

Lawrence Berkeley National Laboratory

Lawrence Berkeley National Laboratory

Title

Comparison of Building Energy Modeling Programs: HVAC Systems

Permalink

<https://escholarship.org/uc/item/2v84k6kx>

Author

Zhou, Xin

Publication Date

2013-08-01

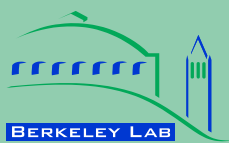

ERNEST ORLANDO LAWRENCE BERKELEY NATIONAL LABORATORY

Comparison of Building Energy Modeling Programs: HVAC Systems

Xin Zhou¹, Tianzhen Hong², Da Yan¹

¹Tsinghua University, China

²Environmental Energy Technologies Division

August 2013

This work was supported by the Assistant Secretary for Energy Efficiency and Renewable Energy, the U.S.-China Clean Energy Research Center for Building Energy Efficiency, of the U.S. Department of Energy under Contract No. DE-AC02-05CH11231. It was co-sponsored by Energy Foundation under the China Sustainable Energy Program.

Disclaimer

This document was prepared as an account of work sponsored by the United States Government. While this document is believed to contain correct information, neither the United States Government nor any agency thereof, nor The Regents of the University of California, nor any of their employees, makes any warranty, express or implied, or assumes any legal responsibility for the accuracy, completeness, or usefulness of any information, apparatus, product, or process disclosed, or represents that its use would not infringe privately owned rights. Reference herein to any specific commercial product, process, or service by its trade name, trademark, manufacturer, or otherwise, does not necessarily constitute or imply its endorsement, recommendation, or favoring by the United States Government or any agency thereof, or The Regents of the University of California. The views and opinions of authors expressed herein do not necessarily state or reflect those of the United States Government or any agency thereof, or The Regents of the University of California.

Ernest Orlando Lawrence Berkeley National Laboratory is an equal opportunity employer.



Executive Summary

This technical report summarizes methodologies, processes, and main assumptions of three building energy modeling programs (BEMPs) for HVAC calculations: EnergyPlus, DeST, and DOE-2.1E. This is a joint effort between Lawrence Berkeley National Laboratory, USA and Tsinghua University, China. It is part of a research project under the five-year collaborative research program of the U.S.-China Clean Energy Research Center for Building Energy Efficiency (CERC-BEE). Energy Foundation, an industrial partner of the CERC-BEE, is the co-sponsor of this work.

The fact that large discrepancies exist in simulated results when different BEMPs are used to model the same building has caused increasing concern. Immediate research is needed to identify main elements that contribute towards the discrepancies of simulation results. This will help users get an in-depth understanding of BEMPs and how to improve accuracy of simulation results. This will also help build a foundation for building energy code development and energy labeling programs as they rely on building energy simulations. In order to achieve these objectives, it is essential to identify and understand the differences between widely used BEMPs and the way these differences influence simulation results. This will involve a detailed comparison of these BEMPs from key user inputs, modeling methods, and source code to results. The goal of this BEMP comparison work is to develop new methods and processes to perform scientific comparisons, and to summarize a list of advantages and disadvantages of the three BEMPs, based on an in-depth understanding of their modeling capacities, mathematical algorithms, assumptions and limitations.

For comparison purposes, BEMPs can be divided into load modules and HVAC system modules. This technical report predominantly focuses on the latter as a previous report focused on the former. A comparative test method is used mainly for the inter-program comparisons. First, the HVAC system modules of the three BEMPs are summarized, analyzed, and compared to identify differences in the solution algorithms and main assumptions. The component models are important parts of the HVAC system calculations and have an important influence on the HVAC calculation results. The calculation methods and main assumptions of several of the main components are discussed and compared in detail. As the HVAC control strategies of supply air temperature, supply air volume, and other parameters affect the operation of HVAC systems, they have significant impacts on the simulation results. The basic simulation methods of the control strategies in the three BEMPs are summarized and the differences are discussed. Secondly, the limitations of existing HVAC system calculation tests are discussed, and additional tests are designed to allow the HVAC systems to be compared deeply and thoroughly. CAV (constant air volume) and VAV (variable air volume) systems are tested in this study to analyze the HVAC system performance and control strategies under various heating/cooling load ratios. All inputs for the test cases of the three BEMPs are kept constant where possible. For parameters that cannot have same values, equivalent conversions are made, in the interest of consistency. The tests include the system-side and plant-side, so that the test process is similar to real cases. Analytical tests are first conducted to ensure the load-side calculations are consistent, so differences in the following calculation results can only come from the HVAC system modules. Through the CAV tests under

Executive Summary

full load and part load conditions, the component models and their influences on the calculation results are compared. Then, based on the VAV test cases, the control strategies used by the three BEMPs are analyzed in detail. Finally, a case study based on a real office building is presented and differences in the simulation results from the three BEMPs are analyzed. Based on the load calculation results, drivers of the differences in the HVAC side are analyzed and discussed.

Main research findings are summarized as follows:

1. EnergyPlus, DOE-2.1E, and DeST all have fundamental capabilities and appropriate modeling assumptions for HVAC system simulations. The results from the comparative tests on component models show small differences, which are mainly due to input settings and algorithms used in each program. Differences between the calculated total energy consumption of HVAC systems from DeST and EnergyPlus can be less than 5%, if all component models are similar, and the same or equivalent inputs for the HVAC systems are used. It is found that the main influencing factors on HVAC discrepancies between DeST and EnergyPlus are the algorithms used for the HVAC component models and their control strategies. For the case that simulates the real building, using design and default values for the inputs of each simulation program, the errors in both load calculations and HVAC system calculations are within 15% of the measured values. This demonstrates good agreement between the simulation programs for modeling real buildings.
2. EnergyPlus has more comprehensive component models than DOE-2 and DeST. The three programs have consistent component models for pumps, fans, and boilers. The coil models in EnergyPlus and DeST are based on engineering/physics equations while the coil model in DOE-2 is based on assumptions and empirical data. The influences of load ratio, condenser inlet water temperature, and evaporator outlet water temperature on the chiller efficiency are considered in all three programs. Three chiller performance curves with user-specified coefficients are used in EnergyPlus and DOE-2, while one hard-wired performance curve is used in DeST. In EnergyPlus and DOE-2.1E, the fan power of the cooling tower is related to the load ratio, so the fan can cycle on and off during a particular hour if the load is small. In DeST, the fan power draw remains constant whenever the cooling tower has a load for any particular hour.
3. To complete a comprehensive comparison of the three different simulation programs, several requirements are needed: 1) the test cases should be broad enough to cover most modeling features; 2) the test cases should be detailed enough to isolate influencing factors; 3) special cases should be designed to test the unique limitations of each program. Based on the current development of HVAC system tests, a test concept is introduced in this study to develop a better method of comparison. As each component in a HVAC system is connected and influenced by one another, the whole HVAC system should be considered when the comparison is conducted. This means that both air-side and plant-side components should be tested together. Imposing steady-state conditions makes it possible to compare each component model in detail and calculate the

Executive Summary

analytical results. Considering the whole system makes the test process more practical.

It should be noted that further research is needed to compare more HVAC system types and control strategies, especially how low energy systems, e.g. natural ventilation, radiant systems, displacement ventilation, to understand the differences and limitations of the three BEMPs. This study can be a supplement to the on-going development of HVAC test cases for ASHRAE Standard 140.

Table of Contents

Table of Contents

Executive summary	0
1 Introduction.....	1
1.1 Background.....	1
1.2 Objectives.....	1
1.3 Methodology	2
2 Overview of the three programs.....	4
2.1 EnergyPlus	4
2.2 DOE-2.1E.....	7
2.3 DeST.....	9
2.4 Summary of HVAC System Simulations in the Three Programs	12
3 HVAC Component Calculation Methods	15
3.1 Pumps.....	15
3.2 Cooling Coils	16
3.3 Cooling Towers	16
3.4 Fans.....	17
3.5 Chillers and Boilers	17
4 Control strategies	24
4.1 EnergyPlus	24
4.2 DOE-2.1E.....	25
4.3 DeST.....	25
4.4 Summary of control strategies for VAV systems.....	26
5 Comparison of HVAC system simulations	27
5.1 Literature review	27
5.2 Test cases introduction.....	28
5.3 Test suite description	29
5.4 CAV full load test cases.....	32
5.5 CAV Part Load Tests.....	47
5.6 VAV Variable Load	54
6 Case study.....	64
6.1 Building description.....	64
6.2 Simulation results.....	68
6.3 Analysis and discussion	70
7 Conclusions.....	73
Acknowledgment.....	75
References.....	76

1 Introduction

1.1 Background

Computer simulation is one of the most effective and economic methods to predict and analyze building energy consumption and performance. The simulation industry has developed rapidly since the 1960s, with hundreds of Building Energy Modeling Programs (BEMPs) developed and used around the world. Well known BEMPs include DOE-2 and EnergyPlus from the U.S. Department of Energy, ESP-r from the University of Strathclyde, U.K., and DeST from Tsinghua University, China. These BEMPs are widely used in the design stages of new energy efficient buildings, the planning stages of energy retrofits for existing buildings, and the development of building energy codes and standards and energy labeling programs in the building industry.

However, more and more practical applications show that large discrepancies exist in results from different modelers using different BEMPs for the same building. This is a large problem for the simulation industry and the subject of much attention. Some believe that the simulation methodology is flawed and attribute the discrepancies to the different calculation engines of different BEMPs. This may hinder the development and application of BEMPs. Consequently, it is important for the simulation industry to understand the reasons for these discrepancies and define the application scope of each program. To solve the problem and promote the development of BEMPs, the detailed comparison of BEMPs' engines is a fundamental and significant step.

A number of studies have been conducted to compare the advantages and disadvantages of several BEMPs. For comparison purposes, BEMPs can be divided into two parts: the load-side calculations and the HVAC system-side calculations. This report focuses on the HVAC system-side calculations. A previous report discussed the load side comparisons (REF). Compared to methodologies for testing load-side calculations, the HVAC system comparison process is at an early stage. There exists no widely accepted testing procedure that can be used directly. The inter-program comparison of HVAC system calculations for commonly used BEMPs is of great significance for users to gain a better understanding of each simulation program. This will also lead to a more effective use of building simulation in scientific research and engineering practice.

1.2 Objectives

EnergyPlus, DeST, and DOE-2.1E are compared in this technical report. These three BEMPs are used widely in the U.S. and China. The comparison will focus on the solution algorithms of the HVAC systems, component models, how the control strategies are modeled, and default program inputs.

The objectives of the comparison include:

1. Better understanding of the HVAC system calculations in each program, including the simulation structure, application scope, advantages,

disadvantages and limitations;

2. Identify key elements leading to the different results from EnergyPlus, DeST, and DOE-2. Attention is paid to the BEMP algorithms, modeling capabilities, and the main assumptions for the HVAC calculations;
3. Provide a list of advantages and disadvantages for each program. This is to allow the correct application of each BEMP to the building life cycle design process (including planning, design, operations, and retrofits) to achieve the goal of reducing building energy use. This important work also provides technical guidance on the use of different building simulation programs to support the development of China's building energy standards and energy labeling programs;
4. Explore a more comprehensive test method for HVAC simulation systems, and from the results, analyze the impact of key elements on the simulated HVAC system energy consumption;
5. Apply the research findings to a real building case study to help test and analyze the differences in simulation results caused by using the three different simulation programs.

1.3 Methodology

The methodology of this study is shown in Figure 1.

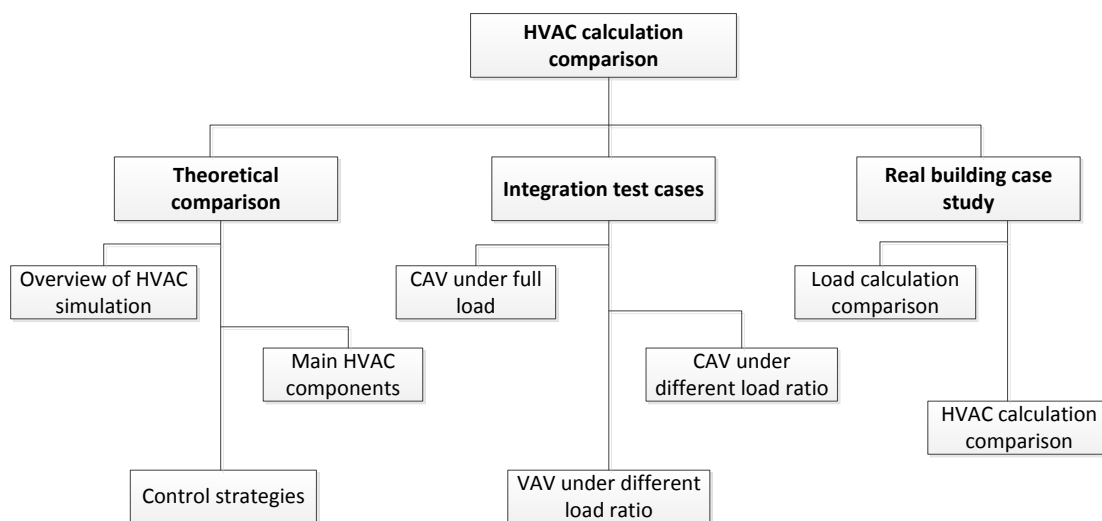

Figure 1 Technical roadmap of HVAC calculation comparisons

The HVAC calculation comparison in this technical report is composed of three main parts as follows:

Theoretical comparison

First, in Section 2, each of the three BEMPs is reviewed in terms of HVAC simulation methods, and their advantages and disadvantages are summarized. Then, focusing on the main HVAC components in Section 3 and HVAC control strategies in Section 4, the differences between simulation methods (including solution algorithms, modeling assumptions, and simplifications) are discussed and analyzed in detail. This is a key

step to identifying the inter-program discrepancies.

Integrated test cases

Based on the review of existing HVAC system tests, an integrated test method is proposed and used. Due to the similarity of EnergyPlus and DOE-2 in the use of steady-state HVAC models, the test process is only applied to EnergyPlus and DeST. Two types of HVAC systems (CAV and VAV) are tested under different load conditions. Comparisons of each component model and control strategy are made and analyzed in detail.

Case study with a real building

Based on the findings of the previous two comparisons, a real building case study is conducted using the three simulation programs. The differences in the load-side calculations are compared first. Then, on the foundation of the load-side results, the errors in the HVAC system energy consumption results are compared and analyzed to ascertain the differences between measured and simulated results, for each program.

2 Overview of the three programs

2.1 EnergyPlus

2.1.1 Overview

The entire integrated program can be represented as a series of functional elements: BUILDING/Zone, SYSTEM, and PLANT subroutines are integrated and controlled by the integrated solution manager. These elements have to be linked in a simultaneous solution scheme. The solution scheme generally relies on successive substitution and iteration to reconcile all of the elements using the Gauss-Seidell philosophy of continuous updating.

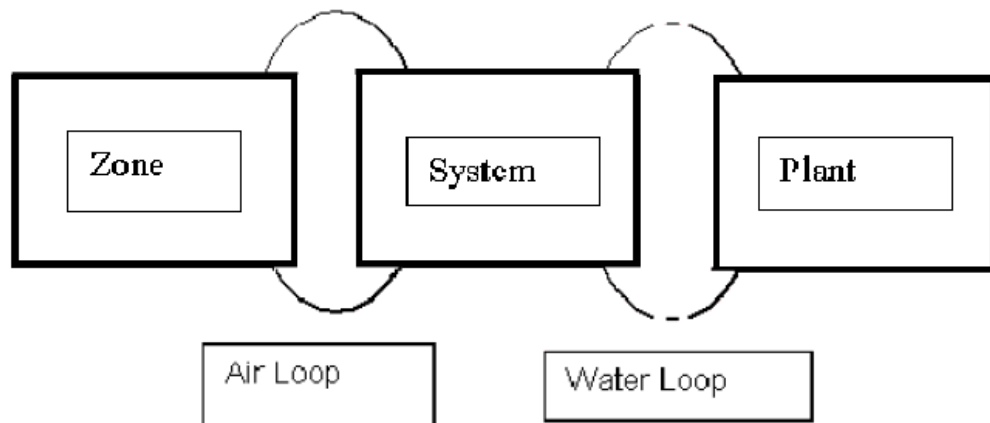

Figure 2 Schematic of simultaneous solution scheme

The elements are connected by fluid loops, and each loop is divided into supply and demand sides.

Air loops are divided into two parts as per the following:

Primary air system: the supply side of the loop, including supply and return fans, central heating and cooling coils, outside-air economizers, and other central conditioning equipment and controls.

Zone equipment: the demand side of the loop, including air terminals as well as fan coils, baseboards, window air conditioners and so on.

The water loop can be separated into a plant loop and a condenser loop. Similarly, the supply side and demand side can be ruled as following:

Plant demand side: equipment (coils, baseboards, radiative systems, etc.) that places a load on the primary equipment (e.g. chillers and boilers).

Plant supply side: chillers, boilers, etc.

Condenser demand side: chiller condenser

Condenser supply side: cooling tower that cools the condenser water

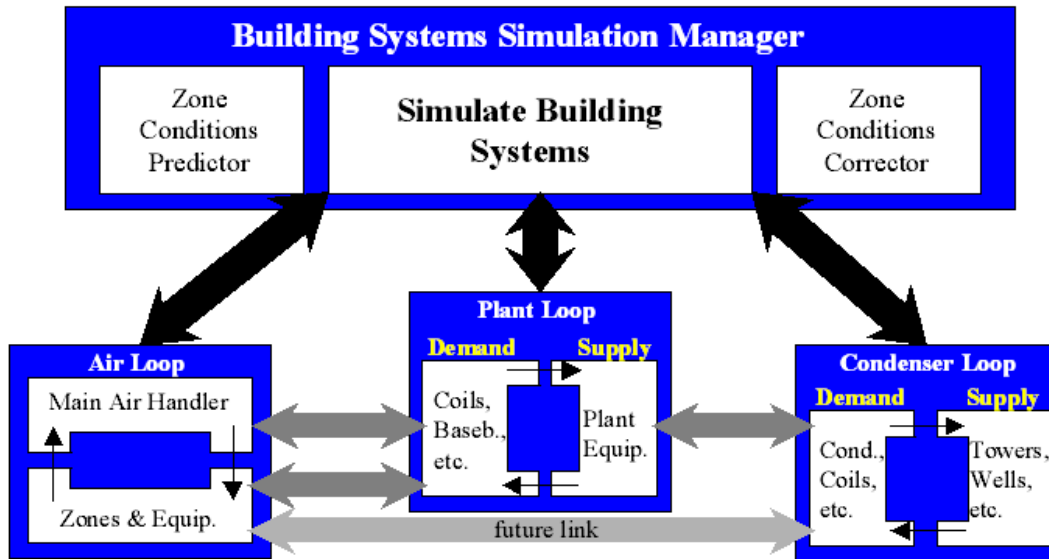

Figure 3 Connections between the main HVAC simulation loops and sub-loops

2.1.2 Assumptions

There are several main assumptions made in EnergyPlus. For reasons of consistency and comprehensibility, it is required that all EnergyPlus models be forward models. That is, the component inputs correspond to the inlet conditions and the outputs correspond to the outlet conditions. For each component several choices of inputs and outputs are possible.

- 1、 AIR SYSTEM CONTROL uses a predictive system energy balance method. It has many characteristics of a predictor-correct method. An assumption was made that if the air system has sufficient capacity (based on the desired zone air temperature) to meet the zone conditioning requirements, those requirements will be met. On the other hand, if the air system cannot provide enough conditioning to the zone, the air system provides its maximum capacity.
- 2、 Simultaneous solution of the system and plant operating parameters requires that the temperature of the water entering the coils must be the same as the temperature leaving the chillers or boilers. Also, the temperature of the return water from the coils must be equal to the chiller or boiler supply water temperature. If the plant has adequate capacity, no iteration is needed (i.e. the supply water temperature equals the set point). But when the plant is overloaded, the plant outlet water temperature is calculated iteratively using the secant method.
- 3、 During each system simulation time step, new zone temperatures and humidity ratios are predicted using previous values. The zone temperatures and humidity ratios are then held constant during the simulation of the air system (and the plant). Then the zone temperatures and humidity ratios are corrected using results from the system simulation. As a result the usual algebraic loops arising from steady-state air system simulations are eliminated.

- 4、 The properties of the loop (temperature, enthalpy, flow rate, etc.) are stored in the branch nodes. Components on the branch take the conditions of the nodes at their inlet and use that information as well as overall control information to perform calculation for the components. Simulation results are written to the outlet nodes of the component, and also copy to the down streaming nodes on the branch.
- 5、 The plant flow resolver is used to adjust the flow rate within the plant and condenser loops. First, the loop manager would simulate all the components on each branch of the loop purely based on the components' own control to satisfy the desired flow rate. Then, the loop manager would resolve the flow and the components are re-simulated with the corrected flows. During this iteration, the flow resolver sets the flow rate. In order not to resort to a pressure-based flow network, a rule-based "flow resolver" was employed. The flow resolver uses a simple predictor-corrector algorithm to enforce mass continuity across the plant splitters.
- 6、 To control the fluid temperature, thermal capacitance is added to the plant loop. This adds stability to the calculations. Once the set point temperature is reached, the storage effects are not included.
- 7、 The loops essentially ignore the node pressures. This is suitable for many applications; however it may cause inaccuracies in the calculation of the pump power. The loop pressure drop is used as the new pump head. If a pump curve is not specified, it is assumed that the pump will always be able to meet the operating point.
- 8、 When a parallel system is encountered, the parallel system is set to use the highest pressure drop found on the parallel branches. There are two types of pressure drop curves that can be entered: generic (a function of current mass flow rate), and pressure information (frictional effects and minor losses).
- 9、 EnergyPlus can also perform a "loop level" pump-system flow resolution to calculate the loop pressure drop. The flow resolver reads the non-dimensional pump curve, loop pressure constant and rated mass flow rate (or mass flow rate from the last iteration) to calculate the pump operating point.

2.1.3 Summary

In conclusion, EnergyPlus is a powerful simulation program. The main idea is successive iteration and analogue simulation. This calculation method leads to a high requirement on convergence and stability, so a series of measures has been taken to improve the performance of the solver. However, EnergyPlus allows users to overwrite internal algorithms or add new calculations via the Energy Management System feature, which improves the flexibility of HVAC simulations.

To eliminate the necessity of solving the interactions between pressures and flow rates, EnergyPlus currently has no duct system model, so the flow rates of different ducts are determined by a ruled flow resolver. The flow resolver distributes the flow rate according to the characteristics of each branch. This assumption is an effective

way to reduce the complexity of the model and improve the speed of convergence. But it does not accurately address the interactions between branches that affect the balance of the flow. Such limitations lead to several un-resolved operating problems, e.g. flow rate adjustments and coil dynamic characteristics.

EnergyPlus calculates the pressure drop based on the flow rate. However, the change of pressure does not affect the branch flow rate. Additionally, the flow rate of each branch has nothing to do with the branch's resistance characteristics. Therefore, the resultant pressure has no practical meaning, and can only be regarded as a reference.

The majority of inputs for EnergyPlus are determined by the user. This requires a high level of expert knowledge in buildings and HVAC systems. The amount of input data is large, which is one of the main reasons for long execution times.

2.2 DOE-2.1E

2.2.1 Overview

DOE-2 is a program that uses sequential simulation modules. It has one subprogram for the translation of user inputs (the Building Description Language (BDL) processor), and four simulation subprograms (LOADS, SYSTEMS, PLANT, and ECON). The SYSTEM and PLANT subprograms constitute the HVAC subroutines. LOADS, SYSTEMS, and PLANT are executed in sequence. Outputs from the SYSTEMS and PLANT modules become inputs to the ECON module. Then the ECON subprogram calculates utility cost as part of the economic reports.

The SYSTEMS subprogram uses the output information from the LOADS program and a list of user-defined system characteristics to handle secondary systems. The PLANT subprogram uses hourly results from the LOADS and SYSTEMS programs, combined with user instructions, to handle primary systems. SYSTEM calculates the performance of air-side equipment (fans, coils, and ducts). It corrects the constant temperature loads from the LOADS subprogram by taking into account outside air requirements, hours of equipment operation, equipment control strategies, and the thermostat set points. The outputs of SYSTEMS are airflow rates and coil loads. PLANT calculates the behavior of boilers, chillers, cooling towers, storage tanks, etc., in satisfying the secondary systems heating and cooling coil loads. It takes into account the part-load characteristics of the primary equipment in order to calculate the fuel and electrical demands of the building.

Overview of the Three Programs

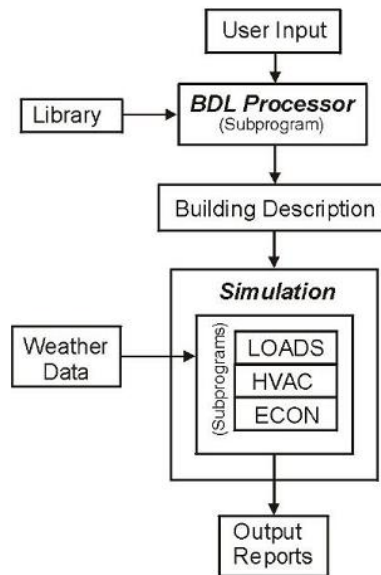

Figure 4 DOE-2 calculation flow chart

2.2.2 Assumptions

Several assumptions are made in DOE-2.1E, including:

1. The dynamics of the interactions between the HVAC equipment and the building are calculated by the simultaneous solution of the room air temperature weighting factors with the action of equipment controller. To eliminate the necessity of solving the interactions of all the zones simultaneously, the zone temperatures from the previous hour are used to approximate the heat flow across internal walls. Likewise, to eliminate the need to iterate until all of the temperatures in the equipment loop converge, temperature histories are used in the calculation of equipment capacities. This is a good approximation if the derivative of the zone temperature is roughly constant.
2. The moisture content of the air is calculated by assuming a steady state solution of the system moisture balance. The moisture condensation on cooling coils is simulated by characterizing the coils by their bypass factors and then solving the bypass relation simultaneously with the system moisture balance.
3. A linear relationship is assumed to describe the interaction of the thermostat, space temperature, and equipment output. First, the capacity is estimated by using the dry- and wet-bulb temperatures from the end of the previous time step (hour). Then according to the estimated equipment capacity, the corresponding relationship with zone temperature is used to decide the equipment's capacity.
4. The equipment capacity and energy input are expressed as the product of a "rated" value and modifier functions. It is assumed that it can be well approximated by the product of multiple modifier functions.
5. As all of the information is communicated in one direction only, a subprogram "upstream" cannot make use of any information "downstream", like the overload cases. In the PLANT subroutine, if the coil load is not met, it will pass the

overload to successive time steps until it is finally met, or the heating or cooling is scheduled to be switched off. The one-way flow of information also does not allow several building control strategies to be simulated, such as adjusting the lighting loads according to the electrical loads.

6. If multiple sizes of given equipment type are operating simultaneously, the program models them as if all the equipment was lumped together into one large unit. It assumes that the same type of equipment will have identical performance curves regardless of their sizes. Also, it assumes that all equipment of the same type will be operating at the same fraction of their design capacities.
7. Electricity needed to operate a boiler or a storage tank pump is not accounted for in the total energy of PLANT.
8. The PLANT subprogram does not make checks to see if the type of equipment and fuel types the user inputs are compatible.

2.2.3 Summary

DOE-2.1E is a simulation program with a long history and a comprehensive set of functions. However, due to the lack of further development since the early 1990s, there are several weaknesses in the software. The main problem is the structure of the software. It has no feedback process, and the one direction calculation flow contains a lot of simplifications compared to real HVAC systems. Facing the increasingly complex system schemes and control methods which are currently emerging, DOE-2 cannot adequately satisfy some user requirements, particularly those with feedback situations.

To simplify the calculation process and avoid iterative calculations, in DOE-2 the zone temperatures from the previous hour are used to approximate the heat flow across internal walls and temperature balances. This method will introduce inaccuracies when the zone temperatures fluctuate significantly.

Meanwhile, the SYSTEMS subroutine corrects the constant-temperature loads by the LOADS subprogram using room air temperature weighting factors. It does not perform a true zonal heat balance and will also lead to inaccuracies.

2.3 DeST

2.3.1 Overview

DeST separates the heating/cooling station (central plant) from the supply side, dividing them into two modules (equivalent user terminal and heating/cooling station). The equivalent terminal model is a simplified model to reflect the main properties of air terminals. The two modules iterate to obtain the results. DeST performs detailed modeling of ducts, chillers, and pumps in the heating/cooling station side. Exact and strict physical equations based on first principles are used, but

in the user terminal side, a curve is used to reflect the changes of whole flow rate, pressure drop, and heat transfer.

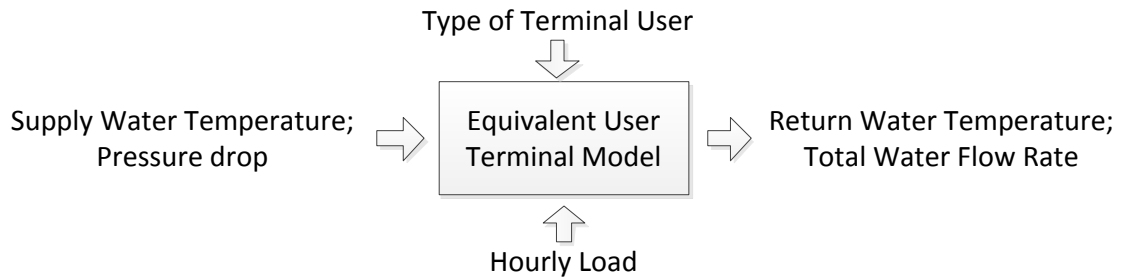

Figure 5 Equivalent user terminal model

DeST builds equivalent user terminal models for different end types. As Figure 5 shows, in the terminal model, when the terminal user type and hourly load have been input, and the user side supply water temperature $t_{w,in}$ and the pressure drop ΔP have been calculated, then through the equivalent user terminal model, the chiller water flow rate in user side and the return water temperature $t_{w,out}$ are calculated. The equivalent user terminal model can reflect the overall performance and the time average situation. In this way, the terminal system is separated from the complex dynamic control. In the heating/cooling station model, as Figure 6 shows, when the control strategy of heating and cooling station has been determined, and the return water temperature and flow rate have been input, the supply water temperature and pressure drop can be calculated.

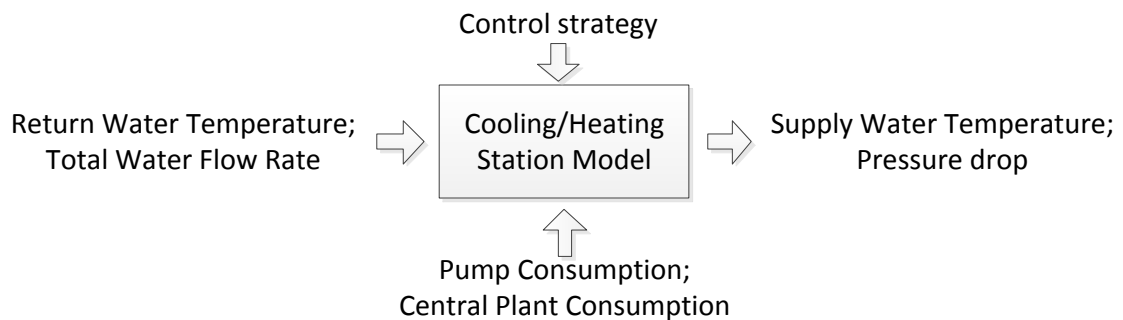

Figure 6 Heating/cooling station model

After the modeling of equivalent user terminal and heating/cooling station, based on the inside coupling relationship, iterative calculations are performed to obtain the actual flow rate, pressure drop, and water temperature, thus maintaining the consistency of water flow rate, pressure drop, and heating/cooling load on both the

user side and supply side. The combined iteration method is illustrated in Figure 7.

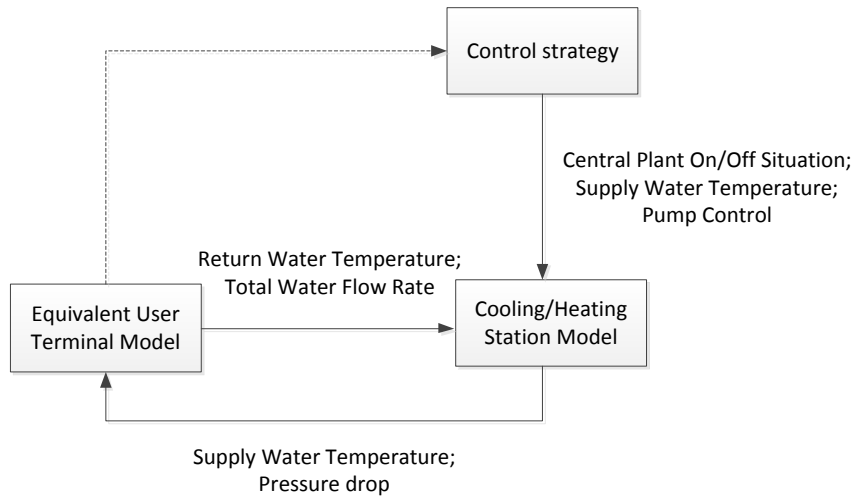

Figure 7 Iterations between equivalent user terminal model and the heating/cooling station model

2.3.2 Assumptions

DeST makes several important assumptions:

1. For the lower level closed-loop controls, DeST only checks to see whether a set point can be met by regulating equipment. If the set point can be met, DeST calculates the regulated variables, such as the cooling outputs, pump rotation speed, and valve pressure drops. Otherwise, the control apparatus will be opened to the maximum position.
2. For the overall upper level control strategies for the cooling and heating plants, DeST uses detailed simulations, e.g., when determining the operating status of each chiller and pump. Because control strategies can vary significantly, DeST cannot cover all possibilities, but it does provide a few simple control strategies for users to choose. Users can enter code for control strategies based on their needs using a list of parameters and variables provided by DeST.

2.3.3 Summary

With the concept of an equivalent user terminal, the iterative calculations between demand side and supply side has been simplified, which also decreases the complexity of the iterative calculations and improves the chance of convergence. DeST's whole simulation structure is simpler and clearer compared to other programs. So far the equivalent user terminal has covered several typical HVAC systems. This needs to be expanded for new HVAC systems.

2.4 Summary of HVAC System Simulations in the Three Programs

The three BEMPs have different features in terms of time step, calculation flows, component model algorithms, system types, pressure calculations, and limitations, as summarized in Table 1.

The determination of time-step is one of the key issues during the coupling between the simulation of buildings and controls strategies. In DeST and DOE-2, the simulation of control strategies mainly focuses on the expressions like control targets, setting values, number of operating machines and so on. The influence of control processes, such as PID is not involved. The simulation of HVAC system is a quasi-stable state process, so the chosen time-step is 1 hour. In EnergyPlus, to reflect the function of PID control, time-step can be adjusted as minutes' magnitude. Another main reason for the choice of small time-step in EnergyPlus is to increase the computational stability. So according to the applications, the determinations of time-step in different BEMPs are different.

The return water temperature from terminal side has a huge influence on the water system energy consumption and the operating performance. The simulation methods about this part in different BEMPs are different. The return water temperature from terminal side is mainly affected by the terminal types (FCU with on-off control, AHU with continuous adjustment or FAU with no control), supply water temperature, pressure difference between supply side and return side. The simplifications and simulation methods about this part differs in different BEMPs. In EnergyPlus and DOE-2, the terminal model is divided into different equipment, and through the simulation of each equipment, the relevant return water temperature and flow rate can be achieved. In DeST, with the consideration that the characteristics of each terminal differ from that of the whole system, the equivalent user terminal model is taken to describe the features of return water temperature and flow rate. Taking the simulation of FCU with on-off control as an example, in EnergyPlus and DOE-2, the FCU model is integration, which includes equipment models like: fan and heating/cooling coil, and the operation of the fan is according to the relevant control strategies; in DeST, the equivalent user terminal model is based on curve model. The input parameters include terminal load, supply water temperature and pressure difference between supply and return side, and the output parameters are return water temperature from terminal side and the total flow rate. Through the equivalent user terminal model which can reflect the average situation of terminals' flow rate and thermodynamic state, the overall situation of terminals and controllers can be described.

Overview of the Three Programs

Table 1 Summary: system simulation overview

Features	EnergyPlus	DeST	DOE-2.1E
Time-step	Sub-hourly, auto-adjusted from zone time step	Fixed hourly	Fixed hourly
Advanced features	Energy Management Systems (EMS)	None	User functions
Simulation structure	Integrated solution. BUILDING, SYSTEM, PLANT are integrated and controlled by the integrated solution manager. Uses a predictor-corrector approach.	DeST separates the heating and cooling station from the supply side, dividing them into two modules: equivalent user terminal and heating/cooling station. The two modules iterate to calculate results.	DOE-2 is a program with sequential simulations. It has one subprogram for the translation of users' inputs (BDL processor), and four simulation subprograms (LOADS, SYSTEMS, PLANT and ECON). LOADS, SYSTEMS and PLANT are executed in sequence. Their outputs are used as inputs to the ECON subprogram.
Algorithm	All the equipment models are forward, quasi-steady models that use equipment/system performance curves		
Limitations	For complex system configurations, convergence sometimes is an issue	For new types of HVAC systems, the equivalent user terminal is limited	Cannot model new HVAC system types; When the SYSTEM subprogram cannot meet the loads, space temperatures are estimated.
System configurations	Flexible, user definable, typical HVAC templates	Predefined HVAC templates	25 fixed system types with optional components
Fixed system types	Typical HVAC systems can be build using the HVACTemplate objects, including: Thermostat; Zone: IdealLoadsAirSystem; Zone: FanCoil; Zone: PTAC; Zone: PTHP; Zone:Unitary; Zone: VAV; Zone: VAV:FanPowered; Zone: WaterToAirHeatPump; System:Unitary; System:UnitaryHeatPump:AirToAir; System:VAV; System: PackagedVAV; System:DedicatedOutdoorAir;	VAV, CAV, FCU, VRF,PTAC, PTHP	Ceiling Bypass; Ceiling Induction; Constant Volume Reheat Fan System; Dual Duct System; Evaporative Cooling; Floor Panel Heating; Four Pipe Fan Coil; Four Pipe Induction Unit; Heating and Ventilation; Multi-Zone System; Packaged Multi-Zone System; Packaged Single Zone; Packaged Terminal Air Conditioner; Packaged Variable Air Volume; Packaged Var-Volume, Var-Temp; Powered Induction Units; Residential system; Residential Var-Volume, Var-Temp;

Overview of the Three Programs

	Plant:ChillerWaterLoop; Plant:Chiller; Plant:Tower; Plant:HotWaterLoop; Plant:Boiler; Plant:MixedWaterLoop		Single Zone Variable Temperature; Two Pipe Fan Coil; Two Pipe Induction Unit; Unit Heater; Unit Ventilator; Variable Air Volume; Water Loop Heat Pump.
Pressure calculation	Two types of pressure drop curves	Characteristics of equivalent user terminal	User inputs
Terminal model	Take terminals as different equipment models to get the information about flow rate, return water temperature and so on	Use the equivalent user terminals model to reflect the average situation of terminal flow rate and thermodynamic state	Take terminals as different equipment models and the inputs are based on average parameters, then the overall features can be achieved
Interaction between the HVAC equipment and the building loads	successive substitution iteration to reconcile all elements using the Guass-Seidell philosophy of continuous updating with predictive system energy balance method	equivalent user terminal curve	The zone temperatures from the previous hour calculation are used to approximate the heat flow across internal walls. Temperature histories are used in the calculation of equipment capacities.
Handling of given types of equipment with multiple sizes	According to the control strategy defined by the users	According to the control strategy defined by the users	Model them as if all the sizes operating were combined together into one large unit.

3 HVAC Component Calculation Methods

Components models are important parts of the HVAC system simulations. In EnergyPlus and DeST, component models are divided into many groups, which cover most types of components such as boilers, chillers, coils, pumps, fans, and cooling towers. The number of selectable model types for the same component in DeST is less than that in EnergyPlus, as is the number of inputs for the model. Many component models in EnergyPlus are adapted from those in DOE-2, so for these models little differences exist between the two programs.

Amongst the many categories of component models in the three simulation programs, six types of component models will be discussed and compared in detail. They are: pumps, chilled-water cooling coils, cooling towers, fans, electric water-cooled chillers, and hot-water boilers. The tables below list the main features of each type of component model in EnergyPlus, DeST, and DOE-2, and readers can get an overall understanding of the modeling assumptions and compare them easily. Also, some of the main characteristics of these models will be discussed in detail.

3.1 Pumps

All three simulation programs provide a constant speed pump model and a variable speed pump model. In EnergyPlus and DOE-2, a pump can operate continuously or intermittently according to whether there is a load on the loop. While in DeST, a pump can only operate when there is a heating/cooling load. The pump power calculation is similar in all the three programs. The basic formula for a constant speed pump is:

$$PumpElectricPower = PumpVolumeFlowRate * \frac{PumpHead}{TotalEfficiency}$$

Where,

PumpElectricPower is the pump power in watts;

PumpVolumeFlowRate is the pump flow rate in m³/s;

PumpHead is the pump head in Pa;

TotalEfficiency is the pump efficiency.

When a pump has variable speed, the pump power will be modified by the *FractionFullLoadPower*, which is a cubic equation. The exact equation is different amongst the three programs. In EnergyPlus and DOE-2, the curve coefficients can be changed by users, while in DeST, the equation and coefficients are hard-wired into the code.

Generally, all the three programs treat a pump as an ideal pump, which means that the pump operates unrestricted by the relationship between pressure and flow rate. EnergyPlus offers a function that determines a pump's operating point according to the dimensionless pump curve and the system pressure characteristics. Currently this is only applied to constant speed pumps. The net effect of several pumps operating

on the same loop is the same in EnergyPlus and DeST. The pumps are made to work at full load. DOE-2 is different - the operation of multiple pumps is treated as one large pump, i.e. all the pumps work with the same load ratio. Table 2 summarizes pump models for the three programs.

3.2 Cooling Coils

The calculation of heating coil performance is similar to that of the cooling coil under dry conditions, so only the algorithm for the cooling coil is discussed here. Because only one cooling coil model is available in DeST, while there are a few models in EnergyPlus, the simple cooling coil model in EnergyPlus was chosen due to it being the closest model compared to that in DeST. DeST uses a heat exchange efficiency method to describe the performance of coils. In EnergyPlus, the ϵ -NTU method is used for dry coils, and for wet-coil conditions, the ϵ -NTU method is modified by replacing the temperature with enthalpy. The two modeling methods are equivalent. However, in DOE-2, the coil bypass factor is used. The coil bypass factor is a function of both physical and operational parameters of the coil. It is expressed as a product of the design value and two modifier functions, which can be calculated from manufacturers' data.

Although the main coil algorithms in EnergyPlus and DeST are the same, the determinations of a coil's performance parameters are different. In EnergyPlus, the coil's performance parameters (such as the UA value) are calculated based on the design conditions and several assumptions including:

- 1) the coil is wet at the design condition.
- 2) Internal UA is 3 times the external UA.
- 3) coil external heat transfer surface area is calculated using the following information: Tube inside diameter = 0.0122 (m); Tube side water velocity = 2.0 (m/s); Inside to outside coil surface area ratio (A_i/A_o) = 0.07 (-); Fins overall efficiency = 0.92 (-); Aluminum fins, 12 fins per inch with fins to total outside surface area ratio of 90%; Airside combined heat and mass transfer coefficient = 140 ($W/m^2 \cdot ^\circ C$).

In DeST, a coil database is supplied to allow users to pick a suitable coil. For a chosen coil, the basic information used in the calculation is provided directly, e.g. the head-on wind area, heat dissipation area of each row, sectional area of water, coil surface ratio of heat transfer to head-on wind area for each row of tubes, row number of finned tubes and so on.

Table 3 summarizes cooling coil models for the three programs.

3.3 Cooling Towers

Both EnergyPlus and DeST use Merkel's theory and perform an energy balance on the water and air sides of the air/water interface to complete the cooling tower calculations. For DOE-2, the cooling tower model uses several performance curves to estimate the rating capacity and the relationship between the water temperature leaving the tower and the outdoor air wet-bulb temperature.

Table 4 summarizes cooling tower models for the three programs.

3.4 Fans

The fan models in the three programs are quite similar. All of them include constant volume and variable volume fans. For the constant volume fans, the fan power does not change during operation. While for variable volume fans, the fan power is modified by a polynomial curve using the flow/pressure ratio. The main differences are how fan heat and pressure are calculated.

Table 5 summarizes the fan models for the three programs.

3.5 Chillers and Boilers

EnergyPlus includes absorption chillers, indirect absorption chillers, combustion turbine chillers, and electric chillers. DeST has screw chillers, piston chillers, centrifugal chillers, and absorption chillers. DOE-2 can model absorption chillers, compression chillers, and double bundle chillers. All of the models use empirical curves and energy balance equations, but the form of the equations are not the same between the three programs.

For boilers, a curve function is also used as a modeling method. But similarly, the parameters and forms of the equations are different in the three programs. Also, in DeST, the equation form and coefficients are hard-wired into the code.

Table 6 summarizes the chiller models for the three programs, and Table 7 summarizes the boiler models for the three programs.

Component Calculation Methods

Table 2 Pump model summary

Features	EnergyPlus	DeST	DOE-2
Categories	Three optional elements: constant or variable speed; continuous or intermittent operation; operation with or without a load on the loop	constant or variable speed	Constant or variable speed pumps; hot water and chilled water pumps normally operate only when there is a heating or cooling load from the SYSTEMS subprogram. In the STANDBY mode, heating and cooling pumps will operate any time heating and cooling is scheduled to be available.
Pump Power	$PumpElectricPower = PumpVolumeFlowRate * \frac{PumpHead}{TotalEfficiency}$ <p>For variable speed pumps:</p> $PumpPower = FractionFullLoadPower * PumpElectricPower$ <p><i>FractionFullLoadPower</i> is determined by the cubic equation.</p>		$PumpElectricPower = PumpVolumeFlowRate * \frac{PumpHead}{TotalEfficiency}$
Pump operating point	Ideal; Constant speed pumps also consider the dimensionless pump curve and the system pressure characteristics	ideal	ideal

Component Calculation Methods

Features	EnergyPlus	DeST	DOE-2
<p>Pump heat addition to the loop</p>	$\begin{aligned} \text{ShaftPower} &= \text{PumpPower} * \text{PumpMotorEfficiency} \\ \text{PumpHeatToFluid} &= \text{ShaftPower} + \\ &(\text{PumpPower} - \text{ShaftPower}) * \text{FracMotorLossToFluid} \end{aligned}$	<p>Not considered</p>	$\text{HHGAIN} = \text{HTSUM} * \text{HLOSS}$ <p>HLOSS: the fraction of the design space heating load.</p> <p>HTSUM: the peak space heating load in watts</p> <p>If the pump motor is ventilated, only the shaft energy heats the loop.</p> $\begin{aligned} \text{HHGAIN} &= \text{HHGAIN} - (\text{HPELEC} * \text{HEFFM}) \end{aligned}$ <p>HPELEC: the pump electrical power in watts; HEFFM: the pump motor efficiency</p>
<p>Combinations of pumps</p>	<p>Simulated as a single component and specified as an integer multiple of a single pump. If they are constant speed pumps, they all work at full load. If they are variable speed pumps, the last pump runs at part load and the others run at full load</p>	<p>Simulated as a single component and specified as an integer multiple of a single pump. If they are constant speed pumps, they all work at full load. If they are variable speed pumps, the last pump runs at part load and the others run at full load</p>	<p>Simulated as a single component and assumes that all pumps are operating at the same fraction of their design capacity</p>

Table 3 Cooling coil model summary

Feature	EnergyPlus	DeST	DOE-2
Flow models	Cross flow; Counter flow	No distinctions	No distinctions
Analysis models	Simple analysis mode: wet coil or dry coil; Detailed analysis mode: wet coil, dry coil or partially-wet, partially-dry coil	One analysis mode	One analysis mode
U-Factor multiplied by area values (UA)	Based on a series of heat transfer and energy balance equations with several reasonable assumptions. Uses iterative calculations to obtain results.	Based on empirical equations	Simplifies the calculations using modifier functions in the form of performance curves
Coil models	For dry-coils, uses the ϵ -NTU method. For wet-coils, the ϵ -NTU method is modified by using enthalpy to replace the temperature	Uses a heat exchange efficiency model	Uses a coil bypass factor model. It characterizes the air leaving the coil as being composed of two major streams according to whether the air is cooled by the coil or not. The coil bypass factor is calculated under the assumption that the temperature of the air stream conditioned by the coil is at the apparatus dew point temperature.

Table 4 Cooling tower model summary

Features	EnergyPlus	DeST	DOE-2
Categories	Single-speed tower, Two-speed tower, variable-speed tower. A tower can have multiple cells.	No distinctions	Induced-draft crossflow; induced-draft counterflow; forced-draft crossflow; forced-draft counterflow. The towers can operate at single-speed or two-speed. A tower can have multiple cells.
Capacity control	Fan speed, fan cycling or fluid bypass	NA	Fan speed, fan cycling
Model	Merkel's theory, and an energy balance performed on the water and air side of the air/water interface	Merkel's theory, and based on the energy balance on the water and air side of the air/water interface	Uses performance curves and outdoor air wet-bulb temperatures to estimate the tower capacity and the water temperature leaving the tower
Tower basin heater	Scheduled or available the entire simulation time period	NA	NA
Variable speed cooling towers	Based on empirical curves. The user specifies tower performance at design conditions, and empirical curves are used to determine the approach temperature and fan power at off-design conditions	NA	NA

Component Calculation Methods

Features	EnergyPlus	DeST	DOE-2
Cooling tower makeup water usage	Includes three components: evaporation, drift, and blowdown	NA	NA
Input Q data	Iteration with the chiller heat rejection	Iteration with the chiller heat rejection	Use the chiller heat rejection loads from previous time step

Table 5 Fan model summary

Features	EnergyPlus	DeST	DOE-2
Categories	Constant Volume; Variable Volume; On/Off	Constant Volume; Variable Volume	Constant Volume; Variable Volume;
Algorithm of single-speed fan	According to rated conditions, the airflow volume will not change during fan operation		
Algorithm of multi-speed fans/variable speed fans	Polynomial curves are used		
Heat loss to air	$Q_{toair} = Q_{shaft} + (Q_{tot} - Q_{shaft}) \cdot f_{motortoair}$	$Q_{toair} = Power - of - Fan$	$Q_{toair} = PLR * Q_{operationto-designfanatgain}$ $PLR = \frac{PWR}{PL}$ <p>PLR: Part flow rate; PL: part-load energy consumption</p>
Fan pressure rise	Uses the Fan:ComponentModel to calculate, a function of air flow and physics-based.	Constant value	Constant value

Table 6 Chiller model summary

Features	EnergyPlus	DeST	DOE-2
Categories	Absorption chiller; indirect absorption chiller; combustion turbine chiller; electric chiller	Screw chiller; piston chiller; centrifugal chiller; absorption chiller	Absorption chiller; compression chiller; double bundle chiller
Chiller model	Rated operation parameters combined with part-load ratio. Empirical curves and energy balance equations are used		

Table 7 Boiler model summary

Features	EnergyPlus	DeST	DOE-2
Categories	Simple hot water boiler; steam boiler	No distinction	Simple hot water boiler; steam boiler
Boiler model	<p>Users input: nominal boiler capacity and thermal efficiency;</p> <p>Combines the normalized boiler efficiency curve to calculate the energy consumption;</p> <p>The curve is a single, independent variable function of the part-load ratio or dual, independent variable function of the part-load ratio and the boiler outlet water temperature</p>	<p>According to the part-load performance parameter to complete the energy calculation; the part-load curve is a single, independent variable function of the part-load ratio.</p>	<p>Uses the heat input ratio to calculate the energy input in part-load. The heat input ratio curve is a single, independent variable function of the part-load ratio.</p>

4 Control strategies

Control strategies refer to how the simulation program determines the supply airflow rate and supply air temperature, and how the flow rate is distributed and so on. Although the types of system are similar, the details of the hourly simulation results (e.g. the calculated energy consumption) can be significantly affected by the control options. This section focuses on the determination of set points and the basic control concepts in the HVAC system.

4.1 EnergyPlus

Most set points in EnergyPlus are defined in the Setpoint Manager module. Setpoint Managers are one of the high-level control structures in EnergyPlus. A Setpoint Manager is able to access data from any of the HVAC system nodes and use this data to calculate a set point for one or more other HVAC system nodes. Set points are then used by controllers, and plant or condenser loops as a target for their control actions.

Setpoint Managers are executed at the start of each HVAC time step, and they reside outside the HVAC system iteration loops. Thus, the Setpoint Managers are executed once per HVAC time step, and they use previous time step information (except for zone load) to calculate their set points. Because most coil component models require the use of a set point manager, they have a close relationship with the supply air temperature.

EnergyPlus offers 20 kinds of Setpoint Managers. They can be divided into the following:

1. Schedule: the Setpoint Manager simply uses a schedule to determine one or more set points.
2. Outdoor air: the Setpoint Manager sets the supply air temperature according to the outdoor air temperature using a reset rule.
3. Load: the Setpoint Manager detects the control zone load in certain rooms (total load or warmest room or coldest room, and so on), zone inlet node flow rate and zone node temperature, then according to this information, a suitable supply air temperature is calculated to satisfy the zone load.
4. Humidity: the Setpoint Manager detects the humidity level in the control zone, then calculates the supply air humidity ratio that can satisfy the zone relative humidity range.
5. Reference: the Setpoint Manager determines the set point by referring other existing set points.

Set points are used in the control module as a signal to help adjust other parameters to meet the set points. However, the set point is not always applicable to all component models and systems especially those with their own control strategies.

4.2 DOE-2.1E

The Heat-Temp-Sch and Cool-Temp-Sch together with the Throttling-Range, define the three action bands of the physical space thermostat. When the zone air temperature is outside the cooling or heating throttling range, the zone requires cooling or heating. The actual actions that occur when the zone temperature is within the heating and cooling ranges vary based on the type of equipment. When it is in the heating range, the following actions take place in sequence: 1) increase supply air temperature; 2) increase the baseboard output; 3) increase the reheat coil output; 4) increase the air volume. When it is in the cooling range, the measurements are sequenced as the following: 1) decrease the supply air temperature; 2) increase the supply air volume.

The maximum humidity and minimum humidity are user inputs. They place relative humidity controls on the return air stream. If the return air relative humidity falls below the specified minimum, steam or hot-water may be added to the air stream to raise the humidity. The resultant load is always passed on to the PLANT subprogram as a steam or hot-water load. When the return air humidity exceeds the maximum level, the supply air temperature is set to the minimum. This reset action may make the simulation inaccurate during large temperature drops. The inaccuracy is caused by the non-iterative nature of the simulation because resetting the supply air temperature causes a very different thermostat and different terminal unit performance compared with the initial calculations and there is no detailed zone recalculation.

4.3 DeST

The supply air temperature and the supply air volume are determined in the SCHEME subprogram. The DeST SCHEME module applies an approach to simulating the hourly zone air temperature under various system configurations and operations. With the hourly room air temperatures, supply air temperature, supply air volume, and other HVAC parameters can be calculated and HVAC design alternatives can be simulated and evaluated. This could provide a better picture of the system performance than the traditional design day analysis. After a designer has decided the details of the scheme, simulations could be used to obtain the annual hourly results for analysis. If the designer does not satisfy the results, the scheme details could be revised and simulated again until the expected efficiency of the designer is reached. The scheme design stage is actually a loop that repeats the process of design, simulation, and improvement until the scheme meets the design criteria. The main concern of the scheme design stage is whether the selected HVAC systems could maintain the room temperatures under the design conditions specified throughout the year. To complete the simulation, several assumptions are needed: 1) an ideal AHU that can supply any possible supply air conditions to the spaces; 2) an ideal control for the system that can be regulated perfectly to any conditions; and 3) for the purpose of simplicity, the determination of supply air flow rate, supply air temperature, and terminal reheat capacity will not consider humidity effects.

Load conditions of a room fluctuate throughout the year because of the changes of outdoor air temperature, internal heat gains, and many other simultaneous thermal heat exchanges. To maintain the indoor thermal environment, the supply air temperature or the supply air volume should be adjusted. In CAV systems, the airflow rate is constant, only the supply air temperature can change. An optimization technique is employed to search for the best supply air temperature for the situation. In VAV systems, both the supply airflow rate and the supply air temperature can be adjusted to offset the load fluctuations in different rooms, so optimization is also done to find the best supply air temperature that can minimize the energy consumption for both cooling/heating power and fan power.

4.4 Summary of control strategies for VAV systems

The following table compares different control strategies of VAV systems used by the three programs.

Table 8 Comparison of VAV system control strategies

Program	Control	Description
EnergyPlus (normal acting damper)	Heating	Supply airflow rate stays at a constant minimum value for normal acting dampers and modulates higher for reserve acting dampers, supply air temperature may vary
	Cooling	Supply air temperature may vary, supply airflow rate varies
DeST	Heating & cooling	An optimization technique is employed to search for the best supply air temperature; when the range of best supply air temperature (SAT) exists, determine the supply air volume (SAV) to make sure the air flow rate minimum; otherwise, determine the SAT to make deviation minimum
DOE-2	Heating	The actions are sequential: 1) increase supply air temperature, 2) increase the baseboard output if exist,3) increase reheat coil output;3) increase supply air volume
	Cooling	The actions are sequential:1) reduce supply air temperature;2) increase the airflow rate

5 Comparison of HVAC system simulations

5.1 Literature review

Simulating the energy use of buildings is a complex process. It is difficult to ascertain the weakness or faults of simulation programs. Continuous and systematic validation work is needed for simulation programs. User feedback is important for developers to implement updates and maintenance. The validation work of BEMPs includes a combination of empirical validation, analytical verification, and comparative analysis techniques. Several organizations that specialize in building energy simulation have released standards and guidelines for the validation process, including IEA BESTest and ASHRAE Standard 140.

The testing and validation work is well accepted in the building load calculation part. Many simulation programs have been subjected to comparative load tests. Existing load tests include building envelope and fabric load tests, window shading tests, interior solar distribution tests, etc., that cover the most important factors of the load simulation. Most popular simulation programs like EnergyPlus, DeST, DOE-2, ESP, BLAST, and TRNSYS have participated in several of the tests.

Another important part of building energy simulation is the HVAC system calculation. This also attracts much attention from researchers. The HVAC tests based on ASHRAE research project 865 offers several analytical tests and the ANSI/ASHRAE Standard 140 offers several test cases for simple unitary vapor compression cooling systems and fuel-fired furnace heating systems. The National Renewable Energy Laboratory created the BESTEST in collaboration with the International Energy Agency Solar Heating and Cooling programme (IEA SHC) and the Energy Conservation in Buildings and Community Systems programme (IEA ECBCS). One of the tests created under IEA SHC Task 34/ECBCS Annex 43 examines the mechanical equipment and control strategies for chilled water and hot water systems. This tests the performance and control strategies of chillers, cooling/heating coils, chilled water hydraulic circuits, boilers, and hot water hydraulic circuits. Developers of some simulation programs have created several test cases to verify their simulation results. For example, EnergyPlus global energy balance tests check the accuracy of EnergyPlus with regards to energy balances at various boundary volumes when simulating the operation of HVAC systems. Many papers have compared several simulation programs.

However, the tests for HVAC systems still need a standardized and widely adopted method to allow their comparison in a structured and consistent way. The difficulties are:

1. The complexity of the HVAC systems

There are many components in various HVAC systems, and some components operate in response to others, according to the control strategies or calculation assumptions in the cycling systems. Focusing on the component itself and changing the boundary conditions is a good way to test the component modeling algorithm. This is widely used in currently available test cases. However, under the method for independent testing of each component, there is no check of the

ability to simulate whole HVAC systems, as modeled in real projects.

2. The inconsistencies of simulation programs

Currently, HVAC components from different programs are dissimilar, and cannot always be converted so that they are equivalent. How to put all the simulation programs on the same platform and conduct a series of equivalent HVAC tests, is a complex and unsolved problem.

3. The control strategies

The control strategies are one of the most important characteristics in the operation of HVAC systems. Their contents and forms vary with simulation programs. It is hard to tell which one is the best or most accurate. In most simulation programs, the control strategies are written in the code and cannot be modified, which makes it more difficult to compare the HVAC systems.

This study designs several test cases to compare HVAC system simulations. Because the HVAC component models in DOE-2 are similar to those in EnergyPlus, only EnergyPlus and DeST are compared. EnergyPlus version 7.0 and DeST version 2.0 were used for this study. Because there are various models of HVAC components available in the two programs, to ensure the comparison operable, the closest model types in the two programs are chosen. Through the designed test cases, the simulation methods of HVAC systems in EnergyPlus and DeST will be discussed in a more detailed way. Furthermore, from the comparison process, the difficulties in the validation process of HVAC system simulation can be demonstrated, which may provide inspiration about how to conduct uniform and widespread HVAC simulation testing.

5.2 Test cases introduction

Only the sensible load is compared in the load calculations. Similarly, the tests in this report have not taken into account the latent conditions. The CAV (constant air volume system) steady condition tests compare the modeling methods and results of EnergyPlus and DeST with regards to components like electric chillers, boilers, constant volume pumps, cooling towers, and coils under constant loads. The advantage of the steady condition tests is that the analytic values can be calculated and the detailed modeling method can be explained step-by-step. In this way, the modeling process becomes a white-box test which makes the differences easily quantified and clearly explainable. The assumption of steady state conditions is mainly for the loads calculation in order to provide a constant loads input for the HVAC systems. In the HVAC calculations, as the thermal inertia of HVAC equipment is small and the HVAC component models in the three programs are steady state, there would be small discrepancies in the HVAC results between the dynamic case and the steady state case. In the HVAC test cases, different loads (part-load-ratio) conditions are covered in order to test how HVAC equipment and systems (component models as well as system control strategies) perform under part load conditions. As each component calculation method and result is tested in a complete HVAC system environment, it performs the same way with real building energy simulation processes. This makes the test results more convincing and lends more practical

significance. Therefore, both the analytical and comparative methods are used in the HVAC testing.

The consistency of three BMEPs about dynamic building load simulation has been proven in existing studies. In the simulation of HVAC system, most BEMPs take the calculation method of quasi steady state, in which each calculation condition is irrelevant. In order to highlight the comparison about HVAC system and eliminate the differences introduced by dynamic load simulation from building side, a series of steady state test cases can be taken to conduct the comparison.

The test cases build upon a modified version of the small office building from the USDOE commercial reference buildings which comply with ASHRAE Standard 90.1-2004. The building side is needed only to create a constant load for the HVAC simulations. For the convenience of comparison, the size of the load is required to be as constant as possible between EnergyPlus and DeST. To achieve this, several modifications have been made to the original building model. The test suite in this section includes the following tests:

- a) CAV system with full load
 - Test A1: Constant outdoor air temperature of 10°C, for heating tests
 - Test A2: Constant outdoor air temperature of 30°C, for cooling tests
- b) CAV system with part load
 - Tests B1-B19
- c) VAV (Variable air volume) system with variable load
 - Tests C1-C21

All test cases are under steady-state conditions. The CAV Full Load tests aim to validate the component models in detail, while the CAV Part Load tests are to compare component performance under part load conditions. Because the HVAC components in all of the system tests are almost the same, the VAV Variable Load tests are mainly for the purpose of testing the control strategies at part load conditions.

5.3 Test suite description

The test suite uses the small office building model from the USDOE commercial reference buildings, and makes several modifications to the model to ensure the HVAC loads are the same.

5.3.1 Base case building description

Figure 8 shows the small office building selected from the USDOE commercial reference buildings. It has an unconditioned attic and five conditioned zones: one core and four perimeter. The layout of the five zones has the advantage of testing separated systems fed by one chiller and one boiler, and the architectural composition is common in real buildings.

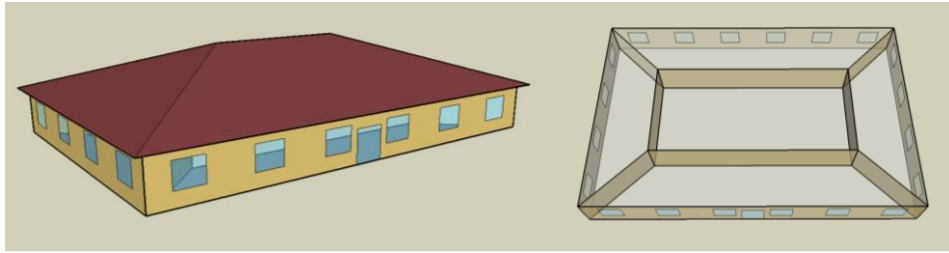

Figure 8 Building model of small office building in ASHRAE 2004

To simplify the comparison and to create a constant thermal load, several modifications and assumptions were made to create an ideal building model, including:

1. The attic space is removed and the pitched roof changed to flat. This is to reduce uncertainties associated with how pitched roofs are handled by EnergyPlus and DeST. The modified building is shown in Figure 9.

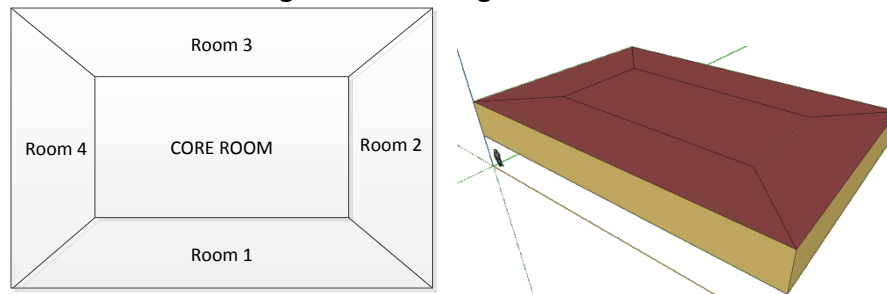

Figure 9 Modified small office building

2. Internal heat gains to internal surfaces are distributed differently by EnergyPlus and DeST, (discussed previously in Loads comparison). To avoid the introduction of such differences in the comparison of the HVAC system simulations, it is assumed that there were no internal heat gains in the five rooms.
3. The algorithm for indoor long-wave radiation is different between DeST and EnergyPlus. To avoid the use of this algorithm, the thermal absorption of all surfaces is set to zero.
4. The effect of sky infrared radiation is ignored by setting exterior surface infrared emittance to 0.
5. Solar heat gains through windows are calculated differently between DeST and EnergyPlus, so all windows are removed.
6. To create a steady-state condition, the weather data is modified to have: constant outdoor air dry-bulb temperature, constant outdoor air humidity ratio, zero solar radiation, and no wind (zero wind velocity).
7. No air infiltration.
8. The floor is a raised floor without ground contact. This is to avoid the different handling of ground heat transfer between EnergyPlus and DeST.
9. All five rooms are always conditioned to have a constant temperature of 20°C.

Important information like material properties for the building envelope is summarized in Table 9 and Table 10.

Table 9 Envelope construction information

Element	External wall	Interior wall	Roof	Floor
conductive resistance $m^2 \cdot K / W$	1.284	0.159	0.627	0.077

Table 10 Interior surface and exterior surface heat transfer coefficients

Element	Vertical ext. surface	Vertical int. surface	Level up int. surface	Level down int. surface	Level ext. surface
surface heat transfer coefficient $W / (m^2 \cdot K)$	23.3	3.5	4.0	1.0	23.3

5.3.2 Building load calculation results

In the simplified building model, the thermal load only includes the heat transfer through the walls, roofs, and floors. Using an outdoor air temperature of 10°C as an example, the load calculation of the core room is discussed as follows.

The heat transfer in the core zone only comes from the roof and floor. The heat transfer coefficient of the roof is:

$$K_{Roof} = \frac{1}{0.627 + \frac{1}{23.3} + \frac{1}{1}} = 0.599$$

So the heat loss from the roof is

$$Q_{Roof} = K_{Roof} \cdot F \cdot \Delta t = 0.599 \times 150 \times 10 = 898.5W = 0.9kW$$

Similarly, the heat transfer coefficient of the floor is:

$$K_{Floor} = \frac{1}{0.077 + \frac{1}{23.3} + \frac{1}{4}} = 2.7$$

Similarly, the heat loss from the floor is:

$$Q_{Floor} = 4.05kW$$

So the total heating load is:

$$Q_{total} = Q_{Roof} + Q_{Floor} = 4.95kW.$$

The annual thermal load of the core zone, calculated by EnergyPlus and DeST under an outdoor temperature of 10°C is shown in Figure 10.

Comparison of HVAC System Simulations in Different Programs

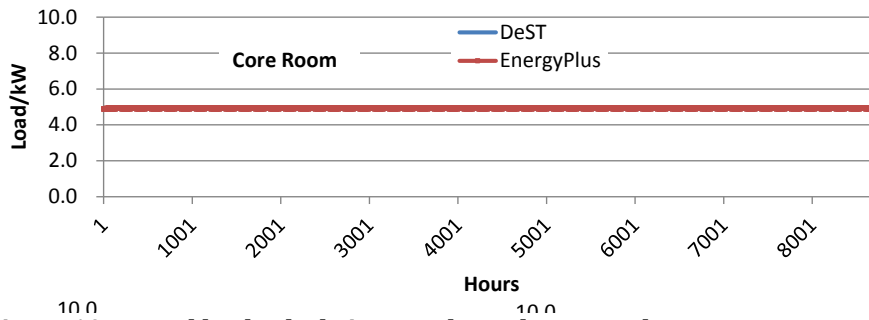

Figure 10 Annual load calculation results under an outdoor temperature of 10°C

The load calculation process for the four perimeter zones is similar to that of the core zone. The thermal loads for the four perimeter rooms from both programs are presented in Figure 11.

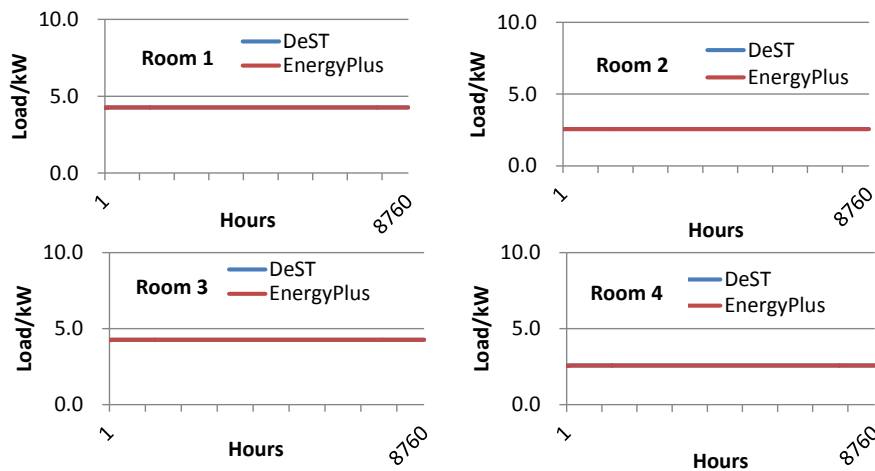

Figure 11 Annual load calculation results of four perimeter rooms under Outdoor Temperature of 10°C

It can be seen from Figure 10 and Figure 11 that EnergyPlus and DeST calculated almost the same heating loads as the analytical solutions. When the outdoor air temperature changes, different levels of building loads can be achieved. The building load will then be passed to the HVAC systems, so the calculation of operation strategies and equipment performance under different load ratios can be completed. The load calculated by the two simulation programs under the same outdoor air temperature is consistent, so the differences arising from the comparison of the HVAC systems can only be caused by the different calculation processes used on the HVAC side. After isolating the HVAC system from the load calculation, this method can focus on the principal problems, which is helpful to the analysis of the HVAC system calculation results.

5.4 CAV full load test cases

Two cases are developed for the CAV full load tests: one with a constant outdoor air temperature of 10°C to test the operation of the HVAC heating components, and the other with a constant outdoor air temperature of 30°C to test the operation of the HVAC cooling components.

5.4.1 Outdoor air condition

Two outdoor air temperatures were used in the full load test cases, 10°C and 30°C, to create the full load conditions for heating and cooling. The relative humidity is 57%.

5.4.2 Indoor air temperature

The indoor air temperature for all five zones of all test cases was set to a constant 20°C.

5.4.3 HVAC System Diagram

The HVAC system Diagram is shown in Figure 12, and detailed settings about each part are introduced in the following parts.

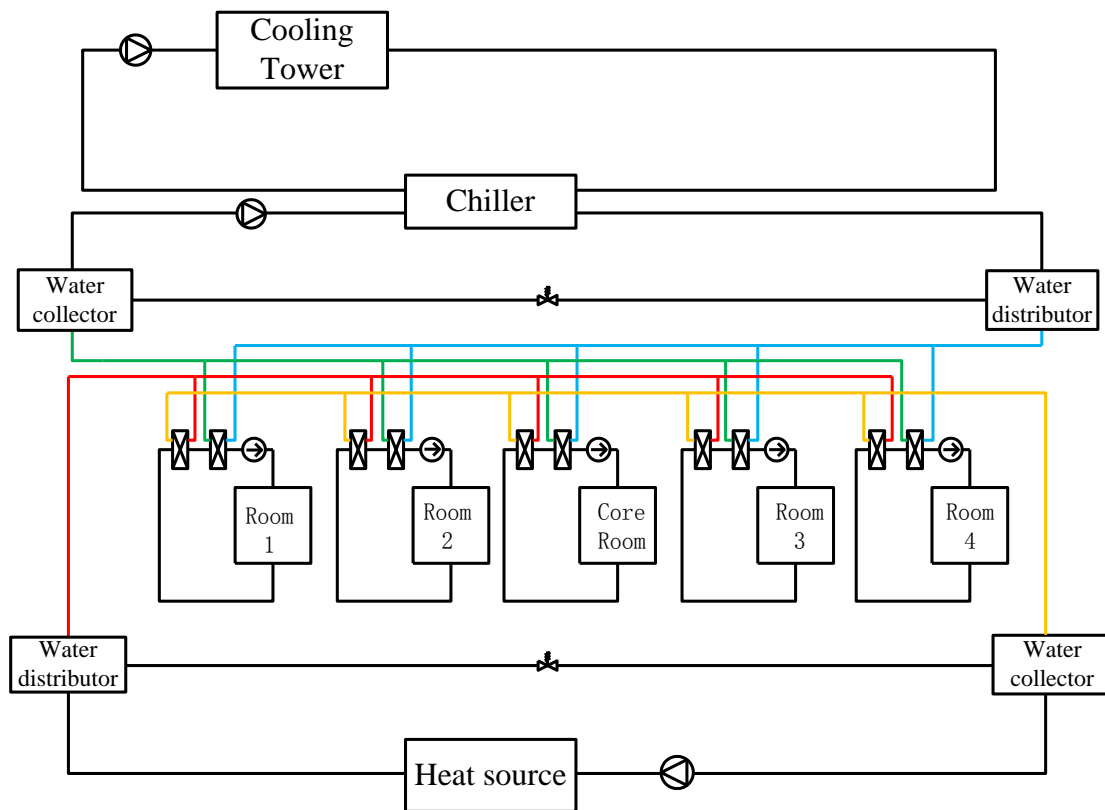

Figure 12 HVAC system schematic diagram

5.4.4 Air distribution system

To avoid problems caused by load differences in the five zones, the air distribution system was designed to be a single-zone CAV system without interactions between zones. The five CAV systems are served by one water system which contains the following components:

Hot water loop: simple hot water boiler, hot water pump

Chilled water loop: electric water chiller, chilled water pump

Condenser water loop: single-speed cooling tower, condenser water pump

Comparison of HVAC System Simulations in Different Programs

Each CAV system has a terminal unit (one for each zone) with a heating coil and a cooling coil. All the coils are ideal counter flow heat exchanger. The terminal units provide adequate cooling and heating airflow rates to meet zone loads and maintain the zone set point temperature with the following assumptions:

- ✓ 100% convective air system
- ✓ 100% efficient with no duct losses
- ✓ Zone air is perfectly mixed
- ✓ No outside air; no exhaust air
- ✓ No fan heat to the air stream with the assumption that the fan motor and transmission drive are located outside the air stream
- ✓ No pump heat to the water system

Heating loads on the hot water heating coils and the design conditions are shown in Table 11.

Table 11 Heating coils loads and design conditions

Zone name	Water inlet T °C	Water outlet T °C	Air inlet T °C	Air outlet T °C	Air flow rate m ³ /h
Core room	60.00	20.01	19.99	23.22	4564.55
Room 1/Room 3	60.00	20.01	19.99	23.67	3460.23
Room 2/Room 4	60.00	20.01	19.99	23.73	2052.65

- ✓ Cooling is provided by a chilled water cooling coil. The design conditions are shown in Table 12.

Table 12 cooling coil design condition

Zone name	Water inlet T °C	Water outlet T °C	Air inlet T °C	Air outlet T °C	Air flow rate m ³ /h
Core room	7	15.5	20	16.8	4564.55
Room 1/Room 3	7	15.5	20	16.3	3460.23
Room 2/Room 4	7	16.3	20	16.3	2052.65

5.4.5 Central plant heating equipment

The central plant heating equipment was a constant flow natural gas-fired hot water boiler with an assumed rated heating efficiency of 85%. The capacity is set to 20470 W. The boiler provides hot water to the heating coils.

Other simulation assumptions for the heating plant included:

- ✓ Hot water pump with a total efficiency (The total efficiency equals motor efficiency times impeller efficiency) of 64% operates against a 219780 Pa head. The rated flow rate is 0.71 m³/h. Motor is located outside of fluid and adds no heat to fluid. The efficiency is assumed to be constant during the entire load ratio.
- ✓ Hot water loop piping is assumed to be perfectly insulated, so no heat loss from the loop.
- ✓ Hot water flow is assumed to be constant.

5.4.6 Central plant cooling equipment

Cooling was provided by a water-cooled electric chiller. Figure 13 to Figure 18 and Table 13 to Table 14 show the comparison of the chiller operation in EnergyPlus and DeST under different conditions. The capacity of the chiller is set to 20470 W and the rated COP is 5. The chiller provides chilled water to a chilled water loop which includes the HVAC system cooling coils. Condenser water is supplied to the chiller condenser from a condenser water loop which includes a cooling tower.

Load ratio = 1, condenser inlet water temperature changes:

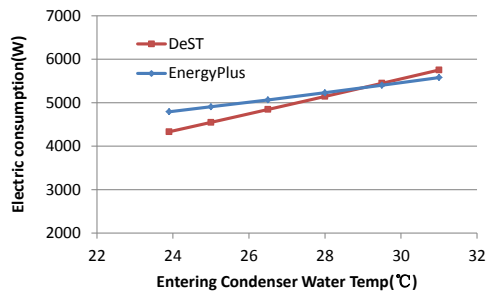

Figure 13 Electricity consumption with condenser supply water temperature, T

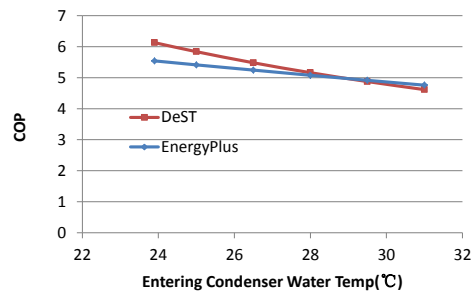

Figure 14 COP changes with entering condenser water T

Load ratio changes:

EnergyPlus performance:

Comparison of HVAC System Simulations in Different Programs

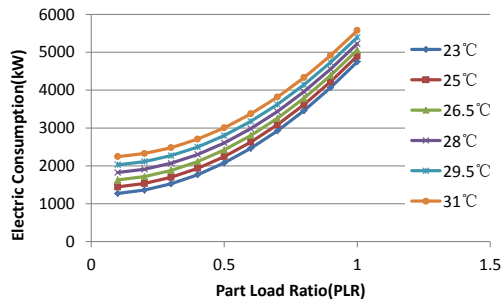

Figure 15 Consumption changes versus PLR and Entering Condensing Water Temperature (ECWT) in EnergyPlus

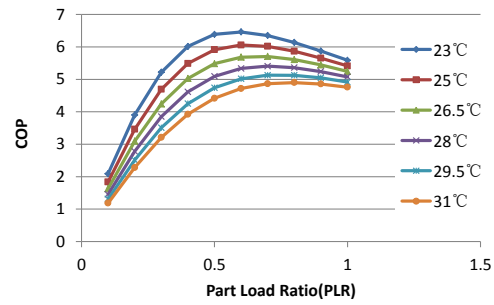

Figure 16 COP changes versus PLR and ECWT in EnergyPlus

DeST performance:

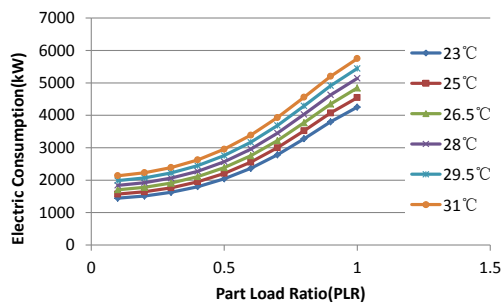

Figure 17 Consumption changes versus PLR and ECWT in DeST

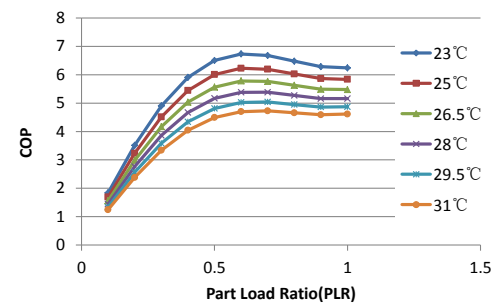

Figure 18 COP changes versus PLR and ECWT in DeST

Table 13 Differences in chiller electricity use between EnergyPlus and DeST under different part load and ECWT conditions

Energy consumption % Different = (EnergyPlus - DeST) / Mean*						
Mean* = (EnergyPlus + DeST) / 2						
	Entering Condenser Water Temp(°C)					
Part Load Ratio (PLR)	23.5	25	26.5	28	29.5	31
0.1	-12.9%	-8.5%	-4.5%	-1.0%	2.1%	4.9%
0.2	-10.4%	-6.8%	-3.6%	-0.6%	2.0%	4.3%
0.3	-6.3%	-3.9%	-1.7%	0.3%	2.1%	3.8%
0.4	-1.8%	-0.8%	0.2%	1.2%	2.2%	3.1%
0.5	1.9%	1.6%	1.5%	1.5%	1.6%	1.7%
0.6	4.1%	2.8%	1.7%	0.9%	0.2%	-0.4%
0.7	5.1%	2.9%	1.1%	-0.4%	-1.8%	-2.9%
0.8	5.4%	2.7%	0.3%	-1.7%	-3.5%	-5.0%

Comparison of HVAC System Simulations in Different Programs

0.9	6.8%	3.7%	0.9%	-1.6%	-3.7%	-5.6%
1.0	11.1%	7.6%	4.4%	1.6%	-0.9%	-3.1%

Table 14 Differences of chiller COP between EnergyPlus and DeST under different part load and ECWT conditions

COP %Different = (EnergyPlus - DeST)/DeST						
	Entering Condenser Water Temp(°C)					
Part Load Ratio(PLR)	23.5	25	26.5	28	29.5	31
0.1	12.9%	8.5%	4.5%	1.0%	-2.1%	-4.9%
0.2	10.4%	6.8%	3.6%	0.6%	-2.0%	-4.3%
0.3	6.3%	3.9%	1.7%	-0.3%	-2.1%	-3.8%
0.4	1.8%	0.8%	-0.2%	-1.2%	-2.2%	-3.1%
0.5	-1.9%	-1.6%	-1.5%	-1.5%	-1.6%	-1.7%
0.6	-4.1%	-2.8%	-1.7%	-0.9%	-0.2%	0.4%
0.7	-5.1%	-2.9%	-1.1%	0.4%	1.8%	2.9%
0.8	-5.4%	-2.7%	-0.3%	1.7%	3.5%	5.0%
0.9	-6.8%	-3.7%	-0.9%	1.6%	3.7%	5.6%
1.0	-11.1%	-7.6%	-4.4%	-1.6%	0.9%	3.1%

Water chiller performance data shown above contains a 7.5°C range on the condenser water temperatures and PLR from 0.1 to 1. Other simulation assumptions included:

- ✓ Chilled water pump with a total efficiency of 64% operates against a 279640 Pa head. The rated flow rate is 3.53 m³/h. Motor is located outside of fluid and adds no heat to fluid.
- ✓ Condenser water pump with a total efficiency of 64% operates against a 197740 Pa head. The rated flow rate is 4.23 m³/h. Motor is located outside of fluid and adds no heat to fluid.
- ✓ The fan of the cooling tower has a rated power of 340 W
- ✓ Chilled water and condenser water loop piping are assumed to be perfectly insulated so there is no heat loss.
- ✓ Chilled water and condenser water flows are assumed to be constant.

5.4.7 Results comparison and discussion

In the steady-state test cases, each component’s calculation method will be discussed in detail, as well as the calculation results. The totals and component breakdowns for electricity consumption will be presented to analyze the differences between the EnergyPlus and DeST HVAC system calculations.

A. Outdoor air temperature of 10°C

Under this steady-state condition, only the heating load will be passed to the HVAC system. The working components include the heating coil, the hot water pump, and the boiler.

1. Heating coil

The calculation method for heating coils in DeST uses a heating efficiency method, while EnergyPlus uses the ϵ -NTU method. The two methods are the same in principle, and if the corresponding input parameters are consistent, there will be no difference in the results. A coil database is supplied by DeST to allow users to select a desired coil. The coil can also be chosen automatically (default) by DeST. The information in the coil database includes the rated capacity, rated airflow rate, heat exchange area per row, head-on area, and so on. This information will be used in the coil calculations. The input parameters in EnergyPlus include the UA value, maximum water flow rate, and so on. In EnergyPlus, the UA value can also be obtained by inputting the design conditions and then letting the program calculate the UA value.

To make input values as consistent as possible, the same airflow rate, air-side temperatures, and water side temperatures are input to both programs. The NTU value in the ϵ -NTU method used by EnergyPlus is the same as the temperature difference correction factor β in the heating efficiency method used by DeST, so the UA value in EnergyPlus can be estimated according to the information in DeST. Calculation results are compared in Table 15, which shows that the calculation method is similar between EnergyPlus and DeST.

Table 15 Calculation results of heating coil in Test A1

	Calculation %Different(E-Plus - DeST)/ Mean*						
	Mean* = (EnergyPlus + DeST) / 2						
zone name	Air Entering temp. from coil (°C)	Air flow rate (m3/h)	Leaving Air Temp. (°C)	Entering Water Temp. (°C)	Leaving Water Temp. (°C)	Water Flow Rate (kg/h)	Total heating Load (kW)
Core Room	0.0%	-0.4%	-0.1%	0.0%	0.0%	-1.0%	-1.9%
Room 1/Room 3	0.0%	-1.1%	0.0%	0.0%	0.3%	-0.6%	-1.7%
Room 2/Room 4	0.0%	-0.9%	0.0%	0.0%	0.4%	-0.6%	-1.8%

2. Hot water pump

The hot water pump is a constant speed pump. In EnergyPlus, it is assumed that the electricity consumption of a constant speed pump is equal to the rated pump power consumption. If the equipment is auto-sized, the rated power consumption is calculated from the inputs of rated flow rate, rated pump head, and motor efficiency. As an example, in this test case, the rated pump head is 219780 Pa, rated flow rate is 0.000197222 m³/s, and the motor efficiency is 0.82. The total efficiency equals motor efficiency times impeller efficiency. When it is auto-sized, the impeller efficiency is set to 0.823 in the code. So in this case, the rated pump power consumption = 0.000197222 × 219780 / 0.823 / 0.78 = 67.52W . The pump power consumption is constant to be 67.52 W.

In DeST, if the pump cannot supply the required flow rate or the water head, the flow rate and pump head will be set to the rated values. If the pump operates appropriately, the pump head and the efficiency would be calculated based on a quadratic curve equation of flow rate ratio as following:

$$G_{ratio} = G / G_{rated}$$

$$EFF = Rate_EFF \times (-0.8967 * G_{ratio}^2 + 1.8613 * G_{ratio} + 0.0011) / 0.9657$$

$$P = Rated_P * (-0.3813 * G_{ratio}^2 + 0.1544 * G_{ratio} + 1.1589) / 0.932$$

Where,

G is the pump flow rate in m³/s;

EFF is the efficiency of the pump;

P is the pump head.

In this case, G_{ratio} is 1, so EFF=0.64, P=219.63 Pa, and the pump power consumption in DeST = 0.71 × 219.63 / 0.64 / 3600 = 67.68W .

The calculation results from both programs are shown in Figure 19. The result of DeST overlay that of EnergyPlus.

Comparison of HVAC System Simulations in Different Programs

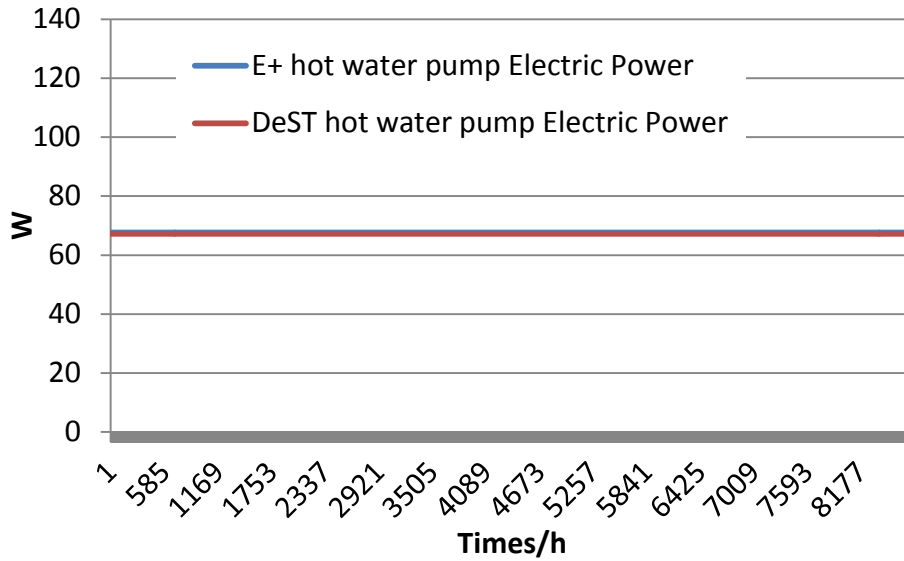

Figure 19 Hot water pump's electricity consumption in Test A1

3. Constant volume fan

In DeST and EnergyPlus, the fan model is calculated by the equation:

$$Q_{tot} = m \cdot \Delta P / (e_{tot} \cdot \rho_{air})$$

Where,

- Q_{tot} is the fan power in watts;
- m is the air mass flow in kg/s;
- ΔP is the fan design pressure drop in Pascals;
- e_{tot} is the fan total efficiency;
- ρ_{air} is the air density in kg/m³.

DeST assumes that ρ_{air} is a constant of 1.2 kg/m³, while in EnergyPlus, the air density is under standard conditions, which means that the local atmosphere has an air temperature of 20°C, and the humidity ratio is 0.

As the inputs of the two programs are almost the same, the fan power results are very close, as shown in Table 16.

Table 16 Fan electricity consumption in Test A1

	DeST	EnergyPlus	%Different = (EnergyPlus - DeST)/ Mean*
Air volume flow rate (m3/h)	15590	15456	-0.9%
Pressure rise (Pa)	62.2	62.2	0.0%
Total Efficiency	0.54	0.54	0.0%
Power (kW)	0.502	0.498	-0.9%

4. Boiler

Due to the use of a bypass pipe, the water flow rate of a boiler can be the same as

the rated value, 0.71 m³/h. In DeST, the boiler provides the exact amount of heat to meet the heating demand (18.61 kW). For natural gas boilers, the efficiency is constant under all situations, which is DeST's assumption. So the total fuel consumption of boiler is:

$$Boiler_Consume_Fuel = Boiler_Q / Boiler_E / GasheatValue * 3600$$

Where,

Boiler_Q is the heating load the boiler needs to deal with in watts;

Boiler_E is the boiler's efficiency;

GasheatValue is the gas heating value in kJ/m³.

DeST assumes a gas heating value of 35170kJ/m³, so the boiler fuel consumption is 2.24 kg/h.

In EnergyPlus, the flow rate of the boiler is also equal to the rated value of 0.71 m³/h. The rated efficiency is set to 0.85, the same value used by DeST. The efficiency curve is set to keep a constant value of 1. So the boiler gas consumption is:

$$= Boiler_Q / Nor\ min\ aThermalEffciency / BoilerEffiencyCurveOutput .$$

Nor min aThermalEffciency is the boiler's rated efficiency;

BoilerEffiencyCurveOutput is the output of the boiler's efficiency curve which is used to modified the efficiency under PLR.

To compare the two results, the boiler fuel consumption in DeST is converted to the boiler gas consumption rate. The results, shown in Figure 20, from both programs are close, basically due to the use of same or equivalent inputs.

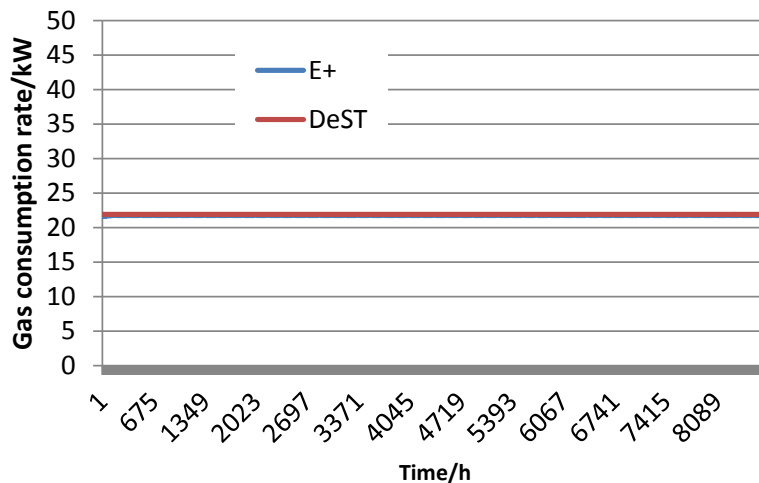

Figure 20 Boiler gas consumption in Test A1

B. Outdoor air temperature of 30°C

Under this steady-state condition, only the sensible cooling load will be passed to the HVAC system; there is no latent load on the system; outdoor air humidity ratio only affects cooling tower performance. The working components include: cooling coil, chilled water pump, condenser water pump, chiller, supply fan, and cooling tower.

Because the fan operating conditions are the same as above, the analysis will not be conducted again.

1. Cooling coil

When the cooling coil is dry, the calculation method is the same as the heating coil, which means that the thermal efficiency method is used by DeST, while the ϵ -NTU method is used by EnergyPlus. If the coil is wet, the thermal efficiency method still applies so no modification is made to the calculations performed by DeST. However, for EnergyPlus, the ϵ -NTU method is not appropriate for a wet coil, so the enthalpy is used to replace the temperature. This changes the calculation to be equivalent to the dry coil calculation, i.e. it is the same as the thermal efficiency method for a wet coil. Since there is no outdoor air or internally generated moisture in this case, the coil is considered dry. The comparison results are shown in Table 17.

Table 17 Cooling coil calculation results in Test A2

	$\% \text{Different} = (\text{EnergyPlus} - \text{DeST}) / \text{Mean}^*$						
zone name	Air Entering Temp. from coil (°C)	Air Flow Rate (m ³ /h)	Leaving Air Temp. (°C)	Entering Water Temp. (°C)	Leaving Water Temp. (°C)	Water Flow Rate (kg/h)	Total Cooling Load (kW)
Core Room	0.0%	-0.4%	0.1%	0.0%	1.0%	-1.6%	-0.9%
Room 1/Room 3	0.0%	-1.1%	0.0%	0.0%	0.7%	-1.6%	-0.9%
Room 2/Room 4	0.8%	-0.9%	1.6%	0.0%	-1.6%	0.0%	6.0%

2. Chilled water pumps and condenser water pumps

The calculation methods for constant speed pumps are all the same and have been explained in detail in the hot water pump section of this report. Only the calculation results are presented here.

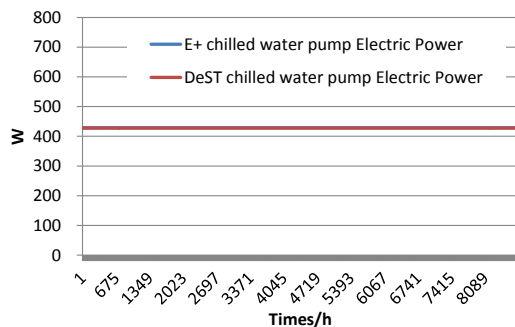

Figure 21 Electricity consumption of chilled water pump in Test A2

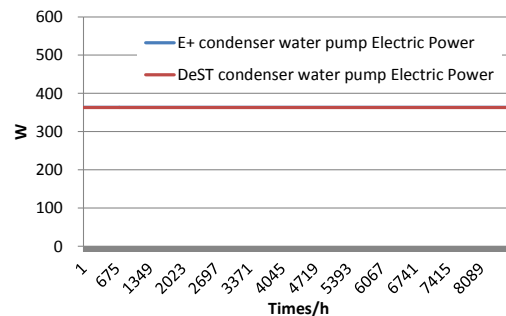

Figure 22 Electricity consumption of condenser water pump in Test A2

3. Chillers

In DeST, the chiller water flow rate is constant and equal to the rated value. The outlet water temperature from the chiller is maintained at 7°C if the capacity of the chiller is high enough. The COP is determined by the following equations:

$$Q_{ratio} = Q / rated_Q$$

$$COP_{ratio} = ((116.65 / T_{cond,in} - 1.65) * \sin(4.1 * Q_{ratio}) + (454.06 / T_{cond,in} - 2.88) * \sin(0.765 * Q_{ratio})) / T_{evap,out}$$

$$COP = rated_COP * COP_{ratio}$$

Where,

Q_{ratio} is the part load ratio;

COP_{ratio} is the part load COP ratio;

$T_{cond,in}$ is the condenser water inlet temperature in °C;

$T_{evap,out}$ is the chilled water outlet temperature in °C.

In EnergyPlus, three electric chiller models are available: an electric chiller model based on the fluid temperature difference; an electric chiller model based on the condenser inlet temperature; and an electric chiller model based on the condenser outlet temperature. In this case, the electric chiller model based on the fluid temperature differences was chosen, because this model has the same input parameters with the chiller model used in DeST. It is also the simplest chiller model with the fewest performance curves. The model is an empirical model from the BLAST program. Chiller performance curves are generated by fitting simulation results from the calculation of DeST chiller model to the three second-order polynomial equations. The curves adjust the output according to the influence of the chiller's available capacity, part-load performance, and operating conditions as follows:

$$CapRatio = A_1 + A_2 \Delta T_{chiller} + A_3 \Delta T_{chiller}^2$$

$$\text{Where } \Delta T_{chiller} = \frac{T_{cond,in} - T_{cond,in,design}}{TempRiseRatio} - (T_{evap,out} - T_{evap,out,design});$$

$$PowerRatio = B_1 + B_2 PLR + B_3 PLR^2;$$

$$\text{Where } PLR = \frac{ChillerCoolingLoad}{No\ min\ alChillerCapacity};$$

$$LoadRatio = C_1 + C_2 CapRatio + C_3 CapRatio^2;$$

$$Q_{evap} = AvailibleChillerCap * PLR$$

$$Power = PowerRatio * LoadRatio * \frac{AvailableChillerCap}{RatedCOP}$$

Where,

$TempRiseRaio$ is the ratio of required change in condenser water temperature to a given change in chilled water temperature;

$T_{cond,in, rated}$ is the rated condenser water inlet temperature in °C;

$T_{evap,out, rated}$ is the rated chilled water outlet temperature in °C;

In EnergyPlus, the coefficients of the curves have to be provided by users. To avoid the differences caused by the different chillers' performance, the curve coupling work has been conducted by using DeST to generate the performance data. This was then regressed to produce the EnergyPlus curves. The chiller COPs and electricity consumption are shown in Figure 23 and Figure 24.

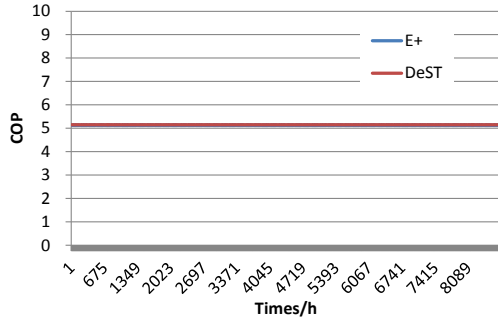

Figure 23 Chiller COPs in Test A2

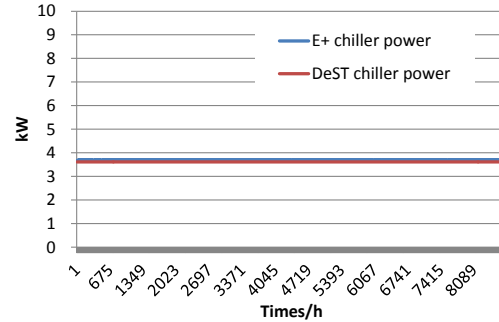

Figure 24 Chiller electricity consumption in Test A2

4. Cooling towers

In DeST, the cooling towers have a constant water flow rate. The fan power is also constant, using the rated value. The cooling tower inlet water temperature is calculated iteratively. First, on the chiller side, the condenser inlet temperature (the cooling tower outlet temperature) is assumed to be 32°C, then, the condenser outlet temperature (the cooling tower inlet temperature) is calculated. For example, in this test case using a centrifugal chiller, the cooling tower inlet temperature is:

$$CoolerT_{out} = Q * 3.6 * (1 + COP_{ratio}) / (COP_{ratio} * Water_heat * G) + CoolerT_{in}$$

Where,

$CoolerT_{out}$ is the chiller outlet temperature, or the cooling tower inlet temperature;

Q is the cooling load on the chiller;

COP_{ratio} is the part load COP ratio;

$Water_heat$ is the specific heat of water;

G is the water flow rate through the chiller's condenser side;

$CoolerT_{in}$ is the chiller inlet temperature, or the cooling tower outlet temperature.

Then, the cooling tower inlet water temperature is combined with the cooling tower characteristics to calculate a new cooling tower outlet water temperature. If the two cooling tower outlet temperatures satisfy the convergence criteria, the calculation stops. Otherwise, the new cooling tower outlet temperature replaces the old one and the process is repeated until convergence is reached or the maximum number of

iterations is reached.

In EnergyPlus, it is assumed that enthalpy of the wet air can be determined using the wet-bulb air temperature. The cooling tower steady-state calculation is the same as that used in DeST. The iterative method is also used for steady-state conditions. The only differences are the initial assumptions of the cooling tower outlet air wet-bulb temperature and the convergence criteria. This methodology is used to calculate the exiting water temperature in the free convection regime (water pump on, tower fan off) and with the tower fan operating (including low and high fan speed for the two-speed tower). Under actual conditions, the cooling tower model seeks to maintain the temperature of the water exiting the cooling tower at (or below) a set point which can be input by users. For these part-load operations, the model assumes a simple linear interpolation between two steady-state regimes without accounting for any cycling losses

The calculation results are as follows:

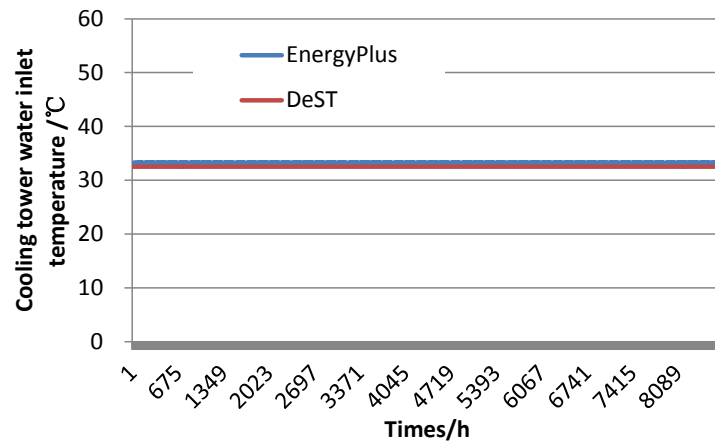

Figure 25 Cooling tower water inlet temperature in Test A2

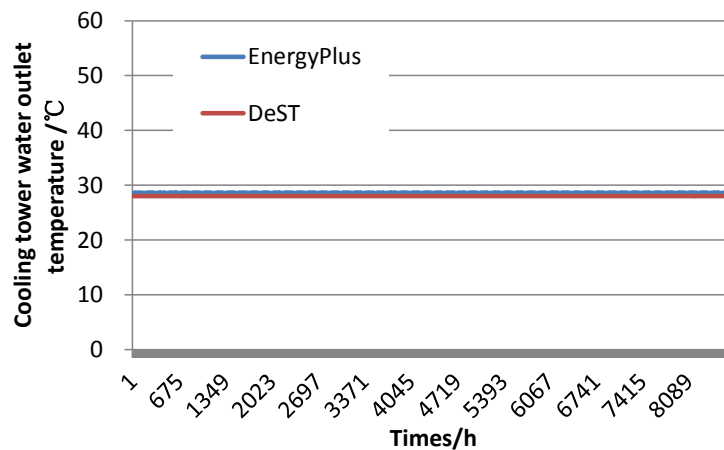

Figure 26 Cooling tower water outlet temperature in Test A2

Comparison of HVAC System Simulations in Different Programs

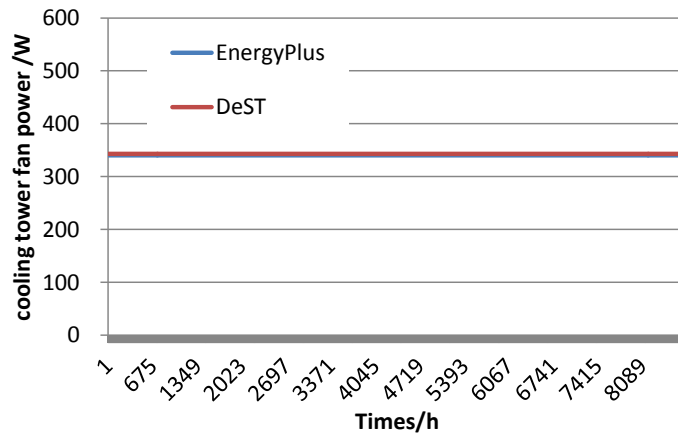

Figure 27 Cooling tower electricity consumption in Test A2

The differences of results are mainly caused by two reasons:

1) The enthalpy calculation method

The method for calculating enthalpy differs between the two programs. In EnergyPlus, the enthalpy is estimated using the wet-bulb temperature with the following equation:

$$H = TDB + W * (2.5 + 1.86 * TDB);$$

where,

W is the humidity ratio when the relative humidity is 100%;

TDB is the wet-bulb temperature in °C;

In DeST, the enthalpy is also estimated by using the wet-bulb temperature, but using a different equation:

$$H = 9.3625 + 1.7861 * TDB + 0.01135 * TDB^2 + 0.98855 / 1000 * TDB^3$$

During the design sizing calculations for the cooling tower, the TDB is assumed to be 28°C in DeST.

2) The air temperature used for auto-sizing

When the UA value for the cooling tower is auto-sized, in EnergyPlus, the air dry-bulb temperature is assumed to be 35°C, and the air wet-bulb temperature is 25.6°C. While in DeST, the air dry-bulb temperature is assumed to be 28°C, and the air relative humidity is set to 100%.

C. Comparison of the energy consumption

As discussed before, although some input parameters are different between the two programs, users can set them to consistent values based on an understanding of the calculation process. The steady-state test cases introduce an ideal environment for testing, which makes the process easier for users to understand. Because the core component modeling engines are quite similar in the two programs, the calculation results have small differences between them. Table 18 and Table 19 summarize the energy consumption results in Test A1 and Test A2.

Table 18 Energy consumption comparison of Test A1: CAV Full Load, outdoor air temperature of 10°C

	EnergyPlus	DeST	%Difference = (EnergyPlus - DeST)/ Mean*
Pump Electric Use kWh	592.2	588.9	0.6%
Fan Electric Use kWh	4362.5	4397.5	-0.8%
Boiler Gas Use MWh	190.8	191.8	-0.5%

Table 19 Energy consumption comparison of Test A2: CAV Full Load, outdoor air temperature of 30°C

Electric Consumption kWh	EnergyPlus	DeST	%Difference = (EnergyPlus - DeST)/ Mean*
Chiller	32301	31671	2.0%
Chilled water pump	3755	3746	0.2%
Condenser water pump	3182	3179	0.1%
Cooling tower fan	2978	3006	-0.9%
Supply Fan	4362	4397	-0.8%
Total	46580	46000	1.3%

5.5 CAV Part Load Tests

5.5.1 Test case settings

These cases were designed to test the ability of a program to model the part-load performance of components for a constant air volume system. The configurations of the test cases are the same as those in the CAV Full Load tests, only the outdoor air dry-bulb temperature is changed to create a part-load environment. The outdoor air relative humidity is set to a constant of 57%, which allows simultaneous evaluation of cooling tower performance as PLR is varied by reducing ODB. Table 20 describes the outdoor air dry-bulb temperature used for each test. The temperature changes every 400 hours to ensure that a steady state temperature can be achieved for a range of heating/cooling load ratios. The data analysis below is for the 200th hour of each test case.

Comparison of HVAC System Simulations in Different Programs

Table 20 Configurations of CAV Part Load Tests

Test Case	Hours	Load ratio (negative means cooling load)	Outdoor air dry-bulb temperature (°C)
A1	1-400	-100%	10
B1	401-800	-90%	11
B2	801-1200	-80%	12
B3	1201-1600	-70%	13
B4	1601-2000	-60%	14
B5	2001-2400	-50%	15
B6	2401-2800	-40%	16
B7	2801-3200	-30%	17
B8	3201-3600	-20%	18
B9	3601-4000	-10%	19
B10	4001-4400	0	20
B11	4401-4800	10%	21
B12	4801-5200	20%	22
B13	5201-5600	30%	23
B14	5601-6000	40%	24
B15	6001-6400	50%	25
B16	6401-6800	60%	26
B17	6801-7200	70%	27
B18	7201-7600	80%	28
B19	7601-8000	90%	29
A2	8000-8760	100%	30

5.5.2 Results and comparison

As the modeling for each component has been described in detail in the CAV with full load section, only the results and discussions will be presented here.

A. Constant components

Comparison of HVAC System Simulations in Different Programs

The operation of some components is not influenced by the load ratio, so the energy consumption will not change, e.g. constant speed pumps (Figure 28 to Figure 30) and supply fans (Figure 31).

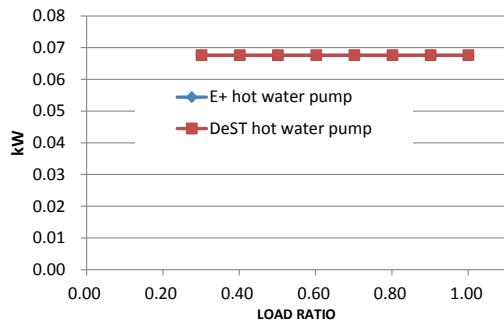

Figure 28 Hot water pump power consumption under different PLRs

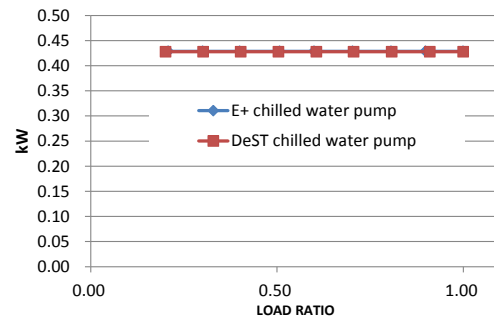

Figure 29 Chilled water pump power consumption under different PLRs

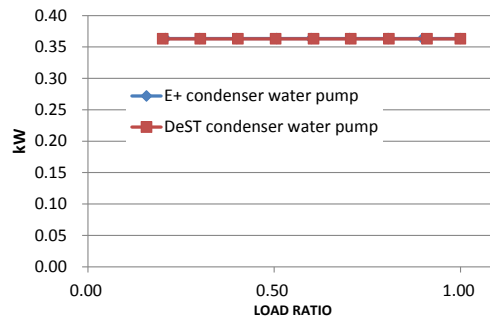

Figure 30 Condenser water pump power consumption under different PLRs

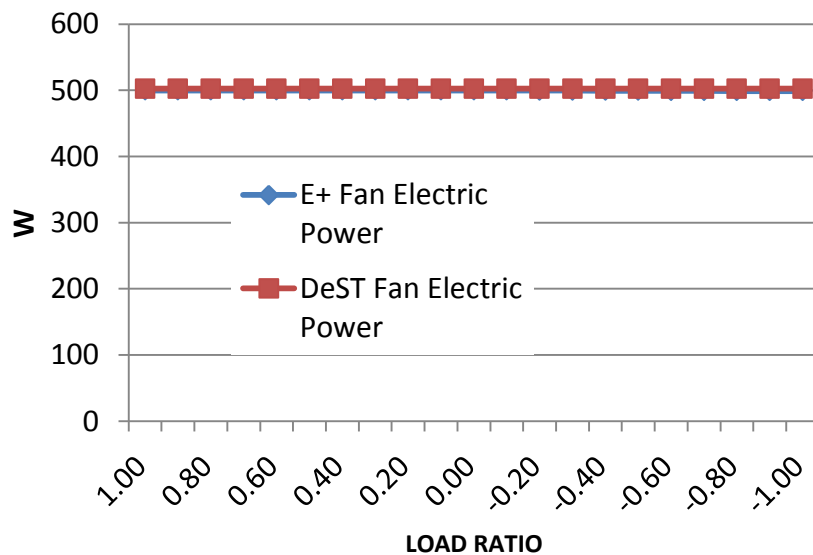

Figure 31 Fan power consumption under different PLRs (a negative load ratio represents a cooling load)

B. Variable components

The performance of some components varies as the load ratio changes, including the chiller, boiler, cooling tower, and heating/cooling coils.

1) Chiller

As described before, the curves used in the chiller model modify the output according to several factors which include the load ratio. Although the curve equations are different between the two programs, these performance curves were made equivalent, so the chiller part load simulation results are similar, as shown in Figure 32 and Figure 33.

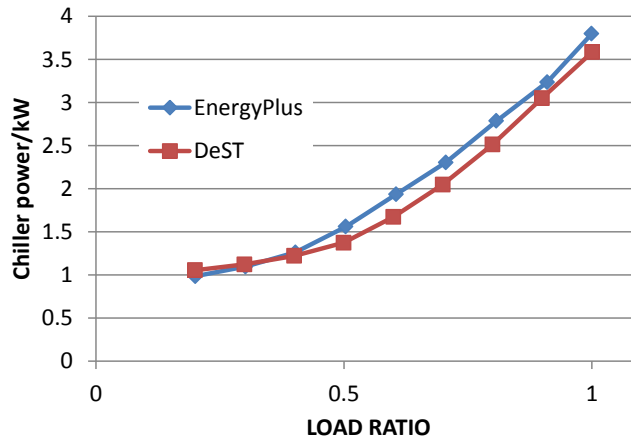

Figure 32 Chiller electricity consumption under different PLRs

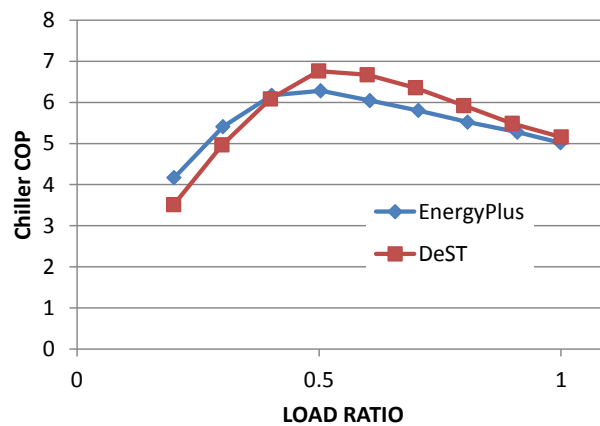

Figure 33 Chiller COP under different PLRs

2) Boiler

Since the efficiency of the boiler is assumed to be constant, the boiler gas consumption changes only with load ratio so the results are consistent, as Figure 34 shows.

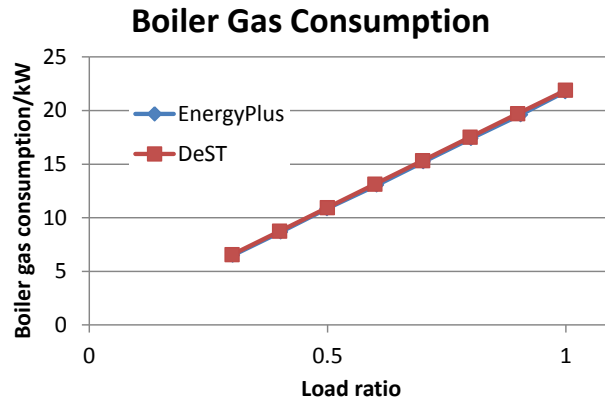

Figure 34 Boiler gas consumption under different PLRs

3) Cooling tower

a) Cooling tower fan consumption

In DeST, the cooling tower fan consumption is assumed to be constant, while in EnergyPlus, the fan power will be a linear interpolation of results from the two steady-state regimes – the tower fan switched on for the entire simulation time step and tower fan switched off for the entire time step. When the load ratio decreases, the fan consumption in the two programs will differ gradually as shown.

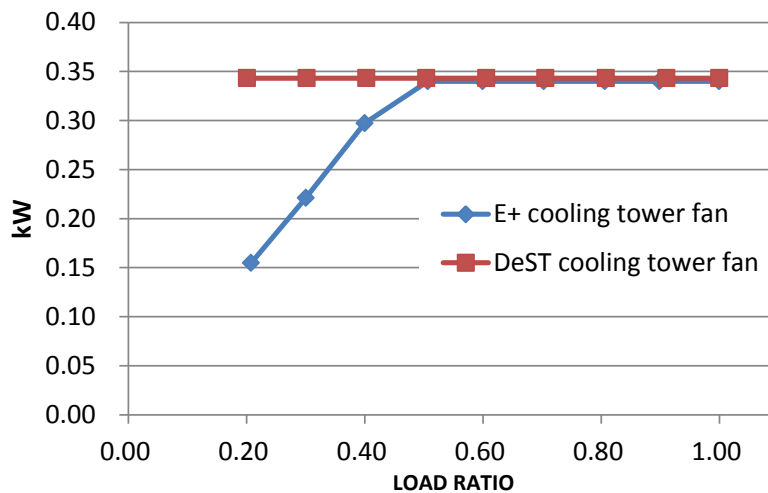

Figure 35 Cooling tower fan consumption under different PLRs

b) water inlet/outlet temperature

Figure 36 and Figure 37 are provided to give an indication of how the inlet and outlet temperatures of the cooling tower vary with the part load ratio. Because the air and water flow rates are constant in the cooling tower model, the water inlet/outlet temperatures change mainly due to changes in the outdoor wet-bulb temperature and the load on the condenser side.

Comparison of HVAC System Simulations in Different Programs

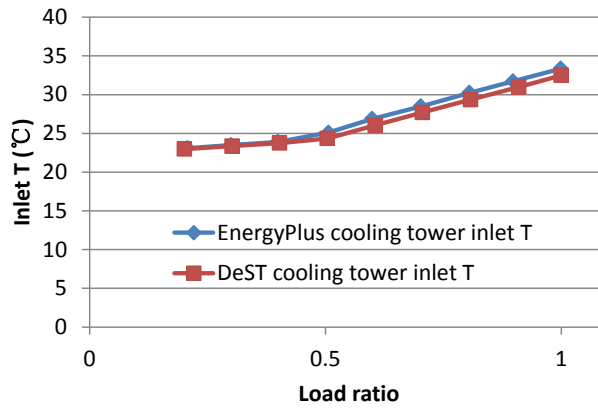

Figure 36 Cooling tower inlet water temperature under different PLRs

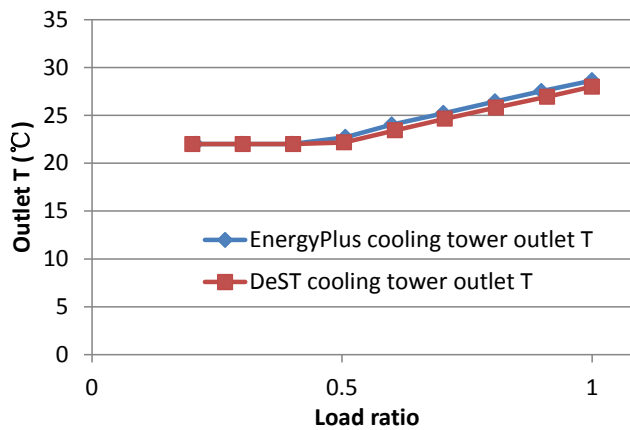

Figure 37 Cooling tower outlet water temperature under different PLRs

4) Cooling and heating coils

The hA value on the air side and the water side of the coil is an exponential function of the flow rate ratio. The coefficient of the exponential function on the air side in EnergyPlus is 0.8 while it is 0.52 in DeST. Similarly, EnergyPlus sets the coefficient of the exponential function on the water side to 0.85 while DeST sets it to 0.8. So the differences will increase as the water flow rate decreases. Table 21 and Table 22 give an example of the part load performance of the coil.

Table 21 Comparison of heating coil performance under different PLRs

Load ratio	core zone, %Difference = (EnergyPlus - DeST)/ Mean*						
	Air Entering temp. from coil	Air flow rate (m ³ /h)	Leaving Air Temp. LAT(°C)	Entering Water Temp. EWT(°C)	Leaving Water Temp. LWT(°C)	Water Flow Rate ChWFR (kg/h)	Total Heating Load CLT (kW)
1.00	0.0%	0.7%	-0.3%	0.0%	0.1%	-0.7%	-1.5%
0.90	0.0%	0.7%	-0.2%	0.0%	0.1%	0.0%	-1.0%
0.80	0.0%	0.7%	-0.2%	0.0%	0.1%	-0.5%	-1.4%

Comparison of HVAC System Simulations in Different Programs

0.70	0.0%	0.7%	-0.2%	0.0%	0.0%	-0.5%	-1.5%
0.60	0.0%	0.7%	-0.1%	0.0%	0.0%	-0.1%	-1.1%
0.50	0.0%	0.7%	-0.1%	0.0%	0.0%	-0.8%	-1.9%
0.40	0.0%	0.7%	-0.1%	0.0%	0.0%	-0.1%	-1.3%
0.30	0.0%	0.7%	0.0%	0.0%	0.0%	-0.2%	-1.4%
0.20	0.0%	0.7%	-0.1%	0.0%	0.0%	-1.9%	-3.3%
0.10	0.0%	0.7%	-0.1%	0.0%	0.0%	-8.0%	-9.4%

Table 22 Comparison of cooling coil performance under different PLRs

core zone, %Difference = (EnergyPlus - DeST)/ Mean*							
Load ratio	Air Entering temp. from coil	Air flow rate AFR(m ³ /h)	Leaving Air Temp. LAT(°C)	Entering Water Temp. EWT(°C)	Leaving Water Temp. LWT(°C)	Water Flow Rate ChWFR (kg/h)	Total Heating Load CLT(kW)
0.10	0.0%	0.7%	0.0%	0.0%	1.9%	-1.0%	0.6%
0.20	0.0%	0.6%	-0.1%	0.0%	2.6%	-0.1%	2.7%
0.30	0.0%	0.5%	0.0%	0.0%	3.0%	-4.6%	-1.2%
0.40	0.0%	0.4%	0.0%	0.0%	2.8%	-4.5%	-1.3%
0.50	0.0%	0.4%	-0.1%	0.0%	2.9%	3.6%	-0.1%
0.61	0.0%	0.3%	0.0%	0.0%	2.5%	2.3%	-1.7%
0.71	0.0%	0.2%	0.0%	0.0%	2.7%	-4.1%	-1.0%
0.81	0.0%	0.2%	-0.1%	0.0%	1.6%	0.4%	-0.8%
0.91	0.0%	0.1%	0.0%	0.0%	2.0%	-3.6%	-1.9%
1.00	0.3%	0.1%	0.1%	0.0%	0.8%	1.8%	-0.6%

C. Comparison of energy consumption

The total energy consumption and differences in the test cases of the CAV Part Load test are depicted in Table 23.

Table 23 Energy consumption comparison of CAV Part Load tests under different PLRs

Electric Consumption kWh	EnergyPlus	DeST	%Difference = (EnergyPlus - DeST)/ Mean*
Chiller	8914	8333	6.7%
Chilled water pump	1697	1693	0.2%
Condenser water pump	1438	1436	0.1%
Hot water pump	216	215	0.6%
Cooling tower fan	1207	1358	-11.8%
Supply Fan	4375	4400	-0.6%
Total	17848	17437	2.3%
Boiler Gas Consumption	45388	45519	-0.3%

5.6 VAV Variable Load

5.6.1 Test case configurations

The VAV system has the same HVAC components as the CAV system except there are differences in the supply fan and system control strategy – the VAV system has a variable speed fan, and the supply airflow rate and temperature are adjusted to meet the cooling and heating loads. The VAV cases were designed specifically to test the control strategies in EnergyPlus and DeST. As there are multiple control strategies for VAV systems in EnergyPlus, the control behavior corresponding to the Normal Acting damper for the terminal units is chosen. The Normal Acting damper means that during heating, the damper stays at the minimal position.

5.6.2 Outdoor air temperature

The weather data used in the CAV test cases is also applied here. The outdoor air dry-bulb temperature is shown in the following table, while the outdoor air relative humidity is set to a constant of 57%.

Table 24 Configurations of VAV Part Load Tests

Test Cases	Hours	Outdoor air dry-bulb temperature (°C)
C1	1-400	10
C2	401-800	11
C3	801-1200	12

Comparison of HVAC System Simulations in Different Programs

C4	1201-1600	13
C5	1601-2000	14
C6	2001-2400	15
C7	2401-2800	16
C8	2801-3200	17
C9	3201-3600	18
C10	3601-4000	19
C11	4001-4400	20
C12	4401-4800	21
C13	4801-5200	22
C14	5201-5600	23
C15	5601-6000	24
C16	6001-6400	25
C17	6401-6800	26
C18	6801-7200	27
C19	7201-7600	28
C20	7601-8000	29
C21	8000-8760	30

5.6.3 Air distribution system

Five simple air distribution systems are modeled as VAV air terminals with no reheat. Each VAV system serves a single zone and has a terminal unit (one for each zone) with a heating coil and a cooling coil. The five VAV systems are served by one water system which contains the following components:

Hot water loop: simple hot water boiler, hot water pump;

Chilled water loop: electric water chiller, chilled water pump;

Condenser water loop: single-speed cooling tower, condenser water pump.

An HVAC system (one for each zone) with the following characteristics provides whatever heating or cooling the space needs in order to maintain the set point temperature. The building load of room 1 is the same as room 3. Also, the load of room 2 is the same as room 4, so repeated information will not be mentioned below:

Comparison of HVAC System Simulations in Different Programs

- ✓ 100% convective air system
- ✓ 100% efficient with no duct losses and large enough capacity
- ✓ Zone air is perfectly mixed
- ✓ No outside air; no exhaust air
- ✓ No fan heat and pump heat to the air stream
- ✓ Indoor air set at a temperature of 20°C
- ✓ information about the limits of air volume and supply air temperature in each zone, as Table 25 :

Table 25 Information about VAV system supply air volume and SAT

Zones	Maximum design air flow rate m ³ /h	Minimum design air flow rate m ³ /h	Maximum supply air temperature °C	Minimum supply air temperature °C
Core room	4565	913	32	14
Room 1/3	3460	692	32	14
Room 2/4	2053	411	32	14

- ✓ Heating provided by hot water heating coil and the design condition is as Table 26:

Table 26 Design condition of heating coil

Zone name	Water inlet T °C	Water outlet T °C	Air inlet T °C	Air outlet T °C	Air flow rate m ³ /h
Core room	60	21.88	19.99	32	1226
Room 1/3	60	21.59	19.99	32	1060
Room 2/4	60	20.83	19.99	32	638

- ✓ Cooling provided by chilled water cooling coil, and the design condition is as Table 27 :

Table 27 Design condition of cooling coil

Zone name	Water inlet T °C	Water outlet T °C	Air inlet T °C	Air outlet T °C	Air flow rate m ³ /h
Core room	7	13.55	20	14	2500
Room 1/3	7	13.87	20	14	2200
Room 2/4	7	14.92	20	14	1300

5.6.4 Central plant heating equipment and central plant cooling equipment

The central plant heating equipment is a constant flow natural gas-fired hot water boiler and the central plant cooling equipment is a water cooled electric water chiller. The capacity and other assumptions about the central plant heating equipment and central cooling equipment are the same as with that in the CAV system test cases.

5.6.5 Supply air volume and supply air temperature results

The calculation results of the supply air volume and supply air temperature are depicted graphically in the Figure 38 to Figure 40 (taking the core room as an example), the negative load ratio value means a cooling load. Discrepancies existed in the results mainly due to the differences in the control strategies.

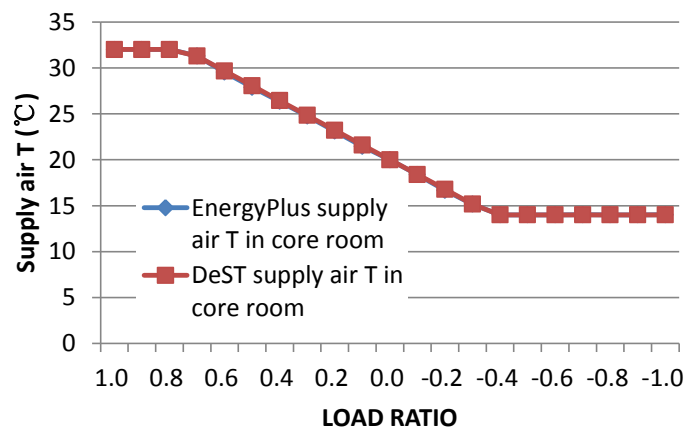

Figure 38 SAT in core room under software defined control

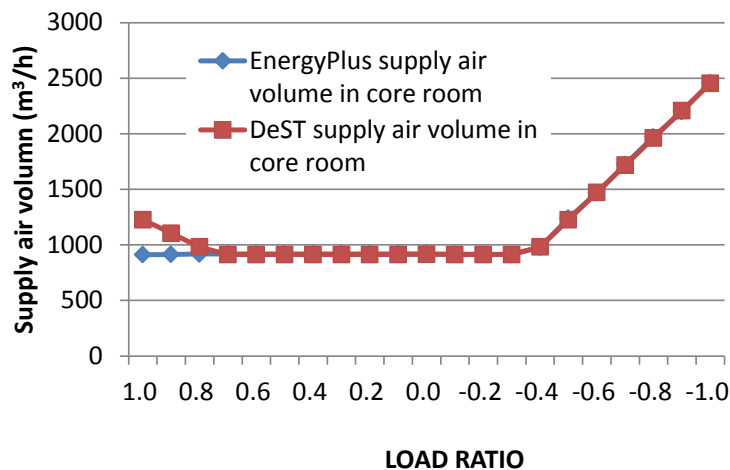

Figure 39 SAV in core room under software defined control

Comparison of HVAC System Simulations in Different Programs

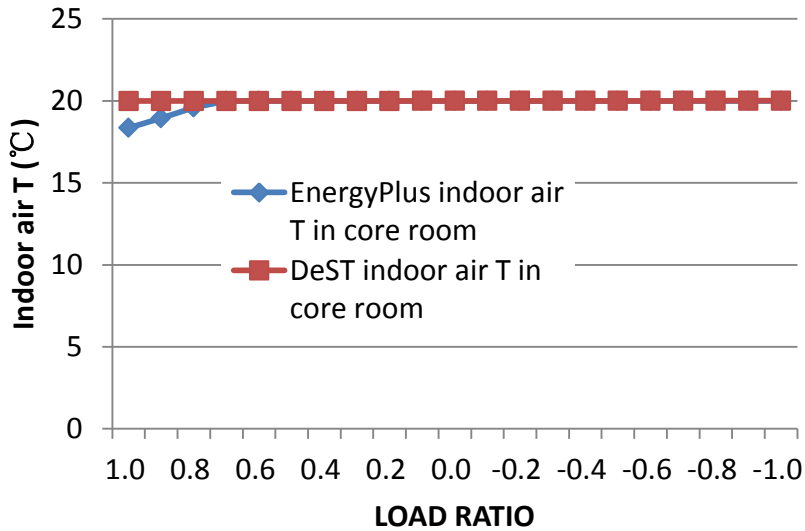

Figure 40 Indoor air T of core room under software defined control

Although the supply air temperatures are all the same in the results, the calculation process is different. In DeST, the supply air temperature and supply air volume are determined by the optimization algorithm, which ensures that under the premise that room set point can be reached, the air supply volume is set to the minimum possible rate. However, in EnergyPlus, when there is a heating load, the supply air volume is set to the minimum value, which can be seen from Figure 39, and the supply air temperature is determined by the load and the flow rate. When the heating load ratio is 1, to maintain the room temperature set point, the supply air temperature would be larger than the maximum value (32°C). So the supply air temperature is set to 32°C as Figure 38 shows, and the room temperature is lower than the set point (20°C), as Figure 40 shows, because it cannot supply the desired load. When a cooling load is required, the air supply temperature is determined first. It is a function of the room load and the flow rate from the previous time step. As Figure 38 and Figure 39 show, when the supply air temperature decreases to the lowest limit, the minimum value would be taken. The supply air volume is then determined from an energy balance calculation.

More discrepancies happen in zone 2 as the following figures (Figure 41 to Figure 43) show, the reason has been discussed above:

Comparison of HVAC System Simulations in Different Programs

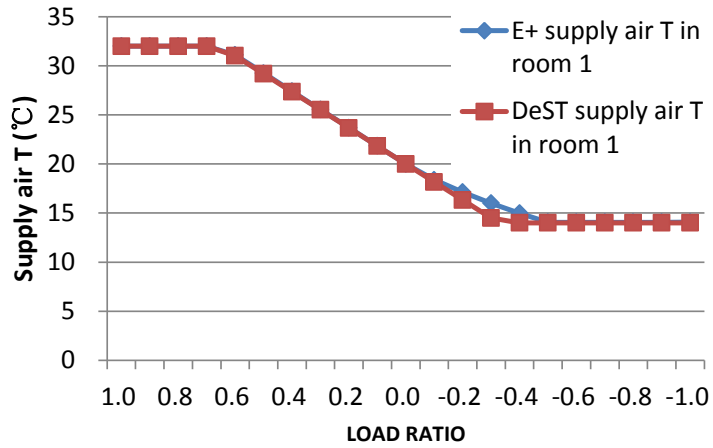

Figure 41 SAT in room 1 under software defined control

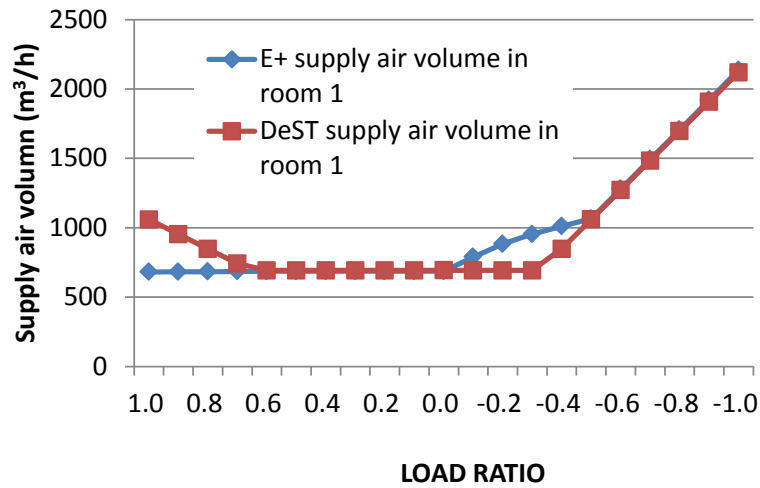

Figure 42 SAV in room 1 under software defined control

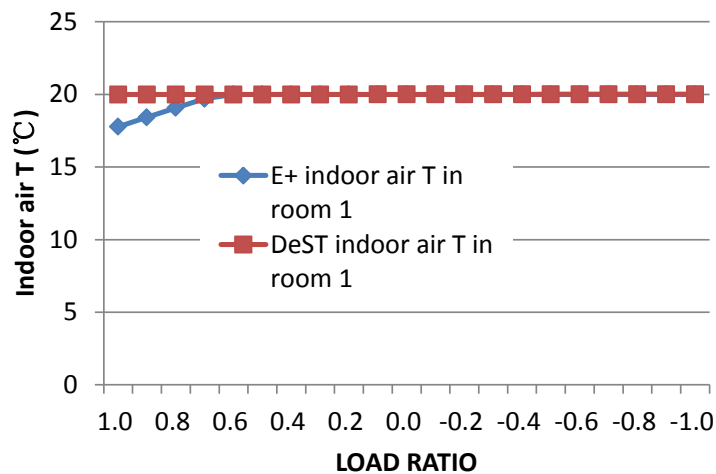

Figure 43 Indoor air T of room 1 under software defined control

The cumulative energy consumed under a VAV control strategy over the variations in PLR in each modeling program is compared in the table below:

Table 28 Energy consumption comparison of VAV system tests

Electricity Consumption kWh	EnergyPlus	DeST	%Difference = (EnergyPlus - DeST)/ Mean*
Chiller	8904	8354	6.4%
Chilled water pump	1700	1696	0.2%
Condenser water pump	1441	1439	0.1%
Hot water pump	216	215	0.6%
Cooling tower fan	1207	1358	-11.8%
Supply Fan	1291	1296	-0.3%
Total	14762	14360	2.8%
Boiler Gas Consumption	41352	45263	-9.0%

During the heating season, limited by the control strategy and the maximum supply air temperature, EnergyPlus cannot supply a large enough heating load and so the boiler gas consumption is lower.

To verify this is due to the control strategy, the supply air temperature and supply air volume in EnergyPlus are set to the same with DeST. This can be achieved by specifying the supply air temperature set point and the minimum supply air volume via the schedule. The results are as follows (Figure 44 to Figure 49):

Core room calculation results:

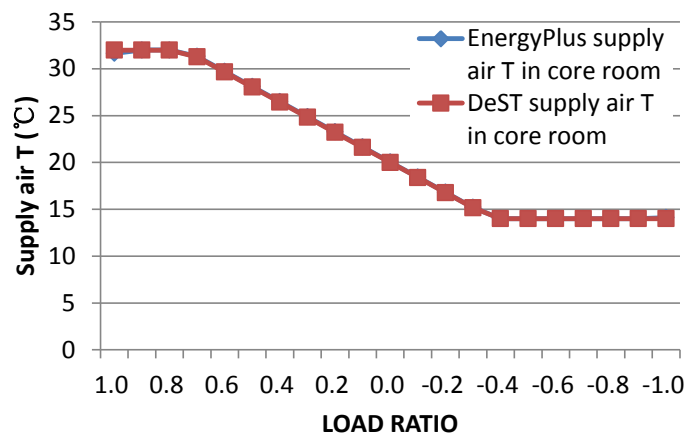

Figure 44 SAT in core room under the same control

Comparison of HVAC System Simulations in Different Programs

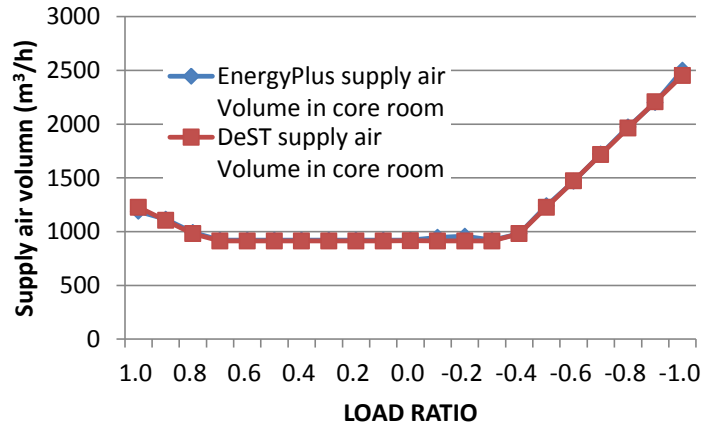

Figure 45 SAV in core room under the same control

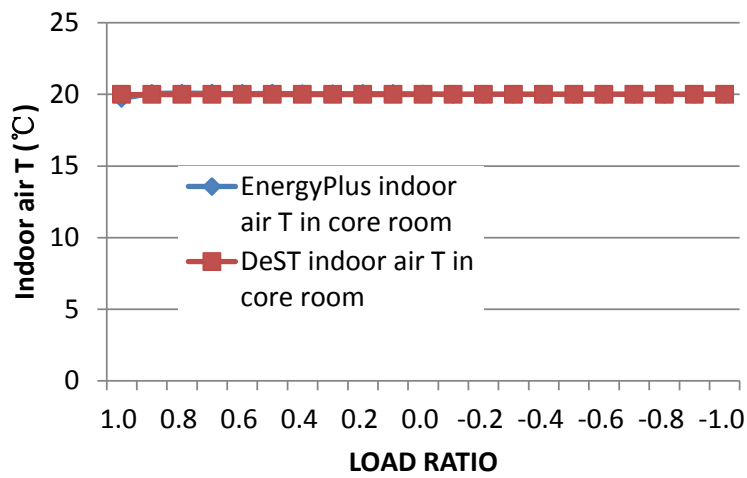

Figure 46 Indoor air T of core room under the same control

Room 1 calculation results:

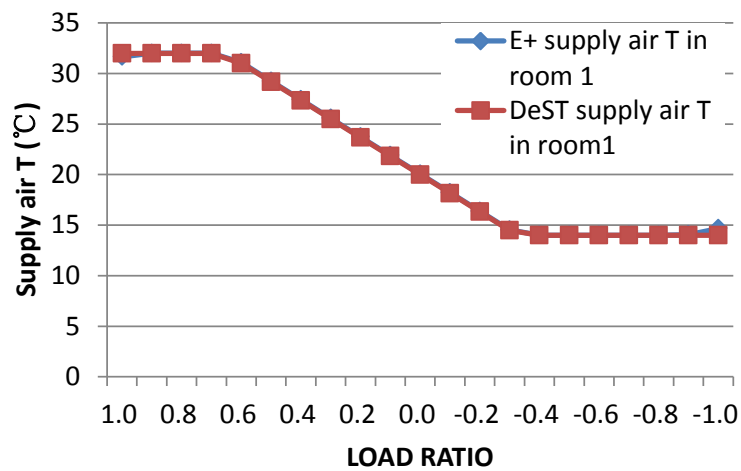

Figure 47 SAT in room 1 under the same control

Comparison of HVAC System Simulations in Different Programs

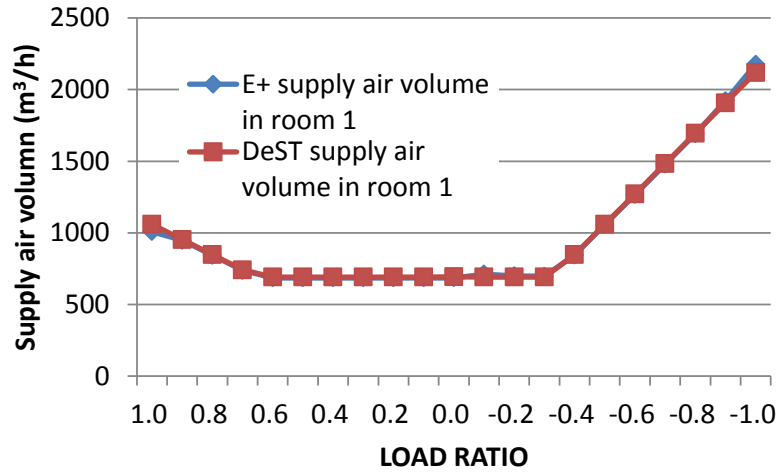

Figure 48 SAV in room 1 under the same control

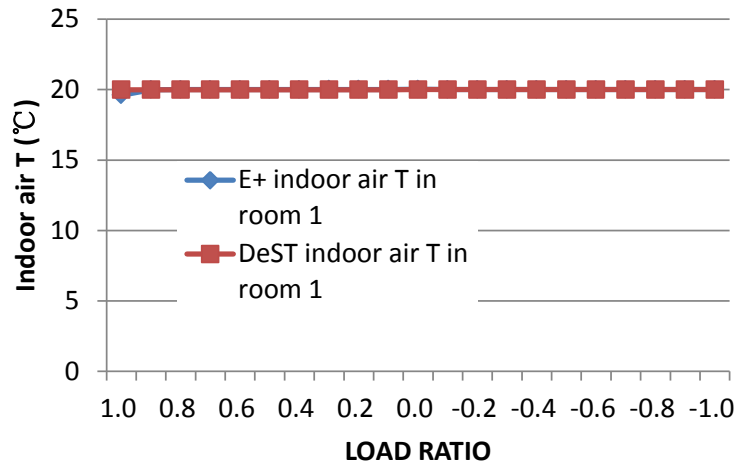

Figure 49 Indoor air T of room 1 under the same control

The supply air temperature and supply air volume are almost the same, proving that if the control strategies are the same, the air system is consistent. What should be stressed here is that if only the energy consumption results are taken into account, the differences between the control strategies cannot be determined (see Table 28 and Table 29). The reason for this is that the sum-up method offsets the discrepancies during the calculations. This supports the concept that the comparison of different simulation programs should not only focus on the final results, but also on the calculation process. More attention should be paid to the calculation flow charts for the programs.

Table 29 Energy consumption comparison of VAV system test under the same control strategy

Electricity Consumption kWh	EnergyPlus	DeST	%Difference = (EnergyPlus - DeST) / Mean*
Chiller	9062	8354	8.1%
Chilled water pump	1700	1696	0.2%

Comparison of HVAC System Simulations in Different Programs

Condenser water pump	1441	1439	0.1%
Hot water pump	216	215	0.6%
Cooling tower fan	1208	1358	-11.7%
Supply Fan	1309	1296	1.0%
Total	14937	14360	3.9%
Boiler Gas Consumption	45149	45263	-0.3%

6 Case study

A case study using an actual office building is conducted in this section to further analyze the differences in load, HVAC system, and energy calculations from the three programs. The methodology used in this part is as following:

first, a DOE-2 model is built based on the as-built design drawings and specifications, and operating schedules of a real building. The simulation results are calibrated based on the one-year monthly utility data.

Secondly, the EnergyPlus and DeST models are built base on the DOE-2 model. It means that the inputs of DOE-2 model are used as much as possible in the building process of the other two models. For those unavailable inputs like surface convection heat transfer coefficient and furniture coefficient, default values from each program are used. In this step, the inputs of EnergyPlus and DeST are qualified controlled, and the calculation results are not calibrated with the real buildings' consumption data.

Finally, the simulation results from the three programs are compared to each other and to the billing data to see the discrepancies in real applications when the users' inputs are consistent and the program defaults are used.

6.1 Building description

6.1.1 General

The office building is located in a sub-tropical, hot-humid climate; it has a total floor area of 7300 m² with a basement of 900 m² and four above-grade floors (1600 m² each). Concrete structure, double pane windows, exterior shading from overhangs and side fins are used in the building. The window-wall-ratio is about 18% and the long axis is along the East-West direction. The front facade faces North, rotated 15 degrees towards the East. The maximum occupancy is about 360.

6.1.2 The plan views

The plan view of the building is shown in Figure 50. The basement is a rectangle with dimensions 11.25 m by 80 m. The four above-grade floors have the same footprint of 20 m by 80 m. All the above-ground floors have a corridor in the center of the floor plan. The basement is not air-conditioned except for the conference room. The common areas on the East and West sides of the building are unconditioned. The height of each floor is 4 m and the plenum height in each floor is 1.3 m.

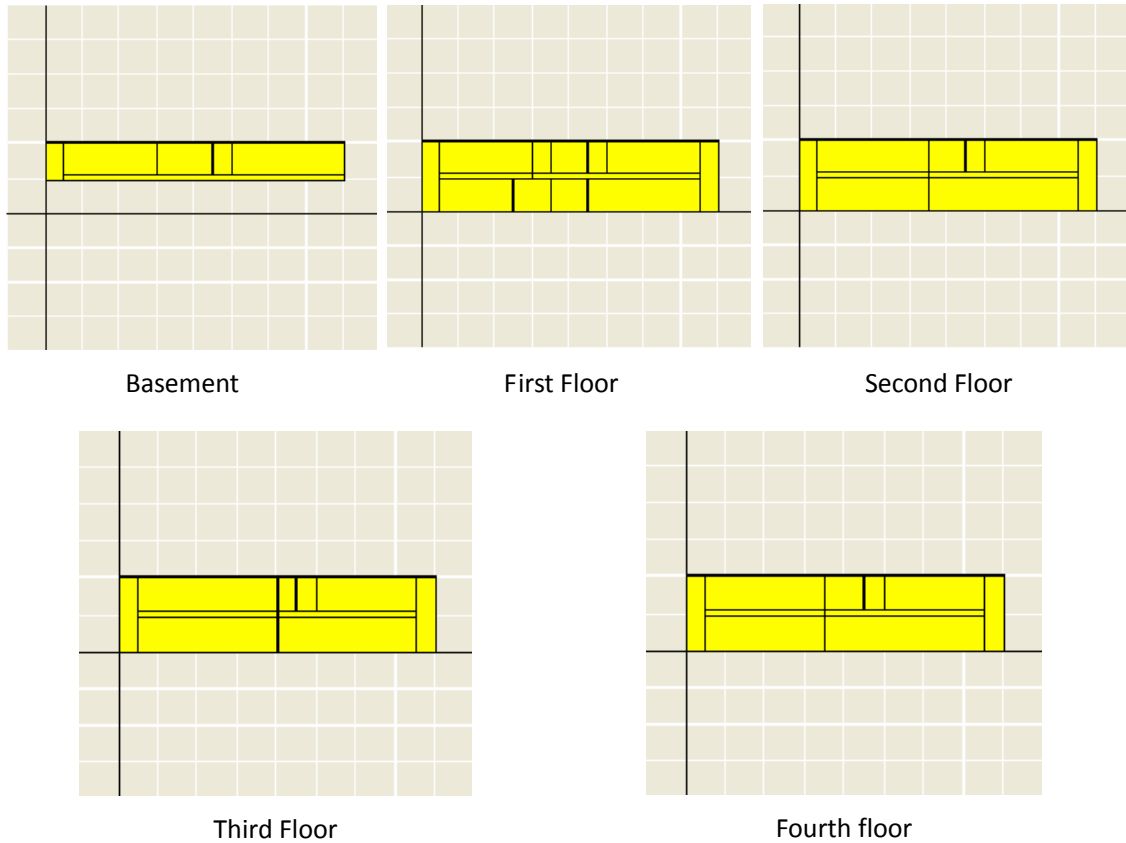

Figure 50 Building plan views

6.1.3 3D View of Building

The building has an entrance shade on both the south and north sides. Little shading from adjacent buildings and trees are ignored. Figure 51 shows the 3D view of the building.

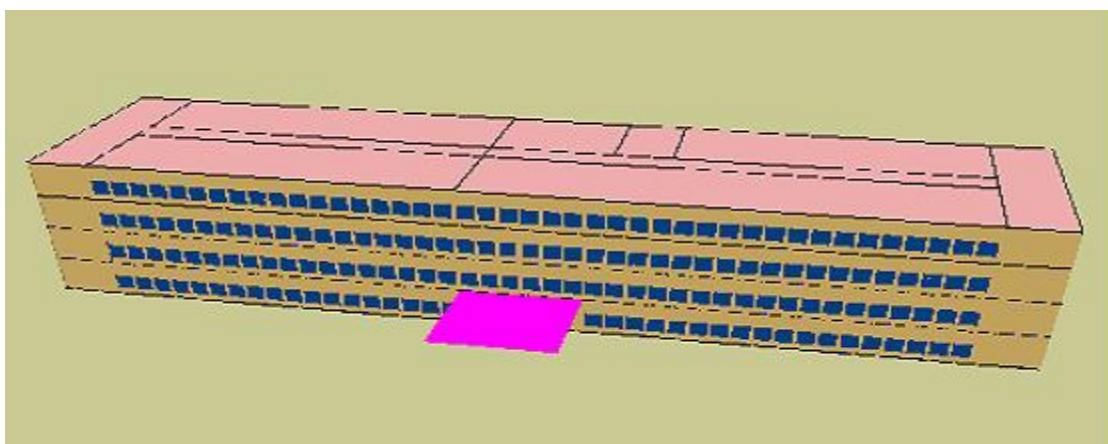

Figure 51 3D view from the north facade

6.1.4 Lighting

Common areas have a lighting power density (LPD) of 6 W/m² while conditioned spaces have a LPD of 18 W/m². The whole building average LPD is about 14 W/m².

6.1.5 Plug equipment

The average plug loads (equipment power density EPD) of the building is 6.8 W/m².

6.1.6 HVAC systems and central plant

The building is served by nine air handling units (AHUs) – four CAV systems, four VAV systems, and one fan coil system. There is no space heating or reheat in the building. The central plant has two water-cooled centrifugal chillers (175 tons each), two cooling towers (200 tons each), two chilled-water pumps, and two condenser-water pumps. The four water pumps are constant speed pumps. The cooling towers have variable speed fans. The rated COP of the constant speed chillers is 4.237.

The conference room in the basement is served by a fan-coil system with a total cooling capacity of 10 tons. Each above-grade floor is served by a constant air volume (CAV) system for spaces on the East side and a variable air volume (VAV) system for spaces on the West side. Each AHU is equipped with cooling coils, filters, and air economizers, and two fans to provide outdoor air. Demand controlled ventilation is applied to adjust the amount of outdoor air according to the CO₂ concentration by occupancy.

6.1.7 Miscellaneous Energy Use

An 11 kW elevator is used in the building. There is also a supply-water pump and 3 waste-water pumps. All of this equipment is modeled as miscellaneous energy use with a peak power of 26 kW and a schedule listed below.

6.1.8 Operation schedules

The operation schedules are assumed to be typical office patterns listed in Table 30.

Table 30 Operation Schedules

	Weekdays	Weekend and Holidays
<p>Occupant- Maximum 95%, minimum 0%</p>		
<p>Lighting- Maximum 90%, minimum 0%</p>		
<p>Plug Loads (equipment)</p>	Same as lighting	Same as lighting
<p>Infiltration- 100% during off hours, 0% when system is on</p>		
<p>Space Cooling Temperature- Set point is 26°C. Reset to 36°C during off-hours.</p>		
<p>Fans- Two hours optimum start is enabled.</p>		
<p>Outdoor Air- Each system uses a different OA schedule to model the demand control ventilation. The fractional value represents the percentage of total supply air volume.</p>	 For AHU1	
<p>Miscellaneous Energy Use</p>		

6.1.9 Weather data

Hourly weather data from 2003 was used. It contained 8760 hourly values of weather parameters including locally measured outdoor air dry-bulb and wet-bulb temperatures, wind speed and velocity from a local airport weather station. No measured solar radiation data was available, so the default solar radiation calculated from the DOE-2.1E program (converted for EnergyPlus and DeST) was used in the case study.

6.2 Simulation results

Table 31 and Figure 52 to Figure 54 show the results from DOE-2.1E, EnergyPlus, and DeST. The annual electricity use from the three programs is within a range of 10%, and the maximum error of monthly electricity use is 15%. The total cooling loads from the HVAC systems in the three programs are very close - the maximum error of annual cooling load is 2%.

Table 31 Monthly Billed and Simulated Electricity Use

	Bills kWh	DOE-2 kWh	EnergyPlus kWh	DeST kWh	Error:DOE-2	Error: EnergyPlus	Error: DeST
JAN	58016	58459	56447	57326	1%	-3%	-1%
FEB	47656	52137	50316	48581	9%	5%	2%
MAR	66304	67203	65960	65301	1%	-1%	-2%
APR	78736	80307	82325	76342	2%	4%	-3%
MAY	91168	82213	84352	80084	-11%	-8%	-14%
JUN	89096	81786	81617	79933	-9%	-9%	-11%
JUL	101528	97982	95348	93527	-4%	-6%	-9%
AUG	97384	89648	87341	87607	-9%	-11%	-11%
SEP	89096	83034	81654	80561	-7%	-9%	-11%
OCT	84952	82627	84065	78708	-3%	-1%	-8%
NOV	80808	76714	77530	72419	-5%	-4%	-12%
DEC	64232	73717	71306	70172	13%	10%	8%
Whole Year	948976	925827	918259	890561	-3%	-3%	-7%

Case study with DOE-2.1E, EnergyPlus, and DeST

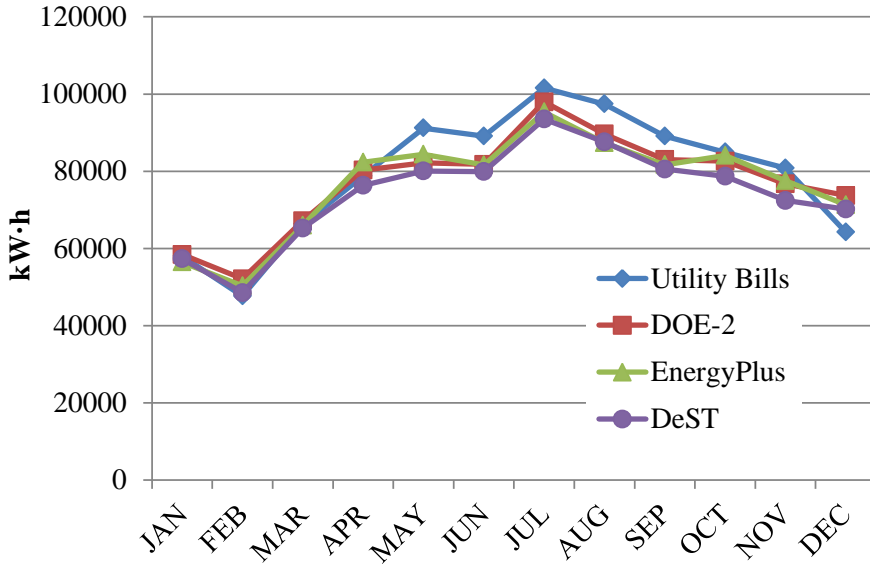

Figure 52 Monthly Billed and Simulated Electricity Use

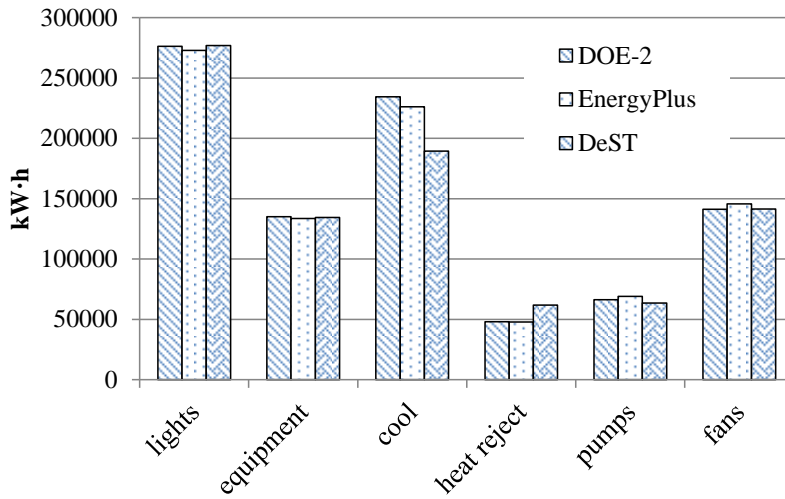

Figure 53 Simulated Electricity End Uses

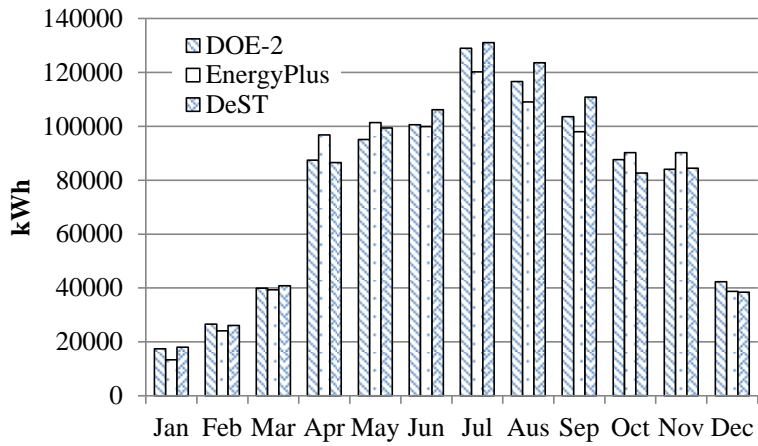

Figure 54 Simulated HVAC Cooling Loads

6.3 Analysis and discussion

The annual cooling load calculation differences among the three programs are within 3%, which is mainly due to different values and models used by the three programs for surface convection heat transfer and solar radiation.

When the system cooling load is passed to the central plant side, the differences among the chiller energy consumptions increase as Figure 55 shows.

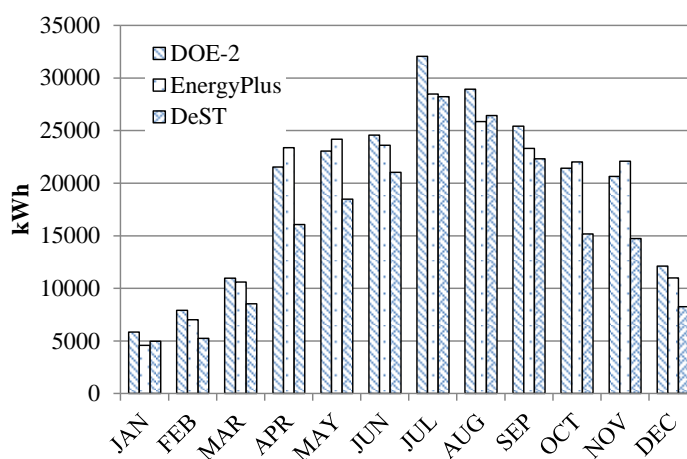

Figure 55 Simulated monthly chiller electricity use

The main reasons for the differences have been discussed in detail in previous sections of this report, and can be concluded as follows:

1. Chiller performance curves

The chiller performance is calculated by three curves in EnergyPlus and DOE-2. The independent variables of the curves are the part load ratio, condenser inlet water temperature and evaporator outlet water temperature. The coefficients of the curves can be changed by users, and in this case, the DOE-2 default chiller performance curves are used in DOE-2 and EnergyPlus models. DeST uses a hard-wired coupling curve to describe the chiller performance using the same independent variables as the other two programs. Because the forms of the curves cannot be exactly the same, and the coefficients of the curve in DeST cannot be changed, some differences in chiller energy use are expected.

2. Chiller operation time

In DOE-2 and EnergyPlus, the chillers operate, by default, whenever there is a cooling demand from the system. While in DeST, chillers will stop operating when the cooling load is lower than 10% (a hard-wired value). So the total operation time of the chillers is different among the three models. The comparison of chiller operation hours and cooling load demand hours are shown in Figure 56.

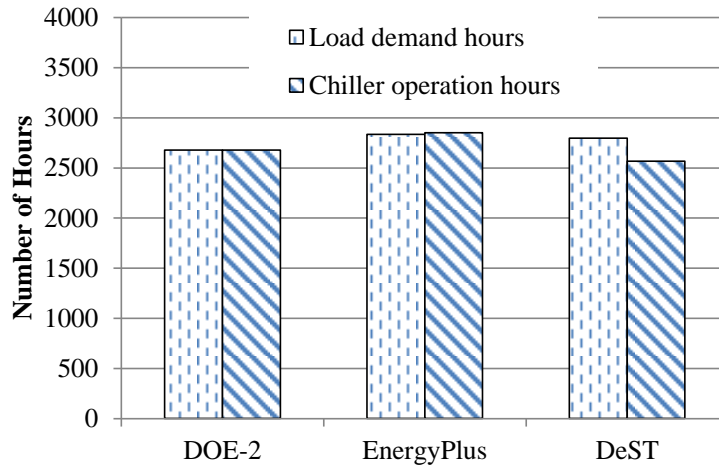

Figure 56 Comparison of cooling load demand hours and chiller operation hours

3. Cooling tower fan control

On the other hand, Figure 53 shows different behavior of the cooling tower energy use calculated by DeST – it is lower than those from DOE-2 and EnergyPlus. The cooling tower energy use here includes electricity use by the cooling tower fans and condenser water pumps.

The condenser water pumps operate at a constant speed, so when all the inputs are the same, the rated pump head and rated pump power are consistent, and the energy consumption will mainly be determined by the operation time. The pump running time is based on the chiller operation, so the condenser water pumps operate for fewer hours in DeST than in DOE-2 or EnergyPlus. This does not help explain the higher cooling tower energy use of DeST. So, the cooling tower fans are the only possible cause for differences in energy use between the three programs.

In EnergyPlus and DOE-2, since the cooling tower fans are variable speed, the fan power is adjusted to meet the loads. While in DeST, the cooling tower fan power is constant whenever there is cooling load. The different fan energy use for the cooling towers is shown in Figure 57.

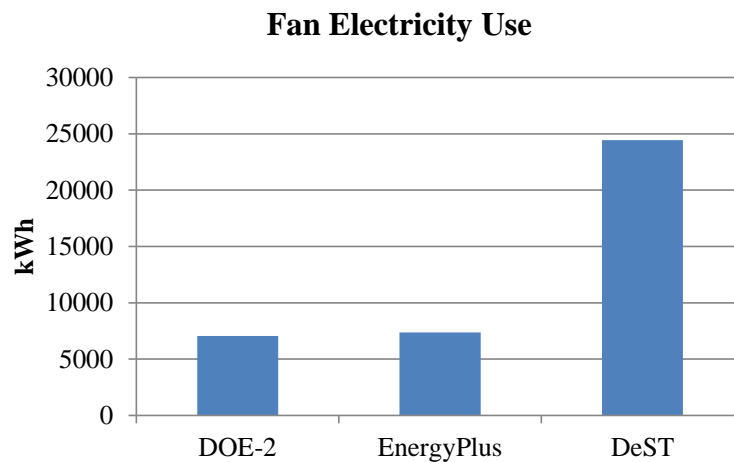

Figure 57 Fan electricity use

Despite these discrepancies, the total annual energy consumption calculated by the three programs agrees within 7%, as shown in Table 31, with monthly and disaggregated component detail in Figure 52 to Figure 54. The differences between the measured and simulated electricity use can be explained by various reasons, such as air infiltration not being zero during summer months, and the use of default DOE-2 chiller performance curves.

This case study demonstrated that the three programs can be used to simulate the energy performance of buildings with typical HVAC systems. Their simulated results can be consistent if their model inputs are kept the same or equivalent as far as possible.

7 Conclusions

EnergyPlus is a powerful simulation program with the most complete component models and the most adjustable parameters among the three simulation programs. Its main limitations exist in the pressure calculation, flow rate distribution, and calculation convergence. The calculation speed of DOE-2 is the fastest, and DOE-2 is the simulation program with a long history and complete functions. However, the lack of integrated solutions between loads and systems makes it difficult for DOE-2 to simulate several new HVAC system types and control strategies. The SCHEME sub-program and the simple and clear HVAC simulation structure make DeST different from the other two programs. However, the simulation concept, the overuse of hard-wired parameters, and limited types of component models causes differences versus the other two programs. Amongst the comparable component models, the detailed analysis shows that the assumptions, simplifications and algorithms for the HVAC components are very similar. But there are large differences between the algorithm for the cooling coil model in DOE-2 and the other two programs, and the chiller model in DeST. Furthermore, the control strategies in the three programs are quite different, which definitely impacts on the energy calculation results.

An integrated test method is introduced and designed to perform more comprehensive HVAC comparisons. The operational performance of the different components under full load conditions demonstrates great consistency across the three programs under the same or equivalent inputs. The part load tests reveal differences among results of different algorithms for chiller models and cooling tower fan models that are used in the three programs. The VAV system comparison focuses on the control strategies. The detailed control logic is analyzed based on the calculation results. Furthermore, the same supply air temperature and air flow rate are input to verify the influence of the control strategies. The comparison of the simulation results proves that an integrated test method is needed to uncover the differences in control strategies and the influences among different components, which cannot be detected if individual components are tested separately or independently.

For the real building case study, all three programs are used to calculate the required loads and end use energy consumption of an actual building. The simulation results are further compared to the monthly utility bill data. The real case uses input information from design documents and specifications where possible. Several unspecified parameters such as the furniture parameters and so on are determined from the default values according to each simulation program. The maximum difference in cooling load is within 15%, but the maximum difference in total building energy consumption is larger due to differences in the HVAC system modeling. The main differences in the energy consumption on the HVAC system side come from the use of different models for chillers and cooling tower fans.

In conclusion, all the three programs fundamentally have the capability for HVAC system simulation and the differences in the simulation results are within a small range. Even though the control logic and modeling methods for some components

Conclusion

are not the same, the differences in whole building energy consumption for a real building using EnergyPlus, DeST, and DOE-2.1E are less than 10% (assuming that all the necessary inputs are kept the same or equivalent, and there are no human errors in the use of each simulation program). Compared with EnergyPlus and DeST, DOE-2.1E is limited in the basic assumptions of HVAC system calculations. The one-way calculation structure of DOE-2.1E makes it unsuitable for many newly developed HVAC components and control strategies that require feedback controls and integrated solutions of loads and systems.

It should be noted that further research is needed to compare more HVAC system types and control strategies, especially how low energy systems, e.g. natural ventilation, radiant systems, displacement ventilation, to understand the differences and limitations of the three BEMPs. This study can be a supplement to the on-going development of HVAC test cases for ASHRAE Standard 140.

Acknowledgment

This work was supported by the U.S.-China Clean Energy Research Center for Building Energy Efficiency. It was co-sponsored by the Energy Foundation under the China Sustainable Energy Program. Dr. Hung-Wen Lin and Dr. Wen-Kuei Chang, as LBNL affiliates from Industrial Technology Research Institute of Taiwan, helped create the EnergyPlus model for the case study of the real building.

This work was supported by the Assistant Secretary for Energy Efficiency and Renewable Energy, Building Technologies Program, of the U.S. Department of Energy under Contract No. DE-AC02-05CH11231.

References

- [1] DeST team of Tsinghua University. Simulation Method for Building Thermal Environment - DeST. China Architecture and Building Press, 2006. (In Chinese)
- [2] DOE-2 Engineers Manual Version 2.1A, LBL-11353, LA-8520-M
- [3] Da Yan and Yi Jiang. An Overview of an Integrated Building Simulation Tool – Designer’s Simulation Toolkit (DeST), Ninth International IBPSA Conference.
- [4] EnergyPlus Engineering Reference, October 2011
- [5] DOE-2 BDL Summary Version 2.1E
- [6] DOE-2 Supplement Version 2.1 C
- [7] ANSI/ASHRAE 2007. Standard 140-2007, Standard Method of Test for the Evaluation of Building Energy Analysis Computer Programs, American Society of Heating, Refrigerating and Air-Conditioning Engineers, Atlanta, GA.
- [8] ASHRAE Research Project 865 - Development Of Accuracy Tests For Mechanical System Simulations
- [9] G. Yuill, J. Haberl. (Development of Accuracy Tests for Mechanical System Simulation, 865 TRP. Atlanta, GA: American Society of Heating, Refrigerating, and Air-Conditioning Engineers. July 29, 2002
- [10] Felsmann, C. Mechanical Equipment and Control Strategies for a Chilled Water and a Hot Water System. Dresden, Germany: Technical University of Dresden, 2008
- [11] R. Judkoff and J. Neymark. Model Validation and Testing: The Methodological Foundation of ASHRAE Standard 140. Presented at the ASHRAE 2006 Annual Meeting, Quebec City, Canada, June 24–29, 2006
- [12] R. Judkoff and J. Neymark. International Energy Agency Building Energy Simulation Test (BESTEST) and Diagnostic Method, February 1995.
- [13] Robert H. Henninger and Michael J. Witte. EnergyPlus Testing with Global Energy Balance Tests, November 2011.
- [14] Robert H. Henninger and Michael J. Witte, EnergyPlus Testing with HVAC Equipment Performance Tests CE100 to CE200 from ANSI/ASHRAE Standard 140-2007, November 2011.
- [15] J. Neymark and R. Judkoff. International Energy Agency Building Energy Simulation Test and Diagnostic Method for Heating, Ventilating, and Air-Conditioning Equipment Models (HVAC BESTEST) Volume 1: Cases E100–E200, January 2002.
- [16] Robert H. Henninger and Michael J. Witte, EnergyPlus Testing with HVAC Equipment Performance Tests CE300 to CE545 from ANSI/ASHRAE Standard 140-2007, November 2011.
- [17] Robert H. Henninger and Michael J. Witte, EnergyPlus Testing with Fuel-Fired Furnace Tests HE100 to HE230 from ANSI/ASHRAE Standard 140-2007,

References

November 2011.

- [18] Julia Purdy and Ian Beausoleil-Morrison, Building Energy Simulation Test and Diagnostic Method for Heating, Ventilation, and Air-Conditioning Equipment Models (HVAC BESTEST): Fuel-Fired Furnace Test Cases, May 2003.
- [19] Robert H. Henninger and Michael J. Witte, EnergyPlus Testing with HVAC Equipment Component Tests, November 2011.
- [20] Robert H. Henninger and Michael J. Witte, EnergyPlus Testing with IEA BESTEST Mechanical Equipment & Control Strategies for a Chilled Water and a Hot Water System, November 2011.
- [21] Clemens Felsmann, Mechanical Equipment & Control Strategies for a Chilled water and a Hot water system, June 2008.
- [22] Robert H. Henninger and Michael J. Witte. Test Report of LBNL DOE-2.1E119 Based on ANSI/ASHRAE Standard 140-2004, September 2006.
- [23] Tianzhen Hong, Architecture Energy Corporation. A Case Study with CVisualDOE 4.0: the Building 64 of ITRI, Taiwan, March 2005.
- [24] Tianzhen Hong, Dale Sartor, Paul Mathew and Mehry Yazdani. Comparisons of HVAC Simulations between EnergyPlus and DOE-2.2 for Data Centers, August 2008.
- [25] Dandan Zhu, Tianzhen Hong, Da Yan, Chuang Wang. Comparison of Building Energy Modeling Programs: Building Loads. LBNL Report 6034E, June 2012.