

# UC Davis

## Research Reports

### Title

The Potential to Build Current Natural Gas Infrastructure to Accommodate the Future Conversion to Near-Zero Transportation Technology

### Permalink

<https://escholarship.org/uc/item/2tp3n5pm>

### Authors

Myers Jaffe, Amy  
Dominguez-Faus, Rosa  
Ogden, Joan  
et al.

### Publication Date

2017-03-01

# The Potential to Build Current Natural Gas Infrastructure to Accommodate the Future Conversion to Near-Zero Transportation Technology

March 2017

A Research Report from the National Center for  
Sustainable Transportation

Amy Myers Jaffe, University of California, Davis

Rosa Dominguez-Faus, University of California, Davis

Joan Ogden, University of California, Davis

Nathan C. Parker, University of California, Davis

Daniel Scheitrum, University of California, Davis

Zane McDonald, University of California, Davis

Yueyue Fan, University of California, Davis

Tom Durbin, University of California, Riverside

George Karavalakis, University of California, Riverside

Justin Wilcock, University of California, Davis

Marshall Miller, University of California, Davis

Christopher Yang, University of California, Davis



**National Center  
for Sustainable  
Transportation**

**UCDAVIS**

**SUSTAINABLE TRANSPORTATION ENERGY PATHWAYS**

*of the Institute of Transportation Studies*

## **About the National Center for Sustainable Transportation**

The National Center for Sustainable Transportation is a consortium of leading universities committed to advancing an environmentally sustainable transportation system through cutting-edge research, direct policy engagement, and education of our future leaders. Consortium members include: University of California, Davis; University of California, Riverside; University of Southern California; California State University, Long Beach; Georgia Institute of Technology; and University of Vermont. More information can be found at: [ncst.ucdavis.edu](http://ncst.ucdavis.edu).

## **U.S. Department of Transportation (USDOT) Disclaimer**

The contents of this report reflect the views of the authors, who are responsible for the facts and the accuracy of the information presented herein. This document is disseminated under the sponsorship of the United States Department of Transportation's University Transportation Centers program, in the interest of information exchange. The U.S. Government assumes no liability for the contents or use thereof.

## **California Air Resources Board Disclaimer**

The statements and conclusions in this Report are those of the contractor and not necessarily those of the California Air Resources Board. The mention of commercial products, their source, or their use in connection with material reported herein is not to be construed as actual or implied endorsement of such products.

## **Acknowledgments**

This study was funded by a grant from the National Center for Sustainable Transportation (NCST), supported by USDOT through the University Transportation Centers program. The authors would like to thank the NCST and USDOT for their support of university-based research in transportation, and especially for the funding provided in support of this project.

The authors would like to thank our colleagues in research of alternative fuels and vehicles and more sustainable transportation at the California Air Resources Board for funding this contract and the staff with whom we engaged in the Research Division. The authors also thank the contributing team members of the STEPS program for their diligent and comprehensive work on this contract and report.



# The Potential to Build Current Natural Gas Infrastructure to Accommodate the Future Conversion to Near-Zero Transportation Technology

---

A National Center for Sustainable Transportation Research Report

March 2017

**Sustainable Transportation Energy Pathways Program, Institute of Transportation Studies,  
University of California, Davis**

Amy Myers Jaffe, Principal Investigator, University of California, Davis

Rosa Dominguez-Faus, University of California, Davis

Joan Ogden, University of California, Davis

Nathan C. Parker, University of California, Davis

Daniel Scheitrum, University of California, Davis

Zane McDonald, University of California, Davis

Yueyue Fan, University of California, Davis

Tom Durbin, University of California, Riverside

George Karavalakis, University of California, Riverside

Marshall Miller, University of California, Davis

Christopher Yang, University of California, Davis



[page left intentionally blank]

# Table of Contents

Abstract .....	viii
Executive Summary.....	x
1 Introduction.....	16
2 Background.....	19
<b>2.1 Natural Gas in Transportation: Literature Review .....</b>	<b>19</b>
<b>2.2 Renewable Natural Gas in Transportation: Literature Review.....</b>	<b>20</b>
2.2.1 RNG Pathways.....	20
2.2.2 RNG Costs.....	21
2.2.3 RNG Yields.....	22
2.2.4 Commercial RNG Examples.....	22
2.2.5 RNG synergies .....	23
<b>2.3 Hydrogen in Transportation: Literature Review.....</b>	<b>24</b>
2.3.1 Hydrogen Production.....	24
2.3.2 Hydrogen Storage and Delivery .....	28
2.3.3 Hydrogen Infrastructure Strategies .....	28
2.3.4 Current Status of Hydrogen Infrastructure development in California .....	29
2.3.5 Studies of Hydrogen and the Natural gas grid .....	32
2.3.6 Synergies Between Hydrogen Fuel Cell and Natural Gas Vehicles .....	33
3 Methods.....	34
<b>3.1 Fossil natural gas infrastructure pathways.....</b>	<b>34</b>
<b>3.2 Renewable natural gas supply pathways .....</b>	<b>36</b>
<b>3.3 Hydrogen Pathways.....</b>	<b>40</b>
4 Results.....	44
<b>4.1 RNG Compatibility with the Natural Gas System.....</b>	<b>44</b>
4.1.1 RNG Treatment and Purification .....	47
4.1.2 Monitoring .....	51
4.1.3 RNG Potential in California: Upgrading and Injection Costs Assessment.....	52
4.1.4 The GHG benefit of blending NG with RNG .....	58
<b>4.2 Hydrogen Compatibility with Natural Gas Infrastructure .....</b>	<b>61</b>
4.2.1 Which transportation markets are most promising for natural gas and hydrogen?.....	61
4.2.2 Hydrogen infrastructure supply pathways .....	62
4.2.3 infrastructure requirements and overlap for Hydrogen and NG Supply Pathways.....	63
4.2.4 Compatibility of CNG refueling station equipment with hydrogen .....	65
4.2.5 Blending hydrogen with natural gas.....	67
4.2.6 Methanation or “E-gas”: Production of Methane from CO <sub>2</sub> and Renewable Hydrogen.....	76
<b>4.3 Scenarios for Growth: Implications for Natural Gas as a Bridge to Hydrogen.....</b>	<b>77</b>
5 Summary and Conclusions .....	81
6 Recommendations.....	83
7 Glossary of Terms.....	85
8 Appendix A: RNG compatibility with natural gas infrastructure.....	87
9 References .....	102

## List of Figures

Figure 1. CNG (left) and LNG (right) stations in California.	17
Figure 2. Natural Gas Fueling Stations in California 2009-2014.	20
Figure 3. Pathways to hydrogen	24
Figure 4. Six fuel supply pathways for hydrogen and hydrogen blends derived from natural gas.	26
Figure 5. Delivered cost of hydrogen transportation fuel from various pathways.	27
Figure 6. Locations (top) and status (bottom) of hydrogen refueling stations in California. In 31 stations, compressed hydrogen is delivered by truck; 7 have liquid hydrogen delivered by truck; 7 onsite electrolysis; 2 onsite steam methane reforming; 1 hydrogen pipeline delivery.	30
Figure 7. CARB projections for hydrogen fuel cell vehicle populations (top) and numbers of stations (bottom) in California (CEC/CARB Joint report 2015).	31
Figure 8. Renewable Hydrogen Requirements in California under SB1505.	32
Figure 9. LNG supply pathways	34
Figure 10. CNG supply pathway	35
Figure 11. CNG Time fill station configuration.	35
Figure 12. RNG Sites compared to trucking corridor	37
Figure 13. Public CNG and LNG locations in California.	38
Figure 14. Centralized and onsite hydrogen infrastructure pathways for providing hydrogen transportation fuel.	40
Figure 15. Near Term and Long Term Pathways for Hydrogen Production and Delivery to Vehicles. (It is also possible to deliver hydrogen via compressed gas truck.)	41
Figure 16a. Hydrogen refueling station with onsite steam methane reforming.	42
Figure 17. Schematic of RNG production from feedstock through to end use.	51
Figure 18. Generalized Natural Gas Processing Schematic from Electrigaz (2011).	53
Figure 19. Upgrading schematic for dairy biogas from Electrigaz (2011).	54
Figure 20. Upgrading schematic from LFG from Electricgaz (2011).	54
Figure 21. Upgrading and injection cost curve fit to the Electrigaz (2011) study.	55
Figure 22. Distance to nearest pipeline from California dairies.	56
Figure 23. Potential RNG sources and natural gas infrastructure.	57
Figure 24. Change in CI values of fossil CNG when increasing the percentage of renewable CNG in the blend.	60
Figure 25. Fuel supply chains for natural gas (top 3 pathways), pure hydrogen (middle 4 pathways) and hydrogen/natural gas blends (bottom 2 pathways).	64
Figure 26. Compatibility of natural gas pathways with hydrogen. Items which are common between a hydrogen pathway and a natural gas pathway are colored green; items which are unique to the H <sub>2</sub> or NG system are colored red indicating that there is no possibility for shared infrastructure or adapted equipment; items in the NG pathway that potentially could be re-used or built to provide forward compatibility with H <sub>2</sub> are colored yellow.	64

Figure 27. Cost comparison for H <sub>2</sub> and CNG refueling station compressed gas storage tanks versus tank size. The H <sub>2</sub> tank is 425 bar pressure and the CNG tank 245 bar.	66
Figure 28. Comparison of refueling station compressor costs versus compressor flow rates for hydrogen compressors (to 425 bar) and natural gas compressors (to 245 bar).	67
Figure 29. Limitations on the blend share of hydrogen by application.	70
Figure 30. Risk to an individual per year by adding hydrogen to the natural gas pipeline: UK data.	73
Figure 31. Effect of blending green hydrogen with natural gas on fuel gas energy and carbon content. The y-axis shows the fraction compared to pure natural gas.	75
Figure 32. Methanation Concept for producing renewable methane from electrolytic hydrogen and CO <sub>2</sub> <sup>91</sup> .	76



## List of Tables

Table 1. Difference between conventional natural gas and RNG	44
Table 2. Biomethane Quality Specifications	46
Table 3. Summary of RNG cost components by pathway in \$/mmBtu	58
Table 4. LCFS approved carbon intensities (gCO <sub>2e</sub> /MJ).	58
Table 5. Carbon intensity reduction (%) achievable by blending levels (%) of each type of RNG	59
Table 6. Transportation Applications for Natural Gas and Hydrogen.	62
Table 7. Scenario for hydrogen and natural gas vehicles and fueling stations in California <sup>a</sup>	78
Table 8. Difference between conventional gas and RNG	87
Table 9. Manure-base biogas composition	91
Table 10. Iron Oxide Products	96
Table 11. Generic Amines	97
Table 12. Proprietary Amines	98
Table 13. Biomethane Quality Specifications	100

## ABSTRACT

The emergence of natural gas as an abundant, inexpensive fuel in the United States has highlighted the possibility that natural gas could play a significant role in the transition to low carbon fuels. Natural gas is often cited as a “bridge” to low carbon fuels in the transportation sector. Major corporations are already investing billions of dollars to build infrastructure to feed natural gas into the U.S. trucking industry and expand the use of natural gas in fleets. In the state of California, natural gas fueling infrastructure is expanding, especially in and around the ports of Los Angeles and Long Beach. The use of natural gas fueled medium and heavy-duty fleets is currently on an upswing.

The emergence of new interest in investment in natural gas fueling infrastructure in California raises the question regarding whether natural gas infrastructure could become stranded by the ultimate shift to lower carbon fuels or whether the natural gas infrastructure system offers synergies that could potentially facilitate speedier adoption of lower carbon fuels. Industry has advocated that overlap of key natural gas infrastructure will lower transition costs and provide consumers with an optimal mix of fuels as the state’s commercial vehicle stock is replaced with alternative vehicles over time.

Development of alternative fuels that have low greenhouse gas emissions and low criteria pollutant emissions, such as renewable natural gas and hydrogen, are considered a major avenue for the state of California to meet climate change and air quality goals.

We examine the precise natural gas infrastructure that is economically and technologically synergistic for both natural gas and renewable natural gas in the near-term, and alternative fuels like renewable natural gas (RNG) and hydrogen in the long term. In particular, we examine optimum paths for developing infrastructure in the near-term that will accommodate alternative fuels once they become available at the commercial scale. The original design of the Low Carbon Fuel Standard (LCFS) provides time for the development of advanced, near-zero technologies. We consider the credits from the LCFS in our analysis.

We find that infrastructure requirements for natural gas and renewable natural gas (RNG) have many synergies. Emerging RNG supplies can utilize much of the same infrastructure as fossil natural gas networks, sharing the same vehicles, station equipment and midstream pipelines for transmission. The time frame for availability and opportunity are also contiguous, allowing for RNG and fossil natural gas networks to be developed simultaneously, each facilitating the other. Fossil natural gas network investors can benefit from receiving carbon credits by blending RNG into their fossil based natural gas fuel while RNG investors can save costs by piggy backing on existing fossil natural gas infrastructure.

There substantial sources of RNG in California that are commercially competitive with existing fossil fuel-based transportation fuels because carbon externalities are taken into consideration in the California market through existing programs such as the Low Carbon Fuel Standard (LCFS) and the U.S. Renewable Fuel Standards (RFS). Those resources will be enabled by the build-out of natural gas infrastructure and adoption of natural gas fueled vehicles for commercial transportation. Liquefied natural gas (LNG) fueling stations for heavy trucks now exist in over a dozen locations around the state of California and continue to expand. But widespread adoption of RNG will require new facilities for the clean-up and

upgrading of biogas from anaerobic digestion and collection of landfill gas. Thus, price support for RNG through LCFS credits, RFS credits and higher tipping fees for municipal solid waste can be influential in propelling replacement of fossil natural gas with lower carbon gas from bio sources. The minimal price support required by each pathway in order to compete with fossil natural gas is \$11.50, \$3.75, \$5.90, and \$26.00 per mmBTU for MSW, Landfill, WWTP, and Dairy, respectively. In per gasoline-gallon-equivalent (gge) terms, the minimal price support required by each pathway is \$1.38, \$0.45, \$0.71, and \$3.15 per gge for MSW, Landfill, WWTP, and Dairy, respectively.

Hydrogen fuel cell passenger cars are now being introduced in California, with tens of thousands of vehicles expected by the early 2020s, served by 100 or more public stations, located primarily in urban areas. However, the best synergies with natural gas vehicles and infrastructure, in terms of both equipment and location, may involve transitioning from compressed natural gas to hydrogen in freight applications.

Initial infrastructure roll outs for medium and heavy duty trucking can register early success through pilot programs for short-haul applications such as last mile deliveries and drayage trucks, where back to base stations “behind the fence” facilities can promote use by fleets. Industry estimates are that it will take roughly 7 to 15 years before new truck platforms can be designed and built, leveraging equipment development for successful bus and truck fleets.

Private stations for hydrogen for medium and heavy duty vehicles with short haul applications would supplement or replace vehicles running on compressed natural gas (CNG) derived from fossil natural gas or renewable natural gas. “Behind the fence” facilities overlap between CNG and hydrogen will build off the same pipeline connections if hydrogen is reformed from fossil or renewable natural gas. Separate storage facilities and refueling equipment will be needed for a transition from natural gas or RNG to hydrogen fuel. Co-location of fueling infrastructure for natural gas, RNG and hydrogen may lower overall costs but the need for costlier equipment to handle hydrogen, which can be more corrosive to pipeline and storage materials than natural gas means higher credits and incentives compared to renewable natural gas would be important to drive a widespread adoption of hydrogen as a fuel for medium and heavy duty commercial vehicles.

While California has already begun the process of adding public hydrogen stations for primarily serving passenger vehicles in urban locations, the timing for the likely build-out for hydrogen stations serving new, hydrogen-ready trucks and buses will likely be a decade or more later than the current expansion of the fossil natural gas and RNG networks, limiting some of the potential for synergies for overlapping infrastructure for commercial fleets. Natural gas fueling infrastructure built today will need to be refurbished or replaced within 15 years, while hydrogen networks are likely to only reach wide scale adoption in that timeframe. However, advanced planning for eventual addition of hydrogen fueling infrastructure at new compressed natural gas and liquefied natural gas fueling locations can facilitate the adoption of hydrogen fuel at a later date and smooth the transition to near zero carbon technologies. Our analysis shows that certain port and urban locations will favor renewable natural gas resources initially but may be able to link to hydrogen supply chains in the longer term.

## EXECUTIVE SUMMARY

California will need high volumes of alternative fuels that have low greenhouse gas emissions to be able to meet its climate change and air quality goals. The development of an industry in advanced, near-zero emission alternative fuels in California comes at a time when the fossil fuels natural gas industry is expanding its supply and infrastructure into the transportation sector.

In the United States, there are 250,000 natural gas vehicles on the road in a variety of applications. About 22,000 natural gas-powered heavy duty trucks were on the road in the United States in 2010, according to the Natural Gas Vehicles for America Association, from which only about 4,000 are long haul trucks. The United States has 1,632 CNG fueling sites of which 922 stations are public. In contrast, there are only 118 LNG stations, two thirds of which or about 80 are public<sup>1</sup>.

Liquefied natural gas (LNG) fueling stations for heavy trucks now exist in over a dozen locations around the state of California and continue to expand. At the end of 2014, California had 330 fueling stations that offered natural gas based fuel. There are approximately 25,000 registered natural gas vehicles in the state.<sup>2</sup> The majority of CNG stations in California offer 3,600 psi pounds per square inch gas compression service with just 15 offering 3000 psi service. An increasing number of stations are offering RNG as a marketed variation of CNG, providing additional options for consumers and businesses.

One potential near-zero fuel is renewable natural gas (RNG). Existing biomass resource assessments suggest that there is a substantial resource base in California that could be tapped to build a renewable natural gas industry in the state. Such resources include manure, food waste, landfill gas, wastewater treatment sludge, forest and agricultural residues, and organic municipal solid waste. Technologies under consideration include capture of landfill gas and anaerobic digestion for all other resources. The process for creating RNG is generally speaking costlier than extracting fossil natural gas. Biogas resulting from anaerobic digestion or produced as landfill gas requires clean-up and upgrading in order to produce a vehicle fuel or to be blended in to the commercial natural gas pipeline network.

California has the potential to produce approximately 94.6 BCF per year (750 million gge per year) of renewable natural gas from dairy, landfill, municipal solid waste, and wastewater treatment plant sources<sup>3</sup>. A study by UC Davis for the Air Resources Board found that RNG can achieve significant market penetration of 14 BCF of RNG into the transportation fueling infrastructure by the 2020s with California's Low Carbon Fuel Standard (LCFS) credits at current levels of \$120 per metric ton of CO<sub>2</sub>. Higher volumes are possible, as LCFS credits become more valuable and technological learning and scale economies lower upfront capital costs. When considering the additional credit from the U.S. Federal Renewable Fuels Standard (RFS) RINs of \$1.78 per gallon of ethanol equivalent (\$23.32 per mmBTU), the volume is higher at 82.8 BCF per year<sup>56</sup>.

Hydrogen could also play an important role in meeting California's goals for reducing state greenhouse gas emissions. Hydrogen is also being demonstrated in fleet vehicles such as transit buses (where there are currently a few dozen in operation with a few hundred planned over the next few years), trucks<sup>4</sup>, and specialty vehicles, notably forklifts, where hydrogen

fuel cells offer operational advantages over batteries<sup>5</sup>. UC Davis researchers find that in order to meet the state’s target to reduce greenhouse gas emissions 80% by 2050, hydrogen fuel might need to represent a third of the light duty transportation fuel mix c. 2050.<sup>6</sup> California has launched a deployment program<sup>i</sup> to accelerate hydrogen fueling infrastructure to support fuel cell vehicles in several pilot locations such as Los Angeles, Oakland and Sacramento. California has targeted building 100 hydrogen refueling stations by 2021 and has allocated up to \$20 million per year for this purpose through AB8.<sup>ii</sup>

The best synergies with natural gas vehicles and infrastructure, in terms of both equipment and location, may involve transitioning from compressed natural gas to hydrogen in freight applications. Initial infrastructure roll outs for medium and heavy duty trucking can register early success through pilot programs for short-haul applications such as last mile deliveries and drayage trucks, where back to base stations “behind the fence” facilities can promote use by fleets. Industry estimates are that it will take roughly 7 to 15 years before new truck platforms can be designed and built, leveraging equipment development for successful bus and truck fleets.

Private stations for hydrogen for medium and heavy duty vehicles with short haul applications would supplement or replace vehicles running on compressed natural gas (CNG) derived from fossil natural gas or renewable natural gas. “Behind the fence” facilities overlap between CNG and hydrogen will build off the same pipeline connections if hydrogen is reformed from fossil or renewable natural gas. Separate storage facilities and refueling equipment will be needed for a transition from natural gas or RNG to hydrogen fuel. Co-location of fueling infrastructure for natural gas, RNG and hydrogen may lower overall costs but the need for costlier equipment to handle hydrogen, which can be more corrosive to pipeline and storage materials than natural gas means higher credits and incentives compared to renewable natural gas would be important to drive a widespread adoption of hydrogen as a fuel for medium and

---

<sup>i</sup> Assembly Bill 8 (AB 8, Perea, Chapter 401, Statutes of 2013) reauthorized Assembly Bill 118 (Núñez, Chapter 750, Statutes of 2007) and created new legal requirements for the California Energy Commission’s Alternative and Renewable Fuel and Vehicle Technology Program (ARFVTP), which creates an annual \$100 million public investment fund to promote development and deployment of advanced technology, low carbon fuels and vehicles that will help the state achieve its greenhouse gas reduction goals. AB 8 directs the Energy Commission to allocate up to \$20 million, or up to 20 percent of each fiscal year’s available funding, for the development of hydrogen refueling stations (HRS) until there are at least 100 publicly available hydrogen-fueling stations in operation in California (Section 43018.9[e]). AB 8 directs the California Air Resources Board (ARB) to report annually on the current and expected number of hydrogen fuel-cell vehicles in California and to evaluate and report to the Energy Commission the need for additional hydrogen refueling stations to meet vehicle demand. The ARB has published two such reports; the most recent is the 2015 Annual Evaluation of Fuel Cell Electric Vehicle Deployment and Hydrogen Fuel Station Network Development. In addition, the bill also directs ARB and the Energy Commission to annually “jointly review and report on progress toward establishing a hydrogen-fueling network that provides the coverage and capacity to fuel vehicles requiring hydrogen fuel that are being placed into operation in the state,” including determining “the remaining cost and timing to establish a network of 100 publicly available hydrogen-fueling stations and whether funding from the Alternative and Renewable Fuel and Vehicle Technology Program remains necessary to achieve this goal.” Source: McKinney, Jim, et al. 2015. Joint Agency Staff Report on Assembly Bill 8: Assessment of Time and Cost Needed to Attain 100 Hydrogen Refueling Stations in California. California Energy Commission. Publication Number: CEC-600-2015-016.

<sup>ii</sup> Source: California Air Resources Board, “Annual Evaluation of Fuel Cell Electric Vehicle Deployment and Hydrogen Fuel Station Network Deployment” July 2015.  
[http://www.arb.ca.gov/msprog/zevprog/ab8/ab8\\_report\\_2015.pdf](http://www.arb.ca.gov/msprog/zevprog/ab8/ab8_report_2015.pdf)

heavy duty commercial vehicles.

Dimethyl ether (DME) is a potential replacement for diesel fuel that can be made from natural gas or other hydrocarbons such as coal or biomass. However, DME is not suitable for direct use in natural gas storage or delivery systems. While DME potentially overlaps with the LPG infrastructure, there is no synergy with fossil natural gas infrastructure, and thus it is not considered broadly in this report.

The alternative gaseous fuel with the largest potential overlap of existing fossil natural gas fueling infrastructure is RNG produced from landfill gas and municipal solid waste. Emerging RNG supplies can utilize much of the same infrastructure as fossil natural gas networks, sharing the same vehicles, station equipment and midstream pipelines for transmission. In addition, the RNG resource development time line is aligned with the current expansion of natural gas in transportation. The time frame for availability and opportunity exist in the current market, allowing for RNG and fossil natural gas networks to be developed simultaneously, each facilitating the other. Fossil natural gas network investors can benefit from receiving ongoing carbon credits by blending RNG into their fossil based natural gas fuel while RNG investors can save costs by piggy backing on existing fossil natural gas infrastructure. High clean-up costs to reach the standard of compliance for access to the California existing natural gas pipeline system can be an economic obstacle to RNG commercial development. RNG has many impurities that need to be addressed before it can be blended into existing fossil natural gas infrastructure. Thus, clean-up costs are a barrier, as is the misalignment between location of supply and location of demand. Recently, the CPUC has instituted a biomethane monetary incentive program<sup>7</sup> which will provide \$40 million in funding to offset 50% of interconnection costs, up to \$1.5 million for each biomethane project built in California over the next five years. This program will enable in state RNG production.

For RNG from dairies and municipal solid waste, separate, greenfield aerobic digester (AD) facilities and dedicated clean up equipment must be constructed to generate the biogas. These facilities are not co-located with the fossil natural gas system and specifically with the large scale natural gas processing systems for fossil gas clean up and therefore cannot take advantage of the fossil gas infrastructure. Because biogas facilities for upgrading generally speaking would be dispersed at multiple sites where the resource is based, small biogas sources are unable to take advantage of the economies of scale in the clean-up technologies that reduce the cost of fossil gas clean up. Clustering of biogas clean up facilities can improve the commercial economics of RNG development.

Biogas differs from fossil natural gas by not having to remove oil or condensates from the gas but having higher concentrations of water and CO<sub>2</sub> to remove, making different technologies more appropriate for biogas clean-up. In addition, biogas from waste water and landfill gas also has other contaminants such as siloxane and vinyl chloride not present in fossil natural gas but must be removed before biogas can enter a carbon dioxide removal process.

The timing for the likely build-out for hydrogen stations serving new, hydrogen-ready trucks and buses will likely be a decade or more later than the current expansion of the fossil natural gas and RNG networks, limiting some of the potential for synergies for overlapping infrastructure for commercial fleets. Natural gas fueling infrastructure built today will need to

be refurbished or replaced within 15 years, while hydrogen networks are likely to only reach wide scale adoption in that timeframe. However, advanced planning for eventual addition of hydrogen fueling infrastructure at new compressed natural gas and liquefied natural gas fueling locations can facilitate the adoption of hydrogen fuel at a later date and smooth the transition to near zero carbon technologies. Our analysis shows that certain port and urban locations will favor renewable natural gas resources initially but may be able to link to hydrogen supply chains in the longer term.

Still, costs to accommodate natural gas pipeline and storage for hydrogen are expensive and could require incentives. Adding hydrogen to the existing natural gas pipeline system would require extensive testing and investigation to ensure verification that pipes and polymer liners are made of sufficiently strong materials consistent with hydrogen transport. Operators would also have to verify that pipelines were free from cracks and weaknesses that might be worsened by hydrogen's more corrosive properties. Hydrogen pipelines require different materials, and hydrogen compression and storage systems generally operate at higher pressures than CNG<sup>8</sup>. Most hydrogen is dispensed to fuel cell vehicles at 700 bar, as compared 200-300 bar for CNG. In addition, the hydrogen fueling infrastructure requires additional equipment not needed for natural gas fuels including different types of compressors, liquefiers, hydrogen delivery trucks and hydrogen production systems such as natural gas reformers and electrolyzers.

In theory, there is potential for infrastructure overlap for hydrogen fleet vehicles and CNG fleet vehicles. We consider scenarios where these fleets could operate in similar applications and geographies including ports or package delivery in cities. Hydrogen and CNG fleets typically utilize dedicated private refuelling sites. Storage and compression equipment for the two fuels is somewhat analogous and therefore we can consider the costs related to conversion from CNG to hydrogen. We consider specifically how much savings could be gained by building CNG gas storage tanks hydrogen-compatible from the outset and therefore to be able to shift to hydrogen as more adoption of hydrogen fuel becomes apparent over time. We consider storage tanks because it is the CNG station component most easily made forward compatible.

A typical CNG fleet station dispensing 1500-2000 gge/day might have a tank with a capacity of 55,000 scf or 437 gge on an energy basis<sup>9</sup>. Cost estimation for a CNG tank is about \$100,000 or about \$230/gge. If the tank were "overbuilt" for hydrogen service, we calculate that the tank cost would increase to \$1200/kg or \$1200/gge<sup>10</sup>. In other words, overbuilding a 437 gge capacity tank would add  $\$524,000 - 100,000 = \$424,000$  to the capital cost of the CNG station.

We then consider how this extra cost could be recovered. If a station owner switches to hydrogen in year "n", the present value of the hydrogen-compatible tank is  $\$524,000/(1+i)^n$  where i is the discount rate. Assuming i=6% (10%), and solving for n, we find that overbuilding the CNG tank would have an economic incentive only if the station is switched to hydrogen within the first 4 years of operation. Because this is a relatively short period of time, it is possible that CNG station owners would need strong government incentives storage to overbuild for hydrogen compatibility. It is possible therefore that many hydrogen stations and CNG stations might be developed parallel to each other instead of leveraging overbuilding for transition from one to the other.

We also analyzed possible scenarios for large scale use of natural gas for trucking and hydrogen for light duty vehicles out to 2035. Within 5-10 years, the number of hydrogen stations required for emerging FCV passenger car markets will far exceed the number of stations needed along interstates for long-haul trucks. By 2020/2025/2035 there will be 5x/10x/40x as many hydrogen stations as LNG truck stations. Moreover, there will be little geographic overlap of these two networks. Further, there is very little commonality between the equipment in LNG stations (which will come to dominate truck supply and do not have compressors or compressed gas storage tanks) and hydrogen stations. This analysis leads us to the conclusion that long haul NG truck stations will not offer substantial leverage to help start a hydrogen fueling infrastructure.

*Recommendations: Policies related to renewable natural gas blending with fossil natural gas*

- Create an inter-agency RNG regulatory task force that can oversee conflicting rules and complex permitting for RNG facilities as a result of water use, VOC emissions, waste-stream usage and pipeline injection standards; Empower task force to recommend policies based on scientific input to update regulations to be consistent with other U.S. states and European best practices; Task force should also study and recommend approaches to streamline the regulatory process to create a single entity with sufficient expertise for comprehensive RNG oversight and permitting.
- Inter-agency task force should reevaluate CUPC and utilities tariff structure for injection of RNG into existing fossil natural gas pipeline system in California and recommend any needed adjustments.
- Task force should be commissioned to draft standardized control processes and specifications for RNG as a vehicle fuel. Such standards and safety codes would also simplify the adoption of RNG as a vehicle fuel and lower the final cost of the fuel while improving consistency and efficiency, with technical input from academic experts, utilities, CPUC, pipeline owners, RNG producers, engine OEMs, and other stakeholders. Standardization should include equipment for gas and electrical distribution interconnections.
- Evaluate modifications in the minimum heating value requirement to allow for injection of biomethane, taking into account for downstream blending to occur naturally in the pipeline and considering an energy content of 960 to 980 BTU/scf as standardization rather than 990 BTU/scf.
- Amend California's policies regarding 12 constituents of concern to measure contaminants not at the point of injection but before biomethane is mixed with fossil natural gas.
- Evaluate whether subcontractors should be allowed to construct RNG pipelines under supervision by CPUC
- Support R & D on thermochemical gasification technologies with the purpose of developing lower cost, higher efficiency systems that can serve as reliable technologies to convert forest and agricultural residues (and other feedstocks) to biogas.
- Commission a study that identifies regions suitable for resource and recovery parks to cluster processing and distribution of RNG from Dairy sources. The study should ensure that appropriate infrastructure either exists or can be economically built to distribute the feedstocks to the centralized facilities.



- Given the high environmental potential of dairy RNG and the importance of the dairy industry to California’s economy, select of one or more promising locations for a resource and recovery park to cluster processing and distribution of RNG from Dairy sources and fund the preliminary work necessary for installation of the facilities. This work could include defining the project scope, submitting all appropriate environmental reports, obtaining approvals from all relevant agencies, building infrastructure, and necessary site preparation.
- Conduct a full life-cycle analysis comparing biogas environmental performance in transportation in comparison to other end uses (e.g. recycling, composting, electricity generation, biodiesel etc.) across waste streams to enable policies and incentives to be created to guide the feedstocks to the “highest and best” usage.

*Policies related to hydrogen-blending with natural gas and power to gas (e-gas)*

- Conduct a rigorous, scientifically-based assessment to establish acceptable limits for hydrogen blend concentrations in California’s natural gas system. Develop protocols for introducing hydrogen into the natural gas grid. This assessment will be based on site-specific analyses of hydrogen compatibility, including natural gas end-use, transmission, storage and distribution equipment in California’s natural gas system. Draw upon technical expertise from ongoing hydrogen codes and standards activities under the Federal and California agencies and National Laboratories, as well as public/private groups such as H2USA and the California Fuel Cell Partnership, and industry (gas utilities, industrial gas companies, and groups such as FCHEA and the California Hydrogen Business Council) and learnings from international power to gas programs. As part of the assessment, examine the costs and benefits of hydrogen blending. Timely to do this.
- Establish a process to certify different parts of the natural gas system including end-use devices such as end-use appliances, storage, compressors, transmission and distribution pipelines for use with hydrogen blends.
- Establish a strict regulatory and permitting process for hydrogen blending with natural gas should be established that includes independent verification of extensive testing that pipes and polymer liners are made of sufficiently strong materials consistent with hydrogen transport and are free from cracks and weaknesses that might be worsened by hydrogen’s more corrosive properties. Permitting of hydrogen blending with natural gas should demonstrate a clear need and environmental benefit and be restricted to levels consistent with the results of the blending assessment.
- Conduct a California-specific assessment of the costs, benefits and emissions reductions of a methanation or e-gas strategy, and its role in a future energy system with increasing use of intermittent renewables. Examine the costs and benefits of producing renewable methane via methanation of CO<sub>2</sub> by electrolytic hydrogen produced from curtailed renewables like wind and solar, and “storing” this excess renewable power as methane injected into natural gas pipelines.
- Compare the likely costs, benefits and emissions reductions for e-gas and hydrogen/natural blending strategies, as compared to battery storage and other energy storage technologies for large fractions of intermittent renewable energy in California. Assess implications for greenhouse gas emissions from the transportation sector.

# 1 INTRODUCTION

For the past two decades, researchers have investigated the optimum way to transition to cleaner, more secure, alternative fuels in the U.S. transportation sector. Hundreds of scholarly articles have been published on pathways for hydrogen<sup>11,12,13</sup>, biofuels<sup>14,15,16</sup>, methanol,<sup>17</sup> and electricity,<sup>18</sup> among other alternatives. Less attention was paid to the prospects that natural gas could become a major transport fuel, given its importance as an economically efficient feedstock for power generation and industry. In the late 1980s and through 1990s, U.S. natural gas markets were expected to have a precarious supply outlook that would leave the U.S. highly dependent on increasingly insecure, foreign sources of natural gas. Although natural gas was in wide supply in North America in the 1980s, Flynn found that “fundamental shifts in the relative values of oil and natural gas” towards the end of that decade caused major players to exit the market for compressed natural gas vehicles and fueling stations. In a survey regarding the fate of CNG vehicles in Canada in the 1980s, Flynn concludes that a chicken and egg problem emerged for fueling stations and vehicles. Lack of fueling infrastructure discouraged purchases of vehicle conversion equipment, and low vehicle conversions, in turn, dented the profitability of stations that did get built.<sup>19</sup> Reputational issues also played a role.

However, the unexpected breakthrough in the technologies to exploit unconventional oil and gas in the United States has revolutionized the outlook for the U.S. national energy mix, with significant consequences. The emergence of natural gas as a newly abundant, inexpensive fuel in the United States has once again raised the possibility of a larger shift in the level of natural gas utilized in the transportation sector.

California will need high volumes of alternative fuels that have low greenhouse gas emissions to be able to meet its climate change and air quality goals. Natural gas is often touted as a “bridge” to low carbon fuels in the transportation sector. Development of alternative fuels that have low greenhouse gas emissions and low criteria pollutant emissions, such as renewable natural gas and hydrogen, are considered to be pivotal for the state of California to meet climate change and air quality goals. However, these alternative fuels can require high initial investment costs for new state-wide fueling infrastructure relative to the fully discounted, incumbent oil-based network. The deeply entrenched incumbency of oil-based fuels and their well-established infrastructure distribution provide a formidable competitive commercial influence slowing the transition to alternative fuels. Approaches to alternative fuels development that can tap existing transportation fuel infrastructure would have beneficial effects by lowering the commercial costs associated with a transition to low carbon fuels.

The ability to use existing energy infrastructure would speed transition to alternative fuels. One such synergy that is possible in California is to tap the expanding natural gas infrastructure. While many of these stations are open for public access, a number of them only provide limited access or exclusive access to a private vehicle fleet(s). LNG infrastructure in particular has limited public access, with only one-third of the LNG stations in California open to the public.

The traditional fossil fuels natural gas industry is expanding its supply and infrastructure into the transportation sector. With 46 LNG stations, California represents about 70% of US LNG truck refueling facilities and about 200,000 gallons/day of LNG were trucked into California in the mid-2000s. About 23 of the LNG stations are L/CNG stations providing both liquefied and compressed natural gas, according to the U.S. Department of Energy.<sup>20</sup> Volumes have been

growing steadily in recent years, and LNG fueling facilities now exist in Tulare, Fontana, Lodi, Lost Hills, San Diego, Aurora and Ripon, with planned new facilities in Coachella and Colton. California is the leading state in LNG trucking, according to the US Department of Energy, with station locations focusing initially on US interstate routes from Los Angeles to Houston and Las Vegas as well as to Chicago and Atlanta. California has 330 CNG stations<sup>iii</sup>, or about 20% of the total US CNG stations, which concentrate around populated areas in Southern California, Bay Area-Sacramento and San Joaquin Valley (Figure 1)<sup>21</sup>.

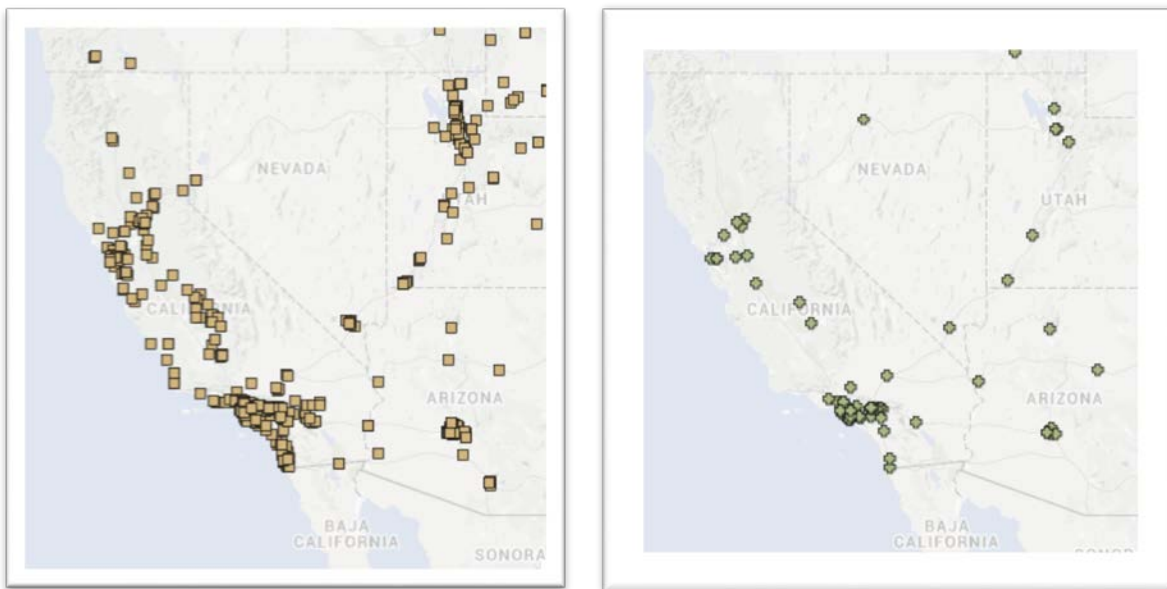

Figure 1. CNG (left) and LNG (right) stations in California<sup>21</sup>.

In this study we investigate which elements of this natural gas infrastructure can be used for two alternative fuels, RNG and Hydrogen, and how much cost-savings might be achieved through planning and policy intervention to promote common use. We consider a number of factors including time line for adoption of each alternative fuel and the working life of fueling equipment and transport infrastructure. We pay special attention to technical standards for equipment and transport infrastructure that are needed to maintain temperature and pressure for each different fuel as compared to natural gas as well as materials needed to avoid corrosion, accidents, and leakage along the supply and transportation chain, and we consider the environmental consequences of fuel blending with natural gas on a life cycle basis and any special environmental considerations of multi-use facilities. We also provide data on whether there are geographic considerations that would prevent the use of common transport infrastructure and fueling equipment. Finally, we offer analysis of costs and other commercial factors that might prevent or create barriers to the common use of infrastructure and equipment between natural gas and alternative fuels.

<sup>iii</sup> The availability of natural gas fueling infrastructure has shown relatively steady growth in California. In 2009, there were 191 CNG stations and 25 LNG stations. By 2014, the number of CNG and LNG stations had increased to 284 and 46 stations, respectively, which is shown in Figure 1. For perspective, California has nearly 10,000 retail gasoline stations, a number that has been declining in recent years.

Dimethyl ether (DME) is a potential replacement for diesel fuel that can be made from natural gas or other hydrocarbons such as coal or biomass. However, DME is not suitable for direct use in natural gas storage or delivery systems. While DME potentially overlaps with the LPG infrastructure, there is no synergy with fossil natural gas infrastructure, and thus it is not considered further in this report.

For DME, typically, methanol is produced first from a hydrocarbon source and DME is then synthesized from methanol. DME offers air quality benefits including significantly reduced particulate emissions<sup>iv</sup> and has been used as a cleaner-burning truck fuel in China, Sweden, South America and elsewhere<sup>v</sup>. (DME combustion produces very low NO<sub>x</sub> and CO emissions and no sulfur or soot emissions.) DME was recently approved as a transport fuel in California and is allowed as a biofuel under the US Renewable Fuel Standard<sup>vi</sup>.

Volvo is testing DME in Diesel trucks California in collaboration with Oberon Fuels, which manufactures a small-scale DME production system<sup>22</sup>. DME is stored, handled, and transferred as a liquefied gas under 5 atmospheres pressure and utilizes a storage and distribution infrastructure similar to liquefied petroleum gas (LPG) or propane. With straightforward retrofits especially of seals and gaskets, basic components of LPG storage and handling technology can be used for the storage and handling of DME<sup>vii</sup>, and DME can be blended with LPG or propane. DME is not suitable for direct use in natural gas storage or delivery systems and therefore has no synergies with the fossil natural gas fueling system in California.

---

<sup>iv</sup> Preliminary assessments from the California Air Resources Board report that well-to-wheels emissions of the criteria air pollutants NO<sub>x</sub>, CO and PM<sub>10</sub> from DME derived from natural gas are comparable and somewhat lower when compared on an energy basis to CA ultralow sulfur diesel.

[http://www.arb.ca.gov/fuels/multimedia/meetings/DMETierIReport\\_Feb2015.pdf](http://www.arb.ca.gov/fuels/multimedia/meetings/DMETierIReport_Feb2015.pdf) (accessed July 11, 2016).

<sup>v</sup> DME production is a mature technology that is utilized in a number of countries including Canada, Japan, China, Korea, and India. It has a variety of applications: 1) Use as a liquefied petroleum gas (LPG) substitute for cooking and heating. DME combustion produces very low NO<sub>x</sub> and CO emissions and no sulfur or soot emissions. 2) Use as a chlorofluorocarbon (CFC) substitute for propellants in cosmetic- or paint aerosol cans. 3) Use as a diesel substitute. DME has a high cetane number (55) and can be combusted in diesel-powered vehicles that have been retrofitted to run on DME or in purpose built engines. 4) Use as a precursor to dimethyl sulfate and acetic acid production 5) Use as a refrigerant. 6) Use as a rocket propellant. 7) Use as carrier for livestock insect sprays and foggers. 8) use as a solvent for extraction of organic compounds. America's Commercial Transportation Research Co., LLC, "Future of Natural Gas Engines in Heavy Duty Trucks: The Diesel of Tomorrow?", August 10, 2012. [www.actresearch.net](http://www.actresearch.net)

[http://www.arb.ca.gov/fuels/multimedia/meetings/DMETierIReport\\_Feb2015.pdf](http://www.arb.ca.gov/fuels/multimedia/meetings/DMETierIReport_Feb2015.pdf) (accessed July 11, 2016).

<sup>vi</sup> In August 2015 the USEPA approved biogas-based DME for inclusion under the Renewable Fuel Standard and made it eligible for Renewable Identification Numbers (RINs) credits based on EPA findings that the fuel achieves a 68% reduction in greenhouse gases. Source: Green Car Congress, California approves sale of DME as compression-ignition engine fuel, 27 February 2015, <http://www.greencarcongress.com/2015/02/20150227-dme.html>. Despite its emissions benefits, DME has been slow to capture commercial interest as a transport fuel in the US because it is costlier than Diesel, making truck owners less likely to switch. Moreover, methanol has a large U.S. market as a chemical feedstock, a transportation fuel, and other applications. Since methanol is an intermediate product in the methane-to-DME refining processes, the price spread between diesel and methanol must be significant enough to incentivize the refiner to make DME as a diesel competitor, instead of simply selling methanol.

<sup>vii</sup> While handling of DME is similar to propane, pumps, valves, and seals on DME tanks and DME infrastructure must be made of specific materials since there is a risk of seal and gasket failures with some materials. [http://www.arb.ca.gov/fuels/multimedia/meetings/DMETierIReport\\_Feb2015.pdf](http://www.arb.ca.gov/fuels/multimedia/meetings/DMETierIReport_Feb2015.pdf).

## 2 BACKGROUND

### 2.1 NATURAL GAS IN TRANSPORTATION: LITERATURE REVIEW

Assessments of natural gas in transportation have focused on light duty, transit and refuse vehicles applications, with a few considering long haul trucking applications. A study by Rood-Worpy identified key barriers to widespread adoption of natural gas as a transportation fuel in the United States, including high costs, limited refueling infrastructure, and uncertain environmental performance.<sup>23</sup> A different study by Krupnick found that transitioning to a “hub and spoke” system from a long-haul route structure might facilitate the development of natural gas refueling infrastructure<sup>24</sup>.

Kuby and Kelley studied consumer behavior for early adopters of light duty natural gas vehicles. They found that certain early CNG adopters may be willing to refuel more frequently and farther from home than gasoline drivers. This is especially true for work-based trips and less so for home-anchored trips<sup>25</sup>. Moreover, CNG users preferred to make refueling stops along frequently traveled routes rather than closer to their homes<sup>26,27</sup>. This suggests that CNG may be better matched to commercial applications than for passenger vehicles. This view is consistent with economic analyses by Boston Consulting Group and by Christopher Knittel showing that CNG vehicles could offer long term cost advantages.<sup>28</sup>

Dimitropoulos et al. found that light duty vehicle owners’ refueling behavior was influenced by a variety of attributes related to driving range and refueling (including station availability and refuel time). Improvements in driving range were seen as a possible enabler for adoption of alternative fuel vehicles.<sup>29</sup>

Addressing CNG from the perspective of fuel suppliers, the Boston Consulting Group finds that conventional gasoline/diesel stations will add CNG refueling, only if there is a guaranteed demand from a fleet partner. Further, a “package deal” offering both vehicle and refueling station technology is necessary to spur CNG adoption<sup>30</sup>. A German study (Rostenstiel et al.) found that monopoly ownership of highway service stations inhibited market development for NGVs<sup>31</sup>.

Market adoption studies by MIT researchers Struben and Sterman found that market diffusion can be accelerated by “word of mouth”. The researchers concluded that to establish a critical threshold for sustained adoption of alternative fueled vehicles, policies and subsidies are required<sup>32</sup>.

California has a growing commercial natural gas fueling infrastructure; although station numbers fall far short of those for diesel and gasoline which total 10,000 statewide. A recent study by the California Energy Commission finds that CNG and LNG station costs are also much higher than for diesel and gasoline given the requirement for expensive on-site storage and compression (in the case of CNG)<sup>33</sup>. CNG fueling infrastructure can also cost anywhere from \$45,000 to \$1.8 million depending on the necessary level of service, while LNG stations range in cost from \$1 million to \$4 million. Amortizing capital expenditure can dominate costs for underutilized resources, so infrastructure builders need a certain demand base before making the investment and typically see significant improvements in station economics as demand

increases. Increased availability of stations, opportunities for home refueling, and decreased operational and capital costs can help to foster a more competitive natural gas vehicle market.

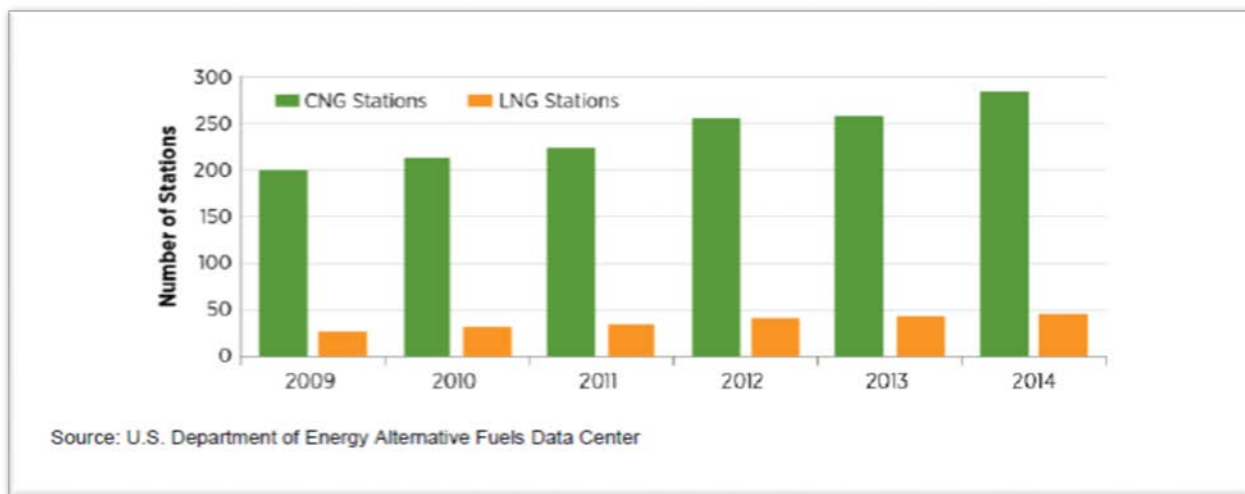

Figure 2. Natural Gas Fueling Stations in California 2009-2014.

A study by UC Davis’ Institute for Transportation Studies<sup>34</sup> (ITS-Davis) concluded that the conditions for natural gas fueling infrastructure in the state of California are more commercially attractive than in other parts of the United States. The flow of freight traffic on California highways is higher than on many other national routes and a high percentage of the state’s freight movement is concentrated on the I-5 corridor, limiting the number of stations needed to cover major routes inside the state. California also has higher diesel prices than in other parts of the country, again providing a more favorable commercial incentive for fuel switching. ITS Davis finds that firms can achieve a 12 percent rate of return on investment in natural gas fueling stations in California, once the network of long distance trucking running on natural gas were to reach a penetration rate of 6,000 vehicles, about twice as high as today’s fleet. This study confirmed the possibility that some financial incentives for natural gas trucks including existing carbon credits would be effective in promoting a state-wide fueling network.

Research shows that hydrogen roadmaps involve public-private partnerships that coordinate the deployment of FCVs and hydrogen infrastructure build-out, geographically and over time<sup>35, 36, 13</sup>. A cluster strategy is considered desirable, co-locating the first several thousand vehicles and tens of stations in “lighthouse” communities identified as early adopter areas within a larger region<sup>37</sup>. The cluster strategy lowers the required number of initial stations<sup>38</sup>.

## 2.2 RENEWABLE NATURAL GAS IN TRANSPORTATION: LITERATURE REVIEW

Renewable natural gas can be blended with natural gas with some clean up intervention. Renewable natural gas can be produced from landfill gas, and from the anaerobic digestion of wet and dry bio residues such as manure, WWTP sludge and food and green waste.

### 2.2.1 RNG PATHWAYS

Anaerobic digestion (AD) of organic waste is the process of treating organic material (yard clippings, food waste, food soiled papers or biological waste) in an anaerobic setting. This

process utilizes the natural decomposition of the material to break it down into a nutrient rich soil additive. This process produces methane, which is then captured and processed for fuel or energy usage. Anaerobic digestion is typically broken up into two categories, wet and dry.

Wet AD is typically employed at wastewater treatment plants or at livestock production facilities to deal with animal waste. Three manure to energy processes are generally used:

- Covered anaerobic lagoon- Standard retention ponds are covered in order to contain the methane and then that gas is converted to energy or fuel.
- Plug-flow dairy- Digestion of waste occurs as it works through a processing system in a batch manner; therefore, keeping the waste from mixing with newly introduced materials.
- Continually stirred tank reactors- this technology mixes the waste to maintain a consistency through the system. Continuously stirred tank reactors are most typical in both agricultural and wastewater treatment plants.

Dry AD is used to process food waste and green waste typically collected from residential and commercial establishments by cities or private waste companies. Most are batch processed in a plug-flow digester<sup>39</sup>.

Recovery of green and food waste is a notable component to zero waste initiatives. Cities, such as San Francisco and Seattle have declared zero waste goals as a part of their sustainability policies<sup>40</sup>. Also, many major corporations including Wal-Mart have achieved or are working toward zero waste goals for their companies<sup>41</sup>. These efforts demonstrate that the political and corporate climate may be prepared to embrace alternative technologies for handling solid waste. Snider et al. find that methane production from food waste in the U.S. could total 5.9 billion cubic meters (208 Billion scf), representing about \$1.5B in energy produced<sup>42</sup>.

An additional opportunity for growth within AD is the combination of wet and dry processing facilities. Agricultural AD systems could benefit financially from the addition of food and green waste in order to generate additional revenues as well as increase energy production<sup>43,44</sup>. AD from both wet and dry sources is typically small scale applications set up at wastewater treatment plants, dairies and landfills. There are approximately 120 anaerobic digesters in operation in the US. Globally, there are significantly more with 3,700 in Germany alone<sup>45</sup>.

### **2.2.2 RNG COSTS**

Cost studies for RNG vary widely. Lazarous and Rudstrom<sup>46</sup> estimate capital costs of dairy AD of \$355,000-\$424,000 per installation (for a 800 cow dairy producing 3,418 mmBTU of NG per year). Use of simple payback periods of 4-10+ years and IRR- -13% to 8% for a NPV (annualized) estimate between -\$27,856 to \$5,919. Variations in the estimates are based on grants, loans and subsidies currently available for the dairy farm.

Another study of small producers (in the 3-7 mmBTU/day range) showed that of 16 installed systems, only 6 had positive cash flows using an 8% discount rate and 20-year lifetime. This required 50% cost sharing from grants, loans, tax exemptions and production incentives<sup>47</sup>.

For a 64 mmBTU/day Waste Water Treatment Plant (WWTP) digester, a 2005 study in Massachusetts<sup>48</sup> demonstrated capital costs of \$1.67M, payback period of 8 years, an annual

cash flow of \$66K (cost of loan only, without the cost of operating the combined heat and power plant).

Another study noted high capital costs can be created due to the equipment required for biogas capture and upgrading<sup>49</sup>. Studies report that dry AD is more economically viable than wet due to lower energy costs and more efficient energy production<sup>50</sup>.

### **2.2.3 RNG YIELDS**

Theoretical potential yields for AD projects can be estimated based on amount of feedstock. However, the ability to capture, process and bring this gas to market under commercial conditions can be different. Successful AD projects require a reliable and steady feedstock. AD projects in the range of 3-70 mmBTU per day have been built. For reference, production of 10 mmBTU per day is equivalent to about 70 gallons of diesel fuel per day and could fuel a fleet of perhaps 3 to 4 refuse trucks assuming each was driven 100 miles per day. Securing contracts with waste haulers for the constant supply of green/food waste is advantageous. Methods to prevent contamination of the feedstock also are desirable to optimize usability of supplies. In practice, proximity to secure fuel sales users can support commercial feasibility but many supply sources are distant to end user markets. High interconnection and clean-up costs can hinder commercial feasibility of projects.

Methane production in a landfill is variable upon a number of factors. The amount of organic waste in the landfill, the amount of rain the region receives and the number of wells can influence the pace and volume of methane creation in a landfill. While these variables can be planned and modeled, this variation means that the energy production potential of each landfill should be considered individually.

Generally speaking, landfills in California are seeing decreasing methane production volumes due to increased recycling efforts. In considering the commercial feasibility of landfill RNG projects, investors must take into consideration the following factors: What is the rate of slowdown for the landfill and how were these reductions figured into the financial modeling for the project? What is the estimated remaining lifespan of the landfill? Are any efforts in place to speed up production of landfill gas (adding water to the landfill etc.)? Has this been included in the financial models?

Landfills are Title V facilities and therefore subject to Title V emission standards. In the California and San Francisco Bay area, local regulations include regional standards under BAAQMD 8-34, state standards set by CARB AB 32, and EPA requirements under New Source Performance Standards<sup>51,52</sup>. Additional regulations governing landfills include the Landfill Methane Control Measure<sup>53</sup>. This latter rule stipulates that all landfills, active, inactive and closed with 450,000 tons or more that received waste after January 1, 1977, must have gas collection equipment installed and maintained.

### **2.2.4 COMMERCIAL RNG EXAMPLES**

One of the largest landfill gas-to-liquid fuel projects is a joint venture with Linde and Waste Management. This project produces up to 13,000 gallons of LNG per day. Currently the fuel is used exclusively for Waste Management's garbage truck fleet.



Commercial feasibility of landfill gas production facilities can be enhanced via the value of tipping fees that are assessed by the landfill or transfer station receiving the waste. Tipping fee revenues vary greatly across the United States, but average \$44 per ton nationwide<sup>54</sup>. Still, the waste industry has suffered from a lack of profitability<sup>55</sup> and is encountering tougher commercial economics in recent years.

Further technical details on the composition, physical properties, clean-up requirements for the different types of biogas and the compatibility of RNG with the natural gas system are given in Appendix A. ITS-Davis' most recent estimates for RNG resources in California are presented in the results section below.<sup>56</sup>

### **2.2.5 RNG SYNERGIES**

RNG produced from landfill gas and municipal solid waste is the alternative gaseous fuel with the largest potential overlap of fossil natural gas infrastructure. Emerging RNG supplies can utilize much of the same infrastructure as fossil natural gas networks, sharing the same vehicles, station equipment and midstream pipelines for transmission. In addition, there is the possibility that the RNG resource development time line is aligned with the current expansion of natural gas in transportation. The time frame for availability and opportunity exist in the current market, allowing for RNG and fossil natural gas networks to be developed simultaneously, each facilitating the other. Fossil natural gas network investors can benefit from receiving ongoing carbon credits by blending RNG into their fossil based natural gas fuel while RNG investors can save costs by piggy backing on existing fossil natural gas infrastructure. High clean-up costs to reach the standard of compliance for access to the California existing natural gas pipeline system can be an economic obstacle to RNG commercial development. RNG has many impurities that need to be addressed before it can be blended into existing fossil natural gas infrastructure. Thus, clean-up costs are a barrier, as is the misalignment between location of supply and location of demand.

One aspect of the high costs for pipeline injection of RNG into the fossil natural gas pipeline system is the testing and verification required to meet pipeline owner specifications. California's interconnection costs for RNG feeder pipelines into the existing natural gas system pipeline system are generally more expensive than other states. California has strict environmental and safety standards for RNG injection (testing, mixing, compression, etc). Recently, the CPUC has instituted a biomethane monetary incentive program<sup>57</sup> which will provide \$40 million in funding to offset 50% of interconnection costs, up to \$1.5 million for each biomethane project built in California over the next five years. This program will enable in state RNG production.

For RNG from dairies and municipal solid waste, separate, greenfield AD facilities and dedicated clean up equipment must be constructed to generate the biogas. These facilities are not co-located with the fossil natural gas system and specifically with the large scale natural gas processing systems for fossil gas clean up and therefore cannot take advantage of the fossil gas infrastructure. Because biogas facilities for upgrading generally speaking would be dispersed at multiple sites where the resource is based, small biogas sources are unable to take advantage of the economies of scale in the clean-up technologies that reduce the cost of fossil gas clean up. Clustering of biogas clean up facilities can improve the commercial economics of RNG development.

Biogas differs from fossil natural gas by not having to remove oil or condensates from the gas but having higher concentrations of water and CO<sub>2</sub> to remove, making different technologies more appropriate for biogas clean-up. In addition, biogas from waste water and landfill gas also has other contaminants such as siloxane and vinyl chloride not present in fossil natural gas but must be removed before biogas can enter a carbon dioxide removal process.

## 2.3 HYDROGEN IN TRANSPORTATION: LITERATURE REVIEW

California has taken a leadership role in assessing hydrogen as a potential future transportation fuel. Hydrogen is of interest because of its potential to reduce carbon emissions from the transport sector, which is the largest single contributor to California's greenhouse gas emissions. Hydrogen also is seen as a solution to tailpipe air pollutant emissions because it offers a zero emissions performance. In this section we provide background information on hydrogen supply technologies and their synergies with natural gas supply technologies. We also describe the current status of hydrogen infrastructure development in California.

### 2.3.1 HYDROGEN PRODUCTION

Like electricity, hydrogen can be produced from diverse primary energy resources (see Figure 3 below). Almost any energy resource can be converted into hydrogen, although some pathways are superior to others in terms of cost, environmental impacts, efficiency, and technological maturity. In the United States, about 9 million metric tonnes of hydrogen are produced each year, mainly for industrial and refinery purposes (enough to fuel a fleet of about 35 million fuel cell cars if it were used for that purpose). Steam reforming of natural gas is the most common method of hydrogen production today, accounting for about 95 percent of hydrogen production in the United States.

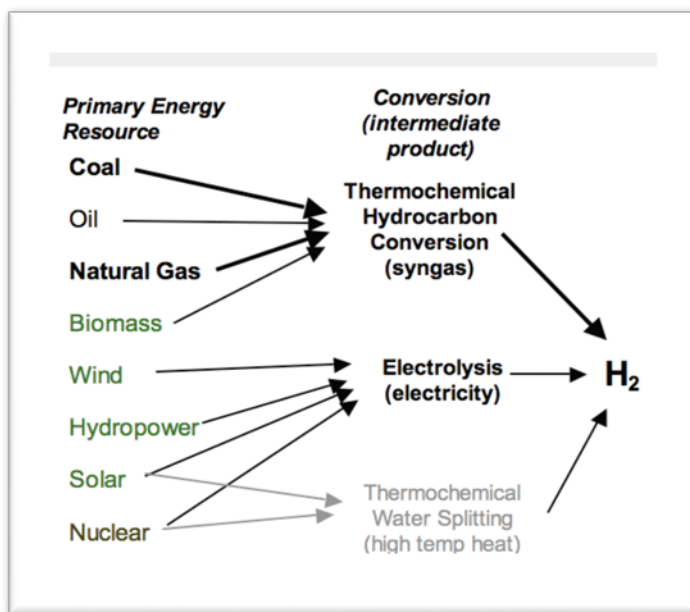

Figure 3. Pathways to hydrogen

### 2.3.1.1 Hydrogen from Fossil Fuels

In the near to medium term, fossil fuels (primarily natural gas) are likely to continue to be the least expensive and most energy-efficient resources from which to produce hydrogen. Conversion of these resources still emits some carbon into the atmosphere, roughly half as much as a comparable gasoline car on a well to wheels basis<sup>58</sup>. The growth of low-cost shale gas has been one important factor boosting interest in hydrogen in the US.

Hydrogen production from natural gas via steam methane reforming is a well-established and proven, mature technology for applications in the industrial sector. These applications include ammonia production, refinery processes such as hydrocracking and hydro-desulfurization, and food processing hydrogenation reactions.

The hydrogen production process consists of three major chemical process steps: steam methane reformation, water gas shift reaction and hydrogen separation and purification. These three reactions are used to strip the H<sub>2</sub> from the natural gas molecules (primarily CH<sub>4</sub>), enhance the yield of H<sub>2</sub> by further extracting enthalpy from carbon monoxide (CO), and purify the H<sub>2</sub> by reducing the impurity (mainly CO and CO<sub>2</sub>) concentration.

Future hydrogen production technologies could virtually eliminate greenhouse gas (GHG) emissions even in the case of fossil feedstocks.

When hydrogen is produced thermochemically from hydrocarbons like natural gas, coal or even biomass, CO<sub>2</sub> can be separated, captured, transported and stored deep underground in secure geological formations like depleted oil and gas fields or deep saline aquifers. CO<sub>2</sub> capture, transport and storage technologies are similar for hydrogen and electricity. The incremental cost of CO<sub>2</sub> capture can be lower for hydrogen systems than for power plants, because separating carbon (CO<sub>2</sub>) is already an inherent part of the process of making hydrogen from a hydrocarbon. Scale-up issues, availability of CO<sub>2</sub> storage sites and costs for initiating a CO<sub>2</sub> disposal network are analogous to those for fossil electricity with CCS<sup>59</sup>. For large central plants producing hydrogen from natural gas or coal, it is technically feasible to capture 75-90% of the CO<sub>2</sub> produced and permanently sequester it in deep geological formations, although the widespread use of sequestration technology has several important challenges to overcome and is unlikely to happen on a wide scale until 2025 at the earliest.

H<sub>2</sub> from natural gas is the most mature and cost-effective near-term technology for medium-to-large scale production (over 10 tonnes/day). Distributed hydrogen production via small-scale natural gas reformers is considered a promising near-term hydrogen pathway<sup>60, 61</sup>. A number of demonstration projects involving distributed onsite production via natural gas have been installed. Two hydrogen stations in California use onsite small steam methane reformers.

The following figure (Figure 4) illustrates six sample pathways for producing hydrogen from natural gas for use in vehicles. Natural gas (delivered by pipeline to the refueling station) is converted to hydrogen onsite in a small steam methane reformer (SMR) in the “onsite SMR” pathway. In the “centralized production” pathway, a large central SMR is used to produce hydrogen from natural gas and then the hydrogen is delivered by truck as compressed gas (CH<sub>2</sub>) or cryogenic liquid (LH<sub>2</sub>) or via hydrogen gas pipeline to the fueling station. Centrally produced hydrogen from natural gas can also be blended into existing natural gas pipelines and delivered

to stations. The NG/ H<sub>2</sub> blend gas can be used directly or the hydrogen can be separated for use in fueling in fuel cell vehicles.

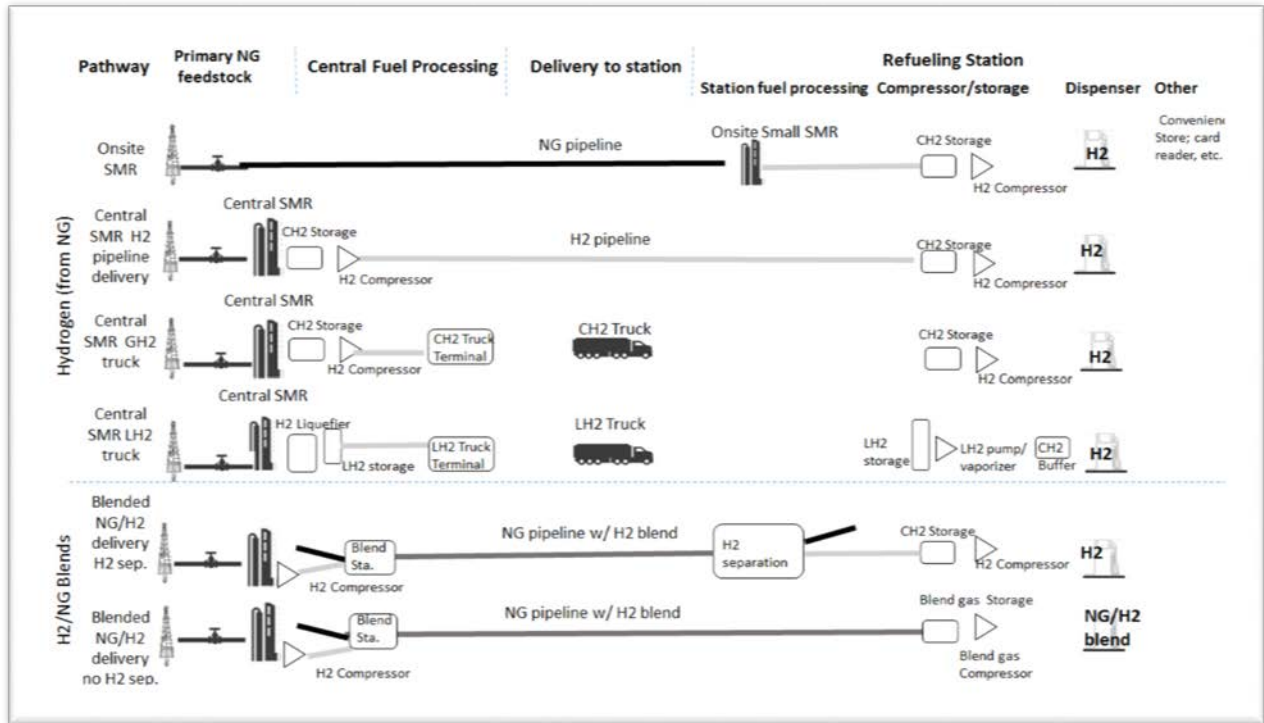

Figure 4. Six fuel supply pathways for hydrogen and hydrogen blends derived from natural gas.

A positive cash flow for hydrogen suppliers and hydrogen priced competitively with gasoline is estimated to be \$10/kg initially, and \$5-8/kg for the longer term.<sup>viii</sup>

### 2.3.1.2 Hydrogen from Low Carbon Pathways

Production of hydrogen from renewable biomass is a promising midterm option (post 2020) with very low net carbon emissions, and could also take advantage of carbon capture and sequestration, enabling net negative carbon hydrogen<sup>62</sup>. In the longer term, vast carbon-free renewable resources such as wind and solar energy might be harnessed for hydrogen production via electrolysis of water. While this technology is still improving, high costs for electrolyzers and renewable electricity (in part because of the low capacity factors of intermittent renewable sources) suggest that renewable electrolytic hydrogen will likely cost more in the long-term than hydrogen from fossil resources with carbon capture and sequestration (CCS) or biomass gasification. For example, a recent study by Yang and Ogden on low carbon options for

<sup>viii</sup> Hydrogen costs are typically given in \$ per kilogram (\$/kg). 1 kg of hydrogen has about the same energy content as 1 gallon of gasoline. Hydrogen FCVs are about 2-2.5 times as energy efficient as conventional gasoline internal combustion engine vehicles. So the fuel cost per mile for H<sub>2</sub> at \$10/kg is equivalent to gasoline at \$4-5/gallon. For estimates for vehicle efficiencies see: National Research Council. Transitions to Alternative Vehicles and Fuels. Washington, DC: National Academies Press, 2013.

[http://www.nap.edu/catalog.php?record\\_id=18264](http://www.nap.edu/catalog.php?record_id=18264)

hydrogen supply in California suggests that it would cost several dollars more per kg of hydrogen to achieve a 90% reduction in GHG emissions from hydrogen pathways<sup>63</sup>. In addition, there may be benefits to coupling hydrogen fuel production with flexible storage of off-peak intermittent renewable electricity from wind or solar intensive electricity grids.

Biomass hydrogen produced via large scale gasification potentially has a lower production cost than electrolytic hydrogen, but biomass resources are more limited, and may find higher value uses as feedstocks for making liquid biofuels or RNG. Another possibility would be reforming biogas.

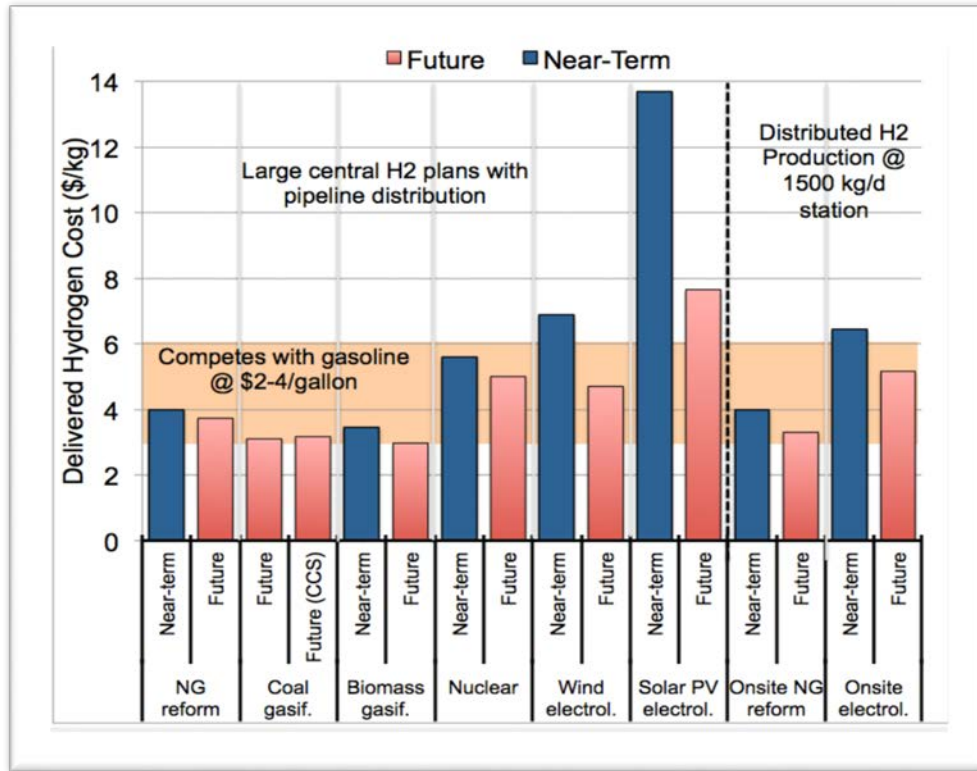

Figure 5. Delivered cost of hydrogen transportation fuel from various pathways.

In Figure 5, the orange band indicates where the fuel cost per mile for hydrogen FCVs would compete with a gasoline hybrid. (Note that fuel taxes are not included in the delivered fuel costs.) Costs assume that hydrogen supply technologies are mature and mass-produced and are based on costs from the H2A model.

There is growing interest in renewable hydrogen in California due to the regulatory requirement for the fuel in the state SB1505 (also see section 1.3.5). For renewable hydrogen derived from solar or wind electrolysis, the issue is more cost than technical feasibility or resource availability. Unless electricity is essentially “free” (for example, sourced from curtailed windpower), the production cost of hydrogen is generally higher than with steam reforming of fossil natural gas. “Power to gas” projects are underway in Europe that turn excess renewable power that cannot be absorbed into markets at the time of production into hydrogen as a “storage” technique for later use.<sup>64</sup>

Hydrogen can be produced electrolytically from nuclear power, but costs from this source are high and issues of waste disposal, safety and proliferation are similar to those for nuclear electricity.

The technologies for large-scale production of hydrogen from fossil sources are well established. The challenges for low carbon hydrogen supply are similar to those for low carbon electricity with respect to issues for nuclear and renewable energy and fossil hydrogen with carbon capture and storage.<sup>65</sup>

### **2.3.2 HYDROGEN STORAGE AND DELIVERY**

Once hydrogen is produced, there are several ways to deliver it to vehicles.<sup>ix</sup> Hydrogen can be produced regionally in large plants, stored as a compressed gas or cryogenic liquid (at -253°C), and distributed by truck or gas pipeline; or it can be produced on-site at refueling stations (or even homes and commercial facilities) from natural gas, alcohols (methanol or ethanol), or electricity.

Hydrogen delivery technologies are well known commercial technologies in the merchant hydrogen and chemical industries today. While most industrial hydrogen is produced and used onsite, a significant fraction is delivered by dedicated pipeline or truck to more distant users. No one hydrogen supply pathway is preferred in all situations, so, like electricity, it is likely that diverse primary sources will be used to make hydrogen in different regions. Figure 6 shows the delivered cost of hydrogen for a variety of supply pathways, based on costs from the USDOE H2A (Hydrogen Analysis) model<sup>x</sup>. Storing and delivering hydrogen as a transport fuel could add significantly to costs, depending on the quantities delivered and the delivery distance.

### **2.3.3 HYDROGEN INFRASTRUCTURE STRATEGIES**

A convenient, low cost hydrogen refueling infrastructure is a key pre-condition for widespread adoption of hydrogen vehicles. Because there are many options for hydrogen production and delivery, and no one supply option is preferred in all cases, creating such an infrastructure is a complex design problem. The challenge is not so much producing low-cost hydrogen at large scale as it is providing a convenient and low-cost network of hydrogen stations to many dispersed users, especially during the early stages of the transition. Thinking has advanced considerably over the past few years about how to build a convenient, low cost early hydrogen infrastructure that mitigates some of the ‘chicken-and-egg’ dilemma, by balancing the needs of stakeholders, reducing risk and encouraging confidence. There is now widespread agreement that an early hydrogen infrastructure must offer the following:

---

<sup>x</sup> With support from the US Department of Energy, a major analysis effort was launched in 2003 to document cost and performance data for hydrogen production and delivery technologies. A USDOE-led team developed the “Hydrogen Analysis” or H2A model with extensive industry input. A series of spreadsheets were developed for key hydrogen infrastructure components like reformers, electrolyzers, compressors, storage and pipelines. Figure 5 shows delivered hydrogen costs derived from the H2A model. A general description of the H2A model is found at the US Department of Energy Hydrogen Energy website, [https://www.hydrogen.energy.gov/h2a\\_analysis.html](https://www.hydrogen.energy.gov/h2a_analysis.html). Users’ guides for modeling hydrogen production and delivery technologies are found at: [https://www.hydrogen.energy.gov/h2a\\_production.html](https://www.hydrogen.energy.gov/h2a_production.html) [https://www.hydrogen.energy.gov/h2a\\_delivery.html](https://www.hydrogen.energy.gov/h2a_delivery.html)

- **Coverage:** enough stations to provide convenient fuel accessibility for early vehicles
- **Capacity:** to meet hydrogen demand as the fuel cell vehicle (FCV) fleet grows
- **Cash flow:** positive cash flow for individual station owners and for network-wide supply
- **Competitiveness:** Offering hydrogen fuel to consumers at a competitive cost with gasoline, estimated to be \$10/kg initially, and \$5-8/kg for the longer term.<sup>xi</sup>

To meet these goals, rollout plans must closely coordinate the introduction FCVs and hydrogen infrastructure, geographically and over time. Such plans are being developed by public-private partnerships around the world.<sup>66</sup>

California is a good illustration of how thinking on infrastructure rollout has evolved. The first proposal for the California Hydrogen Highway (2004) was an announcement by the governor that the state would build hydrogen stations every 20 miles along the interstate highways. It was soon recognized that this plan would not serve the daily refueling needs of urban populations, where most Californians live. A more analytical approach was taken by the state's Hydrogen Blueprint Plan (2006), locating hydrogen stations to serve the state's urban populations, loosely based on today's gasoline infrastructure. These studies showed that consumer convenience similar to gasoline could be achieved if approximately 10-30% of gasoline stations offered hydrogen.<sup>67</sup> This was an important insight: hydrogen would not be needed at every gasoline station. But even 5-10% of gasoline stations is still a large number, amounting to 200 to 400 stations in the Los Angeles area alone, just to get started.

The next conceptual advance was development of the "cluster strategy", the idea of co-locating the first several thousand vehicles and tens of stations in "lighthouse" communities identified as early adopter areas within a larger region. The cluster strategy brought the required number of initial stations to a more tractable level and is being used in current planning and road-mapping for hydrogen in California.<sup>68</sup>

#### **2.3.4 CURRENT STATUS OF HYDROGEN INFRASTRUCTURE DEVELOPMENT IN CALIFORNIA**

California has launched a deployment program to accelerate hydrogen fueling infrastructure in several pilot locations such as Los Angeles, Oakland and Sacramento. California has targeted building 51 stations by the end of 2017, and 100 hydrogen refueling stations by 2020 and has allocated up to \$20 million per year for this purpose through AB8. Current fuel cell vehicle populations and hydrogen station numbers are shown below, as well as CARB's projections to 2021.

California has adopted policies to move toward renewable hydrogen transportation fuel over time. California regulation SB 1505 requires that 33% of state-funded hydrogen stations must be renewable. And once statewide hydrogen fuel use exceeds a "threshold" level of 10,000 kg H<sub>2</sub>/day (enough to serve a fleet of about 10,000-20,000 fuel cell vehicles) a similar regulation takes effect for privately built hydrogen stations. SB 1505 acts as a renewable hydrogen

---

<sup>xi</sup> Hydrogen costs are typically given in \$ per kilogram (\$/kg). 1 kg of hydrogen has about the same energy content as 1 gallon of gasoline. Hydrogen FCVs are about 2-2.5 times as energy efficient as conventional gasoline internal combustion engine vehicles. So the fuel cost per mile for H<sub>2</sub> at \$10/kg is equivalent to gasoline at \$4-5/gallon. For estimates for vehicle efficiencies see: National Research Council. Transitions to Alternative Vehicles and Fuels. Washington, DC: National Academies Press, 2013. [http://www.nap.edu/catalog.php?record\\_id=18264](http://www.nap.edu/catalog.php?record_id=18264)



portfolio standard analogous to California’s rules for electricity. Early use of renewable hydrogen may add costs to the early infrastructure development compared to using a fossil based hydrogen supply, but will allow renewable hydrogen producers to obtain LCFS credits.

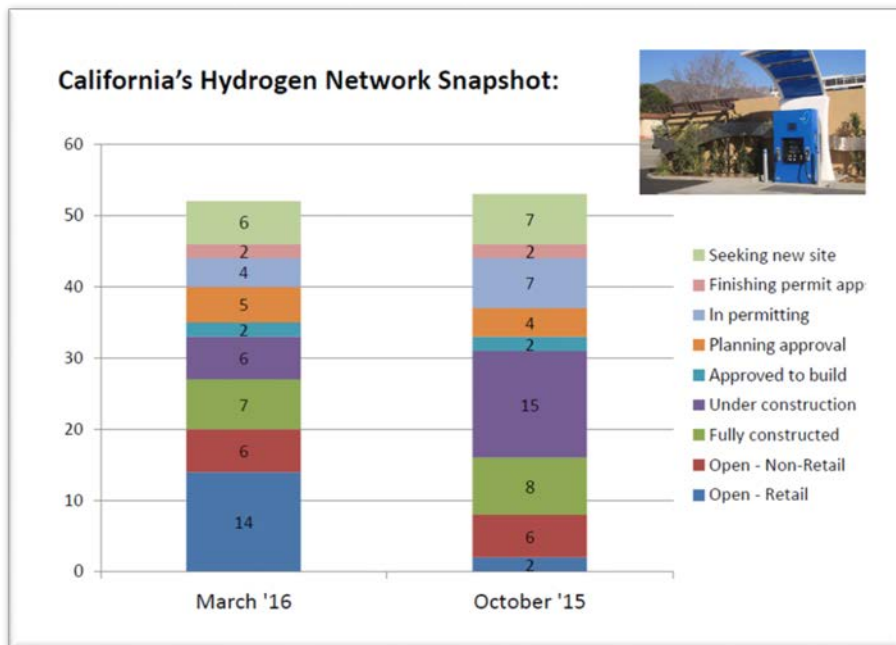
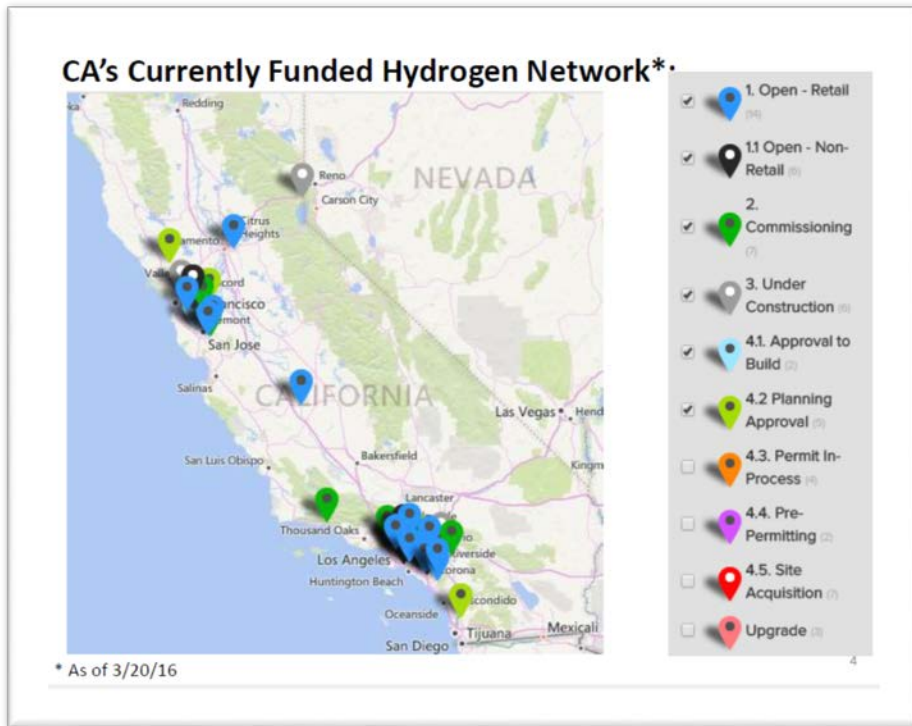

Figure 6. Locations (top) and status (bottom) of hydrogen refueling stations in California. In 31 stations, compressed hydrogen is delivered by truck; 7 have liquid hydrogen delivered by truck; 7 onsite electrolysis; 2 onsite steam methane reforming; 1 hydrogen pipeline delivery.



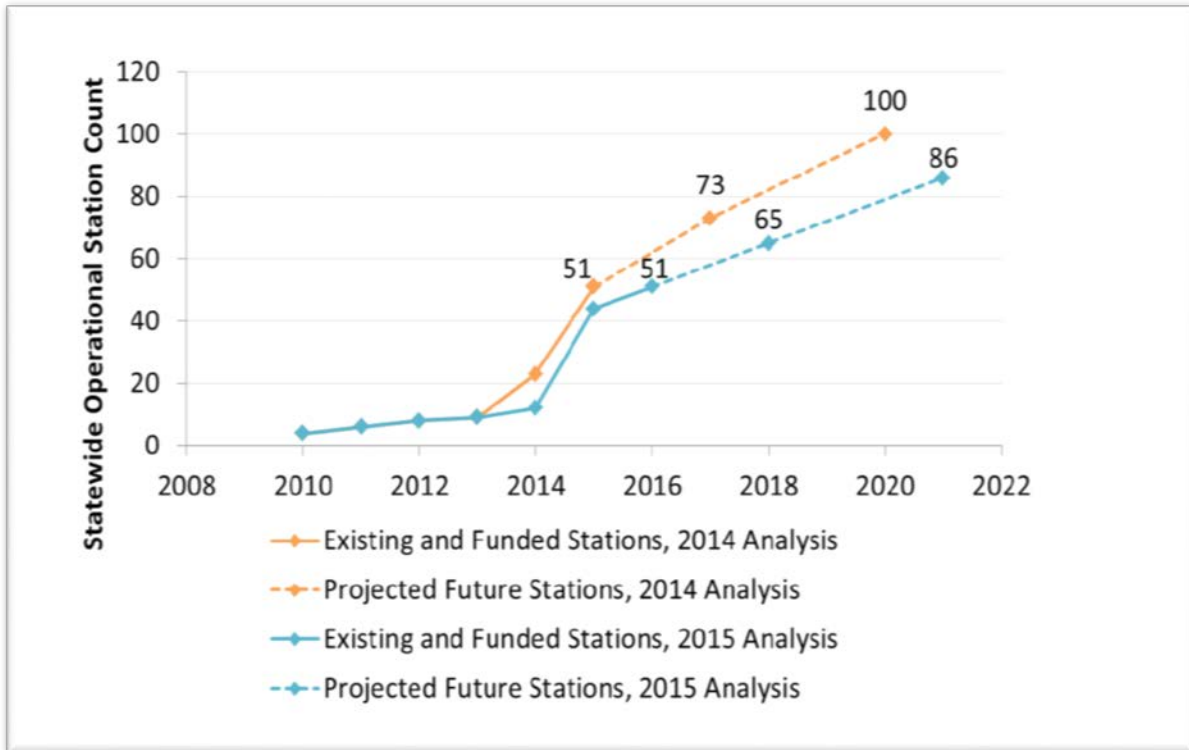
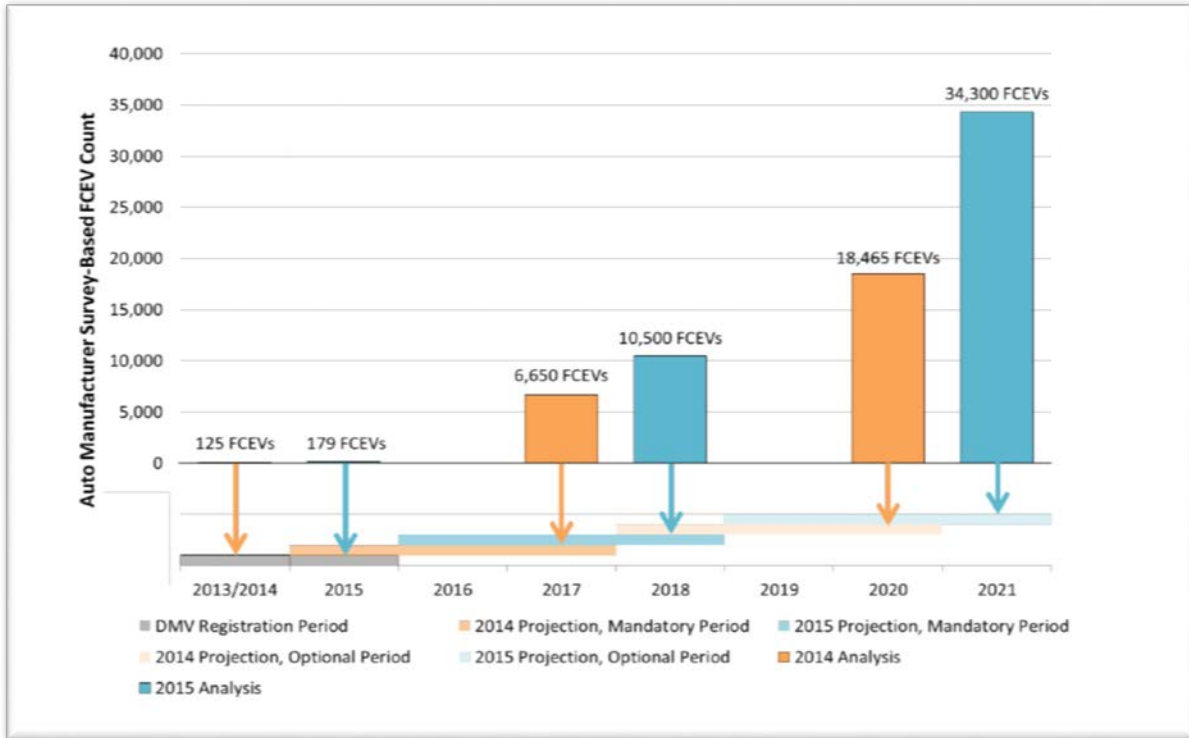

Figure 7. CARB projections for hydrogen fuel cell vehicle populations (top) and numbers of stations (bottom) in California (CEC/CARB Joint report 2015)<sup>69</sup>.

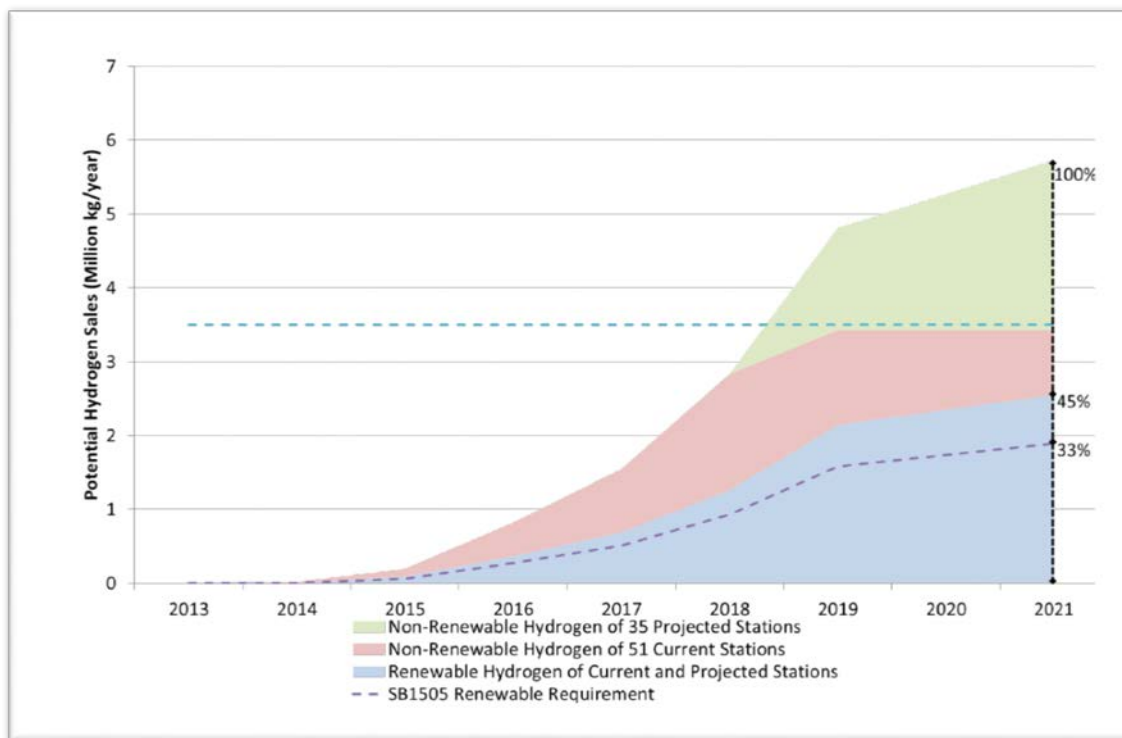

Figure 8. Renewable Hydrogen Requirements in California under SB1505.

### 2.3.5 STUDIES OF HYDROGEN AND THE NATURAL GAS GRID

Several recent studies have addressed the potential synergies between hydrogen and natural gas<sup>70,71</sup>.

The idea of utilizing hydrogen in the existing natural gas grid has been analyzed in various studies going back to the 1980s. One of the main motivations is potentially avoiding the expense of building a new gaseous fuel infrastructure, phasing in hydrogen as part of a blend with natural gas (analogous to adding renewable ethanol to gasoline), by re-using existing equipment throughout the supply chain. More recently, companies have been investigating whether existing natural gas pipelines could be fully changed over to hydrogen transportation uses in California as the state transitions to lower carbon fuels. Hydrogen is currently transported in California through dedicated pipelines specifically designed of non-corrosive steel that is compatible with hydrogen's physical and chemical properties. In particular, hydrogen is a smaller molecule than methane gas, giving hydrogen a faster leakage rate and more potent corrosive effect on metals. This means hydrogen can embrittle and degrade materials commonly used to store and transport natural gas. To date, industry practice has been to use different, costlier materials for the transportation and storage of hydrogen than for fossil natural gas.

Before introducing either hydrogen/natural gas blends or pure hydrogen into a system designed for natural gas, a careful assessment must be done. A thorough investigation of all pipeline materials and the nature of any cracks or corrosion would need to be verified before adding hydrogen to any existing natural gas transmission or distribution infrastructure.

As a “rule of thumb”, various studies suggest that blending relative low concentrations of hydrogen with natural gas (<5%–15% H<sub>2</sub> by volume) would not significantly increase risks such as potential damage to end-use devices (such as household appliances) or adversely affect the durability and integrity of the existing NG pipeline network or public safety<sup>70</sup>. Although 5-15% hydrogen by volume is often given as a “rule of thumb” value, recent studies stress that the allowable blend concentration may vary significantly between pipeline network systems and natural gas compositions and must therefore be assessed on a case-by-case basis.<sup>72</sup>

It is unclear how much of the existing natural gas pipeline system - including pipes with polymer liners- is made of hydrogen compatible materials. Further, the assessing state of repair of the pipelines is important, as introducing hydrogen can accelerate the growth of existing cracks or imperfections near welds.

Any introduction of hydrogen blend would require extensive study, testing, and modifications to existing pipeline monitoring and maintenance practices (e.g., integrity management systems). Specifically, operators would need to take a maintenance inventory of the entire system which would then have to be independently verified. Assessment would have to include verified evaluations by regulators of how compatible existing components and materials would be with hydrogen blends and measure how permeable lines and existing materials would be to hydrogen exposure.

### **2.3.6 SYNERGIES BETWEEN HYDROGEN FUEL CELL AND NATURAL GAS VEHICLES**

There has also been recent interest in exploring the potential synergies between natural gas vehicles and hydrogen fuel cell vehicles. Hydrogen and natural gas have some physical similarities. Both can be stored as compressed gas or cryogenic liquids. Leakage from pipeline and storage containers is a challenge for both gases. Each fuel requires costly water removal and contaminant clean up at the production source. Both also have some of the same issues related to flammability limits and volatility. Still, with proper equipment and monitoring, both natural gas and hydrogen can be safe vehicle fuels. A recent USDOE report<sup>73</sup> concluded that “Starting from common standards and equipment may enable synergistic development of both hydrogen and natural gas.”

Another key insight is that although the two gaseous fuels have some physical similarities, they are likely to serve quite different types of vehicle markets. As noted in a recent study summarizing a workshop by the American Gas Association:

- “Vehicle choice for **commercial applications**, (e.g. freight trucks and delivery vans) is driven by economics and business needs. These businesses are already on a path towards broad use of natural gas for trucks and vans.
- “In contrast, automakers expect that H<sub>2</sub> fuel cell electric vehicles (FCEVs) will be adopted more broadly for **personal transportation**.
- “While there may be overlap in selected niches, such as buses or light duty fleet vehicles, current market and manufacturer signals indicate that H<sub>2</sub> and NG will likely segment into different transportation application areas”.

This market segmentation has major implications for where infrastructure is built. Fueling stations serving long haul heavy duty natural gas trucks will be built along heavily used,

interstate corridors, while early hydrogen stations serving light duty vehicles will be clustered in urban early adopter areas as will be discussed in more detail below.

### 3 METHODS

We examine the precise natural gas infrastructure that is economically and technologically synergistic for both natural gas and renewable natural gas in the near-term, and alternative fuels like renewable natural gas (RNG) and hydrogen in the long term. In particular, we examine optimum paths for developing infrastructure in the near-term that will accommodate alternative fuels once they become available at the commercial scale. The original design of the Low Carbon Fuel Standard (LCFS) provides time for the development of advanced, near-zero technologies. We consider the credits from the LCFS in our analysis.

In this section, we outline what natural gas infrastructure would be most economically and technologically commercially feasible for fossil natural gas transportation fuel and then potentially enabling to lower carbon fuels in the long term. The original design of the low carbon fuel standard (LCFS) provides time for the development of advanced, near-zero technologies. Having infrastructure already in place to deliver alternative fuels to fleets, once more low carbon fuels are already in place, will ease the future transition to zero and near-zero transportation technology and lower the costs of transition. We explore optimum paths for developing infrastructure in the near-term that will accommodate alternative fuels to scale up to significant levels.

#### 3.1 FOSSIL NATURAL GAS INFRASTRUCTURE PATHWAYS

In the conventional LNG pathway, natural gas is delivered by pipeline from the supply site to a liquefaction plant. After it is liquefied, it is delivered by truck to a refueling station and put into a storage tank. LNG is then dispensed out of the storage tank at the refueling station. The second delivery route is the modular small scale LNG. In this relatively new small scale technology, natural gas is delivered from the supply site directly to the refueling station via pipeline. At the refueling station, natural gas is then converted to LNG onsite in a modular liquefaction plant and then dispensed to the customer as LNG via a fuel dispenser.

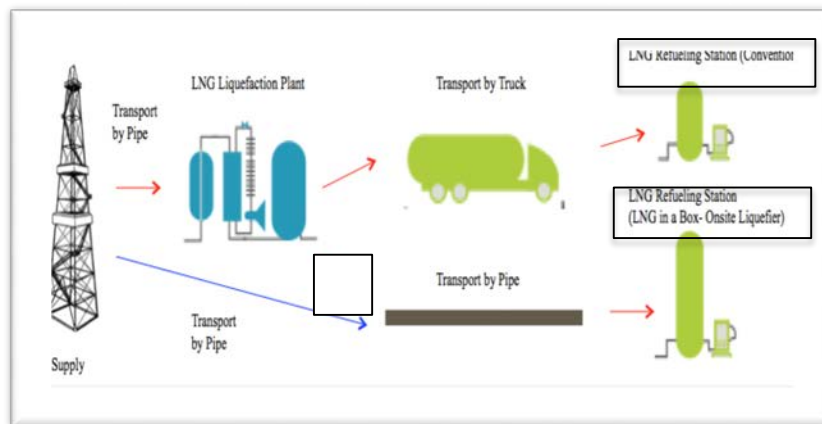

Figure 9. LNG supply pathways

CNG is an alternative to LNG technologies. For CNG, natural gas travels by pipeline to a compression unit at a CNG dispensing station, from where it will be transferred to a dispensing pump and accessible to consumers with natural gas vehicles. The compression unit is used to increase pressure before the gas is dispensed. Vehicles can be fueled using either a fast fill or time fill system. Generally speaking, time fill stations are used when vehicles can be parked overnight for refueling such as return to base fleets. Fast fill systems are designed to be comparable to traditional liquid fuel commercial systems along highways and at other high volume locations for retail fuel sales.

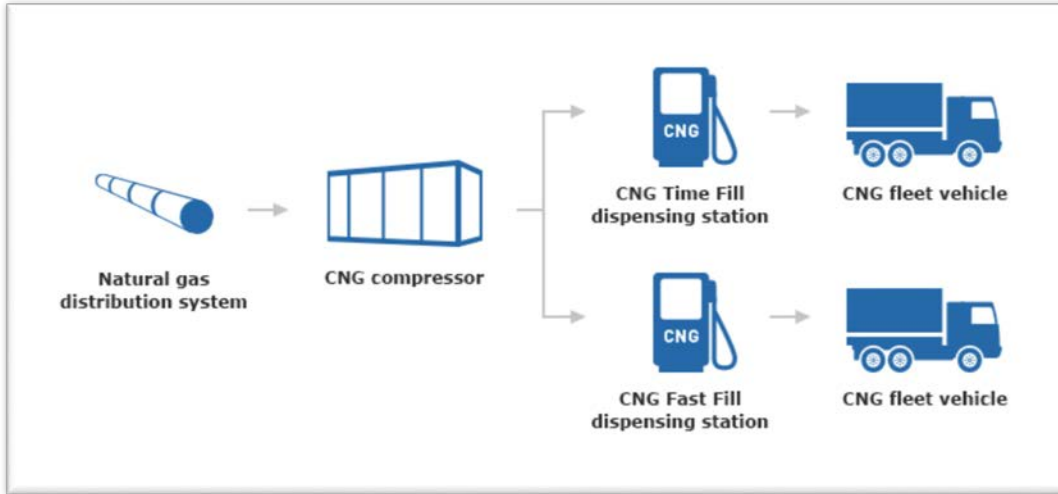

Figure 10. CNG supply pathway

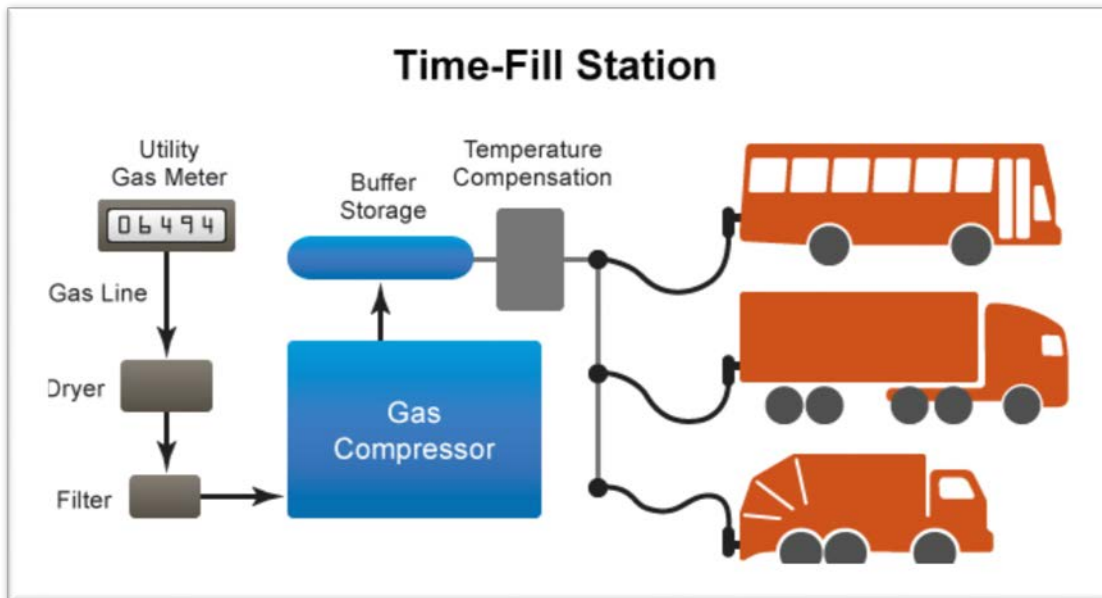

Figure 11. CNG Time fill station configuration.

## 3.2 RENEWABLE NATURAL GAS SUPPLY PATHWAYS

RNG is rich in methane that is produced from organic materials or waste streams and can be processed so that it meets natural gas pipeline and vehicle specifications. RNG can be produced from manure, food waste, landfill gas, wastewater treatment sludge, forest and agricultural residues, and organic municipal solid waste. Blending RNG with fossil natural gas provides a potential opportunity to build RNG usage and familiarity, while lowering costs through integration with existing infrastructure. In a manner similar to E85, a small percentage of RNG could be added to fossil natural gas, to begin building the necessary infrastructure and markets for pure RNG.

Typically, RNG feedstocks are collected and processed in locations that are not contiguous to major oil and gas production areas. This requires separate clean up facilities and the construction of inter-connection pipelines to bring RNG to connect into the fossil natural gas distribution system. The distance between RNG feedstocks, production facilities, and volume users directly impacts the economics of transport. The concerns are not just pipeline access/interconnect, but creating scalable projects near pipelines to reduce that cost element, in addition to lowering interconnection costs. High inter-connection costs for distribution of RNG add to the cost to delivering feedstock and distributing fuel and limit the number of production sites that can be commercially feasible. The cost of building natural gas pipeline infrastructure varied between \$30,000 and \$100,000 per inch mile from 1993 to 2007. A 10 inch diameter pipeline would cost roughly up to \$1 million per mile<sup>74</sup>.

California has far higher interconnection costs than other states. The Coalition for Renewable Natural Gas quotes interconnection costs for projects outside California ranging from \$82,000-\$272,000 while California utilities have quoted costs in the \$1.5-3.0M range<sup>75</sup>.

Another challenge is scaling of RNG production - capital costs and equipment may scale, but feedstocks usually do not. The business case for a project can be hindered by a requirement to move a (low-value) feedstock too far to a production facility.

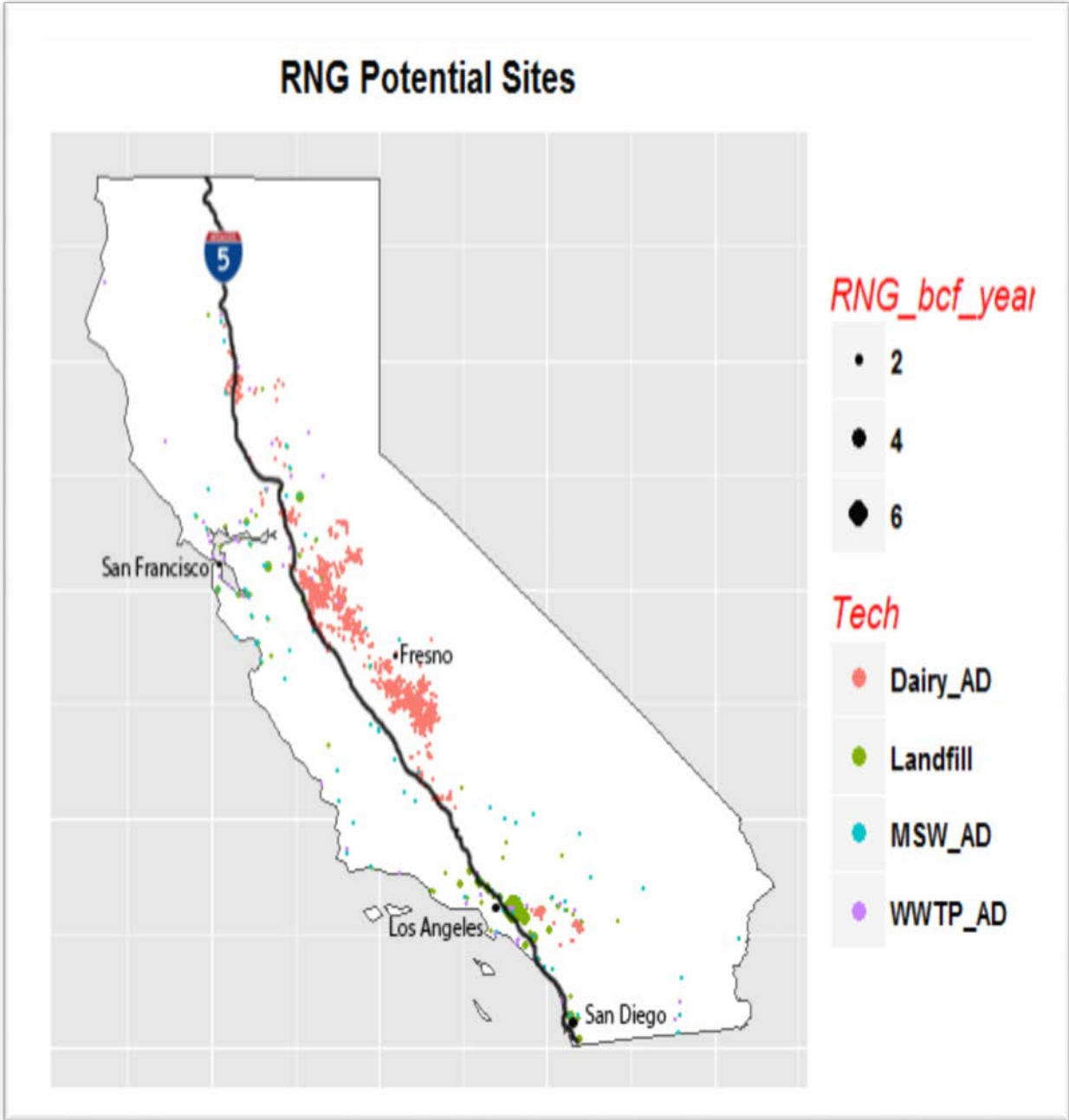

Figure 12. RNG Sites compared to trucking corridor

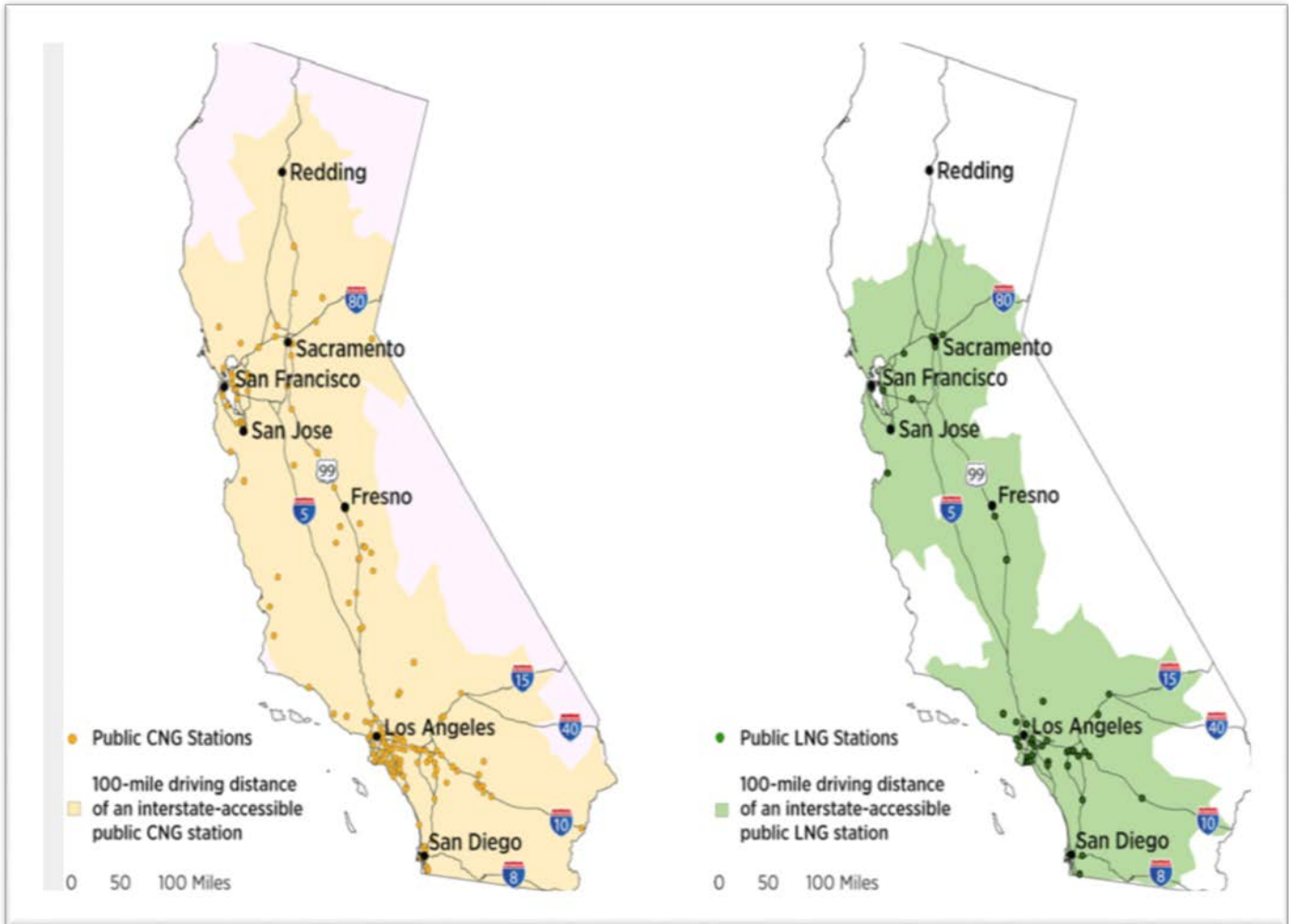

Figure 13. Public CNG and LNG locations in California.

RNG production process requires different production equipment than the fossil natural gas upstream pathway. Biofeedstocks are converted into biogas via anaerobic digesters or via thermochemical gasification facilities. The resulting biogas must be cleaned and upgraded into pipeline quality biomethane for transport in existing fossil natural gas pipeline systems. Once injected into the fossil natural gas pipeline system, RNG shares the same fossil natural gas infrastructure and equipment.

The details of the anaerobic digestion upstream process system are as follows: there are a series of processes through which microorganisms can convert biodegradable material to biogas including, bacterial hydrolysis, acidogenic bacteria, acetogenic bacteria or methanogens.



The infrastructure required to process biofeedstocks for anaerobic digestion includes the following kinds of digester technologies:

- Covered anaerobic lagoon digester
- Plug flow digester
- Complete mix digester
- Dry Digestion
- Single stage wet digester
- Dry fermentation
- Two-stage digesters

Thermochemical gasification is an alternative upstream pathway process that converts biomass to a syngas through partial oxidation at high temperatures. The syngas is produced through simultaneous processes of exothermic oxidation and endothermic pyrolysis with limited oxygen. The resultant gases are carbon monoxide, hydrogen, carbon dioxide, water, nitrogen, and methane. In addition, the process creates a variety of tars. Gasification is less mature technology and is continuing to develop as a process to produce renewable natural gas. There are several gasification technologies that are being used in the market currently including fluidized bed gasification, supercritical water gasification and hydrothermal catalytic gasification. Each requires a different set of infrastructure systems that differ from fossil natural gas.

Once RNG is produced, it can be delivered to vehicles either locally near the production facility or through long distance pipeline distribution such as the traditional fossil natural gas pipeline distribution system and on to LNG liquefaction plants or modular LNG or CNG fueling infrastructure.

The process for creating RNG is generally costlier than extracting fossil natural gas and therefore incentives such as carbon credits that price carbon pollution externalities are often needed to promote scalability. If volumes are not sufficiently large, the cost for RNG processing equipment to remove impurities (clean up) and to improve energy content (conditioning/upgrading) can be a barrier to commercial feasibility. It is technically feasible to utilize traditional natural gas pipeline infrastructure to transport RNG. A discussion of the technical aspects of biogas cleaning and upgrading is provided in more detail in Appendix A.

One aspect of the high costs for pipeline injection of RNG into the fossil natural gas pipeline system is the testing and verification required to meet pipeline owner specifications. California's interconnection costs for RNG feeder pipelines into the existing natural gas system pipeline system are generally more expensive than other states. California has strict environmental and safety standards for RNG injection (testing, mixing, compression, etc). Recently, the CPUC has instituted a biomethane monetary incentive program<sup>76</sup> which will provide \$40 million in funding to offset 50% of interconnection costs, up to \$1.5 million for each biomethane project built in California over the next five years. This program will enable in state RNG production but generally speaking, much of the RNG currently being used in California comes from out of state suppliers. Prior regulatory barriers have given out of state RNG facilities a head start in displacing in-state resources and working down the cost/learning curve for RNG generation.

### 3.3 HYDROGEN PATHWAYS

As discussed in sections 1.3.1-1.3.3 there are many options for producing hydrogen from fossil or renewable sources and delivering it to consumers as a transportation fuel. Hydrogen pathways are often categorized as “centralized hydrogen production with delivery”, where hydrogen is produced at large scale in a centralized plant, distributed to a refueling station via truck or pipeline, where it is stored and dispensed to vehicles, and “onsite hydrogen production,” where hydrogen is produced at the refueling station via electrolysis or methane reforming (Figure 14)

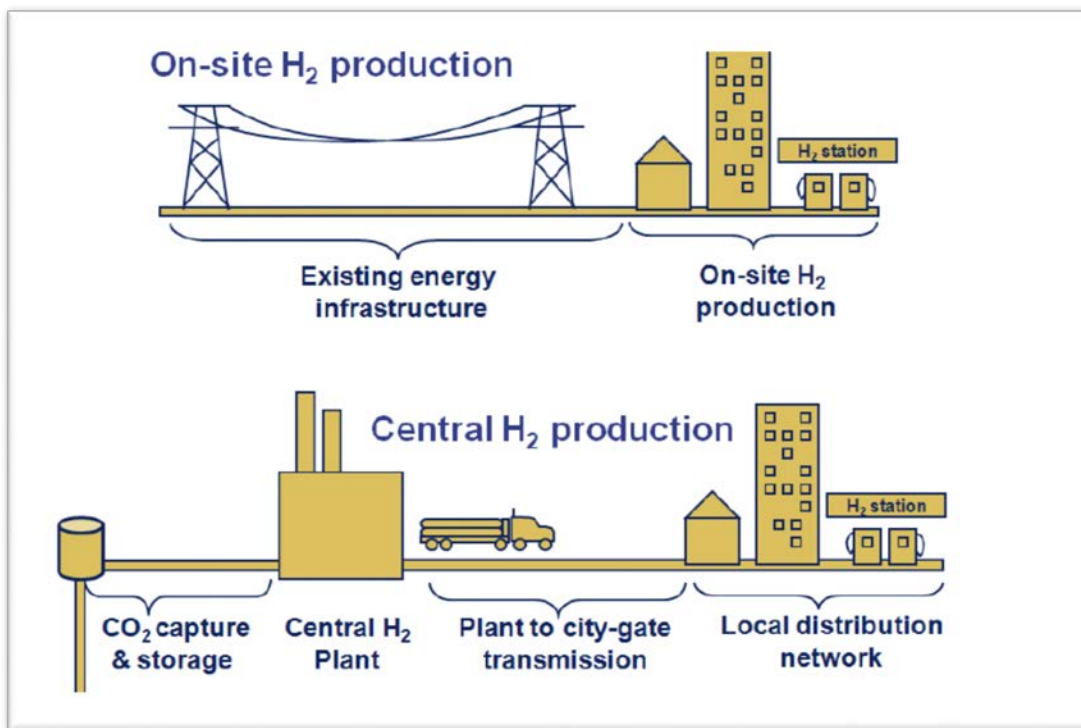

Figure 14. Centralized and onsite hydrogen infrastructure pathways for providing hydrogen transportation fuel.<sup>77</sup>

Important near term and long term hydrogen pathways are illustrated below, for hydrogen production from fossil and renewable sources and delivery via truck or pipeline.<sup>78</sup> We see that in the case of hydrogen production from natural gas, either at a central plant or onsite via steam methane reforming, there is potential overlap with the existing natural gas system (which is shown in pink). Particular pathways analyzed in our study are described in detail in Section 3.2 below.

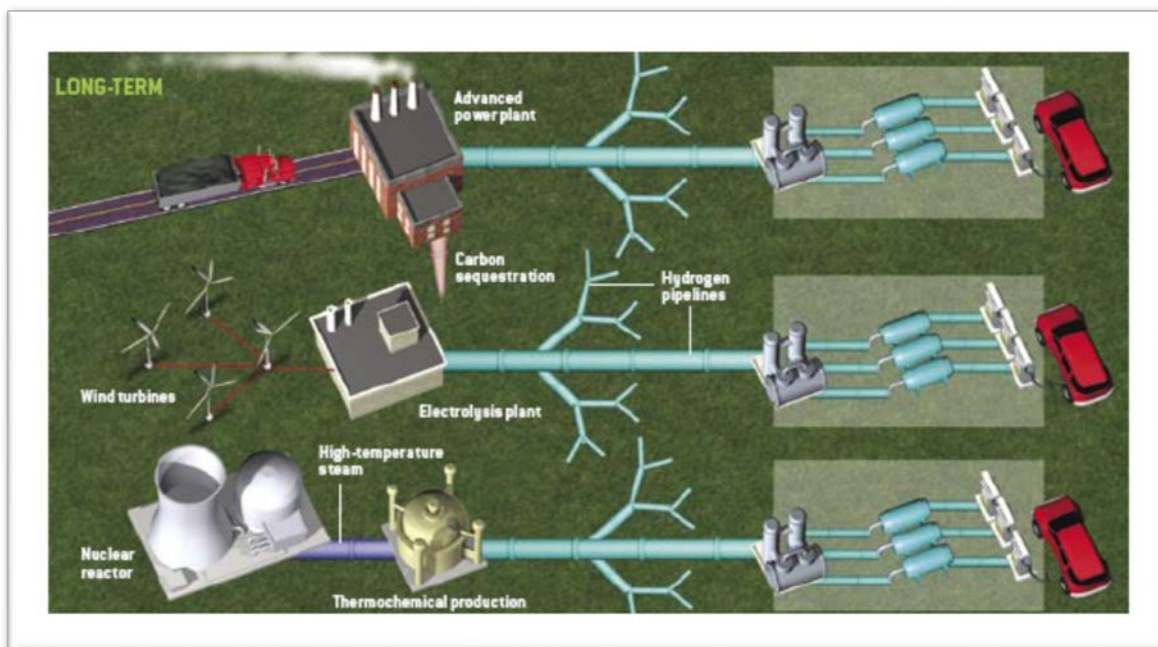
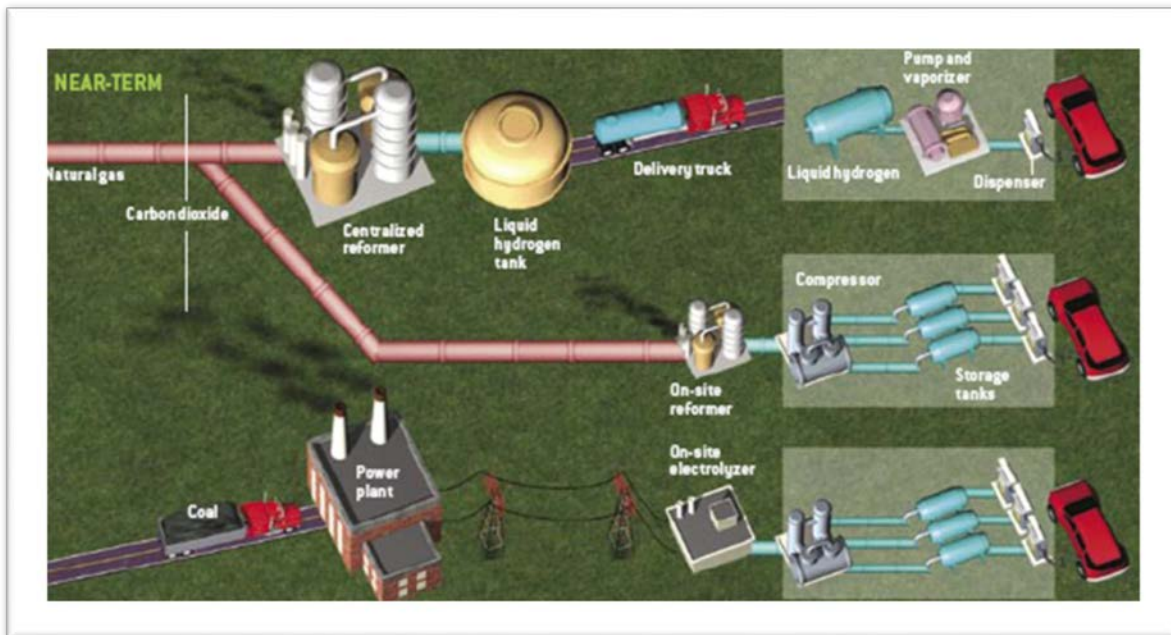

Figure 15. Near Term and Long Term Pathways for Hydrogen Production and Delivery to Vehicles. (It is also possible to deliver hydrogen via compressed gas truck.)

The layout of hydrogen refueling stations depends on the pathway as shown in simplified schematics in Figure 16a-e<sup>79, 80</sup> below. In section 3.2 we identify and analyze a key set of pathways where there is significant potential overall with the natural gas grid.

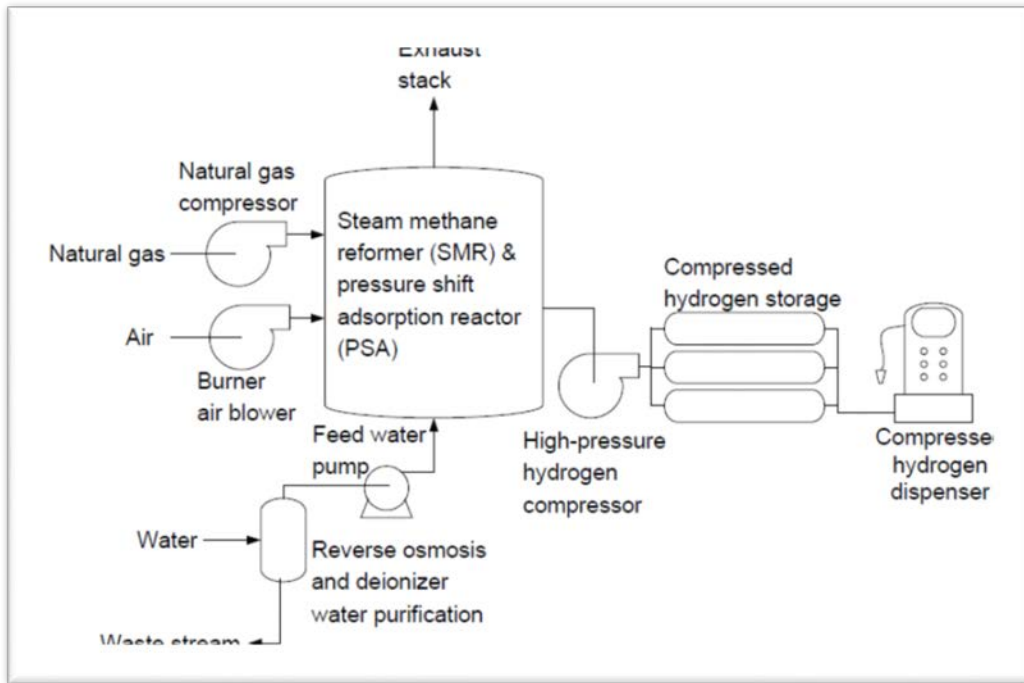

Figure 16a. Hydrogen refueling station with onsite steam methane reforming.

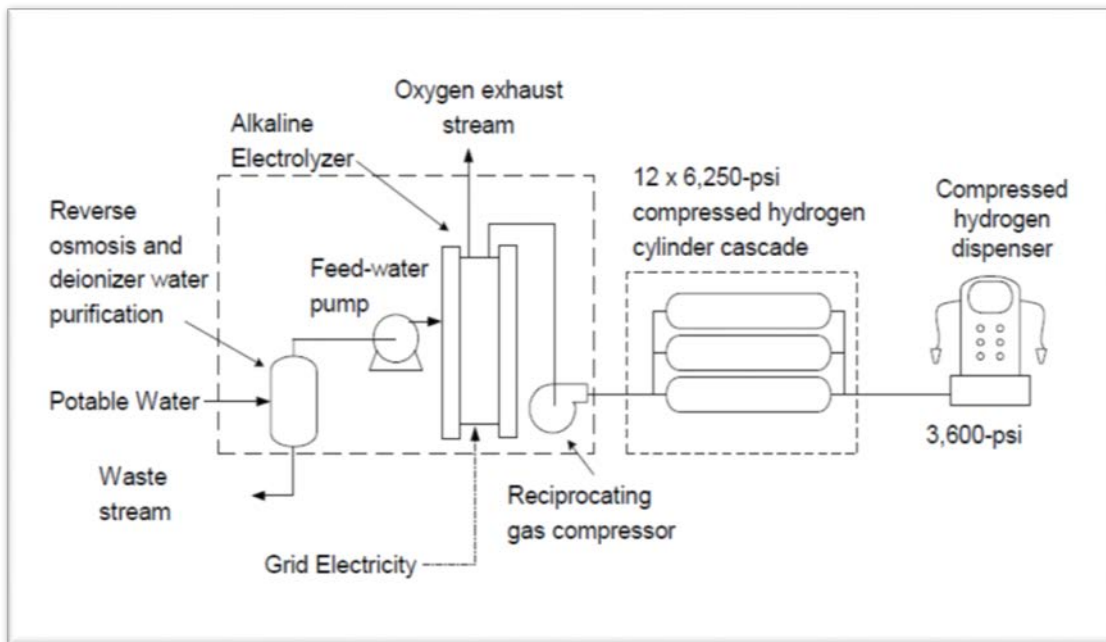

Figure 16b. Hydrogen refueling station with onsite steam methane reforming.

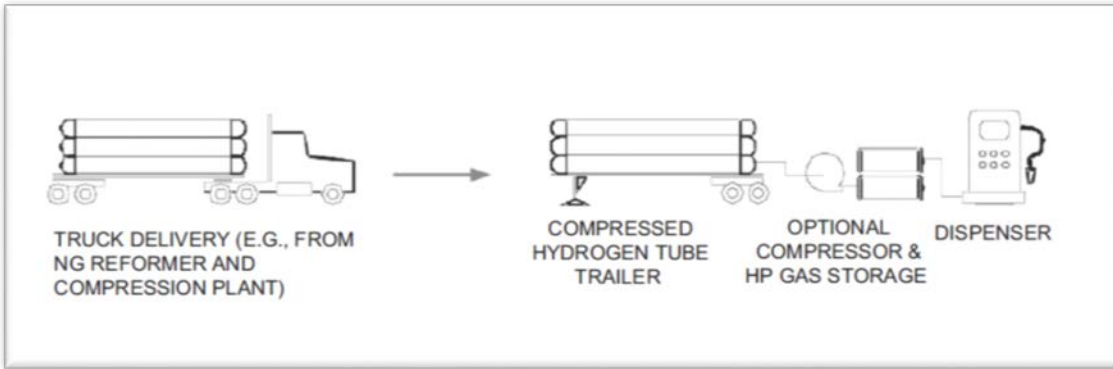

Figure 16c. Hydrogen station with compressed gas truck delivery

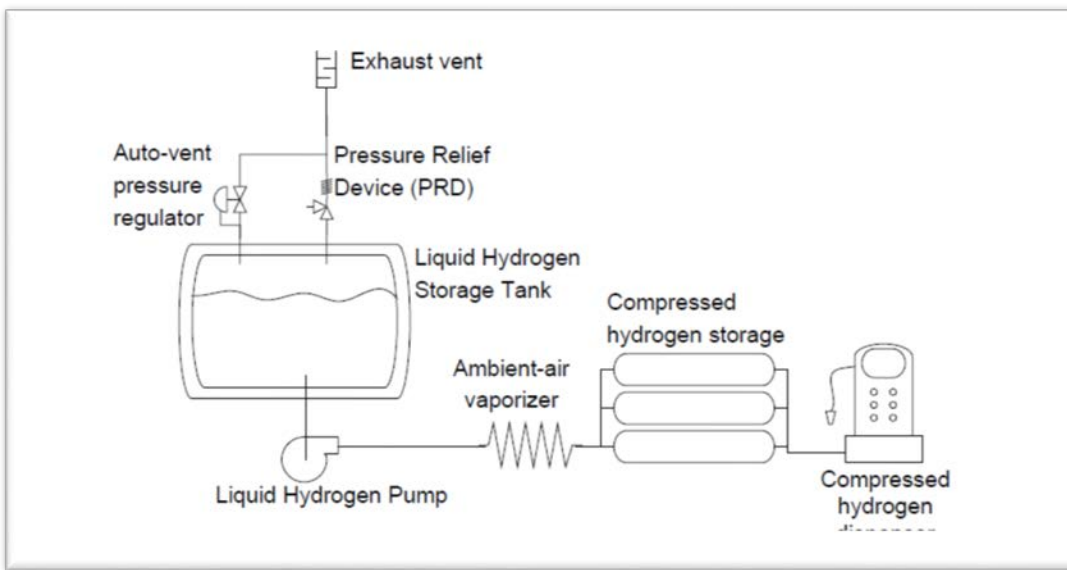

Figure 16d. Hydrogen station with liquid hydrogen delivery.

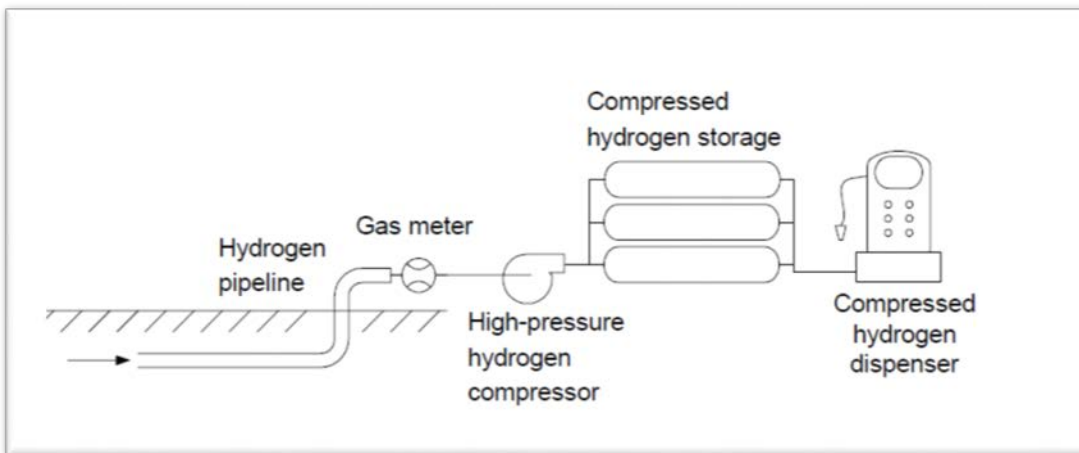

Figure 16e. Hydrogen station with hydrogen pipeline delivery.

## 4 RESULTS

### 4.1 RNG COMPATIBILITY WITH THE NATURAL GAS SYSTEM

We have assessed several questions germane to RNG use in California.

- 1) How much RNG is available and where is it located?
- 2) What are the major compatibility issues in producing high quality RNG to introduce into the existing fossil natural gas grid?
- 3) How much will it cost to purify and upgrade renewable sourced natural gas to integrate it into the existing fossil natural gas grid?
- 4) What changes have to be made in the natural gas fuel delivery system to accommodate RNG?

To use RNG utilizing the same distribution infrastructure as fossil natural gas, RNG must be cleaned and upgraded to match regulatory and commercial standards for fossil natural gas. In this section, we describe the nature of this clean up and discuss the commercial implications of its associated costs.

We present the full technical details of RNG composition, physical properties and NG infrastructure compatibility issues in Appendix A.

Biogas is the mixed, gaseous product of the decomposition of organic matter. When derived from municipal solid waste (MSW) in landfills it is commonly called “landfill gas” (LFG); when derived from anaerobic digestion (AD) of wastewater, animal manure or other organic waste it is commonly called AD gas or simply digester gas. Unlike conventional fossil natural gas which is composed mostly of hydrocarbons-70% or more methane (CH<sub>4</sub>) plus propane and butane-raw, biogas generally contains somewhat less methane, a significant amount of carbon dioxide (CO<sub>2</sub>), and lesser amounts of nitrogen, hydrogen, carbon monoxide and a variety of contaminants. Renewable natural gas (RNG) is made by processing biogas to remove contaminants, upgrading it to a standard of purity comparable to that of conventional fossil natural gas.

Some of the major differences between conventional natural gas and RNG are shown in Table 1.

Table 1. Difference between conventional natural gas and RNG

<b>Conventional Natural Gas</b>	<b>RNG</b>
95-98% methane*	95-98% methane*
Constituents are well understood	Constituents are not well understood
Utility and Interstate pipeline tariffs account for typical components	Utility and Interstate pipeline tariffs don't typically address all components
Methods for treating raw gas are proven and in-place	Methods for treating raw biogas can be costly

\*Post clean-up

Prior to upgrading, conventional fossil natural gas can contain 50-75% methane, although individual deposits can vary significantly. Similarly, methane comprises 45-65% of landfill and AD gas, although individual sites may contain higher or lower percentages. As a general rule, however, digester gas contains a higher proportion of methane than does LFG. Conversely, LFG tends to have higher concentrations of nitrogen and oxygen. Primarily due to air infiltration through the cover soil, nitrogen and oxygen levels must be reduced prior to pipeline injection (since they can affect combustion properties of the delivered fuel).

Carbon dioxide (CO<sub>2</sub>), hydrogen (H<sub>2</sub>), hydrogen sulfide (H<sub>2</sub>S), and ammonia (NH<sub>3</sub>) are also present in significant concentrations, both in conventional natural gas and in biogas. Gas cleanup and processing typically removes all or most of these impurities, as well as water vapor (the gas is usually saturated with water vapor) and various other contaminants.

LFG may contain more than 500 different contaminants, including a variety of sulfur compounds that are corrosive in the presence of water, halogenated compounds (e.g., carbon tetrachloride, chlorobenzene, chloroform) that produce corrosive combustion products, and organic silicon compounds (e.g., siloxanes from cosmetics) that form siliceous deposits in downstream applications, as well as amines, volatile organics such as benzene, toluene, ethylbenzene, and xylenes (BTEX), aldehydes, and ketones.

Microbial-influenced corrosion (MIC) can degrade the integrity, safety, and reliability of pipeline operation and is one of leading causes of pipeline failure in the oil and gas industry. Depending upon the starting biomass, a variety of microbial populations may exist in the resulting gas stream in RNG. MIC corrosion is caused by acids produced by bacteria. It is this acid which induces pitting in metal pipes. MIC can be especially prevalent in gas lines in which moisture has collected, or in wet gas systems.

Volatile metals such as mercury and arsenic may be present in RNG.

Particulate matter, such as dust, gums and biologicals, can be introduced into the gas distribution network from a variety of sources. In the case of landfill-derived renewable gas production, particulate matter may be carried along from the production process into the final landfill-derived renewable gas product. Particles can usually be removed by filters, sedimentation or centrifugal collectors.

Given all these potential contaminants, an initial cleanup or pre-purification step is needed before landfill gas (LFG) can be injected into the pipeline or used in any application involving combustion. AD gas contains many of the same contaminants although siloxane is less likely to be present in significant quantities. On the other hand, the composition of dairy manure produced biogas tends to be more consistent with less 'surprise' elements. Methane is typically as high as 74% but is generally reported as being around 60%.<sup>81</sup>

A requirement of transportation of natural gas by pipelines is that the gas must be free of liquid and solid particulate matter. The basis of this requirement is to minimize problems with operation and maintenance. Overall, the U.S. distribution system has more than 1,214,342 miles of main and 63,534,950 miles of service lines. Approximately 52% of the mains are metallic and therefore susceptible to corrosion, while approximately 39% of services are non-plastic and therefore are at risk for corrosion. In addition to piping, joints, valves, and regulators are also at



risk to contaminants. Beyond the metal components of valves and regulators, diaphragms, gaskets, o-rings, flange seals, quad seals, and valve seats can consist of thermoplastics, elastomers, natural rubbers, and synthetic rubbers which may be sensitive to gas impurities. Polyethylene has been shown by the Plastics Pipe Institute to be resistant to 90 percent sulfuric acid and microbial attack by sewage bacteria.<sup>82</sup> Renewable Natural Gas Specifications

A requirement of transportation of natural gas by pipelines is that the gas must be free of contaminants in order to minimize problems with operation and maintenance. Therefore, biomethane must not contain constituents at concentrations which would prevent or restrict the normal marketing of biomethane, be it at levels that would be injurious to pipeline facilities, or at levels that would present a health and/or safety hazard to Utility employees and/or the general public.

For biomethane to be accepted and transported in the Utility pipeline system, it must be periodically tested and monitored based on the biogas source. The Trigger Level is the level where additional periodic testing and analysis of the constituent is required. The Lower Action Level, where applicable, is used to screen biomethane during the initial biomethane quality review and as an ongoing screening level during the periodic testing. The Upper Action Level, where applicable, establishes the point at which the immediate shut-off of the biomethane supply occurs. Assembly Bill 1900 presents the main biomethane quality specifications as established by the Southern California Gas Company (Rule No. 30).<sup>83</sup>

Table 2. Biomethane Quality Specifications

<b>Constituent</b>	<b>Trigger Level mg/m<sup>3</sup> (ppm<sub>v</sub>)<sup>i</sup></b>	<b>Lower Action Level mg/m<sup>3</sup> (ppm<sub>v</sub>)</b>	<b>Upper Action Level mg/m<sup>3</sup> (ppm<sub>v</sub>)</b>
<i>Health Protective Constituent Levels</i>			
Carcinogenic Constituents			
Arsenic	0.019 (0.006)	0.19 (0.06)	0.48 (0.15)
p-Dichlorobenzenes	5.7 (0.95)	57 (9.5)	140 (24)
Ethylbenzene	26 (6.0)	260 (60)	650 (150)
n-Nitroso-di-n-propylamine	0.033 (0.006)	0.33 (0.06)	0.81 (0.15)
Vinyl chloride	0.84 (0.33)	8.4 (3.3)	21 (8.3)
<u>Non-Carcinogenic Constituents</u>			
Antimony	0.60 (0.12)	6.0 (1.2)	30 (6.1)
Copper	0.060 (0.02)	0.6 (0.23)	3 (1.2)
Hydrogen sulfide	30 (22)	300 (216)	1500 (1080)



Lead	0.075 (0.009)	0.75 (0.09)	3.8 (0.44)
Methacrolein	1.1 (0.37)	11 (3.7)	53 (18)
Toluene	904 (240)	9000 (2400)	45000 (12000)
Alkyl thiols (mercaptans)	(12)	(120)	(610)
<i>Pipeline Integrity Protective Constituent Levels<sup>ii</sup></i>			
Siloxanes	0.01 mg Si/m <sup>3</sup>	0.1 mg Si/m <sup>3</sup>	-
Ammonia	0.001 vol%	-	-
Hydrogen	0.1 vol%	-	-
Mercury	0.08 mg/m <sup>3</sup>	-	-
Biologicals	4 x 10 <sup>4</sup> /scf (qPCR per APB, SRB, IOB <sup>iii</sup> groups and commercially free bacteria of >0.2 micro	-	-

Notes:

- i) The first number in this table are in milligrams per cubic meter of air (mg/m<sup>3</sup>), while the second number () is in parts per million by volume (ppmv).
- ii) The Pipeline Integrity Protective Constituent Lower and Upper Action Limits not provided above will be established in the Commission's next AB1900 update proceeding. Until that time, Biomethane supplies that contain Pipeline Integrity Protective Constituents exceeding the Trigger Level, but lacking a Lower or Upper Action Level, will be analyzed and addressed on a case-by-case basis based on the biomethane's potential impact on pipeline system integrity.
- iii) APB-Acid Producing Bacteria; SRB-Sulfate-reducing Bacteria; IOB-Iron-oxidizing Bacteria

Based on this regulation (Rule No. 30), biomethane Constituent Testing is solely dependent on the biomethane source. Specifically, biomethane from landfills shall be tested for all Health Protective Constituents and the Pipeline Integrity Protective Constituents, whereas biomethane from dairies shall be tested for ethylbenzene, hydrogen sulfide, n-Nitroso-di-n-propylamine, mercaptans, toluene, and the Pipeline Integrity Protective Constituents. Other organic waste sources, including biomethane from publicly owned treatment works (i.e., water treatment and sewage treatment plants) shall be tested for p-Dichlorobenzene, ethylbenzene, hydrogen sulfide, mercaptans, toluene, vinyl chloride, and the Pipeline Integrity Protective Constituents.

#### 4.1.1 RNG TREATMENT AND PURIFICATION

Natural gas produced from traditional wells requires processing in order to be suitable for transport to end users. Some processing, oil and condensate removal, can take place at the well head but gas is typically piped through low pressure gathering lines to a processing facility for removal of natural gas liquids (NGLs), hydrogen sulfide, and carbon dioxide.

In order for biogas from dairy manure or landfills to be suitable for natural gas pipelines, it will need to go through one or more cleanup processes to remove high levels of unwanted components, thereby enriching the gas. Once the gas is sufficiently cleaned up, it can be

referred to as biomethane. Some level of quality control needs to be in effect to prevent uncleaned biogas or less than pipeline quality biomethane from entering the natural gas pipeline.

The collected biogas (either LFG or manure-based gas) must be treated to remove impurities before it enters the CO<sub>2</sub> removal process. Impurities include corrosive hydrogen compounds, low concentrations (parts per million) of non-methane organic compounds (NMOCs, including siloxane), and water. As stated in 40 CFR Parts 72 and 75, the level of hydrogen sulfide (H<sub>2</sub>S)-a corrosive, toxic, and flammable gas with unpleasant odor-must be reduced to less than 5 ppm for pipeline natural gas. Many well-established processes (e.g., absorption, adsorption, and chemical and thermal oxidation) are available for H<sub>2</sub>S removal from gas fluxes.

There are a plethora of methods and processes that can be used to remove contaminants in gas streams including systems based on membrane separation, adsorption and cryogenic distillation. A number of them are well established while others are not as developed. Some are appropriate for use in small scale and others are only economical at gas flows measured in Million Standard Cubic Feet per Day (MMSCFD) and where sulfur removal rates are measured in tons per day. The ability of a process to remove unwanted compounds is highly dependent on a number of factors and assessment of the true practicality of the method for a given application requires careful evaluation. These processes are described more fully in Appendix A but a brief summary is provided here for convenience.

#### **4.1.1.1 Biogas Cleaning**

Biogas produced from AD or TG processes must be cleaned to remove toxic or otherwise harmful constituents such as hydrogen sulfide, ammonia, volatile organic compounds, halides, siloxanes, particulates, and other contaminants). The technologies utilized include adsorption, biofiltration, water scrubbing, and refrigeration (Gas Technology Institute 2014, Ong 2014).

#### **4.1.1.2 Adsorption**

Adsorption systems are relatively simple, inexpensive, and low maintenance, but they can be sensitive to moisture and particulates. They can remove the majority of contaminants from biogas.

Biogas can be flushed through a porous material resulting in contaminant molecules binding to the adsorbent material. The materials should be highly porous with a very large surface area such that the biogas can react with. Several types of adsorbent can be used with renewable natural gas production.

Activated carbon is a highly porous powdered or granulated carbon that has a high affinity for many contaminants (ammonia is an exception). Activated carbon is relatively cheap and widely available. The activated carbon can be thermally regenerated back to its original state, but generally it is economically better to simply purchase more activated carbon. Certain chemicals can be added to the carbon to increase its adsorbent ability such as alkalines or oxide solids.

Zoelites are silicates with uniform pore sizes that can adsorb polar compounds such as water, hydrogen sulfide, sulfur dioxide, ammonia, and mercaptans).

Alkaline solids are used for acid gas removal and rely on chemical adsorption rather than physical adsorption.

Iron and zinc oxide particles (iron sponge) can remove sulfurous compounds by endothermic reactions which release heat. The reaction requires water, but excess condensation on the sponge bed can coat the active material reducing efficiency. Proper humidity is important for the functioning of these sponges.

Silica gels or aluminum oxide can remove siloxanes and water.

#### **4.1.1.3 Water Scrubbing**

Contaminants will dissolve in water and can be removed from the biogas stream. Since methane has a low solubility in water, methane tends to remain in gaseous form. The biogas can flow up through a vertical column of water moving downward. These scrubbers generally require minimal volume and can be cost effective at high flow rates. One problem with scrubbers is that oxygen and nitrogen dissolved in the water can be released into the biogas.

#### **4.1.1.4 Biofiltration**

Biofiltration uses various bacteria to convert hydrogen sulfide to sulfur or sulfate thus removing it from the biogas. In general three configurations can be used – bioscrubbers, biofilters, and biotrickling filters. The bioscrubber acts similarly to water scrubbers with the water sent to a reactor where the bacteria degrade the hydrogen sulfide. Biofilters contain a biofilm where contaminants from the biogas are absorbed and adsorbed and then react with the bacteria.

Biofilters suffer from acidification that can reduce the ability of the bacteria to degrade the contaminants. Biotrickling essentially combines bioscrubbers with biofilters to prevent acidification.

#### **4.1.1.5 Refrigeration**

Refrigeration removes water from the biogas by condensing the water vapor and capturing it in a trap. Since ammonia is highly soluble in water, refrigeration can remove significant ammonia from the biogas as well.

#### **4.1.1.6 Biogas Upgrading**

Biogas upgrading removes gas components such as carbon dioxide to increase the energy content of the fuel. Upgrading may not be necessary if the biogas is used locally for on-site vehicles or for electricity generation; however, if the gas will be injected into the natural gas pipeline, the energy content must meet pipeline injection energy content standards.

Popular upgrading technologies include pressure swing adsorption (PSA), chemical solvent scrubbing, and pressurized water scrubbing. In addition, new technologies have emerged that could promise lower costs and higher efficiencies. These include physical solvent scrubbing, membrane separation, cryogenic distillation, rotary water scrubbing, supersonic separation, and industrial lung. These technologies are briefly described below (Ong 2014).

#### **4.1.1.7 Pressure swing adsorption**

Pressure swing adsorption (PSA) removes carbon dioxide from the gas stream by adsorbing it onto zeolites or activated carbon under pressure. The technology also can remove volatile

organic compounds, oxygen, and nitrogen from the gas stream. PSA systems can achieve methane concentrations of 95-98% with recovery rates of 60-80%. The methane that is lost can be recovered by a second (or multiple) pass through the PSA.

Chemicals in solution such as alkaline salts and amines can chemically bind carbon dioxide and remove it from the biogas flow. After adsorption the chemicals can easily be regenerated for more usage. Amine systems can suffer from corrosion and complexity and may not be applicable to small scale production systems.

#### **4.1.1.8 Pressurized water scrubbing**

Carbon dioxide and hydrogen sulfide have significantly high solubility in water than methane. As mentioned in the biogas cleaning section, water can remove contaminants as well. The removal of carbon dioxide is more efficient at higher pressure so the biogas is compressed before entering a water column. Water scrubbers are often used because they are simple, have been proven, and have low capital and operating costs.

#### **4.1.1.9 Physical solvent scrubbing**

Other solvents besides water can be used to remove carbon dioxide. Organic solvents such as organic glycols have a higher carbon dioxide and hydrogen sulfide solubility and can reduce then volume of solvent and pumping needed. These scrubbers are operated similarly to water scrubbers with pressurized biogas. The solvent is regenerated by heating. The output biogas can be 95-98% methane with methane losses of 1-4%. Solvents are more expensive than water and the process requires more heat.

#### **4.1.1.10 Membrane separation**

Large pressure differential across a porous membrane can separate gases through a variety of mechanisms. The permeation rate of a particular gas depends on the pore size. The membranes are particularly sensitive to many gases such as water, hydrogen sulfide, ammonia, siloxanes, and volatile organic compounds, and these contaminants can degrade performance. Methane content can be increased with multiple membranes achieving 96% or better methane content in 2-3 membrane stages

#### **4.1.1.11 Cryogenic Distillation**

Methane condenses and freezes at lower temperatures than carbon dioxide. Cryogenic systems use high pressures and low temperatures to condense carbon dioxide and remove it from the methane stream. This method can produce 96-97% pure methane with only 1-3% losses. The systems have low maintenance but high capital and operating costs.

#### **4.1.1.12 Supersonic Separation**

A feed gas is injected into a tube a very high velocity causing low temperatures and pressures and condensing water and hydrocarbons into droplets. A high swirl centrifuge then separates the droplets from the gas. Work is underway to allow removal of carbon dioxide and hydrogen sulfide. The process is simple and reliable with potentially lower lifecycle costs than other processes. There should be vastly less downtime due to regeneration, membrane replacement, pumps issues, etc.

### 4.1.2 MONITORING

After RNG has been produced, cleaned, and upgraded it can be injected into the NG pipeline infrastructure. Since there are injection standards that determine the maximum contaminant levels and the minimum energy content of the gas, RNG must be monitored at injection to ensure that the gas meets the standards. Monitoring can be performed at regular intervals or in real-time. Real-time monitoring can ensure that problems with the cleaning or upgrading technologies are found quickly; however, real-time monitoring is significantly more expensive than monitoring performed at much longer intervals.

Figure 17 shows a schematic of the flow from feedstock through to end use for RNG. The various conversion, cleanup, and upgrading processes are included along with transmission and potential end uses. This roadmap only considers pipeline transmission and vehicle end use.

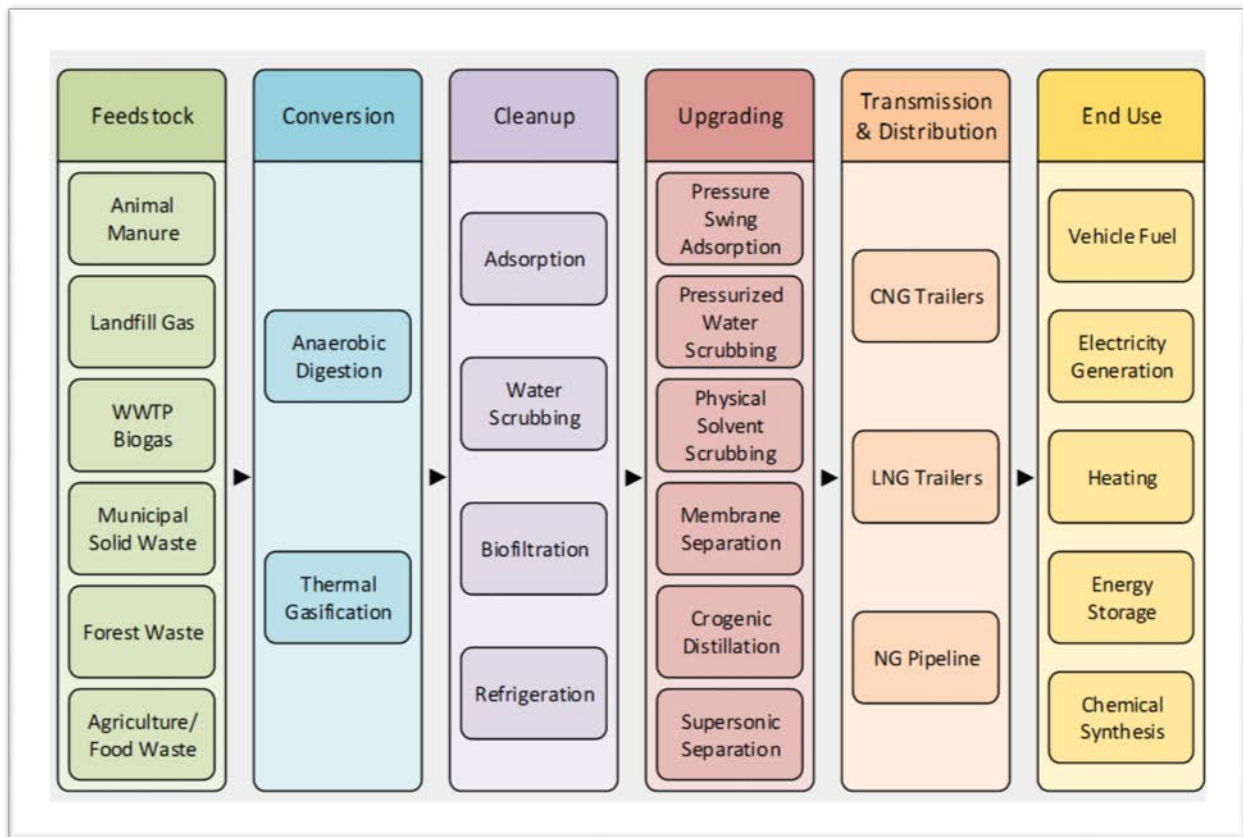

Figure 17. Schematic of RNG production from feedstock through to end use.

### 4.1.3 RNG POTENTIAL IN CALIFORNIA: UPGRADING AND INJECTION COSTS ASSESSMENT

Recent preliminary work by our team for CARB estimated that California has the potential to produce approximately 94.6 BCF per year (750 million gge per year)<sup>xii</sup> of renewable natural gas from dairy, landfill, municipal solid waste, and wastewater treatment plant sources. Clean up costs to get this RNG up to the specifications required for the use of the fossil natural gas infrastructure system are considered a barrier to wide spread investment in RNG in California.<sup>xiii</sup>

Policy makers are studying whether the additional cost barriers to cleaning and upgrading raw RNG gas to California's strict pipeline quality standards are hindering larger scale investment in RNG, especially for dairy farms that face more expensive logistical and capital costs for collecting and converting methane. In dairies, clean up and injection costs can represent up to two thirds of total required investment.

There are substantial sources of RNG in California that are commercially competitive with existing fossil fuel-based transportation fuels because carbon externalities are taken into consideration in the California market through existing programs such as the Low Carbon Fuel Standard (LCFS) and Renewable Fuels Standard (RFS). In a forthcoming study to the ARB, calculations show that RNG can achieve significant market penetration of 14 BCF of RNG into the transportation fueling infrastructure by the 2020s with California's Low Carbon Fuel Standard (LCFS) credits at current levels of \$120 per metric ton of CO<sub>2</sub>. Higher volumes are possible, as LCFS credits become more valuable and technological learning and scale economies lower upfront capital costs. The breakdown at an LCSF price of \$120 per metric ton of CO<sub>2</sub>, is 6.3 bcf from landfill, 1.5 from waste-water treatment, 1.75 from municipal solid waste, and 4.3 from dairy.

When considering the additional credit from the U.S. Federal Renewable Fuels Standard (RFS) RINs of \$1.78 per gallon of ethanol equivalent (\$23.32 per mmBTU), the volume is higher at 82.8 BCF per year. However, RNG only very recently been qualified to generate cellulosic biofuel D3 RINs which have been the most expensive RIN category. The price of D3 RINs have been extremely expensive as biofuel producers had failed to meet cellulosic biofuel production targets and thus elevated the D3 RIN price due to scarcity of qualifying fuel. Since the category of cellulosic fuel has expanded to include RNG, D3 RIN prices are starting to decline as the scarcity of qualifying fuel eases. Adding in credits from the Federal Renewable Fuels Standard of \$1.78 per gallon of ethanol equivalent all four sources of gas increases from 0 bcf to 82.8 bcf of which 50.8 bcf is from landfill and 5.6 bcf from waste-water treatment, 16.3 bcf from municipal solid waste, and 10.1 bcf from dairy.

The added cost differentials for various RNG pathways reflect differences in the level of specialized technology and infrastructure that is needed to bring the biogas to commercial fossil natural gas commodity quality pipeline standards. For RNG from dairies and municipal solid waste, separate, greenfield aerobic digester (AD) facilities and dedicated clean up equipment must be constructed to generate the biogas. These facilities are not co-located with the fossil

---

<sup>xii</sup> ARB study "The Feasibility of Renewable Natural Gas as a Large-Scale, Low Carbon Substitute"

<sup>xiii</sup> High resolution California resource assessment has been updated using county level data from the most recent California Biomass Collaborative's Resource Assessment (Williams et al, 2015).

natural gas system and specifically with the large scale natural gas processing systems for fossil gas clean up and therefore cannot take advantage of the fossil gas infrastructure. Because biogas facilities for upgrading are dispersed at multiple sites where the resource is based, small biogas sources are unable to take advantage of the economies of scale in the clean-up technologies that reduce the cost of fossil gas clean up.

Fossil natural gas consists mainly of methane but can have natural gas liquids and water associated with production systems. Fossil natural gas processing systems utilize separators at the production site to remove oil, condensates and water from the gas stream. At the next stage, a tower containing an amine solution is used to remove contaminants such as carbon dioxide, hydrogen sulfide, water vapor, helium, and oxygen. A nitrogen extraction unit is then used before a cryogenic or absorption method/fractionation is used to separate the methane from any natural gas liquids (NGLs) such as ethane, propane and butane. Some of these processes are also used in the clean-up of RNG. However, biogas differs from fossil gas by not having to remove oil or condensates from the gas but having higher concentrations of water and CO<sub>2</sub> to remove, making different technologies more appropriate for biogas clean-up. In addition, biogas from waste water and landfill gas also has other contaminants such as siloxane and vinyl chloride not present in fossil natural gas but that need to be removed before biogas can enter a carbon dioxide removal process.

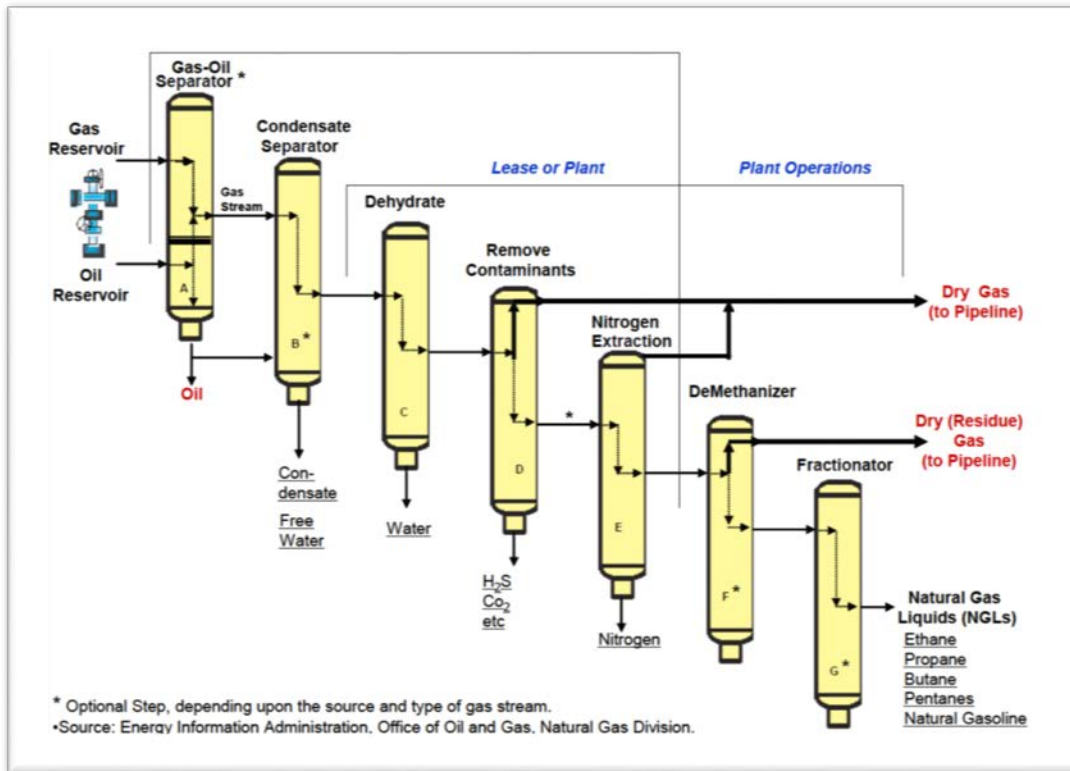

Figure 18. Generalized Natural Gas Processing Schematic from Electrigaz (2011).

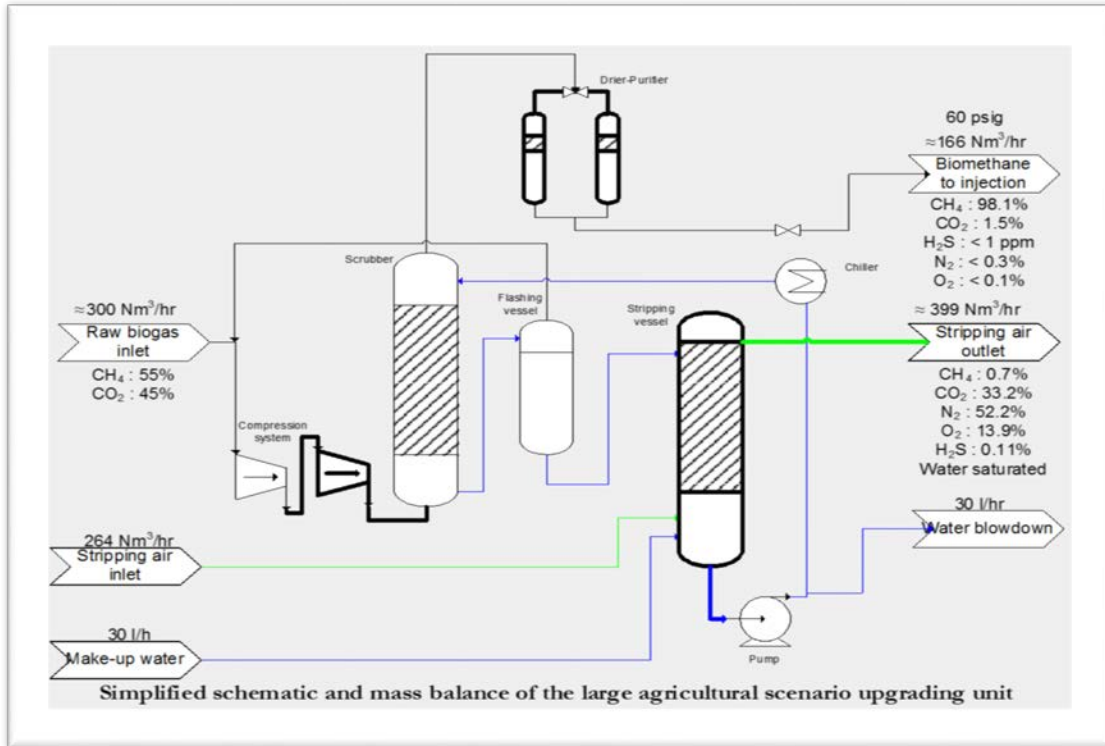

Figure 19. Upgrading schematic for dairy biogas from Electricgaz (2011).

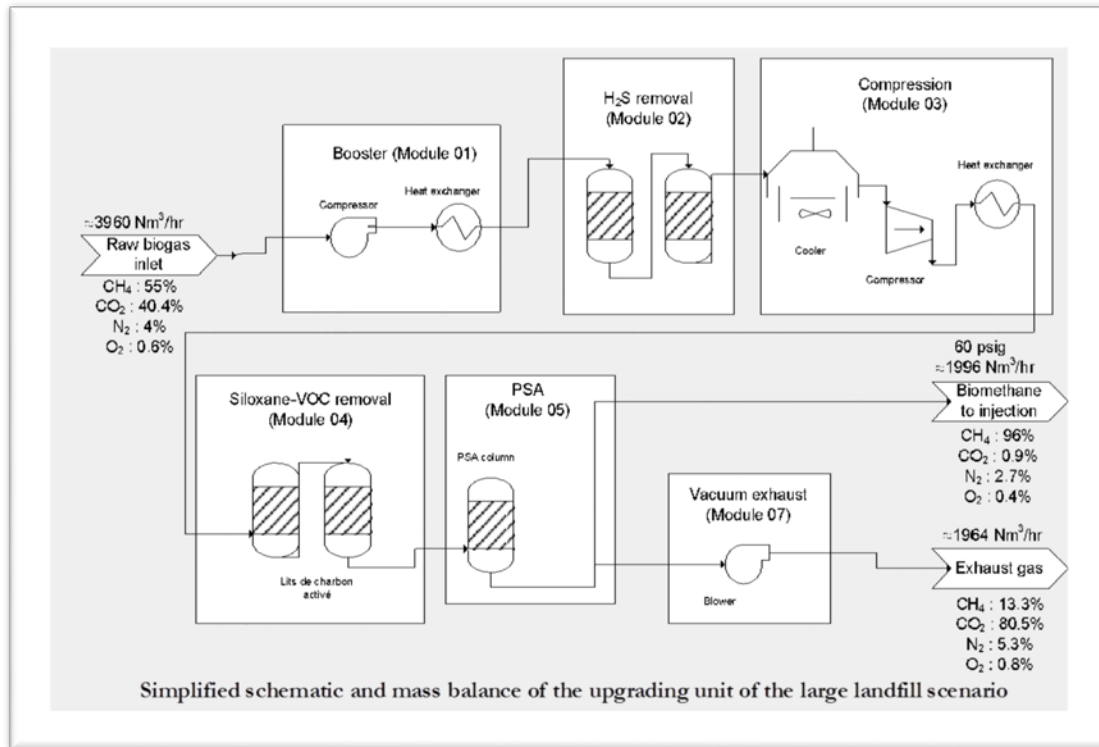

Figure 20. Upgrading schematic from LFG from Electricgaz (2011).



For landfill gas and WWTP, collection and upgrading equipment is needed that also does not overlap with the fossil natural gas fuel production and distribution system. Capital costs of for the separate AD infrastructure facilities are about a third of total capital requirements for RNG from dairy, other kinds of animal waste and MSW, while the other two thirds are upgrading and injection infrastructure costs. The gas from individual landfills and waste water treatment plants may require more upgrading or more expensive monitoring equipment than others and therefore clean-up costs may be higher than those assumed in this report in order to meet California gas quality standards.

The cost of upgrading biogas to RNG and the injection station for pipeline injection demonstrate significant economies of scale. The cost for biogas upgrading including an injection station is shown in Figure 21 with an estimate developed from Electrigaz (2011) and public comments to the CPUC. The Electrigaz study considered upgrading of biogas and injection of RNG into the existing natural gas pipeline in Ontario, Canada for three sizes of landfills, three sizes of dairy digesters, two industrial digesters and one size of waste water treatment plant. The costs include the clean-up to the pipeline specification shown in Table 2.

Each individual case had a unique configuration of clean-up/upgrading equipment. For the purposes of estimating the costs across the hundreds of sources in California, we did not analyze each site to provide a unique clean-up configuration recommendation for each site but rather fitted a cost curve to the data from the Electrigaz study to give a good estimate of the cost while taking into account the scale of the resources at a given location. In addition, we have modified the cost function to account for higher costs of interconnection in California based on industry comments to the CPUC. The cost of capital was adjusted to reflect a 12% rate of return. The curve fit is shown in Figure 21.

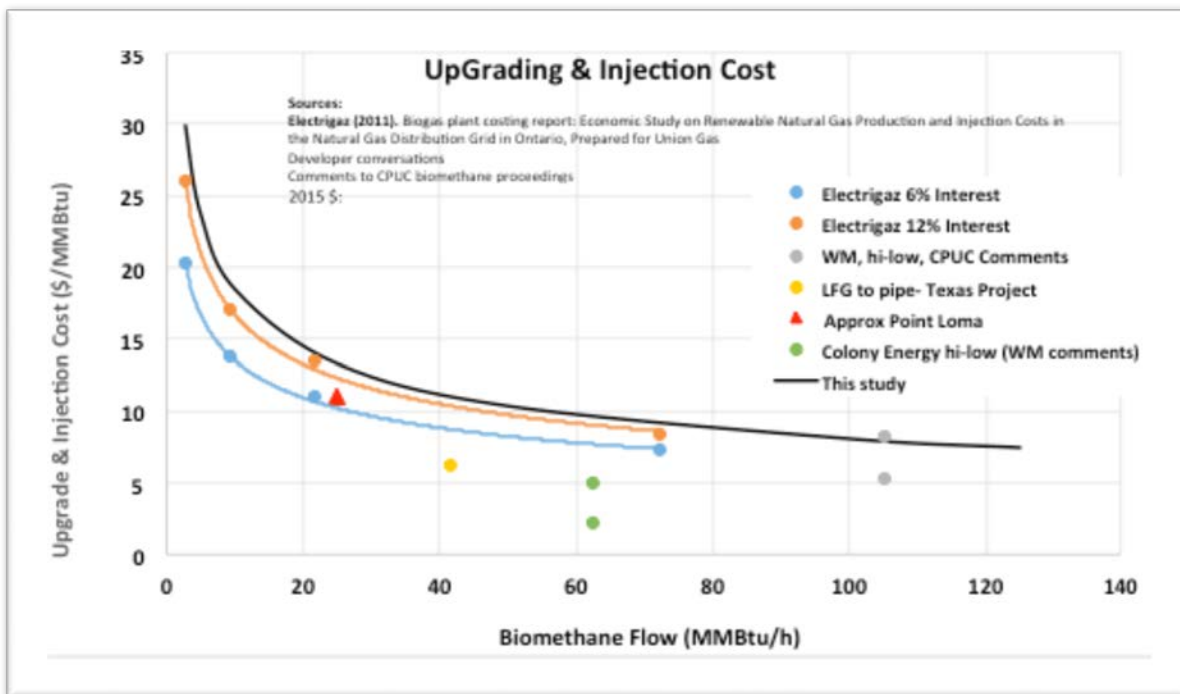

Figure 21. Upgrading and injection cost curve fit to the Electrigaz (2011) study.

Using a Canadian report for estimating the cost of upgrading biogas to pipeline quality raises some issues given California's stringent pipeline standards. The properties of the RNG in the study here are different than the California standard. Of note, the oxygen limit in the study is higher than California's standard (0.4 mol% compared to 0.1 mol% for the standard). These cost estimates were used due to lack of data at the time of analysis for the cost of meeting the California standard across a wide range of biogas resources and scales of operation.

Pipeline costs are estimated at \$1 million per mile based on updating the Region 9 natural gas pipeline costs for 2 to 8 inch pipelines found in Brown et al (2011) to 2014 dollars. The cost for each facility is then dependent on their distance to the pipeline. For example the fraction of manure resources versus the distance to a NG pipeline is shown for California dairies in Figure 22.

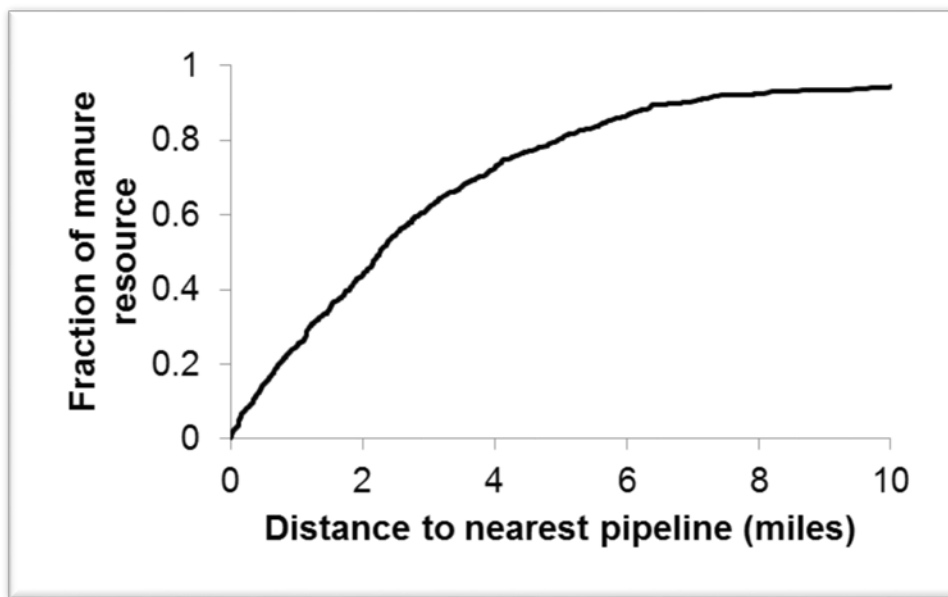

Figure 22. Distance to nearest pipeline from California dairies.

Once RNG is upgraded to standards compatible with commodity fossil natural gas it can be transported and converted to fuel using the same infrastructure as fossil natural gas. RNG supplies can utilize much of the same infrastructure as fossil natural gas networks, sharing the same vehicles, station equipment and pipeline transmission. In addition, there is the possibility that the RNG resource development time line is aligned with the current expansion of natural gas in transportation. The time frame for availability and opportunity exist in the current market, allowing for RNG and fossil natural gas networks to be developed simultaneously, each facilitating the other.

However, only some of California's RNG supply resources are close to existing fossil natural gas pipeline system and natural gas fueling stations and liquefaction plants. As Figure 22 shows, most of California's most commercially attractive landfill gas and waste water sites are located in Southern California, near pipeline and fueling facilities in the Los Angeles area. A smaller

concentration of landfill and wastewater sites is near northern California natural gas infrastructure. By contrast, many dairy sites are located in the central valley, relatively far away from natural gas pipelines and fueling hubs such as Los Angeles and the port of Long Beach or the I-5 interstate highway routes where many of the LNG fueling stations will be located. There are also several MSW sites that are distant to fossil natural gas infrastructure.

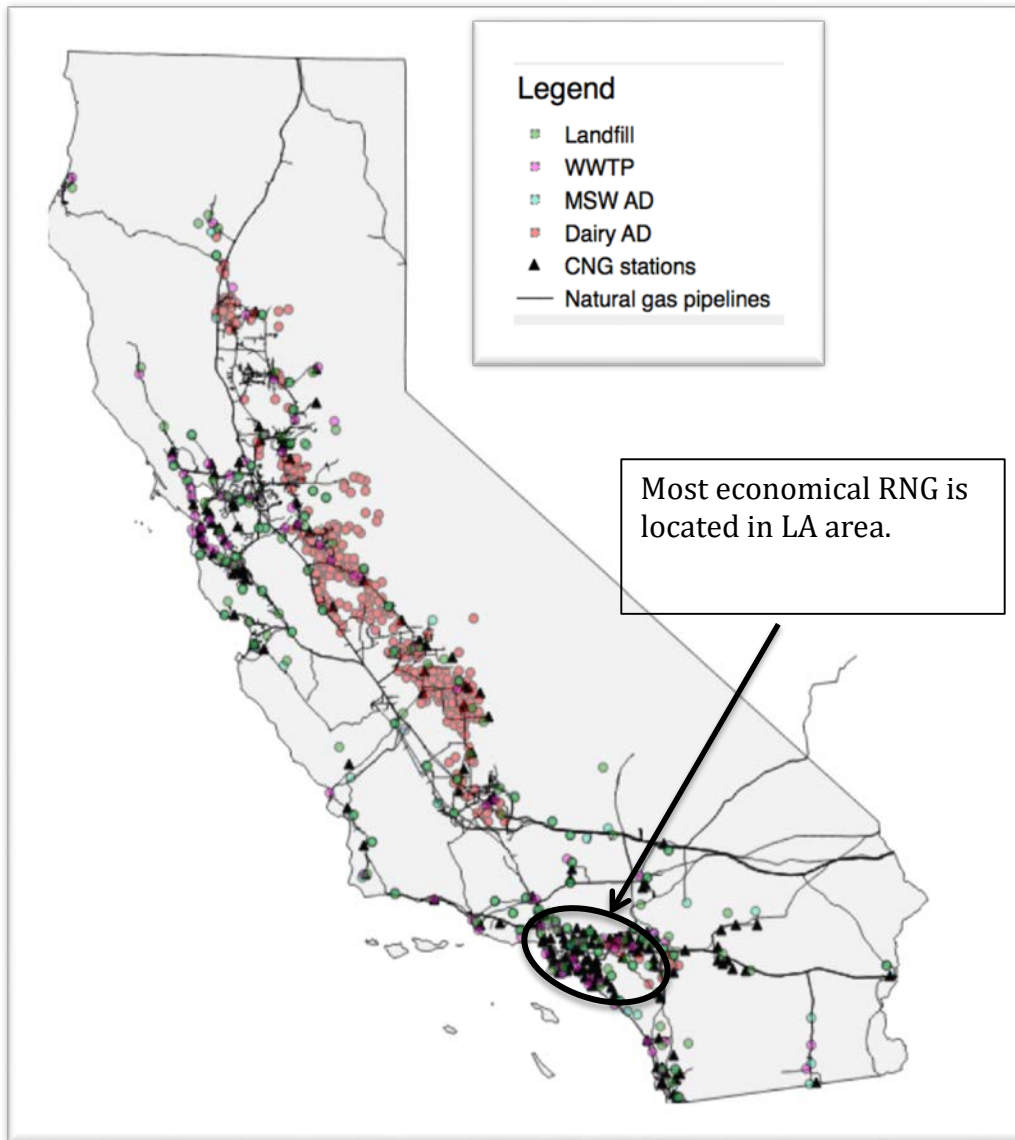

Figure 23. Potential RNG sources and natural gas infrastructure.

Table 3 summarizes the cost components for dairies, WWTPs, MSW, and forest or agricultural residues using TG. The cost components are feedstock, conversion, upgrading/injection, and distribution.

Costs for RNG fall in the \$10-40/mmBTU range with a large percentage of forest and agricultural residues, WWTP, and MSW falling in the \$10-20/mmBTU range. Fossil natural gas costs roughly \$2-5/mmBTU (Jaffe 2015) so the RNG costs are roughly 2-6 times higher.

Table 3. Summary of RNG cost components by pathway in \$/mmBtu

Pathway	Feedstock <sup>xiv</sup> (Scale Dependent)	Conversion (Scale Dependent)	Upgrading/Injection (Scale Dependent)	Distribution (Distance Dependent)
Dairy AD	-	9 to 25	11 to 23	<0.01 to 21
Waste water biogas	-	-	6 to 9	0.01 to 0.25
MSW AD	-7 to -15 <sup>xv</sup>	17 to 19	7.5	0.05 to 1
Gasification	2 to 9.5 <sup>xvi</sup>	11.5 to 12.5	~0.02 <sup>xvii</sup>	<0.01 to 4

#### 4.1.4 THE GHG BENEFIT OF BLENDING NG WITH RNG

In this section, we investigate the effect of RNG blending on the climate performance of NG as a fuel. We use the carbon intensity values below to test how the carbon intensity of fossil natural gas can be reduced by blending RNG.

Table 4. LCFS approved carbon intensities (g CO<sub>2</sub>e/MJ).

Fuel Pathway	Carbon Intensity $\frac{gCO_2e}{MJ}$
Diesel*	102.01
Gasoline*	99.78
Fossil CNG <sup>†</sup>	78.37
Landfill CNG <sup>†</sup>	46.42
WWTP CNG*	19.34
MSW CNG*	-22.93
Dairy CNG <sup>‡</sup>	-276.24

\* California Code of Regulation Title 17, §95488, Table 6. Carbon intensity for WWTP is the average of two WWTP pathways.

† California Code of Regulation Title 17, §95488, Table 7.

‡ Method 2B Application CalBio LLC, Dallas Texas, Dairy Digester Biogas to CNG.

<sup>xiv</sup> Feedstock costs for WWTP and dairy manures are assumed to be zero as systems are in place to collect the manures/biogas as part of the existing operation.

<sup>xv</sup> Based on regional average tipping fees from CalRecycle

<sup>xvi</sup> Lignocellulosic feedstock costs for agricultural residues, forest residues and woody MSW taken from Tittmann et al (2010).

<sup>xvii</sup> Upgrading included in Conversion for gasification technology. This estimate assumes \$1 million injection station for each facility.

The formula used for the calculation is that of simple weighted average

$$CI_{blend} = [CI_{ng} * (1 - \%)] + [CI_{rng} * \%]$$

Where  $CI_{blend}$  is the carbon intensity of the final blend,  $CI_{ng}$  and  $CI_{rng}$  are the carbon intensities of fossil natural gas and renewable natural gas respectively (shown in Table 4), and % refers to the percentage of RNG in the blend.

Table 5 shows carbon reductions achieved by different RNG types at each blend levels. Shading shows reductions under 25%, 26-50%, 51-75% and above 75%. The largest reductions can be achieved with Dairy RNG. Adding merely 20% of Dairy RNG to fossil natural gas is sufficient to completely eliminate the carbon intensity of fossil natural gas. Blends above 25% produce a net negative carbon intensity.

The next most favorable RNG is MSW which can achieve total carbon elimination at 80% blends and above, followed by WWTP, with a maximum reduction of the carbon intensity of 75% in its purest form. Finally, fossil fuel blended with landfill RNG will produce the most modest reductions, with a maximum reduction of about 40% when landfill RNG is used in its purest form.

Table 5. Carbon intensity reduction (%) achievable by blending levels (%) of each type of RNG

% Reduction from fossil CNG				
% RNG ble	Landfill	WWTP	MSW	Dairy
5%	-2%	-4%	-6%	-23%
15%	-6%	-11%	-19%	-68%
20%	-8%	-15%	-26%	-90%
25%	-10%	-19%	-32%	-113%
35%	-14%	-26%	-45%	-158%
45%	-18%	-34%	-58%	-204%
50%	-20%	-38%	-65%	-226%
55%	-22%	-41%	-71%	-249%
65%	-26%	-49%	-84%	-294%
75%	-31%	-56%	-97%	-339%
80%	-33%	-60%	-103%	-362%
85%	-35%	-64%	-110%	-385%
100%	-41%	-75%	-129%	-452%

Figure 24 shows at what point the blend could become zero-carbon. Dairy and MSW RNG offer the largest opportunity, with a 20/80 Dairy/fossil resulting in a zero carbon blend. A 80/20 MSW/fossil blend also results in a zero-carbon fuel. Although significant reductions can be achieved when blending fossil fuel with landfill and WWTP RNG, no zero-carbon status can be attained.

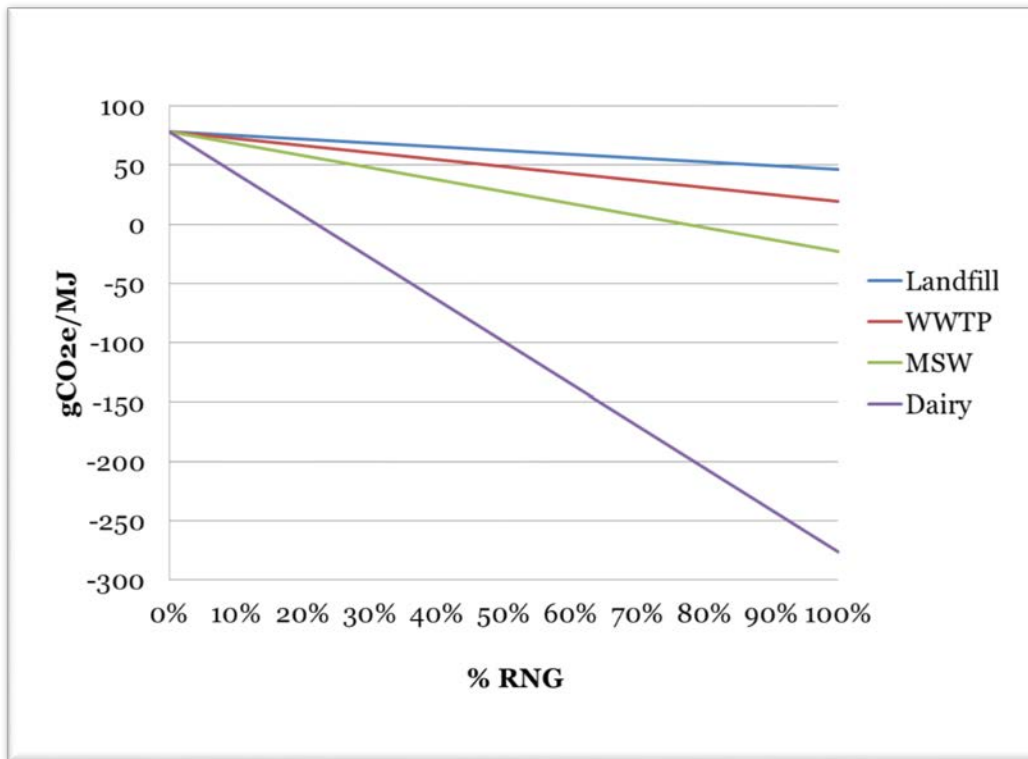

Figure 24. Change in CI values of fossil CNG when increasing the percentage of renewable CNG in the blend.

In summary, blending of Dairy and MSW RNG with fossil natural gas produces the most carbon benefits but blending landfill or WWTP with fossil natural gas produces more limited improvements in its climate performance.

## 4.2 HYDROGEN COMPATIBILITY WITH NATURAL GAS INFRASTRUCTURE

There is significant interest in the compatibility of H<sub>2</sub> with existing natural gas infrastructure for two main reasons.

Firstly, introducing H<sub>2</sub> created from renewable sources can serve to “green” the natural gas grid. Introducing renewable H<sub>2</sub> into the pipeline displaces fossil methane which has a greater climate impact when combusted. Secondly, allowing H<sub>2</sub> to be blended into the natural gas pipeline system could provide a reliable customer to which H<sub>2</sub> producers can sell their hydrogen gas without needing to arrange for storage and delivery.

We examine several key questions about the possibilities for natural gas infrastructure to serve as a “bridge” to hydrogen infrastructure in California.

- How much of the natural gas refueling system might be used or adapted for use with hydrogen? Are there viable strategies for a hydrogen infrastructure to evolve out of natural gas infrastructure?
- Which hydrogen supply pathways are likely to overlap with the natural gas supply system? Which hardware components of natural gas pathways (e.g. storage, pipelines, delivery trucks, compressors) might be compatible with hydrogen equipment?
- Does it make sense to “overbuild” natural gas infrastructure components (e.g. storage tanks or pipelines) to ensure future compatibility with hydrogen?
- What is the potential role of hydrogen blending into pipeline natural gas in a transition to hydrogen? Is blending “green hydrogen” (e.g. hydrogen produced from wind or solar electrolysis) into natural gas a good way to reduce greenhouse gas emissions?
- Which transportation markets are most promising for natural gas and hydrogen? How much do these coincide?
- What is the expected timing and scale for developing natural gas and hydrogen as transport fuels in California over the next 2 decades?
- What are likely supply pathways for producing and delivering hydrogen to vehicles in California? How might policies like California’s “renewable hydrogen portfolio” law SB 1505 impact the mix of hydrogen pathways over time?
- What are the prospects for natural gas truck fueling infrastructure to serve as a bridge to hydrogen?

### 4.2.1 WHICH TRANSPORTATION MARKETS ARE MOST PROMISING FOR NATURAL GAS AND HYDROGEN?

Current and potential transportation markets for natural gas and hydrogen are shown in Table 6. (Natural gas can also be used as a feedstock for liquid fuels or electricity generation, but these are not considered here.) As discussed above, the market for gaseous fuels is segmented. Current natural gas transport fuel development is focused on heavy duty long haul trucks fueled with LNG, as well as fleet vehicles fueled with CNG.

The current focus for hydrogen is light duty fuel cell passenger vehicles fueled with CH<sub>2</sub>, although a few dozen hydrogen buses and demonstration trucks are in operation. A recent roadmap explored the potential for medium and heavy duty applications over the next 7 to 15 years, focusing on Heavy-Duty Class 7-8 short haul/drayage trucks (ports) and Medium-Duty Class 4-6 delivery trucks<sup>84</sup>. Hydrogen long haul heavy duty trucks are seen as beyond 2030.

Compressed hydrogen/natural gas blends could be used in some of the same applications as CNG. These blends differ from pure hydrogen in that they could not be used directly in fuel cells, although they could be used in modified combustion engines and burners.

Table 6. Transportation Applications for Natural Gas and Hydrogen<sup>85</sup>.

<b>Application</b>	<b>NG</b>		<b>H2</b>	
	<b>CNG</b>	<b>LNG</b>	<b>CH2</b>	<b>LH2</b>
<b>LIGHT DUTY VEHICLES</b>	√		√	
<b>BUSES</b>	√		√	
<b>MED DUTY TRUCKS</b>	√		√	
<b>HEAVY DUTY TRUCKS</b>	√	√	√	•
<b>RAIL</b>		•		•
<b>MARINE</b>		√		•
<b>AVIATION</b>		•		•

√ = in use; • = proposed;

CNG = compressed natural gas; LNG = liquefied natural gas; CH2 = compressed hydrogen gas; LH2 = liquid hydrogen

#### 4.2.2 HYDROGEN INFRASTRUCTURE SUPPLY PATHWAYS

We consider several options for delivering H<sub>2</sub> to vehicles as fuel, each with varying degrees of overlap with the existing natural gas pipeline and refueling infrastructure.

Hydrogen refueling pathways are typically described as “centralized production with delivery” or “onsite production”. A candidate refueling station can either produce H<sub>2</sub> onsite or accept delivery of centrally produced H<sub>2</sub> from elsewhere. As discussed above, hydrogen can be produced from a wide variety of primary resources including fossil fuels and renewables.

Centrally produced H<sub>2</sub> can be delivered via truck or dedicated H<sub>2</sub> pipeline, or blended with natural gas and transported as a mixed fuel gas via natural gas pipelines. For this last option, natural gas/hydrogen blends can be used directly as a fuel gas (with hydrogen being a component of the mix), or pure H<sub>2</sub> can be recovered downstream at a separation station for use as fuel.

With onsite production, hydrogen is produced at the station via small scale steam methane reforming or water electrolysis (using electricity to split water into hydrogen and oxygen). Onsite production avoids the need to transport hydrogen from the central production facility to the station in a truck or pipeline.



### 4.2.3 INFRASTRUCTURE REQUIREMENTS AND OVERLAP FOR HYDROGEN AND NG SUPPLY PATHWAYS

We now sketch supply pathways and key equipment for natural gas and hydrogen transportation fuel infrastructures. This sets the stage to evaluate potential overlap for between these two fuel infrastructures, in terms of equipment compatibility, as well as in terms of geographic and temporal aspects of market development.

Three natural gas pathways are shown: CNG, central LNG, and onsite LNG. We compare these with six H<sub>2</sub> fuel pathways: on site H<sub>2</sub> production via steam methane reforming (SMR), central H<sub>2</sub> (Compressed Gas Truck Delivery), central H<sub>2</sub> (Liquid Hydrogen Truck Delivery), central H<sub>2</sub> (H<sub>2</sub> Pipeline Delivery), central H<sub>2</sub> (H<sub>2</sub> blended into NG pipeline and separated at station), central H<sub>2</sub> (H<sub>2</sub> blended into NG pipeline but not separated).

We show each NG and H<sub>2</sub> fuel supply chain in four sequential supply stages: primary feedstock, central fuel processing, fuel delivery, and the refueling station, which can include onsite production. (Note that, the onsite production pathway does not require a “fuel delivery” stage.)

Potential overlap between natural gas and hydrogen infrastructure pathways and equipment is highlighted in Figure 26. A green color is assigned to components common to hydrogen and natural gas pathways; items unique to the H<sub>2</sub> or NG system are colored red indicating there is no scope for shared infrastructure or adapted equipment; items in the NG pathway that potentially could be adapted, re-used or built for forward compatibility with H<sub>2</sub> are colored yellow.

All pathways begin with natural gas feedstock and all have some refuelling station equipment (such as a card reader, a convenience store or even a good location) that doesn't depend on the fuel. These components are common to both H<sub>2</sub> and NG and are colored green.

Central fuel processing equipment (e.g. a central NG liquefier or large SMR) that cannot be repurposed are colored red.

Yellow shading is used to highlight compressed natural gas equipment that could be repurposed to be compatible with hydrogen. This includes compressors, CNG gas storage and pipelines. We discuss these synergies below.

It is important to note that there is no overlap between LNG and hydrogen pathways. Unlike CNG stations, LNG stations do not have compressors or pressure storage vessels that might be overbuilt for future compatibility with compressed H<sub>2</sub>. Additionally, LNG storage is not suitable for liquid hydrogen storage. LNG is stored cryogenically at about -160 degrees C, while liquid hydrogen requires significantly lower temperatures -253 degrees C and thus is incompatible on a technical basis. Thus, all LNG equipment is colored red.

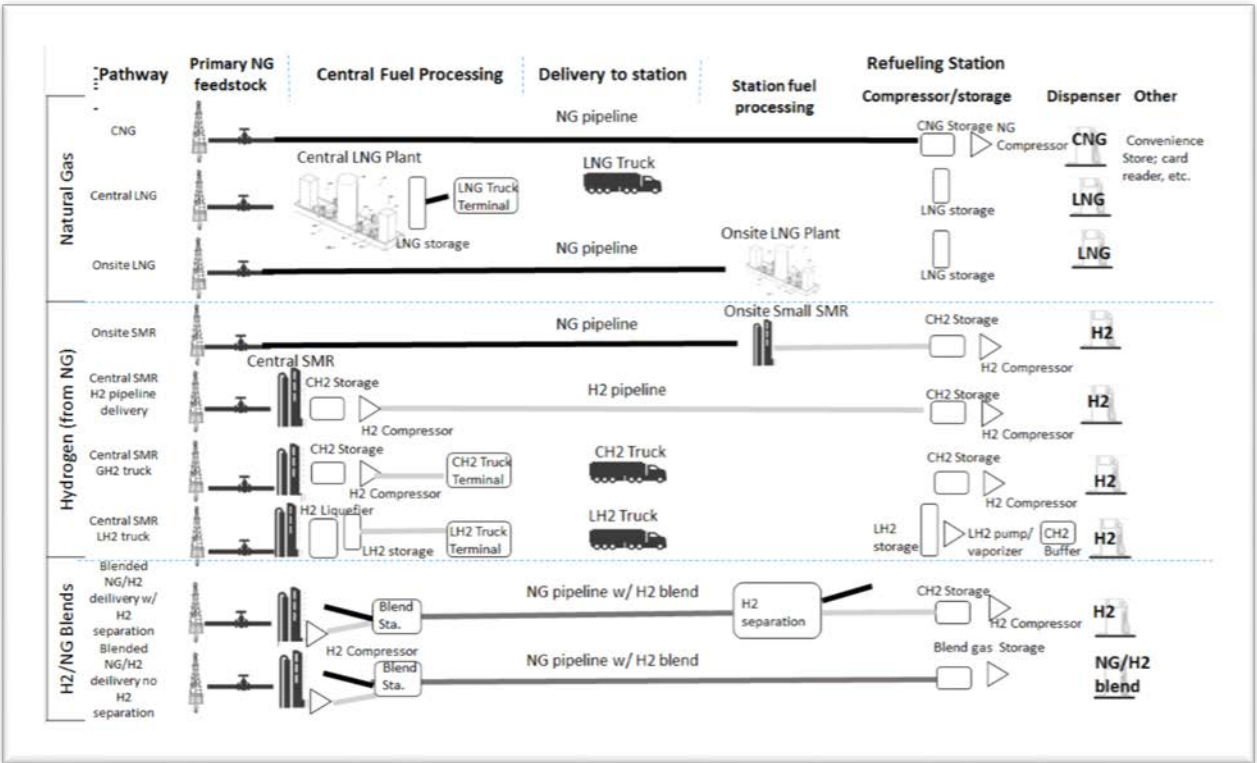

Figure 25. Fuel supply chains for natural gas (top 3 pathways), pure hydrogen (middle 4 pathways) and hydrogen/natural gas blends (bottom 2 pathways).

FUEL	Pathway	Primary feedstock	Central Fuel Processing				Delivery to station		Refueling station			
			Dryer/filter	NG Liquefier	LNG Cryo storage	LNG truck terminal	LNG Truck	Station fuel processing	Compression/Storage	Dispenser	Other	
Natural Gas	CNG	NG via pipeline				NG pipeline		Dryer/filter		NG compressor; CNG storage	CNG dispenser	Card reader, convenience store, etc.
	Central LNG	NG via pipeline	Dryer/filter	NG Liquefier	LNG Cryo storage	LNG truck terminal	LNG Truck			LNG storage	LNG dispenser	Card reader, convenience store, etc.
	Onsite LNG	NG via pipeline				NG pipeline		Dryer/filter; Small NG Liquefier (LNG in a box)		LNG storage	LNG dispenser	Card reader, convenience store, etc.
Hydrogen (from NG)	Onsite SMR	NG via pipeline				NG pipeline		Dryer/filter; Small SMR		CH2 compressor; CH2 storage	CH2 dispenser	Card reader, convenience store, etc.
	Central SMR H2 pipeline delivery	NG via pipeline	Dryer/filter	SMR; H2 compressor	bulk GH2 storage	H2 pipeline				CH2 compressor; CH2 storage	CH2 dispenser	Card reader, convenience store, etc.
	Central SMR GH2 truck	NG via pipeline	Dryer/filter	SMR; H2 compressor	bulk GH2 storage	GH2 truck terminal	GH2 truck			CH2 compressor; CH2 storage	CH2 dispenser	Card reader, convenience store, etc.
	Central SMR LH2 truck	NG via pipeline	Dryer/filter	SMR; H2 Liquefier	bulk LH2 storage	LH2 truck terminal	LH2 truck			LH2 pump/vaporizer; LH2 storage	CH2 bluffer storage	CH2 dispenser
H2/NG Blends	Blended NG/H2 delivery w/ H2 separation	NG via pipeline	Dryer/filter	SMR; H2 compressor	bulk GH2 storage; blend station to add H2	NG pipeline (w/blend H2)		H2 Separation equipment		CH2 compressor; CH2 storage	CH2 dispenser	Card reader, convenience store, etc.
	Blended NG/H2 delivery no H2 separation	NG via pipeline	Dryer/filter	SMR; H2 compressor	bulk GH2 storage; blend station to add H2	NG pipeline (w/blend H2)				Blend gas compressor; Blend gas storage	Blend gas dispenser	Card reader, convenience store, etc.

Figure 26. Compatibility of natural gas pathways with hydrogen. Items which are common between a hydrogen pathway and a natural gas pathway are colored green; items which are

unique to the H<sub>2</sub> or NG system are colored red indicating that there is no possibility for shared infrastructure or adapted equipment; items in the NG pathway that potentially could be re-used or built to provide forward compatibility with H<sub>2</sub> are colored yellow.

#### 4.2.4 COMPATIBILITY OF CNG REFUELING STATION EQUIPMENT WITH HYDROGEN

Our analysis of infrastructure compatibility focuses on CNG and H<sub>2</sub> station compression and storage equipment and natural gas pipelines.

Typically, at a hydrogen refueling station, hydrogen is compressed to 350-700 atmospheres in a specially designed compressor and stored in heavy-duty pressure tanks. The fuel is then dispensed to the vehicle at high pressure. Hydrogen compressors, storage tanks and dispensers are analogous to corresponding equipment at CNG stations; however, they require much higher pressures as well as special materials. Because the volumetric energy density of H<sub>2</sub> is only a third that of natural gas, H<sub>2</sub> is typically compressed to a higher storage pressure (350-500 atm) than CNG (200-250 atm) and thus requires a higher power compressor and a stronger storage tank plus a dispenser which can handle such pressures. Further, hydrogen can embrittle and degrade materials commonly used to store and transport natural gas and requires different, potentially more expensive, materials. Hydrogen storage tanks are made of stainless steel plus an interior polymer lining to protect against embrittlement and permeation. For example, the cost of compressed gas energy storage increases with pressure, so a 200-240 bar tank used for natural gas, costs less than a 350-700 bar tank used with hydrogen<sup>9, 86</sup>. Higher hydrogen storage pressure adds to compressor costs, as well. In addition, the differing physical properties of hydrogen and natural gas require different compressor designs.

It has been suggested that a CNG station might overbuild storage tanks or compressors to ensure forward compatibility with hydrogen. However, as we discuss below the additional costs and relatively short lifetime of the equipment could outweigh the benefit of forward compatibility with hydrogen. Also, the timing of market dynamics might make conversion less attractive. Typically, CNG equipment needs to be replaced every 15 to 20 years. Widespread hydrogen adoption in medium and heavy duty trucks is likely 7 to 15 years off, making an overbuild for CNG- H<sub>2</sub> compatibility less commercially attractive for today's CNG stations. In Figure 27 we compare the costs of compressed natural gas tanks **Error! Bookmark not defined.** and hydrogen storage tanks<sup>87</sup> used in refueling stations. Hydrogen storage is several times as costly as natural gas per unit of energy stored (\$ per gasoline gallon equivalent or \$/gge). The cost of compressed gas energy storage increases with pressure, so a 200-240 bar tank used for natural gas, costs less than a 350-700 bar tank used with hydrogen (Smith and Gonzales 2014; USDOE 2015, 2016). Higher hydrogen storage pressure adds to compressor costs, as well. In addition, the dissimilar physical properties of hydrogen and natural gas require different compressor designs

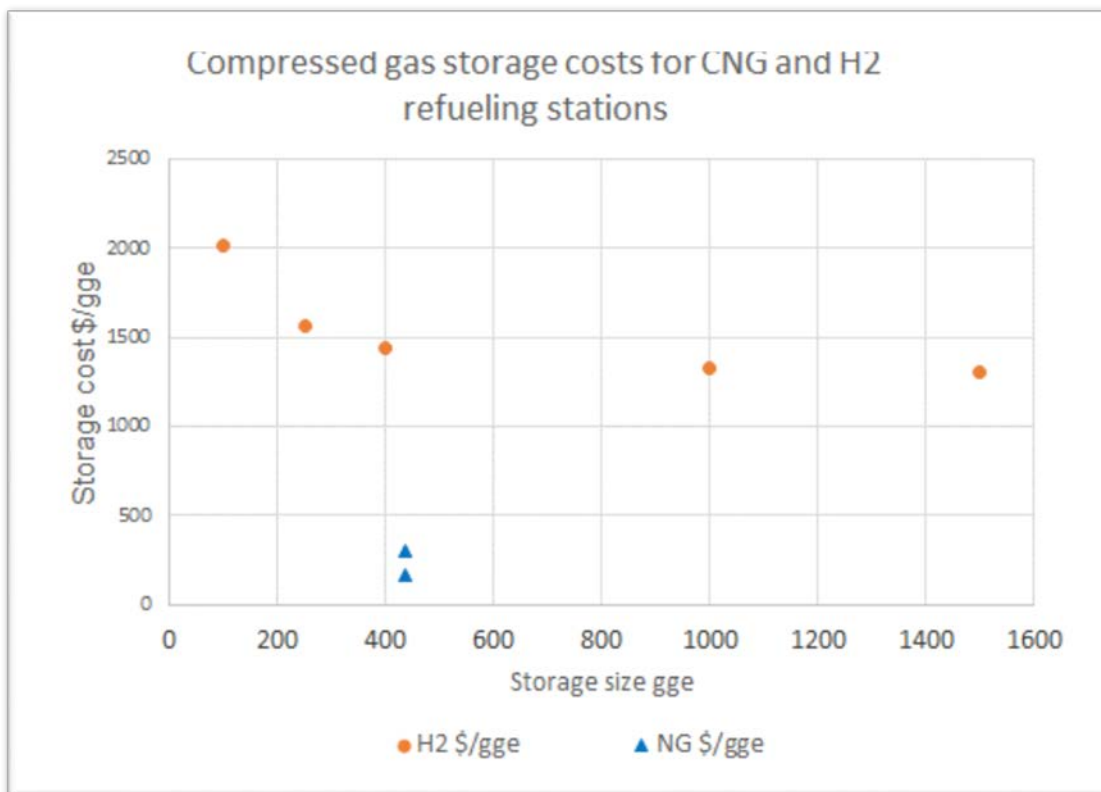

Figure 27. Cost comparison for H<sub>2</sub> and CNG refueling station compressed gas storage tanks versus tank size. The H<sub>2</sub> tank is 425 bar pressure and the CNG tank 245 bar.

Figure 28 compares the installed costs of natural gas and hydrogen compressors for typical refueling station pressures and flow rates. For reference, 100 gge per hour (gge/h) is a typical peak compressor flow rate for a 1000 gge per day hydrogen station (USDOE 2016), and 140-190 gge/h for a 1500-2000 gge per day CNG station (Smith and Gonzales 2014). These two stations would fuel equivalent numbers of fleet vehicles, since CNG vehicles are less energy efficient and require more energy dispensed at each fueling. Comparing costs for a 100 gge/h hydrogen compressor and a 170 gge/h CNG compressor, we see that the hydrogen compressor costs about \$500,000 and the CNG compressor about \$300,000. (Often two half size compressors are installed at refueling sites for added reliability (Smith and Gonzales 2014), in which case the total costs would be about 10% higher for each alternative.) Upgrading a CNG compressor for hydrogen might involve adding another compression stage (because of hydrogen's higher pressure), replacing valves and seals. Further, the design of a CNG compressor would not be optimal for hydrogen, because hydrogen has different physical properties from natural gas, such as density and viscosity.

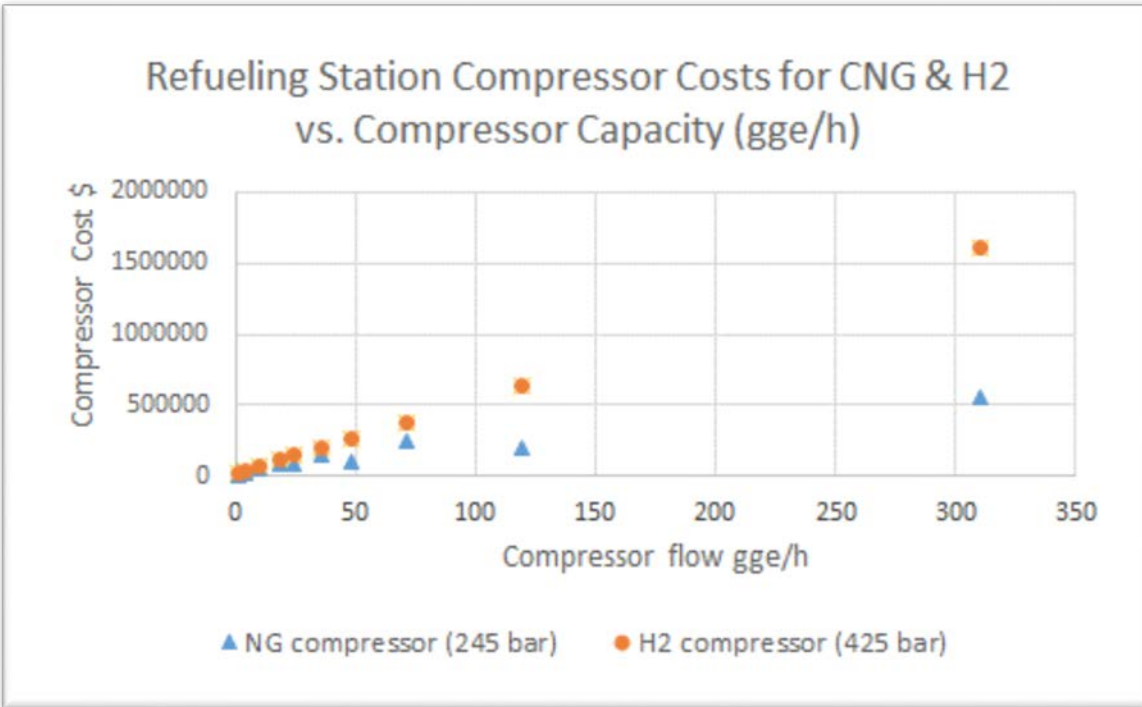

Figure 28. Comparison of refueling station compressor costs versus compressor flow rates for hydrogen compressors (to 425 bar) and natural gas compressors (to 245 bar).

The USDOE (USDOE 2016) has assessed the installed costs for hydrogen pipelines compared to natural gas pipelines. Although some costs were similar such as trenching for pipeline installation, they found overall H<sub>2</sub> pipelines were perhaps 10% more costly than similarly sized natural gas lines. This was primarily because hydrogen required costlier pipeline materials.

#### 4.2.5 BLENDING HYDROGEN WITH NATURAL GAS

Several potential benefits of blending hydrogen with natural gas have been suggested:

- Lower infrastructure transition costs by using the existing natural gas pipeline infrastructure to distribute NG/ H<sub>2</sub> blends instead of building a costly new dedicated hydrogen system.
- Reduced cost of storing hydrogen by introducing it into natural gas pipelines, rather than building dedicated hydrogen storage systems.
- Encouraged transition to pure hydrogen end-use systems by starting with a blend gas partly composed of hydrogen (hydrogen blended into natural gas).
- Reduced fuel gas GHG emissions by blending renewable hydrogen (for example, produced from wind or solar electrolysis) with fossil natural gas.

Using a hydrogen/natural gas blend is theoretically appealing as it might utilize existing natural gas equipment and infrastructure. However, utilizing a NG/ H<sub>2</sub> blend in the existing natural gas grid raises multiple questions.

- Will addition of hydrogen affect the integrity and safety of the natural gas delivery system? For example, will hydrogen “embrittle” pipeline or storage materials designed for use with natural gas?
- How will adding hydrogen affect the energy flow rate in a pipeline?
- Will natural gas end-use systems such as CNG vehicles, home appliances or heating systems still operate safely and efficiently with hydrogen blended in?
- What is the overall system cost for blending hydrogen?
- Does blending “green hydrogen” with natural gas offer major greenhouse gas benefits?

NREL researchers Melaina, Antonia and Penev<sup>70</sup> reached the following high-level conclusions in their assessment of NG/ H<sub>2</sub> blending:

- From a system level perspective, “blending hydrogen in relatively low concentrations (<5%–15% H<sub>2</sub> by volume), appears viable without significantly increasing risks. This level of blended NG- H<sub>2</sub> gases does not provide a threat or cause potential damage to end-use devices (such as household appliances), nor does it reduce overall public safety, or jeopardize the durability and integrity of the existing NG pipeline network.”
- “Although 5-15% hydrogen by volume is a typical value, the appropriate blend concentration may vary significantly between pipeline network systems and natural gas compositions and must therefore be assessed on a case-by-case basis.”<sup>72</sup>
- “More significant issues must be addressed for higher blends in the range of 15%–50%, such as conversion of household appliances or an increase in compression capacity along distribution mains serving industrial users. Blends above 50% face more challenging issues across multiple areas, including pipeline materials, safety, and modifications required for end-use appliances or other uses.”
- “Any introduction of a H<sub>2</sub> blend would require extensive study, testing, and modifications to existing pipeline monitoring and maintenance practices (e.g., integrity established a strong knowledge base on the management systems)”.

Several recent European projects and studies have assessed hydrogen tolerance of the natural gas grid. These studies stress that a system perspective must be taken considering both supply infrastructure and end-use systems. Findings of a recent workshop on Power to Gas and Hydrogen Blends<sup>72</sup> are summarized below:

- Future energy systems with growing Renewable Energy Source (RES) penetration will need to become more flexible, require more energy storage capacities, and will need more interaction between natural gas and electricity grids. In general, an energy network based focus (rather than separating electricity and gas) should be taken as further integration is expected in the future.
- Hydrogen can be a very effective storage medium, which is extremely important for the evolution of the energy system towards decarbonization, with high shares of intermittent renewable energy sources.

- In order to determine a safe hydrogen concentration limit for admixture in the natural gas grid, several research and standardization issues have been identified.
- No materials related showstoppers have been identified in the pipeline system, and case by case consideration of the limits of hydrogen addition to the gas grid was recommended. The current consensus seems to be that most parts of the natural gas system can tolerate mixtures of up to 10% by volume hydrogen. However, several areas need further investigation in order to understand the hydrogen tolerance e.g., cavern storage, surface facilities, storage tanks, gas flow monitors and gas analysis instruments.
- Depending on national or local conditions, the allowable limit may vary. A common, European wide understanding about how much hydrogen can be added to the overall gas network system is therefore necessary.
- There is also a need to provide guidance for injection of hydrogen in the natural gas networks in order to ensure operational safety. Public support (regulations, market, funding) may be required to identify all necessary changes to the gas grid.
- As safety is a key principle of the gas industry, focus should be placed on the establishment of sound engineering practices. Barriers identified include a fragmented and compartmentalized industry and insufficient collaboration between network operators. As the level of integration needed and number of technologies involved are high, long timescales before commercialization are expected. Therefore, a directed rather than market-led approach to setting the innovation agenda has been proposed by members of industry. The access to existing networks for demonstration projects should be incentivized.

The need for case by case evaluation suggests to us that, specifically, operators would need to take a comprehensive maintenance inventory of the entire natural gas transport system. Regulators would need to independently verify estimates to ensure compatibility of existing components and materials to hydrogen blends and to verify repairs to ensure that transmission and distribution lines would be safe for hydrogen exposure.

Other transportation related considerations are that hydrogen/natural blends can be directly used in internal combustion engines (ICEVs), but not in automotive fuel cells, which are significantly more efficient. If the H<sub>2</sub>/NG blend is directly combusted in an engine, the well to wheels energy efficiency benefits of consuming H<sub>2</sub> in a fuel cell are foregone. If the H<sub>2</sub>/NG blend is directly combusted in an engine, the energy efficiency benefits of consuming H<sub>2</sub> in a fuel cell are similarly foregone. If the blended H<sub>2</sub> can be separated downstream and used as fuel for a FCV, this significantly reduces well to wheel GHGs as well as SO<sub>2</sub>, NO<sub>x</sub>, and PM. Hydrogen blending provides a potential platform for a renewable credit allocated to NG with a specified % content of H<sub>2</sub>. This system would parallel the renewable energy credit system used in the electricity sector.<sup>70</sup>

Finally, hydrogen is significantly more expensive than natural gas per unit of energy, so blending hydrogen will increase the cost of the fuel gas. Additional costs must be weighed against the benefit of providing a more sustainable and low-carbon gas product to consumers.



#### 4.2.5.1 Limiting factors and safety considerations for hydrogen in the natural gas system

We now consider how using hydrogen blends might impact the different parts of the natural gas system including: end-use equipment (like home appliances, heaters and burners); long distance, high pressure transmission pipelines; local pipeline distribution in distribution mains and service lines; and separation of hydrogen from natural gas blends.

##### 4.2.5.1.1 LIMITING FACTORS FOR HYDROGEN CONCENTRATIONS: END-USE SYSTEMS

The maximum concentration of H<sub>2</sub> that can be blended into the NG pipeline network without adversely impacting end-users is a function of the composition of the natural gas, the type of end-user, and age of appliance in question.<sup>88</sup> As mentioned above, as a “rule of thumb”, H<sub>2</sub> can be safely blended into the NG pipeline network at concentrations of 5%-15% by volume, with increasing costs associated with higher concentrations of hydrogen<sup>70</sup>.

European nations have regulations that limit hydrogen in natural gas grids to concentrations of 0.1-12% by volume.<sup>89</sup> A recent German study examined hydrogen blend limits for diverse types of equipment used in various end-use applications and delivery components in the existing natural gas system. As shown in Figure 29, the allowable hydrogen blend fraction varies significantly for different applications. For example, compressors, gas turbines and CNG tanks require modification for hydrogen concentrations above a few percent, while natural gas pipelines can tolerate a higher hydrogen fraction. We believe it would be difficult to determine appropriate blend limits for a particular natural gas grid without detailed knowledge of all the equipment in the system.

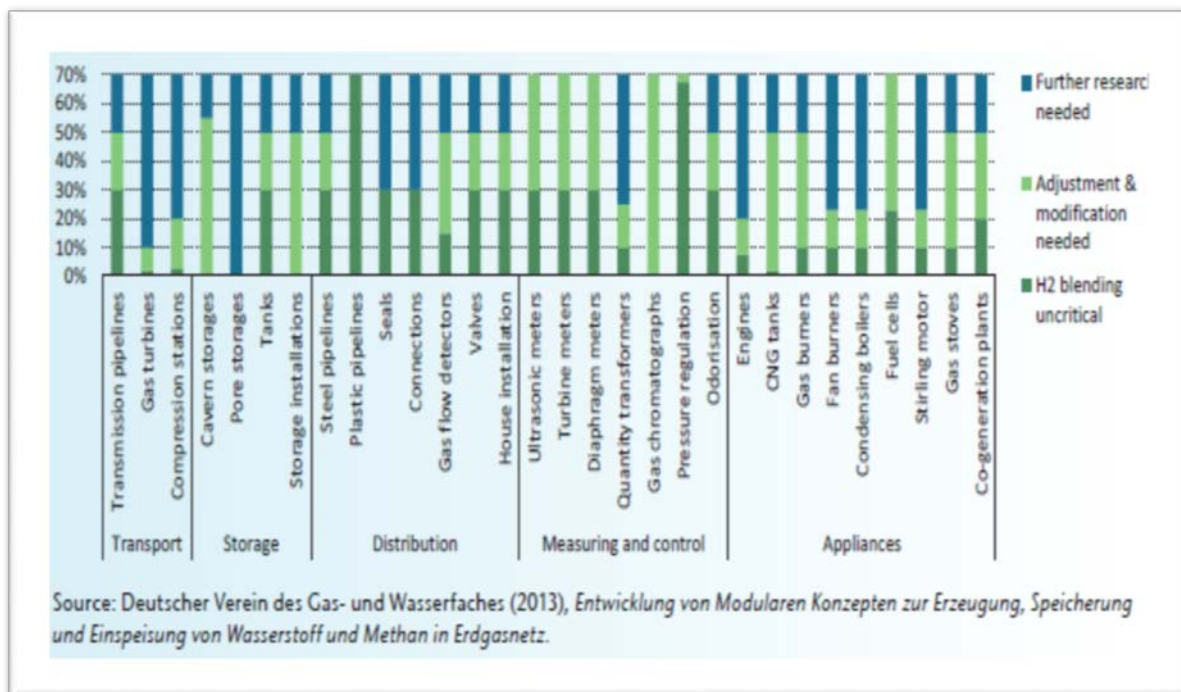

Figure 29. Limitations on the blend share of hydrogen by application.<sup>90</sup>



In theory, blending could be initiated at a very low concentration and gradually increased with time as retrofitting of supply and end-use equipment allows. It is technically feasible to retrofit natural gas burners to run on blends with any fraction of hydrogen, but above about 15% the costs and complexity of retrofits increases. (Moreover, this strategy would imply a series of multiple retrofits, which could be costly.) End-user infrastructure retrofitting is generally considered to be the largest obstacle to progressive blending of H<sub>2</sub><sup>70</sup>.

#### **4.2.5.2 Safety Considerations for Hydrogen Blends in Natural Gas Pipelines**

Introduction of H<sub>2</sub> into the natural gas system also has important safety considerations for natural gas pipelines. Considerations are different for “transmission lines”, “distribution mains” and “service lines”. We define these as follows:

“Transmission lines” refer to long distance, high pressure pipelines that can operate at up to 600-1200 psi. “Distribution mains” operate at 30-100 psi and deliver gas throughout a city. “Service lines” are small diameter, low pressure pipes (a few psig) running a short distance from the distribution mains to individual users. Long distance, high pressure transmission lines are often located in rural areas. By contrast, distribution mains and service lines generally run through densely populated, urban areas where more people are nearby. Service lines and distribution mains can be located in confined spaces (e.g. inside buildings or underground) which can pose a risk of building up flammable gas concentrations in the event of a leak.

A series of studies have assessed the risk of hydrogen blending for different types of pipelines at various concentration levels ranging from 10%-50% by volume<sup>81</sup>. The three major risk factors of H<sub>2</sub> in the natural gas pipeline network were identified: (1) gas buildup, (2) explosions in enclosures and (3) risk from transmission in case of pipe failure.

We discuss two key issues that impact safety: hydrogen embrittlement and hydrogen leaks.

##### **4.2.5.2.1 HYDROGEN EMBRITTLEMENT OF PIPELINES**

Blending hydrogen can materially degrade pipelines designed for natural gas, via hydrogen embrittlement. Hydrogen embrittlement is roughly analogous to water entering into a crack in pavement, freezing, and expanding the crack. Hydrogen is a small molecule that can force itself between molecules into microcracks in materials and causes damage by either expanding the crack under pressure changes (cracking/blistering) or by reacting with the material (hydride formation).

The rate of H<sub>2</sub> embrittlement is a function of the concentration of H<sub>2</sub>, the pressure, the operating conditions (how often pipeline is pressurized and depressurized), the pre-existence of cracks or imperfections in welds, the temperature in the pipeline system and importantly the pipeline material, which varies with the type of pipeline. Overall, the natural gas pipeline network is slightly over 50% polymer based and slightly under 50% based on steels. Polymers are much more compatible with H<sub>2</sub> than metals, but have a higher leak rate (see below). Polymers are used in distribution systems, but not for high pressure transmission. Some pipeline steels commonly used in natural gas transmission lines are subject to hydrogen embrittlement and some are not. Thus, a careful inventory of pipeline materials and quality of maintenance would be required for safe use of a hydrogen blend. (If a pipeline is purpose built for hydrogen it is possible to minimize the risk of embrittlement by proper selection of materials.)

High pressure interstate transmission pipelines are typically those most susceptible to hydrogen embrittlement and cracking due to their high pressures. However, the factors contributing to embrittlement should be evaluated for any natural gas system where hydrogen is introduced.

#### 4.2.5.2.2 HYDROGEN LEAKS DURING PIPELINE DISTRIBUTION

Due to its small molecular size, H<sub>2</sub> can more easily leak and escape the pipeline system than natural gas. Permeation rates of H<sub>2</sub> are four to five times higher than methane through polymer pipes and three times higher through steel and iron pipes. (In polymer pipes, most gas loss occurs through pipe walls. In metal pipes, loss occurs primarily at threads or welds.) The fact that hydrogen leaks through cracks in pipelines at a far faster rate than methane creates a differential between the relative level of safety of hydrogen vs methane in enclosed areas where accumulation can create material threats. Hydrogen will accumulate at a markedly faster rate in an enclosed space than methane, increasing its riskiness. The quantities of hydrogen leakage and the economic cost of H<sub>2</sub> leakage is less material than the important safety considerations<sup>70</sup>, particularly in confined and enclosed spaces where accumulation is possible: for example, if a leak existed in a service line that went through a confined space.

#### 4.2.5.2.3 MEASURING GAS FLOW RATES IN PIPELINES

It is important to meter the gas flow rate in pipeline systems. Meter accuracy is impacted by the introduction of H<sub>2</sub> into the pipeline; however, at less than 50% H<sub>2</sub> by volume, the accuracy of meters still falls within the acceptable range of 4%.<sup>70</sup> Overall, it is estimated that at under 50% concentrations, modifications to pipeline infrastructure would incur an additional 10% capital cost for equipment<sup>70</sup>.

### 4.2.5.3 Overall Risk of Hydrogen Blends in Natural Gas Pipelines

Recent studies of the overall risks for using hydrogen blends focusing on pipeline failures for transmission pipelines, and leaks and gas buildup for distribution mains and service lines.

#### 4.2.5.3.1 TRANSMISSION LINES

In one recent study the risk from 25% hydrogen blends vs. 100% natural gas in high pressure transmission lines is estimated using the following general equation:

“Risk = Frequency of Pipeline Failure × Probability of Ignition × Consequences of the Fire

“Compared to natural gas transmission pipeline explosions, there is a consistent tendency for the severity of the risk with hydrogen mixtures to shift spatially, increasing closer to the point of explosion and decreasing further from the point of explosion. Given this generic risk result for a transmission pipeline, site-specific risks would vary depending on the population density and distribution near the pipeline.” Figure 30 below shows the risk to an individual from a transmission pipeline using UK data for NG and NG/ H<sub>2</sub> blends as a function of distance from the pipeline and pipeline diameter. At 25% H<sub>2</sub> there is not a large difference in the risk.

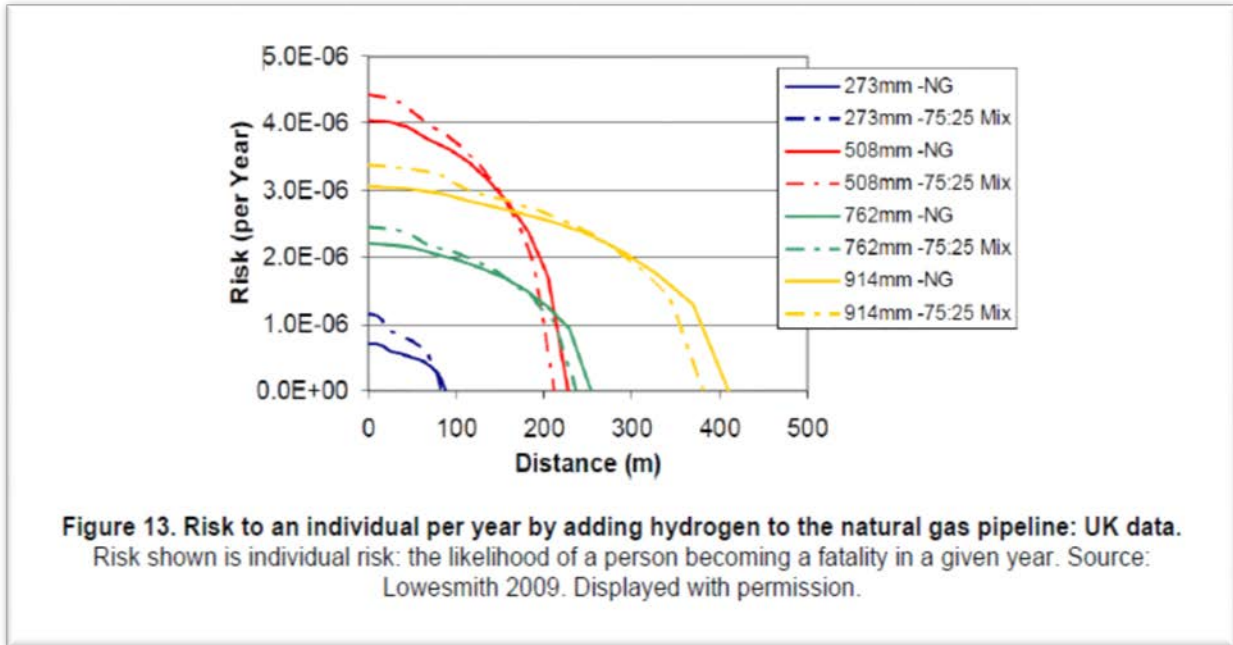

Figure 30. Risk to an individual per year by adding hydrogen to the natural gas pipeline: UK data.

#### 4.2.5.3.2 DISTRIBUTION MAINS AND SERVICE LINES

A recent analysis by the Gas Technology Institute (GTI) of hydrogen blends in distribution systems suggests that adding hydrogen to the natural gas pipeline network increases risk posed by leakage.<sup>91</sup> However, this increased risk is relatively small for service lines at concentrations of less than 20% hydrogen, but increases to moderate risk for distribution mains at less than 50% hydrogen. Much of the danger of introducing hydrogen into distribution systems stems from hydrogen accumulating in an enclosed space and igniting. This suggests that service lines should not exceed 20% H<sub>2</sub> due to being frequently confined where gases could build up. This concentration may be less stringent for distribution mains that are not as confined.

Again, many different factors influence risk estimates, and actual risks can vary widely from location to location.

#### 4.2.5.3.3 EXTRACTING PURE HYDROGEN FROM H<sub>2</sub>/NG BLENDS

If the intention of introducing H<sub>2</sub> into the natural gas system is to recover the hydrogen at some point downstream, then hydrogen must be separated from the blend. Three types of technologies could be used for separation: pressure swing absorption (PSA), membranes, or electrochemical pumping. Pressure Swing Absorption is the most widely used commercially, so we focus on this option. The pros and cons of the other separation methods are discussed in Melaina et al. 2013<sup>70</sup>. **Error! Bookmark not defined.**

Separation via PSA typically is done at a station. Separating hydrogen from a blended pipeline is an expensive procedure, though the costs can be reduced if the PSAs are placed strategically at “step down” facilities where the pressure of the natural gas delivered via a long distance, high pressure pipeline is reduced for local distribution within a city. Step-down facilities are typically located near the “city gate”.

Pressure Swing Absorption occurs in three stages. First, the mixed gas (H<sub>2</sub> and CH<sub>4</sub>) is pushed through a filter bed at 300 psi. The CH<sub>4</sub> is retained by the bed and the H<sub>2</sub> passes through. Once the bed is full, it is removed from pressure releasing the CH<sub>4</sub>. Finally, a small amount of H<sub>2</sub> is filtered backwards through the unpressurized filter bed to remove any remaining CH<sub>4</sub> which is then recompressed and injected back into the line. PSA extraction at 300psi can cost between \$3.20/kg of H<sub>2</sub> and \$8.20/kg of H<sub>2</sub> with a 10% H<sub>2</sub> mixture. (This is a significant add-on to the cost of hydrogen, which might cost \$1-2/kg to produce and a few \$/kg to transport by pipeline. See Figure 5.) However, if the separation process is executed at a stepdown facility where recompression of the gas is not necessary, the costs of separation can range from \$0.20 to \$1.30/kg of H<sub>2</sub> with a 10% mixture<sup>70</sup>. These separation costs are simply the cost to recover the hydrogen that has already been introduced into the pipeline. They do not include the cost to produce and blend in the hydrogen upstream or to transport the gas by pipeline from the blending site to the separation station.

#### 4.2.5.4 The Potential Greenhouse Gas Benefits of Blending “Green Hydrogen” Into Natural Gas

It has been suggested that blending “green hydrogen” (produced using zero net carbon pathways such as wind electrolysis) with natural gas could produce a lower carbon gaseous transportation fuel. To better understand the potential, we have calculated the effects of blending a fraction of green hydrogen with natural gas.

Table 7. Assumptions for Calculating GHG Emissions Associated with Green Hydrogen Blends

Higher Heat value: Fuel gases	<ul style="list-style-type: none"> <li>• H<sub>2</sub> = 286 kJ/mol</li> <li>• NG = 889 kJ/mol</li> <li>• 15% H<sub>2</sub>/85%NG = 799kJ/mol</li> </ul>
Add 15% zero-C H <sub>2</sub> to NG:	<ul style="list-style-type: none"> <li>• Reduces gC/mol <b>15%</b></li> <li>• Reduces HHV/mol by <b>10%</b></li> <li>• Reduces gC/MJ fuel <b>5%</b></li> </ul>

For the assumptions in Table 7, we calculate the relative values of three metrics for mixed fuel gases versus the fraction of hydrogen by volume. The higher heating value of the gas in HHV/mol is shown in blue. The carbon content per mole of gas gC/mol is shown in red. Finally, the fuel carbon content per unit energy is shown in grey gC/MJ.

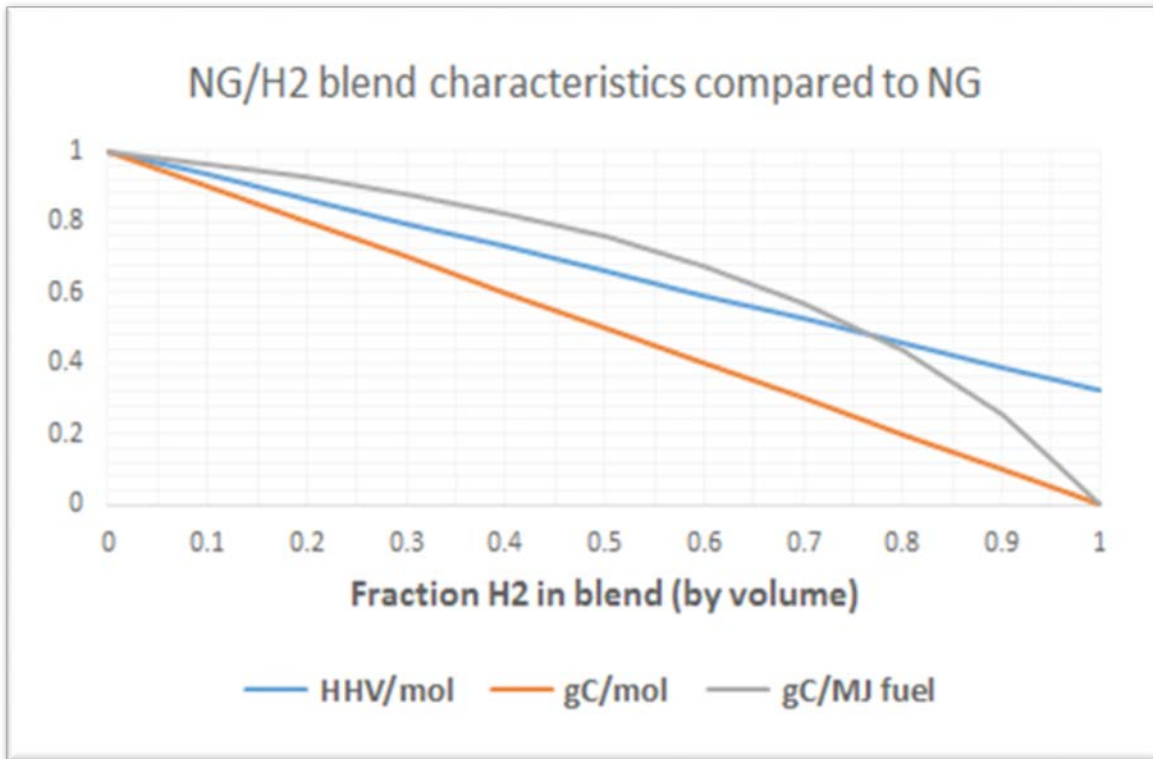

Figure 31. Effect of blending green hydrogen with natural gas on fuel gas energy and carbon content. The y-axis shows the fraction compared to pure natural gas.

Figure 31 shows the effect of blending green hydrogen with natural gas on fuel gas energy and carbon content. The carbon content per mole (gC/mol) is reduced proportional to the fraction of green hydrogen, but heating value of the gas (HHV/mol) is also reduced. Consequently, with a 15% H<sub>2</sub>/85% NG blend (a typical H<sub>2</sub> limit to avoid extra costs and safety issues), the fuel carbon content gC/MJ of fuel is only reduced by about 5% instead of 15%.

Next we consider the end-use efficiency for different gases. Separating pure H<sub>2</sub> from the blend could enable use of fuel cell vehicles rather than ICEVs run on the NG/ H<sub>2</sub> blend. Because a H<sub>2</sub> FCV is roughly twice as efficient as a NG/ H<sub>2</sub> ICEV, there would be a greater well-to-wheels carbon reduction with the separated H<sub>2</sub>/FCV pathway.

In summary, blending “zero-carbon” renewable hydrogen with natural gas at 15% hydrogen by volume yields only a 5% reduction in fuel carbon content per MJ. To realize large GHG benefits from blending “green hydrogen”, the hydrogen must be separated and used in a high efficiency end-use device such as a fuel cell. However, as shown above separation has costs and efficiency losses.

#### 4.2.6 METHANATION OR “E-GAS”: PRODUCTION OF METHANE FROM CO<sub>2</sub> AND RENEWABLE HYDROGEN<sup>92</sup>

Another concept that could potentially utilize electrolytic hydrogen from variable renewables, like wind and solar, is “methanation” of CO<sub>2</sub>. In methanation, renewable hydrogen is chemically combined with a concentrated stream of CO<sub>2</sub> (preferably from a renewable biomass source) to produce methane (see Figure 32 below). This approach, which is also called “e-gas”, “captures” the energy in intermittent renewable electricity, by making electrolytic hydrogen and using it as a feedstock for methane production. The methane can then be introduced into the natural gas grid without the compatibility concerns that arise for hydrogen and hydrogen blends.

There is considerable interest in methanation for renewable intensive electric grids, as a way of storing energy from curtailed variable renewable power that would otherwise be wasted. If the end-user wished to reconvert the methane to pure hydrogen (for example, to power a fuel cell vehicle), a steam methane reformer is needed, which has energy losses and costs. A recent study by the International Energy Agency suggests that the methanation pathway is likely to be less energy efficient than other options for storing variable renewable energy (e.g. solar or wind power), which could be a barrier to deployment.<sup>93</sup> Further, a 2016 comprehensive review of methanation found that the produced methane was not economically competitive with either fossil natural gas or bio methane.<sup>94</sup>

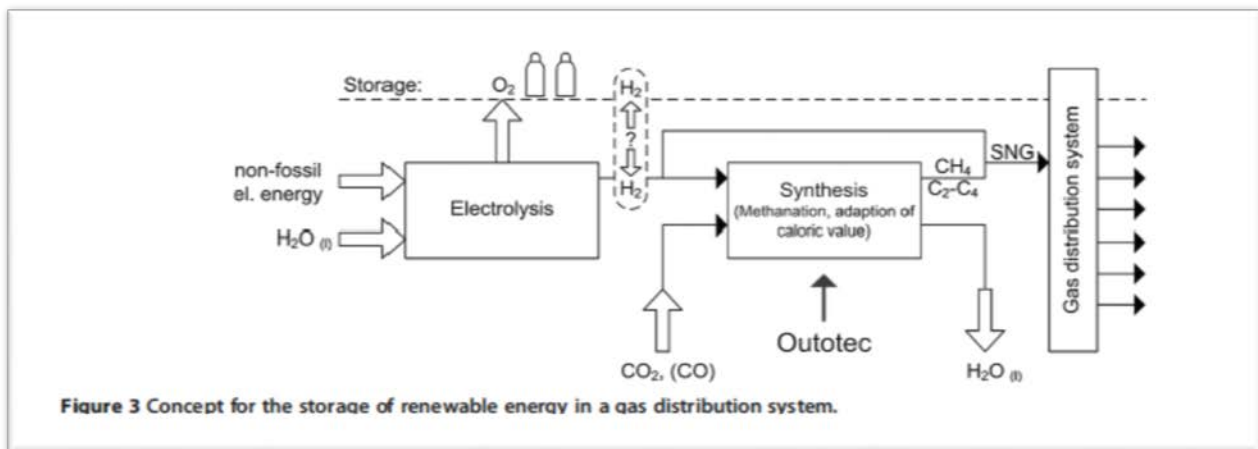

Figure 32. Methanation Concept for producing renewable methane from electrolytic hydrogen and CO<sub>2</sub><sup>92</sup>.

## 4.3 SCENARIOS FOR GROWTH: IMPLICATIONS FOR NATURAL GAS AS A BRIDGE TO HYDROGEN

### 4.3.1.1 California's near term hydrogen network

About 3/4 of California's 50 planned hydrogen refueling stations rely on central production of hydrogen and truck delivery of compressed hydrogen gas or liquefied cryogenic hydrogen. (In 31 stations compressed hydrogen is delivered by truck; 7 have liquid hydrogen delivered by truck; 7 onsite electrolysis; 2 onsite steam methane reforming and in one case, a station gets its hydrogen by tapping into an existing hydrogen pipeline serving a refinery in a nearby industrial area.) The hydrogen is derived from large scale, centralized steam reformation of fossil natural gas. These hydrogen production and delivery technologies are commercial and widely used in the industrial gas industry today.

Some stations use "onsite production" where hydrogen is produced at the station via small scale steam methane reforming (2 stations) or water electrolysis (7 stations). (Electrolysis uses using electricity to split water into hydrogen and oxygen.) Onsite production avoids the need to transport hydrogen from the central production facility to the station. Onsite production technologies are less mature, and the stations costlier than those with truck delivery.

Hydrogen blending with natural gas is not currently done in California. There is a "power to gas" project being conducted by Southern California Gas at UC Irvine which began in 2016. This project plans to use a methanation approach.

Today's hydrogen refueling stations in California are typically 180-350 kg per day in size, capable of serving a total fleet of perhaps 250-500 cars, assuming stations were fully utilized. This is much smaller than a typical gasoline station, which might support a fleet of several thousand cars.

As California's renewable hydrogen requirement becomes more important (see Figure 7), hydrogen production will shift away from fossil sources toward options like reforming renewable natural gas or electrolysis using renewable electricity. This may make the overlap with the fossil natural gas infrastructure less important.

Roughly 100 hydrogen stations are forecast for 2021, of which up to a third could be renewable sources but beyond that time, a growing network and larger stations will be needed if hydrogen is successful. New H<sub>2</sub> stations that derive their fuel from renewable sources will have little overlap with the natural gas infrastructure system and thereby few, if any synergies.

### 4.3.1.2 Limited Synergies for Adoption of Natural Gas and Hydrogen Vehicles and Infrastructure Buildout

In this section, we present scenarios for developing natural gas and hydrogen as transport fuels in California over the next two decades. We evaluate the timing and magnitude of the two infrastructures and discuss their possible synergies.

Table 7. Scenario for hydrogen and natural gas vehicles and fueling stations in California<sup>36,34,95</sup>.

	2015	2020	2025	2030	2035
<b>Hydrogen Fuel Cell Light Duty Passenger Vehicles<sup>a</sup></b>					
Number of H <sub>2</sub> FCV LDVs on road	197	23,500	270,000	1.5 million	4 million
H <sub>2</sub> use for LDVs (gge/d)	138	16,200	189,000	1.1 million	2.8 million
H <sub>2</sub> Stations serving LDVs in California	21	100	400	1500	4000
<b>Hydrogen Fuel Cell Medium and Heavy Duty Fleet Vehicles<sup>b</sup></b>					
# H <sub>2</sub> Fleet Vehicles On-Road (buses, short haul trucks, MD delivery trucks)	0	660	12316	29972	58812
H <sub>2</sub> Fuel Use For Fleet Vehicles (gge/d)	0	5985	61977	149216	299,726
H <sub>2</sub> Stations Serving H <sub>2</sub> Fleet Vehicles	0	17	89	213	428
<b>CNG Medium and Heavy Duty Fleet Vehicles<sup>b</sup></b>					
# CNG Fleet Vehicles On-Road (buses, HD short haul, MD delivery trucks, HD vocational trucks)	47894	49502	52524	58168	66630
CNG Fuel Use For Fleet Vehicles (gge/d)	1,291,836	1,299,190	1,331,875	1,381,486	1,451,488
Stations Serving CNG Fleet Vehicles	538	563	570	634	580
<b>NG Long Haul Heavy Duty Trucks<sup>c,d</sup></b>					
Number of NG Heavy Duty Trucks	729	738	14,231	48,748	74,545
NG Energy use gge/d	25,418	25,727	495,916	1,698,827	2,597,999
NG Stations serving trucks in California	CNG: 8 LNG: 9	CNG: 8 LNG: 9	CNG: 8 LNG: 37	CNG: 10 LNG: 73	CNG: 11 LNG: 93

Table 7 shows a scenario for market growth of hydrogen and natural gas vehicles over the next two decades, based on UC Davis research<sup>36,34,96,97</sup>. The number of H<sub>2</sub> FCV light duty vehicles is assumed to grow rapidly, and by 2035 there are 4 million on-road light duty FCVs, far more than for NG or H<sub>2</sub> medium and heavy duty fleets. CNG is already established as a fleet fuel and we assume that it remains at a near-steady level; however, H<sub>2</sub> FCV use in medium and heavy duty fleets is assumed to grow significantly and the on-road fleet numbers rival CNG by 2035. Long haul trucks using LNG are also assuming to grow rapidly, reaching about 75,000 by 2035.

How might NG and H<sub>2</sub> infrastructures grow in this scenario? It is important to consider market timing for different applications and technical compatibility as well as the spatial design of the refuelling network.

Hydrogen fuelled FCV passenger vehicles will require many, relatively small public H<sub>2</sub> stations. The main considerations for siting public H<sub>2</sub> stations are providing fuel conveniently and cost effectively to a geographically diffuse population of consumers. Public H<sub>2</sub> stations will be



largely located in urban areas with a few “connector” or destination stations to facilitate long distance travel. Numbers of public hydrogen stations grow rapidly after 2025, and by 2035, the number of passenger car public H<sub>2</sub> stations is 4000, far outnumbering the refuelling stations needed for LNG (100), hydrogen fleets (430) or CNG fleets (580).

By contrast, LNG long haul freight trucks operate along high density freight corridors, and are fuelled in relatively few, large “truck stop” stations located along interstate highways<sup>96</sup>. As discussed above there are no technical possibilities to convert equipment in LNG stations to hydrogen stations. Further, there are relatively few LNG stations, because they are large capacity and geographically concentrated along highway freight corridors. The only spatial overlap might be for long distance travel by passenger cars.

Perhaps the largest potential spatial and technical overlap of the two infrastructures, would be for hydrogen fleet vehicles and CNG fleet vehicles. These fleets might operate in the same geographic areas, such as ports or package delivery in cities. Both hydrogen and CNG fleets will likely have dedicated private refuelling sites, and the gas storage and compression equipment for the two fuels is somewhat analogous, as discussed above. However, the dynamics of these markets are different. In our scenario, hydrogen fleets start growing after about 2020, and the number of hydrogen fleet stations is assumed to grow from 90 to 430 between 2025 and 2035, while the number of CNG fleet stations stays fairly constant at about 500-600 stations. In our scenario analysis, we do not envision a major switch from CNG to hydrogen by 2035, but rather the addition of new capacity for hydrogen to supplement existing CNG markets. Both hydrogen and CNG market shares would grow, presumably replacing diesel. In our scenario, the issue for infrastructure is mainly focused on adding hydrogen supply, rather than repurposing CNG equipment. Today’s natural gas stations will need to be replaced about the same time that hydrogen use is growing rapidly. But the station locations for the two fuels may not overlap much and there will be many more hydrogen station sites. Thus, it is not clear that there is a large commercial benefit in overbuilding today’s natural gas station components for hydrogen compatibility, anticipating a future hydrogen market that may be geographically concentrated elsewhere and may not really “take off” in terms of energy flow for 10 years. To promote overbuilding of current CNG networks to shift more quickly to hydrogen, government would potentially need to intervene in markets with some kind of incentive program.

Still, in theory, there is potential for infrastructure overlap for hydrogen fleet vehicles and CNG fleet vehicles. We consider scenarios where these fleets could operate in similar applications and geographies including ports or package delivery in cities. Hydrogen and CNG fleets typically utilize dedicated private refuelling sites. Storage and compression equipment for the two fuels is somewhat analogous and therefore we can consider the costs related to conversion from CNG to hydrogen. We consider specifically how much savings could be gained by building CNG gas storage tanks hydrogen-compatible from the outset and therefore to be able to shift to hydrogen as more adoption of hydrogen fuel becomes apparent over time. We consider storage tanks because it is the CNG station component most easily made forward compatible.

A typical CNG fleet station dispensing 1500-2000 gge/day might have a tank with a capacity of 55,000 scf or 437 gge on an energy basis<sup>9</sup>. Cost estimation for a CNG tank is about \$100,000 or about \$230/gge. If the tank were “overbuilt” for hydrogen service, we calculate that the tank cost would increase to \$1200/kg or \$1200/gge<sup>10</sup>. In other words, overbuilding a 437 gge capacity tank would add  $\$524,000 - 100,000 = \$424,000$  to the capital cost of the CNG station.

We then consider how this extra cost could be recovered. If a station owner switches to hydrogen in year “n”, the present value of the hydrogen-compatible tank is  $\$524,000/(1+i)^n$  where i is the discount rate. Assuming  $i=10\%$  ( $6\%$ ), which is typical for private businesses (publically funded stations), and solving for n, we find that overbuilding the CNG tank would have an economic incentive only if the station is switched to hydrogen within the first 3 (4) years of operation. Because this is a relatively short period of time, it is possible that CNG station owners would need strong government incentives storage to overbuild for hydrogen compatibility. It is possible therefore that many hydrogen stations and CNG stations could be developed parallel to each other instead of leveraging overbuilding for transition from one to the other.

## 5 SUMMARY AND CONCLUSIONS

The development of an industry in advanced, near-zero emission alternative fuels in California comes at a time when the fossil fuels natural gas industry is expanding its supply and infrastructure into the transportation sector. The emergence of new interest in investment in natural gas fueling infrastructure in California raises the question regarding whether natural gas infrastructure could become stranded by the ultimate shift to lower carbon fuels or whether the natural gas infrastructure system offers synergies that could potentially enable synergies that will facilitate speedier adoption of lower carbon fuels. Industry has advocated that overlap of key natural gas infrastructure will lower transition costs and provide consumers with an optimal mix of fuels as the state's car stock is replaced with alternative vehicles over time.

Generally speaking, we find that there are some synergies between natural gas infrastructure and California's hydrogen fuel buildout but that fossil natural gas networks can be more easily and cost effectively utilized to advance a renewable natural gas industry in the state. Blending RNG with fossil natural gas provides a potential opportunity to build RNG usage and familiarity, while lowering costs by reducing capital costs for dedicated transmission and fueling infrastructure. In a manner similar to E85, a small percentage of RNG could be added to fossil natural gas, to begin building the necessary infrastructure and markets for pure RNG.

In particular, we find:

- 1) Emerging RNG supplies can utilize much of the same infrastructure as fossil natural gas networks, sharing the same vehicles, station equipment and midstream pipelines for transmission.
- 2) There is the possibility that the RNG resource development time line is aligned with the current expansion of natural gas in transportation. The time frame for availability and opportunity exist in the current market, allowing for RNG and fossil natural gas networks to be developed simultaneously, each facilitating the other. Fossil natural gas network investors can benefit from receiving ongoing carbon credits by blending RNG into their fossil based natural gas fuel while RNG investors can save costs by piggy backing on existing fossil natural gas infrastructure.
- 3) One issue with RNG is that the clean-up and upgrading costs are high and that impacts the economics of scaling it up. Also the upstream equipment for RFG is generally located in geographically different places than oil and gas production facilities so there can often be a long distance to connect into existing pipeline system. Clustering clean up and upgrading facilities for biogas can improve the commercial viability of RNG businesses.
- 4) DME is stored, handled, and transferred as a liquefied gas under 5 atmospheres pressure and utilizes a storage and distribution infrastructure similar to liquefied petroleum gas (LPG) or propane. With straightforward retrofits especially of seals and gaskets, basic components of LPG storage and handling technology can be used for the storage and handling of DME, and DME can be blended with LPG or propane. However, DME is not suitable for direct use in natural gas storage or delivery systems. In summary, DME potentially overlaps with the LPG infrastructure but not with natural gas infrastructure
- 5) For hydrogen, natural gas can be a feedstock for methane reformation but eventually for a zero-emissions sustainable hydrogen, electrolysis will be used and that will not share natural gas infrastructure, unless the methanation approach is pursued.

- 6) Hydrogen fueling equipment can theoretically share some of the same components (storage and compression) as CNG. Hydrogen compression and storage equipment requires much higher pressures as well as special materials.
- 7) Because the energy density of H<sub>2</sub> is very low per unit volume, H<sub>2</sub> is compressed to a much higher storage pressure than CNG and thus requires a more powerful compressor and a stronger storage tank plus a dispenser which can handle such pressures. Since this has a higher cost, station owners might require government incentives to overbuild their station to ensure forward compatibility with hydrogen fueling. Without government intervention, our analysis shows that CNG and H<sub>2</sub> stations might develop in parallel rather than transition mainly from one to the other.
- 8) Hydrogen can embrittle and degrade some materials commonly used to store and transport natural gas and requires the use of less reactive and stronger materials. Hydrogen storage tanks are made of stainless steel plus an interior polymer lining to prevent against embrittlement and permeation.
- 9) As a “rule of thumb” hydrogen can be blended with natural gas at up to 5-15% by volume without requiring major changes in the infrastructure or end-use equipment or causing safety problems. Although 5-15% hydrogen by volume is a typical value, the appropriate blend concentration may vary significantly between pipeline network systems and natural gas compositions and must therefore be assessed on a case-by-case basis.
- 10) Blending “zero-carbon” renewable hydrogen with natural gas at acceptable concentrations (15% hydrogen by volume) yields only a 5% reduction in fuel carbon content per MJ. To realize large GHG benefits from blending “green hydrogen”, the hydrogen must be separated and used in a high efficiency end-use device such as a fuel cell. However, separation has costs and efficiency losses.
- 11) There will be some overlap in geographies and locations between CNG and hydrogen for medium duty trucks. Transition to hydrogen trucks may take 7 to 15 years, however, meaning that some of the CNG stations built today will be may be out of service by the time significant demand for hydrogen fuel for trucks would emerge.
- 12) Within 5-10 years, the number of hydrogen stations required for emerging FCV passenger car markets will far exceed the number of stations needed along interstates for long-haul trucks. By 2020/2025/2035 there will be 5x/10x /40x as many hydrogen stations as NG truck stations. There is very little commonality between the equipment in LNG stations and hydrogen stations and thus the expansion of the LNG network for heavy duty trucks is unlikely to be enabling to hydrogen transition.

## 6 RECOMMENDATIONS

### Policies related to renewable natural gas blending with fossil natural gas

- Create an inter-agency RNG regulatory task force that can oversee conflicting rules and complex permitting for RNG facilities as a result of water use, VOC emissions, wastewater usage and pipeline injection standards; Empower task force to recommend policies based on scientific input to update regulations to be consistent with other U.S. states and European best practices; Task force should also study and recommend approaches to streamline the regulatory process to create a single entity with sufficient expertise for comprehensive RNG oversight and permitting.
- Inter-agency task force should reevaluate CUPC and utilities tariff structure for injection of RNG into existing fossil natural gas pipeline system in California and recommend any needed adjustments
- Task force should be commissioned to draft standardized control processes and specifications for RNG as a vehicle fuel. Such standards and safety codes would also simplify the adoption of RNG as a vehicle fuel and lower the final cost of the fuel while improving consistency and efficiency, with technical input from academic experts, utilities, CPUC, pipeline owners, RNG producers, engine OEMs, and other stakeholders. Standardization should include equipment for gas and electrical distribution interconnections.
- Evaluate modifications in the minimum heating value requirement to allow for injection of biomethane, taking into account for downstream blending to occur naturally in the pipeline and considering an energy content of 960 to 980 BTU/scf as standardization rather than 990 BTU/scf.
- Amend California's policies regarding 12 constituents of concern to measure contaminants not at the point of injection but before biomethane is mixed with fossil natural gas.
- Evaluate whether subcontractors should be allowed to construct RNG pipelines under supervision by CPUC
- Support R & D on thermochemical gasification technologies with the purpose of developing lower cost, higher efficiency systems that can serve as reliable technologies to convert forest and agricultural residues (and other feedstocks) to biogas.
- Commission a study that identifies regions suitable for resource and recovery parks to cluster processing and distribution of RNG from Dairy sources. The study should ensure that appropriate infrastructure either exists or can be economically built to distribute the feedstocks to the centralized facilities.
- Given the high environmental potential of dairy RNG and the importance of the dairy industry to California's economy, select of one or more promising locations for a resource and recovery park to cluster processing and distribution of RNG from Dairy sources and fund the preliminary work necessary for installation of the facilities. This work could include defining the project scope, submitting all appropriate environmental reports, obtaining approvals from all relevant agencies, building infrastructure, and necessary site preparation.
- Conduct a full life-cycle analysis comparing biogas environmental performance in transportation in comparison to other end uses (e.g. recycling, composting, electricity

generation, biodiesel etc.) across waste streams to enable policies and incentives to be created to guide the feedstocks to the “highest and best” usage.

- Dairy-based RNG promises significant benefits but faces serious challenges in economics and the coordination required to develop clustered infrastructure required to improve the economics. The state will need to assist in financing these projects. To minimize cost and maximize benefits, the state should provide funding through Short-Lived Climate Pollutant Program to help finance centralized upgrading and injection infrastructure. Additional coordination support should be provided in the form of targeted workshops to bring together the dairies in a region with other relevant stakeholders in order to facilitate the formation of robust clusters.

#### Policies related to hydrogen-blending with natural gas and power to gas (e-gas)

- Conduct a rigorous, scientifically-based assessment to establish acceptable limits for hydrogen blend concentrations in California’s natural gas system. Develop protocols for introducing hydrogen into the natural gas grid. This assessment will be based on site-specific analyses of hydrogen compatibility, including natural gas end-use, transmission, storage and distribution equipment in California’s natural gas system. Draw upon technical expertise from ongoing hydrogen codes and standards activities under the Federal and California agencies and National Laboratories, as well as public/private groups such as H<sub>2</sub>USA and the California Fuel Cell Partnership, and industry (gas utilities, industrial gas companies, and groups such as FCHEA and the California Hydrogen Business Council) and learnings from international power to gas programs. As part of the assessment, examine the costs and benefits of hydrogen blending. Timely to do this.
- Establish a process to certify different parts of the natural gas system including end-use devices such as end-use appliances, storage, compressors, transmission and distribution pipelines for use with hydrogen blends.
- Establish a strict regulatory and permitting process for hydrogen blending with natural gas should be established that includes independent verification of extensive testing that pipes and polymer liners are made of sufficiently strong materials consistent with hydrogen transport and are free from cracks and weaknesses that might be worsened by hydrogen’s more corrosive properties. Permitting of hydrogen blending with natural gas should demonstrate a clear need and environmental benefit and be restricted to levels consistent with the results of the blending assessment.
- Conduct a California-specific assessment of the costs, benefits and emissions reductions of a methanation or e-gas strategy, and its role in a future energy system with increasing use of intermittent renewables. Examine the costs and benefits of producing renewable methane via methanation of CO<sub>2</sub> by electrolytic hydrogen produced from curtailed renewables like wind and solar, and “storing” this excess renewable power as methane injected into natural gas pipelines.
- Compare the likely costs, benefits and emissions reductions for e-gas and hydrogen/natural blending strategies, as compared to battery storage and other energy storage technologies for large fractions of intermittent renewable energy in California. Assess implications for greenhouse gas emissions from the transportation sector.

## 7 GLOSSARY OF TERMS

AD – Anaerobic Digester  
Bbl or bbl – Barrels (of oil, diesel, etc.)  
Bcf or bcf – billion cubic feet  
BCG - Boston Consulting Group  
BDT – Bone dry tons  
BTEX - Benzene, toluene, ethylbenzene, and xylenes  
CCS- Carbon Capture and Sequestration  
CH<sub>2</sub> = Compressed Hydrogen gas  
CH<sub>4</sub> - Methane  
CNG – Compressed Natural Gas  
CO- Carbon Monoxide  
CO<sub>2</sub> - Carbon Dioxide  
CPUC - California Public Utility Commission  
Dimethyl ether (DME)  
EER – Energy efficiency ratio  
FCVs - Fuel Cell Vehicles  
Gas Technology Institute (GTI)  
GHG – Greenhouse gas  
GHG - Greenhouse Gas  
GJ – Gigajoule  
H<sub>2</sub> - Hydrogen  
H<sub>2</sub>S - hydrogen sulfide  
HHV - High-Heating Value  
ICEVs - Internal Combustion Engines  
LCFS - Low Carbon Fuel Standard  
LCFS – Low-carbon fuel standard  
LFG - Landfill Gas  
L H<sub>2</sub> - liquid hydrogen  
LMOP - Landfill Methane Outreach Program  
LNG – Liquefied natural gas  
LPG - Liquefied petroleum gas  
MIC - Microbial-influenced corrosion  
mmBTU – million British Thermal Units  
MMSCFD - Million Standard Cubic Feet per Day  
MMT CO<sub>2</sub> – Million metric tons of Carbon Dioxide  
MSW – Municipal Solid Waste  
MSW - Municipal solid waste  
NGLs - Natural gas liquids  
NH<sub>3</sub> - Ammonia  
NMOCs - Non-methane organic compounds  
OEMs - Original Equipment manufacturers  
PSA - Pressure swing adsorption  
RIN - Renewable Identification Number  
RNG – Renewable Natural Gas  
SLCP- short lived climate pollutants

SMR – Steam Methane Reformer  
SWIS – Solid Waste Information Systems  
TTW – Tank to Wheels  
VOC- Volatile Organic Compounds  
WTT – Well to Tank  
WTW – Well to Wheels  
WWTP – Wastewater Treatment Plant  
WWTP- Waste Water Treatment Plant



## 8 APPENDIX A: RNG COMPATIBILITY WITH NATURAL GAS INFRASTRUCTURE

**Biogas** is the mixed, gaseous product of the decomposition of organic matter. When derived from municipal solid waste (MSW) in landfills it is commonly called “**landfill gas**” (LFG); when derived from anaerobic digestion (AD) of wastewater, animal manure or other organic waste it is commonly called **AD gas** or simply **digester gas**. Unlike conventional fossil natural gas which is composed mostly of hydrocarbons-70% or more methane (CH<sub>4</sub>) plus propane and butane-raw, biogas generally contains somewhat less methane, a significant amount of carbon dioxide (CO<sub>2</sub>), and lesser amounts of nitrogen, hydrogen, carbon monoxide and a variety of contaminants. **Renewable natural gas (RNG)** is made by processing biogas to remove contaminants.

Some of the major differences between conventional natural gas and RNG are shown in Table 8. The raw gas can be upgraded and purified into gaseous or liquid products, known as compressed biogas (CBG), liquid biogas (LBG) or simply “high Btu natural gas”. RNG becomes a gaseous product that has been upgraded to a standard of purity comparable to that of conventional fossil natural gas (Table 8).

Table 8. Difference between conventional gas and RNG

Conventional Natural Gas	RNG
95-98% methane*	95-98% methane*
Constituents are well understood	Constituents are not well understood
Utility and Interstate pipeline tariffs account for typical components	Utility and Interstate pipeline tariffs don't typically address all components
Methods for treating raw gas are proven and in-place	Methods for treating raw biogas can be costly

\*Post clean-up

Prior to upgrading, conventional fossil natural gas can contain 50-75% methane, although individual deposits can vary significantly. Similarly, methane comprises 45-65% of landfill and AD gas, although individual sites may contain higher or lower percentages. As a general rule, however, digester gas contains a higher proportion of methane than does LFG. Conversely, LFG tends to have higher concentrations of nitrogen and oxygen. Primarily due to air infiltration through the cover soil, nitrogen and oxygen levels must be reduced prior to pipeline injection (since they can affect combustion properties of the delivered fuel).

Carbon dioxide (CO<sub>2</sub>), hydrogen (H<sub>2</sub>), hydrogen sulfide (H<sub>2</sub>S), and ammonia (NH<sub>3</sub>) are also present in significant concentrations, both in conventional natural gas and in biogas. Gas cleanup and processing typically removes all or most of these impurities, as well as water vapor (the gas is usually saturated with water vapor) and various other contaminants.

LFG may contain more than 500 different contaminants, including a variety of sulfur compounds that are corrosive in the presence of water, halogenated compounds (e.g., carbon tetrachloride, chlorobenzene, chloroform) that produce corrosive combustion products, and organic silicon compounds (e.g., siloxanes from cosmetics) that form siliceous deposits in downstream applications, as well as amines, volatile organics such as benzene, toluene, ethylbenzene, and xylenes (BTEX), aldehydes, and ketones. It should be stressed that emissions from BTEX species, aldehydes, and ketones can be introduced into the pipeline.

Siloxanes are organic compounds that contain silicon, oxygen, hydrogen, and carbon. Due to the increase in silicon-containing personal hygiene, health care, and industrial products, the presence of silicon in waste streams has increased. As the silicon-containing waste stream is aerobically digested, the silicon converts to siloxane compounds that volatilize and become entrained in the biogas. When this gas is combusted under high heat and pressure, silicon dioxide is formed. This silica dust damages internal combustion engines, turbines, and add-on air pollution control devices. It is worth mentioned that D4 (octamethylcyclotetrasiloxane) and D5 (decamethylcyclopentasiloxane) are the most common compounds found in landfill-derived renewable gas.

Microbial-influenced corrosion (MIC) can degrade the integrity, safety, and reliability of pipeline operation and is one of leading causes of pipeline failure in the oil and gas industry. Depending upon the starting biomass, a variety of microbial populations may exist in the resulting gas stream in RNG. MIC corrosion is caused by acids produced by bacteria. It is this acid which induces pitting in metal pipes. MIC can be especially prevalent in gas lines in which moisture has collected, or in wet gas systems.

Inert and diluent gases are non-hydrocarbons and reduce the overall heating value of a fuel gas. Inerts (nitrogen, argon, helium, etc.) are not chemically reactive with the surrounding environment. However, diluent gases may chemically react with the surrounding environment. Carbon dioxide is considered a diluent and is an odorless, colorless gas. It reduces the overall heating value of the gas stream per unit volume. Carbon dioxide is non-corrosive in the absence of water, but if water is present, under certain conditions, it can form carbonic acid. Additionally, carbon dioxide can act synergistically with hydrogen sulfide and oxygen, thereby enhancing the corrosion of pipeline materials. The presence of oxygen is critical because it increases both the effect and rate of other corrosion mechanisms. In combination with free water and/or with other constituents such as carbon dioxide, hydrogen sulfide and bacteria (naturally occurring), enhanced corrosion can result. Therefore, a dry renewable gas product is desired. Small amounts of oxygen can support colonies of sulfate-reducing bacteria, especially in the presence of moisture. Nitrogen is an inert gas that is colorless, odorless and non-corrosive. It is usually regulated because it affects the calorific value and relative density of the gas. At elevated nitrogen concentrations, combustion operations may be impacted, possibly causing poor flame stability and producing a flame with yellow tipping and lifting. High concentrations of nitrogen also may affect compressibility of the gas.

Volatile metals such as mercury and arsenic may be present in RNG. In RNG generation, they may be released into the raw gas through the degradation of concentrated plant materials and metal-containing products. Mercury in natural gas can be from both natural

and artificial sources. It is believed to permeate from the carboniferous formations from which the gas itself originates. Artificial sources are likely mercury-containing devices that measure pressure and gas flow through the pipeline. It is generally supposed that any arsenic in natural gas comes from the geological gas formations. The primary impact from the presence of mercury in the gas stream is potential corrosion of aluminum metal and alloys used to construct gas processing equipment. This is particularly problematic because mercury may concentrate in cryogenic liquids and other processing fluids.

The primary impact from the presence of arsenic in the gas stream is potential formation of particulates of alkyl arsine sulfides at pressure reduction points along the gas network. The presence of arsenic compounds in the gas phase can lead to poisoning of palladium and platinum catalysts used in gas processing operations. For both parameters there are potential health hazards associated with pipeline workers performing odorant sniff tests and end use applications.

The presence of ammonia could impact on downstream gas processing equipment and odorization of pipeline gas. When present in a gas that is combusted, it could form nitrogen oxides that would have an impact on end use operations. Nitrogen oxides are a concern because they are known to assist in the creation of smog, foster the depletion of the ozone layer, and contribute to acid rain. Ammonia may also possibly degrade the quality of odorization and induce odor fade or odor masking.

Particulate matter, such as dust, gums and biologicals, can be introduced into the gas distribution network from a variety of sources. In the case of landfill-derived renewable gas production, particulate matter may be carried along from the production process into the final landfill-derived renewable gas product. The amount and size of particulate matter in any fuel as should be minimized to avoid contamination, clogging and erosion of processing plant and distribution line components. Particles can usually be removed by filters, sedimentation or centrifugal collectors.

Hydrogen sulfide is found at various levels in landfill-derived renewable gas and its presence is due to its formation during the anaerobic microbial decomposition of sulfate and sulfur-containing organic matter. The primary sulfur compound found in raw biogas is hydrogen sulfide. It can also be found in natural gas as a naturally occurring contaminant. Hydrogen sulfide is colorless and smells like rotten eggs.

Mercaptans are sulfur compounds which may be naturally occurring or added to natural gas as an odorant. Lower molecular weight mercaptans, such as methyl mercaptan, can be found in biogenic gases. Higher molecular weight mercaptans, such as t-butyl mercaptan (TBM) are added as part of an odorant blend along with other mercaptans, dimethyl sulfide (DMS), or tetrahydrothiophene (THT). Other sulfur compounds that can potentially be present include carbonyl sulfide, sulfur dioxide, and polysulfides, the latter due to sulfur species interactions in the pipeline.

The presence of H<sub>2</sub>S and other sulfur-containing compounds is regulated because of their potential corrosive and destructive nature on pipeline materials. Sulfur can be corrosive with or without the presence of water. In the presence of water, sulfur compounds can eventually form sulfuric acid, a strong acid with an aggressive corrosion potential.

Additionally, it can potentially cause sulfide stress cracking in steel. Sulfur species corrosion is synergistic if other compounds are present, especially CO<sub>2</sub> and O<sub>2</sub> (from the presence of air). When present in sufficiently high enough concentrations (>1 ppmv), lower molecular weight mercaptans can degrade the quality of odorization and induce odor fade or odor masking. Pipeline tariffs typically include a limit on hydrogen sulfide concentration and total sulfur, and many limit total mercaptans.

The presence of water vapor can pose many problems particularly associated with corrosion. Usually the upgrading process will reduce the water content significantly. The presence of water is an issue because water, combined with CO<sub>2</sub> and H<sub>2</sub>S under certain conditions, can form acidic mixtures which are corrosive to pipeline systems. Water vapor is also limited to prevent condensation and to reduce hydrate formation. Hydrates are ice-like mixtures of water and hydrocarbons formed at high pressures where high water vapor is present. Temperature drops of 6-7 °F occur in gas through a regulator for about every 100 psi of gas pressure. This drop can be enough to cause ice and hydrate formation that clog the regulator or piping if the gas contains an excessive amount of water.

Biogas produced from landfill biomass sources typically consists of methane and other major components, but can also contain hundreds of other chemicals-most of which are known as "non-methane organic compounds" or volatile or semi-volatile organic compounds (VOCs and SVOCs). These are typically compounds containing carbon, hydrogen, and sometimes oxygen. These can be present directly in the landfill waste stream, or formed biogenically. Under the anaerobic conditions found in a landfill, complex organic compounds from the initial waste stream can be degraded by microbial action to volatile organic compounds before complete conversion to methane and carbon dioxide. Because this reaction does not usually go to completion, it results in a buildup of volatile or semi-volatile organic compounds in the landfill and ultimate volatilization to the gas phase. Many non-halogenated VOCs and SVOCs are present in natural gas as well, originating from the geological basin from which the gas was extracted. Non-halogenated VOCs and SVOCs can be a concern due to potential health hazards associated with pipeline workers performing odorant sniff tests and end use applications.

Halocarbons are organic compounds containing carbon, hydrogen, and chlorine, fluorine, and bromine. One halocarbon example common in landfill-derived gases are the various forms of Freon. These halocarbons are very stable and do not typically undergo any degradation reaction. Halocarbons present in the gas stream can cause operational problems for gas processing. When combusted, chloride ions form, causing potentially corrosive conditions to the pipeline. Vinyl chloride is a common halocarbon found in raw landfill gas and is highly toxic and regulated in some areas. Vinyl chloride is also suggested to be the most significant chlorinated compound in unprocessed landfill gas. The California Public Utility Commission regulates vinyl chloride in landfill-derived gas supplied to an existing gas customer at 1170 ppbv (1.17 ppmv).

Aldehydes and ketones are organic compounds that contain hydrogen, carbon and oxygen atoms. Aldehydes and ketones can be found in landfill waste streams such as building materials such as OSB (oriented strand board), MDF (medium-density fiberboard), carpet and linoleum/vinyl flooring, other pressed wood products, hardwood and plywood paneling, upholstery fabrics, latex-backed fabrics, fiberglass, and urea formaldehyde foam

insulation. Aldehydes and ketones can also be formed through anaerobic degradation of synthetic polymers, adhesives, and other waste streams. Under the anaerobic conditions found in a landfill, complex organic compounds from the initial waste stream can be degraded by microbial action to volatile aldehydes and ketones before complete conversion to methane and carbon dioxide. Because this reaction does not usually go to completion, it results in a buildup of aldehydes and ketones in the landfill and ultimate volatilization into the gas phase. Aldehydes and ketones present in the gas stream can cause operational problems for gas processing and end use applications. Their presence may possibly degrade the quality of odorization and induce odor fade or odor masking.

Given all these potential contaminants, an initial cleanup or pre-purification step is needed before LFG can be injected into the pipeline or used in any application involving combustion. AD gas contains many of the same contaminants although siloxane is less likely to be present in significant quantities.

On the other hand, the composition of dairy manure produced biogas tends to be more consistent with less ‘surprise’ elements. The typical compounds and their reported concentration ranges are shown in (Table 11). Methane is typically as high as 74% but is generally reported as being around 60%. The addition of food wastes into a manure-based digester seems to improve biogas production and may increase the methane concentration. Carbon dioxide is often measured at 40%. Nitrogen, hydrogen, oxygen, and hydrogen sulfide are typically found in smaller quantities.

Table 9. Manure-base biogas composition

	Compound	Concentration
<b>CH<sub>4</sub></b>	Methane	54-70%
<b>CO<sub>2</sub></b>	Carbon dioxide	27-45%
<b>N<sub>2</sub></b>	Nitrogen	0.5-3%
<b>H<sub>2</sub></b>	Hydrogen	1-10%
<b>CO</b>	Carbon monoxide	0-0.1%
<b>O<sub>2</sub></b>	Oxygen	0-0.1%
<b>H<sub>2</sub>S</b>	Hydrogen sulfide	600-700+ ppm
	Trace elements, amines, sulfur compounds, non-methane volatile organic compounds, halocarbons	

A requirement of transportation of natural gas by pipelines is that the gas must be free of liquid and solid particulate matter. The basis of this requirement is to minimize problems with operation and maintenance. Overall, the U.S. distribution system has more than 1,214,342 miles of main and 63,534,950 services. Approximately 52% of the mains are metallic and therefore susceptible to corrosion, while approximately 39% of services are non-plastic and therefore are at risk for corrosion. In addition to piping, joints, valves, and regulators are also at risk to contaminants. Beyond the metal components of valves and regulators, diaphragms, gaskets, o-rings, flange seals, quad seals, and valve seats can consist of thermoplastics, elastomers, natural rubbers, and synthetic rubbers which may be

sensitive to gas impurities. Polyethylene has been shown by the Plastics Pipe Institute to be resistant to 90 percent sulfuric acid and microbial attack by sewage bacteria.

### *RNG Treatment and Purification*

Natural gas produced from traditional wells requires processing in order to be suitable for transport to end users. Some processing, oil and condensate removal, can take place at the well head but gas is typically piped through low pressure gathering lines to a processing facility for removal of natural gas liquids (NGLs), hydrogen sulfide, and carbon dioxide. Most NGLs are removed by absorption or cryogenic expansion. Amine processes account for more than 95% of U.S. hydrogen sulfide removal operations.

In order for biogas from dairy manure or landfills to be suitable for natural gas pipelines, it will need to go through one or more cleanup processes to remove high levels of unwanted components, thereby enriching the gas. Once the gas is sufficiently cleaned up, it can be referred to as biomethane. Some level of quality control needs to be in effect to prevent uncleaned biogas or less than pipeline quality biomethane from entering the natural gas pipeline.

The collected biogas (either LFG or manure-based gas) must be treated to remove impurities before it enters the CO<sub>2</sub> removal process. Impurities include corrosive hydrogen compounds, low concentrations (parts per million) of non-methane organic compounds (NMOCs, including siloxane), and water. As stated in 40 CFR Parts 72 and 75, the level of hydrogen sulfide (H<sub>2</sub>S)-a corrosive, toxic, and flammable gas with unpleasant odor-must be reduced to less than 5 ppm for pipeline natural gas. Many well-established processes (e.g., absorption, adsorption, and chemical and thermal oxidation) are available for H<sub>2</sub>S removal from gas fluxes.

There are a plethora of methods and processes that can be used to remove contaminants in gas streams. A number of them are well established while others are not as developed. Some are appropriate for use in small scale and others are only economical at gas flows measured in Million Standard Cubic Feet per Day (MMSCFD) and where sulfur removal rates are measured in tons per day. The ability of a process to remove unwanted compounds is highly dependent on a number of factors and assessment of the true practicality of the method for a given application requires careful evaluation.

### *Membrane Separation*

Since CO<sub>2</sub> is more permeable than CH<sub>4</sub>, the two may be separated by selective permeation through membranes. When the LFG contacts the membrane, more CO<sub>2</sub> than CH<sub>4</sub> permeates, although quantities depend on the partial pressure difference across the membrane. Gas streams containing high levels of hydrogen sulfide can degrade the membrane and shorten its useful life. To extend membrane life, cleanup units can be employed to pre-clean the gas before entering the membrane process. Membranes can be highly selective or highly permeable but rarely both. The process efficiency is therefore less than ideal as multiple passes are needed and gas is lost. However, membranes are highly reliable, easy to operate, and can be used for gas dehydration.

Membrane separation is amenable to a wide range of process stream volumes, CO<sub>2</sub> concentrations and product-gas specifications. It also tends to be more environmentally friendly than amine processes. Since membrane separation operates at relatively high pressure, ranging from 200 to 600 psig, a further benefit is reduction in compression requirements for CNG production or injection into the gas grid.

### *Adsorption*

Sour gas is passed through a bed of adsorbate which likely exhibits a high surface area to unit weight ratio. The adsorbent is typically a microporous solid that attracts and holds onto selective components (adsorbate) from the gas stream. The force which binds the gas components to the solid is quite weak making regeneration easily attainable by decreasing gas pressure, increasing temperature, and gas purges. Regeneration of adsorbents can be accomplished through one of the four following cycles: Temperature Swing Adsorption (TSA), Inert Purge Adsorption, Displacement Purge Adsorption, or Pressure Swing Adsorption.

TSA is used primarily for dehydration and removal of small concentrations of impurities. The gas is passed through the adsorbent, but at a low temperature. Once the bed becomes saturated, the temperature is raised and the gas continues to pass through the bed until saturation occurs at the raised temperature. Adsorption and regeneration is accomplished through a heating and cooling cycle which is both time and energy intensive.

For the Inert Purge Adsorption cycle, gas is passed through the adsorbent bed until saturation at partial pressure occurs. A non-adsorbing gas is then fed through the bed causing desorption by reducing the partial pressure of the adsorbate. It is the heat of adsorption that causes the temperature difference. There is an increase during adsorption and a decrease during desorption eliminating the need for externally created heating and cooling as with TSA. The Inert Purge Adsorption Cycle occurs quickly, but is limited to low concentration changes and is usually employed for hydrocarbon separation.

The Displacement Purge Cycle is similar to the Inert Purge cycle. The major difference occurs in the desorption approach. In Displacement Purge, a purge gas which is more strongly adsorbed than the removed component is passed through the bed. Though Displacement Purge and Inert Purge have short cycle times and are used for hydrocarbon separation, Displacement Purge can realize greater removal amounts. The major drawback of Displacement Purge is the necessity of the separation of the purge gas from the purge stream and from the adsorbent.

Rapid cycling is also possible with Pressure Swing Adsorption (PSA). This cycle relies on pressure changes to adsorb contaminants from the gas stream. Desorption occurs by lowering the pressure. Application of PSA to biogas has been performed in the United States and Europe. Pretreatment is recommended prior to employing this process for carbon dioxide adsorption. This includes reducing hydrogen sulfide levels and dehydrating the gas. Parameters affecting the collection include temperature, total pressure, and partial pressure of the constituent gases. In PSA, the pressure is swung (since CO<sub>2</sub> is adsorbed more easily than CH<sub>4</sub> under high pressure) and the CH<sub>4</sub>-rich gas that is not adsorbed flows through the vessel. Once the adsorbent in the vessel is saturated, adsorbed CO<sub>2</sub> is removed

by reducing the pressure to ambient. A cycle of PSA adsorption and desorption is typically relatively short since common industrial practice is to use multiple vessels to maintain a constant feed flow and output gas product. PSA operates at relatively high pressure; the pressure of the product gas ranges from 100 to 200 psig.

### Adsorbents

Although Pressure Swing Adsorption, Temperature Swing Adsorption, Inert Purge, and Displacement Purge cycles make regeneration of adsorbents possible, not all adsorbents are economically regenerable. There are a number of options for cleanup using adsorbents. Silica- or alumina-based adsorbents are preferred for gas dehydration operations. Gas cleanup adsorption methods would employ molecular sieves or carbon-based adsorbents. Carbon-based adsorbents can be activated making them capable of organic vapor adsorption. Molecular sieves are unique in that they are capable of dehydration and selective adsorption.

Molecular sieves used as adsorbents occur in nature, but the most commonly used sieves are synthetic. They are commonly referred to as zeolites. Molecular sieves are capable of adsorbing or excluding a molecule based on size. High adsorption capacity at low concentrations, as well as possessing a high affinity for polar compounds ( $\text{H}_2\text{S}$ ,  $\text{H}_2\text{O}$ ,  $\text{NH}_3$ , etc.), make it an attractive product for gas purification. The four most widely used are types 3A, 4A, 5A, and 13X, where the type name refers to the size of molecules it will absorb. For instance, type 4A will not absorb any molecule larger than 4 Ångströms (1 Ångström =  $1 \times 10^{-10}$  meters). Type 13X has a pore size of 10 Ångströms. In regard to gas processing, pore size limitations of 4A and 5A sieves can only adsorb light mercaptans, making a 13X a preferred adsorbent for complete sulfur removal. With size 13X, preferential adsorption of polar compounds allows for selective removal of water and hydrogen sulfide over carbon dioxide.

Carbon-based materials with the ability to adsorb have been dubbed 'active carbon' or 'activated carbon'. A significant number of source materials have been used to produce them including wood, nutshells, rice hulls, bones, petroleum coke, and coal to name a few. In order to 'activate' the carbon material, source materials are ground, mixed with a binder, extruded, and heated. Additional steps like adding chemicals or using oxidizing gases can increase adsorption properties. Active carbons are preferred adsorbents for removal and recovery of volatile organic compounds and odor abatement as a form of air pollution control.

To adapt active carbons to remove hydrogen sulfide, they can be impregnated. Carbons impregnated with compounds like sodium hydroxide or sodium carbonate can attract and keep sulfur compounds through an acid-base reaction. This has been shown to increase hydrogen sulfide and methyl mercaptan adsorption by 40-60 times that of the original carbon. Metal oxide impregnated carbons contain sulfur as metal sulfates or sulfides.



## *Absorption*

### Oxides

One of the most common absorption processes is an iron oxide-based sulfur scavenging process in which hydrogen sulfide reacts with iron oxide to form iron sulfide while the biogas flows through a granular iron-oxide in a bed. Some iron oxide processes are regenerable with air, meaning they can be used repeatedly without a chemical change out. The conventional iron oxide product is known as “iron sponge” which originally consisted of steel wool coated with rust. “Iron sponge” has a number of drawbacks. Special care must be taken during regeneration to prevent ignition of the sponge from heat buildup. Each regeneration of the media reduces its effectiveness by 33% creating the need to change out old media which results in waste material that must be disposed. A complication of the amount of spent product is that it is considered hazardous in some instances and should not be put into a landfill without remediation. The change out process can be labor intensive and the overall use of “iron sponge” can create high operating costs. Iron oxides are not as selective as zinc oxides, which are more favorable for removing only trace amounts of hydrogen sulfide. Zinc oxides remove hydrogen sulfide from gas streams by a reaction that forms insoluble zinc sulfide. A potentially major drawback of zinc oxides for biogas cleanup is that the temperature requirement for effective performance is around 200 °C. Information about the main iron oxide products currently in the market is shown in Table 10.

Table 10. Iron Oxide Products

	Iron Sponge	Sulfa Treat®	Sulfur-Rite®	SULFA-BIND®
<b>Substrate containing iron oxide material</b>	Wood chips	Proprietary granules	Ceramic base	Calcinated inorganic natural material
<b>Coated or impregnated</b>	Impregnated	Coated	Impregnated	Coated
<b>Primary constituent</b>	Fe <sub>2</sub> O <sub>3</sub> , Fe <sub>3</sub> O <sub>4</sub>	Fe <sub>2</sub> O <sub>3</sub> , Fe <sub>3</sub> O <sub>4</sub>	Not known	Fe(OH) <sub>3</sub>
<b>Regenerable?</b>	Y, up to 3x	N	N	Y, up 15x
<b>Pyrophoric</b>	Y	N	N	N
<b>H<sub>2</sub>S Removed per Kilogram of product</b>	2.5 kg H <sub>2</sub> S / kg Fe <sub>2</sub> O <sub>3</sub>	0.55-0.72 kg H <sub>2</sub> S / kg Fe <sub>2</sub> O <sub>3</sub>	Not known	0.5 kg H <sub>2</sub> S / kg media
<b>Spent media</b>	Y	N	N	N
<b>Reduction of H<sub>2</sub>S</b>	3600 ppm to < 1ppm	Not known	Down to < 1ppm	60-100 ppm to < 0.2 ppm
<b>Cost per removed kg of H<sub>2</sub>S</b>	\$0.35-1.55	\$4.85-5.00	\$7.95-8.50	\$2.90-3.00
<b>Annual product cost? (100 ppm-400 ppm loading)</b>	\$250-4,300	\$3,400-13,500	5,560-23,840	\$2,050-8,290

## Amine Solutions

In absorption processes, molecules in the gas phase (e.g., H<sub>2</sub>S and CO<sub>2</sub>) are removed as they become liquids in solutions. The amine process, one of the most common absorption processes in the natural gas industry, uses aqueous solutions of various alkanolamines to remove H<sub>2</sub>S and CO<sub>2</sub>. In a typical process, a CO<sub>2</sub>- and H<sub>2</sub>S-rich gas passing upward through an absorber contacts a downward-flowing amine solution that absorbs CO<sub>2</sub> and H<sub>2</sub>S. The reaction is depicted in the following equation where the amine is R<sub>3</sub>N.



Once the reaction has taken place, the amine can be regenerated by dropping the pressure and increasing the temperature. The regeneration reaction is shown below.

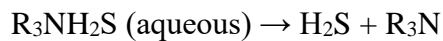

The hydrogen sulfide is in a concentrated form which is either flared or converted to elemental sulfur using air in a sulfur recovery unit represented by the following equation.

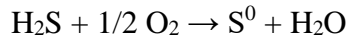

Regeneration of the amine is done by the same method above, consisting of a drop in pressure and an increase in temperature. The equations corresponding to carbon dioxide removal and amine regeneration are shown below.

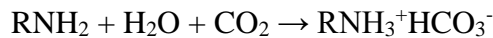

Drawbacks of amine processes on a small scale include high energy needs for regeneration, stringent safety measures regarding concentrated hydrogen sulfide gas streams, complicated flows, and foaming issues associated with liquid absorption procedures. Removal of carbon dioxide via amines has disadvantages that include corrosion, breakdown of the amine, and buildup of contaminants. Table 4 lists commonly used amines, while Table 5 lists proprietary amine processes and their descriptions.

Table 11. Generic Amines

Common Name	Name
<b>MEA</b>	Monoethanol amine
<b>DEA</b>	Diethanol amine
<b>MDEA</b>	Methyl diethanol amine
<b>DIPA</b>	Diisopropanol amine
<b>DGA</b>	Diglycolamine

Table 12. Proprietary Amines

Process Name	Description
<b>Sulfa-Scrub® (Quaker Chemical)</b>	Hexahydrotriazine
<b>Sulfinol-X (Shell)</b>	A mixture of two or more alkanolamines—generally a base amine such as MDEA or Sulfinol-X (diisopropanolamine) and an accelerator.
<b>ADIP-X (Shell)</b>	A mixture of two or more alkanolamines—generally a base amine such as MDEA and an accelerator.
<b>The ELIMINATOR™ (Gas Technology Products)</b>	A high molecular weight hexahydrotriazine-based chemical
<b>COOAB™ (Cirmac)</b>	Special amine composition

### Chelated-Iron Solutions

The two major chelated-iron processes are LO-CAT® trademarked by Gas Technology Products and Sulferox® service marked by Shell Oil Company. Both marketed processes operate on reduction/oxidation (redox) reactions. During a redox reaction, oxidation numbers are changed. In both processes, the iron oxidation number is reduced and hydrogen sulfide is separated into elemental sulfur by an increase of its oxidation number. Regeneration is possible with both processes and is accomplished by an oxidation reaction. Sulferox® is recommended for use with gas flows less than 10 MM m<sup>3</sup>/day that contain between 100 kg and 5 ton of sulfur per day. LO-CAT® has a typical range of 150 lbs to 20 long tons (22.4 tons) of sulfur per day at flow rates up to 10,000 SCFM. Sulferox® claims removal of hydrogen sulfide to less than 1 ppmv. LO-CAT® asserts their units can be designed to achieve better than 99.9% hydrogen sulfide removal efficiency. Gas Technology Products also offers MINI-CAT™ units which use the same catalyst as LO-CAT® but are designed to remove 100-1,000 kg sulfur per day. MINI-CAT™ units are prefabricated, skid-mounted, and have a smaller footprint than the LO-CAT® units.

### Water and Solvent Scrubbing

Water scrubbing is a cheap and simple method for cleanup and is most appropriate for an operation where water is easily accessible, such as at a water treatment facility. One advantage of water scrubbing is the simultaneous removal of hydrogen sulfide and carbon dioxide. Biogas cleaning by water scrubbing loses about 2% methane during processing but results in a gas that contains roughly 95% methane.

Water scrubbing is accomplished by pressurizing the biogas and injecting it into the bottom of a packed column containing water flowing from the top. The water dissolves the carbon dioxide and passes out of the bottom of the column. The “cleaned” gas leaves the top of the column. The water can be circulated into an air column for regeneration, i.e., CO<sub>2</sub> removal, and then passed back into the column. However, regeneration is not recommended for gas streams containing large amounts of hydrogen sulfide.

Solvents, including amines, can replace water in the packed column to improve the scrubbing process. Solvent scrubbing is more efficient than water washing since carbon dioxide and hydrogen sulfide are more soluble in solvents than water. This results in lower solvent and pumping requirements. Solvents also have the ability to upgrade the methane content to above 95%.

### ***Cryogenic Distillation***

Cryogenic distillation uses the relatively higher boiling temperature of CO<sub>2</sub>-as compared with CH<sub>4</sub>-to separate it from landfill gas. As in the amine process, dry compressed landfill gas enters the bottom of an absorber column, flows upward, and contacts a downward-flowing solution (in this case, liquid CO<sub>2</sub>), which “washes” out contaminants. When the contaminant-free landfill gas is cooled by refrigeration at the top of the absorber (typical gas temperature is -59°F), the CO<sub>2</sub> in the gas is condensed. The clean gas exits at the top of the absorber, and some of the liquid CO<sub>2</sub> can be collected for possible co-product use. The rest of the CO<sub>2</sub> flows downward as the absorbent. Since the contaminant-free gas contains a higher CO<sub>2</sub> concentration (~27%), which is higher than pipeline quality natural gas or transportation fuel, further treatment or post purification (for example, using membrane separation) is required.

### **Renewable Natural Gas Specifications**

A requirement of transportation of natural gas by pipelines is that the gas must be free of contaminants in order to minimize problems with operation and maintenance. Therefore, biomethane must not contain constituents at concentrations which would prevent or restrict the normal marketing of biomethane, be it at levels that would be injurious to pipeline facilities, or at levels that would present a health and/or safety hazard to Utility employees and/or the general public.

For biomethane to be accepted and transported in the Utility pipeline system, it must be periodically tested and monitored based on the biogas source. The Trigger Level is the level where additional periodic testing and analysis of the constituent is required. The Lower Action Level, where applicable, is used to screen biomethane during the initial biomethane quality review and as an ongoing screening level during the periodic testing. The Upper Action Level, where applicable, establishes the point at which the immediate shut-off of the biomethane supply occurs.

Table 13 presents the main biomethane quality specifications as established by the Southern California Gas Company (Rule No. 30).

Table 13. Biomethane Quality Specifications

Constituent	Trigger Level mg/m <sup>3</sup> (ppm <sub>v</sub> ) <sup>i</sup>	Lower Action Level mg/m <sup>3</sup> (ppm <sub>v</sub> )	Upper Action Level mg/m <sup>3</sup> (ppm <sub>v</sub> )
<u>Carcinogenic Constituents</u>			
<b>Arsenic</b>	0.019 (0.006)	0.19 (0.06)	0.48 (0.15)
<b>p-Dichlorobenzenes</b>	5.7 (0.95)	57 (9.5)	140 (24)
<b>Ethylbenzene</b>	26 (6.0)	260 (60)	650 (150)
<b>n-Nitroso-di-n-propylamine</b>	0.033 (0.006)	0.33 (0.06)	0.81 (0.15)
<b>Vinyl chloride</b>	0.84 (0.33)	8.4 (3.3)	21 (8.3)
<u>Non-Carcinogenic Constituents</u>			
<b>Antimony</b>	0.60 (0.12)	6.0 (1.2)	30 (6.1)
<b>Copper</b>	0.060 (0.02)	0.6 (0.23)	3 (1.2)
<b>Hydrogen sulfide</b>	30 (22)	300 (216)	1500 (1080)
<b>Lead</b>	0.075 (0.009)	0.75 (0.09)	3.8 (0.44)
<b>Methacrolein</b>	1.1 (0.37)	11 (3.7)	53 (18)
<b>Toluene</b>	904 (240)	9000 (2400)	45000 (12000)
<b>Alkyl thiols (mercaptans)</b>	(12)	(120)	(610)
<b><i>Pipeline Integrity Protective Constituent Levels<sup>ii</sup></i></b>			
<b>Siloxanes</b>	0.01 mg Si/m <sup>3</sup>	0.1 mg Si/m <sup>3</sup>	-
<b>Ammonia</b>	0.001 vol%	-	-
<b>Hydrogen</b>	0.1 vol%	-	-
<b>Mercury</b>	0.08 mg/m <sup>3</sup>	-	-
<b>Biologicals</b>	4 x 10 <sup>4</sup> /scf (qPCR per APB, SRB, IOB <sup>iii</sup> group) and commercially free of bacteria of >0.2 microns	-	-

Notes:

- i) The first number in this table are in milligrams per cubic meter of air (mg/m<sup>3</sup>), while the second number ( ) is in parts per million by volume (ppmv).
- ii) The Pipeline Integrity Protective Constituent Lower and Upper Action Limits not provided above will be established in the Commission's next ABI900 update proceeding. Until that time, Biomethane supplies that contain Pipeline Integrity Protective Constituents exceeding the Trigger Level, but lacking a Lower or Upper Action Level, will be analyzed and addressed on a case-by-case basis based on the biomethane's potential impact on pipeline system integrity.
- iii) APB-Acid Producing Bacteria; SRB-Sulfate-reducing Bacteria; IOB-Iron-oxidizing Bacteria

Based on this regulation (Rule No. 30), biomethane Constituent Testing is solely dependent on the biomethane source. Specifically, biomethane from landfills shall be tested for all Health Protective Constituents and the Pipeline Integrity Protective Constituents, whereas biomethane from dairies shall be tested for ethylbenzene, hydrogen sulfide, n-Nitroso-di-n-propylamine, mercaptans, toluene, and the Pipeline Integrity

Protective Constituents. Other organic waste sources, including biomethane from publicly owned treatment works (i.e., water treatment and sewage treatment plants) shall be tested for p-Dichlorobenzene, ethylbenzene, hydrogen sulfide, mercaptans, toluene, vinyl chloride, and the Pipeline Integrity Protective Constituents.

## 9 REFERENCES

---

- <sup>1</sup> DOE Alternative Fuel Data Center Natural Gas Station locations  
[http://www.afdc.energy.gov/fuels/natural\\_gas\\_locations.html](http://www.afdc.energy.gov/fuels/natural_gas_locations.html)
- <sup>2</sup> Natural Gas Vehicle Research Roadmap Draft, July 2015, CEC-500-2015-091-D
- <sup>3</sup> UCD. The Feasibility of Renewable Natural Gas as a Large-Scale, Low Carbon Substitute Contract No. 13-307
- <sup>4</sup> California Fuel Cell Partnership. Medium- & Heavy-duty Fuel Cell Electric Truck Action Plan for California, November 8, 2016. [http://cafcp.org/sites/default/files/MD-HD\\_FCET-AP-Webinar-Nov-8-2016.pdf](http://cafcp.org/sites/default/files/MD-HD_FCET-AP-Webinar-Nov-8-2016.pdf)
- <sup>5</sup> E4Tech The Fuel Cell Industry Review 2015, 2015.  
<http://www.fuelcellindustryreview.com/archive/TheFuelCellIndustryReview2015.pdf>
- <sup>6</sup> Yang, Christopher, Sonia Yeh, Saleh Zakerinia, Kalai Ramea, David L. McCollum (2015) Achieving California's 80% Greenhouse Gas Reduction Target in 2050: Technology, Policy and Scenario Analysis Using CA-TIMES Energy Economic Systems Model. *Energy Policy* 77, 118 – 130.
- <sup>7</sup> <http://docs.cpuc.ca.gov/SearchRes.aspx?DocFormat=ALL&DocID=152572023>
- <sup>8</sup> Parker, Nathan C. (2004) Using Natural Gas Transmission Pipeline Costs to Estimate Hydrogen Pipeline Costs. Institute of Transportation Studies, University of California, Davis, Research Report UCD-ITS-RR-04-35  
<https://its.ucdavis.edu/research/publications/>
- <sup>9</sup> Smith, M and, Gonzales J., Cost Associated With Compressed Natural Gas Vehicle Fueling Infrastructure. September, 2014. [http://www.afdc.energy.gov/uploads/publication/cng\\_infrastructure\\_costs.pdf](http://www.afdc.energy.gov/uploads/publication/cng_infrastructure_costs.pdf)
- <sup>10</sup> USDOE. H2A (Hydrogen Analysis) Model. Accessed December 12, 2016.  
[https://www.hydrogen.energy.gov/h2a\\_delivery.html](https://www.hydrogen.energy.gov/h2a_delivery.html)
- <sup>11</sup> Bandivadekar, A., Bodek, K., Cheah, I., Evans, C. Groode, T., Heywood, J. Kasseris, E. Kromer, M. and Weiss, M., On the Road in 2035: Reducing Transportation's Petroleum Consumption and GHG Emissions. MIT Laboratory for Energy and the Environment, 2008.
- <sup>12</sup> Greene, D. L., Leiby, P. N., James, B., Perez, J., Melendez, M., Milbrandt, A., Unnasch, S., and Hooks, M., "Analysis of the Transition to Hydrogen Fuel Cell Vehicles and the Potential Hydrogen Energy Infrastructure Requirements," ORNL/TM-2008/30. Oak Ridge National Laboratory, March 2008.
- <sup>13</sup> Ogden, J. and Nicholas, M. "Analysis of a "Cluster" Strategy for Introducing Hydrogen Vehicles in Southern California", *Energy Policy*, 39, 2011, pp.1923–1938.
- <sup>14</sup> Morrison, Geoffrey, Nathan C. Parker, Julie Witcover, Lewis Fulton, Yu Pei, (2014) Comparison of Supply and Demand Constraints on U.S. Biofuels Expansion. *Energy Strategy Reviews* 5, 42-47
- <sup>15</sup> Dominguez-Faus, Rosa, Christian Folberth, Jungo Liu, Amy Myers Jaffe, Pedro J. Alvarez (2013) Climate Change Would Increase the Water Intensity of Irrigated Corn Ethanol *Environmental Science & Technology*, 47 (11) 6030-6037
- <sup>16</sup> Christopher R. Knittel, Reducing Petroleum Consumption from Transportation, *Journal of Economic Perspectives*, 26 (10 Winter 2013)
- <sup>17</sup> Ogden, J. M., Steinbugler, M.M., Kreutz, T. G., A comparison of hydrogen, methanol and gasoline as fuels for fuel cell vehicles: implications for vehicle design and infrastructure development, *Journal of Power Sources*, 79 (2) 143-168; George Apanel, Eric Johnson, Direct Methanol Fuel Cells –ready to go commercial *Fuel Cells Bulletin*, November 2004
- <sup>18</sup> Sierzchula, W., et al. The influence of financial incentives and other socio-economic factors on electric vehicle adoption. *Energy Policy*, Vol. 68, pp. 183-194. 2014. Beyond batteries: An examination of the benefits and barriers to plug-in hybrid electric vehicles (PHEVs) and vehicle-to-grid (V2G) transition. Sovacool, B.K. and Hirsh, R.F. 2009, *Energy Policy*, pp. 1095-1103.
- <sup>19</sup> Peter C. Flynn, "Commercializing an alternative vehicle fuel: Lessons learned from natural gas for vehicles". *Energy Policy*, 30 613-619. 2002.
- <sup>20</sup> U.S. Department of Energy (DOE). 2015a. "Clean Cities Alternative Fuel Price Reports".  
<http://www.afdc.energy.gov/publications/search/keyword/?q=alternative%20fuel%20price%20report>.
- <sup>21</sup> CEC Research Roadmap for Natural Gas Vehicles. <http://www.energy.ca.gov/2015publications/CEC-500-2015-091/CEC-500-2015-091-D.pdf>
- <sup>22</sup> Anthony Greszler, "DME from Natural Gas or Biomass: A Better Fuel Alternative", Volvo Group Truck Technology, presented at SAE International, 2013.  
[http://www.sae.org/events/gim/presentations/2013/greszler\\_anthony.pdf](http://www.sae.org/events/gim/presentations/2013/greszler_anthony.pdf), June 8, 2016.



- 
- <sup>23</sup> Rood-Werpy M., Santini D, Burnham A., and Mintz M. 2010. Natural Gas Vehicles: Status, Barriers, and Opportunities ANL/ESD/10-4 Energy Systems Division.
- <sup>24</sup> Krupnick AJ, “Will Natural Gas Vehicles Be in Our Future?” May 2011. Issue Brief 11-06. Resources for the Future.
- <sup>25</sup> M. Kuby, L. Lines, R. Schultz, Z. Xie, J.-G. Kim, and S. Lim, “Optimization of hydrogen stations in Florida using the Flow-Refueling Location Model,” *Int. J. Hydrogen Energy*, vol. 34, no. 15, pp. 6045-6064, Aug. 2009.
- <sup>26</sup> Kelley S and Kuby M. On the Way or Around the Corner? Observed Refueling Choices of Alternative-Fuel Drivers in Southern California. *Journal of Transport Geography* December 2013. 33:258-267.
- <sup>27</sup> Kuby, Michael, Scott Kelley, and Joseph Schoenemann. Spatial Refueling Patterns of Alternative-Fuel and Gasoline Vehicle Drivers in Los Angeles. *Transportation Research Part D – Transport and Environment* December 2013. 25:84-92.
- <sup>28</sup> Nath R, Aubert G, Dewar A. A Realistic View of CNG Vehicles in the U.S. The Boston Consulting Group. June 16, 2014; Christopher Knittel, Leveling the Playing Field for Natural Gas in Transportation, Hamilton Project discussion paper, Brookings Institution
- <sup>29</sup> Dimitropoulos A, Rietveld P, van Ommeren JN. Consumer valuation of changes in driving range: A meta-analysis. *Transportation Research Part A: Policy and Practice*. Volume 55, September 2013, Pages 27–45
- <sup>30</sup> Mosquet X, Devineni M, Mezger T, Zablitz H, Dinger A, Sticher G, Gerrits M, and Russo M. Compressed Natural Gas. A Potential Bridge Technology? The Boston Consulting Group. July 6, 2011.
- <sup>31</sup> Rosentiel DP, Heuermann DF, Husig S, Why has the introduction of natural gas vehicles failed in Germany? Lessons on the role of market failure in markets for alternative fuel vehicles. *Energy Policy*. Volume 78, March 2015, Pages 91–101
- <sup>32</sup> Struben J and Sterman JD. Transition challenges for alternative fuel vehicle and transportation systems. *Environment and Planning B: Planning and Design* 2008, volume 35, pages 1070-1097
- <sup>33</sup> CEC (2015) Natural Gas Vehicle Research Roadmap (draft) July 2015, CEC-500-2015-091-D. Prepared for: California Energy Commission, Prepared by: National Renewable Energy Laboratory.
- <sup>34</sup> Jaffe A.M., Dominguez-Faus R., Lee A., Medlock K., Parker N., Sheitrum D., Burke A., Zhao H., Fan Y. Exploring The Role of Natural Gas in U.S. Trucking. A NextSTEPS white paper by: NextSTEPS (Sustainable Transportation Energy Pathways) Program UC Davis Institute of Transportation Studies February 18, 2015
- <sup>35</sup> McKinney, J., Bond, E., Crowell, M., Odufuwa, E. Joint Agency Staff Report on Assembly Bill 8: Assessment of Time and Cost Needed to Attain 100 Hydrogen Refueling Stations in California. California Energy Commission. CEC-600-2015-016. 2015. <http://www.energy.ca.gov/2015publications/CEC-600-2015-016/CEC-600-2015-016.pdf>
- <sup>36</sup> Ogden, J.M., Yang, C., Nicholas, M.A., Fulton, L. NextSTEPS white paper: the hydrogen transition. Institute of Transportation Studies, University of California, Davis, Research Report UCD-ITS-RR-14-11. 2014. [http://www.its.ucdavis.edu/research/publications/publication-detail/?pub\\_id=2312](http://www.its.ucdavis.edu/research/publications/publication-detail/?pub_id=2312)
- <sup>37</sup> Brown, T., Smith Schell, L., Stephens-Romero, S., Samuelson, G.S., Economic analysis of near-term California hydrogen infrastructure. *International Journal of Hydrogen Energy*, 38, 3846-3857. 2013.
- <sup>38</sup> California Air Resources Board. Annual Evaluation of Fuel Cell Electric Vehicle Deployment and Hydrogen Fuel Station Network Deployment. 2015. [http://www.arb.ca.gov/msprog/zevprog/ab8/ab8\\_report\\_2015.pdf](http://www.arb.ca.gov/msprog/zevprog/ab8/ab8_report_2015.pdf)
- <sup>39</sup> Thorin, E., Boer, E. d., Belous, O., & Song, H. (2012). Waste to Energy- A Review. *International Conference on Applied Energy* (pp. 1-10). Suzhou: ICAE 2012
- <sup>40</sup> <http://www.wsj.com/articles/SB10001424053111904583204576542233226922972>
- <sup>41</sup> Sustainability. (2015). Retrieved December 2015, from <http://corporate.walmart.com: http://corporate.walmart.com/global-responsibility/sustainability/>
- <sup>42</sup> Snider, C., Levitt, M., Plunkett, S., & Clausen, B. (2014). Food Waste to Energy: Community Responses and the Potential for Anaerobic Digestion in Madison. University of Wisconsin- Madison, Undergraduate Geography Colloquium. Madison: University of Wisconsin- Madison.
- <sup>43</sup> Beddoes, J. C., Bracmort, K. S., Burns, R. T., & Lazarus, W. F. (2007). An Analysis of Energy Production Costs from Anaerobic Digestion Systems on U.S. Livestock Production Facilities.
- <sup>44</sup> Bidart, C., Frohling, M., & Schultmann, F. (2013). Municipal Solid Waste and Production of Substitute Natural Gas and Electricity as Energy Alternatives. *Applied Thermal Engineerin*, 51, 1107-1115.
- <sup>45</sup> Environmental Business International, Inc. (2011). The Clean Energy Industry in California: An Economic Analysis Assessing the Current Market in the Global Economy. State of California, Air Resources Board. Sacramento: State of California.
-

- 
- <sup>46</sup> Lazarus, W. F., & Rudstrom, M. (2007). The Economics of Anaerobic Digester Operation on a Minnesota Dairy Farm. *Review of Agricultural Economics*, 29 (2), 349-364
- <sup>47</sup> Klavon, K. H., Lansing, S. A., Mulbry, W., Moss, A. R., & Felton, G. (2013). Economic Analysis of Small-Scale Agricultural Digesters in the United States. *Biomass & Bioenergy*, 54, 36-45.
- <sup>48</sup> Wong, S. C. (2011). Tapping the Energy Potential of Municipal Wastewater Treatment: Anaerobic Digestion and Combined Heat and Power in Massachusetts. Massachusetts Department of Environmental Protection.
- <sup>49</sup> Linville, J. L., Shen, Y., Wu, M. M., & Urgun-Demirtas, M. (2015). Current State of Anaerobic Digestion of Organic Wastes in North America. *Current Sustainable Renewable Energy Report*, 2, 136-144.
- <sup>50</sup> Snider, C., Levitt, M., Plunkett, S., & Clausen, B. (2014). Food Waste to Energy: Community Responses and the Potential for Anaerobic Digestion in Madison. University of Wisconsin- Madison, Undergraduate Geography Colloquium. Madison: University of Wisconsin- Madison
- <sup>51</sup> AB32 Overview <http://www.arb.ca.gov/cc/ab32/ab32.htm>
- <sup>52</sup> Title 40- Protection of Environment. Chapter I- Environmental Protection Agency. Subchapter C- Air Programs. Part 60- Standards of performance for new stationary sources. [http://www.ecfr.gov/cgi-bin/text-idx?tpl=/ecfrbrowse/Title40/40cfr60\\_main\\_02.tpl](http://www.ecfr.gov/cgi-bin/text-idx?tpl=/ecfrbrowse/Title40/40cfr60_main_02.tpl)
- <sup>53</sup> Landfill Methane Outreach Program. (2015, May 28). Retrieved November 2015, from [www.epa.gov](http://www.epa.gov): <http://www3.epa.gov/lmop/basic-info/index.html>
- <sup>54</sup> Bird, D. (2014). Tipping Fees in California. CalRecycle..
- <sup>55</sup> <http://fortune.com/2015/09/03/waste-management-recycling-business/>
- <sup>56</sup> The Feasibility of Renewable Natural Gas as a Large-Scale, Low Carbon Substitute Contract No. 13-307
- <sup>57</sup> <http://docs.cpuc.ca.gov/SearchRes.aspx?DocFormat=ALL&DocID=152572023>
- <sup>58</sup> Nguyen, T., J. Ward, K. Johnson, “Well-to-Wheels Greenhouse Gas Emissions and Petroleum Use for Mid-Size Light-Duty Vehicles,” Program Record (Offices of Bioenergy Technologies, Fuel Cell Technologies & Vehicle Technologies, US Department of Energy, Record #: 13005 (revision #1), May 10, 2013.
- <sup>59</sup> Johnson, N., and J. Ogden, Detailed spatial modeling of carbon capture and storage (CCS) infrastructure deployment in the southwestern United States, *Energy Procedia* (2011). 4: p. 2693-2699.
- <sup>60</sup> I. Scholjberg, et al., “Small scale reformers for on-site hydrogen supply”, *Energy Procedia* 29 (2012), 559-566.
- <sup>61</sup> Ogden, J., “Review Of Small Stationary Reformers For Hydrogen Production”, Report To The International Energy Agency, March 9, 2001. <http://www.afdc.energy.gov/pdfs/31948.pdf>
- <sup>62</sup> Nils Johnson, Nathan Parker, Joan Ogden, “How negative can biofuels with CCS take us and at what cost? Refining the economic potential of biofuel production with CCS using spatially-explicit modeling,” *Energy Procedia* 00 (2013) 000–000
- <sup>63</sup> Yang, C. and J. Ogden. “Renewable and Low Carbon Hydrogen for California – Modeling The Long Term Evolution of Fuel Infrastructure Using a Quasi-Spatial TIMES Model.” *International Journal of Hydrogen Energy*. 38 (11) p 4250-4265. 2013.
- <sup>64</sup> Gahleitner, G., 2013. Hydrogen from renewable electricity: An international review of power-to-gas pilot plants for stationary applications. *International Journal of Hydrogen Energy*, 38(5), pp.2039–2061. Available at: <http://www.sciencedirect.com/science/article/pii/S0360319912026481>
- <sup>65</sup> United Nations, Intergovernmental Panel on Climate Change, Special Report on Renewable Energy, May 2011. Sims, R., P. Mercado, W. Krewitt, G. Bhuyan, D. Flynn, H. Holttinen, G. Jannuzzi, S. Khennas, Y. Liu, M. O’Malley, L. J. Nilsson, J. Ogden, K. Ogimoto, H. Outhred, Ø. Ulleberg, F. van Hulle, 2011: Integration of Renewable Energy into Present and Future Energy Systems. In IPCC Special Report on Renewable Energy Sources and Climate Change Mitigation [O. Edenhofer, R. Pichs-Madruga, Y. Sokona, K. Seyboth, P. Matschoss, S. Kadner, T. Zwickel, P. Eickemeier, G. Hansen, S. Schlömer, C. von Stechow (eds)], Cambridge University Press, Cambridge, United Kingdom and New York, NY, USA
- <sup>66</sup> McKinney, J., Bond, E., Crowell, M., Odufuwa, E. Joint Agency Staff Report on Assembly Bill 8: Assessment of Time and Cost Needed to Attain 100 Hydrogen Refueling Stations in California. California Energy Commission. CEC-600-2015-016. 2015. <http://www.energy.ca.gov/2015publications/CEC-600-2015-016/CEC-600-2015-016.pdf>
- <sup>67</sup> Nicholas, M. A. and Ogden, J. M. “Detailed Analysis of Urban Station Siting for California Hydrogen Highway Network,” *Transportation Research Record* 1983. 2007, 121–28
- <sup>68</sup> California Air Resources Board, “Annual Evaluation of Fuel Cell Electric Vehicle Deployment and Hydrogen Fuel Station Network Deployment” July 2015. [http://www.arb.ca.gov/msprog/zevprog/ab8/ab8\\_report\\_2015.pdf](http://www.arb.ca.gov/msprog/zevprog/ab8/ab8_report_2015.pdf)
-

- 
- <sup>69</sup> McKinney, Jim, et al. 2015. California Energy Commission and California Air Resources Board Joint Agency Staff Report on Assembly Bill 8: Assessment of Time and Cost Needed to Attain 100 Hydrogen Refueling Stations in California. California Energy Commission. Publication Number: CEC-600-2015-016. <http://www.energy.ca.gov/2015publications/CEC-600-2015-016/CEC-600-2015-016.pdf>
- <sup>70</sup> Melaina, M. W., Antonia, O., & Penev, M. (2013). Blending Hydrogen into Natural Gas Pipeline Networks : A Review of Key Issues Blending Hydrogen into Natural Gas Pipeline Networks : A Review of Key Issues. NREL, (March). <http://doi.org/10.2172/1068610>
- <sup>71</sup> Final Report: Transitioning the Transportation Sector: Exploring the Intersection of Hydrogen Fuel Cell and Natural Gas Vehicles, September 9, 2014. American Gas Association, 400 N. Capitol St., NW, Washington, DC 20001. Organized in partnership by: Sandia National Laboratories, AGA and Toyota, in support of the U.S. Department of Energy. [http://energy.gov/sites/prod/files/2015/02/f19/2015-01\\_H2NG-Report-FINAL.pdf](http://energy.gov/sites/prod/files/2015/02/f19/2015-01_H2NG-Report-FINAL.pdf)
- <sup>72</sup> JRC (2014) Final Report Summary and Main Outcomes. Workshop "Putting Science into Standards: Power-to-Hydrogen and HCNG" EARTO, the European Standards Organisations and the European Commission's Joint Research Centre JRC Petten, The Netherlands, 21-22 October 2014. The presentations of the workshop can be downloaded from: <https://ec.europa.eu/jrc/en/event/workshop/workshop-putting-science-standards-power-hydrogen-andhcng/presentations-keynotes-conclusions>
- <sup>73</sup> Final Report: Transitioning the Transportation Sector: Exploring the Intersection of Hydrogen Fuel Cell and Natural Gas Vehicles, September 9, 2014. American Gas Association, 400 N. Capitol St., NW, Washington, DC 20001. Organized in partnership by: Sandia National Laboratories, AGA and Toyota, in support of the U.S. Department of Energy. [http://energy.gov/sites/prod/files/2015/02/f19/2015-01\\_H2NG-Report-FINAL.pdf](http://energy.gov/sites/prod/files/2015/02/f19/2015-01_H2NG-Report-FINAL.pdf)
- <sup>74</sup> Pipeline & gas journal's 2009 international pipeline construction report . Pipeline & Gas Journal. Voluem 236. Issue Number 8. Pp 20-27 <https://trid.trb.org/view.aspx?id=905768>
- <sup>75</sup> R.13-02-008 (AB 1900) Comments on California's Challenges & Potential Solutions to Procuring Biomethane (RNG) [http://www.energy.ca.gov/2013\\_energypolicy/documents/2013-05-31\\_workshop/comments/Coalition\\_for\\_RNGs\\_Comments\\_and\\_Presentation\\_2013-06-14\\_TN-71272.pdf](http://www.energy.ca.gov/2013_energypolicy/documents/2013-05-31_workshop/comments/Coalition_for_RNGs_Comments_and_Presentation_2013-06-14_TN-71272.pdf)
- <sup>76</sup> <http://docs.cpuc.ca.gov/SearchRes.aspx?DocFormat=ALL&DocID=152572023>
- <sup>77</sup> Ogden J., et al., "The Hydrogen Pathway" in Sustainable Transportation Energy Pathways: A Research Summary for Decisionmakers, Joan Ogden and Lorraine Anderson, ed.s, Regents of the University of California, Davis campus. Available under a Creative Commons BY-NC-ND, 3.0 license, published 2011, p. 38-63.
- <sup>78</sup> Ogden, J., High Hopes for Hydrogen, Scientific American, vol. 295, September 2006, pp. 94-101.
- <sup>79</sup> Jonathan Weinert and Joan Ogden, "A Near-term Economic Analysis of Hydrogen Fueling Stations," Proceedings of the 2005 National Hydrogen Association Meeting, Washington, DC, March 2005
- <sup>80</sup> Ogden, Joan M., Joshua M. Cunningham, Michael A. Nicholas (2010) Roadmap for Hydrogen and Fuel Cell Vehicles in California: A Transition Strategy through 2017. Institute of Transportation Studies, University of California, Davis, Research Report UCD-ITS-RR-10-04
- <sup>81</sup> Saber D.L., Takach, S. F., Technology Investigation Assessment and Analysis, Task 1 Final Report, GTI Project Number 20614, Gas Technology Institute, September 30, 2009
- <sup>82</sup> Resistance of solid wall polyethylene pipe to a sanitary sewerage environment TN-15/2009, The Plastics Pipe Institute, June 2009, [https://plasticpipe.org/tn-15\\_polyethylene\\_resistance\\_sanitary\\_sewage.pdf](https://plasticpipe.org/tn-15_polyethylene_resistance_sanitary_sewage.pdf)
- <sup>83</sup> Decision regarding the biomethane implementation tasks in Assembly Bill 1900. Decision 14-01-034, January 16, 2014, [http://www.pge.com/pipeline\\_resources/pdf/library/cpuc\\_order\\_14\\_01\\_034.pdf](http://www.pge.com/pipeline_resources/pdf/library/cpuc_order_14_01_034.pdf)
- <sup>84</sup> California Fuel Partnership. 2016.
- <sup>85</sup> Ogden, J.M., 2014. H2 and NG as transport fuels, presented at Transitioning the Transportation Sector: Exploring the Intersection of Hydrogen Fuel Cell and Natural Gas Vehicles, September 9, 2014, American Gas Association, 400 N. Capitol St., NW, Washington, DC 20001.
- <sup>86</sup> U.S. Department of Energy, H2A (Hydrogen Analysis) Model, accessed December 12, 2016. [https://www.hydrogen.energy.gov/h2a\\_delivery.html](https://www.hydrogen.energy.gov/h2a_delivery.html)
- <sup>87</sup> USDOE. H2A (Hydrogen Analysis) Model. 2016.
- <sup>88</sup> Qadrdan, M., Abeysekera, M., Chaudry, M., Wu, J., & Jenkins, N. (2015). Role of power-to-gas in an integrated gas and electricity system in Great Britain. International Journal of Hydrogen Energy, 40(17), 5763–5775. <http://doi.org/10.1016/j.ijhydene.2015.03.004>
- <sup>89</sup> G. Minter, "New Natural Gas Pathways for California:"Decarbonizing the Pipeline," presented at Southern California Gas webinar, <https://www.socalgas.com/smart-energy/presentations-webinars/decarbonizing-the-pipeline>
-

- 
- <sup>90</sup> International Energy Agency, “Technology Roadmap: Hydrogen and Fuel Cells,” OECD/IEA, 2015 International Energy Agency 9 rue de la Fédération 75739 Paris Cedex 15, FRANCE.  
<https://www.iea.org/publications/freepublications/publication/TechnologyRoadmapHydrogenandFuelCells.pdf>
- <sup>91</sup> Zhongquan Zhou and Daniel Ersoy, Gas Technology Institute, “Review Studies of Hydrogen Use in Natural Gas Distribution Systems,” prepared for the National Renewable Energy Laboratory, 1617 Cole Blvd., Golden, CO 80401. October 2010. This report appears as Appendix A in Melaina, M. W., Antonia, O., & Penev, M. (2013). Blending Hydrogen into Natural Gas Pipeline Networks: A Review of Key Issues Blending Hydrogen into Natural Gas Pipeline Networks : A Review of Key Issues. NREL, (March). <http://doi.org/10.2172/1068610>
- <sup>92</sup> Tanja Schaaf, Jochen Grünig, Markus Roman Schuster, Tobias Rothenfluh and Andreas Orth. Methanation Of CO<sub>2</sub> - Storage Of Renewable Energy In A Gas Distribution System, *Energy, Sustainability And Society*20144:2. Doi: 10.1186/S13705-014-0029-1
- <sup>93</sup> International Energy Agency, “Technology Roadmap: Hydrogen and Fuel Cells,” OECD/IEA, 2015 International Energy Agency 9 rue de la Fédération 75739 Paris Cedex 15, FRANCE.  
<https://www.iea.org/publications/freepublications/publication/TechnologyRoadmapHydrogenandFuelCells.pdf>
- <sup>94</sup> Manuel Götz , , Jonathan Lefebvre, Friedemann Mörsa, Amy McDaniel Koch, Frank Graf, Siegfried Bajohr, Rainer Reimert, Thomas Kolb Renewable Power-to-Gas: A technological and economic review,” *Renewable Energy*, Volume 85, January 2016, Pages 1371–1390, doi:10.1016/j.renene.2015.07.066
- <sup>95</sup> Fan, Y., Lee, A., Parker, N., Scheitrum, D., Jaffe, A.M., Dominguez-Faus, R., and Medlock, K., 2017. Geospatial, temporal and economic analysis of alternative fuel infrastructure: The case of freight and U.S. natural gas markets. *The Energy Journal*, (forthcoming)
- <sup>96</sup> Fan, Y., Lee, A., Parker, N., Scheitrum, D., Jaffe, A.M., Dominguez-Faus, R., and Medlock, K., 2017. Geospatial, temporal and economic analysis of alternative fuel infrastructure: The case of freight and U.S. natural gas markets. *The Energy Journal*, (forthcoming)
- <sup>97</sup> Miller, M., Burke, A., Zhao, H., Ouellette, P., Fulton, L., Yang, C. Ogden, J., 2017. Transition Scenarios Technical Documentation, Institute of Transportation Studies Working Paper, University of California, Davis.