

UC Berkeley

HVAC Systems

Title

Fans for cooling people guidebook

Permalink

<https://escholarship.org/uc/item/2qd7r5mp>

Authors

Raftery, Paul

Cheung, Toby

Douglass-Jaimes, David

et al.

Publication Date

2023

Data Availability

The data associated with this publication are available at: <https://cbe-berkeley.gitbook.io/fans-guidebook/>

Copyright Information

This work is made available under the terms of a Creative Commons Attribution-NonCommercial-ShareAlike License, available at <https://creativecommons.org/licenses/by-nc-sa/4.0/>

Peer reviewed

Fans for cooling people guidebook

Executive summary

One page summary of the guidebook



Fans for cooling people guidebook

cbe-berkeley.gitbook.io/fans-guidebook

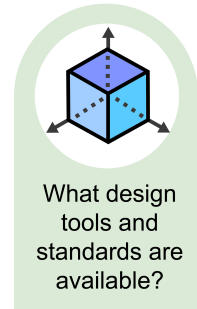
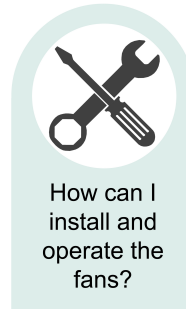
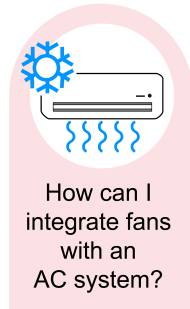

You can use this open-source figure to present the guidebook

Using fans alone or in coordination with HVAC systems to cool people offers several significant enhancements compared to conventional HVAC systems, including improved thermal comfort, indoor air quality, air distribution, energy savings, and initial cost savings.

Despite the numerous benefits of fans and fan-integrated systems, comprehensive resources are unavailable to guide engineers and architects in designing and implementing such systems. The purpose of this guideline is to address this gap and provide practitioners with valuable materials and answers to common questions.

What are the available fan options?

Various fan types are available in the market, such as ceiling fans, desk fans, and pedestal fans. This guideline provides a comprehensive overview of the criteria for fan type selection. These criteria cover blade characteristics, fan size, airflow patterns, fan performance metrics, motors and drives, power and efficiency, and control strategies. Ceiling fans are generally preferred for their higher efficiency, control and effectiveness, but cost, flickering and fixed location are limitations. This guideline can assist users in selecting suitable fan types based on individual building characteristics and specific application needs.

How to integrate fans with my existing AC system?

Adequate fan choice mainly depends on design intents, space characteristics, and HVAC operation strategies. This guidebook discusses which HVAC systems can be integrated with fans. With well-defined design intent, the guidebook provides a step-by-step process for determining the number and size of fans and their layout, ensuring proper fan installation, and integrating the fans with the control of the HVAC system.

How do we implement and operate fans-integrated systems?

Designing a successful fans-integrated system involves more than adding fans to a building. This guidebook assists building designers and operators by helping them adjust appropriate settings in chillers, air handling units, environmental conditions, and operation strategies. This optimization maximizes energy savings while ensuring occupants' comfort within the building. Additionally, the guidelines explore HVAC systems design that can enhance air distribution effectiveness and minimize construction costs. Most importantly, the guidelines outline a transformation strategy for transitioning from conventional air conditioning to a fan-integrated system with minimal disruption to occupants. This comprehensive approach ensures a smooth and efficient integration of fans into the existing air-conditioning infrastructure.

Which design tools and case studies are available?

This guidebook recommends using the [CBE Thermal Comfort Tool](#) and the [CBE Ceiling Fan Design Tool](#). These tools enable users to define the comfort zone with elevated air speed and determine the optimal arrangement of ceiling fans based on room conditions specified by the users. In addition, the guidebook highlights relevant codes and standards related to environmental conditions, fan testing procedures, fire safety, and seismic requirements (subject to variations in different countries' regulations). Furthermore, we presented several case studies of buildings successfully implementing the fan-integrated HVAC system.

We released two versions of our guidebook online: the Practitioner Summary and the Full Guide. These resources support selecting, designing, constructing, operating, and implementing fans and fans-integrated HVAC systems. The [Practitioner Summary](#) offers a concise overview (~15 pages) of key considerations for building practitioners, providing brief descriptions of the fan-integrated system. In contrast, the [Full Guidebook](#) provides a more comprehensive exploration (~70 pages) of the fan and fan-integrated system, including real building references, catering to users from diverse backgrounds. So we expect that many readers, after studying the [Practitioner Summary](#), will move to sections of the [Full Guidebook](#) that are relevant to their work. Fans and fans-integrated HVAC systems will result in more sustainable and healthy buildings.

Practitioner Summary

Benefits of using fans

This guide enables engineers, architects, and facility managers to maximize the many benefits of fans and integrating fans (also known as elevated air movement devices) into HVAC systems. It introduces the advantages of using fans, describes how they work, explains how to select them, and provides guidance and resources for designing spaces with fans in buildings.

The key benefits of fans are as follows:

- **Thermal comfort:** Increased air movement across the skin remove heat from the body by convection and evaporation. Given the ability of some fans to provide more personalized thermal conditions, they can increase comfort.
- **Improved air distribution:** Operation of fans supports the HVAC system to increase air mixing, providing more uniform temperature and air quality distribution throughout a space in both heating and cooling conditions.
- **Improved indoor air quality:** Increased air speed may reduce an occupant's exposure to indoor pollutants via dilution of the concentration of local sources, enhancement of the deposition rate of airborne particles onto indoor surfaces and increased ultraviolet germicidal irradiation system (UVGI) effectiveness for disinfection.
- **Energy savings:** Fans incur significant energy savings by reducing cooling demand of the HVAC system when the indoor temperature setpoints are increased. The HVAC savings potential is about two-orders of magnitude above the fan energy use.
- **Cost savings:** Beside the cost savings related to energy savings, using ceiling fans to distribute air more effectively throughout a space can reduce ductwork and diffusers required to serve a zone. Additionally, the higher temperature cooling setting allows HVAC system size reduction for chiller and air handling units, thus reducing the capital cost.

Elevated air speed and thermal comfort

How air speed meets thermal comfort goals

ASHRAE Standard 55 – Thermal Environmental Conditions for Human Occupancy (2020) identifies six factors that affect thermal comfort, including clothing insulation, metabolic rate, air temperature, mean radiant temperature, relative humidity, and air speed. Increasing air speed enhances heat transfer via convection and evaporation, which provides a cooling sensation named “Cooling Effect”. It allows the body to maintain thermal comfort at higher air temperatures than what would be comfortable in still air. Figure T1 shows how the air speed is associated with cooling effect. More importantly, this cooling effect is instantaneous and beneficial during the transitional moments (i.e., stepping into the building from a hot and humid outdoor environment). The ASHRAE Standard 55 (2020) and the [CBE Thermal Comfort Tool](#) help design how much air movement is needed for thermal comfort and occupant satisfaction.

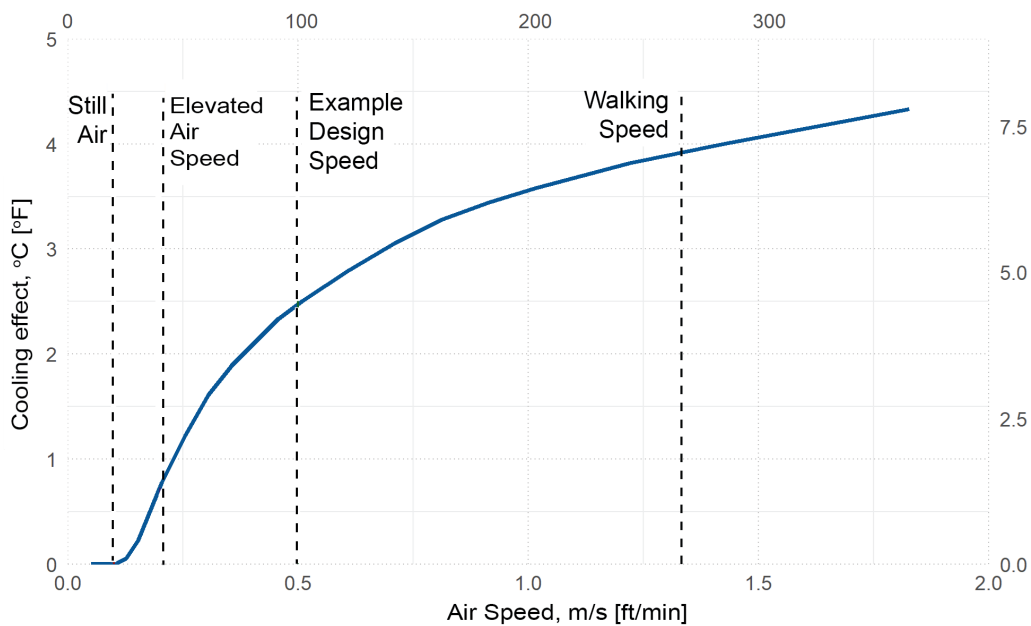

Figure T1. Cooling effect of increased air speed for a 'typical' office worker in cooling conditions (operative temperature of 24.4 °C [76 °F], 50% relative humidity, 0.6 clo, 1.13 met).

Thermal comfort calculation with elevated air speed

ASHRAE Standard 55 (2020) provides a method called The Elevated Air Speed Comfort to calculate thermal comfort in situations of elevated air speed. This method uses a combination of the Analytical Comfort Zone Method combined with the [Standard Effective Temperature \(SET\)](#) method. The SET output translates the six thermal comfort factors (from above) into a single temperature equivalent that can be compared across a variety of comfort conditions. In addition, the cooling effect initiated by increased air speed is also used to calculate the Cooling Fan Efficiency (CFE). CFE is defined in [ASHRAE Standard 216 \(2020\)](#) as the ratio of the cooling effect to the input power of the fan. CFE gives people a standardized way to compare how much cooling a fan provides when consuming the same energy.

Human response to air movement

Do the occupants prefer an environment with a cooler temperature or an increased air speed and slightly higher temperature? Research has shown that people prefer an environment where they can use fans with a slightly higher than usual temperature (i.e., 26 °C [79 °F]) compared with the typical air conditioning temperature setpoint (i.e., 23 °C [73 °F]) without fans ([Schiavon et al., 2016](#)). Studies conducted in office buildings showed that the results were aligned with the findings obtained from laboratory experiments ([Lipczynska et al., 2018](#)). In addition, using a human heat balance model, a study found that fans can be used to cool occupants even if the ambient temperature exceeds normal skin temperature (i.e., 35 °C [95 °F]) ([Tartarini et al., 2021](#)).

Fan options and key characteristics

Which are the different types of fans in the market and the main features for you to consider?

There are multiple fan types available in the market, but ceiling fans, in general are preferable compared to other fan types due to their air circulation effectiveness and low energy consumption, especially for serving multiple occupants within the same space. In addition, the installation and operation of ceiling fans are specific to the building design which is different from other portable fan options. This guide highlights a standalone section on ceiling fans, while other fan choices (i.e., other air movement devices) will be discussed in a separate section.

Ceiling fans

The US Department of Energy (DOE) defines various ceiling fan types in the "Uniform Test Method for Measuring the Energy Consumption of Ceiling Fans." Table T1 presents the criteria of ceiling fan blade thickness and tip speed adopted from DOE, and Table T2 summarizes the definition of several common ceiling fan types with supporting remarks.

Table T1. Ceiling Fan Blade and Tip Speed Criteria (adapted from DOE definitions).

Airflow Direction	Thickness (t) of edges of blades	Thickness (t) of edges of blades	Tip speed threshold	Tip speed threshold
	mm	in	m/s	fpm
Downward-Only	$4.8 > t \geq 3.2$	$3/16 > t \geq 1/8$	16.3	3200
Downward-Only	$t \geq 4.8$	$t \geq 3/16$	20.3	4000
Reversible	$4.8 > t \geq 3.2$	$3/16 > t \geq 1/8$	12.2	2400
Reversible	$t \geq 4.8$	$t \geq 3/16$	16.3	3200

Table T2. Common ceiling fan types (adapted from DOE definitions)

Ceiling fan types	Fan diameter (D)	Fan diameter (D)	Remarks
	m	Ft	
Standard fan	$0.46 \leq D \leq 2.1$	$1.5 \leq D \leq 7$	Blade to ceiling height > 25 cm [10 in]
Large-diameter fan	$D > 2.1$	$D > 7$	Known as high volume low speed (HVLS) fan
Hugger fan	$0.46 \leq D \leq 2.1$	$1.5 \leq D \leq 7$	Similar to standard fan Blade to ceiling height ≤ 25 cm [10 in]
Very-small-diameter fan	$D < 0.46$	$D < 1.5$	Airflow > 0.87 m ³ /s [1840 cfm]; Rotational speed > rpm at highest speed

In general, a larger diameter fan (i.e., high volume low speed (HVLS) fan) blade can move a larger volume of air than a smaller diameter fan blade. As fan diameter increases, the rotational speed is typically limited to prevent excessive noise from the fan blades, especially near the blade tip. Additionally, where fans can be mounted at blade heights below 3 m [10 ft], the rotational speed must be limited to meet safety criteria for the maximum speed of the blade tips. HVLS fans require higher ceilings (typically at least 3.3 m [11 ft]) and larger spaces free from obstructions to accommodate their increased diameter, and these fans are most often found in non-residential settings, like commercial and industrial applications. Some large-diameter ceiling fans include “winglets” or blade tip fences to maximize airflow and minimize noise, which is a less common problem in standard fans as the blade tip speed is already constrained for safety reasons.

Fan blades

Blade shape, number of blades, and blade pitch are important factors in increasing energy efficiency while maximizing airflow through the fan blades. Generally, there are two main types of fan blades: flat blades and airfoil-style blades. The curvature of the airfoil blades helps increase airflow through the ceiling fan, minimizing air turbulence at the trailing edge, which it is more efficient and quieter when compared to flat blades. However, airfoil blades will not operate as efficiently (i.e., lower airflow) in reverse direction. Increasing the number of fan blades and blade’s angle will increase the airflow of a ceiling fan. Nevertheless, the increased weight and drag can cause energy efficiency loss. Standard ceiling fans typically have 3 to 5 blades with blade’s angle to be 8 – 15°.

Motors and drives

Typically, ceiling fans have three main types of motor (AC induction; permanent magnet DC (PMDC); and brushless direct current (DC) motors) and two types of drives (direct drive; and gear-driven). Table T3 highlights the characteristics of these motors and drives.

Table T3. Comparison between ceiling fan’s motors and drives

		Characteristic(s)
Motors	Alternating current (AC) induction	Provides constant, even airflow and are cheaper than DC motors. They typically provide only three speed levels.
Motors	Permanent magnet DC (PMDC)	More energy efficient than AC motors and provides constant force over a wider range of speeds than AC motors.
Motors	Brushless direct current (DC)	The most energy efficient of the three motor types (use 70% less energy than an AC motor), more quiet, and has a longer service life than PMDC motors.
Drives	Direct drive	Almost all small-diameter fans are direct drive. It is quieter than gear-driven fans. However, comparatively, it provides less airflow.
Drives	Gear-driven	Gear-driven fans allow for high motor power where maximizing airflow is a priority over sound levels or aesthetics.

Diameter and rotational speed

Assuming all other factors being equal, a larger diameter fan will produce greater airflow, average air speed and uniformity of air speed in space than a smaller diameter fan at the same rotational speed. In general, the total airflow and the air speed from any measurement point are linear with rotational speed. This relationship begins to break down at very low air speed, very low rotational speeds, or where the fan blade height is unusually far from the floor.

Rated airflow

The test methods for rating the airflow of these fans are regulated in the US [under 10 CFR 430 Appendix U](#). For standard fans, the rating is determined by a modified [Energy Star method](#), while for large diameter fans (above 2.1 m [7ft]), the rating is determined by the [AMCA 230-15](#) test method.

Air speed and uniformity

Ceiling fans' air speed is defined as the average air speed that passes through the fan blades sweeping area. It is calculated by dividing the rated airflow of the fan by its diameter. Fan air speed is a useful metric because it is more directly representative of the air speed that will occur in the space. Typically, the maximum air speed in the space is within 1.3 – 1.5 times of the fan air speed and will occur below the fan blade tip. Fans with higher maximum fan rotational speed will produce higher possible air speed in the room regardless of fan diameter. If the room design target is based on maximum air speed instead of rated airflow, the designer can directly compare fans with different sizes.

The variation of the air speeds in a space is an important design consideration. Figure T2 demonstrates an example of air speeds distribution from a 1.5 m [5 ft] diameter ceiling fan. The airflow 'jet' from the fan immediately narrows to a slightly smaller diameter than the fan blades. The jet then impinges on the floor, creating a stagnation point, and then spreads radially outwards along the floor. Away from the fan diameter and above the floor spreading zone, there is a still air zone where air speeds are almost unaffected. The depth of air spreading zone along the floor and its average air speed is dependent to the fan diameter: smaller fan (shallower) and larger fan (deeper). In general, larger diameter fans have lower air speeds directly under the fan center (i.e., near the stagnation point), but the air speeds distribution is more uniform than the smaller diameter fans.

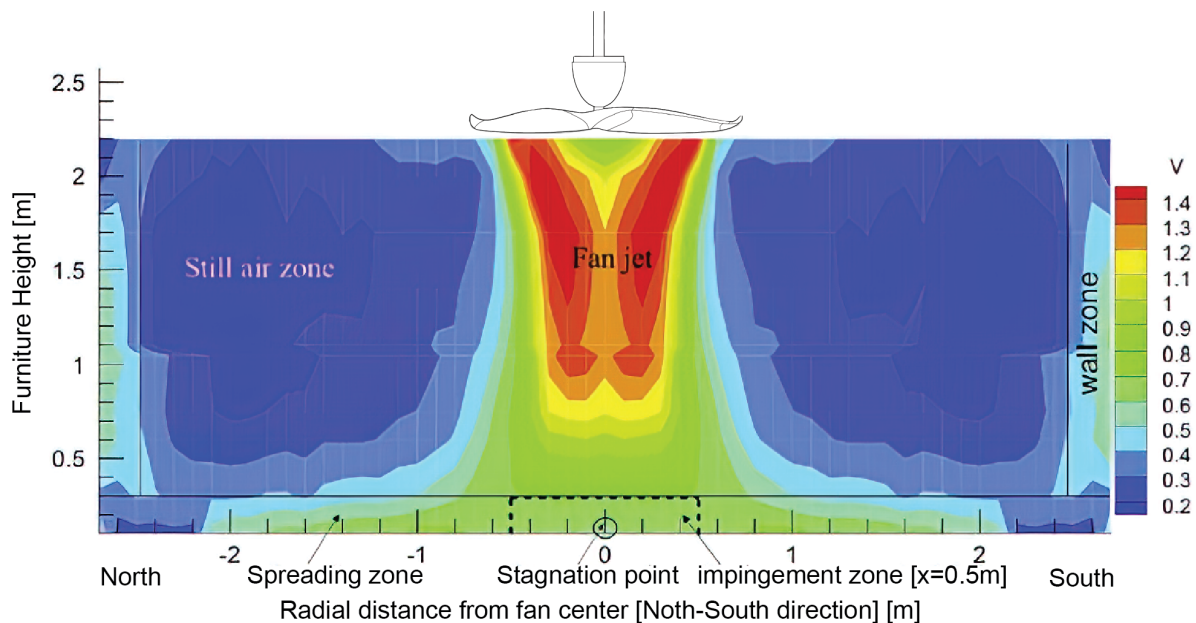

Figure T2. Example air speed distribution from a ceiling fan (Gao et al., 2017).

Fan operates in reverse direction

Most of the ceiling fans in the market can operate in reverse direction (i.e., blowing air upwards). One application is destratifying spaces in the heating season, where downwards flow may cause a draft (overcooling) on the occupants even when the fan is operating at a minimum rotational speed. The air circulation pattern generated by reversely operated ceiling fans is similar to the normal operation condition, but the air speed is much lower and much more uniformly distributed in space. The upward blowing airflow is depended on the fan type and blade geometry. For the same diameter fans, fan with flat blades would generate higher upward airflow than airfoil-style blades. The average air speed for upwards blowing is approximately 60 – 70 % of the downwards case for flat blades fans. Furniture and ceiling obstructions are likely contributing to the drop of airflow.

Fans speed control

Most standard fans typically have several fixed fan speed levels. Standard AC motor fans typically have three levels, whereas DC motor fans tend to have more. Large-diameter fans usually have a variable speed regardless of motor type. Having a high minimum speed can be problematic in some applications. It may generate too much of a cooling effect for the occupants when temperatures are mild or cool. A reasonable approximation is that the minimum fan air speed should be below 0.4 m/s [80 fpm] or a 1.7 °C [3 °F] cooling effect at the minimum allowed blade height, depending on the specifics of the application.

Power and efficacy

According to the US Department of Energy (DOE), ceiling fan efficacy is generally defined by the amount of airflow generated by the fan divided by the power consumption. Typical fan efficacy at the lowest and highest operating speeds are, respectively, 0.08 m³/s·W [165 CFM/W] and 0.04 m³/s·W [79 CFM/W] (MAEDbS database). It is noted that ceiling fans with the same efficacy could perform differently, whereas fans with lower-rated maximum airflows will have a better-rated efficacy even if they consume more power to provide the same airflow. It is because when a fan operates at a lower rotation speed, the reduction of power consumption is higher than airflow (i.e., fan power ∝ (rotational speed)³, while airflow ∝ rotational speed), resulting in higher fan efficacy metrics (airflow/power). Figure T8 shows three fans have the same efficacy 0.11 m³/s·W [234 CFM/W], but the fan represented by the leftmost curve has a smaller overall efficiency (i.e., lowest maximum airflow) than the rightmost curve (i.e., highest maximum airflow).

Meanwhile, the ceiling fan energy index (CFEI), a ratio of reference fan power input to actual fan power input, is a more reliable alternative in reflecting the above blind spot. It helps to make inefficient fans less likely to comply with slower speeds and to remove the unintentional barrier to compliance for high-performing high-utility fans by comparing fans to a standardized baseline. Taking the same example in Figure T3, CFEI at high fan speed for the leftmost and rightmost curve is, respectively, 0.63 (less efficient) and 1.72 (more efficient). See the section “Ceiling fans testing regulations” for more information.

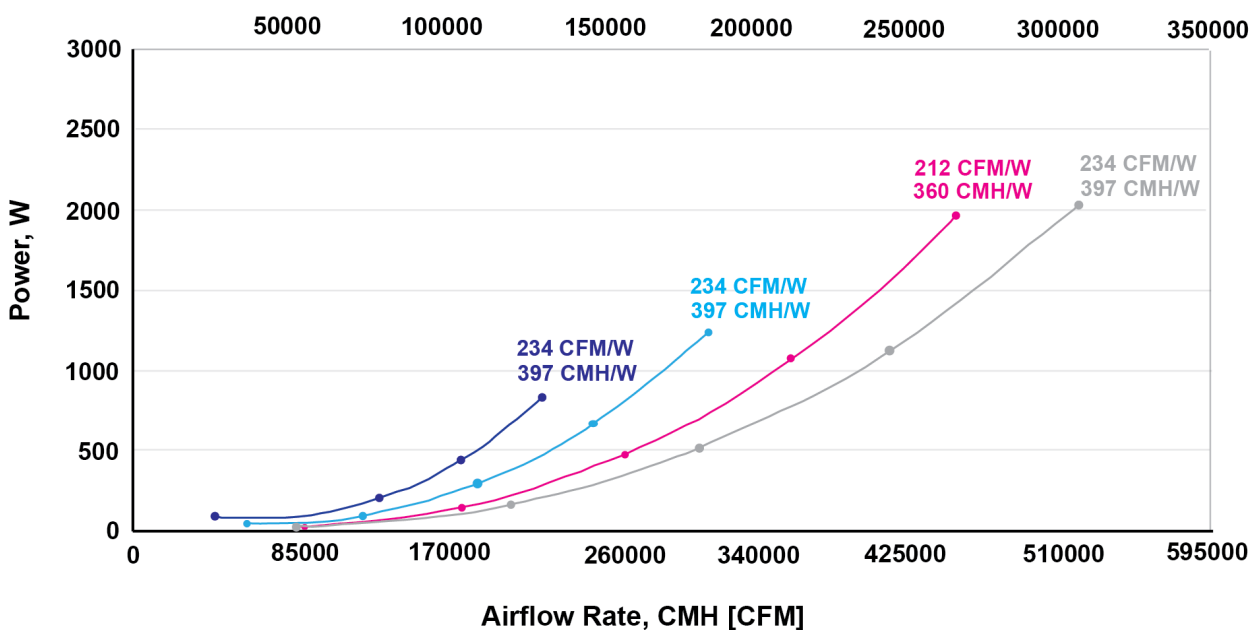

Figure T3. Fan efficacy versus total airflow and power.

Generally, the ability of a fan to operate efficiently at a lower speed improves as the diameter increases, but there is considerable variation in performance between models of fans with the same diameter. Fans with a lower turndown ratio (i.e., minimum fan speed divided by maximum fan speed) can be more flexible for different applications.

Other air movement devices

Places with lower floor-to-ceiling height or a ceiling with compacted fixtures could be limited for ceiling fan installation. Moreover, installing a ceiling fan may be challenging due to the presence of other equipment, fans like lights. These limitations can be mitigated by using other air movement devices. There are numerous kinds of fan available in the market, and this technical guide only illustrates six common types of air movement devices: desk fan, pedestal fan, tower fan, wall-mounted fan, bladeless ceiling fan, and air circulator. The selection criteria for these fan types are discussed as follows.

Typical functions and airflow patterns

The above-mentioned air movement devices basically have two major functions: (1) move air directly towards the human body and (2) room air circulation. Moving air towards the human body aims to cool the subject using convective heat loss, while air circulation aims to keep air in motion within the enclosed space to enhance air and temperature mixing. Nevertheless, most fan types can deliver both functions by adjusting the fan speed and operation distance between fans and occupants. Therefore, fan selection should be based on the intent, whether it is an individual adjustment for personal cooling (group 1) or producing a general air movement effect for multiple occupants' usage simultaneously. Table T4 summarizes the typical function, application location, and approximate price range of different fan types for reference.

Table T4. Summary of other air movement device's function, noise level and approximate price range.

Fan Type	Typical function	Typical application location	Price range (USD)
Desk fan	Air movement towards human body	Workstation, bedroom, study room	\$ 10 - \$ 300
Pedestal fan	Air movement towards human body / Room air circulation	Open plan office, residence	\$ 40 - \$ 400
Tower fan	Air movement towards human body / Room air circulation	Bedroom, personal office, small room	\$ 40 - \$ 450
Wall mounted fan	Air movement towards human body / Room air circulation	Residence, waiting room, restaurant, school, warehouse	\$ 50 - \$ 300
Bladeless ceiling fan	Room air circulation	Residence, office	\$ 500 - \$ 1000
Air circulator	Room air circulation	Warehouse, residence, open plan office	\$ 50 - \$ 300
Ceiling fan (with blades)	Air movement towards human body / Room air circulation	Any indoor / semi-indoor space with sufficient mounting height	\$ 200 - \$ 1000

Airflow patterns from different devices can be varied by fan size, blade types, and fan structure. There is no requirement or standard on typical air speed for the air movement devices described in Table T4. The air speed and airflow requirements are mainly dependent on the typical functions and locations of users.

For fans that intend for direct cooling towards the human body, customers tend to select a stronger fan that can produce more airflow and faster air speed. However, in some situations (e.g., operating the fan together with air-conditioning), the occupants do not require air movement that is too strong. Therefore, choosing a fan with a possible lower airflow turndown (minimum speed divided by maximum speed) capability could be the key to better comfort in terms of direct convective cooling. Meanwhile, if the function of a fan is used to circulate the air in a room, the fan selection approach should be either bigger in size (i.e., produce more airflow) or able to generate a high airflow jet with high speed to drive the in-room air. Figure T4 illustrates examples of airflow flow patterns for different fan types.

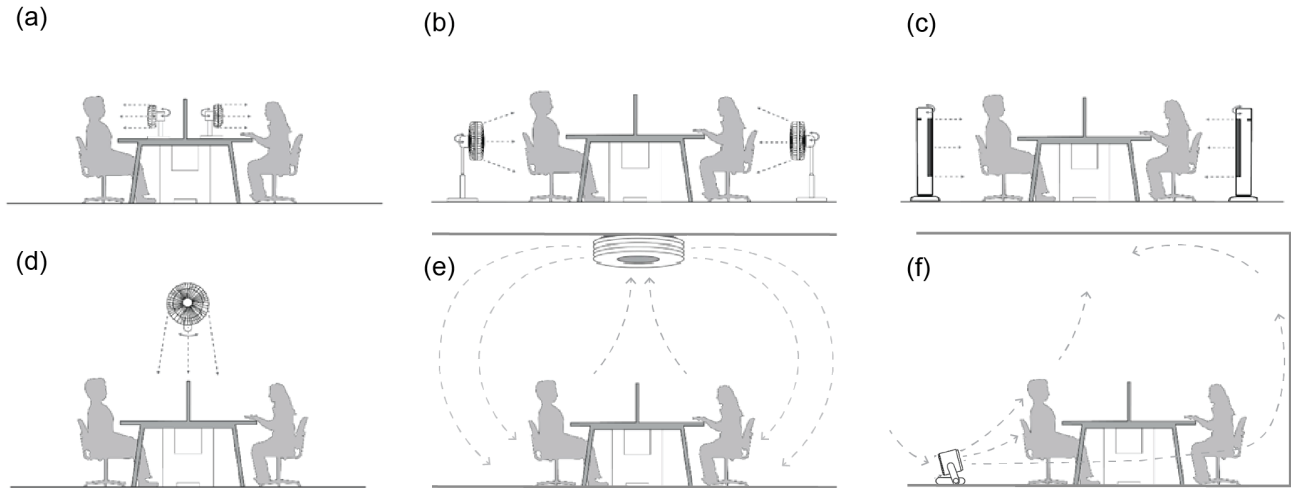

Figure T4. Example airflow patterns for (a) desk fans, (b) pedestal fans, (c) tower fans, (d) wall mounted fans, (e) bladeless ceiling fans, and (f) air circulators.

Noise levels

Noise from a fan can initiate dissatisfaction and unwillingness to its usage from occupants. The noise sources of a fan are mainly from the operating motor and the fast movements of the blades (i.e., turbulence ingestion). The sound level of domestic fans ranges from 30 to 70 dBA. Fans operating at higher speeds usually correspond to higher noise levels due to turbulence. Nevertheless, the noise cannot be characterized only by sound level. Its frequency is also an important aspect. Low-frequency noise has been identified to be annoying. It is not practical to conclude one fan type will always be quieter than another. Designers/users are encouraged to experience fan usage before purchasing.

Power and cooling fan efficiency

All the elevated air movement devices described in Table T4 consist of a motor and drive. The types of motor and drive used for these elevated air movement devices are similar to those that operate in a ceiling fan, which we have discussed in the former section. It is worth noting that a larger energy-saving potential can be achieved by using a DC motor instead of an AC motor, especially for small fans like desk fans or pedestal fans.

In general, fan performance can be evaluated by the cooling fan efficiency (CFE) index, the ratio between the cooling effect of the device and its power consumption, defined in the following equation (where P_f = the input power of the fan (in W) and Δt_{eq} = the whole-body cooling effect (in °C or °F):

$$CFE = \frac{\text{Cooling Effect}}{\text{Fan Power}} = (-1) \frac{\Delta t_{eq}}{P_f}$$

It is noted that the cooling effect depends on the effectiveness of convective cooling towards the subject's body and is affected by air speed, airflow pattern, and fan operation distance. Eventually, the intent of fan usage (local cooling vs. air circulation) should have been considered when quantifying the fan's effectiveness.

Flexibility and other features

One major advantage of the above-listed elevated air movement devices over ceiling fans is the high flexibility of usage in terms of location, operation height and oscillating angle. Such flexibility enhances adjustment to occupant's needs and comfort demands regarding elevated air speed under different circumstances.

In addition, some fans are also equipped with modern technologies that enable them with special features while being equally efficient. For example, fans equipped with filters for air purification, fans installed with UV-C light for air disinfection, and fans that emit water mist for air humidification and evaporative cooling.

Design goals and fan selection

Which are the relevant air movement goals for your design and how to select fans that meets those goals?

Fans are effective for comfort cooling, and air circulation. However, fan applications depend highly on the design goals for desired air speed and distribution and any physical environment limitations.

Understanding the elevated air movement design goals is the prerequisite in selecting an adequate fan type for a particular space.

Design goals

Figure T5 outlines the key considerations for defining the fan design goals, including personal control, targeted, variability, and uniformity. "Personal control" design emphasizes the goal of the fan system to provide thermal comfort for a single occupant, while the adjustment of fans is unlikely affecting the others. "Variability" has its advantage at multi-occupant space where occupants have the flexibility to adjust fan operation based on their desired thermal comfort needs, or they are free to move around and choose their preferable locations or thermal conditions. In spaces where there is variable or transient occupancies, non-uniform thermal conditions, or spaces with specific thermal requirements due to architectural features or activity levels, "Targeted" air movement may provide more comfort. Lastly, "Uniformity" (i.e., more regular control) emphasizes uniform air speeds and consistent thermal comfort experience applied in multi-occupant spaces where occupants do not have the flexibility to control fan or change their location, especially when occupants will be staying in those areas for extended periods.

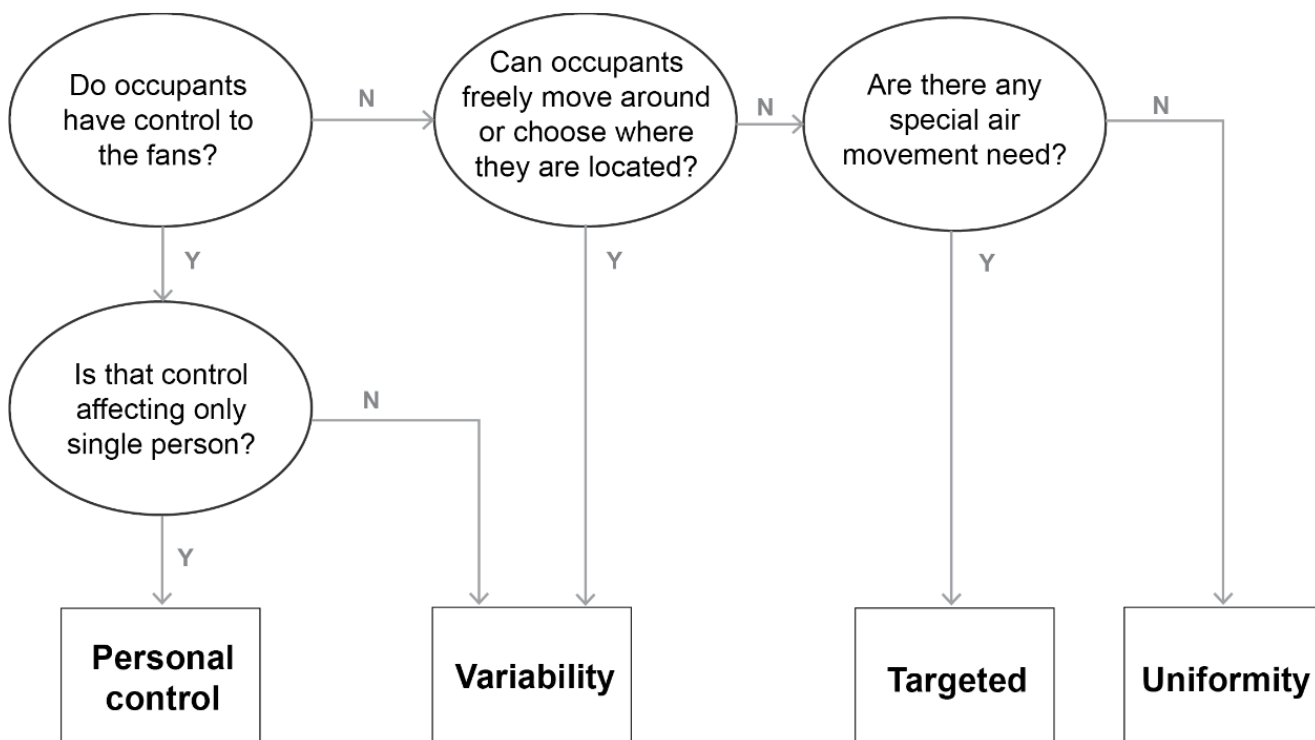

Figure T5. Flow chart of design intent for air speed and distribution.

Fan selection

Fan selection criteria mainly depend on the design goals of air speed and distribution, the purpose of elevated air movement (i.e., direct cooling across the human body or air circulation), and any limitations of fan usage in space (i.e., floor-to-ceiling height).

Ceiling fans are generally effective for comfort cooling and air circulation in nearly all scenarios and applications. Ceiling fans are recommended due to their effectiveness in air movement, provided that some limitations of implementation have been compromised, including insufficient height clearance for ceiling fans installation, presence of obstructions at the ceiling or on the floor that block airflow, an inadequate arrangement between lighting fixtures and ceiling fans that cause strobing or visual flickering effect, and high renovation cost for ceiling fans integrated design. Installation of ceiling fans is recommended if these limitations do not apply. Alternatively, other air movement devices shall be chosen if these limitations cannot be compromised. Figure T6 presents the fan selection examples (with/without ceiling fans) based on different design intent. In addition, different types of fans can be integrated to maximize occupants' comfort and to achieve multiple design intent. For example, ceiling fans can provide a uniformly low-speed background air movement for all occupants in a large open space, while individual fans allow additional personal control to improve occupants' local thermal comfort further whenever it is necessary (e.g., at transient conditions or near the window). An example of such a mixed design intent approach is presented at the bottom of Figure T6.

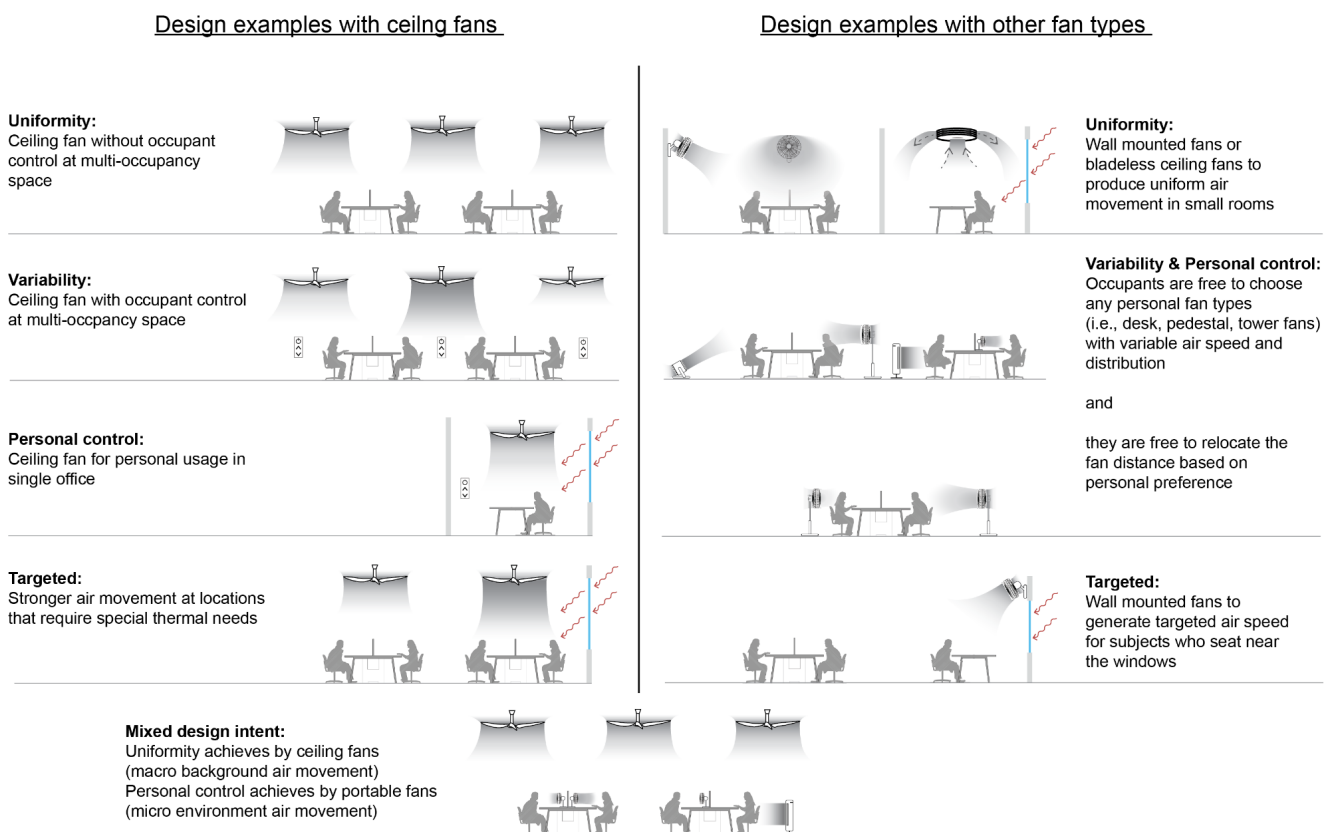

Figure T6. Fans selection examples based on different design intent.

Ceiling fan integration with HVAC system

How to design, select, install and operate ceiling fans when integrated with a HVAC system?

This technical guide focuses on the integration of ceiling fans with air-conditioning systems in buildings, due to higher attention on design, installation, and operation. Besides, incorporating ceiling fans in the early system design stage can achieve additional savings in reduced construction costs and downsized HVAC system components.

Ceiling fan system design

Considerations of ceiling fan design in space are mainly two folds: fan size and installation.

Fan size and number determination

Determining the appropriate ceiling fan size (and number) within space is critical to air speed distribution and effective cooling. Table T5 lists the key features for fan size (and number) determination.

Table T5. Key features in determining fan size (and number) in space.

Features	Considerations	Remark(s)
<p>Fan mounted height and clearance from wall and other obstructions</p>	<p>Standard ceiling fans:</p> <ul style="list-style-type: none"> • Mounted at least 2.1m [7 ft] above floor for safety concern. • Minimum blades to ceiling height of 20 cm [8 in] or 0.2 times of the fan diameter (Whichever is larger). • Minimum blades to wall clearance of 45 cm [18 in] <p>Large diameter fans (>2.1m [7ft]):</p> <ul style="list-style-type: none"> • Mounted at least 3m [10ft] above floor. • Minimum blades to ceiling height of 0.2 times of the fan diameter. • Minimum blades to wall clearance of 90 cm [36 in] 	<p>Ceiling fans size (i.e., diameter) is limited to the floor to ceiling height of the space, due to safety concern and to avoid “starving” of the fans (i.e., insufficient air feeding the fan). Refers to “Fan installation” section for more detailed on minimum clearances.</p>
	<p>For small and roughly square room:</p> <ul style="list-style-type: none"> • Single fan with diameter of 0.2 – 0.4 times the room width shall be used. • A single fan can effectively serve a rectangular room with aspect ratio (length : width) up to 1.5 : 1. <p>For high aspect ratio (> 1.5 : 1) and unconventional shape room</p> <ul style="list-style-type: none"> • Multiple fans shall be considered to ensure uniform air speed distribution. • If a single fan is used, the fan diameter shall be 0.2 – 0.4 times the characteristics 	<p>If uniformity of air speed is the design intent, the largest available fan size that fulfills the spatial concerns (i.e., height, clearance, area, and layout) shall be selected.</p>

<p>Space area, room ratio and layout</p>	<p>room width (i.e., square root of the floor area): For larger size room:</p> <ul style="list-style-type: none"> • It should be sub-divided into multiple equal square-shaped “fan cells” (i.e., < aspect ratio of 1.5 : 1) • One fan will be centred in each fan cell and operates similarly within a small room as describes above. • Size and number of fan cells and ceiling fans are dependent to the function of the space (i.e., the design intent). • In each fan cell, the fan diameter should be between 0.2 – 0.4 times of the fan cell’s characteristics width. 	<p>For multiple fans design, space with higher uniformity may require larger size fans and closer fans spacing. See Figure T7 for recommended fan size and layout for single-case. See Figure T8 for recommended fan size and layout for multi-fan cases.</p>
<p>Design intents</p>	<p>Design intents of fan speed and distribution criteria based on category presents in Figure T5. For example, whether the desired air speed is designated for personal usage, a targeted area, variability of change, or maximizing uniformity</p>	<p>Larger fans or more fans will be required in spaces that are likely to benefit from uniformity to variability.</p>
<p>Other ceiling installations</p>	<p>Fan size should compromise potential conflicts with other building system, such as fire sprinklers and lighting.</p>	<p>Refers to “Fan installation” section below for details.</p>

Figure T7 demonstrates an example of recommended ceiling fan size for single-fan applications. Provided that the room area aspect ratio (length : width) is within 1.5 : 1, one fan operation is applicable. The room area is 24 m² [258 ft²], and the characteristic width is 4.9 m [16 ft] (i.e., square root of the room area). The recommended ceiling fan diameters are between 0.2 – 0.4 times of the room characteristics width, equivalent to 1 m [3.3 ft] – 2 m [6.6 ft], assuming all other features in Table T5 have been fulfilled.

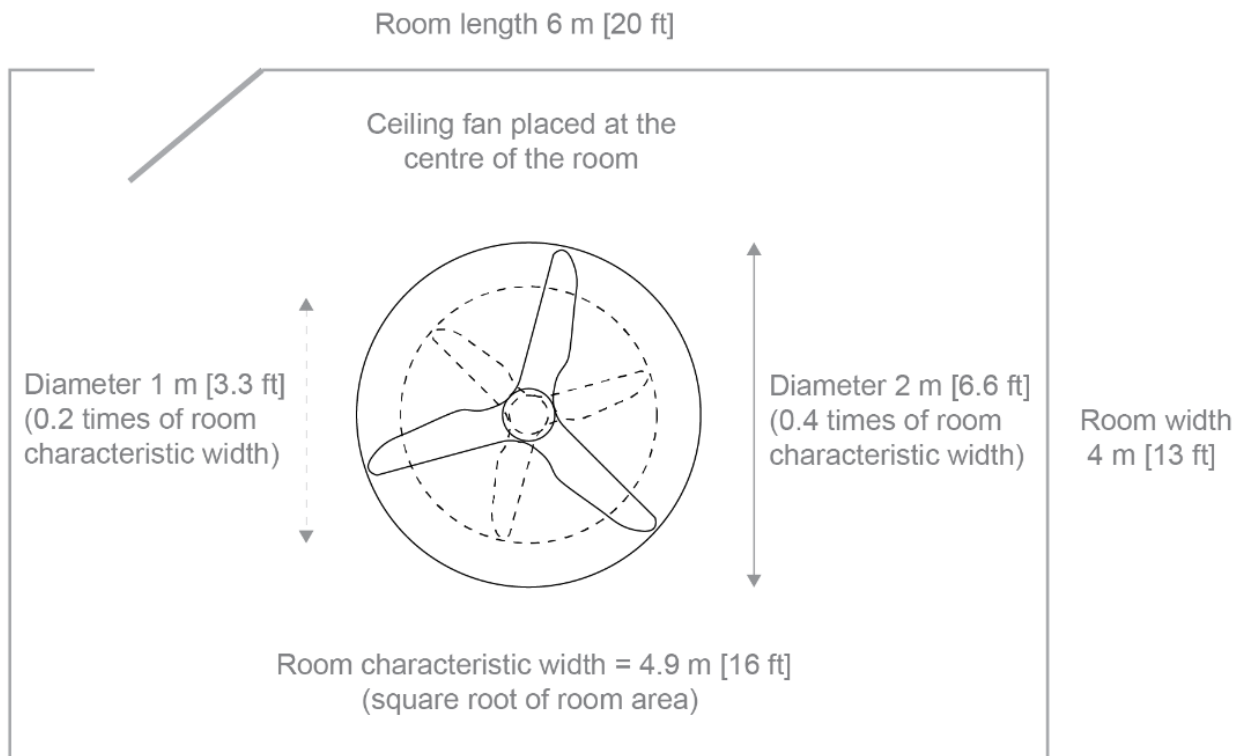

Figure T7. Recommended ceiling fan size and layout for single-fan applications.

Figure T8 presents two examples of recommended ceiling fan sizes and layouts for multi-fan applications with the same site area (240 m² [2580 ft²]) but different room heights and room functions. Figure T8a shows a warehouse divided into two identical fan cells, and one larger-diameter ceiling fan (4.4 m [14 ft]) is centered in each fan cell. The design and installation are valid with sufficient room height (8 m [26 ft]). Figure T8b shows an office with the same area of the warehouse but a much lower room height (2.6 m [9 ft]). It also demonstrates two layout settings: fewer fan cells with larger fans (on the left) and more fan cells with smaller fans (on the right). Settings on the left have four 30 m² [322 ft²] fan cells and a 2.2 m [7 ft] diameter fan centered in each cell (calculated by 0.4 times of room characteristics width). A 2.2 m [7 ft] diameter fan is considered a larger-diameter ceiling fan, which requires at least 3 m [10 ft] mounting height above floor level (see Table T5), and it is not suitable to be installed in office space with relatively shorter room height. In addition, considering this is an office space, too large fan size would block the lighting fixture on the ceiling, initiating unwanted visual flicker. Using a smaller fan size may fulfill the installation requirement but result in a smaller airflow rate and reduced uniformity. The layout settings on the right, with more but smaller fan cells (13 m² [140 ft²]) and a 1.45 m [4.7 ft] diameter fan centered in each cell, can provide more uniform air speed within space, and it is a more suitable design for office settings.

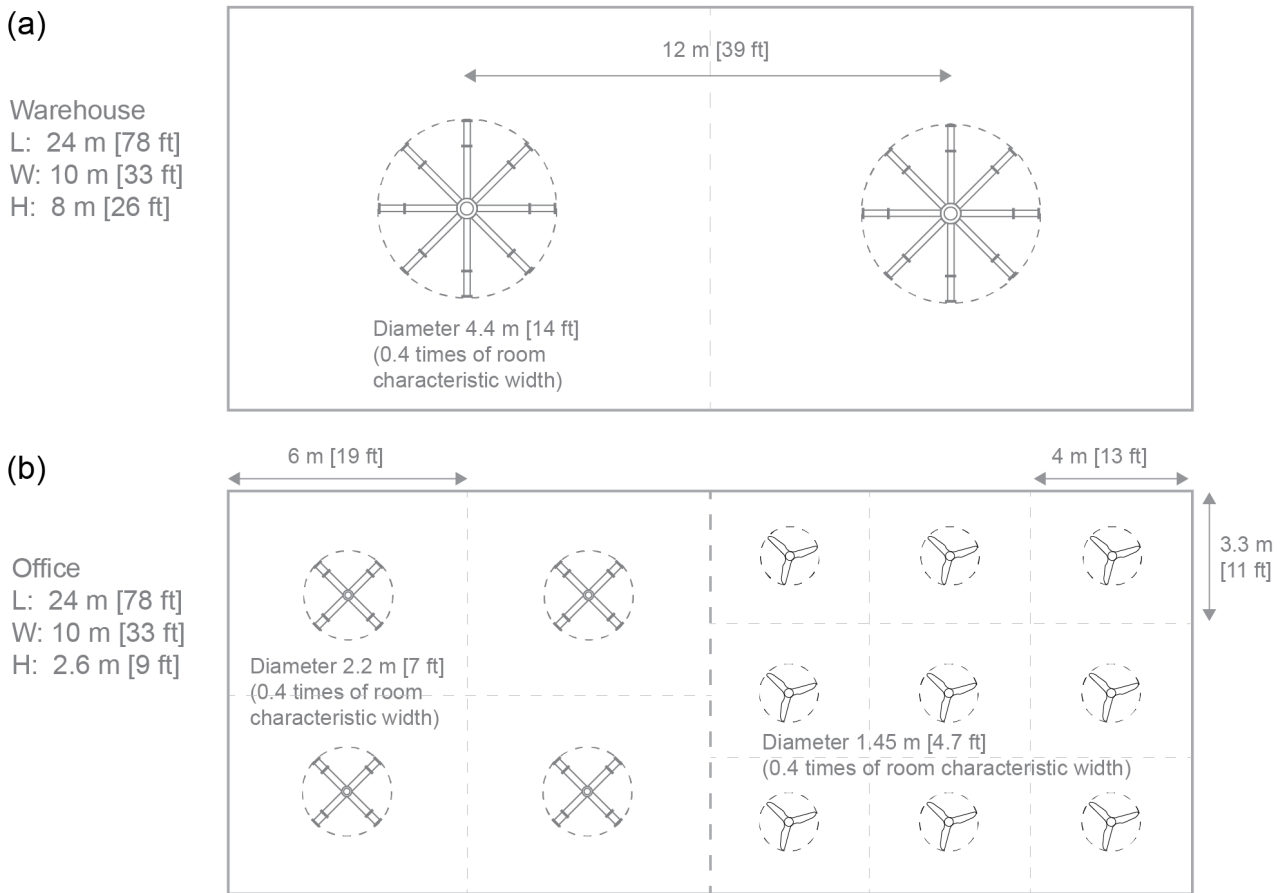

Figure T8. Recommended ceiling fan size and layout for multi-fan applications. (a) Warehouse with higher room height, (b) office with lower room height.

Fan installation

In general, all ceiling fan installation procedures shall follow the manufacturer's recommendations. The ceiling fan should be fixed on a structural surface (slab or beam) to guarantee sturdiness and stability. With the appropriate type of mounting bracket, ceiling fans can also be installed in sloped ceilings. There is no reinforcement requirement if the diameter of the fan is smaller than 2.1 m [7 ft].

The fans mounting heights from ceiling / floor and clearance from walls / obstructions are important regarding both safety and performance consideration (See Table T5 in details for both standard and large diameter ceiling fans). In rule of thumb, ceiling fans require a minimum distance from the ceiling of 0.2 times of the fan diameter to avoid "starving".

Installation of ceiling fans should avoid conflicts with the lighting fixtures to minimize changes of visual flicker and strobing effect, as well visual discomfort. Figure T9 illustrates the potential problems when ceiling fans interact with lighting fixtures. It suggests that visual flicker effect is dependent to view angle of the occupants. Thus, the position of ceiling fans should not only be installed away from the recess lights, but also considering occupants' position in space. Alternatively, designer may consider the possibility of using dropdown lightings (see Figure T9c) with minimum glare to the occupants. If the above limitations with respect to lightings cannot be resolved, designers may consider using other non-ceiling fan alternatives.

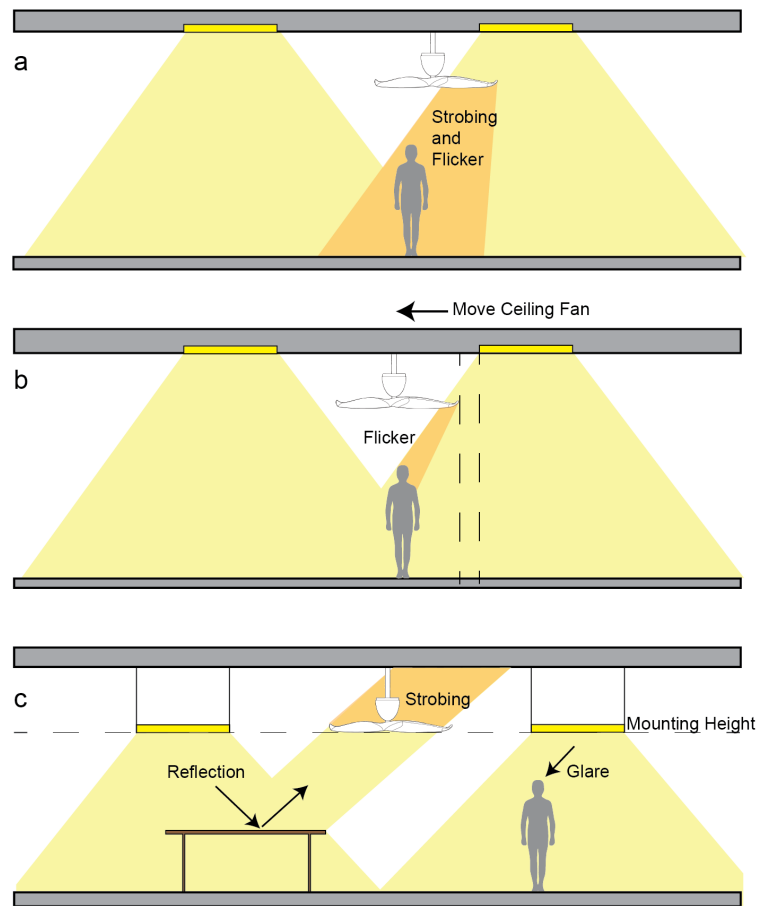

Figure T9. Sectional illustrations on the interactions between ceiling fans and lighting fixtures across different configurations: (a) strobbing and flicker, (b) flicker, and (c) ceiling strobing.

Operation of ceiling fans near windows/doors opening would impact the room [air changes per hour \(ACH\)](#) or ventilation rate. Figure T10 illustrates the airflow patterns for normal window and door-like opening settings. Designers should consider the impact of room air changes per hour via window in natural ventilation conditions by the fan airflow patterns. The use of door-like openings may induce more outdoor airflow.

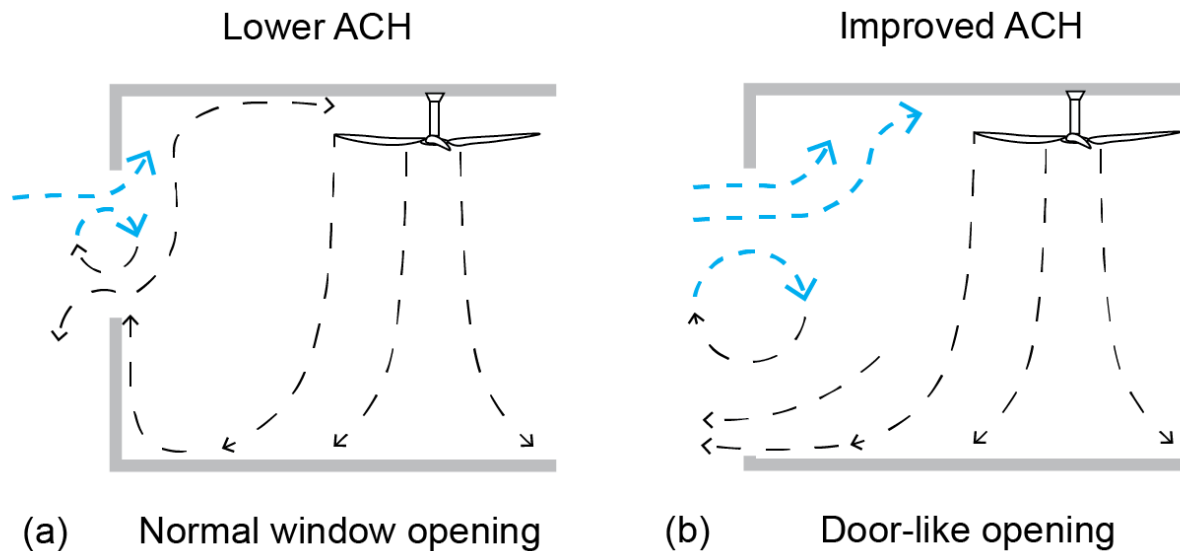

Figure T10. Illustration of airflow patterns induced by ceiling fan for (a) normal window opening, (b) door-like opening settings.

Air-conditioning system design

The conventional air-conditioning system requires diffusers and extended air ducts to distribute air evenly within the space. However, ceiling fans integrated with conventional air-conditioning systems can effectively mix and re-distribute the room air without the need for extra diffusers and extended supply air ducts. In principle, ceiling fans integrate well with most ventilation settings that require air mixing, including radiant cooling systems. However, they are unfavorable for systems that rely on stratification, such as displacement ventilation and underfloor air distribution system or systems utilizing active or passive chilled beams.

Figure T11 compares the design layouts between a conventional air-conditioning system and a recommended ceiling fan integrated air-conditioning system. The ceiling fan integrated air-conditioning system requires only the main supply air duct to throw cool air from a high-sidewall vent into the occupied space. Then the ceiling fan will mix and distribute the cool air in the space. The cool supply air would be best fed above the fan blades to enhance air mixing and avoid cold drafts. Immediate benefits of such design are reduced capital and maintenance costs for unnecessary ducting, diffusers, and variable air volume (VAV) boxes. In addition, the ceiling fans could work more efficiently with larger blades to ceiling height (assuming no false ceiling and without an extra supply air duct).

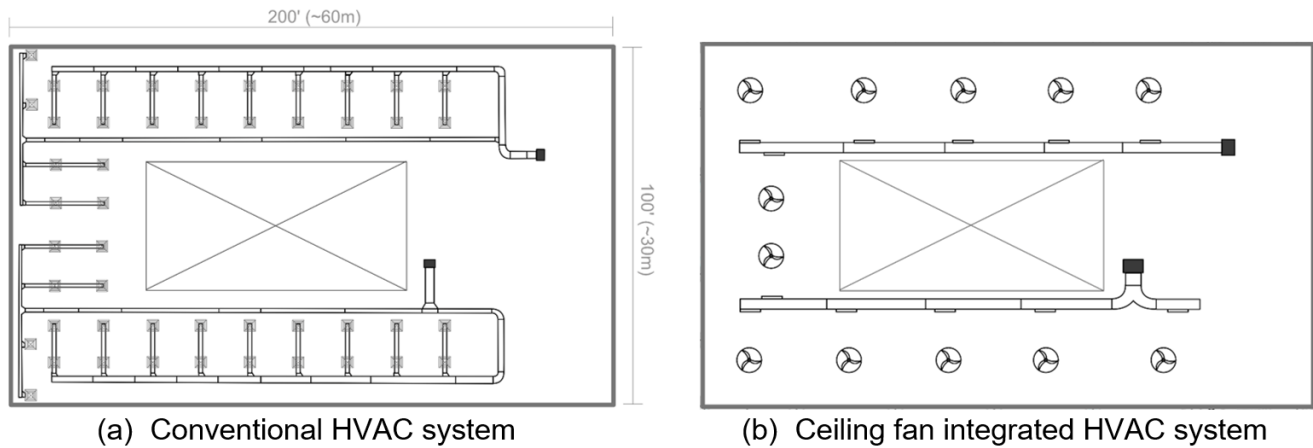

Figure T11. Example design layouts for (a) conventional HVAC system with supply air ducts and diffusers, (b) Ceiling fan integrated HVAC system with limited supply air ducts.

Ceiling fans integrated AC system

One major advantage of the integrated air movement design is the additional convective effects on occupants. This means additional energy saving from space cooling is possible due to the optimization of the air-conditioning system.

Design room conditions

The presence of space air movement allows higher dry bulb room temperature (2-3 °C [4-5 °F]) and dewpoint temperature (1-2 °C [2-4 °F]) when compared with conventional air-conditioning system design. Alternatively, if the originally designated air temperature is 23-25 °C [73-77 °F], it can be increased to 23-27 °C [73-81 °F] with elevated air movement to achieve similar or even better thermal comfort. The room operating air speed can be up to 0.8 m/s [160 fpm] without personal control, while there is no air speed limit if occupants have full control of the fans (i.e., just ceiling fan or ceiling fan + desk fan) within the space.

Components selection

Regarding the relaxation of designated cooling demand (i.e., lower sensible and latent load), the chiller and the air handling unit (AHU) from the original HVAC system can be downsized in the system design stage. The design supply air temperature setpoint (SAT) and chilled water temperature (ChWT) setpoint relaxation should be 50% to 100% of the zone cooling setpoint temperature adjustment. For example, if compared to a conventional HVAC design, the HVAC design with elevated air speed could have a 2 °C higher cooling setpoint temperature, and the SAT and ChWT setpoints should be increased by 1-2 °C. In addition, a smaller size fan in the AHU can be used for the ceiling fan integrated design because it returns smaller static pressure along the critical supply air path (only require the main supply air duct).

HVAC and fans system control

Figure T12 demonstrates the control schematic for the heating, ventilation, and air conditioning (HVAC) system with and without the integration of ceiling fans. It shows that when ceiling fans are integrated with the building automation system (BAS), it can react at the first stage cooling setpoint (say 23 °C [73 °F]) to cool down the zone before the HVAC system begins to operate for cooling. The ceiling fan speed shall increase with the room temperature, which is determined by the cooling effect or a representative point in space. The HVAC cooling starts when the indoor temperature increases to the second stage of the cooling setpoint (say 26 °C [79 °F]). Operating the HVAC system at this higher cooling setpoint has significant energy savings potential.

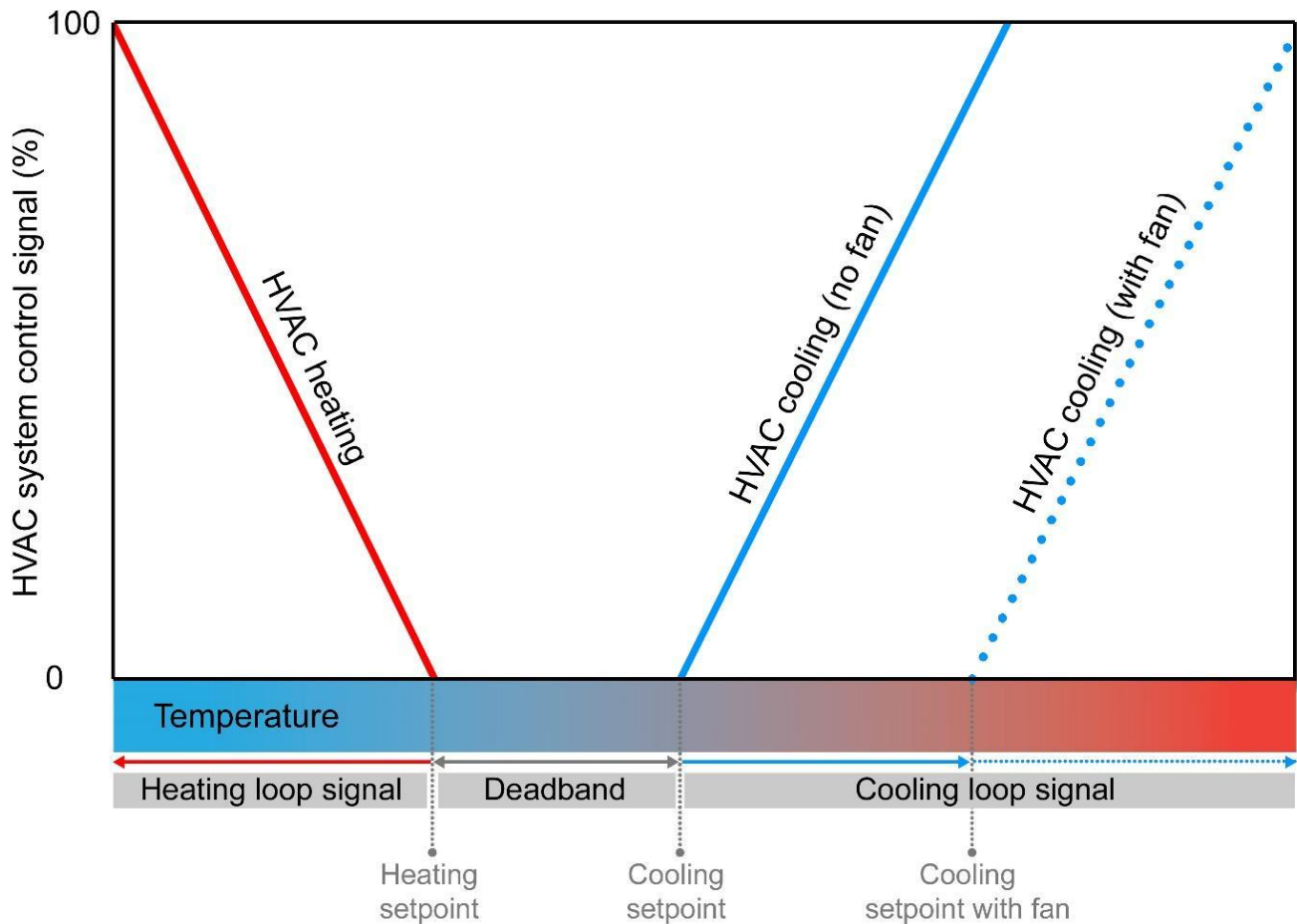

Figure T12. Example HVAC control schematic with / without ceiling fans.

Some ceiling fans have onboard sensing and controls that allow fan speed and temperature automation without integration with the building automation systems (BAS). A lower-cost, simpler alternative to automatically control the ceiling fan based on temperature is to use a relay to turn fan(s) on and off. The fans then operate at a fixed pre-set speed. Fans' operation can also be tied to occupancy sensors in the zone, preventing unnecessary operation, energy use, and maintenance. In some cases, it may be beneficial to operate fans even when unoccupied, such as pre-cooling applications that benefit from increased convection from surfaces in the space due to the air movement generated by the fans.

Potential savings

Comparing the two designs in Figure T11, the ceiling fan integrated air-conditioning system could save up to 45% in capital construction cost compared to the conventional system. These savings are mainly obtained from reduced ductwork, diffusers, VAV boxes, sensors, and controls. Savings can also be obtained from the extra time and workmanship for additional ducting and fittings installation. More importantly, the majority of these ducting and fittings are not reusable and become construction waste when the building is demolished. The cost of purchasing and installing ceiling fans in the space is low compared to the above cost savings.

In addition, substantial energy for space cooling can be accrued when implementing the elevated air movement with a higher temperature cooling strategy. Approximately 17 % of cooling energy saving can be achieved by increasing the cooling temperature setpoint from 22 °C [72 °F] to 25 °C [77 °F]. In such room temperature setpoint adjustment, higher chilled water supply temperature (10 °C [50 °F]) can be used instead of the conventional temperature setpoint (7 °C [44.6 °F]), which it would account for approximately 12% of additional energy saving from the chiller. In a Singaporean zero-energy building, a 32% HVAC energy saving was obtained when the setpoint was increased from 24 [75 °F] to 26.5°C [80 °F]. These cooling energy savings are at least two orders of magnitude higher than the energy used for ceiling fans operation in space.

Managing occupants' expectations with fans

How to deal with occupant expectations when fans are introduced in a space?

Fans can be added to an existing AC system to save energy and increase comfort. Besides the aspect related to the system's design, it is also important to consider how the new fans are introduced in the space and how the temperature setpoints are increased.

Implementation and adaptation

Occupants take time to adapt to the fan-integrated AC system at warmer temperatures and higher air speed environments. Depending on the site conditions and culture, a grace period for occupant adaptation may take up to 3 months. Any change in temperature cooling setpoint should be small, gradual, and follow occupants' comfort feedback. Despite studies showing occupants can be comfortable at a higher temperature condition with increased air speed, in practice, they may perceive thermal dissatisfaction with a sharp change in room temperature setpoint (e.g., from 23 °C to 27 °C [73 °F to 81 °F]) without providing a grace period for adaptation. This is particularly important in building retrofits.

For a practical implementation of a fan-integrated system, building facility managers are suggested to go slow and have patience and perseverance with the progressive transformation process. For example, if the thermal comfort analyses indicate it is possible to increase the air temperature cooling setpoint from 25 to 27 °C [from 77 to 81 °F] at higher air speed conditions with fans, in practice, the temperature setpoint shall be first increased to 26 °C [79 °F] and maintained for at least two weeks for occupant adaptation before further increasing it to 27 °C [81 °F]. In addition, occupants' feedback on the indoor environment shall be continuously monitored during the transformation period. If a lot of thermal dissatisfaction votes have been received, a slightly lower air temperature setpoint should be used. For example, the temperature should be brought down to 25.5 °C [78 °F] to be maintained for two weeks, then raised up to 26 °C [79 °F] again, and advice and training to the occupants about the use of fans should be provided.

Several studies have suggested that occupants can have a higher tolerance to thermal discomfort when provided with control of their micro-environment. Regardless of specific building functions or design intents, allowance for personal control of the fan systems is recommended.

User education

A key indicator of a successful fan-integrated system is ensuring occupants understand the purpose and use of the fans. Figure T13 shows an example of an information plaque informing the fan usage priority – Fan cooling first approach – when occupants feel too warm.

Feel too warm?

(1) Increase the fan speed

(2) Reduce the cooling temperature

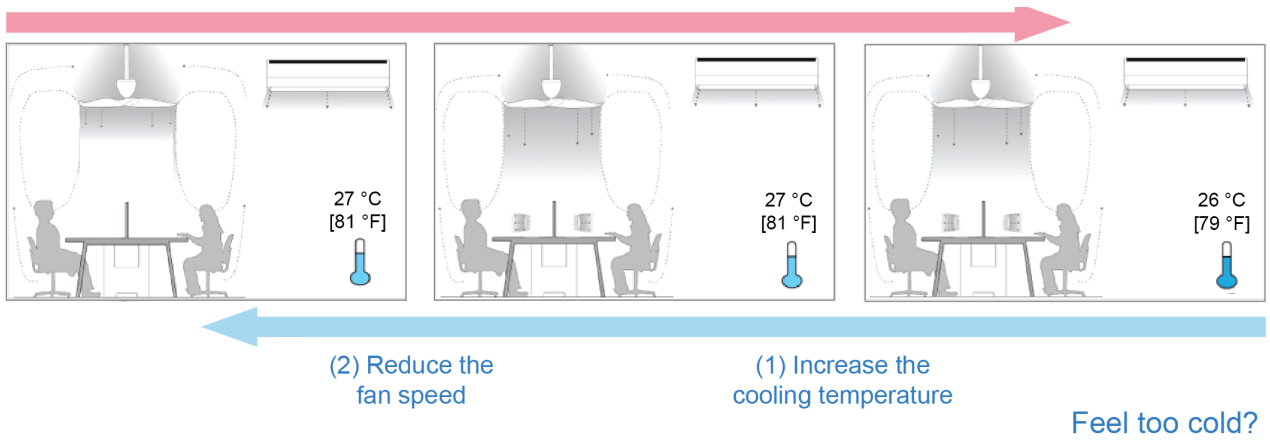

Figure T13. Fan cooling first approach – example plaque for occupant interface and control recommendations.

Design tools

Overview of available design tools

CBE Thermal Comfort Tool

The [CBE Thermal Comfort Tool](#) is an online tool developed by the Center for the Built Environment at the University of California, Berkeley, which helps users define comfort zones at elevated air speeds according to ASHRAE Standard-55 and EN-16798 methodologies. More details on how the tool functions can be found in the online [User Guide](#).

CBE Ceiling Fan Design Tool

The [Ceiling Fan Design Tool](#) is an online tool developed by the Center for the Built Environment at the University of California, Berkeley, which helps users determine optimal ceiling fan arrangements from the user-defined parameters, such as room dimensions and design air speed ranges. The tool can inform users about the estimated air speed, cooling effect, and air speed uniformity when compared between different fan layouts. More details on how the tool functions can be found in the online [User Guide](#).

Codes and standards

Overview of codes and standards

This technical guide does not cover all codes and standards related to fans and air movement published worldwide, and it highlights only several commonly used materials for references and examples. It is also noted that the usage of these materials could be subjected to variations by countries. Users are advised to implement these materials with caution.

Environmental conditions

[ASHRAE Standard 55 – Thermal Environmental Conditions for Human Occupancy \(2020\)](#) identifies factors that may affect thermal comfort in an indoor environment. Proposed in ASHRAE 55, the standard effective temperature (SET) is a reliable index in estimating the heat loss effect for increased air speed conditions.

Green Mark is a green building certification scheme established in Singapore to raise energy performance standards and emphasize other sustainability outcomes. [A Technical Guide of Green Mark for existing non-residential buildings \(2017\)](#) suggests the indoor temperature setpoint could maintain at 26 °C [79 °F] or above if the space is designed with elevated air speed.

Ceiling fans testing regulations

[ASHRAE Standard 216 – Methods of Test for Determining Application Data of Overhead Circulator Fans \(2020\)](#) specifies the instrumentation, facilities, test installation methods, and procedures to determine ceiling fan application data for occupant thermal comfort in a space.

Performance testing on small-diameter ceiling fans (≤ 2.1 m [7 ft]) is recommended by the [ENERGY STAR qualified method](#).

Performance testing on large-diameter ceiling fans (> 2.1 m [7 ft]) is standardized by the [Air Movement and Control Association \(AMCA\) Standard 230 – Laboratory Methods of Testing Air Circulating Fans for Rating and Certification \(2015\)](#).

A modified testing method for large-diameter fans, the [ceiling fan Energy Index \(CFEI\)](#), is developed to enhance ceiling fan testing effectiveness. CFEI is derived from the fan energy index equation in [ANSI/AMCA Standard 208-18: Calculation of the Fan Energy Index](#) with substitute coefficient for large-diameter ceiling fans.

Fire safety

The primary concern with ceiling fans about the fire code is the interaction with fire sprinklers. The National Fire Protection Association (NFPA) Standards, [NFPA 13](#), summarizes the requirements of ceiling fan installation concerning fire sprinklers in buildings. It is noted that specific fire safety requirements may vary by country. Users should always consult local codes and requirements for a specific project.

Seismic requirements

Seismic considerations and requirements are especially relevant for installations of ceiling fans, especially for large-diameter fans, long suspension rods, or other requirements for seismic support. An example can be found in the [American Society of Civil Engineer \(ASCE 7\) Standard](#). Users should always consult local codes and requirements for a specific project.

Full Guidebook

Benefits of using fans

Fans are more than just a basic amenity for residential applications. Increasingly, fans are found in applications varying from industrial to commercial buildings, from semi-outdoor spaces and high-end hospitality settings, and everything in between. The extensive use of fans in residential applications (over 80% of single-family homes in the United States have at least one ceiling fan), as demonstrated in Figure 1 below, indicates their effectiveness in supporting thermal comfort and occupant demand for controllable air movement.

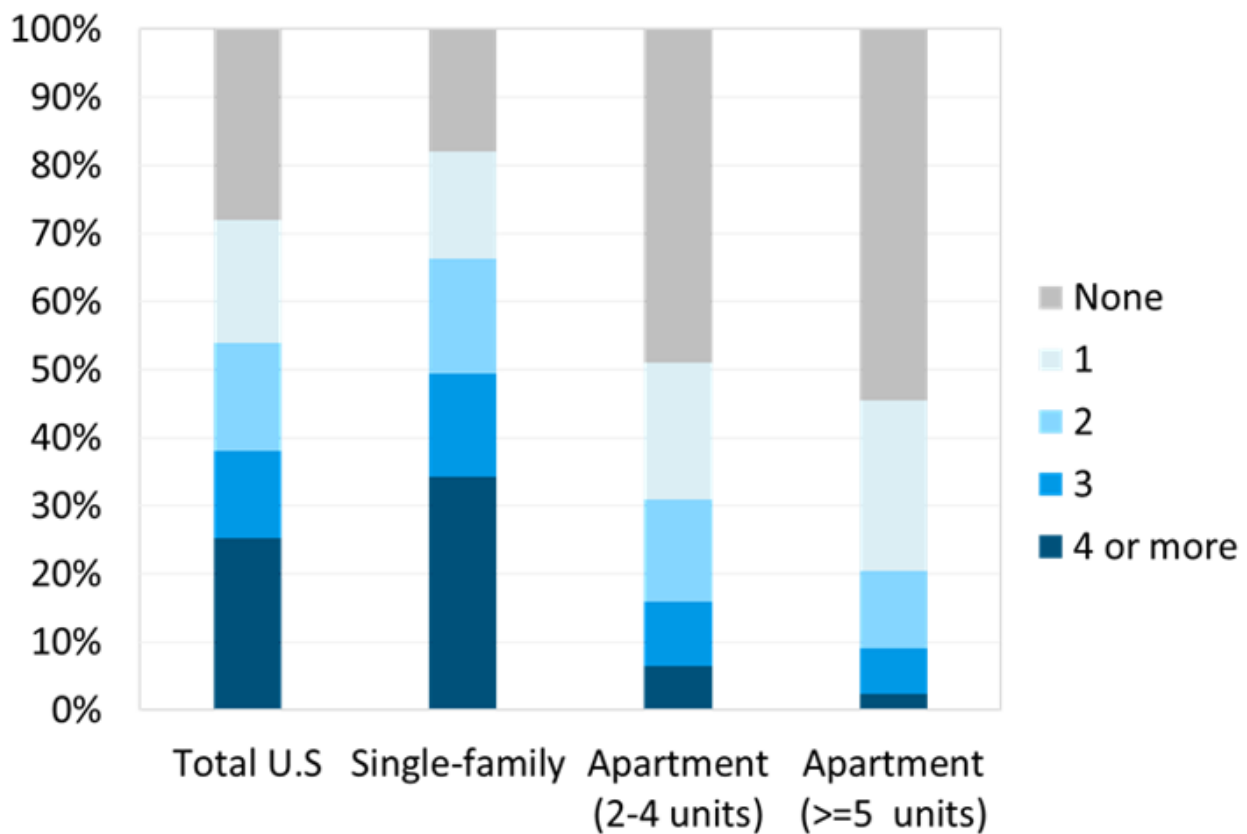

Figure 1. Number of fans per household by housing unit type, data source: U.S. Energy Information Administration 2015 [Residential Energy Consumption Survey](#).

This widespread applicability stems from the many benefits that fans can provide in interior environments. The key benefits of fans include thermal comfort, improved air distribution, improved air quality, energy savings, and first and operating cost reductions.

Thermal comfort

Simply stated, thermal comfort is an occupant's satisfaction ("comfort") with the thermal environment. Humans have been using air movement for centuries to help regulate thermal comfort. In warm conditions, there is generally less heat loss from the skin than in cooler conditions, so people are at risk of warming up as our body needs to lose the heat produced in the body core continually. Increased air movement across the skin carries away more heat from the body via two physical processes, convection and evaporation, thereby restoring comfort. Since the advent of mechanical air-conditioning systems, building designers have largely focused on air temperature and humidity. However, modifying other thermal comfort factors, such as air speed, changes how the air temperature is perceived. Occupants near a fan feel cooler than they would feel at the same temperature and humidity in still air, like the phenomenon of "wind chill". Therefore, when the air temperature is warmer, occupants near a fan will be more comfortable than they would be in still air conditions. In addition, large-scale studies of occupant survey data indicate that occupants would prefer more air movement than they have, especially if they report feeling warm, as illustrated in Figure 2. These studies also show that increasing air speed can increase satisfaction under all comfort conditions. As Figure 2 shows, in these cases, 40% of occupants also prefer more air movement.

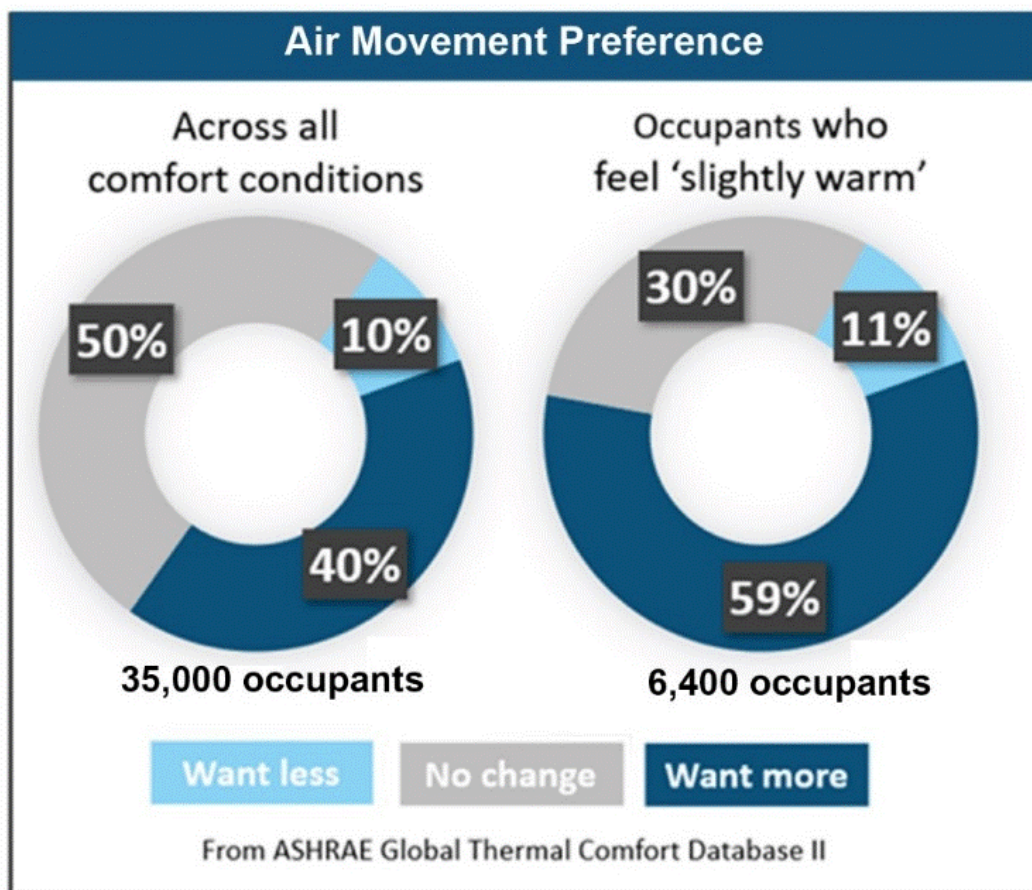

Figure 2. Occupant preference for more air movement (Data source: ASHRAE Global Thermal Comfort Database II).

Improved air distribution

In addition to the thermal comfort benefits, increasing air speed by using fans in concert with the HVAC system can also improve air distribution and provide the desired thermal conditions more consistently throughout a space. When correctly designed and operated, fans support the HVAC system to minimize temperature gradients within a space, providing more consistent temperature and air quality conditions throughout a space. This improved air distribution can be effective for both heating and cooling scenarios. For example, [ASHRAE Standard 62.1 – Ventilation for Acceptable Indoor Air Quality](#) lists a ventilation effectiveness of 0.8 for ceiling-supplied warm air systems (due to stratification of the warm air near the ceiling), but adding ceiling fans in this scenario brings the ventilation effectiveness back to 1.0, or fully mixed condition, reducing the amount of outside air required. As described in “HVAC systems that are not favourable for ceiling fans”, fans do not work with HVAC systems based on stratification as displacement ventilation and underfloor air distribution.

Improved indoor air quality

Fans can also improve air quality by increasing air movement and improving air distribution in space. It changes the airflow pattern in the space, reducing an occupant’s exposure to indoor pollutants in several ways. In spaces with stagnant air or short-circuiting, sources of air pollutants accumulate in the room locally. Air movement redistributes the air, diluting the concentration of these local sources of pollutants in the room air. A study has demonstrated measurable air quality improvement from ceiling fans and desk fans by dissipating carbon dioxide (CO₂) and other exhaled pollutants that would otherwise gather near occupants in still air conditions ([Benabed et al., 2020](#)). Another study shows that using the ceiling fan reduced the concentration at the exposed person’s breathing zone by more than 20%. The effectiveness of the upper-room ultraviolet germicidal irradiation system (UVGI) typically relies on natural air convection within the space to disinfect microorganisms brought from the breathing zone up to the irradiated zones near the ceiling. Using ceiling fans greatly improved UVGI effectiveness by mixing the microorganisms-laden air up to the irradiation zone, thus disinfecting them at a higher rate than cases without ceiling fans. Elevated air movement increases the deposition rate of airborne particles onto indoor surfaces such as fan blades and room furniture, floor, ceiling and walls, thus reducing the likelihood of occupants inhaling them. Increased air movement also prevents the sensation of stale or stuffy air and helps dissipate odors.

Energy savings

Perhaps most importantly, when implemented effectively as an integral component of a building’s thermal comfort strategy, fans can also result in significant energy savings by reducing the demand for the HVAC system. Although they consume energy, the potential HVAC savings outweigh fan energy use, typically by a factor ranging between 10 and 100 times. The primary energy saving derives from thermal comfort benefits, keeping occupants comfortable at higher temperatures and allowing for increased cooling setpoints. In cooling, a room with fans is thermally comfortable over a wider range of temperatures than a room without fans. This wider range of temperatures reduces the cooling and AHU fan energy. Lastly, when ceiling fans provide air distribution, reducing the extent of distribution ductwork and diffusers, they also help reduce HVAC fan energy by reducing the pressure drop in the air system.

Cost savings

Using ceiling fans to distribute air more effectively throughout a space can reduce the extent of distribution ductwork and diffusers required to serve a zone. Additionally, if the same zone is designed to a slightly higher cooling setpoint due to the comfort cooling effect provided by the fans, this can reduce the required latent and sensible cooling capacity of the HVAC system, providing first cost savings to the chiller, air handling unit, and ductwork. The cost of fans is low compared to the savings generated by reducing ducts and HVAC capacity. Moreover, as fans can help reduce energy consumption, they will reduce energy costs.

Elevated air speed and thermal comfort

Overview

In this section, we discuss the thermal comfort related effects of increased air movement using fans for cooling applications. We also discuss tools such as the [CBE Thermal Comfort Tool](#) to help determine the right air speed and other factors for optimal thermal comfort. Figure 3 shows the cooling effect – or how many degrees warmer the air temperature can be to provide the same level of thermal comfort – associated with increased air speeds. This figure also highlights that the design air speeds discussed in this guide are well below the air speeds that a person experiences every day. For example, a design speed of 0.5 m/s [100 fpm], equal to approximately 2 °C [4 °F] cooling effect, is approximately half the air speed that a person experiences just from the relative motion of walking slowly through still-air conditions.

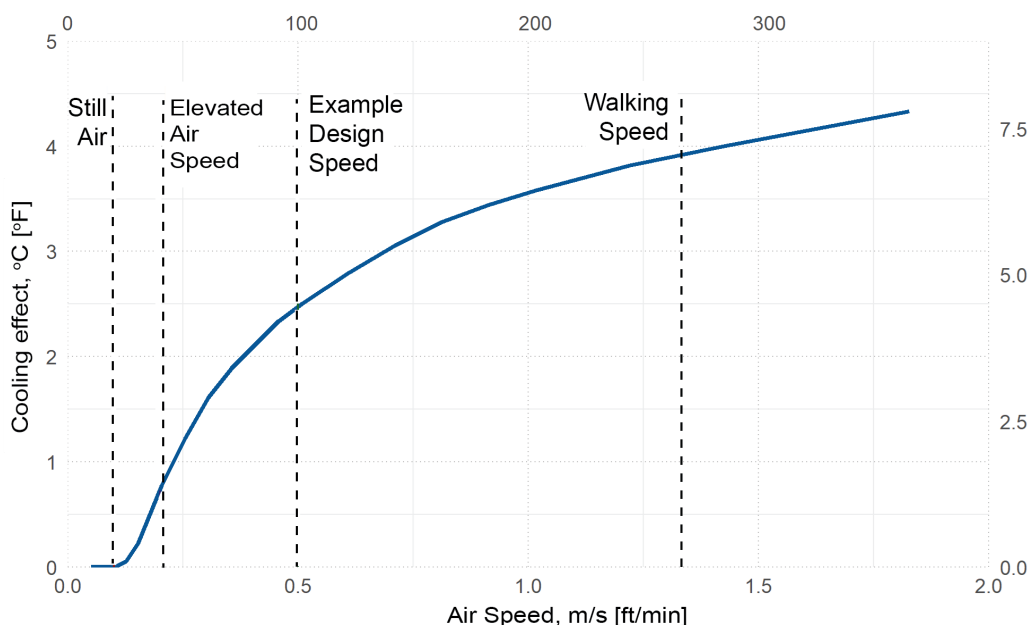

Figure 3. Cooling effect of increased air speed for a 'typical' office worker in cooling conditions (operative temperature of 24.4 °C [76 °F], 50% relative humidity, 0.6 clo, 1.13 met).

Human body thermoregulation

Thermal comfort, here defined as the occupant's satisfaction with the perceived thermal sensation, depends on how much heat is released or retained by the occupant's body. [Human thermoregulation](#), as depicted in Figure 4, is the heat transfer process to and from the body that occurs in four ways: radiation, convection, evaporation, and conduction.

How Human Body Lose Heat

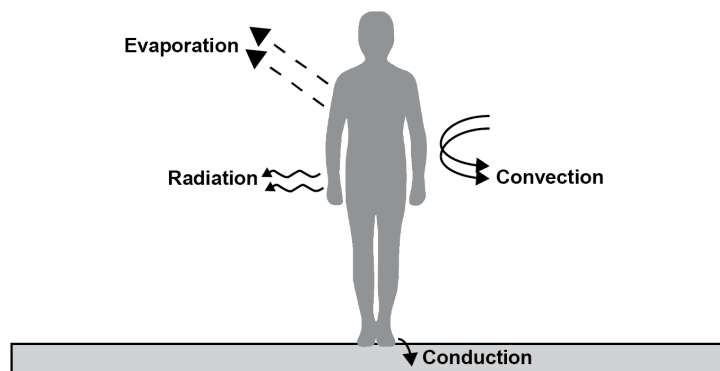

Figure 4. Human body thermoregulation (i.e., heat gain and loss) pathways.

Thermal comfort factors

ASHRAE Standard 55 – Thermal Environmental Conditions for Human Occupancy (2020) identifies six factors that affect [thermal comfort](#). The [metabolic rate](#) is the rate of transformation of chemical energy into heat and mechanical work, based on the level of activity (e.g., walking presents a higher metabolic rate than seating). The [clothing insulation](#) is the insulating effect of clothing preventing heat loss from the body (e.g., shorts and a short-sleeve shirt have lower insulation levels than pants and a heavy sweater). The [air temperature](#) is the temperature of the air, usually measured by the thermostat. The [mean radiant temperature](#) is the average temperature of the surfaces surrounding a certain point, weighted by the view angle of each surface to that point. The [air velocity or air speed](#) at a certain point is the influential factor we explore when fans are used. And the last one is [humidity](#), which indicates how much moisture the air contains.

How elevated air speed meets thermal comfort goals

Fans increase air speed and heat transfer via convection and evaporation, which provides a cooling sensation. It allows the body to maintain thermal comfort at higher air temperatures than what would be comfortable in still air. In addition to providing comfort at increased temperatures, fans are capable of providing instantaneous comfort effects that thermostat adjustments usually cannot because it controls a slower process. A thermostat and HVAC system that conditions the whole room generally takes 15 minutes or longer before the occupant can perceive a change in their thermal environment. However, when an occupant feels too warm, turning on or increasing the speed of a fan instantly provides a cooling sensation, also known as the cooling effect. Fans are also ideally suited to providing adaptive or transitional comfort for changing human comfort conditions. Adjusting fan speeds can help accommodate the natural fluctuations in body temperature and comfort preferences throughout the day. The adjustable nature of fans can provide enhanced thermal comfort during transitional moments, such as the changing comfort needs when transitioning from an active metabolic rate event (for example, after walking from a meeting in a different part of the building or arriving in to work from a morning commute) to a resting metabolic rate (such as sitting at a desk in an office), or simply due to different personal thermal comfort requirements of occupants in the same physical space. The ASHRAE Standard 55 (2020) and the [CBE Thermal Comfort Tool](#) both help to inform how much air movement is needed for thermal comfort and occupant satisfaction.

Thermal comfort calculation with elevated air speed

ASHRAE Standard 55 (2020) provides a method called The Elevated Air Speed Comfort (Section 5.3.3. of the standard) to calculate thermal comfort in situations of elevated air speed. This method uses a combination of the Analytical Comfort Zone Method with the Standard Effective Temperature (SET) method (Normative Appendix D of standard). Since increasing air speed has a cooling effect, the method calculates adjusted air and radiant temperatures according to how occupants are expected to feel under increased air speed conditions to calculate a new PMV value. The “Standard Effective Temperature” (SET) output translates the six thermal comfort factors (presented before) into a single temperature equivalent. The SET provides a single metric that can be compared across a variety of comfort conditions.

The cooling effect is also used to calculate the Cooling Fan Efficiency (CFE). CFE is defined in [ASHRAE Standard 216](#) as the ratio of the cooling effect to the input power of the fan. CFE gives people a standardized way to compare how much cooling a fan provides when consuming the same amount of energy.

Elevated air speed for destratification in heating mode

In addition to directly cooling occupants, fans also effectively mix the air in a space, which has several applications. The most common of these applications is where the temperatures in space are unwantedly stratified, with warmer air close to the ceiling and cooler air near the floor (Figure 5). This typically occurs in spaces with high ceilings or where the heating equipment has a relatively high discharge temperature and low mixing momentum. In these conditions, ceiling fans can mix the air in the space such that the temperature at the floor (and near where the thermostat is located) is close to the average temperature in the space. This can save energy and improve occupant comfort. Ceiling fans are most effective in providing destratification, as they are located close to the ceiling and can run in either direction to achieve this mixing, although they will use more power to achieve the same mixing effect when operating in reverse (moving air upward) than forwards (moving air downward). Note that during destratification, the space is typically operating in heating mode and operating at the lower end of the range of temperatures that define the thermal comfort zone. As such, it is very important to maintain very low air speeds in the occupied zone to avoid the sensation of draft. Depending on the specific conditions, the occupant locations, and the minimum speed capabilities of the fan, running the fan forward or reverse may be better to achieve this goal.

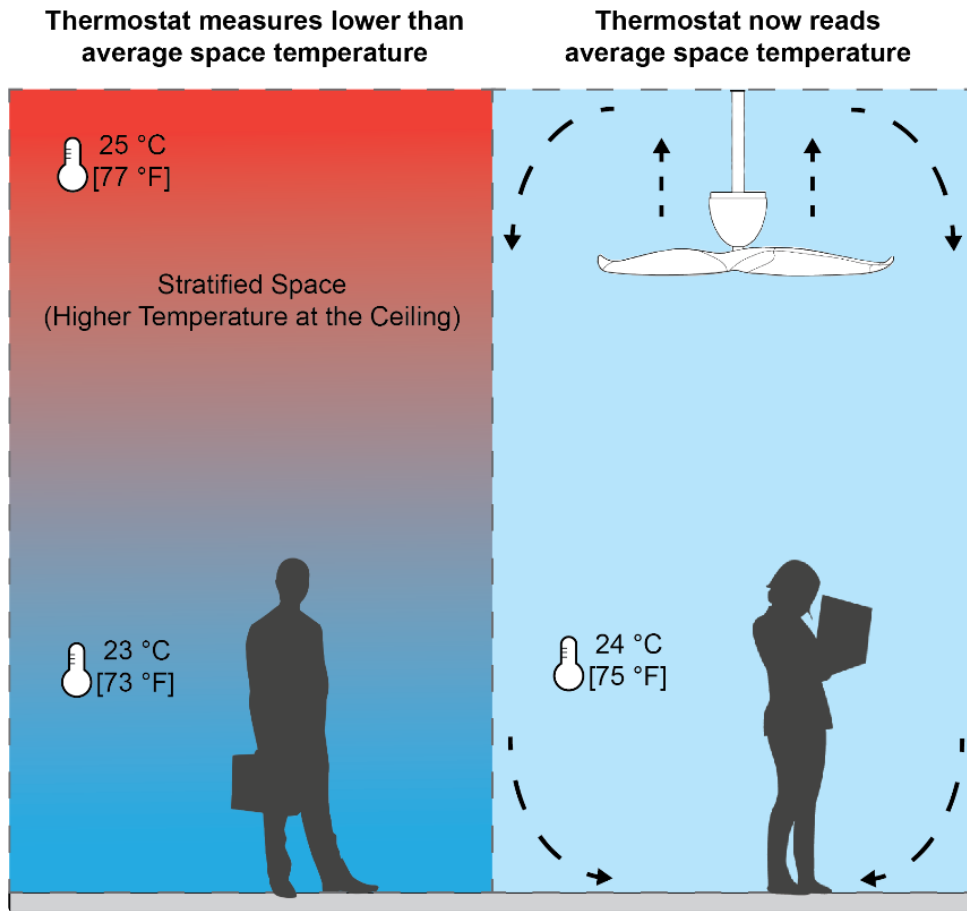

Figure 5. Ceiling fans (blowing upwards) for destratification.

Evidence of occupant's preference for air movement

In theory, elevated air movement accelerates heat loss from occupants via convection and evaporation in a warm environment. The question is, do occupants appreciate elevated air movement? Or do the occupants prefer an environment with cooler temperatures than increased air speed? An experiment conducted in a climatic chamber in Singapore investigated occupants' thermal acceptability under different temperature setpoints with and without fan operation. Figure 6 shows that occupants were thermally more acceptable at 26 °C [79 °F] with higher air movement from personally controlled fans when compared with the condition at 23 °C [73 °F] without a fan. Surprisingly, it also reported that the subjects found themselves thermally more acceptable with temperature at 29 °C [84 °F] with a fan than at 23 °C [73 °F] without a fan. These results revealed that the cooling strategy of only lowering the temperature setpoint might not sufficiently satisfy the occupants, while elevated air movement within the space can play a role in increasing thermal acceptability at higher temperature setpoints.

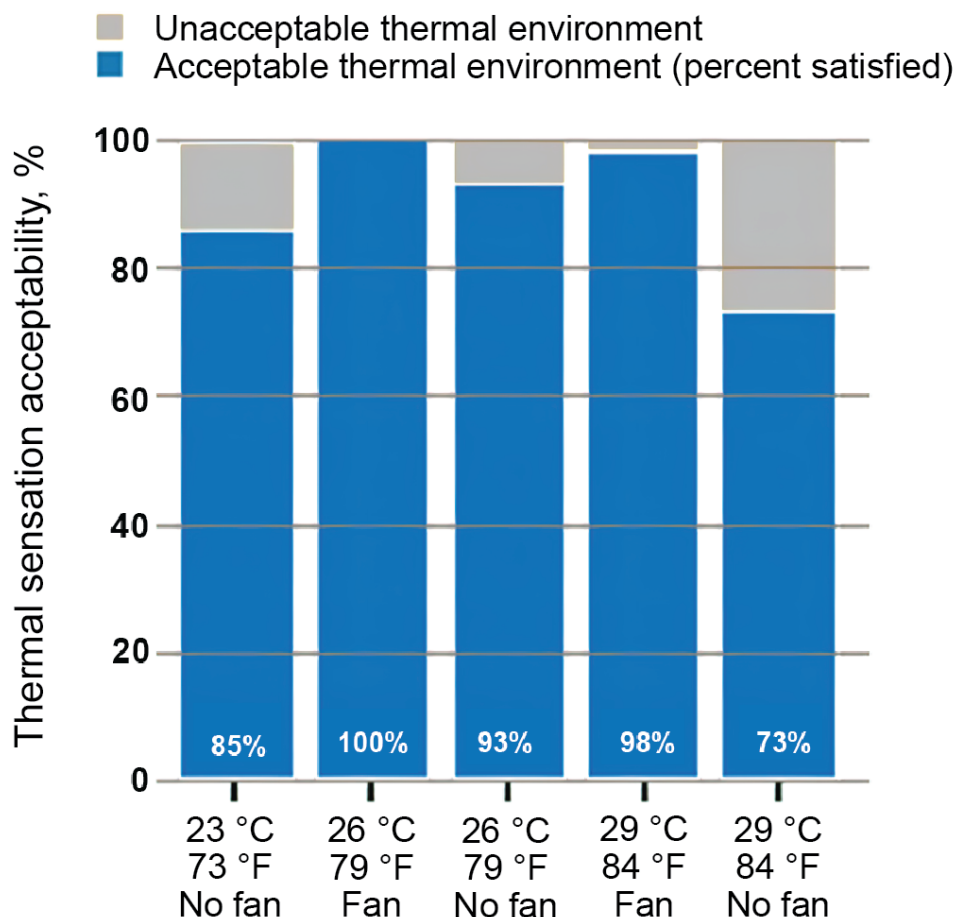

Figure 6. Occupants' thermal acceptability responses in climatic chamber (Schiavon et al., 2016).

To validate the results from the experiment in a climatic chamber, a similar experiment has been conducted in a Singapore office building studying the occupants' thermal acceptability and thermal preference responses under three conditions (23 °C [73 °F] without a fan, and 26/27 °C [79/81 °F] with fan). The study found similar higher thermal acceptability among the occupants for the environment at 26 and 27 °C [79 and 81 °F] with elevated air speed than the condition at 23 °C [73 °F] without fan operation. Besides, the occupants were overcooled and reported a preference for a warmer environment at 23 °C [73 °F]. These results from a real building aligned with the findings obtained in the climatic chamber experiment, where both studies suggested that occupants in tropical climate regions preferred a warmer temperature with elevated air speed over an environment with a cooler temperature without sufficient air movement.

Heat stress and air movement

Some health guidelines actively advise not to use a fan when indoor air temperatures exceed the skin temperature (~ 35 °C [95 °F]). Is it true that a fan shall not be used under heat-stress conditions? Using the human heat balance model, a study found that fans could potentially be used by a healthy young adult even if air temperature exceeds 35 °C [95 °F], because elevated air speed through the human body increases sweat evaporation from the skin (Tartarini et al., 2022). Figure 7 demonstrates under which conditions the fan use could be beneficial. The green zone shows the environmental conditions in which the fan operating at $V = 0.8 \text{ m/s}$ [160 fpm] is beneficial (i.e., providing additional cooling to the human body). The dark green zone represents the conditions where fan usage is still beneficial, but people are likely to suffer from heat strain. The red zone indicates the conditions under which fans are not beneficial and should not be used. The red line shows the temperature limit from WHO, which the usage of fans is not recommended. These findings indicate that fans could be used in some conditions to cool people even when the air temperature exceeds skin temperature. More human experiments and tests with non-healthy groups should be performed. If available and affordable, air conditioning would guarantee safer conditions than just fans.

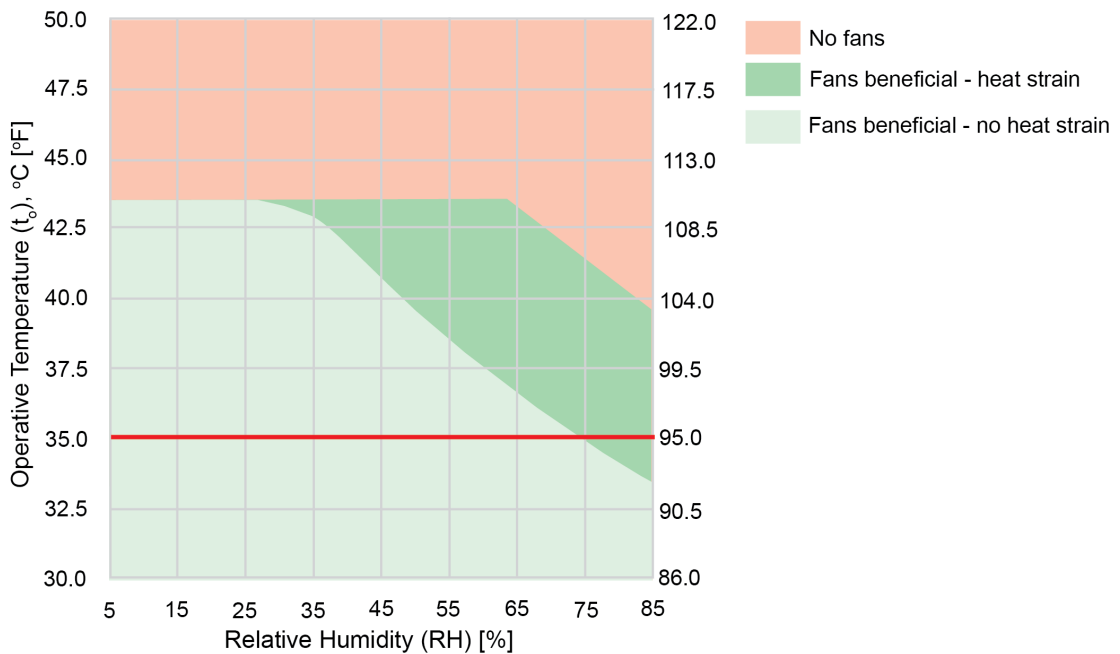

Figure 7. Classification of fan beneficial zones based on operative temperature and relative humidity.

Ceiling fans

Which are the components and performance metrics of ceiling fans?

There are multiple fan types available in the market, but ceiling fans outweigh their benefits over the other fan types in terms of air circulation effectiveness and low energy consumption, especially for serving multiple occupants within the same space. In addition, installation and operation of ceiling fans are specific to building design and different from other portable fan options. Therefore, this guide highlights a separate section for ceiling fans, while other fan choices (i.e., other air movement devices) will be clustered in another section.

Ceiling fan options

The following sections describe the different types of ceiling fans, and the features that differentiate ceiling fan models.

Fan types

A part of the "[Uniform Test Method for Measuring the Energy Consumption of Ceiling Fans](#)" from the US Department of Energy (DOE) defines a variety of ceiling fan types. This guide focuses on several of them defined below:

Standard ceiling fan: any ceiling fan with a diameter greater than 45 cm [18 in] but no more than 2.1 m [7 ft], and with the lowest point of the fan blades more than 25 cm [10 in] below the ceiling. A standard ceiling fan does not exceed the limits outlined in Table 1 below.

Large-diameter ceiling fan: any ceiling fan that is greater than 2.1 m [7 ft] in diameter. These are often also known as High Volume Low Speed (HVLS) fans.

Small-diameter ceiling fan: any ceiling fan that is more than 46 cm [18 in] in diameter but less than or equal to 2.1 m [7 ft] in diameter, and with an airflow of at least 0.87 m³/s [1840 CFM] and a rotational speed of more than 1.5 Hz [90 rpm] at its highest speed.

High-speed small-diameter ceiling fan: any small-diameter ceiling fan that has a blade thickness of less than 3.2 mm [12.6 in] at the edge or a maximum tip speed greater than the applicable limit specified in Table 1 below.

Low-speed small-diameter ceiling fan: any small-diameter ceiling fan that has a blade thickness greater than or equal to 3.2 mm [12.6 in] at the edge and a maximum tip speed less than or equal to the applicable limit specified in Table 1 below. ("Standard ceiling fans", defined above, are a type of low-speed small-diameter ceiling fan).

Hugger ceiling fan: any low-speed small-diameter ceiling fan for which the lowest point on the fan blades is less than or equal to 25 cm [10 in] from the ceiling.

Very-small-diameter ceiling fan: any ceiling fan with one or more fan heads, each of which has a blade span of 46 cm [18 in] or less, and with an airflow of at least 0.87 m³/s [1840 CFM] and a rotational speed of more than 1.5 Hz [90 rpm] at its highest speed.

Highly decorative ceiling fan: any ceiling fan with a maximum rotational speed of 1.5 Hz [90 rpm] and less than 0.87 m³/s [1840 CFM] airflow at high speed

Note that while these DOE definitions include a variety of sub-categories for small-diameter fans, any fan larger than 2.1 m [7 ft] in diameter is simply a “large-diameter” fan, with no further differentiation.

Table 1. Ceiling Fan Blade and Tip Speed Criteria (Adapted from DOE Definitions).

Airflow Direction	Thickness (t) of edges of blades	Thickness (t) of edges of blades	Tip speed threshold	Tip speed threshold
	mm	in	m/s	fpm
Downward-Only	4.8 > t ≥ 3.2	3/16 > t ≥ 1/8	16.3	3200
Downward-Only	t ≥ 4.8	t ≥ 3/16	20.3	4000
Reversible	4.8 > t ≥ 3.2	3/16 > t ≥ 1/8	12.2	2400
Reversible	t ≥ 4.8	t ≥ 3/16	16.3	3200

The DOE also defines a variety of other specialty ceiling fan types (including belt-driven ceiling fans, centrifugal ceiling fans, multi-head ceiling fans, and oscillating ceiling fans), but those specialty types are not the subject of this guide. This guide primarily focusses on two main ceiling fan types, defined above as “standard ceiling fans” and “large-diameter ceiling fans”. However, much of the discussion in this guide will also be relevant to the other small-diameter ceiling fan types beyond the “standard” definition, and there is significant overlap between many of the small-diameter ceiling fan sub-categories. Note, for example, that “standard ceiling fans” are a type of low-speed small-diameter ceiling fan, and “hugger ceiling fans” are essentially equivalent to standard ceiling fans but with fan blades mounted closer to the ceiling (despite the negative effect on efficiency) for suitability in spaces with lower ceiling heights.

In general, a larger diameter fan blade can move a larger volume of air than a smaller diameter fan blade. As fan diameter increases, rotational speed is typically limited to prevent excessive noise from the fan blades, especially near the blade tip. Additionally, where fans can be mounted at blade heights below 10 ft (i.e., almost all standard fans), rotational speed must be limited to meet safety criteria (see [UL 507: Standard for electric fan](#)) for the maximum speed of the blade tips. Large-diameter ceiling fans are sometimes referred to as “high volume low speed” or HVLS fans. Because the design and shape of the fan blades can also have a significant impact on airflow, as described in more detail below, the HVLS terminology is typically used to describe large ceiling fans that are designed to prioritize performance in large commercial and industrial spaces. For example, some large-diameter ceiling fans include “winglets” or blade tip fences to maximize airflow and minimize noise, which is a less common problem in standard fans as the blade tip speed is already constrained for safety reasons.

Though standard ceiling fans are more applied in residential applications, they are equally effective for comfort cooling in most non-residential applications (including offices, classrooms, gyms, hospitality, etc.) where they can be positioned near the occupants. Large-diameter ceiling fans require higher ceilings (typically at least 3.3 m [11 ft]) and larger spaces free from obstructions to accommodate their increased diameter. As a result, large-diameter ceiling fans are most often found in non-residential commercial and industrial applications.

Although the fan type definitions from the DOE focus on fan diameter, in the case of specific fan products there is some overlap in terms of applications and fan styles. Some large-diameter fans are available in styles that are more frequently associated with standard fans, and some manufacturers have HVLS fan models in diameters less than 2.1 m [7 ft]. Additionally, there are some large-diameter fans that have a relatively low maximum rotational speed and thus, meet blade tip speed and thickness requirements for mounting below 3 m [10 ft], though these also have a relatively low maximum airflow.

Blade type and blade number

Blade shape, number of blades, and blade pitch are important factors in increasing energy efficiency while maximizing airflow through the fan blades. There are two main types of blades shapes shown in Figure 8 below. Blade shapes have evolved over time from flat to airfoil-style blades to become more energy efficient and maximize air movement. As the name implies, flat ceiling fan blades are flat panels mounted at a fixed angle, whereas airfoil blades are like airplane wings in section. Like the cross-section of an aircraft wing, the curvature of the airfoil blades helps increase airflow through the ceiling fan, minimizing air turbulence at the trailing edge of the blade common to flat blades. Airfoil-style blades are thus typically more efficient and quieter than flat blades. However, flat blades are cheaper to manufacture. Note that flat blades will perform equally whether the fan is operating in the forwards (blowing down) or reverse (blowing upwards) direction. In contrast, airfoil blades will not operate as efficiently in reverse, and will typically have a lower airflow when doing so. Some fan models have blades that can be manually attached in inverted position or can mechanically invert the blade while it is attached to the fan, which allows for improved efficiency when operating in reverse.

The number of blades is an important factor in increasing airflow of ceiling fans. Nevertheless, the increased weight and drag due to the blades can cause a loss in energy efficiency. Standard fans typically have between 3 and 5 blades, though some models have as few as 2 blades or up to 6 blades. Large-diameter fans typically have 6 or 8 blades, with some models having as few as 3 blades.

Similarly, increasing the blade's angle may also increase airflow at the cost of energy efficiency. Academic modeling studies have found the optimal blade angle to be 8-10 ° for residential fans. Manufacturers recommend 12-15 °. Some airfoil-style blades also vary the blade angle over the length of the fan blade, with steeper angles toward the center of the fan to maximize airflow for the low blade speed in this region and reducing to shallower angles toward the tips where the blade speed is high to limit drag and maximize energy efficiency.

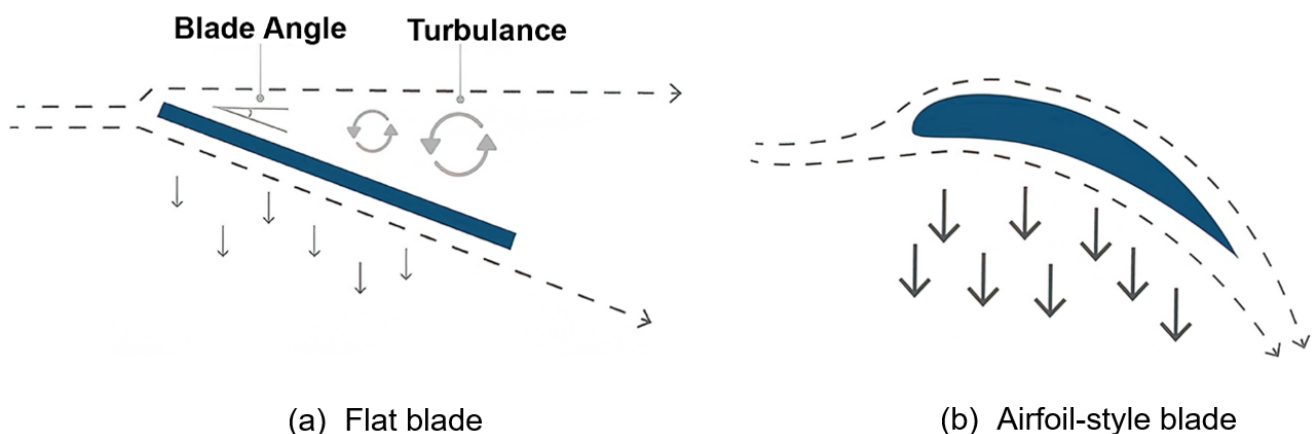

Figure 8. Ceiling Fan Blade Types.

Motor and drives

There are three main types of motors used in ceiling fans: AC induction, permanent magnet DC (PMDC), and brushless direct current (DC) motors. Generally, there are very large percentage efficiency savings when changing from AC to DC motors for small fans, and far less of an effect for large diameter fans. AC induction works with electromagnets outside the motor that creates a rotating magnetic field causing motor rotation through induction. The benefits are that it provides constant and even airflow and it is cheaper than DC motors. PMDC has magnets located on the motor creating a stationary magnetic field. A segmented commutator rotates within the magnetic field creating a mechanical switching of current direction. The benefit is being more energy efficient than AC motors and providing constant force over a wider range of speeds than AC motors. Brushless DC work with permanent magnets rotated in motor creating a rotating magnetic field. The current direction in the stator is switched in relation to the magnetic field to create rotation. This is the most energy efficient motor types (for small motors on small diameter fans, a DC motor often will use 70 % less energy than an AC motor), most quiet, and has a longer service life than PMDC motors, with the same benefit of enabling a wider range of air speed.

Fans may also be either direct drive or gear driven. Almost all small-diameter fans are direct drive, but large-diameter ceiling fans may either be direct-drive or gear-driven. Direct-drive fans are quieter than gear-driven fans, which have a more refined appearance, and reduced operating cost. However, direct-drive fans do provide less airflow and it may be harder to replace the motors. Due to this, direct-drive fans are typically used in situations where sound level and aesthetics are a concern, and less airflow is needed.

On the other hand, gear-driven fans allow for higher motor power and are often used in situations where maximizing airflow is a priority over sound levels or aesthetics. This is well suited for industrial settings where ceilings are high and there is little or no air conditioning.

Understanding ceiling fan metrics

Several factors determine a ceiling fan's performance, as well as its suitability to a given application. Some of the most critical factors are described in the following sections.

Diameter and rotational speed

Ceiling fans are available in a wide range of diameters, from very small fans approximately 45 cm [18 in] in diameter to very large fans up to 7m [24 ft] in diameter. Determining the appropriate fan diameter depends largely on the dimensions of the space and the application, as discussed in more detail later in this guide. The California Energy Commission maintains the Modernized Appliance Efficiency Database System ([MAEDbS](#)), which contains a large dataset of information on ceiling fans as well as many other types of appliances. For context, this dataset shows that most fan models on the market today are between 1.2 – 1.5 m [4 – 5 ft] in diameter, and presumably therefore aimed at the residential market, as illustrated in Figure 9, below.

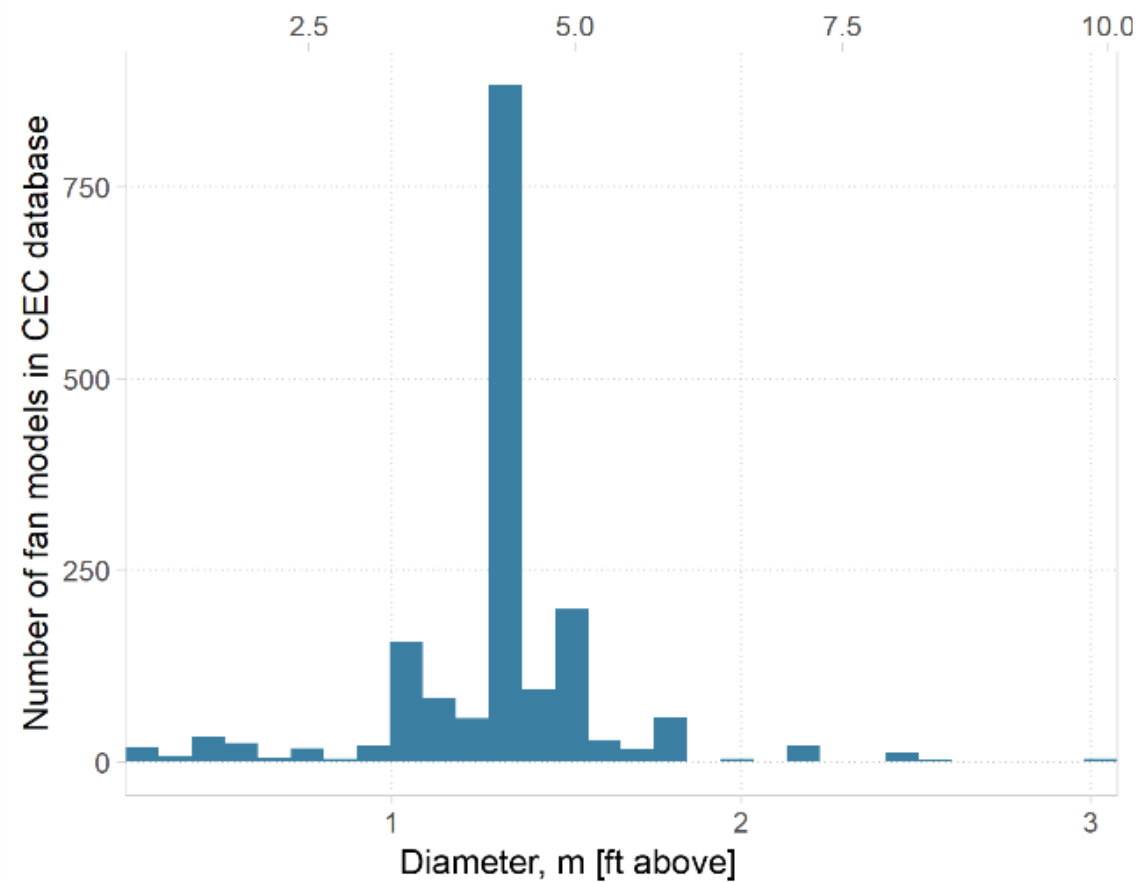

Figure 9. Distribution of fan diameters in a random sample of the fans in the CEC MAEDbs database.

All other factors being equal, a larger diameter fan will produce greater airflow through the fan than a smaller diameter fan at the same rotational speed. Figure 10 shows a range of example fans of varying diameters and the range of possible airflows and rotational speeds at which those fans can operate. In general, higher airflow through the fan generally results in higher average air speeds in the space. Additionally, larger fan diameters increase the uniformity of air speeds throughout a space. Lastly, larger diameter fans increase the depth of the boundary layer of air moving along the floor in the spreading zone outside the fan blades. This figure also highlights the differences between fan models even if they have the same diameter. Comparing the Type G and Type F fans, of equal diameter (2.4 m [8 ft]), it shows the range of performance varies by fan type. The Type G fan has a higher maximum airflow, a lower minimum airflow, and a higher rotational speed for any particular airflow.

For any particular fan, airflow is linear with rotational speed, as Figure 10 also shows. Additionally, the air speed at any point in the space is also directly linear with fan rotational speed. So, if a point in the room measures 0.5 m/s [100 fpm] when the fan is rotating at 1.3 Hz [80 rpm], it will measure approximately 0.25 m/s [50 fpm] at 0.7 Hz [40 rpm]. This relationship begins to break down at very low air speed, very low rotational speeds, or where the fan blade height is unusually far from the floor (e.g., > 3 m [10 ft]).

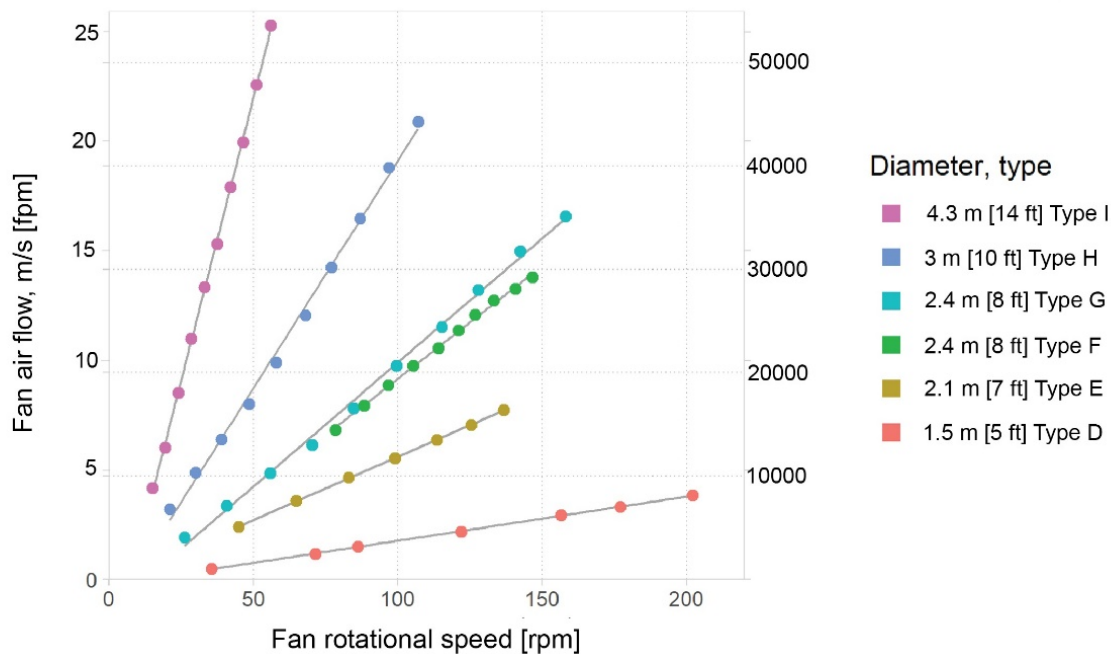

Figure 10. Fan rotation speed and fan airflow for fans of varying diameters.

Power and fan efficacy

The power consumed by a fan increases in proportion to the cube of its rotational speed, while the airflow generated by the fan increases linearly with its rotational speed. Thus, fan efficacy - or the airflow per unit power consumed - decreases as fan speed increases. However, in many fan models, motor efficiency is poor at lower speeds, partially counteracting this effect. In the MAEDbS dataset, the typical (median) fan efficacy at the lowest operating speed of each fan is $0.08 \text{ m}^3/\text{s}\cdot\text{W}$ [165 CFM/W], while it is $0.04 \text{ m}^3/\text{s}\cdot\text{W}$ [79 CFM/W] at highest operating speed. Note that the only way to make a direct energy performance comparison between one fan and another is to compare it under the same conditions - the same diameter and the same power (or the same airflow). This is because fans with lower-rated maximum airflows will have a better-rated efficacy even if they consume more power to provide the same airflow. Note that the US Department of Energy and [ENERGY STAR criteria](#) – and the metric that shows up on the Energy Guide label - calculates the ceiling fan airflow efficacy using an average of the metric at different operating speeds, weighted according to the amount of time the fan is expected to operate at those speeds, including a standby power loss. However, this does not account for the maximum and minimum airflows between fans of the same diameter, so it can be misleading. As before, fans with lower maximum airflow will generally perform better in this efficacy metric. Figure 11 highlights the issue, where three fans have the same $0.11 \text{ m}^3/\text{s}\cdot\text{W}$ [234 CFM/W] efficacy, but there is a clear difference in performance between the fans due to the different range of airflows provided. The fan represented by the left most curve (least efficient, lowest maximum airflow) is rated as having the same overall efficacy as the fan represented by the right most curve (most efficient, highest maximum airflow).

Meanwhile, the [ceiling fan energy index \(CFEI\)](#), a ratio of reference fan power input to actual fan power input, is a more reliable alternative in reflecting the above blind spot. It helps to make inefficient fans less likely to comply with slower speeds and to remove the unintentional barrier to compliance for high-performing high-utility fans by comparing fans to a standardized baseline. Taken the same example in Figure 11, CFEI at high fan speed for the left most and right most curve is, respectively, 0.63 (less efficient) and 1.72 (more efficient). See section “[Ceiling fans testing regulations](#)” for more information.

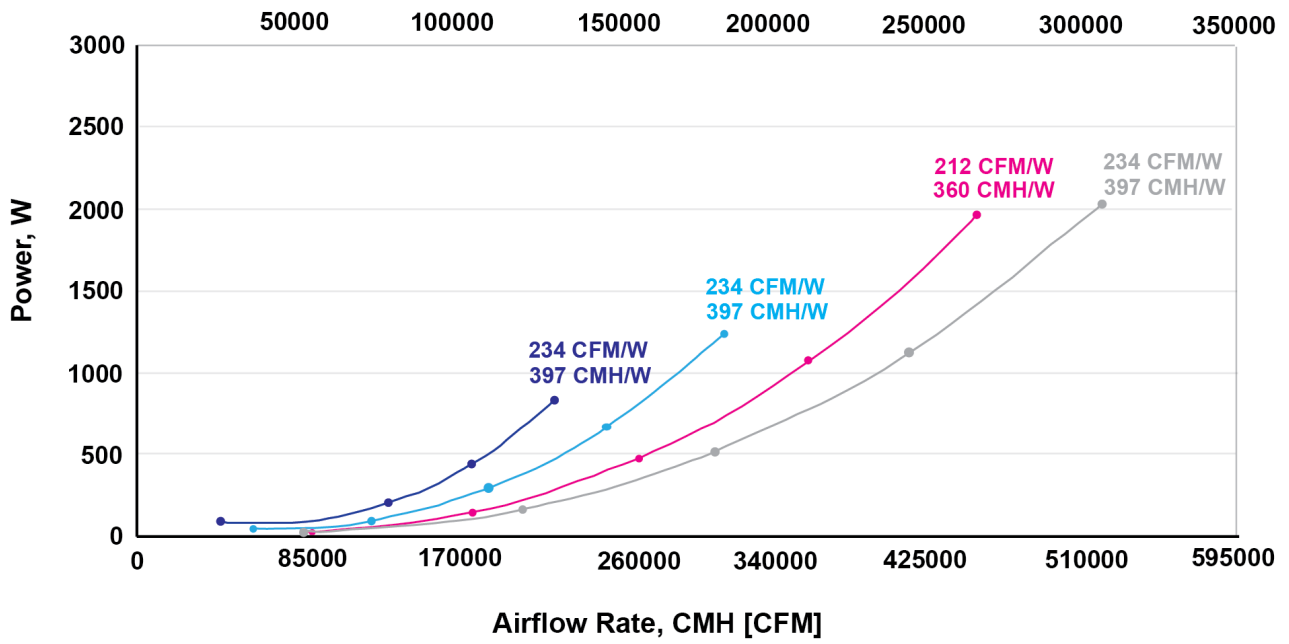

Figure 11. Fan efficacy versus total airflow and power.

Fans that can turn down to a low rotational speed and maintain good motor efficiency at that speed can operate very efficiently under those conditions. There are several fans in the market with an efficacy of over 0.47 m³/s·W [1000 CFM/W] at their lowest operating speed. Other fans typically have a relatively high minimum speed, and often also have poor motor efficiency at that speed, and these fans benefit less from speed reduction. Generally, the ability of a fan to operate efficiently at lower speed improves as the diameter increases, as Figure 12 demonstrates.

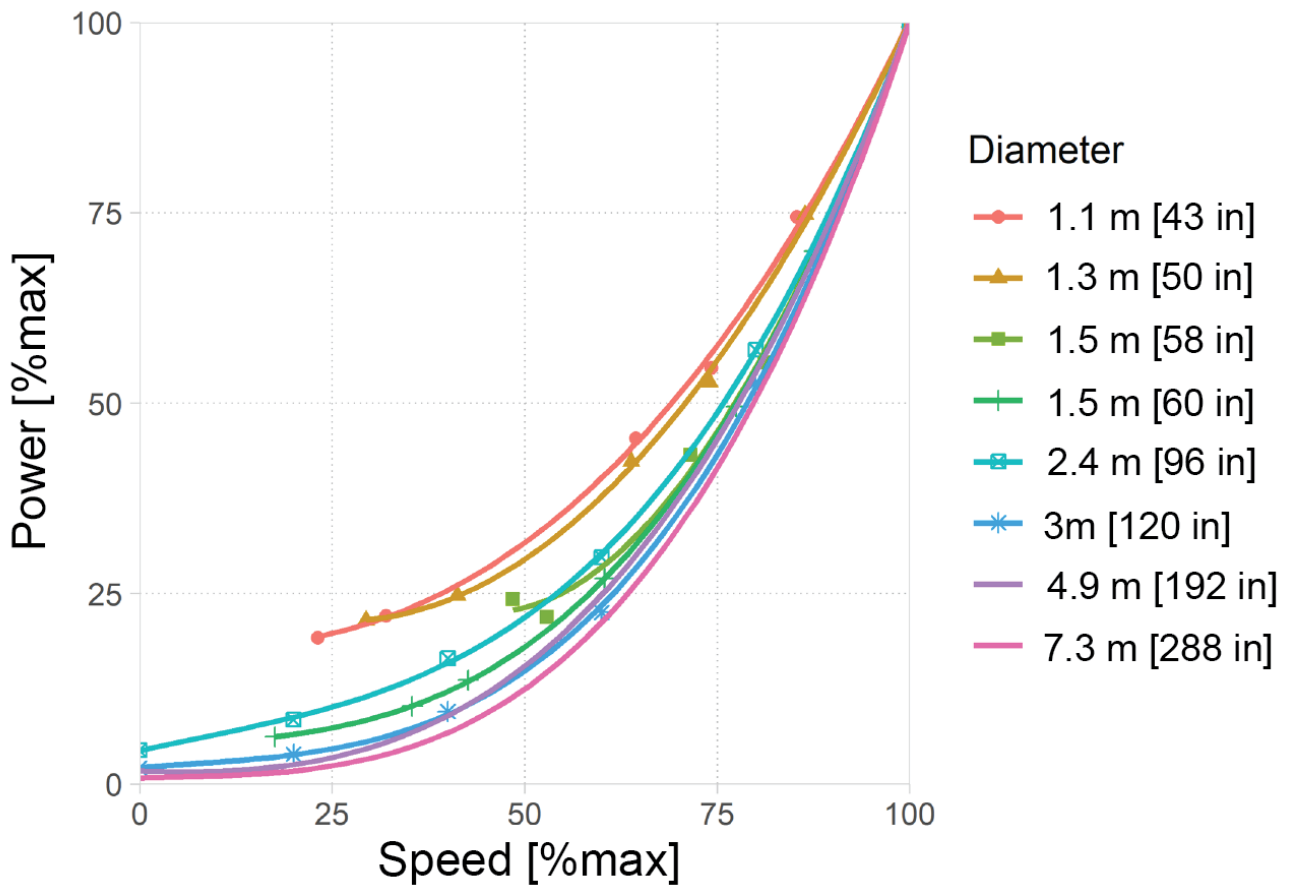

Figure 12. Relationship of power and fan speed settings for eight fans of different diameters (data from a selection of fans from MAEDbS).

However, there is considerable variation in performance between models of fans with the same diameter, as Figure 13 shows. This also demonstrates that there is a wide range of turndown ratios (minimum speed divided by maximum speed) among different fan models at the same diameter. Some fans can operate at or below 20% of their maximum rotational speed, while others cannot run below 50% of their maximum rotational speed. This is also apparent in the MAEDbS data, as Figure 14 shows.

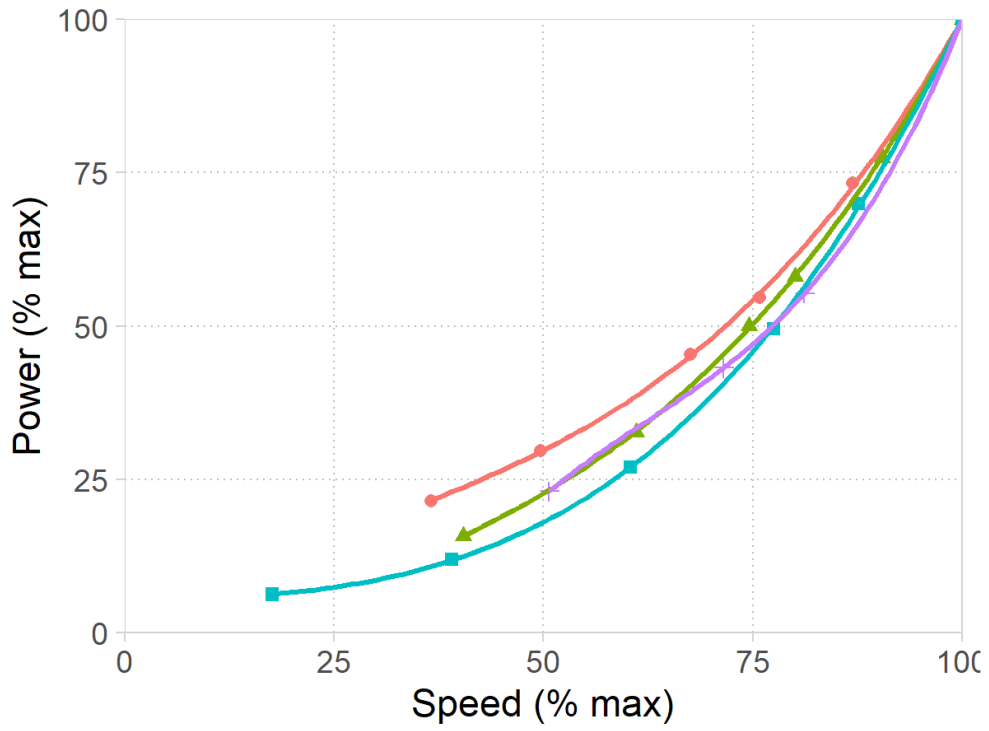

Figure 13. Relationship of power and fan speed settings for four different 5-foot (1.5m) diameter fans.

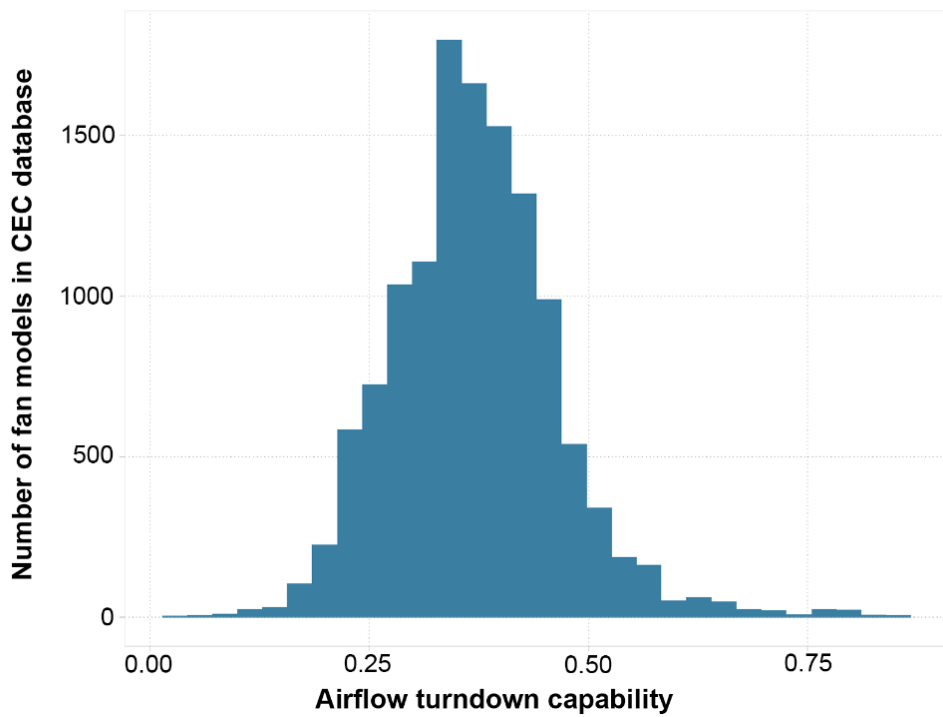

Figure 14. Minimum fan speed for ceiling fans in the CEC MAEDbS database.

Airflow

Drawing data again from the CEC's MAEDbS system, Figure 15 presents random samples of the fans available in the database. This gives a perspective of the range of fan diameters and associated range of fan airflows available on the market today. The test methods for rating the airflow of these fans are federally regulated under [10 CFR 430 Appendix U](#). For standard fans, the rating is determined by a modified Energy Star method, which infers airflow from an anemometer traverse below the fan. For large diameter fans (above 7ft), the rating is determined by the [AMCA 230-15 test method](#), which infers airflow from a load cell measurement of fan.

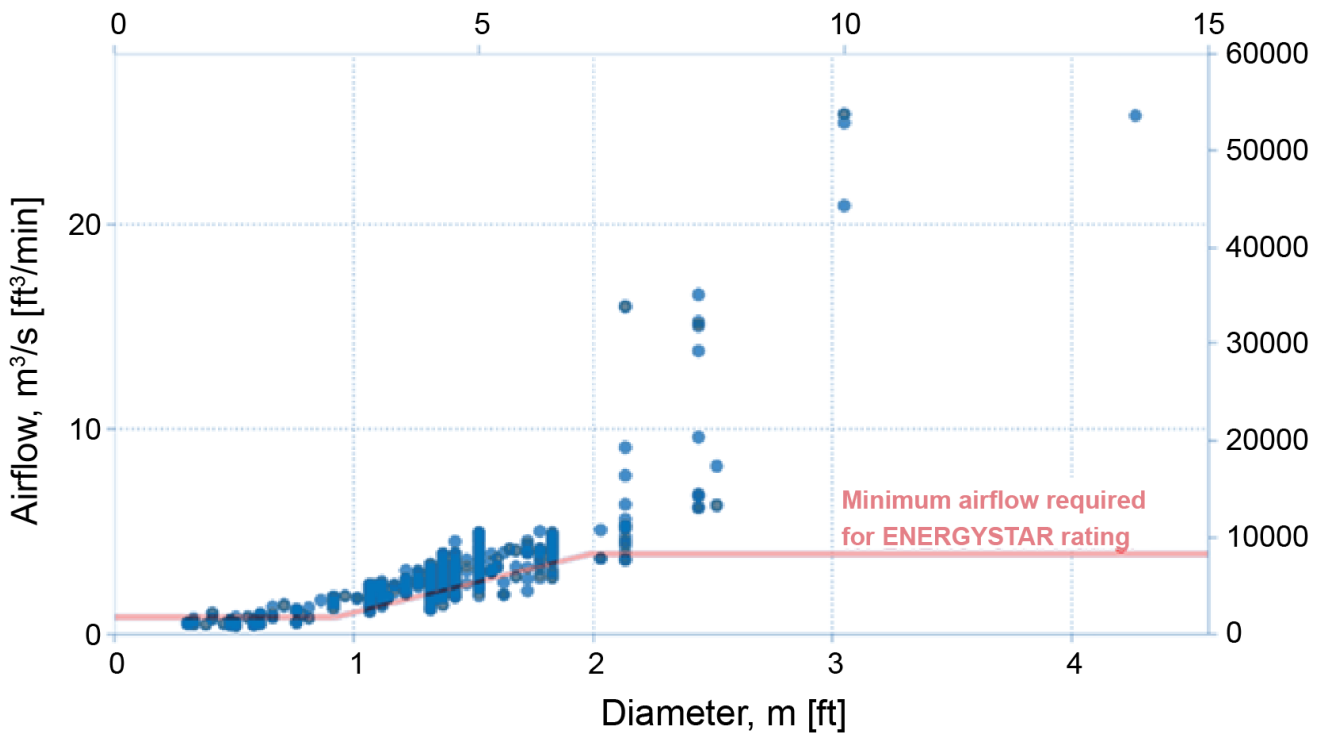

Figure 15. Airflow and fan diameter for ceiling fans in the CEC MAEDbS database.

Airflow direction

All fans sold in the USA are required to be reversible, and thus, fans can run in either direction – forwards, blowing downwards towards the floor, or in reverse, blowing upwards towards the ceiling. Many standard ceiling fans will have a switch on either the wall switch, remote control, or on the motor housing to change the direction between downwards and upwards. For some models this functionality will be provided in the control system or smartphone app. Most applications are for fans blowing downwards, as this is by far the most common and efficient way of creating air movement in the occupied space. Reversing a fan so that it blows upwards against the ceiling requires that the space containing the fan (or fans) is bounded by a ceiling and walls on all sides. This creates a similar recirculation cell as blowing the fan downwards, but it avoids creating a region of high air speeds directly under the fan. Running fans in reverse has the effect of creating a much lower, but much more uniform air speed distribution in the space, which can be desirable in some applications.

One application of running fans in reverse is to mix air the room when elevated air speed in the occupied zone is not desirable. One example is destratifying spaces in the heating season. Many fans have a relatively high minimum rotational speed and if these fans run in the downwards direction, the resulting air speeds may cause a draft on the occupants directly below the fan. This can be remedied by running the fan in reverse. Note here that there are also fans that have a very low minimum speed, allowing them to run forwards without creating a draft on the occupants, while still effectively de-stratifying the space. This uses less power to destratify than a fan with a higher minimum speed running in reverse. Another application of running fans in reverse is when elevated air speed in the region directly under the fan is perceived as excessive for some reason, such as causing paper to blow off a desk.

The ratio of airflow through a fan in the upwards vs. downwards direction depends on the fan type and associated blade geometry. Some fans have highly optimized blade designs that blow downwards efficiently. Here, the blade geometry is not symmetrical when the fan reverses direction, and these do not generate as much airflow at the same rotational speed and power when operated in reverse. Other fans, such as those with a less efficient but symmetrical blade geometry (e.g., flat blades) or those whose blades can be inverted and re-attached to the fan (making the blade geometry symmetrical in reverse), will generate approximately the same airflow operating in reverse.

For context, based on full scale laboratory testing the area weighted average air speed for seated and standing occupants with a fan blowing upwards ranged from 30 to 70% that of the same fan blowing downwards at the same speed in the same room. In cases where the blade geometry is symmetrical (flat blades, or inverted blades), the area weighted average air speed was approximately 60-70% that of the downwards case. Obstructions in the flow from the fan (e.g., furniture, ceiling obstructions, etc.) will likely have a significant effect on these percentages.

Fan air speed

The fan air speed is calculated by dividing the rated airflow of the fan by its diameter. It represents the average air speed that passes through the circle swept by the fan blades. Thus, as with rated airflow, fan air speed varies linearly with fan rotational speed, in other words the airflow rate of a ceiling fan can be scaled (up or down) by its rotational speed. Fan air speed is a useful metric as it is more directly representative of the air speeds that will occur in the space. For example, the maximum air speed at any location and height in the room will typically be within 1.3 to 1.5 times the fan air speed, and it will occur below the fan blade tip, slightly inside the fan blade diameter. That applies regardless of fan diameter. Unlike fan rotational speed, airflow, or power consumption, the concept of fan air speed is also very useful as it allows designers to directly compare fans with different diameters to one other. Figure 16 presents an example from MAEDbs that fans with higher maximum fan air speeds will yield higher maximum air speeds in the room regardless of fan diameter. By using the fan air speed as a metric instead of the rated airflow (see Figure 15), one can directly compare fans to each other even if the diameter differs substantially. This is useful in cases when the design target is the maximum air speed directly underneath the fan.

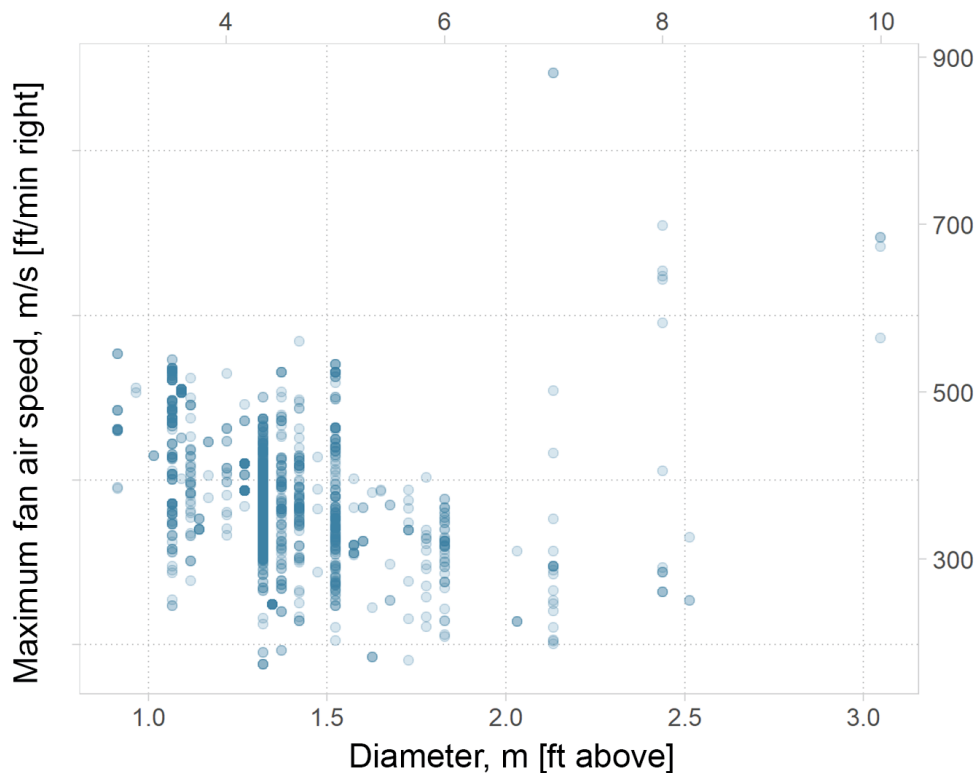

Figure 16. Maximum fan air speed and fan diameter for ceiling fans in the CEC MAEDbS database.

Levels of speed control

Most standard fans typically have several fixed fan speed levels. Though some of these fans have a wide range of speed levels (6 or more), most fans have just 3 (see Figure 17). These are typically standard fans with AC motors, whereas DC motor fans tend to have more speed levels. Large diameter fans are typically variable speed regardless of motor type.

The minimum rotational speed on fans with just 3 speed levels is typically still quite high, and often the minimum speed may generate 0.75 m/s [150 fpm] seated average directly under the fan, equivalent to over 2.8 °C [5 °F] cooling effect. Having a high minimum speed can be problematic in some applications, such where there are occupants located directly under the fans for extended periods of time (e.g., an office) or when the fan is used to destratify a space in heating mode. The reason is that the minimum speed may generate too much of a cooling effect for the occupants when temperatures are mild or cool, and they cannot reduce the speed further without switching the fan off. In contrast, a high minimum speed is less of a concern in transiently occupied spaces, spaces where occupants can move freely around. Overall, in most applications, it is desirable to have more levels of speed control, particularly a minimum level that is slow enough that it generates low air speeds directly under the fan. A reasonable approximation is that the minimum fan air speed should be below 0.4 m/s [80 fpm], or a 1.7 °C [3 °F] cooling effect at the minimum allowed blade height, depending on the specifics of the application.

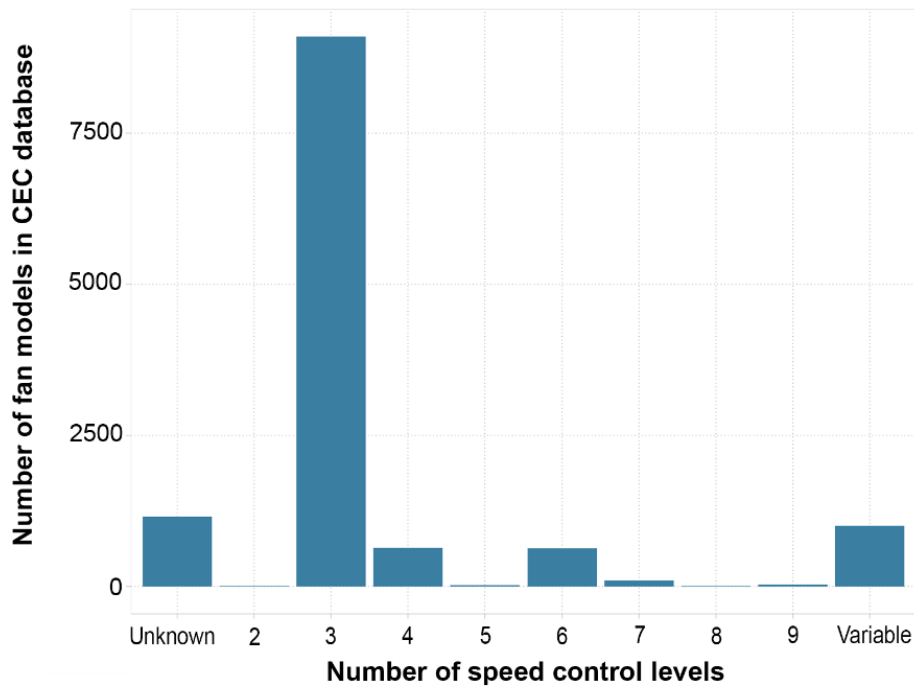

Figure 17. Number of speed control levels for ceiling fans in the CEC MAEDbS database.

Uniformity of air speeds

The amount of variation of the air speeds in a space is an important design consideration. Figure 18 below shows the measured air speeds in a cross section through a 5.5 x 5.5 m [18 x 18 ft] room with a 1.5 m [5 ft] diameter ceiling fan located at the center of the room. The airflow 'jet' from the fan immediately narrows to a slightly smaller diameter than the fan blades. The jet then impinges on the floor, creating a stagnation point, and then spreads radially outwards along the floor. Smaller diameter fans have a relatively shallow spreading zone. For the case shown below, the air speed in the spreading zone is still high along the floor at a distance of one fan diameter from the fan center. However, the air speeds are almost unaffected by the fan at a height of 0.5 to 0.7 m at the same location. In contrast, larger diameter fans have a deeper spreading zone. For fans at or above 3m [10 ft] in diameter, the height of the spreading zone at a distance of one fan diameter from the fan center is approximately the height of an average person. However, large diameter fans have lower air speeds directly under the fan center, near the stagnation point. As Figure 19 shows, the larger the ratio of fan diameter to room size is, the more uniform the distribution of air speeds will be in the room.

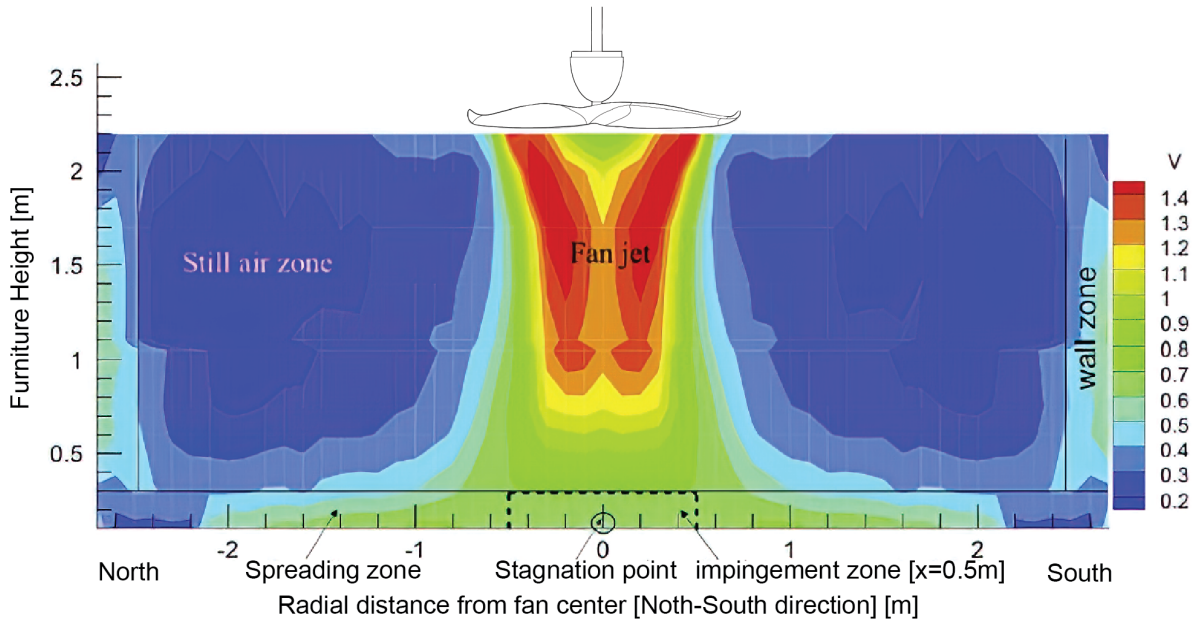

Figure 18. Example air speed distribution from a ceiling fan (Gao et al., 2017).

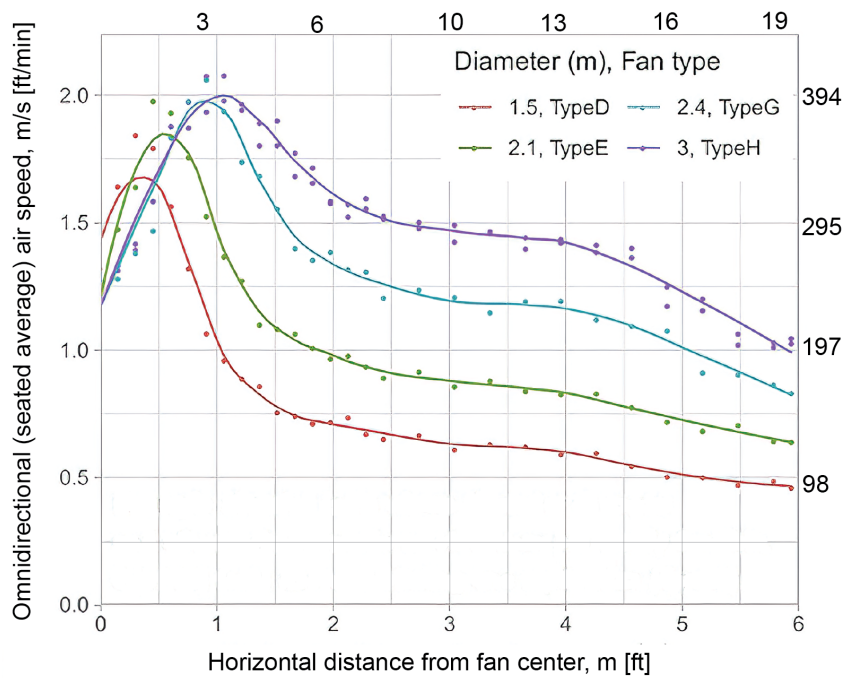

Figure 19. Air speeds over distance from the fan center (Raftery et al., 2019)

IP rating, damp rated, and wet rated

For a motor, drive, and controller combination, it may be useful to check the IP (Ingress Protection) Rating of the fan defined by IEC Standard 60529. The IP rating describes how well an electrical enclosure keeps water and solids out. A direct drive or gear-driven fan with a higher IP rating means that the fan is suited to running in harsh environments or conditions, which may be required for the application under consideration.

Similarly, any ceiling fans in outdoor applications must be rated for outdoor use. UL (Underwriters Laboratories) provides “Damp Location” and “Wet Location” ratings for electrical products such as lighting and ceiling fans. Damp rated ceiling fans can be installed in covered locations where they may be exposed to moisture but cannot be directly exposed to water such as rain or a hose. Wet rated ceiling fans can be directly exposed to rain or washed down with a hose.

Controls

Controls for ceiling fans run the gamut from basic manual on-off and speed controls, to fully automated onboard controls that are also integrated with the building automation system. In any scenario the design and specification of ceiling fans must address a variety of controls considerations. Will the fans be fully manual or automated? Will occupants have control over the fans, and if so how and where? If the fans are automatically controlled, what will the setpoints or triggers be? How much variation in fan speed is necessary for the application? How will ceiling fan controls interface with the HVAC system? These questions must all be considered when planning controls for ceiling fans.

Control needs and priorities will vary from application to application. The following sections provide guidance through the most common decisions related to controls when designing and specifying ceiling fans.

User interface

One of the most important control considerations for implementing ceiling fans is how the occupants will control the fans. Typical user interface options are listed below. Note that it is common for ceiling fan installations to combine several of the control types listed below in a single application.

Pull chain: adjust a fan’s speed or light level by pull chain located on the fan. Typically, each fan will have two chains, one for the light, and one to turn the fan on or off and adjust the fan speed, typically through just 3 speed levels. Typically, only used in residential applications.

Wired wall control: slide controls or knobs on the wall connecting to wiring in order to control fan speed and light levels. Wall controls may be preferable for fans with greater fan speed variability or dimmable lighting.

Wireless IR remote control or detachable wall control: wall control or remotes tuned to create a frequency combination enabling wireless control of fan speed and light levels. Like wired wall controls, wireless controls can support greater fan speed variability and dimmable lighting. Wireless controls eliminate the need for hardwired connections, which can be costly in retrofit scenarios, but they also typically use batteries that will need to be replaced regularly, and if detachable, they can be lost or misplaced.

Wi-Fi or Bluetooth Connectivity via Phone App or Internet: some fans have smartphone apps or web interfaces that use Bluetooth or Wi-Fi networks to control fan speed, light levels, and other settings. This may be especially advantageous for controlling multiple fans in a space or throughout a building but may be less ideal for spaces where multiple people will need access to fan controls. Additionally, note that many fan models can be retrofitted with a controller that adds Wi-Fi or Bluetooth control capabilities.

Building automation system interface: some fans may also be controlled through building automation system interface. This approach may be ideal for applications where access to fan control needs to be limited to building management and maintenance staff, such as assembly and hospitality spaces.



Figure 20. Inappropriate examples of ceiling fan wall controls (Images courtesy Elaina Present).

Figure 20 demonstrates some examples of wall mounted control for ceiling fan that are not particularly clear to the user. For example, the controls are not labelled as controlling the ceiling fan and as such are indistinguishable from a dimmable light switch in many cases. It is important to ensure that wall mounted fan controls are clearly visible to the occupant(s), located near the fan they control and near the thermostat in the room, intuitive (e.g., levels increase vertically from off to maximum speed), and clearly differentiated from other controls, like lighting controls.

Types of control automation

In addition to the user control interfaces listed above, there are a range of options and strategies for ceiling fan control automation. Listed below are some automation strategies that can be implemented for ceiling fans. As with control interfaces, many of these automation strategies can be used in combination. However, the automation options available for any given application will sometimes depend on the capabilities of the chosen ceiling fan model.

The simplest is the manual control option, where there is no automation and fan control is fully manual based on occupant inputs. The schedule option allows to set when the fans are operating, typically at a fixed speed. For example, if a room is generally only used during weekday business hours, a schedule could be set to automatically turn on each weekday morning and turn off at night. Automation based on occupancy option ensures that a fan only operates when the space is occupied. The fans only provide a cooling sensation if an occupant is there to feel it. This control option can be applied in different ways: by a wall switch “vacancy” or “occupancy” sensing; by integration with building automation system (BAS) occupancy sensors (e.g., via power relay, 0-10 V input or BACnet interface to fan); or on-board occupancy sensor (available in some products). Another option is temperature sensing, which allows fans to be programmed to turn on at certain temperature thresholds, and increase speed with temperature, automating the thermal comfort control in a similar manner to a thermostat for a traditional HVAC system. This option can be applied when manufacturer provided wall controller with built in temperature sensor (or remote temperature probe); by integration with building automation system (BAS) occupancy sensors (e.g., via power relay, 0-10 V input or BACnet interface to fan); or on-board occupancy sensor (available in some products). Learning behaviors and/or preference controls can also be used when ceiling fans are equipped with programming that learns user preferences over time. For example, if a user frequently turns off the fan when the room temperature drops to 23 °C [73 °F] the fan will “learn” this user preference and start to automatically turn off at that temperature.

Additional considerations for choosing a control type

There is amperage restriction to a wall control unit which limits the number of ceiling fans that can be controlled together at once. For example, a wall control unit with an amperage of 5 amps could only control at most 5 fans at once if the load of one fan is about 1 A. In general, the number of fans that may be in a space at once is limited by the National Electric Code standards. The standard mandates that a circuit breaker does not carry more than 80% of its rated current. This means that for a standard circuit breaker with 15-20 A, the circuit breaker will only allow about 12 fans (80 % of 15). To allow for more fans to be controlled at once, fans are often daisy-chained together. When fans are daisy-chained, a control device controls one master fan, and the rest of the fans are controlled by the master fan by a variable-frequency drive.

When using wireless wall controls or remote controls, each fan that is controlled must have a receiver. Additionally, for each new fan desired to be controlled simultaneously with the existing fans, a new receiver must be purchased. The frequency settings must then be reset for the receiver and remote control to match.

Ceiling fan costs

Like many building products, ceiling fan costs can vary widely depending on size, material, motor type, and other characteristics. Standard ceiling fans can range from less than US\$100 for basic off-the-shelf models to over US\$1,000 for more specialized fans with more decorative features, higher quality materials, and/or automated onboard control systems. In general, fans with DC motors tend to be more expensive than fans with AC motors, but DC motors also tend to be more energy efficient, quieter, and more durable than AC motor fans due to better bearings and build quality. A wide range of high quality, efficient standard fans with DC motors are currently available from US\$400 upwards. Large-diameter ceiling fans start at approximately US\$3,000 and increase in cost with fan diameter and performance characteristics. There is relatively little difference in performance between DC and AC motors for the larger motor sizes associated with large-diameter fans.

Installation costs can vary widely depending on the fan (assembly time, weight and diameter), the space conditions, and whether the installation is a new construction or a retrofit. Very approximately, it can take a professional anywhere from 30 minutes to 3 hours to assemble and install a single ceiling fan depending on the selected model and site conditions. On the low end of that estimate, the time required to install a ceiling fan is simply the labor cost to assemble the ceiling fan and connect it to an existing junction box. On the other hand, a variety of factors can make ceiling fan installations more complicated, and therefore more expensive. The need for additional structural bracing in spaces with suspended ceilings, the need for additional people to handle and install larger fan models, running new wiring for power and controls in retrofit scenarios, and the need for mechanical lifts for installations in spaces with high ceilings are just a few of the factors that can add complication and cost for ceiling fan installations. In retrofit scenarios, if there is already an electrical box in place, installation costs may be minimal, but if new wiring and junction boxes are needed, the installation is likely to be more complicated and more costly. The variations in installation costs also consider external factors beyond the fan installation, such as long travel times to the demonstration sites (several hours each way), and the size and efficiencies of each of the installation projects (e.g., larger jobs had lower average per fan costs since external factors are averaged over a larger number of fans).

Other fan types

Besides ceiling fans, what are the other fan types available in the market and their main features for you to consider?

While the benefits of elevated air movement by ceiling fans are acknowledged, places with lower floor-to-ceiling height or a ceiling with compacted fixtures could be limited for ceiling fan installation. This limitation can be mitigated by using other air movement devices.

Fan types

Various air movement devices are available in the market, but no standard classification protocol defines them. Based on the function and location of usage, this guide discusses five major types of air movement devices: desk fans (bladed and bladeless), pedestal/tower fans, wall-mounted fans, bladeless ceiling fans and air circulators.

Desk fans

The term 'desk fan' generally describes a fan that is portable with a size small enough to place on the desk or table within reach of an occupant. It can be subdivided into bladed and bladeless fans. Desk fans with blades available in the market generally have a diameter between 7 to 35 cm [3 to 14 in], like the one shown in Figure 21a. Desk fans with a smaller diameter than this range would also be beneficial when working close to the user (< 0.5 m). Meanwhile, a larger fan would be too bulky to place on the desk. In addition, some desk fans are attached with a clip-on base, which allows users to clip the fan on the partition or the edge of their desk (see Figure 21b).

To ensure safety when the fan is in operation, the fan's blades are enclosed inside a resistant plastic or metal mesh. Usually, some small fans with low power (<5 W) do not need an enclosure as the risks are minimized. Further, there are fans with no blades in the market to enhance safety and an aesthetical outlook. Figure 21c shows an example of a bladeless fan. Although it looks and operates "bladeless," these fans have blades operating inside the fan body. The inner blades with the motor draw air in at the bottom and push air up into the ring portion of the fan to create the air stream. The size of the ring portion varies by fan product and is not necessarily circular in shape. In general, bladeless fans operate at a louder noise and require more energy to move the same volume of air when compared to their axial counterparts.

Pedestal fans / Tower fan

Pedestal fans, also known as standing fans, are quite similar to desk fans but with the fan head mounted to a height-adjustable pedestal, elevating the fan to about 0.6 to 1.2 m [2-4 ft] from the ground. The fan operates on a tall stand to enhance air circulation (avoid obstacles on the floor) in larger rooms, and its ability to oscillate left and right delivers air to a broader area. Figure 21d shows an example of a pedestal fan. Although pedestal fans are meant to be portable, they usually come with a heavy base to maintain stability when operating, which is less portable when compared to desk fans. This heavy base allows larger fan size operates on top, i.e., provides more airflow, with market-available blade diameter ranging from 30 to 76 cm [12 to 30 in]. The number of blades for a pedestal fan usually ranges from 3 to 5, with some special models up to 9 blades.

Another common type of fan used on the floor is the tower fan. Unlike axial fans (draw and deliver air along the fan axis), a tower fan is a crossflow variety (draw and deliver air perpendicular to the impeller fan axis). A crossflow fan pulls air from the inlet into a cylindrical impeller vane housed inside the tall and slim fan structure by setting up a cylindrical vortex of spinning air. The vortex then swings the air to the opposite side of the impeller blades and pushes the air out alongside the rectification plate (i.e., the outlet duct). The enclosed impeller blade design maximizes safety for residential usage, especially with kids and pets around. The tower-like structure is fixed on a base and rotates horizontally to extend the air movement sweeping area. The tower fans are compact and lightweight and fit well for any indoor space, serving personal cooling and air circulation. The airflow produced by the tower fan is usually laminar and uniform along the tower. Figure 21e shows an example of a tower fan.

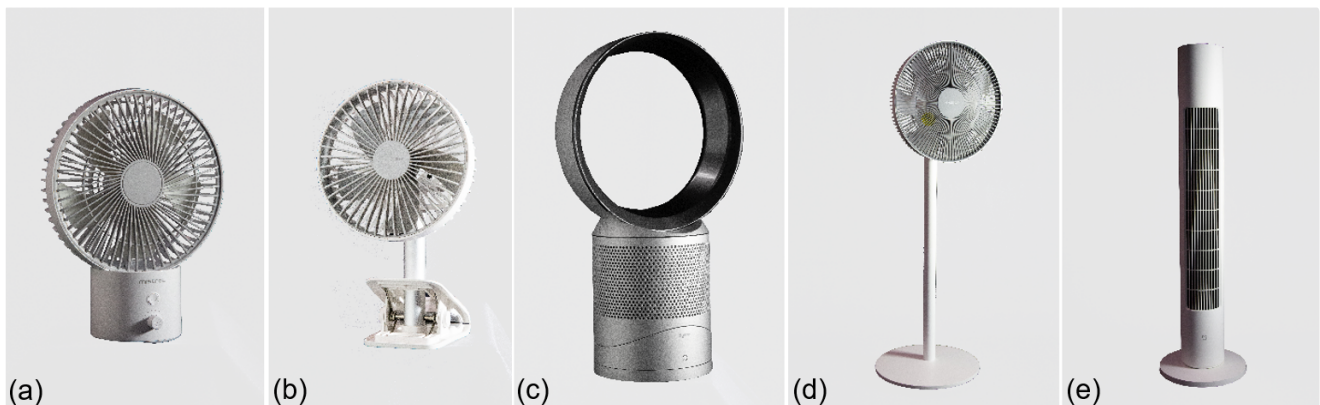

Figure 21. Examples of other air movement devices: (a) desk fan, (b) clip-on fan, (c) bladeless fan, (d) pedestal fan, and (e) tower fan.

Wall-mounted fans

A wall-mounted fan is a pedestal fan without a base mounted on the wall. Sometimes these fans may also mount to the ceiling. Yet, different from conventional ceiling fans, these “ceiling mounted” fans can oscillate at 180 °. It is a good choice to provide a breeze over the human body and enhance room air circulation when the space and floor-to-ceiling height are limited. Figure 22 shows some examples of wall-mounted fans.



Figure 22. Examples of wall mounted fans.

Bladeless ceiling fan

A bladeless ceiling fan operates as a centrifugal fan, unlike the conventional ceiling fan which uses an axial fan. In theory, a bladeless ceiling fan is not bladeless but a special design with many small blades installed at the fan's circumference structure. The fan rotates the entire design structure, which draws air under the fan and hurls it out at the side from 360°. These fans are intended to enhance air movement and air circulation within a small space, such as a living room or bedroom. Figure 23 demonstrates some examples of bladeless ceiling fans. They are less common than other fan types. The installation requirement is similar to a ceiling fan with blades, but the bladeless ceiling fans do not require a minimum mounting height to prevent “air choking”, which means they are suitable to be installed in a space with low floor-to-ceiling height.



Figure 23. Examples of bladeless ceiling fans.

Air circulator

Air circulators aim to provide a high-velocity air jet to circulate air and keep air moving continuously in the room. The strong air movement is not intended to be blown directly toward the human body but to initiate air circulation. Depending on the brand, the air circulator diameter range is between 23-40 cm [9-16 in]. Such fans are ideal for air circulation in small rooms, such as bedrooms and enclosed offices. An extra-large air circulator about 50 to 76 cm [20-30 in] in diameter, also known as the drum blower, with durable metal construction, can deliver extra high-velocity airflow. These heavy-duty air circulators are ideal for warehouses, industrial workshops and loading docks. Figure 24 illustrates some examples of air circulators.



Figure 24. Examples of air circulators.

Fan selection considerations

Typical functions

The above-mentioned air movement devices have two major functions: (1) move air directly towards the human body and (2) room air circulation. Moving air towards the human body aims to cool the subject using convective heat loss, while air circulation aims to keep air in motion within the enclosed space to enhance air and temperature mixing. Generally, a smaller fan that generates less airflow (i.e., desk fan) is more suitable for direct cooling towards the human body, while a larger fan and fan that generates stronger airflow (i.e., bladeless ceiling fan, air circulator) are designed for air circulation. Nevertheless, most of the fan types can deliver both functions by adjusting the fan speed. Therefore, fan selection should be based on the intent, whether it is an individual adjustment for personal cooling (group 1) or simultaneously producing a general air movement effect for multiple occupants' usage. Table 2 summarizes the typical function, location of application, and approximate price range for different elevated air movement devices.

Table 2. Summary of other air movement device's function and approximate price range.

Fan Type	Typical function	Application location	Price range (USD)
Desk fan	Air movement towards human body	Workstation, bedroom, study room	\$ 10 - \$ 300
Pedestal fan	Air movement towards human body / Room air circulation	Open plan office, residence	\$ 40 - \$ 400
Tower fan	Air movement towards human body / Room air circulation	Bedroom, personal office, small room	\$ 40 - \$ 450
Wall mounted fan	Air movement towards human body / Room air circulation	Residence, waiting room, restaurant, school, warehouse	\$ 50 - \$ 300
Bladeless ceiling fan	Room air circulation	Residence, office	\$ 500 - \$ 1000
Air circulator	Room air circulation	Warehouse, residence, open plan office	\$ 50 - \$ 300
Conventional ceiling fan (with blades)	Air movement towards human body / Room air circulation	Any indoor / semi-indoor space with sufficient mounting height	\$ 200 - \$ 1000

Noise levels

Noise from a fan can initiate dissatisfaction and unwillingness of usage from occupants. The noise sources of a fan are mainly from the operating motor and the fast movements of the blades (i.e., turbulence). The sound level of domestic fans ranges from 30 to 70 dBA depending on the fan types (e.g., desk, pedestal, ceiling), fan models and speed. Table 3 suggests the noise level for some corresponding features for comparison. The noise level from an axial fan, initiated by turbulence, increases with the blades' rotational speed. Therefore, higher speeds usually correspond to higher noise levels. While for the cross-flow fan, the air output is generally laminar with lower air speed (i.e., lower blade rotational speed); thus, the noise being generated is also relatively lower.

Nevertheless, the noise cannot be characterized only by sound level; its frequency distribution is also important. Low-frequency noise is identified to be annoying in dwellings, and this kind of noise is associated with appliances such as fans. Sometimes, a louder noise with uniform frequencies might be less annoying than a lower sound level that peaks at specific frequencies. Furthermore, the fan design also plays an important part in defining a fan's sound level and frequencies. Thus, concluding that one fan type will always be quieter than another is not practical. Users are encouraged to experience fan usage before purchasing.

Table 3. Noise level by comparison.

	Sound level (dBA)	Corresponding feature
No health hazards	10	Mosquito buzzing, PC running
No health hazards	20	Clock ticking, leaves rustling
No health hazards	30	Whispering, breathing sound
No health hazards	35	General indoor fan (depends on fan size, speed, and model)
Concentrating becomes problematic	40	Street noise with double insulation
Concentrating becomes problematic	50	Refrigerator in 1m distance, gentle rain
Concentrating becomes problematic	60	Conversations, frogs croaking
Concentrating becomes problematic	70	Normal traffic
Concentrating becomes problematic	80	Motor bike engine
		Over 80dBA health is threatened with exposure over 40h/week

Power and efficiency

Most elevated air movement devices described above are powered by the electric grid. The electricity powers up the motor and spins the blades like the ceiling fan. Most of these air movement devices are not fixed in position, which can plug in any power socket outlet near the desired operation area. Some small fans can be powered by rechargeable lithium-ion batteries, meaning that the fan is cableless to enhance additional flexibility when operating. Some small desk fans with diameters between 7 -15 cm [3-7 in] can be powered by a USB plug linked to a computer.

In general, efficiency is the ratio of the output to the input. For fans, the Cooling fan efficiency (CFE) index (Schiavon & Melikov, 2008) used to evaluate the cooling performance is defined as the ratio between the cooling effect of the device and its power consumption. The following equation represents the calculation of the CFE index, where P_f = the input power of the fan (in W) and Δt_{eq} = the whole-body cooling effect (in °C or °F).

$$CFE = \frac{\text{Cooling Effect}}{\text{Fan Power}} = (-1) \frac{\Delta t_{eq}}{P_f}$$

Due to different designs and usage, the performance of cooling fans (e.g., ceiling fan, desk fan, tower fan) with regards to their cooling effect and cooling efficiency can be varied. Figure 25 demonstrates the test results on some ceiling fans, desk fans, tower fans, and standing fans to depict their relationship between CFE and fan power. The desk fan tested in this study consumed the least power (16 – 20 W) and obtained the highest cooling fan efficiency (0.095-0.177 °C/W [0.17-0.31 °F/W]). The results are interpreted upon normal condition usage of fans, meaning that the desk fan is smaller in size (i.e., smaller motor) and the fan operation distance is closer to the human subject (maximize cooling effect) when compared with other fan types. Indeed, desk fans are designed to provide local cooling by generating airflow towards the human body instead of circulating air for the entire space (like the other fans do). Eventually, the intent of fan usage (local cooling vs. air circulation) should have been taken into consideration when quantifying the fan effectiveness. While the efficiency of the fan itself is somewhat important, any fan's electricity consumption (even not the most efficient type) is always relatively low when compared to using just air-conditioning to provide thermally comfortable conditions to humans. More details are discussed in the section "Potential savings" in this guide.

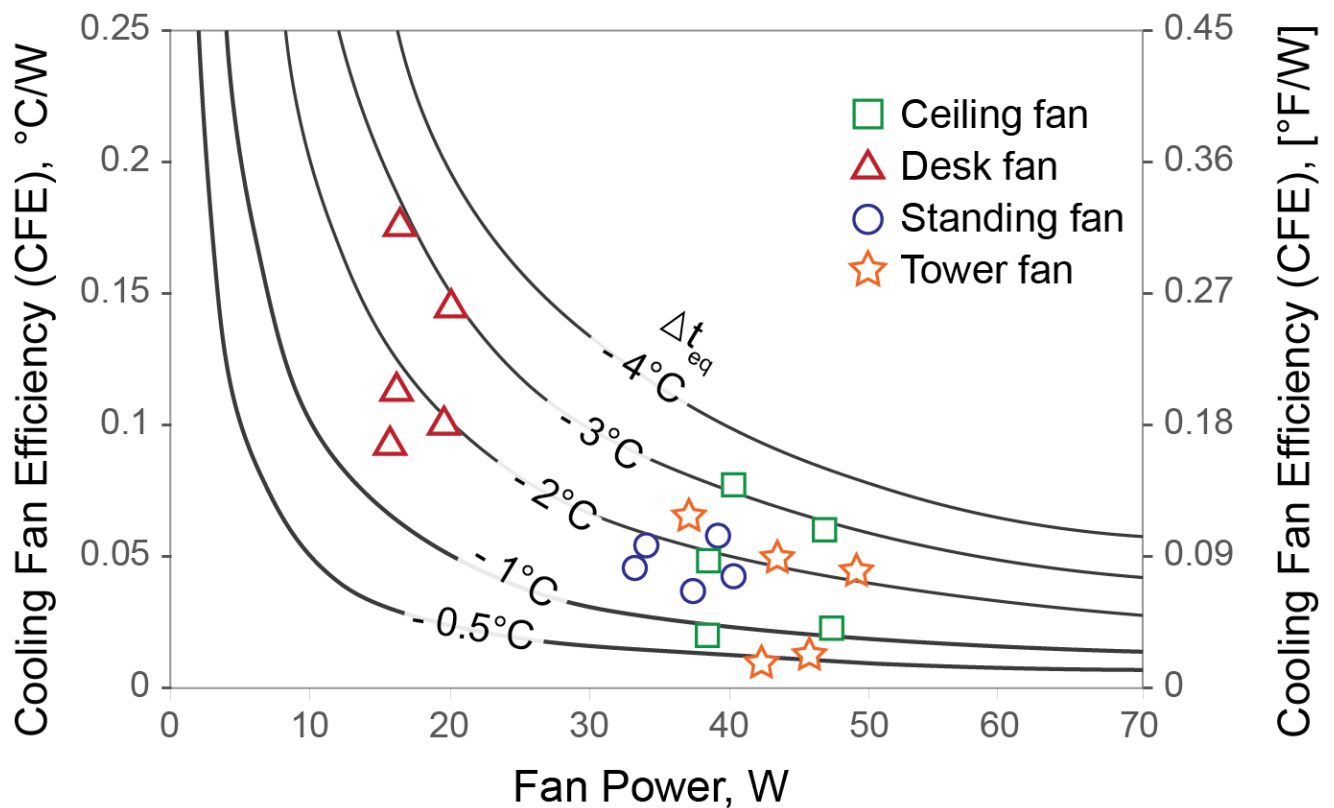

Figure 25. CFE index versus fan power for the ceiling fan (CF), desk fan (DF) standing fan (SF) and tower fan (TF). Lines with constant whole-body cooling effect (Δt_{eq}) are plotted.

Motor and drive

All the elevated air movement devices described above, with or without blades, consist of a rotary part driven by motor and drive. The types of motor and drive used for these elevated air movement devices are similar to those that operate in a ceiling fan, which we have discussed in the former section. It is worth noting that a larger energy-saving potential can be achieved using a DC motor instead of an AC motor, especially for small fans like desk fans or pedestal fans.

Air Speed / Airflow pattern

Performance of air speed from different devices can be varied by fan size, blade types, and fan structure. For axial fans, estimation of air speed is similar to ceiling fan (i.e., dividing the rated airflow of the fan by its diameter). However, such estimation is not applied to bladeless fans and tower fans which have a different airflow driven mechanism.

There is no existing requirement or standard on typical air speed for the air movement devices described above. Air speed and airflow requirement is more critical to the application than place of usage. We will discuss the air speed and airflow requirements based on the usage of (i) direct cooling towards human body, and (ii) room air circulation.

Direct cooling towards human body: When choosing an air movement device, customers tend to select a stronger fan which can produce more airflow and faster air speed. While it is true that bigger and stronger fans can provide better cooling effect, the question is do we really need that much air movement if the fan is intended to operate close to us? The fact is, sometimes we may experience too strong air movement from a nearby fan blowing toward our body, even though it is working at the lowest available fan speed. Figure 26a shows the environment is thermally comfortable if the surrounding air speed is 0.5 m/s [98 fpm]. A cooling effect of 2.8 °C [5 °F] means that, with current thermal condition, the subject is actually feeling 2.8 °C [5 °F] lower than the actual temperature (equivalent to 23.2 °C [73.8 °F]). If the fan is placed closer to the occupant, or the air speed is increased to 0.8 m/s [157 fpm]. Keeping other thermal parameters unchanged, Figure 26b suggests a cooling effect of 3.5 °C [6.3 °F], where the occupant became slightly cool and outside the thermal comfort zone. This example demonstrates that choosing a fan with possible lower airflow turndown (minimum speed divided by maximum speed) capability could be the key for better comfort in terms of direct convective cooling. Figure 27 illustrates the airflow examples for desk fan, pedestal fan, tower fan, and wall mounted. The oscillating function of these fans helps to deliver air movement at a wider coverage range and to minimize the risk of unwanted draft from long term spot cooling.

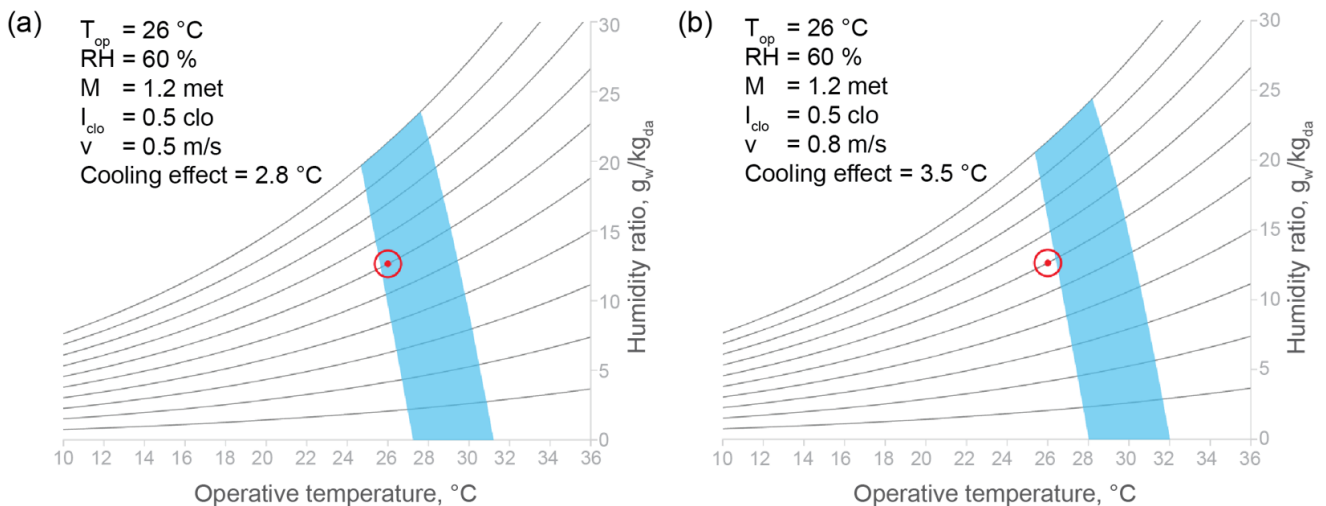

Figure 26. Demonstration of thermal comfort condition and corresponding cooling effect.

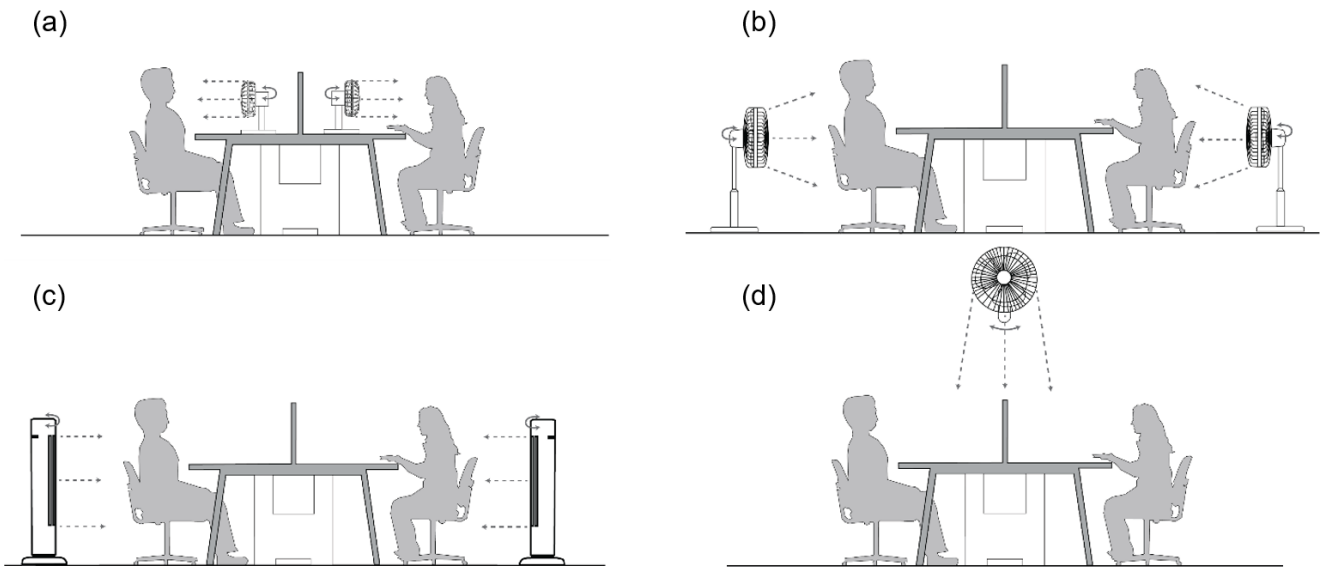

Figure 27. Illustration of airflow patterns for (a) desk fan, (b) pedestal fan, (c) tower fan, and (d) wall-mounted fan.

Room air circulation: An air movement device that aims to circulate the air within a room is either bigger in size (i.e., ceiling fan, bladeless ceiling fan) or able to generate high airflow jet with high speed (i.e., air circulator) to drive the air movement.

The airflow pattern of bladeless ceiling fan is quite similar to a reversely operated ceiling fan, but it applies the centrifugal technique to draw the air from the bottom to the center of the fan then throw it out perpendicularly at the side from 360°. Figure 28 shows a schematic on how air is driven by a bladeless ceiling fan. The goals for such air movement strategy are (i) to elevate the average air speed in the occupied zone and (ii) to mix the air in the space minimizing stratification. It is worth noting that this system works best with close loop airflow within a small to medium size enclosed room (e.g., enclosed office, residential). Since there is no direct air jet blowing towards the occupants, the air speed in occupied zone will be too low if there is no air reflected from surrounding walls. To minimize this problem, some bladeless ceiling fans have modified the fan body design, which is able to guide the airflow slightly downward (i.e., less than 90° flow) towards the occupied zone.

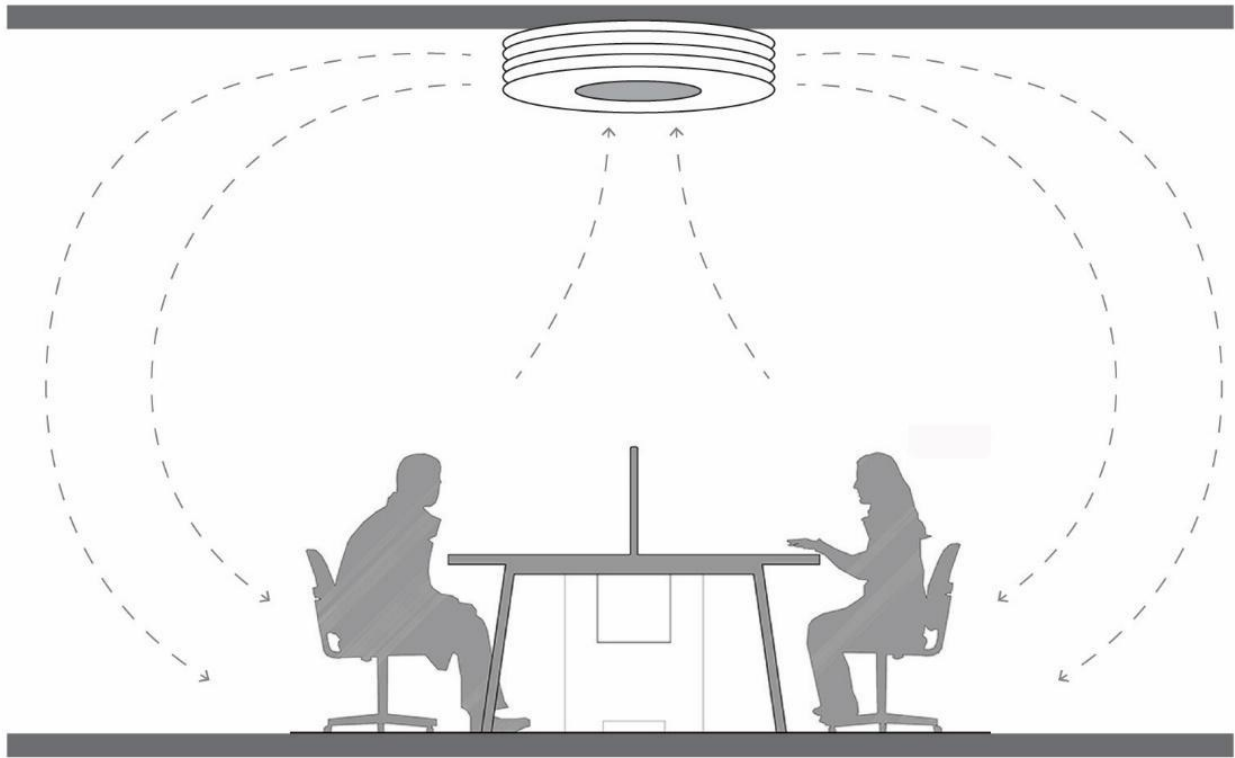

Figure 28. Schematic of airflow pattern driven by bladeless ceiling fan.

An air circulator intends to produce a high-speed strong air jet to move air from one side of the room to the other. Figure 29 presents a schematic representation of the airflow pattern for an air circulator in an enclosed room. Similarly, this strategy aims to move the air to increase the average air speed and to enhance air mixing in space. Thus, the air circulation effectiveness also works better in small to medium size rooms. Different from the bladeless ceiling fan approach, however, air jet from the air circulator is freely adjustable within the occupied zone. Basically, the air circulator can reduce the fan speed, temporarily act as a desk fan, or pedestal fan blowing air directly towards human body for immediate cooling. In addition, to enhance long distance air movement, some air circulator's fan blades are modified to a propeller (or turbine) type. Instead of moving air parallel to the fan axial, it drives the air in form of a vortex which propagates along the fan axial. This feature helps to centralize the airflow across longer distance and to drag surrounding air towards the propagation of air stream to maximize the airflow rate. The air movement distance from an air circulator is much longer when compared with normal desk or pedestal fan with a flat blade.

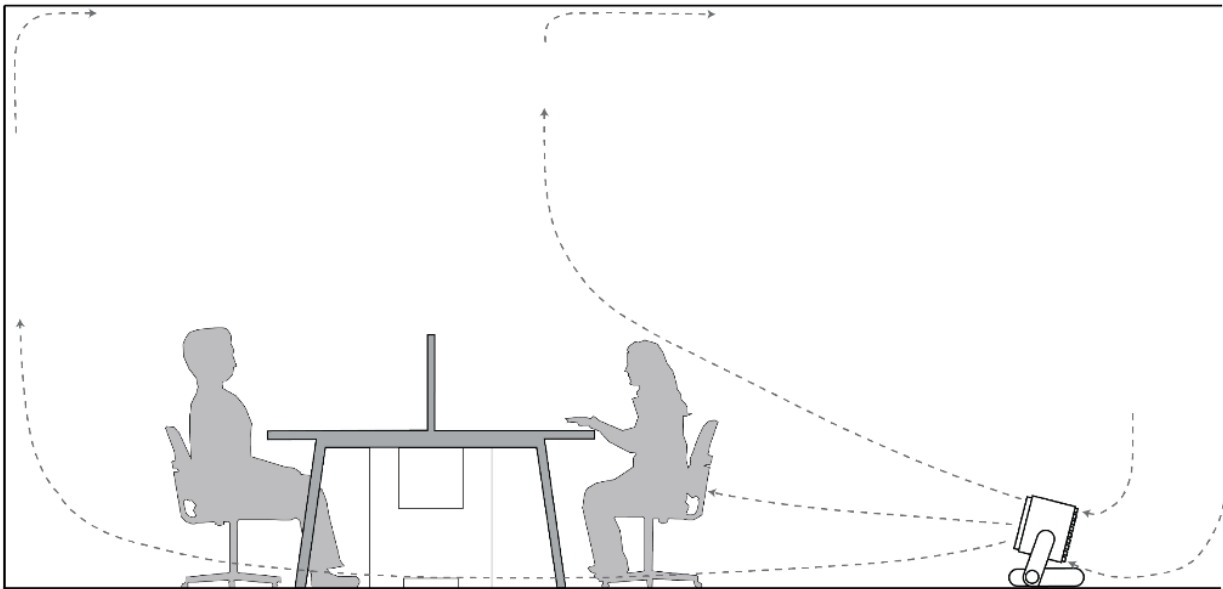

Figure 29. Schematic of airflow pattern driven by air circulator.

Flexibility

One major advantage of the above listed elevated air movement devices over ceiling fan is the high flexibility of usage in terms of location, operation height, flow direction and oscillation. Such flexibility enhances adjustment to occupant's needs and comfort demand regarding elevated air speed under different circumstances. Except the wall mounted fans and bladeless ceiling fans, all other fan types listed in Table 2 are flexible to be relocated based on the occupant's needs: on the desk or floor, directed to or away from the occupants, and any places that can move air to the desire direction. Fan operation height of pedestal fans are adjustable, usually about 0.6-1.2 m [2-4 ft] from ground (depending on brand and type), while some other fan types, such as desk fan and air circulator, can adjust the air stream shooting height by tilting the fan head at certain vertical angles.

Most of the fan types listed in Table 2 can oscillate horizontally in a range of 60 ° to 160 °. Some modern fan types can also oscillate vertically. Horizontal or vertical oscillation of fan allows the air movement to cover wider area within the space and to serve multiple occupants at the same time. In addition, the fan oscillation function could minimize the stale air areas by moving the air from different directions, even behind some obstacles such as furniture or partitions, which enhances effectiveness of air mixing. It is one of the major benefits of ceiling fans usage in space. Portable fans can be operated in different rooms in the same space (i.e., one fan serves multiple rooms).

Other features

Some fans are equipped with technologies that enable them with special features. Some tower fans and bladeless fans are equipped with multiple filters, contributing to air purification. Particulate matter and sometimes gases in the air can be filtered out and cleaner air will be circulated within the space. Different types of filters can remove various kinds of contaminant. Some special fan models are installed with UV-C (i.e., germicidal UV) light inside the fan framework to disinfect the air during circulation process. UV-C is effective at deactivating viruses, bacteria, mold, and fungus. Some fan models can emit water mist that moves along with the air stream to reduce its temperature thanks to the adiabatic cooling (evaporative cooling) process. Figure 30 presents an example of a pedestal fan with evaporative cooling function.



Figure 30. Pedestal fan with evaporative cooling.

Controls

Compared with ceiling fan, other fan types listed in Table 2 are mostly portable, except for wall mounted and bladeless ceiling fans, and manually operated.

Control panel on fan body: Most portable fans are equipped with a control panel on the fan body (See Figure 31a). It shows a simple On / Off plus fan speed control button, and a rotary switch connected with the watch spring to provide basic timer control (i.e., after how long the fan will be switched off automatically). Wireless IR remote control: Many modern fan types can be wirelessly controlled by an IR remote. Figure 31b shows an example of the remote control. Basically, it can adjust the on / off switch, fan speeds, vertical or horizontal oscillation, and set timer. Some remote controls may even be able to control other special functions if the corresponding fan has corresponding features, such as lighting switch. Wi-Fi or Bluetooth control via phone App or Internet: Wireless control via phone App or internet is very similar to the IR remote control approach but uses a smart phone instead of a remote control. Figure 31c presents an example of Wi-Fi connection via smart phone.

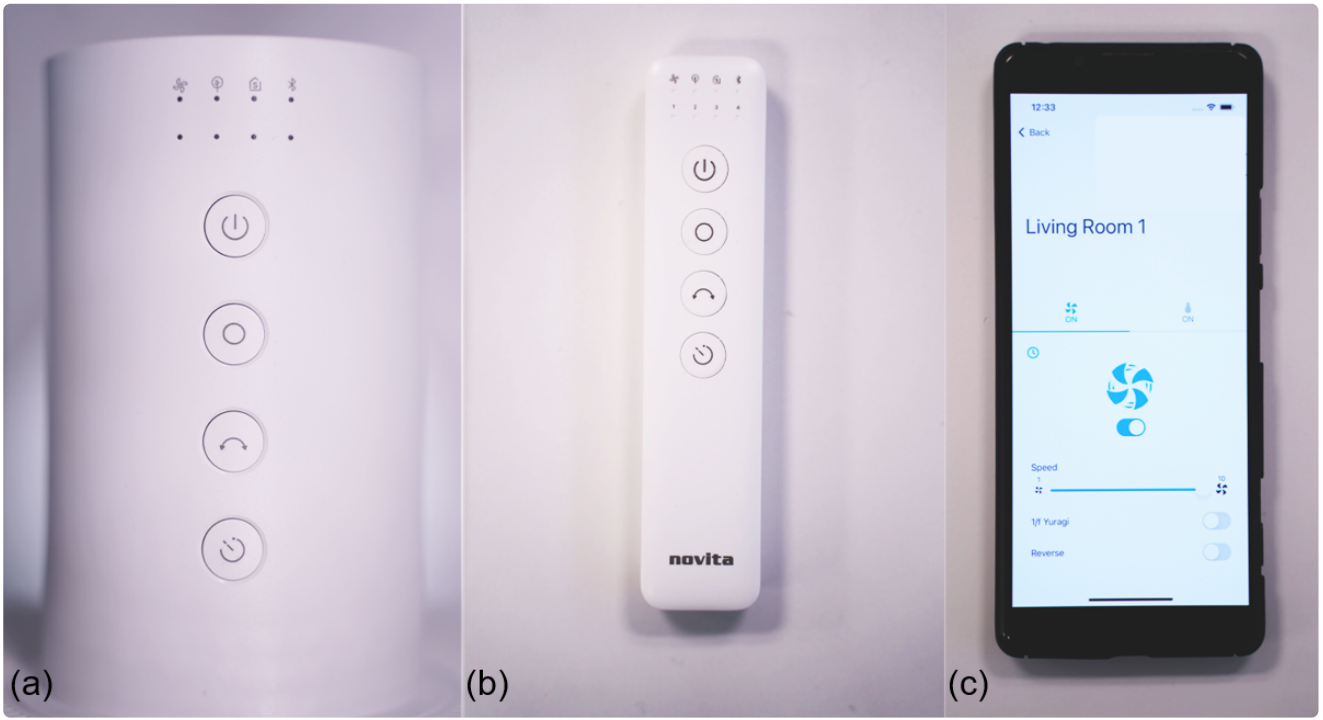

Figure 31. Manual fan control method. (a) Control panel on fan body, (b) IR wireless remote control, (c) Wi-Fi control via smart phone.

Design goals and fan selection

Which are the relevant air movement goals for your design and how to select fans that meets those goals?

Fans are effective for comfort cooling and air circulation. However, fan applications are highly dependent on the design intent for desired air speed and distribution, and any physical environment limitations. Understanding the elevated air movement design intent is the prerequisite in selecting an adequate fan type for a particular space.

Design intents for air speed and distribution

Figure 32 outlines the key considerations for defining the fan design intents. These design intents are divided into four types, namely personal control, targeted, variability, and uniformity. Table 4 outlines the description of fan applications in each design intent category. The table also provides example application types, example target air speeds, and additional considerations for each design intent approach. For any of the described design intent, the ideal condition should include the automation of fan with the possibility of user override. This would allow, ideally, for fans to be activated automatically according to room occupancy and indoor temperature conditions, but maintain occupants control, allowing them to make temporary changes to fit their needs.

Even under identical environmental conditions, occupant comfort needs vary significantly based on individual preference and expectation, clothing levels, and metabolic rates. "Personal control" design emphasizes the goal of fan system to provide thermal comfort for a single occupant, while the adjustment of fans is unlikely affecting other occupants. In such a case, the design intent of air speed and distribution are not particularly relevant, as the subject has full control of the fan speed, airflow direction (i.e., relocate a desk fan position), and operation schedule according to their own needs. One example would be a private office where the single occupant has control over the fan and another one would be an open plan office where every occupant has a small desk fan (see classification of control levels in the "[ASHRAE Standard 55 \(2020\)](#)" section).

In general, design intent of "Variability" has its advantage at multi-occupant space where occupants have flexibility to adjust fans operation based on their desired thermal comfort needs, or they are free to move around and choose their preferable locations or thermal conditions. In many cases the variability in air speeds created by a fan can help improve overall occupant comfort. For example, a manually adjustable ceiling fan that serves multiple persons within the space for different thermal needs (e.g., adjusts higher fan speed for transient period, but lower speed at steady condition). Another example is in spaces where occupants can easily move around, such as a lobby, gymnasium or cafeteria, variability is likely beneficial as the comfort needs of different occupants can be met by choosing their location in the space.

In spaces where there are variable or transient occupancies, non-uniform thermal conditions, or spaces with specific thermal requirements due to architectural features or activity levels, “Targeted” air movement may provide more comfort. For example, the thermal comfort impact of increased solar radiation near a poorly shaded, highly glazed façade could be offset by locating ceiling fans near the façade, but the areas further from the façade might not need any or fewer ceiling fans. Other examples could be to locate ceiling fans over a dance floor area instead of the audience or directing air circulators to the exercise area in a gym and not directed to the front desk.

Design intent of “Uniformity” (i.e., more regular control) emphasizes uniform air speeds and consistent thermal comfort experience applied in multi-occupant spaces where occupants do not have flexibility to control fan or change their location, especially when occupants will be staying in those areas for extended periods. Uniform air speed and distribution are applied because there is no way of guaranteeing that the person who feels the warmest happens to be the one who is located where the air speeds are highest in the room. Examples here include a shared office with fixed assigned seats, classrooms, and allocated seating dining areas.

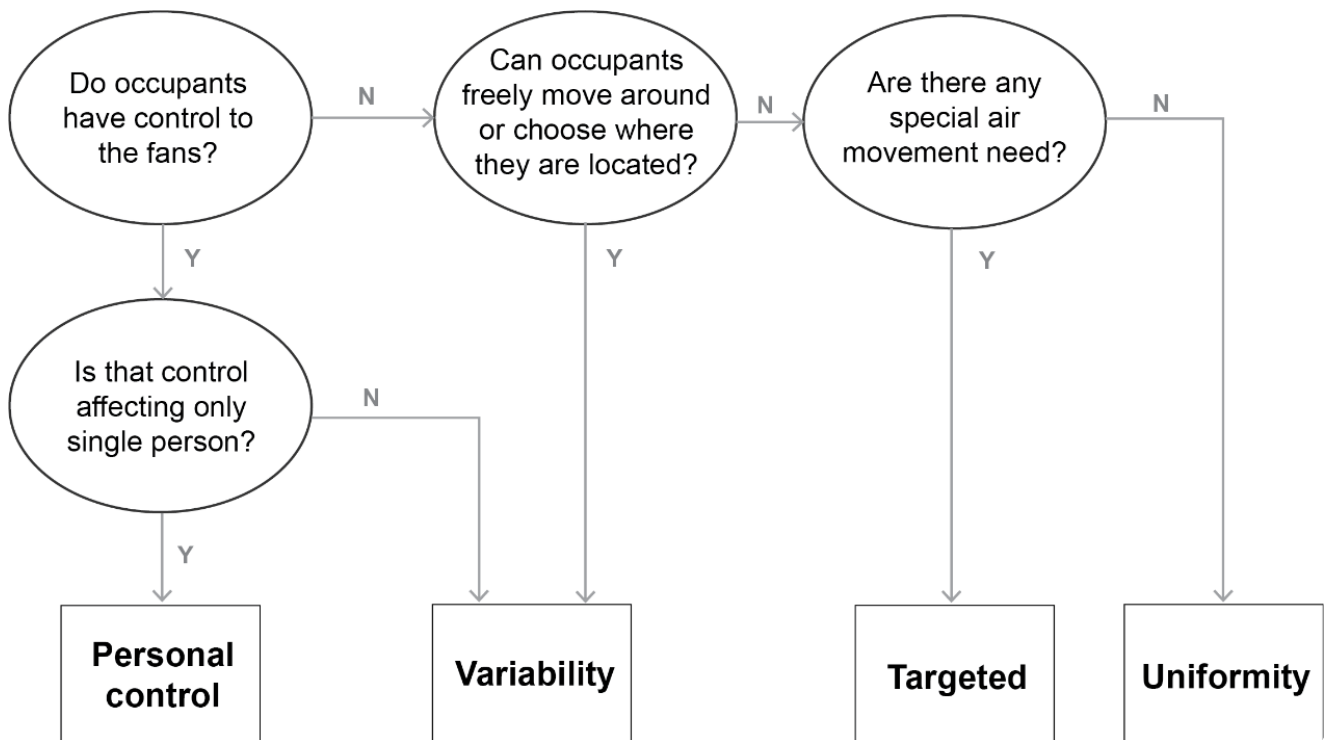

Figure 32. Flow chart of design intent for air speed and distribution.

Table 4. Recommended guidelines classified by design intent for fan applications.

Design Intent	Application Examples	Target Maximum Air Speed	Comments
<p>Personal control: Provide cooling directly to the occupant, taking into consideration furniture configuration / space layout, locate fan directly close to occupant and above occupant in case of ceiling fan, where possible.</p>	<ul style="list-style-type: none"> • Office – Private • Residential 	<p>High to very high</p>	<ul style="list-style-type: none"> • Provide local manual control. • Ensure fan can down to a low fan air speed. • If Ceiling fan is chosen, the locations should consider potential/planned furniture location
<p>Variability: For spaces where occupants have the flexibility to move around the space and choose their preferred conditions, allow variable air speed conditions within the space, up to medium air speeds. Uniformity is a lower priority.</p>	<ul style="list-style-type: none"> • Assembly / Event Spaces – Flexible • Cafeterias • Gymnasium / Exercise Areas • Offices – Shared, Hoteling / Unassigned 	<p>Medium</p>	<ul style="list-style-type: none"> • For office space ensure maximum design air speed will not blow papers around.
<p>Targeted: For spaces with inconsistent or transient occupancies, non-uniform thermal conditions, and/or spaces with specific thermal requirements, target fan to where they are most needed. Consider providing different air speed conditions for different occupant types. For example, permanent occupants in a space (e.g., receptionists in a lobby) may have</p>	<ul style="list-style-type: none"> • Assembly / Event Spaces – Transitional • Lobbies • Agricultural / Livestock • Industrial Production / Manufacturing • Kitchens 	<ul style="list-style-type: none"> • Low to high; depending on application and occupancy. 	<ul style="list-style-type: none"> • Allow flexibility to ensure lower air speeds for any permanent occupants in the space (receptionists, e • Maximum target speeds to high metabolic rate occupants or on higher heat gain other source of higher cooling demand

<p>different thermal comfort requirements than temporary occupants who are passing through the space. Similarly, fans can be used to address inconsistent thermal conditions in a space, such as areas of high solar heat gain near windows, or areas where occupants can be expected to have notably different metabolic rates.</p>	<ul style="list-style-type: none"> • (commercial) Outdoor • Gymnasium / Exercise Areas – directly over areas or equipment where occupants likely will have high metabolic rates 	<p>Target may vary throughout the space</p>	<ul style="list-style-type: none"> • Maximum target speeds in agricultural, industrial, and warehouse applications will depend on whether the space has other mechanical cooling (unconditioned spaces may require higher maximum air speeds).
<p>Uniformity: For multi-occupant spaces where locations are fixed or inflexible, maximize uniformity and coverage at relatively low air speeds throughout the occupied subzones of the space to ensure consistent experience for all occupants.</p>	<ul style="list-style-type: none"> • Assembly / Event Spaces – Fixed • Classrooms and conference rooms • Dining Areas • Offices – Shared, Assigned Seating • Retail 	<p>Low to medium</p>	<ul style="list-style-type: none"> • Prioritize uniform coverage to provide consistent conditions throughout the occupied subzone of the space. • For offices and classroom spaces ensure maximum design air speed will not blow papers off desks (approx 0.8 m/s [160 fpm] can be as low as 0.4 m/s [80 fpm] lightweight papers) • For dining and retail, separate air speeds for subzones containing diners versus servers, clerks versus shoppers, may be created to account for their different activity levels and cooling needs (e.g.,

Fan type considerations

There is no absolute rule to be applied on how to select a suitable fan. In practice, fan selection criteria are mainly dependent on design intent of air speed and distribution, purpose of elevated air movement (i.e., direct cooling across human body or air circulation), and any limitations of fan usage in space.

In general, ceiling fans are effective for both comfort cooling and air circulation in nearly all scenarios and applications. Ceiling fans are recommended due to their effectiveness in air movement, provided that some limitations of implementation are considered. Firstly, “is there sufficient height clearance to install ceiling fans?”. To maintain ceiling fan efficiency and operational safety, the ceiling fan should neither be installed too close to the floor (i.e., prevents subjects accidentally contact with blades) nor the ceiling (i.e., avoids “starving” of the fan). For more details, please refer to the section of [Fan mounting height and clearances](#)). Secondly, “are there obstructions (permanently placed) at the ceiling or on the floor that interfere with the ceiling fan operation?”. Ceiling fans work more effectively in open space with less obstructions (see [Figure 23](#) for air speed distribution from ceiling fan). Air distribution and speed within space could be significantly distorted by the presence of bulky furniture or partitions. In addition, the lighting fixtures installed on the ceiling could have interacted with the rotating blades of ceiling fans, causing strobing and visual flickering effects, if the location of lighting fixtures and ceiling fans are not arranged properly (See section [ceiling fan interaction with lighting](#) for details). Furthermore, higher renovation cost and time for ceiling fan integrated design, when compared with portable air movement devices, could be a factor of concern for building practitioners when they are deciding to implement elevated air speed strategy in an operation building space.

If the above limitations do not apply, ceiling fans are likely to be recommended. Figure 33 shows that ceiling fans work effectively in different design intents summarized in Figure 32. Ceiling fans can be arranged to provide uniform air speed and distribution within a multi-occupancy space when the occupants do not have control of the fans. Alternatively, in spaces where ceiling fan speed can be centrally or manually adjusted, or occupants can freely move around to satisfy their variable thermal comfort needs, uniform air distribution is less important, and variability is recommended. In single occupancy rooms, the occupant can be given full control of the ceiling for fulfilling different air speed demands at different times of the day or throughout the year, in this case ceiling fans can provide personal control. While in a particular area that has special thermal demands, ceiling fans can be pre-set/adjusted with stronger air movement or located only over the most demanding area so, by design, higher air speed target part of the space and lower air speed reaches its adjacencies.

If the limitations of ceiling fan usage cannot be overcome, designers may consider choosing other fan types described in the [Other air movement devices](#) section, such as desk fan, pedestal fan, tower fan, bladeless ceiling fan, wall-mounted fan and air circulator. Figure 33 demonstrates examples for these fans' selection regarding different design intents. The bladeless ceiling fan and wall-mounted fan can provide relatively uniform air speed and distribution, but are only applicable to small size rooms due to installation limitations (i.e., wall-mounted fans can only be installed in a wall or column and will not affect occupants sitting too far from it) and airflow (i.e., bladeless ceiling fans require a boundary to deliver air towards the occupied zone, therefore are not efficient for big spaces). Most of the non-ceiling fan devices mentioned above are portable, operate near the occupants, and allow personal adjustment. This means that both variability and personal control design intents are achievable at the same time where occupants are free to move the fan and to adjust its speed based on their thermal preferences. In spaces where occupants are not supposed to have fan control, but they have special thermal demands, wall-mounted fan can be used to create variability or targeted air speed, by setting different air speeds in spaces where occupants can move around or by directing the wall-mounted fans to the most demanding occupants' group. In this sense, the wall-mounted limited coverage area may constrain a targeted design intent. Nevertheless, facility management teams are encouraged to complement adjustability providing personal fan to occupants when their personal demands are not met.

Within a space, different types of fans can be integrated to maximize occupants' comfort and to achieve multiple design intents. For example, ceiling fans can provide a uniformly low speed background air movement for all occupants in a large open space, while individual fan allow additional personal control to further improve occupants' local thermal comfort at whenever it is necessary (e.g., at transient condition or near the window).

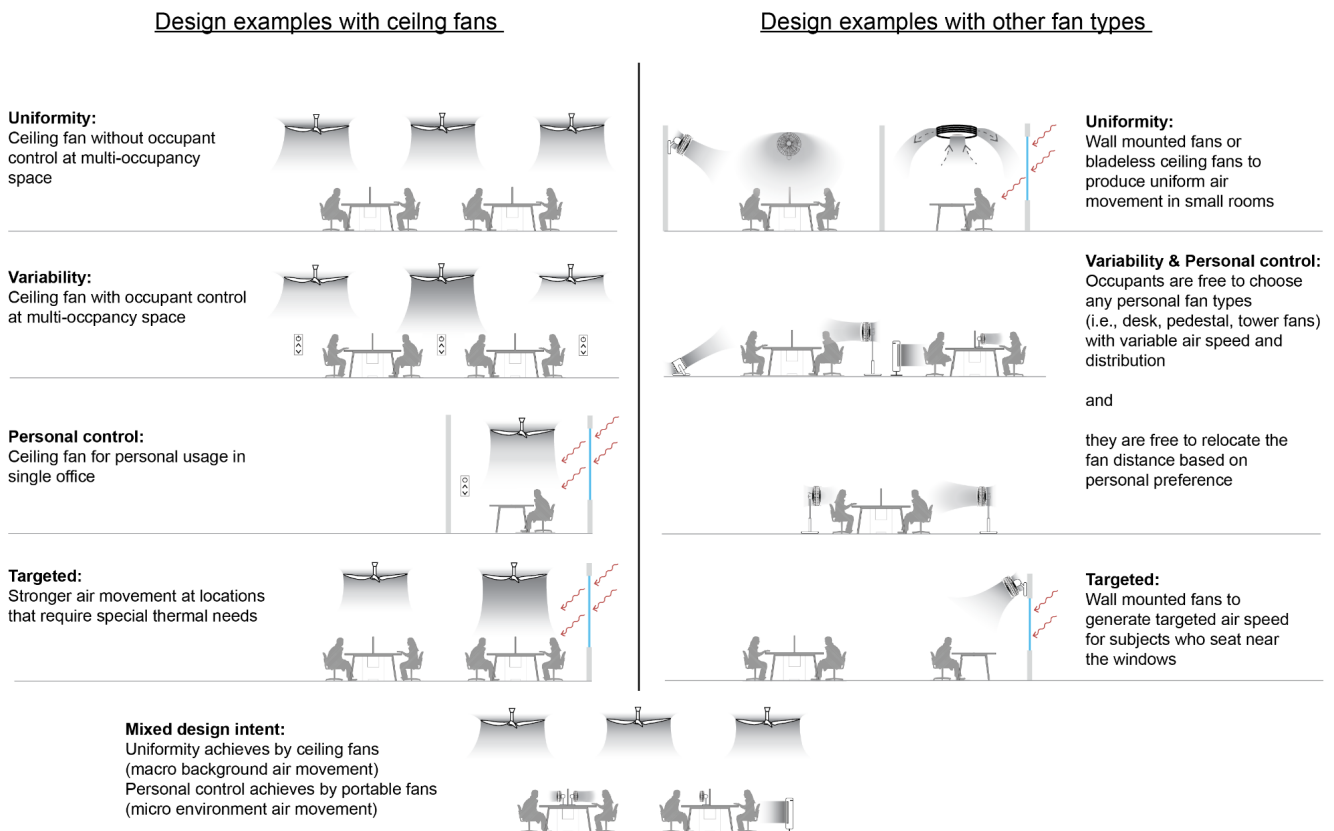

Figure 33. Fans selection examples based on different design intents.

Ceiling fan installation and integration with HVAC system

How to design, select, install and operate ceiling fans when integrated with a HVAC system?

Ceiling fan requires the most attention regarding its design, installation, and operation when compared with the portable counterparts (e.g., desk fan, pedestal fan). On the other hand, it presents the biggest opportunities for integration with the HVAC system design and operation for cost and energy savings. Additionally, incorporating ceiling fans into the design for new construction projects can generate substantial net first cost savings. Therefore, this section discusses the installation requirements of ceiling fans in buildings and the design and operation approaches when integrating with the HVAC system.

Ceiling fan system

Selecting fan sizes and determining the layout

Determining appropriate fan size and layout is critical to effective cooling from ceiling fans. The highest air speeds - and therefore the greatest cooling effects - from a ceiling fan are felt directly beneath the fan blade tips and dissipate the farther an occupant is from the fan. For larger diameter fans, there is a substantial stagnation region directly under the fan center. Air movement and the associated cooling effect are also impacted by obstructions such as furniture, partitions, or equipment. Any permanent obstructions should be considered in determining fan layouts, but spaces that may change in layout over time should take this into account for any application.

Considerations should also include the overall design intent for the ceiling fan application, including the desired air speed uniformity, and overall coverage of the space. Spaces that are likely to benefit from more uniformity will require larger fans or more fans than the spaces that are likely to benefit from variability (see the Applications example from [Table 4](#)). Fan size and layout must also consider relevant code requirements (see [Codes and Standards](#)), and potential conflicts and spacing requirements from other building systems such as fire sprinklers and lighting equipment.

To maximize uniformity of air speeds in a space with standard ceiling fans, choose the largest possible fan that fits in the space while maintaining appropriate mounting height and clearances from walls and other obstructions (see [Fan mounting height and clearances](#)). For small and roughly square rooms such as residential spaces or private offices, where only one fan is required, a simple rule of thumb is that the fan diameter should be between 0.2 and 0.4 times the characteristic room width, as Figure 34 shows. For spaces with a single fan, as closely as possible given practical considerations, the fan should be centered in the room to maximize air speed uniformity. Generally, a single fan centered in a space can effectively serve a rectangular space with an aspect ratio (length : width) of up to 1.5 : 1. Rectangular spaces with higher aspect ratios, or other unconventional shapes, benefit from multiple fans to ensure relatively uniform air speeds throughout the space. For rectangular shape (and other unconventional shapes) room, the characteristic width of the room is the square root of the floor area. For example, in Figure 34, a 6 x 4 m [20 x 13 ft] rectangular room, the characteristic width is 4.9 m [16 ft] and using the simple rule of thumb above yields fan diameters between 1 to 2 m [3.3 to 6.6 ft].

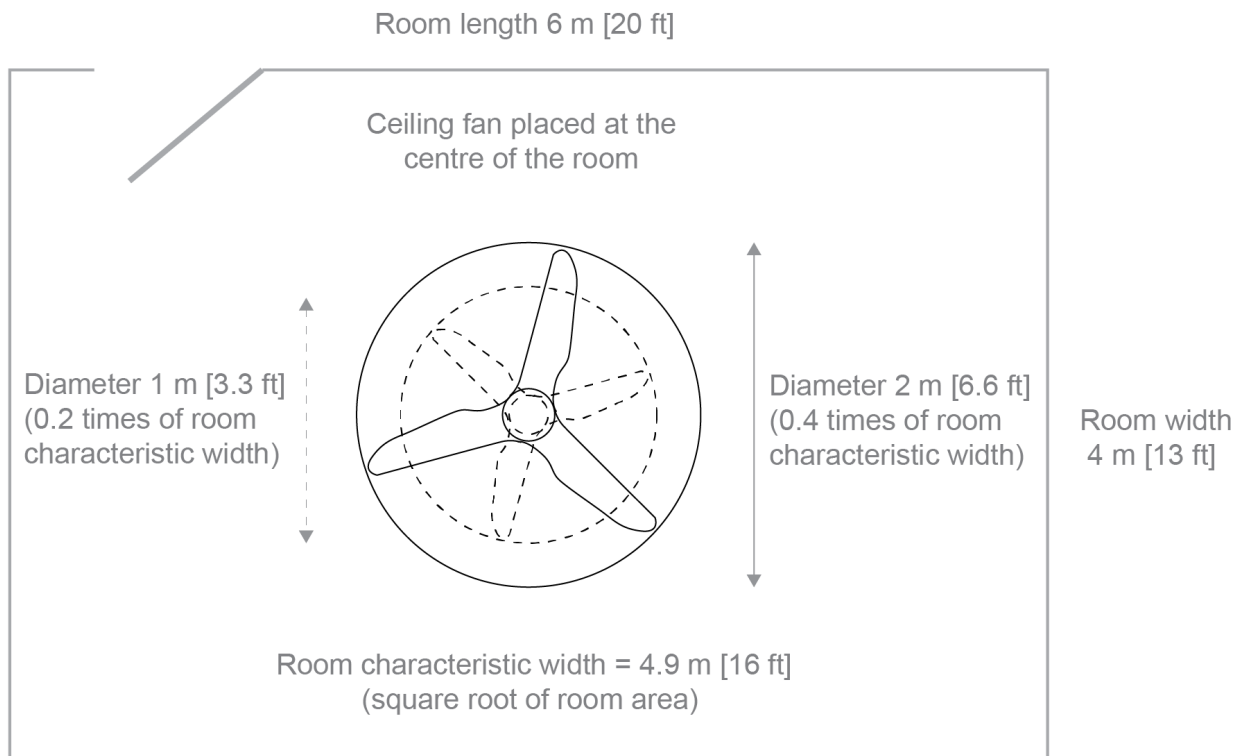

Figure 34. Recommended sizing and layout for single-fan applications in a small room.

For spaces requiring multiple fans the overall layout should be determined by subdividing the space into multiple equal roughly square “fan cells”, and then centering a ceiling fan in each cell. Fan cell size is determined largely by the overall dimensions of the space, and the preferred size of ceiling fans to be used. In many cases there may be a variety of options for fan cell and fan diameter. Fewer large fan cells will require larger diameter fans, while a larger number of smaller fan cells will require smaller diameter fans. When all fans operate at the same speed, the individual fan cells within larger spaces will behave much like smaller spaces with a single fan, and as such should target an aspect ratio of no more than 1.5:1. For Ratios above this value it is possible and beneficial to create split this cell into two fan smaller cells with smaller aspect ratios. As with smaller single-fan spaces, fan diameters should be at least in the range of 0.2 to 0.4 times the characteristic width of the fan cell. Higher values will increase the uniformity of air speeds throughout space. Fan-to-fan spacing should be determined based on centering the fan as much as possible within each fan cell and should take into consideration needs for air speed uniformity in the space. Spaces with high uniformity requirements may necessitate larger fans and closer fans spacing. Large spaces with high ceilings (at least 3.3 m [11 ft]) should also be considered using large-diameter ceiling fans to maximize airflow and uniformity of air speeds (both horizontally, and vertically). Figure 35 presents two examples of recommended ceiling fan size and layout for multi-fan applications with the same site area (240 m² [2580 ft²]) but different room heights and room functions: (a) warehouse and (b) office. In particular, Figure 35b demonstrates two layout settings: less fan cells with larger fans (on the left) and more fan cells with smaller fans (on the right). Despite the settings on the left, four fans with a diameter of 2.2 m [7.2 ft], fulfil the rule of thumb mentioned above, large-diameter fans (i.e., >2.1 m [7 ft]) requires at least 3 m [10 ft] safety mounting height above floor level. Therefore, these fans selection and arrangement are not suitable for office setup with 2.6 m [9 ft] room height. The settings with smaller size but a greater number of fans on the right are more suitable in this situation.

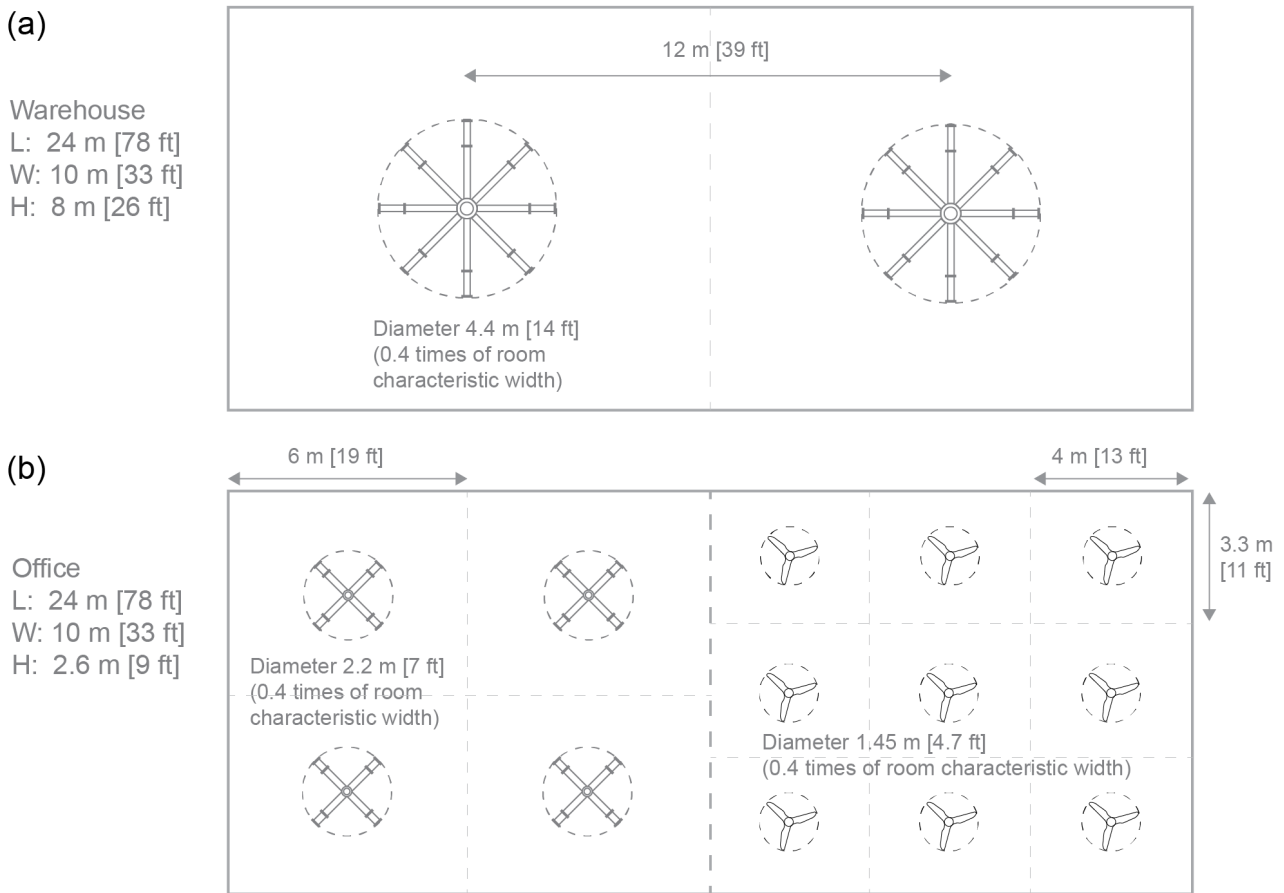

Figure 35. Recommended ceiling fan size and layout for multi-fan applications. (a) Warehouse with higher room height, (b) office with lower room height.

The [CBE Ceiling Fan Design Tool](#) automatically suggests fans dimensions and numbers based on the room dimensions, applying the describe considerations to determine an ideal layouts. Refer to section “[CBE Ceiling Fan Design Tool](#)” for more details.

Fans installation

Users are advised to install ceiling fans following the manufacturer’s recommendations. Nevertheless, they can be installed in all types of ceiling, and there is no reinforcement requirement if the diameter of fan is smaller than 2.1 m [7 ft]. To adjust the fan height, some products allow extending the length of the downrod. The ceiling fans should be fixed in a structural surface of the building to guarantee sturdiness and stability, which can be a slab or beam. For suspended ceiling, the downrod should be longer to ensure sufficient blade-to-suspended-ceiling-height. A canopy shall be positioned below the suspended ceiling to improve aesthetics (see Figure 36a). With the appropriate type of mounting bracket, ceiling fans can also be installed in sloped ceiling (see Figure 36b).

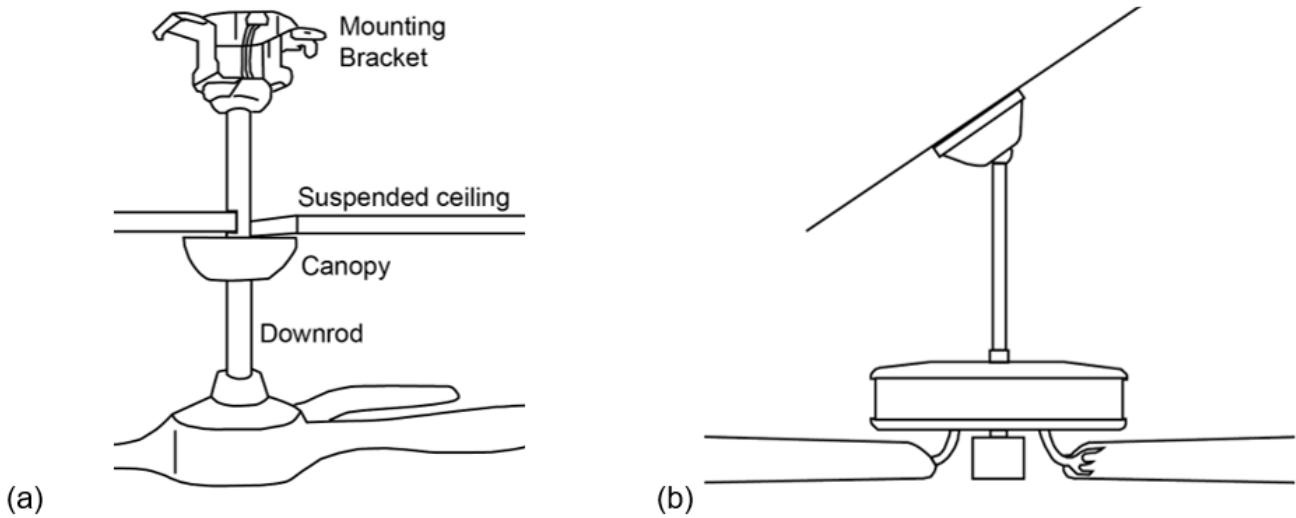

Figure 36. Ceiling fans installation parts.

Fan mounting height and clearances

Another key consideration for ceiling fan effectiveness is mounting height and clearances. Mounting heights and clearances from walls and other obstructions are determined based on both safety and performance considerations.

Standard ceiling fans must be mounted at least 2.1 m [7 ft] above the floor to prevent any accidental contact with blades (see Figure 37). In addition, industry standards recommend fan blades be at least 20 cm [8 in] below the ceiling, though clearances of 31 cm [12 in] or more are more optimal at providing air circulation into the swept area of the blades and avoiding 'starving' the fan. The distance between blades and the ceiling at which 'starvation' occurs increases with fan diameter. An approximation for this has the distance between the blade and the ceiling should be at least 0.2 times the fan diameter. For spaces with relatively low ceilings, "hugger" ceiling fans are available without downrods to maintain adequate clearance, though these fans typically have poorer energy performance than standard fans mounted at an appropriate distance from the ceiling. In spaces with higher ceilings, standard ceiling fans should be suspended on downrods at 3 – 8 m [10 – 26 ft] above the floor to adequately cool occupants. In addition, standard ceiling fans must be located so that the sweep of the blades is at least 45 cm [18 in] from any vertical obstructions such as walls or columns, though clearances of 0.6 – 0.9 m [2 – 3 ft] are often recommended to enable proper air circulation.

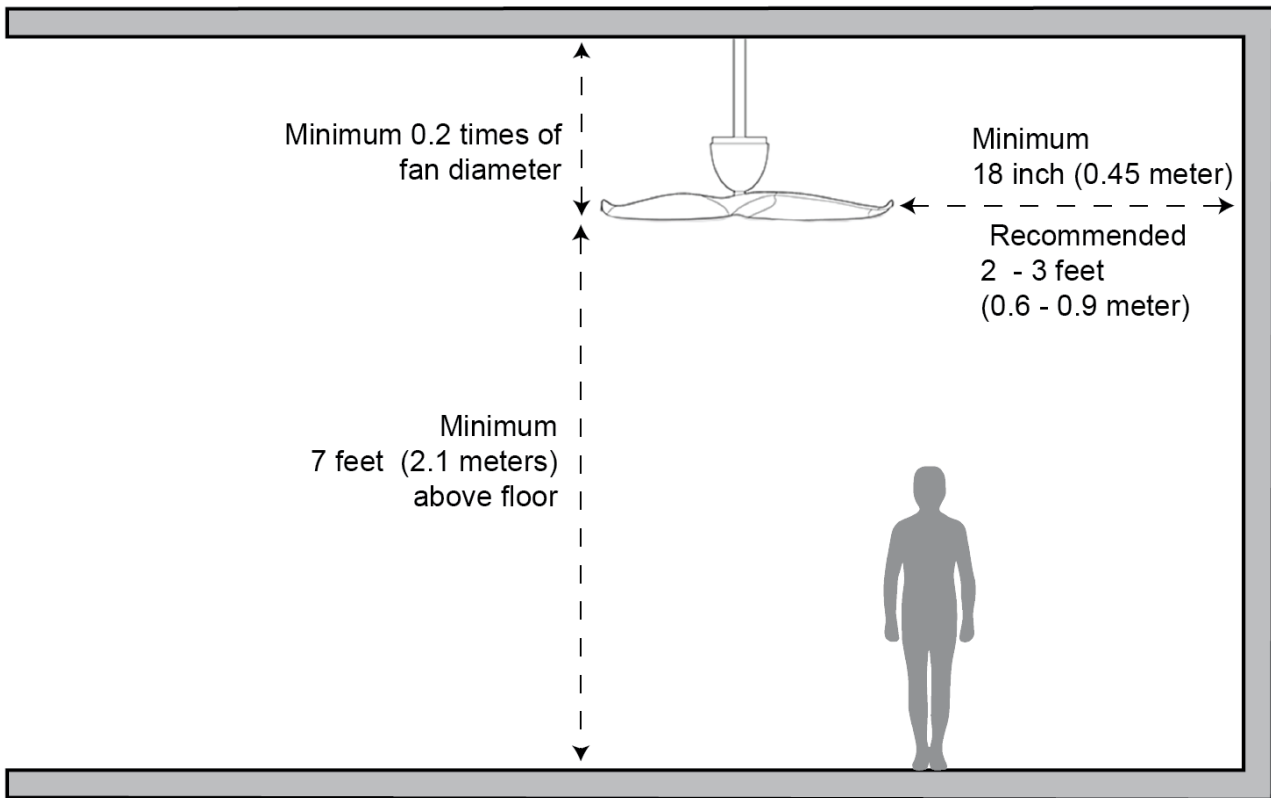

Figure 37. Minimum clearances for standard ceiling fans.

Safety regulations require almost all large-diameter fans (above 2.1m [7 ft] in diameter) to be mounted such that the blades are at least 3m [10 ft] above the floor (see Figure 38). A small number of large-diameter ceiling fan models can be mounted below 3m [10 ft], but these fan models have limited rotational speeds to comply with safety regulations, and as such provide limited maximum airflows. As mentioned above, large-diameter ceiling fans typically require a minimum distance from the ceiling of 0.2 times the fan diameter, though manufacturer recommendations may vary. Similarly, large diameter fans typically require at least 1 m [3 ft] of clearance from any obstructions to the sides or below the fan blades for safety and the ensure proper airflow around the fan blades.

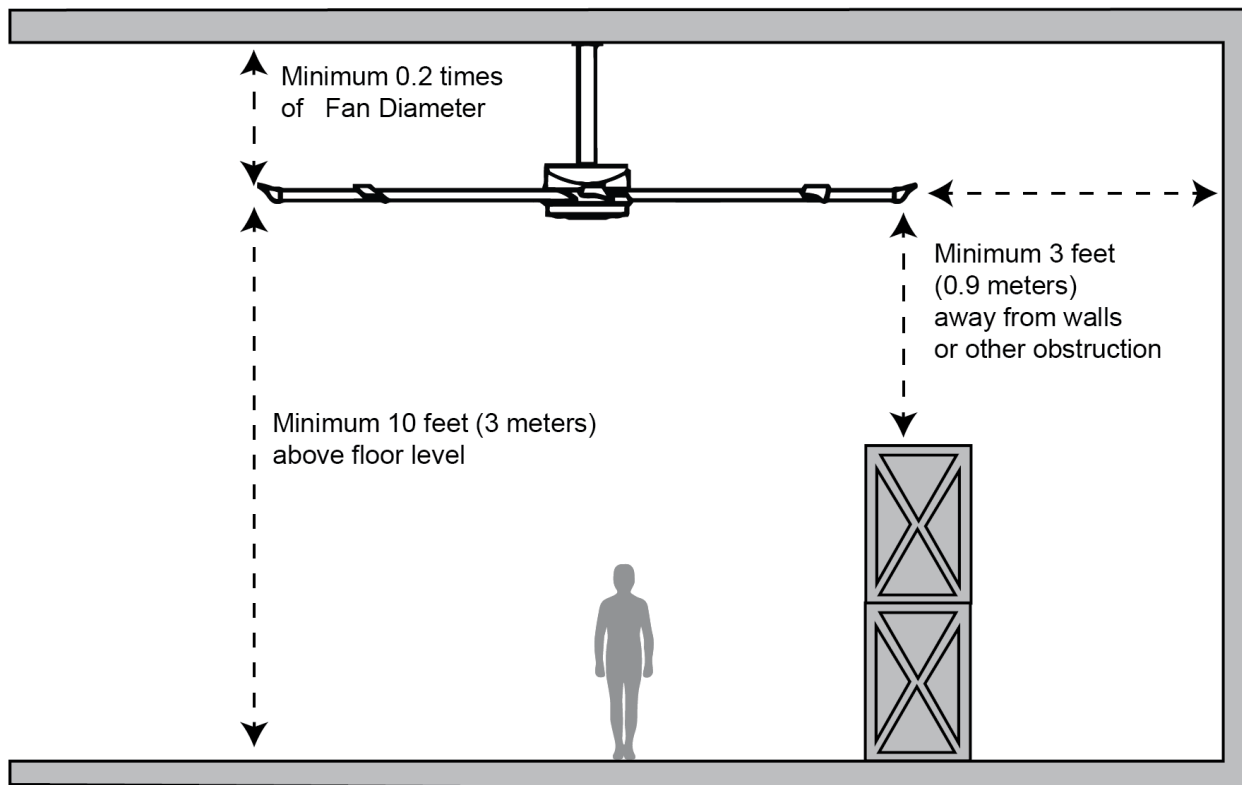

Figure 38. Minimum clearances for large diameter ceiling fans.

In addition to distances from ceilings, floors, and walls, fan placement must also consider any other obstructions in a space, including lighting, mechanical equipment and ducts, fire sprinkler systems, warehouse storage racks, as well as any relevant code requirements (see [Codes and Standards](#) section below). For example, when planning an installation of large-diameter ceiling fans in a warehouse, fans should be mounted at least 1 m [3 ft] above the highest level of any storage racks, stored items, and the tallest extent of any other equipment that may be used in the space such as forklifts. Fan placement and mounting height should also take into consideration any potential furniture placements, even though they may not be permanent. Cabinets or tall bookcases may interfere with fan operation, or cause safety hazards if located too close to ceiling fans.

Multiple ceiling fans operation

We learn in previous sections that the zone air speed and flow pattern from a ceiling fan can be determined by its fan size and rotational speed. However, in many circumstances, ceiling fan does not work individually but include multiple fans serving the same zone (e.g., open plan office). How does the zone air speed and flow pattern change with multiple fans interaction?

Detailed measurement of air speed induced by ceiling fans has been conducted in climatic chamber ([Liu et al., 2018](#)). It showed the speed difference and the distance between two ceiling fans will affect the airflow profiles within space. Figure 39 demonstrates the air circulation patterns interacting between two ceiling fans at both side view and top view for the conditions of (i) comparable air speed vs dominant air speed and (ii) fans set closer to each other vs further apart. The fans distances represented in Figure 39 are not recommended for design but aim at showing airflow pattern interaction with multiple fans.

If both fans are installed close to each other (i.e., $1.3 \times D$, center-to-center distance) and operated at medium or high speed, both air jets will skew towards each other, creating a high turbulence zone in the mid-layer between the fans. For the same close fan distance, if one fan is operating at a much higher speed than the others, the air circulation will be dominated by the stronger fan, while the weaker fan's jet will be skewed towards the stronger one. A low air speed zone will be observed directly under the weaker fan, since the stronger fan has dominated the airflow (i.e., dragging air from the weaker fan and guiding the airflow along the floor level). For the same fan speed testing conditions but with two fans installed further apart ($> 1.7 \times D$, center-to-center distance), the influence of airflow pattern by the other fan will be smaller, meaning that the air jet mainly follows the principle as a single fan condition. In other words, the airflow effectiveness by each fan has been maximized when compared with close fan installation case. From these experiments, the ceiling fans separation distance and their operation speed would impact a lot on the airflow pattern in space. These parameters must be verified early in the building design stage to maximize the system efficiency. Visualization tools that demonstrate the measured air speed and flow pattern for a single ceiling fan and double ceiling fans operation at different distance and fan speed are available below:

single-fan case: <https://cbe-berkeley.shinyapps.io/single-fan>

double-fan case: <https://cbe-berkeley.shinyapps.io/two-fans>

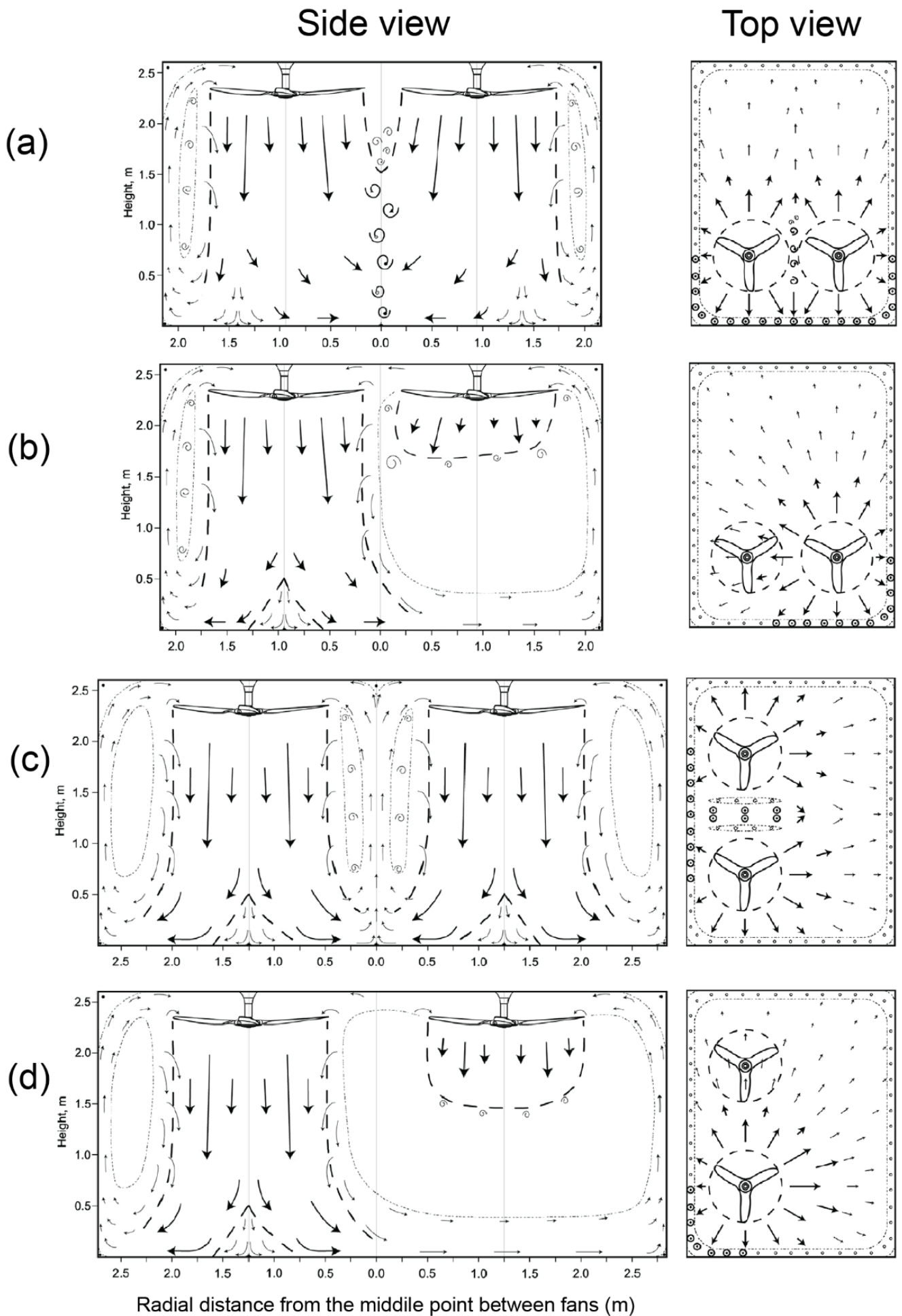

Figure 39. Air circulation pattern and interaction between two ceiling fans. (a) comparable air speed at closer fans distance, (b) dominant air speed at closer fans distance, (c) comparable air speed at further fans distance, and (d) dominant air speed at further fans distance.

Impact of infiltration rate

The outdoor flow rate, sometime measured in air changes per hour (ACH), is one important parameter that determine the indoor environment quality and building energy consumption through mass and energy exchanges between indoors and outdoors (Nazaroff, 2021). Figure 40 illustrates the outdoor air exchange dynamics instigated by a ceiling fan through two distinct opening configurations, namely, the normal window opening and the door-like opening.

In the normal window opening condition, the induced airflow caused by the ceiling fan traverses upwards along the sidewall. A fraction of the upward flows will be dragged out of the window while the remaining that is retained indoors will form a closed-loop circulation back to the ceiling fan. In such a case, little impact of the room ACH will be independently initiated by the ceiling fan. However, the ACH will be dependent on the outdoor wind direction with respect to the window facing. When the window is facing the leeward side of the building, the ACH will be relatively low and thus operating ceiling fan would increase the air-exchange rate. Conversely, if the window is on windward side, the use of ceiling fan could reduce the ventilation rate when compared with no fan condition.

The adoption of a door-like opening configuration is indicative of an enhanced ventilation rate during the operation of a ceiling fan. The momentum of the stimulated airflow generated by the fan results in an outward displacement of air in close proximity to the floor. Meanwhile, negative pressure gradients developed at the apex of the door promote the inward influx of outdoor air, effectively enhancing air circulation. The degree of improvement in air exchange, expressed as the air changes per hour (ACH), is largely dependent to the performance capacity of the ceiling fan, specifically, its air flow rate and rotational speed.

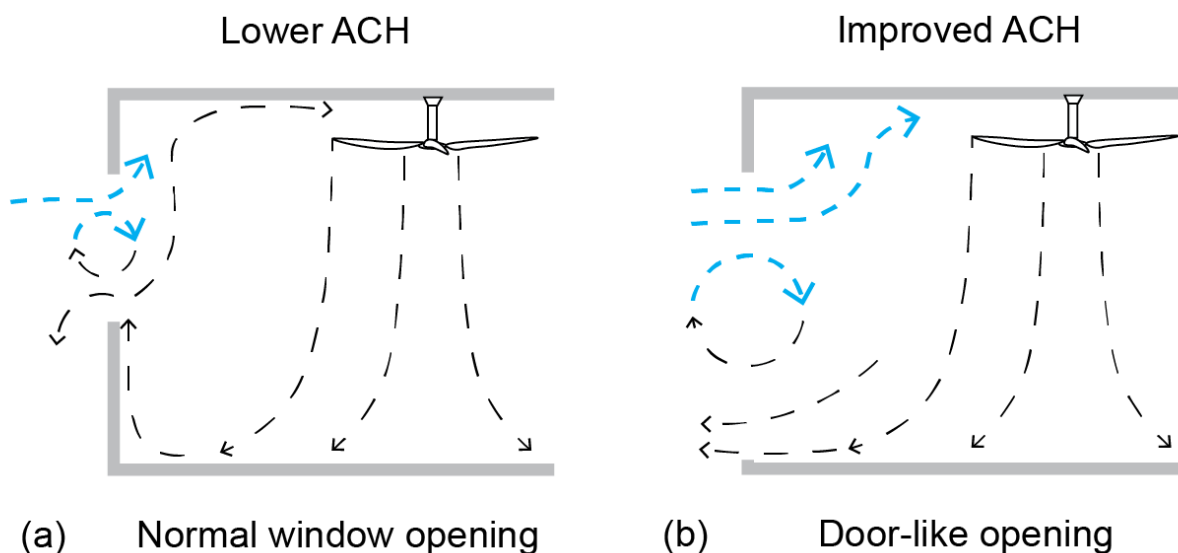

Figure 40. Illustration of airflow patterns induced by ceiling fan for (a) normal window opening, (b) door-like opening settings.

Ceiling fan interaction with lighting

While many ceiling fans are available with built-in lighting (i.e., light kits), typical ceiling fan lights may be insufficient for many lighting requirements and applications. Most applications will be best served by an independent lighting system with additional ceiling fan(s) installed alongside recess lighting that occupies the same ceiling space.

When the ceiling fan blade interacts with light distributed from a recess fixture (see Figure 41a), light flashing on surfaces (i.e., strobing) and at the light source itself (i.e., flicker) can occur. Some design recommendations have been proposed to overcome these problems, but these do not always resolve problems that are caused by the application of ceiling fans. To remove flicker, it is often suggested to move the ceiling fan away from recess lights (see Figure 41b). While this recommendation will likely prevent strobing, it does not stop flicker (Kent et al., 2020).

The visual line of sight from the occupant to a recess fixture can still be blocked by a ceiling fan since the ceiling fan blades are mounted below the electric light (see Figure 41b). Therefore, this design arrangement between the ceiling fan and recess lighting still creates flicker seen from multiple viewing positions inside the space. Another design option is to use dropdown lighting (i.e., light fixtures are suspended at the level of fan blades or below them, see Figure 41c), which bypasses issues of flicker completely, and prevents strobing on the floor surface. However, drawbacks to this configuration may occur in low floor-to-ceiling applications when reflections from adjacent surfaces are projected back onto the ceiling or onto wall surfaces, creating strobing. Meanwhile, glare from electric lights may also be produced when they are mounted closer to the occupants' head.

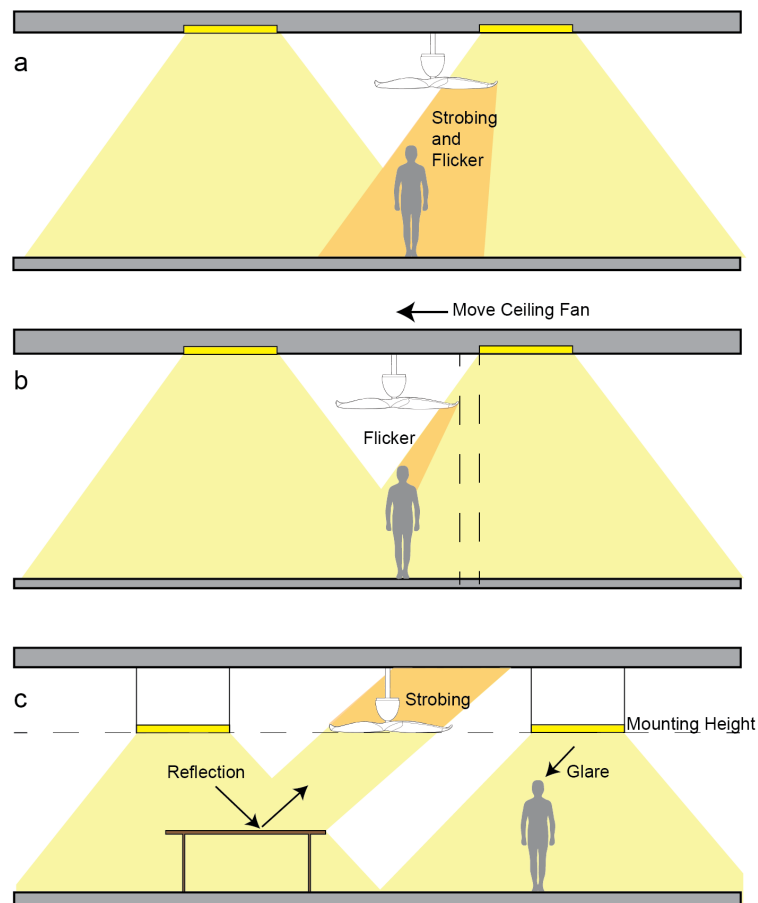

Figure 41. Sectional illustrations showing how interactions between ceiling fans and electric fixtures across different configurations convey different issues to the lighting design of that space: (a) strobing and flicker, (b) flicker, and (c) ceiling strobing.

Strobing and flicker can also occur when ceiling fans interact with daylight transmitted through skylights (see Figure 42). These problems will naturally arise when direct sunlight is admitted into the space, increasing both the temperature and the need to use ceiling fans. Unlike recessed lighting, maneuvering the ceiling fan may not remove strobing when the roof is fully glazed by the skylight. The size and number of blades are often larger to increase the effects of space cooling in these applications. This generally increases the area and frequency in which strobing, and flicker may occur inside the space.



Figure 42. Ceiling fans installed onto skylight applications in Singapore, creating problems of strobing and flicker when daylight is admitted into the space.

There are many adverse effects that are caused by visual flicker. Increased visual discomfort was an overt consequence from a design layout that followed current recommendations in a recent study. Short-term exposure (i.e., about 10-minutes) to flicker from the configuration, shown in Figure 43, made it hard for people to concentrate, which lowered their mental performance (Kent et al., 2020). This could hinder learning in schools or reduce productivity in offices. Under a longer exposure time, like daily working conditions, and for populations highly sensitive to flicker (e.g., photosensitive people), the effects of flicker caused from ceiling fans may be exacerbated.

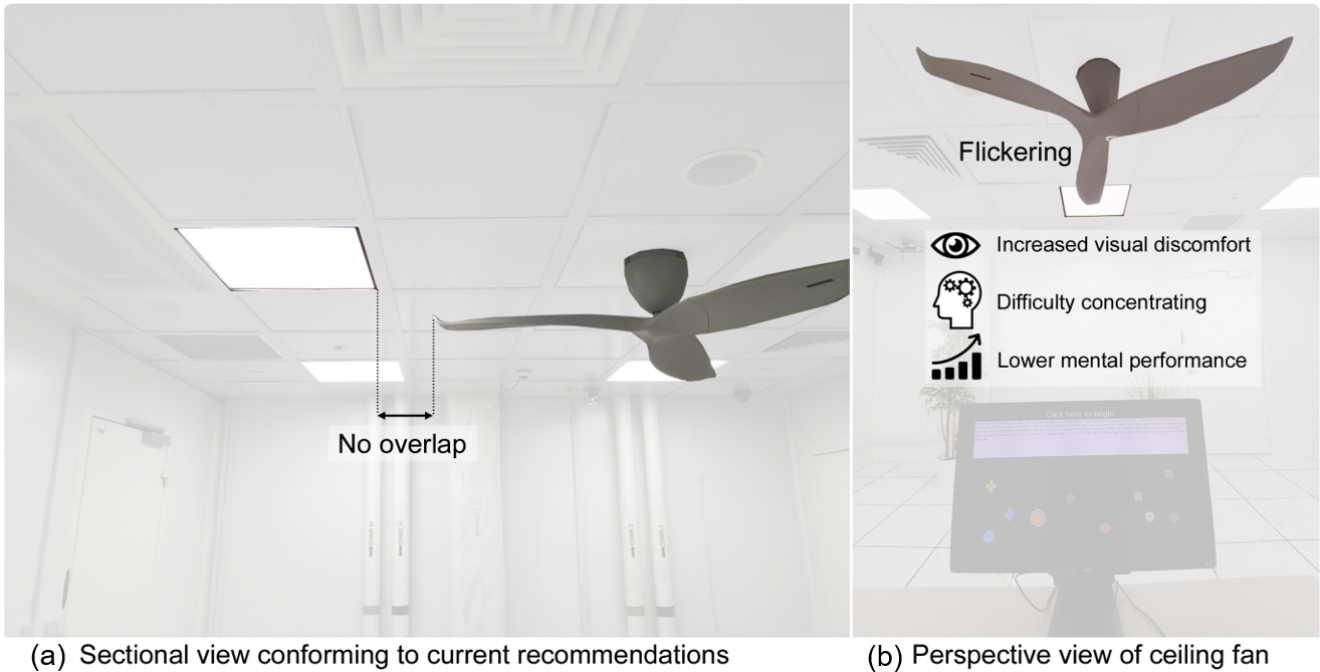

Figure 43. An experimental setup that had followed the design recommendations to remove flicker when using a ceiling fan and recess lighting. The sectional view (a) shows that the blade does not overlap with the light fixture, but the perspective view (b) from a desk shows flicker can be seen.

Not all buildings that use ceiling fans and recess lighting together will produce flicker. This mainly concerns smaller spaces, where the risk of the two technologies interacting with each other is higher. Designers should distribute ceiling fans and electric lights to achieve the desired air-movement and illuminance level while avoiding issues that lead to visual or thermal discomfort. When there are risks of strobing and flicker caused by ceiling fans, some alternative solutions can be suggested.

Transparent ceiling fan blades: This allows light to be transmitted through the blade material, avoiding flickering even when the ceiling fan position would obstruct the electrical light. Nevertheless, it poses additional safety concerns when compared to opaque blade fans, especially for low floor-to-ceiling height applications.

Bladeless ceiling fan: Fan blades are covered by a casing material that prevents them from interacting with electrical lights.

Other fan types: Fans not mounted onto the ceiling pose no risk to the lighting design of the building.

Diffuser panel (skylight applications only): Diffusing the daylight entering through the skylight may alleviate, or even completely remove strobing and flicker from occurring.

Air-conditioning system

The intent of this section is to discuss some common HVAC system that integrates with ceiling fan. The discussion will be focused on how ceiling fan integrates with the system, instead of how to design the HVAC system itself, which is addressed in the [Integrated ceiling fan and HVAC control](#) section

Conventional HVAC system with diffusers

Ceiling fans can be directly implemented to existing air-conditioned buildings with installed ceiling diffusers, as long as that the requirements of mounting height and clearance are fulfilled as described in previous section (see Figure 44). The benefits of installing ceiling fans, i.e., increase building efficiency, improve thermal comfort, and enhance air speed and temperature uniformity, can be achieved. For the air-conditioned space that has shorter floor to (false-) ceiling height, the use of other air movement devices is encouraged due to safety consideration.

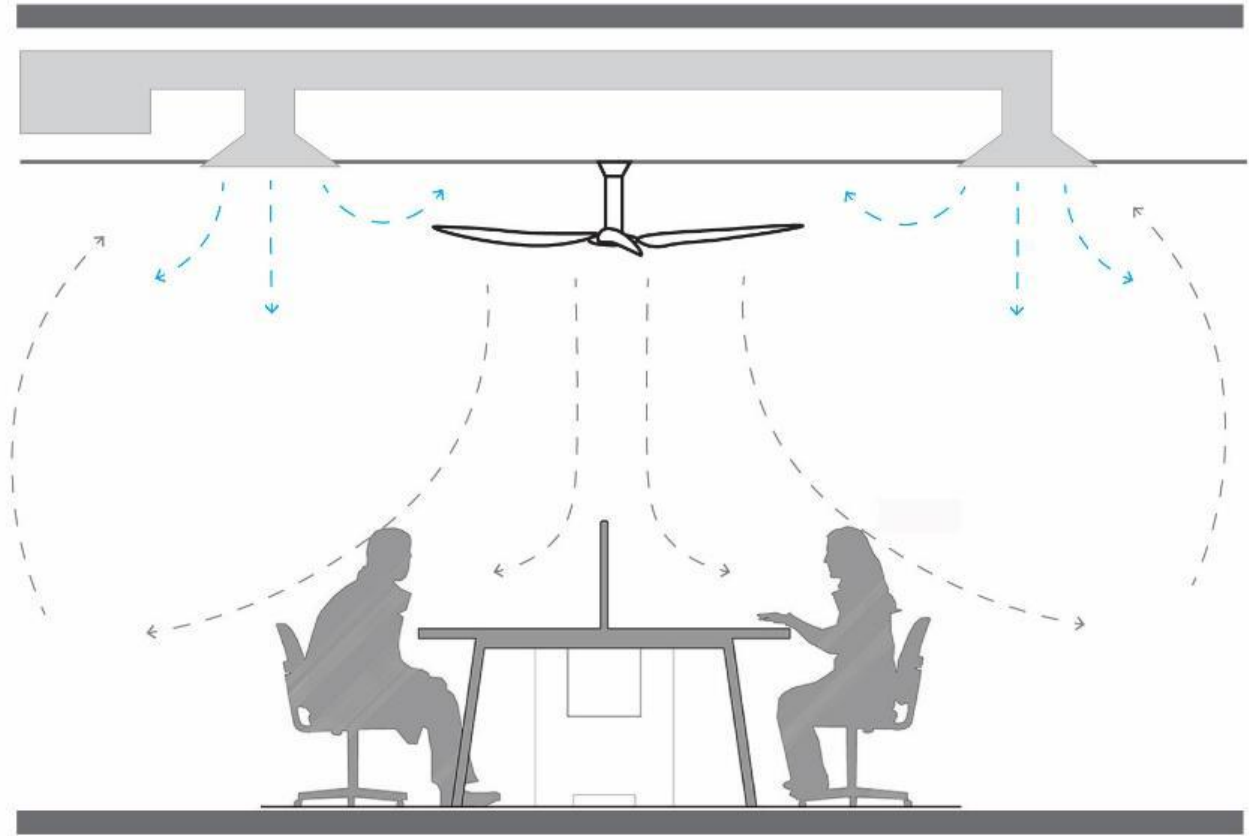

Figure 44. Ceiling fan integrates with conventional all air system with diffusers.

Side-wall supply jet

The function of diffusers and branch ducting in conventional HVAC system is to distribute conditioned air evenly through indoor space, especially for the areas that are away from the main supply air duct. The same purpose, however, can be achieved by operating ceiling fans, meaning that the diffusers and branch ducting could be reduced or completely removed.

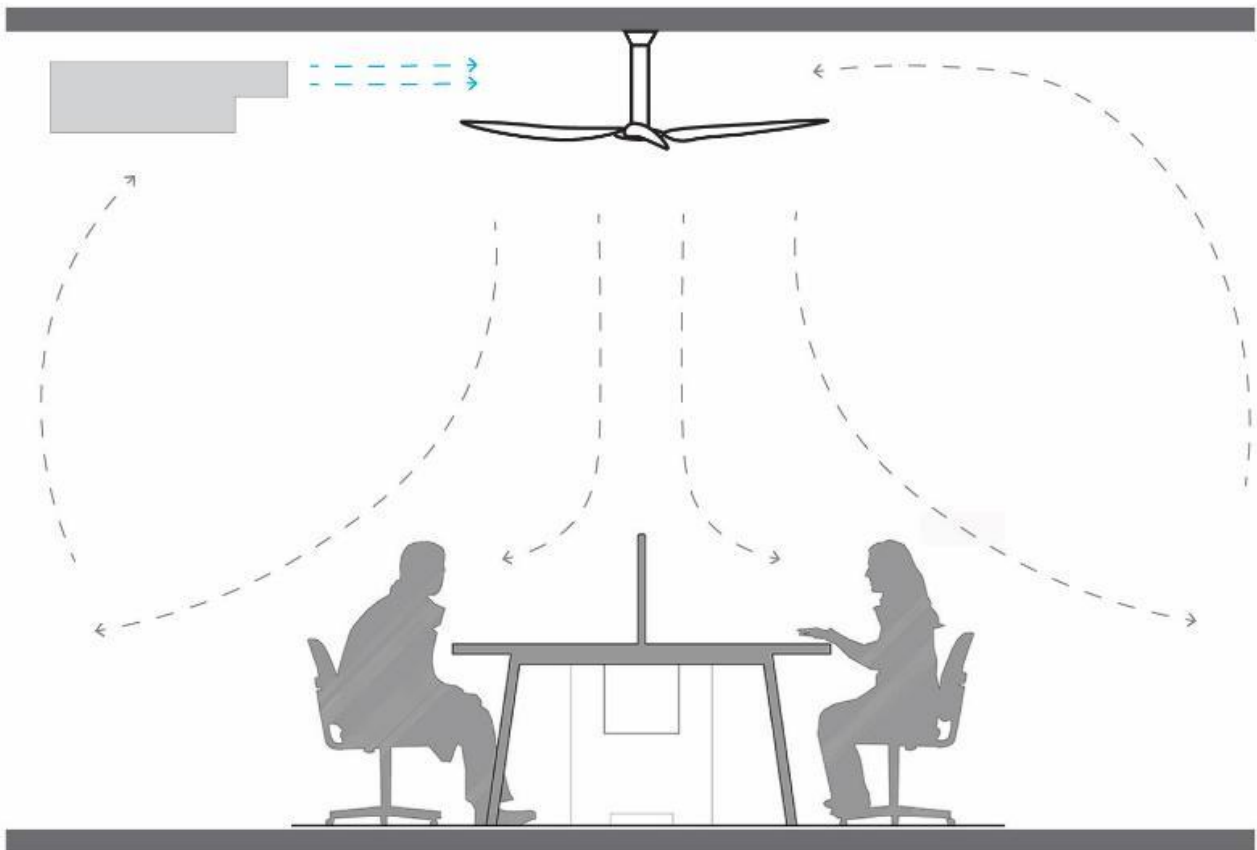

Figure 45. Ceiling fan integrated side-wall air supply air-conditioning system.

Figure 45 demonstrates a new approach on how HVAC system integrates with ceiling fans. The cool air is supplied from a high-side wall vent directly towards the center of the space. Then the ceiling fan mixes the supplied cool air with the room air and distributes it over the indoor space. The immediate benefit of such HVAC – ceiling fans integrated system is the reduction of unnecessary duct work on the ceiling, thereby saving significant amount of costs on the initial construction and continuous maintenance. Further discussion on cost saving with a case study will be demonstrated in the later section of this guide. Secondly, without a false ceiling and extra ducting on top, the ceiling fan is operated more safely and effectively due to maximized mounting height and sufficient clearances between the ceiling and fan blades, especially for a space with limited floor to ceiling distance.

In such a system, the cool supply air would best be fed through the fan (i.e., above the ceiling fan blade), rather than impinging into downward airflow initiated by the ceiling fan (i.e., below or level to the ceiling fan blade). Although the air velocity distribution pattern will be dominated by the ceiling fan airflow in both cool air supply conditions, the air temperature profiles delivered to the occupied zone is different. Figure 46 shows the cool supply air merged with the ceiling fan downward airflow, which possibly initiating a cold draft into the occupied zone, when the cold air is supplied at fan blade height (Chen et al., 2020). In contrast, if cool air is supplied above the fan blade, the supply air is immediately mixed with the room air, it provides a uniform air temperature into the occupied zone.

This approach has been studied for cooling conditions. In heating, the fan may be used in reverse mode but there is no available knowledge about its performance, therefore caution should be used.

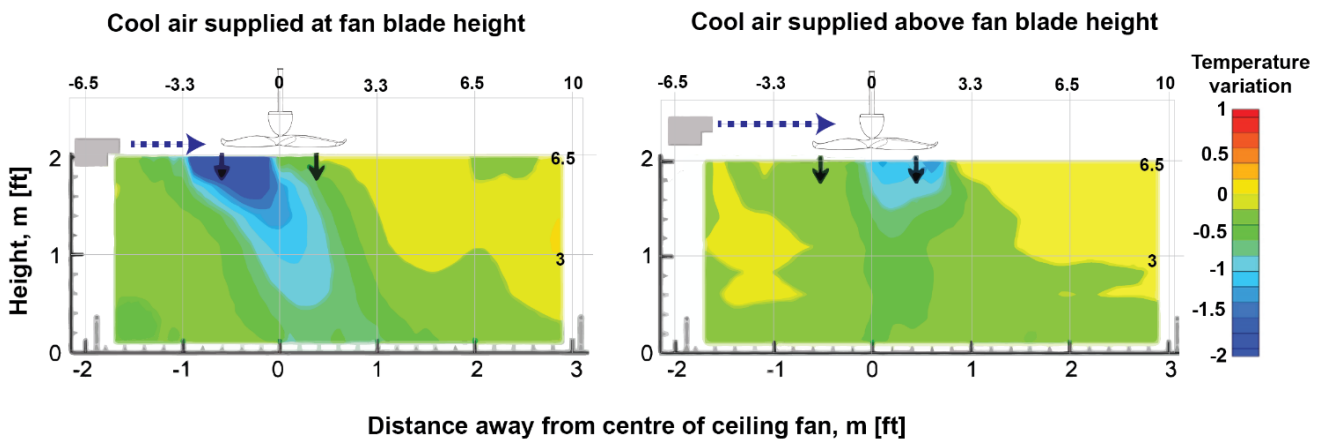

Figure 46. Air temperature variation profile for side-wall air supply at fan blade height and above fan blade height.

Radiant heating and cooling

Radiant heating and cooling systems can achieve significant energy savings, peak demand reduction, load shifting, and some thermal comfort improvement compared to conventional all-air systems. The pipes can be either embedded into the slab (ceiling or floor) or installed inside a radiant panel. Ceiling fans are a good match with radiant heating and cooling systems as they can also increase heat transfer from the radiant system (requiring lower temperature differences between the room and the water, further improving efficiency), and provide the occupant with a means of instantly changing the comfort condition in the space. Figure 47 shows the integration of ceiling fan with radiant system with water pipe embedded into the slab and inside the radiant panel.

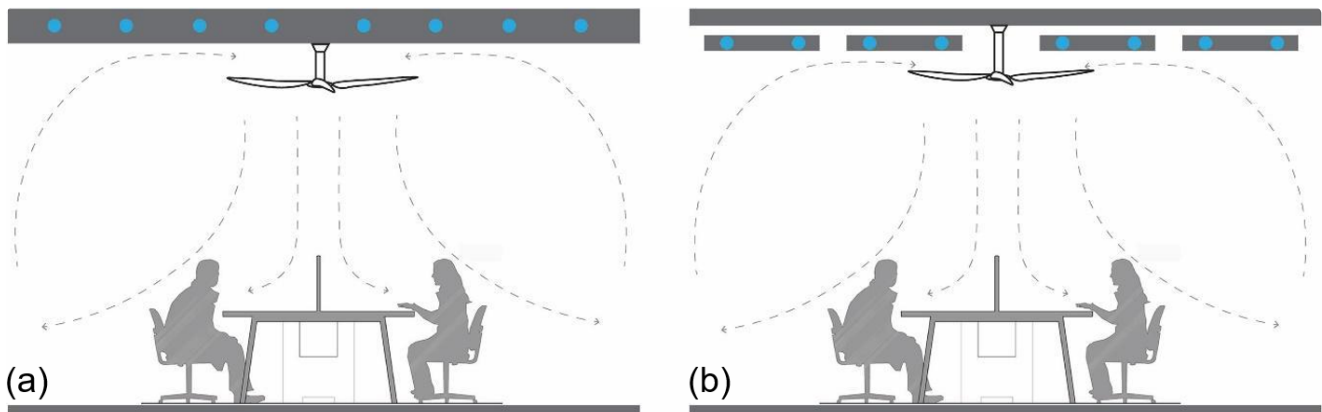

Figure 47. Example for radiant cooling system (a) directly embedded piping inside slab, and (b) piping installed inside radiant panel.

In terms of system efficiency, compared with a conventional radiant ceiling cooling system (without ceiling fan), the cooling capacity of a radiant system with ceiling fan can be increased by up to 22 % and 12 %, respectively, when the fan is blowing upward and downward (Karmann et al., 2017). Upward blowing fan moves the air directly towards the radiant cooling panel on the ceiling, thus resulting in higher cooling capacity. Likewise, a downward blowing ceiling fan, with higher air speeds along the floor, would maximize the cooling capacity of a radiant floor system. Another study on radiant floor systems found that downward blowing ceiling fans increased the radiant slab cooling capacity by 16 % at 24 °C [75 °F] operation temperature and increased by 26 % at 26 °C [79 °F] temperature (Pantelic et al., 2018). Experimental results suggest that elevated air speed in space enhances cooling capacity and system efficiency in radiant system by improving the convective heat transfer.

HVAC systems that are not favorable for ceiling fans

While we have introduced above the HVAC systems that are favorable integrating with ceiling fans, there are also some HVAC designs unfavorable for ceiling fan operation. These systems mainly aim at temperature and pollutant stratification instead of air mixing, such as displacement ventilation and underfloor air distribution system.

Figure 48 presents the airflow patterns of a typical displacement ventilation system. The conditioned cool air is supplied from an air handling unit through diffusers, either located against a wall or at the corner of a room. The cold air gets warmer by absorbing heat from the heat sources (e.g., occupants, equipment) and slowly rises to the top. Thermal plumes are formed due to the density difference between the cold and warm air. Finally, the warm air on the ceiling is removed by the return air outlet. One benefit of displacement ventilation is the improvement of air quality by removing fine particles in the room (light particle goes together with the thermal plumes and exhausts out). The presence of ceiling fan, in this case, will adversely mix the air and temperature inside the room causing the thermal plume dependent on the temperature gradient to no longer exist.

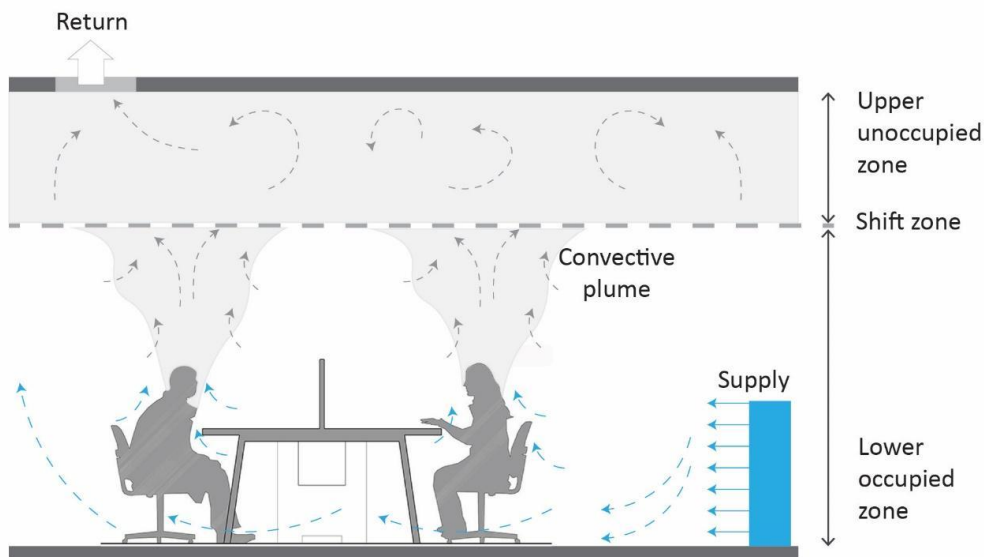

Figure 48. Airflow patterns for displacement ventilation system (Li et al., 2017).

Similarly, the airflow pattern in the underfloor air distribution (UFAD) system (see Figure 49) also relies on the temperature difference within the space, by providing fresh and cool air from underfloor to the lower occupied zone and exhausting the warm air in upper unoccupied zone from the ceiling return. Again, the presence of ceiling fan in UFAD would break the ventilation path, resulting in negative system effectiveness.

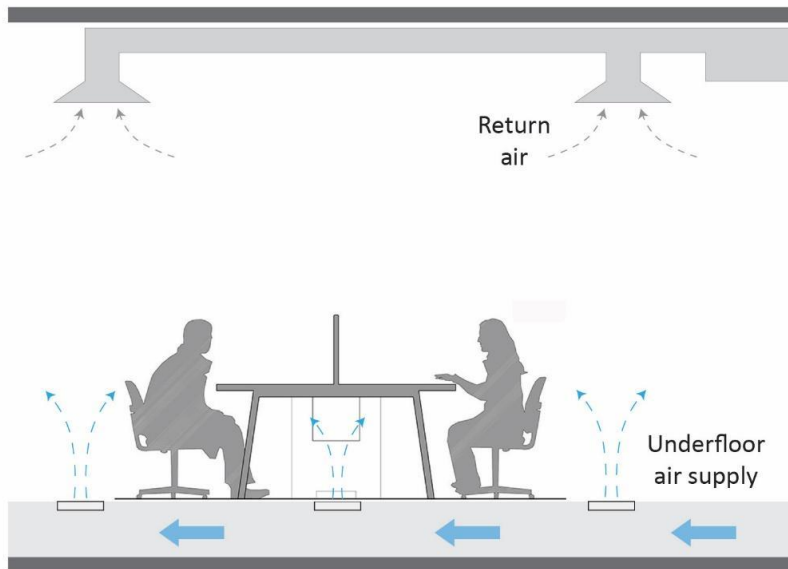

Figure 49. Airflow patterns for [underfloor air distribution \(UFAD\)](#).

Integrated ceiling fan and HVAC control

This section describes the control strategy for integrating ceiling fans and HVAC system.

HVAC system control with / without a fan

Figure 50 demonstrates the control schematic for the HVAC system with and without the integration of a ceiling fan. The HVAC signal for heating reduces when indoor temperature increases accordingly, and it stops when the indoor temperature goes beyond the heating setpoint say 21 °C [70 °F]. For a case without ceiling fans, the HVAC signal for cooling starts when the indoor air temperature goes higher than the first cooling setpoint temperature say 24 °C [75 °F]. Alternatively, for a case integrated with ceiling fan, the fan may respond to zone temperature, acting as the first stage of cooling for a zone before the HVAC system begins to operate in cooling mode. The ceiling fan will operate at the first cooling setpoint of 24 °C [75 °F] to provide convective cooling and maintain occupants' thermal comfort without operating the HVAC. The fan speed increases with zone air temperature until reaching 25.5-26.5 °C [78-80 °F], at a point which the HVAC system begins to modulate and to maintain that setpoint, providing the second stage of cooling. Operating the HVAC system at this higher cooling setpoint has significant energy savings potential.

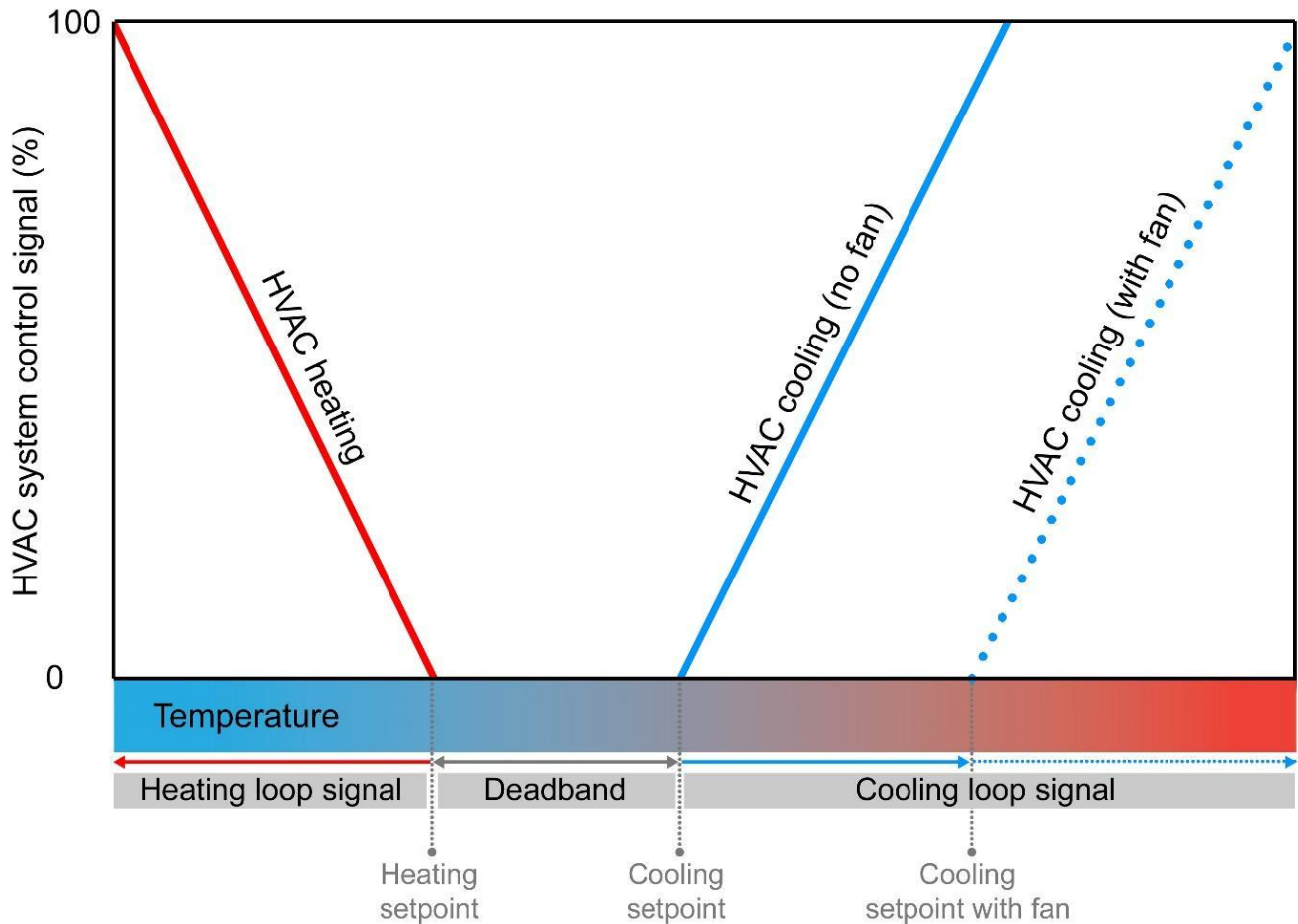

Figure 50. Example HVAC control schematic with without ceiling fans.

Ceiling fan speed control

Ceiling fans can be integrated with the building automation system (BAS) through several mechanisms. True integration requires speed control of the fans, and this is typically achieved using either a 0-10 V input or a BACnet interface. Using the same control case above, Figure 51 shows the control scheme for the ceiling fan speed when responding to zone temperature.

Within the dead band, especially when HVAC is in heating mode, the ceiling fan should be turned off or operated at lowest possible air speed (or even rotating in reverse for destratification or general air mixing). The fans will need to stay on if the HVAC system and its air distribution strategy was designed with less ducts and diffusers assuming the fans would have been in operation for air mixing. When the temperature reaches the fan cooling setpoint, e. g., 24 °C [75 °F], a signal from BAS will operate the ceiling fans in the space to provide the first stage of cooling. The ceiling fan speed increases with the room temperature, which is determined by cooling effect or predicted at a representative point in space. HVAC for cooling operates when the room is at the HVAC cooling setpoint, e.g., 25.5-26.5 °C [78-80 °F] and operates to maintain the room at that temperature. Ideally, the fan speed will increase with the room temperature till the maximum (i.e., 100 %). At all stages, the fan should be controllable by users, meaning that occupants can override fan speed and on/off status any time. The same applies for the HVAC cooling setpoint. However, there should be an automated system review (or regular manual review) of setpoints throughout the building to ensure they have not been adversely overridden by an occupant and left in place indefinitely.

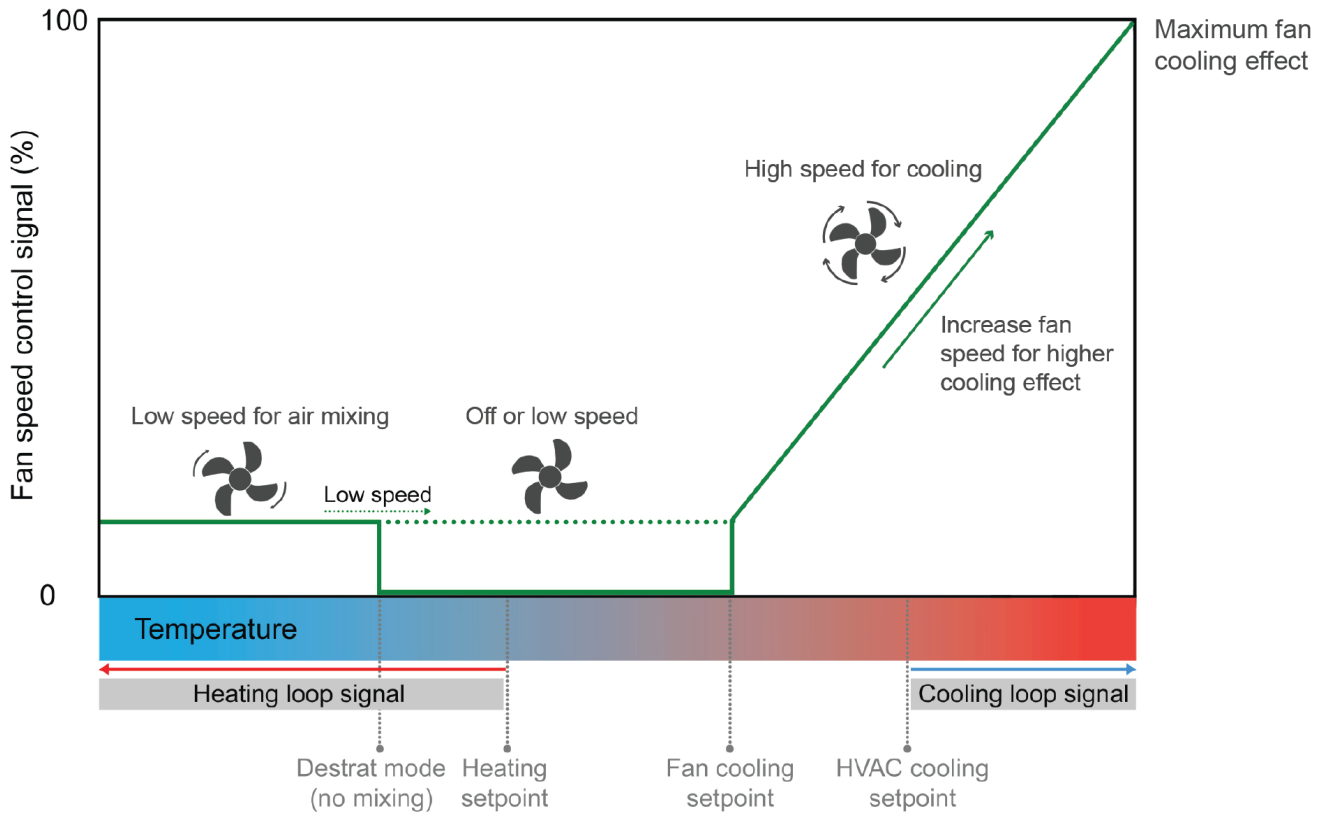

Figure 51. Example ceiling fan control schematic.

Ceiling fan control alternatives

Some ceiling fans have onboard sensing and controls that allow fan speed and temperature automation without integration with the BAS. A lower cost, simpler alternative to automatically control the ceiling fan based on temperature is to use a relay to turn fan(s) on and off. The fans then operate at a fixed pre-set speed. This only provides on/off control, and as such can only be effective over a small range of temperatures without a 'typical' occupant in the space experiencing conditions that are either too warm (insufficient air movement) or too cool (excessive air movement). This approach is mostly applicable for:

- the use of ceiling fans predominantly to mix the air within the space and aim for relatively low air speeds (e.g., ≤ 0.25 m/s [50 fpm]) in the occupied zone. Example applications include: destratification in heating, or air mixing to reduce the need for distribution ductwork.
- for spaces where variability in air speeds is beneficial (e.g., the occupants can easily move within the space, such as a lobby, event space, or hallway).

Fans operation can also be tied to occupancy sensors in the zone, preventing unnecessary operation, energy use, and maintenance. In some cases, it may be beneficial to operate fans even when unoccupied, such as pre-cooling applications that benefit from increased convection from surfaces in the space due to the air movement generated by the fans.

Smart ceiling fan and HVAC control algorithm

Apart from controlling the ceiling fans based on temperature setpoint, smart fan control can also be achieved based on occupant's characteristics, such as occupancy and user preference feedback. To do this, all ceiling fans are connected and controlled by a central controller, as part of the smart building management system, to acquire environmental data such as temperature, relative humidity (RH), and occupancy from a network of sensors in the space. From those inputs, the control algorithm calculates in real-time the optimal fan speed to maximize thermal satisfaction for occupants (Liu et al., 2018). The ceiling fan controller can also be integrated with the HVAC controller for cooperative operations by adjusting the zone temperature setpoints when necessary. There are two main control strategies, automatic mode that is based on ASHRAE 55 comfort model and cooperative mode, that is based on people feedback.

In automatic mode, the integrated PMV-SET (Predicted Mean Vote - Standard Effective Temperature model used in the ASHRAE 55 standard) is utilized to evaluate the thermal comfort in each zone in real-time to determine the optimal fan speed settings (Liu et al., 2018). The model inputs include real-time temperature and RH from the environmental sensors. Personal parameters, i.e., metabolic rate and clothing, are pre-defined within the algorithm. The cooling effect due to elevated air movement is obtained by iteratively solving the SET equation. The output of the PMV-SET model is the desired air velocity to achieve the pre-set targeted PMV range, which is the comfortable range between -0.5 to 0.5. Figure 52 illustrates the PMV-SET with Occupancy control algorithm at automatic mode.

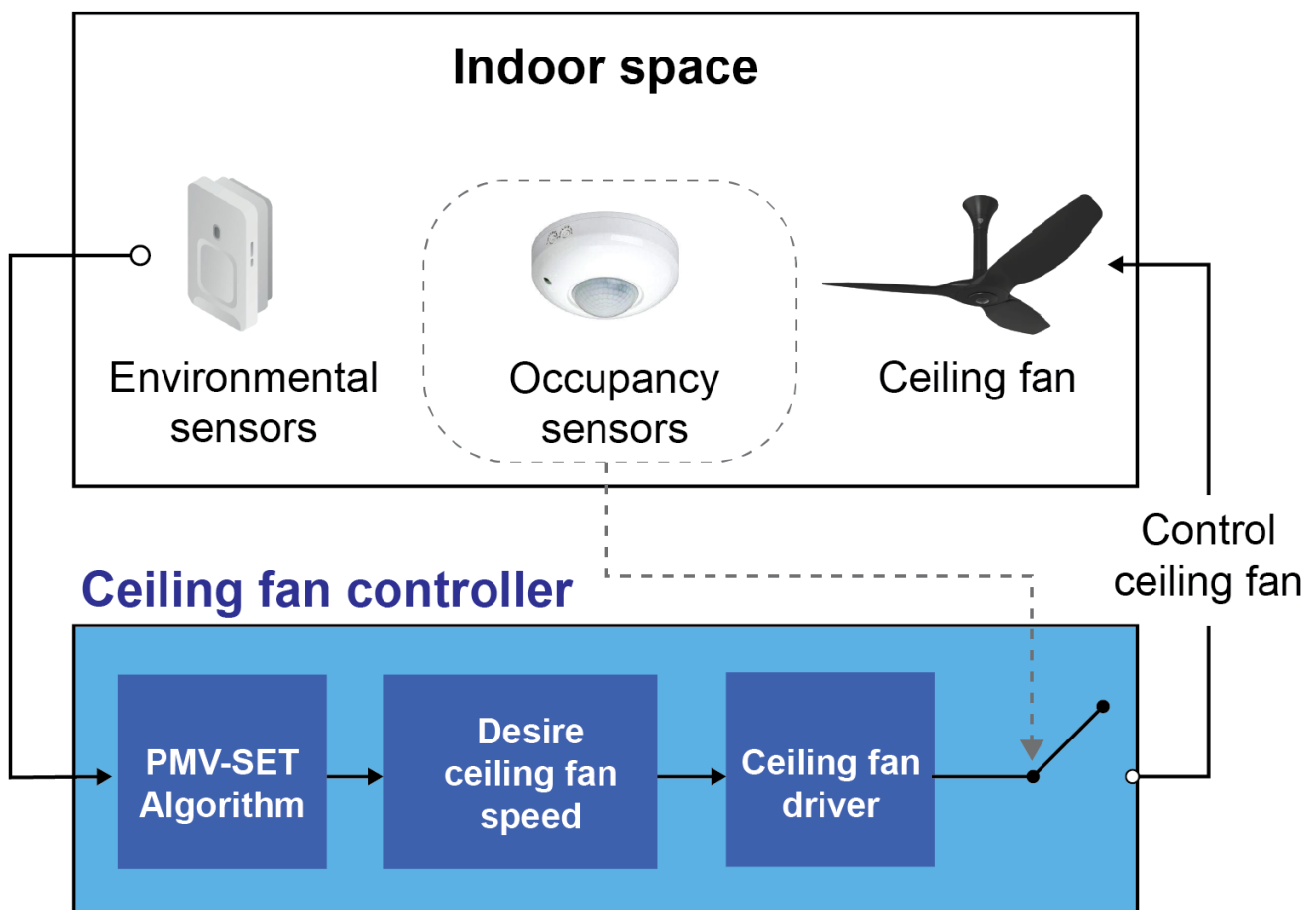

Figure 52. Automatic control mode of ceiling Fan using PMV-SET algorithm, environmental sensors, and occupancy sensors.

In cooperative mode, the ceiling system operates based on the environmental data and real time occupants' preference feedback, such as preference for cooler or warmer thermal sensation and preference for more or less air movement. Occupants would give their feedback anytime via a software application receiving individual users' feedback regarding their preference on fan speed and/or thermal sensation. In this way, the user sensation preference becomes an active input component as a "human-sensor" in the closed-loop ceiling fan control system (see Figure 53). For example, if most of the occupants in the space (i.e., 80 % - adjustable by setting) prefer a cooler environment, first a higher fan speed will be set to satisfy the occupants' needs; if this is still insufficient, then a lower indoor temperature setpoint could be set. This strategy has been successfully applied to a Zero Energy Building in Singapore achieving high energy savings (~32%) and high thermal comfort (Kent et al. 2023).

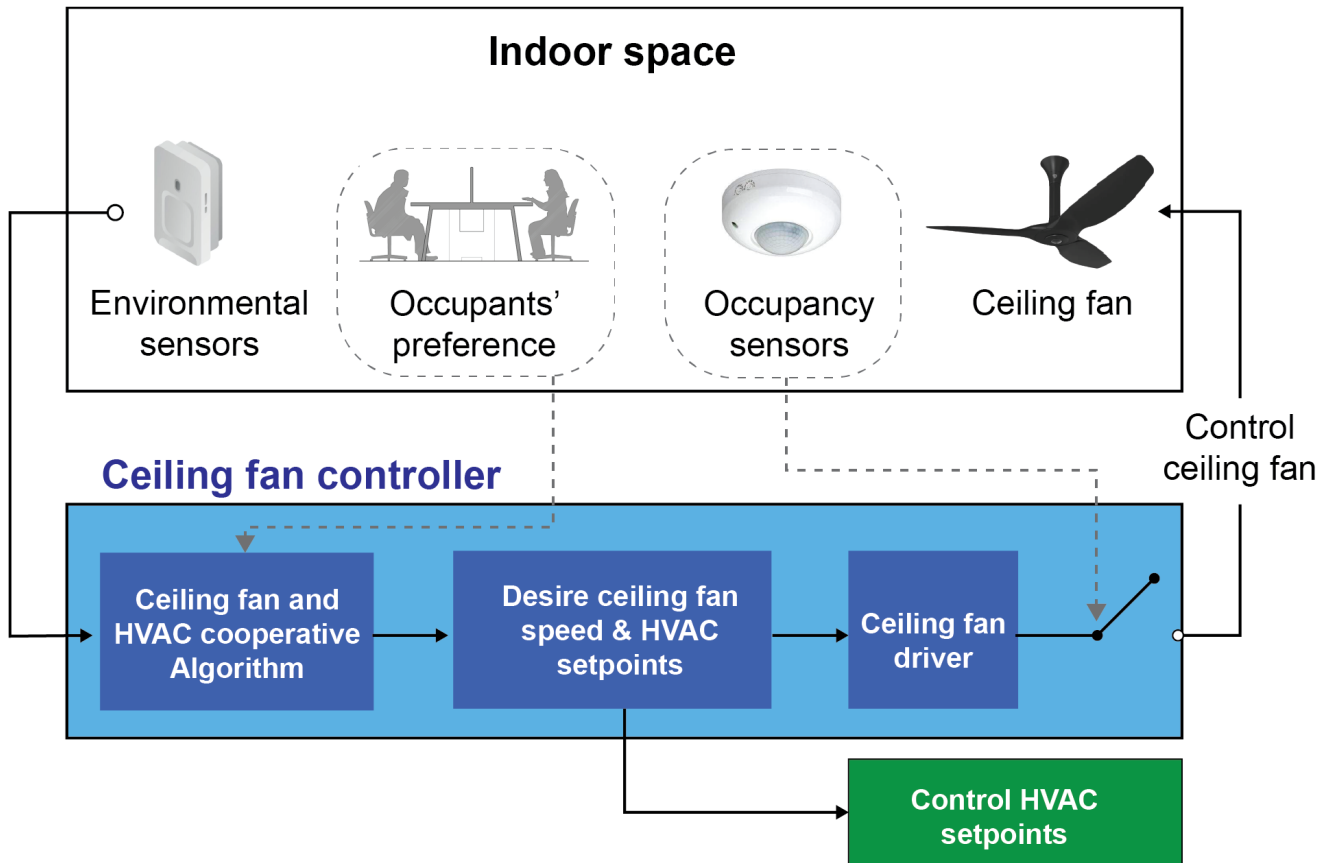

Figure 53. Ceiling Fan cooperative control mode using occupants' preference feedback.

Conventional HVAC vs. ceiling fans integrated HVAC

What are the differences in design considerations, costs, and energy use?

Design layout and components

This section discusses the difference in design and components needed between the conventional HVAC and ceiling fan integrated HVAC system using the same building layout plan (see Figure 54). In conventional HVAC system (see Figure 54a), diffusers are the prime fitting to distribute cool air over the space. They should be evenly installed and require detailed commissioning in balancing the air pressure over the supply air duct (i.e., maintain standard flowrate in each diffuser) to ensure air distribution effectiveness. Depending on the system requirements, variable air volume (VAV) boxes are installed for better zone temperature control.

Alternatively, shown in Figure 54b, the ceiling fan integrated air-conditioning design for the same layout requires only the main supply air duct throwing cool air directly from the sidewall towards the center of space. The ceiling fans can effectively mix the air and temperature within the space, without any diffusers nor extensive supply air ducts for uniform air distribution. The number of ceiling fan and corresponding installation location can be estimated using the [CBE Ceiling Fan Design Tool](#).

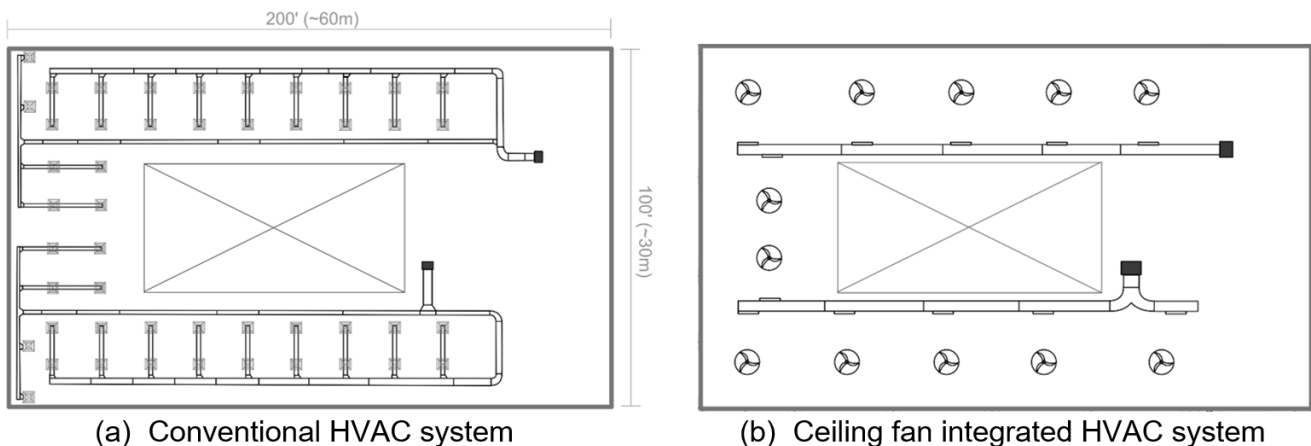

Figure 54. Example design layout for (a) conventional HVAC system with supply air ducts and diffusers, (b) Ceiling fan integrated HVAC system with limited air ducts.

System design, selection, and operation

One major advantage for air movement design is the additional convection effects on occupants and zone equipment, meaning that additional energy saving from space cooling is possible due to HVAC system optimization.

Design room conditions

The presence of space air movement allows higher dry bulb room temperature (2-3 °C [4-5 °F]) and dewpoint temperature (1-2 °C [2-4 °F]) when compared with conventional HVAC design. Alternatively, if the original designated air temperature is 23-25 °C [73-77 °F], it can be increased to 23-27 °C [73-81 °F] with elevated air movement to achieve similar or even better thermal comfort. The room's operating air speed can be up to 0.8 m/s [160 fpm] without personal control, while there is no air speed limit if occupants have full control of the fans (i.e., just ceiling fan or ceiling fan + desk fan) within the space.

Systems selection

Regarding the relaxation of designated cooling demand (i.e., lower sensible and latent load), the chiller and the air handling unit (AHU) from original HVAC system can be downsized in the system design stage. The design supply air temperature setpoint (SAT) and chilled water temperature (ChWT) setpoint relaxation should be 50% to 100% the zone cooling setpoint temperature adjustment. For example, if compared to a conventional HVAC design, the HVAC design with elevated air speed could have 2 °C higher cooling setpoint temperature, the SAT and ChWT setpoints should be increased by 1-2 °C. In addition, a smaller size fan in the AHU can be used for the ceiling fan integrated design, because it returns smaller static pressure along the critical supply air path (only require the main supply air duct).

Potential savings

Construction cost

Estimation from a consultant firm suggests that the ceiling fan integrated air-conditioning system in Figure 54 could save up to 45 % in capital construction cost when compared with the conventional HVAC system design. These savings are mainly obtained from reduced ductwork, diffusers, VAV boxes, sensors and controls. Savings can also be obtained from the extra time and workmanship for additional ducting and fittings installation. More importantly, the majority of these ducting and fittings are not reusable and become construction waste when the building is being demolished. The cost of purchasing and installing the ceiling fans in the space was very low when compared to the above cost savings.

Energy consumption

Substantial energy for space cooling can be accrued when implementing the elevated air movement with higher temperature cooling strategy. An energy simulation model of a standard office, in Figure 55, shows approximately 17 % of energy saving in the HVAC system by increasing the cooling temperature setpoint from 22 °C [72 °F] to 25 °C [77 °F]. In such room temperature setpoint adjustment, higher chilled water supply temperature (10 °C [50 °F]) can be used, instead of the conventional temperature setpoint (7 °C [44.6 °F]), which it would account for approximately 12% of additional energy saving from the chiller. Meanwhile, the consumption of cooling energy savings by increased room temperature setpoint tends to be much greater than the ceiling fans energy consumption. A study of 100 automated ceiling fan showed 36% of compressors energy savings when compared with air-conditioning only conditions, while the fans consumed only 2% of the total compressors consumption (Miller et al., 2021).

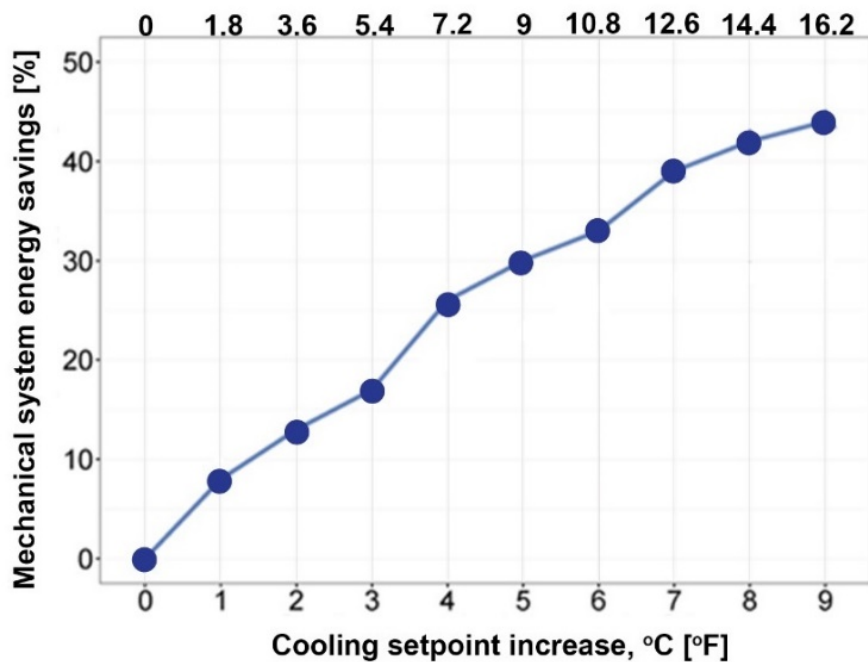

Figure 55. Percentage of mechanical system energy savings by increased cooling temperature setpoints (Duarte et al. 2017). The baseline temperature is at 22 °C [71.6 °F], either reflecting cooling setpoint increase at 0 °C [0 °F] in the x-axis.

Continue testing and adjustment

Conventional air-conditioning design requires detailed testing and commissioning on the airflow through the diffusers and the air pressure drop within the supply air duct. However, there is no standard procedures available for system testing for ceiling fans integrated system. Two recommendations are proposed to test the system's effectiveness in the post-occupancy stage. First, conduct physical measurement on indoor temperature, mean radiant temperature, relative humidity, and air speed at the occupied zone, and check the zone comfort range using the [CBE Thermal Comfort Tool](#). The post-occupancy air speed and pattern could be different from that in the design stage because these parameters are sensitive to room furnishings (e.g., desk, partition, and shelf). Second, it is strongly recommended to conduct a post-occupancy evaluation to understand the actual feelings and needs of the occupants. It is the most direct way reflecting occupants' satisfaction and to plan mitigating action for improvement. If there are areas where air movement from ceiling fans cannot be reached, providing occupants with personal fans (i.e., desk, pedestal, or tower fan) could be a solution.

Managing occupants' expectations with fans

How to deal with occupant expectations when fans are introduced in a space?

Fans can be added to an existing AC system to save energy and increase comfort. Besides the aspect related to the system's design, it is also important to consider how the new fans are introduced in the space and how the temperature setpoints are increased.

Progressive transformation and user adaptations

The benefits of higher temperature cooling with elevated air speed, in terms of energy saving and higher occupant comfort level, have been verified in multiple studies (see "[Benefit of Elevated Air Speed](#)"). However, occupants are used to a conventional cooling strategy with only air-conditioning at lower setpoint temperatures.

Occupants take time to adapt to the fan-integrated AC system at warmer temperatures and higher air speed environments. Depending on the site conditions and culture, a grace period for occupant adaptation may take up to 3 months. Any change in temperature cooling setpoint should be small, gradual, and follow occupants' comfort feedback. Despite studies showing subjects can be comfortable at a higher temperature condition with increased air speed, in practice, occupants may perceive thermal dissatisfaction with a sharp change in room temperature setpoint (e.g., from 23 °C to 27 °C [73 °F to 81 °F]) without providing a grace period for adaptation.

For a practical implementation of a fan-integrated system, building facility managers are suggested to go slow and have patience and perseverance with the progressive transformation process. For example, if the thermal comfort analyses indicate it is possible to increase the air temperature cooling setpoint from 25 to 27 °C [from 77 to 81 °F] at higher air speed conditions with fans, in practice, the temperature setpoint shall be first increased to 26 °C [79 °F] and maintained for at least two weeks for occupant adaptation before further increasing it to 27 °C [81 °F]. In addition, occupants' feedback on the indoor environment shall be continuously monitored during the transformation period. If many thermal dissatisfaction votes have been received, a slightly lower air temperature setpoint should be used. For example, the temperature should be brought down to 25.5 °C [78 °F] to be maintained for two weeks, then raised up to 26 °C [79 °F] again.

Several studies have suggested that occupants can have a higher tolerance to thermal discomfort when provided with control of their micro-environment. Regardless of specific building functions or design intents, allowance for personal control of the fan systems is suggested.

User education

A key part of the success of any fan installation is ensuring that occupants understand the purpose and use of the fans given that, in some context is a novel solution. Presenting the changes clearly to the occupants is very important so they can be informed on how to use the new equipment and why

Occupants is very important, so they can be informed on how to use the new equipment and why modifications are being proposed. In cases with regular occupants (as opposed to spaces with transient occupants such as lobbies or event spaces) who do not have direct control over the fan operation, occupants should be informed about the purpose and operation of the ceiling fans. Ideally, spaces where occupants do not have direct control over fan operation, should also allow for flexibility so that occupants may find a location within the space that best suits their comfort preferences. In applications where occupants have access to fan controls, it is also helpful to post information or instructions encouraging occupants to adjust ceiling fan settings when they are too warm rather than resorting to reducing thermostat setpoints. Figure 56 shows an example of an information plaque with basic recommendations for user control.

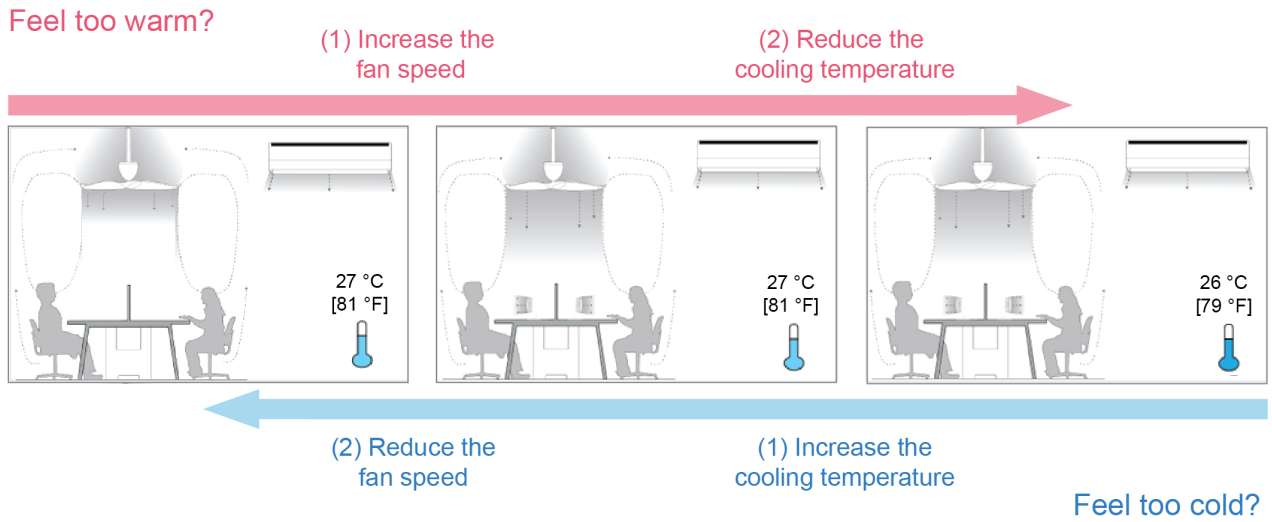

Figure 56. Example of information plaque for occupant interface and control recommendations.

Design tools

Detailed description of available design tools

CBE Thermal Comfort Tool

A helpful tool to find comfort zones at elevated air speeds according to ASHRAE 55 methodology is the [CBE Thermal Comfort Tool](#), an online tool.

The user enters temperature, air speed, humidity, metabolic rate and clothing level into the tool to calculate results including PMV, SET, and ASHRAE 55 compliance as well as generating the graph below in Figure 57. The blue shaded area represents the ASHRAE 55 compliance comfort zone while the red mark shows where the user inputs are relative to the comfort zone. The tool also supports compliance to the European thermal comfort standard EN 16798; however, this standard does not include the calculation adjustment for convection effect included on ASHRAE 55, being less favorable to estimate increased air speed effect.

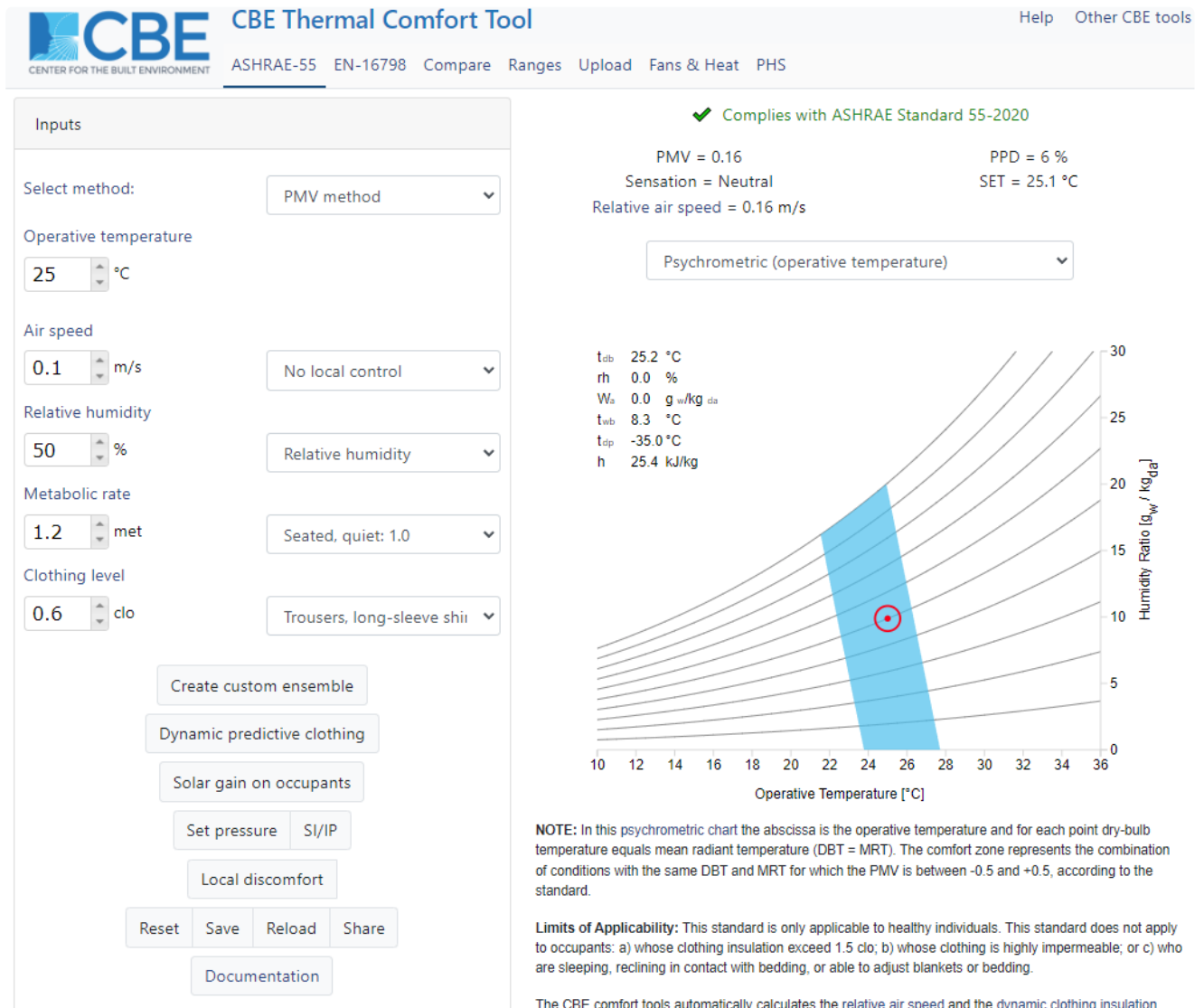

Figure 57. Example of the CBE Thermal Comfort Tool, showing user inputs, psychrometric chart, and results.

The CBE Thermal Comfort Tool also takes into account elevated air speeds. As the air speeds increase, the range of acceptable temperatures increases, and the blue shaded area shifts to the right. Using higher air speeds allows the user to ASHRAE 55 compliance at higher cooling temperature setpoints. Note that Standard 55 has a maximum average air speed permitted in the case that occupants do not have control over the system (0.8 m/s [160 fpm]). This can be specified as an input in the Thermal Comfort Tool as well. To support this functionality, users can also select the “air speed vs. operative air temperature” mode from the drop-down menu above the chart to view the comfort range and results in terms of air speed and temperature (see Figure 58).

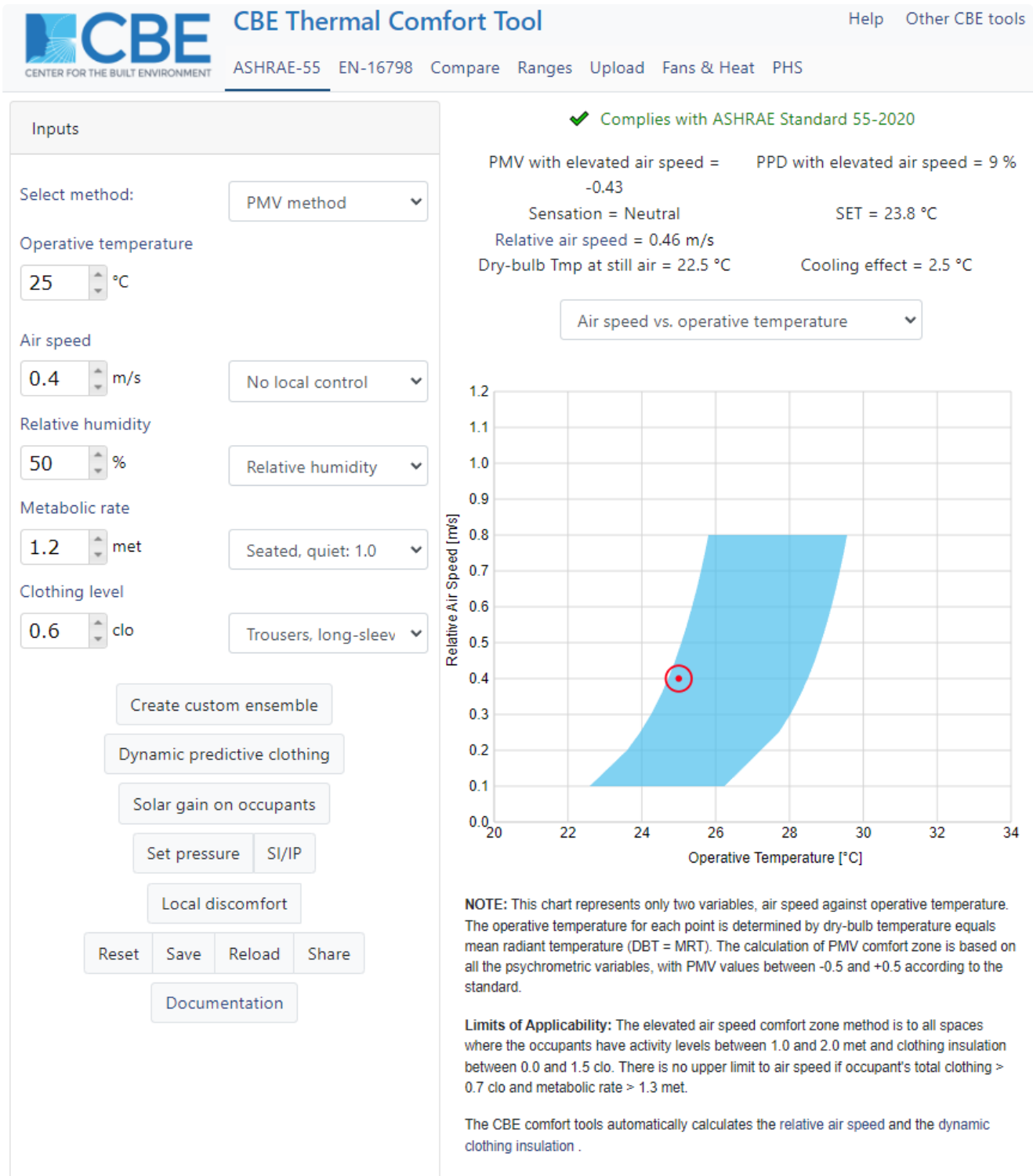

Figure 58. Example of the CBE Thermal Comfort Tool showing air speed vs. operative air temperature mode.

CBE Ceiling Fan Design Tool

To help determine optimal ceiling fan arrangements, you can use the free online [CBE Ceiling Fan Design Tool](#). The tool allows users to input room dimensions, design air speed ranges, and other parameters to determine optimal ceiling fan placement. The tool includes characteristics for a range of default ceiling fan options, or users can input specific details of other ceiling fan models to determine appropriate layouts. In addition to providing recommended fan layouts, the tool provides estimates for air speeds (minimum, average, and maximum), cooling effect (minimum and maximum), and air speed uniformity for each proposed layout (see Figure 59). The tool also provides visualizations for the overall ceiling fan plan for the space, as well as ceiling fan “cell” plan (see Figure 60) and section showing details on air speeds within each fan cell, and ideal mounting heights (see Figure 61).

The CBE Ceiling Fan Design Tool takes into account many of the design factors discussed in the previous sections. For more details on how the tool functions, please consult the online [User Guide](#). However, it is important to highlight that the tool is mainly applicable for uniform design intent and does not consider the room layout or non-uniform demands that should be taken into consideration by the designer.

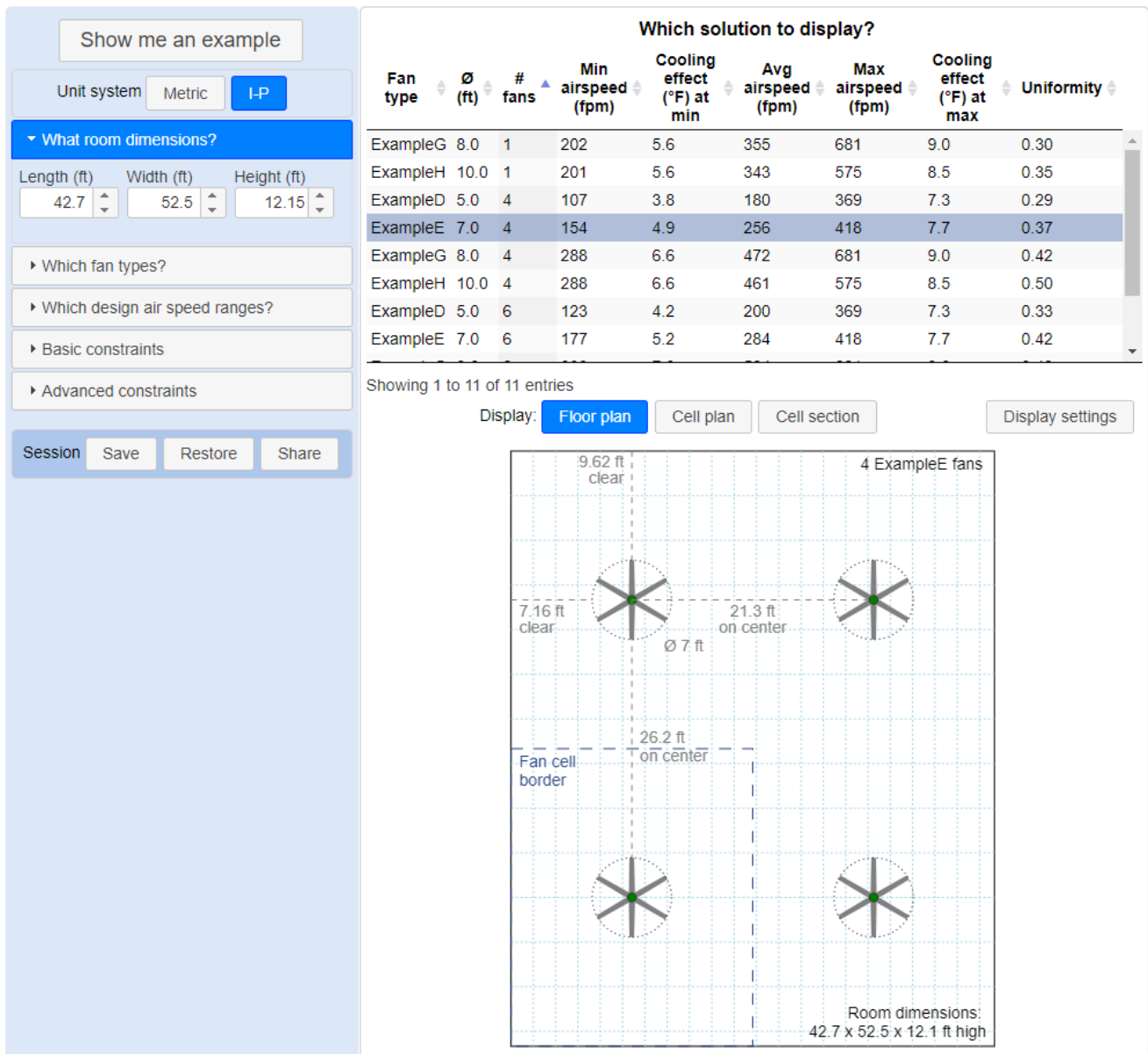

Figure 59. Example CBE Ceiling Fan Design Tool outputs.

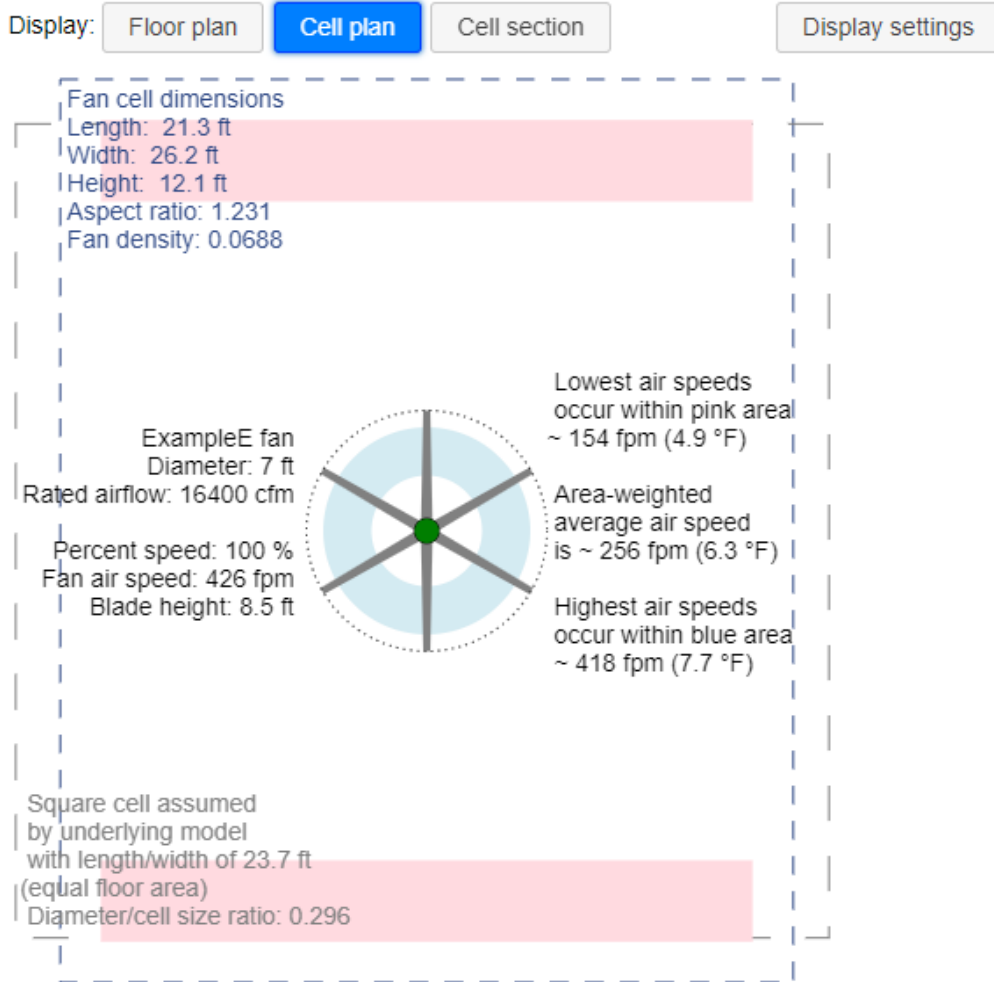

Figure 60. Example cell plan from CBE Ceiling Fan Design Tool.

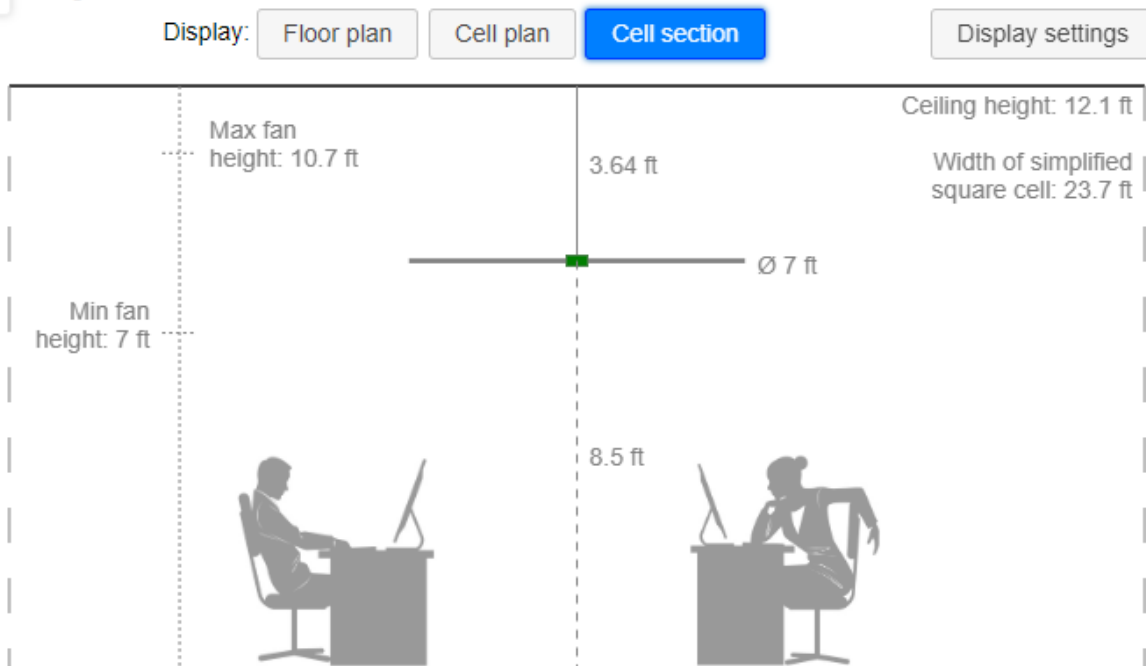

Figure 61. Example cell section from CBE Ceiling Fan Design Tool.

Modelling, simulation, and energy saving estimation

To demonstrate the energy savings potential of fans in a whole building energy model, simply increase the cooling setpoint based on the estimated cooling effect for the considered scenario, while maintaining the same heating setpoint. Models will generally show approximately a 10 % reduction in total HVAC savings per 1 °C increase in cooling setpoint [5 % per 1 °F], through a combination of cooling and associated transport energy savings (e.g., fan), as well as heating energy savings. The reason for heating energy savings is that when the cooling setpoint is higher, temperatures in the space tend to be warmer during the day than without fans, and this reduces morning warmup (and sometimes reheat) energy consumption. For rapid estimates, the [CBE Setpoint Savings Calculator](#) will estimate the energy savings for a particular location in the USA for a commercial office building based on EnergyPlus models. Figure 62 presents an example of the calculation.

CBE Setpoint Savings Calculator

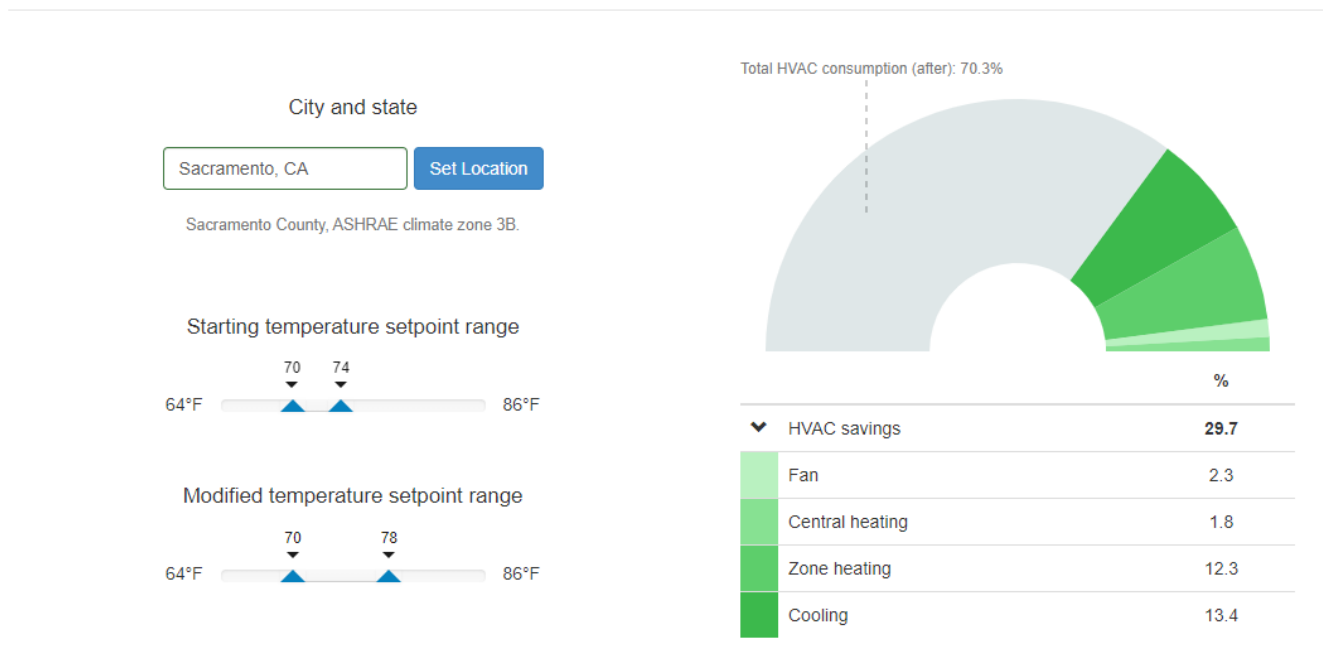

Figure 62. Example of the Setpoint Energy Saving Calculator

Codes and standards

Detailed description of codes and standards

Environmental conditions

ASHRAE Standard 55 (2020)

[ASHRAE Standard 55 – Thermal Environmental Conditions for Human Occupancy \(2020\)](#) specify the combinations of indoor thermal environmental factors and personal factors that will produce satisfactory thermal environmental conditions for a majority of the occupants within the space. The ASHRAE 55 is applicable worldwide and incorporated in other countries standards (e.g., the [Brazilian ABNT NBR 16401-2 review proposed in 2021](#))

ASHRAE 55 (2020) outlines methods to determine satisfactory thermal conditions. The analytical comfort zone method predicts the thermal sensation mean vote (PMV) of a representative occupant based on the six factors indicated in the previous section (Factors of thermal comfort). [PMV](#) is an index that predicts the average vote of thermal sensation on a scale from –3 (cold) to +3 (hot), where a score of 0 would be considered neutral condition, not too cool nor too warm. The standard defines the interval between –0.5 and +0.5 PMV as required condition to achieve thermal comfort. This model is applicable for air speed up to 0.2 m/s [40 fpm]. For higher air speed the Elevated Air Speed Comfort Zone Method should be applied. This method uses the same six factors and is defined based on the same comfortable interval of ± 0.5 PMV. However, the thermal conditions are calculated based on the Standard Effective Temperature (SET) index which is more reliable for considering the heat loss effect of increased air speed. ASHRAE 55 (2020) also includes the Adaptive Model, which is applicable for natural conditioned spaces where occupants can open and close external openings and can adjust their clothes (e.g., take of a jacket). This model considers the increment of air speed can offset the maximum temperature limits in a space.

ASHRAE 55 (2020) presents a Design Thermal Environmental Control Classification that ranks spaces with more control options in a higher level for occupant comfort. This captures the beneficial effects of increased opportunities for local and group level control of thermal comfort as indicated in Table 5. The standard also determines desk fans should have to be capable of providing air speed at the occupant's head/face/upper body within range of 0.36 to 0.8 m/s [71 to 160 fpm].

Table 5. ASHRAE 55-2020 Comfort control classification levels (CCCLs)

Thermal Environmental Control Classification Level	Required Control Measure(s) for Environmental Factors Required to Achieve Level	Informative Examples Meeting Thermal Environmental Control Classification Level
1	Each occupant is provided two or more control measures for their personal environment.	<ul style="list-style-type: none"> • Private office with a ceiling fan and an occupant adjustable thermostat • Shared office with desktop fans and seat warmers for each occupant
2	Each occupant is provided one control measure for their personal environment.	<ul style="list-style-type: none"> • Private office with an occupant adjustable thermostat • Shared office with a desktop fan for each occupant
3	The room provides multi occupant control of at least two control measures in their shared environment.	<ul style="list-style-type: none"> • Shared office with an occupant adjustable thermostat and ceiling fan control
4	The room or thermal zone provides multi occupant control of one control measure in their shared environment.	<ul style="list-style-type: none"> • Shared office with an occupant adjustable thermostat
5	No occupant control of any environmental factors	<ul style="list-style-type: none"> • Shared or private office with an occupant adjustable thermostat or no thermostat

Green Mark Scheme - Singapore

Green Mark is a green building certification scheme established by the Building and Construction Authority (BCA) tailored for tropical climate aiming to raise standards in energy performance and emphasis on other sustainability outcomes. Singapore is located in the Tropics with a yearly average outdoor air temperature around 30 °C [86 °F], which indicates a great potential for application of increased air movement.

In [Green Mark 2021: Health and Wellbeing](#) section, strategy of hybrid cooling system (i.e., increasing temperature setpoint in HVAC system with provision of elevated air speed by ceiling fans and/or individual fans) is highlighted to enhance thermal comfort in air-conditioned non-residential buildings. Thermal comfort can be achieved by controlling the temperature of conditioned air and by adjusting air speed via fans. The [Technical Guide of Green Mark for existing non-residential buildings \(2021\)](#) allows for the use of elevated temperatures in a Hybrid cooling system, with increased air speed to meet thermal comfort criteria ($-0.5 < PMV < 0.5$, and/or $PPD < 10\%$) through ASHRAE Standard 55, ISO 7730, or EN 15251 (substituted by EN 16798) methodologies. This setpoint temperature operates in the fan-integrate AC system is higher than the setpoint recommended in the [Singapore Standard 553 \(2016\): Code of practice for air-conditioning and mechanical ventilation in buildings](#), i.e., room temperature should be maintained within 23-25 °C [73-77 °F], for conventional air-conditioning (without fan) settings, meaning that energy saving through increased temperature setpoint in the HVAC system is achievable.

Ceiling fans testing regulations

In 2017, the US Department of Energy (DOE) published the [Energy Conservation Standards for Ceiling Fans \(Federal Register 82:6826\)](#). This regulation proposes a fan testing procedure to allow comparison of products based on electric input power and airflow. These test criteria are based on common industry protocols and used by fan manufacturers as the basis of published ceiling fan performance data.

Small-diameter fans: Method for ENERGY STAR qualified ceiling fans

Small-diameter ceiling fan is a ceiling fan that is smaller than (or equal to) 2.1 m [7 ft] in diameter. Performance testing on small-diameter ceiling fan is based on the [ENERGY STAR Testing Facility Guidance Manual: The Solid State Test Method for ENERGY STAR Qualified Ceiling Fans](#). This guidance provides detailed information on how to properly test the performance a ceiling fan, including the construction and preparation of the test room, equipment that are needed for the test, equipment set-up, testing procedures, and criteria in reporting test results. The qualifying fans shall meet or exceed the minimum airflow and efficiency requirements at its low fan speed (1250 CFM; 155 CFM/W), medium fan speed (2500 CFM; 110 CFM/W) and high fan speed (5000 CFM; 75 CFM/W).

Large-diameter fans: AMCA Standard 230

Large-diameter ceiling fan is a ceiling fan that is larger than 2.1 m [7 ft] in diameter. Performance testing on larger-diameter ceiling fan is standardized by the [Air Movement and Control Association \(AMCA\) Standard 230-15: Laboratory Methods of Testing Air Circulating Fans for Rating and Certification](#). Similarly, this standard provides a protocol and testing conditions to assess the performance of different fan models, in particular determining and expressing ceiling fan efficiency and efficacy. The fan efficiency, adopted by Department of Energy (DOE) in the United State of America, is calculated using a weighted average of data collected in standby model and up to five available fan speed (if five speeds are tested, each speed is assumed 20% of the daily operating hours). Similar approaches could be applied to other countries as an additional instrument for estimating fans' energy consumption and efficiency. The equation for the DOE efficiency is presented below:

$$DOE \text{ Efficiency } \left(\frac{CFM}{W} \right) = \frac{\sum_i Air\ flow_i \cdot OH_i}{W_{sb} \cdot OH_{sb} + \sum_i W_i \cdot OH_i}$$

where: $Air\ flow_i$ = Airflow at speed i, OH_i = Operating hours at speed i, W_i = Power consumption at speed i, OH_{sb} = Operating hours in standby mode, W_{sb} = Power consumption in standby model.

A major consideration in using the DOE metric is when the fan operates at a very low speed. Power consumption is proportional to the cube of flow rate. Therefore, slowing down a fan would reduce the input power and airflow, but the reduction in input power is higher than airflow. Low airflow fans with inefficient motors can still achieve high DOE metric values. Conversely, high airflow fans (at the same diameter), even equipped with more efficient motors, are more difficult to comply with the DOE metric.

Large-diameter fans: Ceiling Fan Energy Index (CFEI)

Since 2021, the Ceiling Fan Energy Index (CFEI) has been used to make inefficient fans less likely to comply using slower speeds, such as those used to game the DOE (CFM/W) metric and to remove the unintentional barrier to compliance for high-performing high-utility fans. CFEI is derived from the FEI equation in [ANSI/AMCA Standard 208-18: Calculation of the Fan Energy Index](#) with substitute coefficient of airflow constant: $Q_0 = 12.5\ m^3/s$ (26500 CFM), pressure constant: $P_0 = 0.67$ pascals (0.0027 inches water gauge), and fan-efficiency constant: $\eta_0 = 42\ \%$. CFEI is calculated as a ratio of a reference fan's electrical input power to the actual fan's electrical input power. The equation is presented below:

$$CFEI = \frac{\text{Reference Ceiling Fan Electrical Input Power}}{\text{Actual Ceiling Fan Electrical Input Power}}$$

The reference fan is a conceptual fan that relates all fans to a common baseline, producing the airflow and fan pressure required at a specified electrical input power. According to the standard, large-diameter ceiling fans should have a CFEI greater than or equal to: (a) 1.00 at high (i.e., 100 %) fan speed and (b) 1.31 at 40 % of fan speed.

ASHRAE Standard 216

[ASHRAE Standard 216: Methods of Test for Determining Application Data of Overhead Circulator Fans](#) aims to provide standardized performance data for the application of overhead circulation ceiling fans in indoor spaces. The room air speed distribution test results can be used to calculate occupant thermal comfort and to demonstrate compliance with the thermal comfort requirements of ASHRAE Standard 55. This standard includes requirements for test instrumentation, the features of test rooms, and measurement procedures. It also includes calculation procedures for several performance metrics relevant to thermal comfort application of overhead circulator ceiling fans such as uniformity, room average cooling effect, heating draft risk, and comfort cooling efficacy.

This standard provides a consistent industry-standard practice for determining ceiling fan performance characteristics. Manufacturers can use Standard 216 test procedures to test their products and provide standardized performance data for use in specification and simulation of fan performance. Standard 216 test procedures should also be used for any full-scale fan test mock-ups. In conjunction with the Design Thermal Environmental Control Classification of ASHRAE Standard 55, this standard supports the implementation of ceiling fans as an option for thermal comfort control in buildings.

Fire safety and installation

Fire code requirements

The primary concern with ceiling fans in relation to the fire code is the interaction with fire sprinklers. For the most part, standard ceiling fans in typical residential and non-residential applications have few limitations in relation to fire sprinklers, while large-diameter ceiling fans require a higher degree of integration with fire suppression systems.

The California Fire Code (Title 24, Part 9) cites the requirements of the National Fire Protection Association's NFPA 13, "[Standards for the Installation of Sprinkler Systems](#)" and NFPA 13R, "[Standard for the Installation of Sprinkler Systems in Low-Rise Residential Occupancies](#)" govern the use of fire sprinklers in buildings.

Per NFPA 13, for ceiling fans less than 1.5 m [60 in] in diameter where the blades are less than 50 % of the swept area in plan view, fire sprinklers can be located without regard to the fan blades (Ref: NFPA 13 2016 sections 8.6.5.2.1.10, 8.7.5.2.1.6, 8.8.5.2.1.9, 8.9.5.2.1.6; NFPA 13 2019 sections 10.2.7.2.1.10, 11.2.5.2.1.9, 12.1.10.2.1.9). Since the above requirement specifically calls out "fan blades," there may be cases where other parts of the ceiling fan, such as motor housing or mounting pendants (or fan blades that are less than 50% open in plan view), are considered obstructions to fire sprinklers. In most cases, for any motor housing, mounting pendant, or other part of the fan that is 46 cm [18 in] or less below the level of the sprinkler deflector, the so-called "rule of three" applies, where sprinklers must be placed away from the obstruction a minimum distance of three times the maximum dimension of the obstruction, up to 61 cm [24 in] (Ref: NFPA 13 2016 section 8.6.5.2.1.3; NFPA 13 2019 section 10.2.7.2.1.3). In other words, if the motor housing of a ceiling fan is 18 cm [7 in] in diameter, any fire sprinklers should be located at least 53 cm [21 in] from the motor housing. In the 2019 version of NFPA 13, for extended coverage sprinklers and residential sprinklers, this requirement is increased to a distance of four times the maximum dimension of the obstruction, up to 91 cm [36 in] (Ref: NFPA 13 2019 sections 11.2.5.2.1.3 and 12.1.10.2.1.3).

NFPA 13R requirements are more explicit about sprinkler locations in relation to obstructions such as ceiling fans. In these cases, the standards require pendant sprinklers to be a minimum of 1 m [3 ft] from any ceiling fan (Ref: NFPA 13R 2016 and 2019 section 6.4.6.3.4.1), and sidewall sprinklers to be at least 1.5 m [5 ft] from any ceiling fan (Ref: NFPA 13R 2016 and 2019 section 6.4.6.3.5.1). Though the standards do not explicitly state where those distances are measured from, this is typically interpreted as being the distance from the center point of the ceiling fan.

For larger format fans, NFPA 13 lays out more detailed requirements: (1) Fans must be no more than 7 m [24 ft] in diameter; (2) Each fan must be approximately centered between four adjacent sprinklers; (3) The vertical distance from fan blade to sprinkler deflector must be at least 1 m [3 ft]; and (iv) All fans must be interlocked to shut down immediately upon receiving a waterflow signal from the alarm system in accordance with the requirements of NFPA 72.

The California Fire Codes also specify that smoke alarms and smoke detectors shall not be installed within a 36-inch (91 cm) horizontal path from the tip of the blade of a ceiling-suspended (paddle) fan unless the room configuration restricts meeting this requirement (907.2.11.8)

While this section covers requirements as they apply in the California Fire Code, adapted from NFPA Standards, specific requirements may vary by local jurisdiction. Always consult local codes for requirements for a specific project.

Seismic requirements

In many applications, standard ceiling fans attached directly to a structural ceiling do not require any further seismic bracing or restraint. However, applications with large-diameter ceiling fans, suspended ceilings, long suspension rods, or other special conditions may require additional seismic support.

Seismic considerations and requirements are especially relevant for installations of ceiling fans in California. Per the California Building Code, non-structural components that are permanently attached the structure, such as ceiling fans, must be installed to resist the effects of earthquake motions in accordance with the ASCE 7 standard (from the American Society of Civil Engineers, [California Building Code, 2016](#), Part 2, Vol 2, Section 1613.1). The exact requirements in ASCE 7 will vary depending on the size, weight, and configuration of the fan, the strength of the expected seismic forces for the area, and the building type where it is installed.

In addition to the specific requirements in ASCE 7, there are some general best practices for all applications and scenarios. The Federal Emergency Management Agency's (FEMA) document, "[Reducing the Risks of Non-structural Earthquake Damage – A Practical Guide](#)" recommends that all suspended fixtures, such as lighting and ceiling fans, have positive attachment to the structure to avoid falling hazards. Ceiling fans should never be supported on a suspended ceiling grid or ceiling tile. In addition, the [California Department of the State Architect \(DSA\)](#) has issued code interpretations pertaining to suspended fixtures such as ceiling fans, stating that fixtures with rigid suspension pendants must be attached to the structure using a device allowing movement in any direction (i.e., a ball and socket joint) ([DAS IR 16-9](#)) and requiring bracing where any pendant fixture passes through a suspended ceiling ([DAS IR 25-2](#)). Some manufacturers also suggest lateral restraint using guy wires that are at least 6.35 mm [0,25 in] in diameter for large-diameter fans. Again, it is important to consult local building codes to determine specific requirements.

Energy information label for ceiling fan

The Energy Protection Act (EPA) requires any ceiling fan to be tested in approved laboratory before it can be sold in the United States. The airflow and corresponding wattage at different operating speeds of the ceiling fan will be tested. Thereafter, the fan will be given an airflow rating (cubic feet per min), electricity use rating (watt, excludes lights), and an airflow efficiency rating (cubic feet per minute per watt). All the numbers will be printed on an energy Information label outside the fan packaging. This label helps the fan buyers to clarify the efficiency of fan products and to compare their needs between fan types.

Case studies for practitioners

These studies highlight the energy and occupant performance in real buildings that installed with ceiling fans

Coastal Biology Building

Ceiling Fans Case Study



Photo: Michael David Rose



Photo: Michael David Rose

OVERVIEW

Location: Santa Cruz, CA

Project Size: 40,000 ft²

Construction Type: New Building

Completion Date: 2017

Building Type: University Campus

Climate Zone: 3C

Total Building Cost: \$54 million

Owner: UC, Santa Cruz

Architect: EHDD

General Contractors: Swinerton Builders

Structural Engineer: Mar Structural Design

Mechanical Engineer: Taylor Engineering

Civil Engineer: GHD Engineering

Thoughtful design of a world-class research facility highlights the benefits of ceiling fans in naturally ventilated spaces in ensuring occupant thermal comfort in educational settings.

COASTAL BIOLOGY BUILDING

The Coastal Biology Building brings together faculty and staff to support research and teaching on ecology and evolutionary biology. The LEED Gold Certified building is set on a 97-acre site with easy access to wetlands and other important natural habitats for field-based learning. The University of California, Santa Cruz worked with EHDD to deliver world-class facilities for marine and ocean health research located near the Monterey Bay National Marine Sanctuary.

The two-story building is a state-of-the-art facility that includes a 125-seat classroom and two smaller classrooms, 20 primary research laboratories, a core seawater laboratory, seminar and meeting rooms, and 43 research offices. The HVAC systems for many spaces in the building, including the main lecture hall, function without compressive cooling. The integrated facade strategy uses electrochromic glazing, operable windows, and easy-to-operate ceiling fans to ensure above-average occupant comfort in warmer temperatures in summer. The success of this strategy is reflected in the building earning a perfect score in the LEED Indoor Environmental Quality category.

Energy Performance

In keeping with the sensitive nature of the site, the building was designed with a context-appropriate agricultural vernacular with an emphasis on low energy use. The whole building site energy use intensity (EUI) of just 105 kBtu/ft² is 50% less than the average EUI performance of 118 laboratory and college buildings in the 3C climate zone within a federal database of over 230,000 buildings. This places the building in the top 25% of that dataset in terms of energy performance (Figure 1). In addition, it exceeds the best-practice targets in ASHRAE’s Standard 100-2015 Energy Efficiency in Existing Buildings. The use of efficient high-volume, low-speed ceiling fans helped to ensure that the cooling systems consume only 1% of predicted electricity energy of the building.

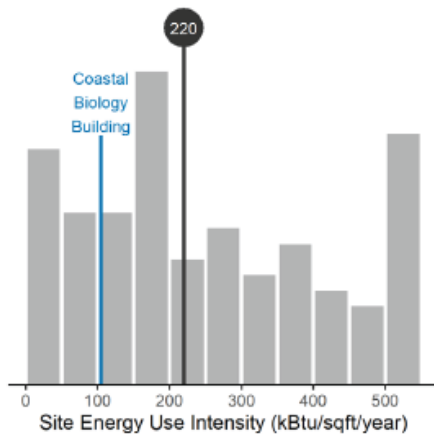

Figure 1. Energy use for both the main building and greenhouse is below 75% of laboratory and college buildings from the same climate zone in the Building Performance Database (BPD). The Site EUI of 105 is over 50% less than the mean EUI of 220.

Thermal Comfort

From the outset, Taylor Engineering wanted to pursue low-energy options to cool the mixed-use building. The cool coastal climate of the campus allowed them to design the HVAC system for the seminar space using an efficient single-zone air handler without a cooling coil. The seminar room has a ductless HVAC design, made possible by the use of ceiling fans to mix the air throughout the room and uniformly cool the occupants. Survey results show occupants’ thermal satisfaction is well above that of comparable buildings in the CBE database (Figure 2). Figure 3 shows the mean score on the seven-point satisfaction scale was +0.8, well above the thermal comfort benchmark of +0.2 in the 112 classrooms and laboratories in the CBE database, placing it in the top 15% of buildings in that dataset.

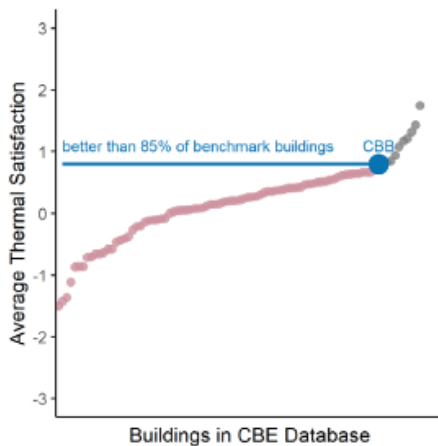

Figure 2. Satisfaction with the thermal environment at CBB is higher than 85% of classroom and laboratory buildings in the CBE Occupant Survey database.



Figure 3. 60% of occupants in the Coastal Biology Building (CBB) rated their indoor temperature as satisfactory. The mean thermal satisfaction vote of +0.8 places it in the top 15% of classrooms and laboratories for thermal comfort in the CBE Occupant Survey database.



This case study is part of a project focused on energy and occupant factors within the larger study of Integrating Smart Ceiling Fans and Communicating Thermostats to Provide Energy-Efficient Comfort. It is being led by Paul Raftery at UC Berkeley Center for the Built Environment (CBE) and funded by the California Energy Commission (EPIC Project 16-013).

Ceiling Fans Case Study



Photo: Nic Lehoux

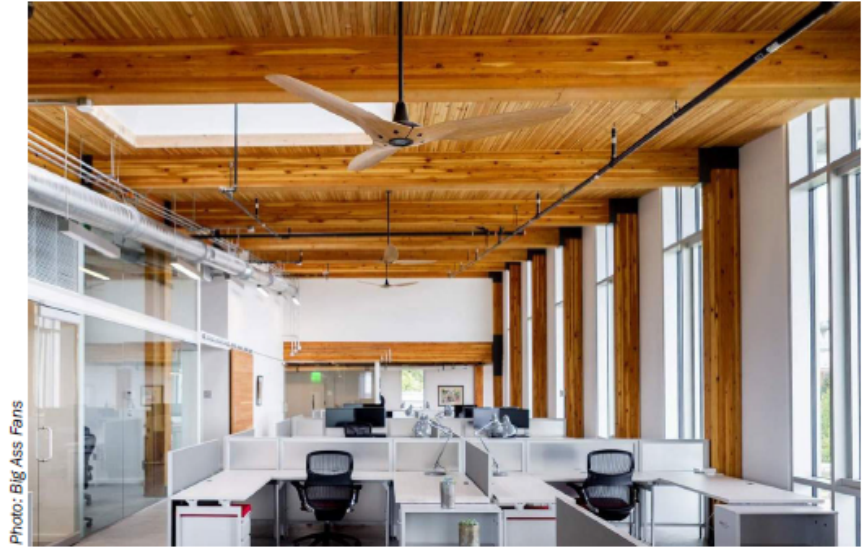

Photo: Big Ass Fans

OVERVIEW

Location: Seattle, WA
Project Size: 52,000 ft²
Construction Type: New Building
Completion Date: 2013
Fully Occupied: 100%
Building Type: Office
Climate Zone: 4C
Total Building Cost: \$32.5 million

Owner: Bullitt Foundation
Architect: Miller Hull Partnership
Development Partner: Point32
General Contractors: Schuchart, Foushee
Structural Engineer: DCI Engineers
MEP Engineering: PAE
Civil Engineer: Stantec
Commissioning: Keithly Barber Associates
Solar Team: Northwest Wind and Solar
Water Systems: 2020 Engineering
Landscape Architect: Berger Partnership

Ceiling fans are a key part of the strategy in achieving world-class commercial building performance and delivering a comfortable indoor environment for office workers.

THE BULLITT CENTER

The Bullitt Foundation, a nonprofit philanthropic organization with a focus on the environment, worked with local real estate firm Point32 to deliver a building at the cutting-edge of sustainable architecture. The building was the vision of CEO Denis Hayes to create “the greenest urban office building in the world”, receiving the Sustainable Building of the Year award from World Architecture News in 2013.

The building uses a mixed-mode cooling, heating and ventilation strategy. To help meet the low energy targets, ceiling fans were combined with automated windows for passive cooling and to provide natural ventilation and fresh air. Fans use only 2% of end use energy but allow higher cooling setpoints to reduce HVAC reliance. This system was estimated to offset about 750 hours of annual cooling. Occupants use the fans to provide thermal comfort and ensure the building operates sustainably. The result is far above average thermal satisfaction and world-class energy performance.

Energy Performance

The Bullitt Center was designed to have exceptionally low energy use to meet zero net energy targets and Living Building Challenge standards. The whole building site Energy Use Intensity (EUI) of just 10 kBtu/ft² is over 80% less than the average EUI performance of 1,142 offices in the 4C climate zone within the Building Performance Dataset (BPD). This places it in the top 2% of those buildings in terms of energy performance (see Figure 1). While that dataset includes a mix of construction age, the Bullitt building's energy use is also significantly lower than a new code building in the same year, and best-practice in ASHRAE's Standard 100-2015 Energy Efficiency in Existing Buildings by approximately 70%. The mechanical engineers used efficient ceiling fans to help reduce HVAC energy and meet the ambitious design goals.

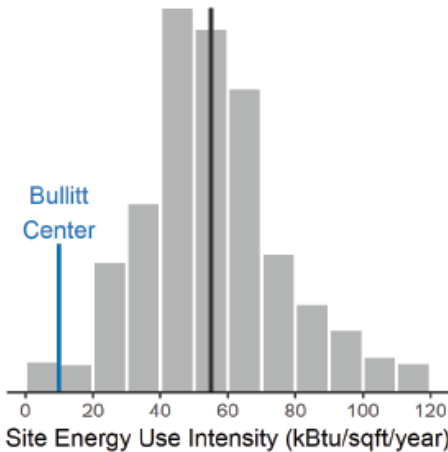

Figure 1. The Bullitt Center is placed in the top 2% of office buildings from the same climate zone in the BPD. The Site EUI of 10 is over 80% less than the mean EUI of 55.

Thermal Comfort

Aiming for low energy use targets required PAE Consulting Engineers to think creatively about ways to reduce HVAC energy consumption. Sensors and controls coordinate the windows to optimize thermal comfort and outside air, thereby reducing reliance on mechanical cooling. The use of ceiling fans help to lower energy use and enhance occupant comfort by cooling occupants much quicker than a centralized system can. The results of the thermal comfort survey show a 50% increase in occupant satisfaction with the temperature over the average building in the CBE database (see Figure 2). The mean score on the 7-point satisfaction scale was +0.8, well above the thermal comfort benchmark of 0.0 in the 500 offices in the CBE database, placing it in the top 15% of commercial office buildings in that dataset.



Photo: Nic Lehoux

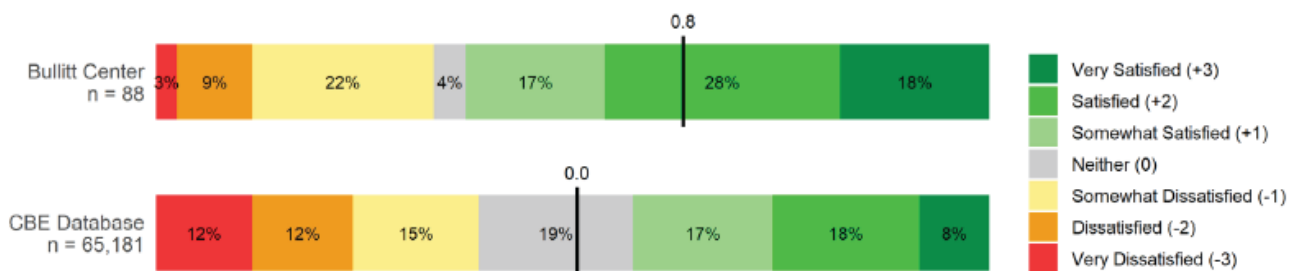

Figure 2. Over 60% of occupants in the Bullitt Center rated their indoor temperature as satisfactory. The mean thermal satisfaction vote of 0.8 places it in the top 15% of commercial office buildings for thermal comfort in the CBE Occupant Survey database.



This case study is part of a project focused on energy and occupant factors within the larger study of Integrating Smart Ceiling Fans and Communicating Thermostats to Provide Energy-Efficient Comfort. It is being led by Paul Rafferty at UC Berkeley Center for the Built Environment (CBE) and funded by the California Energy Commission (EPIC Project 16-013).

Ceiling Fans Case Study



Photo: Community Preservation Partners



Photo: Dana Miller

OVERVIEW

Location: Stockton, CA

Project Size: 50,565 ft²

Construction Type: Renovation

Completion Date: 2007

Fully Occupied: 112 units

Building Type: Senior Living Facility

Climate Zone: 3B

Owner: WNC & Associates

Energy retrofits of a senior living facility shows how ceiling fans integrated with air conditioning can deliver thermal comfort improvements and energy savings for community housing.

FRANCO CENTER

The Franco Center Apartments is a five story senior living facility in Stockton, CA. Constructed in 1967 and renovated in 2007, it is built of solid concrete masonry with no additional insulation. The first floor is made up of retail spaces, community rooms for the residents, and office space for staff. The residential spaces occupy the second through fifth floors, with studios and 1-bedroom units on floors two through four, and 2-bedroom units on the fifth floor.

The Franco Center is located in a hot climate, where the ASHRAE 1% summer design conditions are 97.9° F. Thirty-five ceiling fans were installed in the common areas of the building to demonstrate how smart ceiling fans with on-board sensors for occupancy and temperature can reduce energy usage and increase thermal comfort in flexible mixed-use spaces. Elevated air speeds from the fans improved occupant comfort, allowing thermostat cooling setpoints to be increased to save HVAC energy use. This project demonstrates how simple retrofits can deliver impressive results for both energy and comfort.

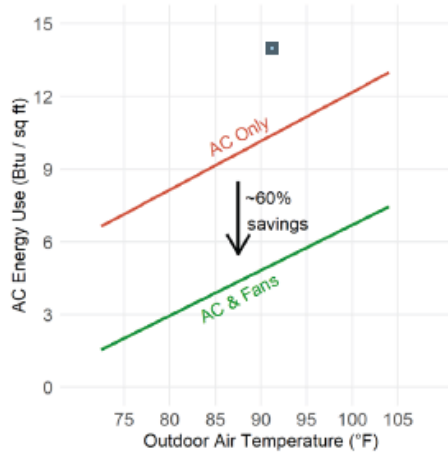

Figure 1. HVAC energy use in the common room was reduced by 60% by raising setpoints and using fans to cool occupants when temperatures were above 74 °F. Source: Dana Miller.



Photo: Dana Miller

Energy Performance

The first-floor common room is served by two compressors and nine fan coil units with a total capacity of approx 400 MBtu/hour. Cooling setpoint temperatures were increased by 5-8 °F to 76 °F after the ceiling fans were installed. Electricity monitoring equipment established baseline energy use before and after the fan installation. Measurements over two summers (Figure 1) show air conditioning energy use increased with outdoor air temperature as expected. The same relationship was seen after installing the ceiling fans, but the total energy use decreased by approx 60% on average. This saved approx \$1000 per month in electricity during summer. These savings were achieved by extending the temperature deadband, made possible by coordinating the fans and air conditioning to maintain or improve comfort.

Thermal Comfort

Thirty-five ceiling fans were installed in the common room in a grid arrangement to ensure even distribution of air speeds. They were programmed to start at 74 °F during occupancy, while the air conditioning was changed to start at approximately 76 °F. Thermal comfort surveys were completed by occupants before and after the ceiling fans were installed. Figure 2 shows 92% of surveyed occupants reported being comfortable at 80 °F with the ceiling fans running. This is an improvement in thermal comfort over the earlier survey without the fans, even though the temperature in the common room was 8 °F warmer. This demonstrates that cooling setpoints can be higher while providing similar or improved occupant comfort by using efficient ceiling fans, substantially reducing energy use and cost.

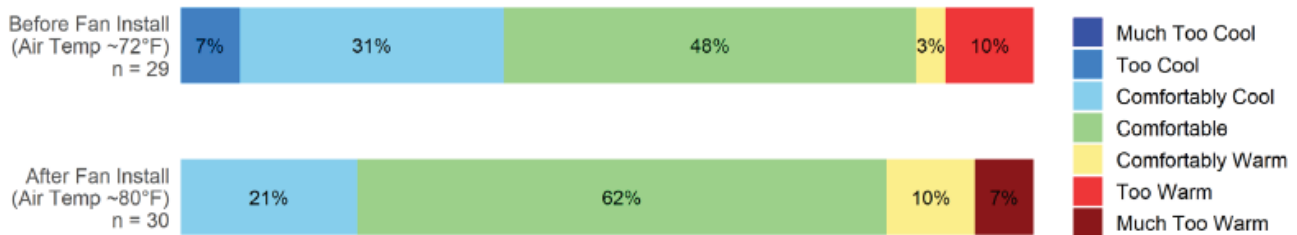

Figure 2. Over 90% of surveyed occupants in the Franco Center Apartments rated their indoor environment as comfortable after the ceiling fans were installed. This is an increase in occupant comfort from the earlier survey even though it was 8 °F warmer. Source: Dana Miller.

Case studies for researchers

These scientific research-based studies inform what we have learnt in buildings that installed with fans

Most studies of ceiling fans have been performed in laboratories, but there are some studies performed in buildings. We discuss them in this section to provide useful information about the application of fans in realistic conditions.

Air speed measurement in 4 commercial buildings in California

Background

This study conducted a detailed assessment of air speed performance by ceiling fans in 4 commercial buildings in California. Different ceiling fan operation modes such as fan rotational speed, operating direction, and the number of operating fans were considered; aiming to demonstrate the magnitude and distribution of air speed, cooling effects, and any potential influencing factors in commercial building settings. Detailed of this field study is available in this paper ([Luo et al., 2021](#)).

Study methods

Field measurements of air speed were conducted in 4 commercial buildings installed with ceiling fans between May 2018 and March 2020. Table S1 summarizes the buildings and ceiling fans characteristics tested in this study. In each site, air speed from ceiling fans was measured with different operation modes, including airflow directions (upward and downward), fan speed levels (high, medium, and off), and the number of operating fans at the same time. Air speed was measured typically at occupied locations with four heights from floor level (i.e., 0.1 m, 0.6 m, 1.1 m, and 1.7 m [0.3, 2, 3.6 and 5.6 ft]). The cooling effect provided by the ceiling fan was estimated.

Table S1. Tested buildings and ceiling fans information.

Buildings (abbreviation)	San Francisco PAE engineering office (PAE)	Santa Cruz biology seminar room (SC)	Franco Community Center (FC)	Sacramento Municipal Utility District office (SMUD)*
Field scene				
Total floor area, m ² / ft ²	227 / 2441	156 / 1681	367 / 3968	344 / 3700
Fan diameter (D), m / ft	2.44 / 8	2.44 / 8	1.52 / 5	1.52 / 5
Fan type (brand)	ESSENCE	ESSENCE	HAIKU	INDUSTRIAL
Maximum fan rotational speed (N _{max}), rpm	158	158	200	247
Maximum airflow through the fan blades (Q _{max}), m ³ /s / cfm	16.6 / 35112	16.6 / 35112	4.1 / 8629	4.5 / 9602
Fan blade swept area (AF), m ² / ft ²	4.7 / 50.3	4.7 / 50.3	1.8 / 19.6	1.8 / 19.6
Number of running fans	All on	1	4	7
	1/2 on [#]	---	2	---
	1/3 on [#]	---	---	---
Average area served by each fan (A), m ² / ft ²	All on	226.8 / 2441	39.1 / 420.4	49.1 / 528.5
	1/2 on	---	78.1 / 840.7	---
	1/3 on	---	---	---

* The SMUD building results have already been reported in [26], and its measurement sensor density was lower than the other three buildings, as such, we did not include it in the detailed analysis for individual buildings. However, it is included later when combining data.

Air speed distribution overview

The height averaged air speed superimposed on floor plans with the ceiling fan layout and furniture in the 4 buildings (see Figure S1). In general, higher air speeds were found under or near the downward operating ceiling fan and decreased proportionally to the distance from the fans. Potential factors that vary the air speed are fan diameter, number of fans in operation, distance from ceiling fan centers, fan rotational speed, and fan operation direction.

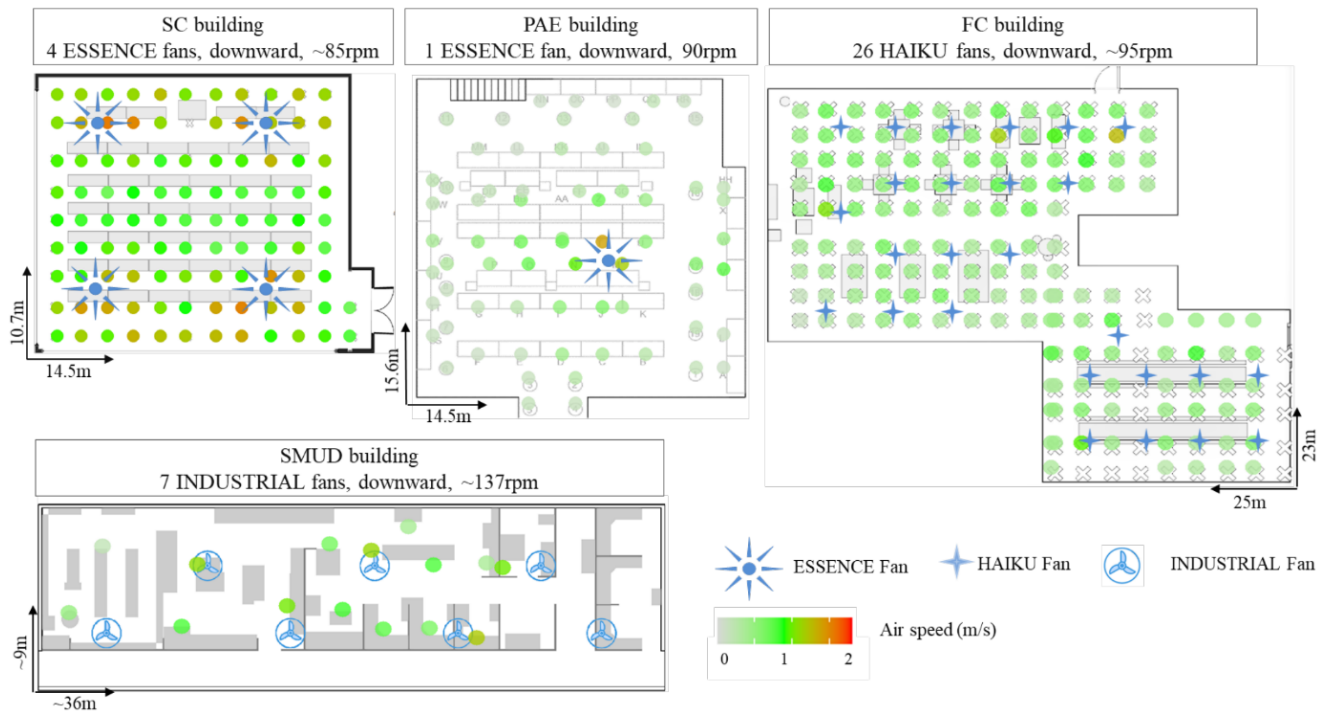

Figure S1. Floor plan and air speed distribution in the 4 tested buildings. The magnitude of air speed at each site is averaged by heights.

Flow direction, rotational speed, and fan number

Figure S2 demonstrates the air speed performance under different test conditions. Ceiling fans operating in the downward direction produced higher mean air speeds (0.2-1.8 m/s [40-350 fpm]) than the upward direction (0.2-0.5 m/s [40-100 fpm]). However, a more uniform airflow within the occupied zone was found when fans are blowing upwards (i.e., smaller variation in air speed distribution). The variation of air speeds is mainly influenced by measurement height. Generally, fans operating downwards create negative vertical gradients (i.e., air speed the fastest at ankle height and the slowest at head height), while a positive gradient is observed directly under the fan. In contrast, upwards operating fans provide higher air speed at the head height of occupant than at the ankle level, but a negative gradient is observed in the return air path (e.g., near walls or at the confluence of airflows with multiple fans). Priority should be given to downward blowing fans if the thermal comfort design requirements are to maximize cooling efficiency in space, or to minimize energy consumption. Conversely, upward blowing fans allow better airflow uniformity across vertical and horizontal dimensions. In addition, designers should pay attention to the fan blade design (with symmetrical blade geometry or inverted installation fan) if the fans are intended to operate upward in the design stage.

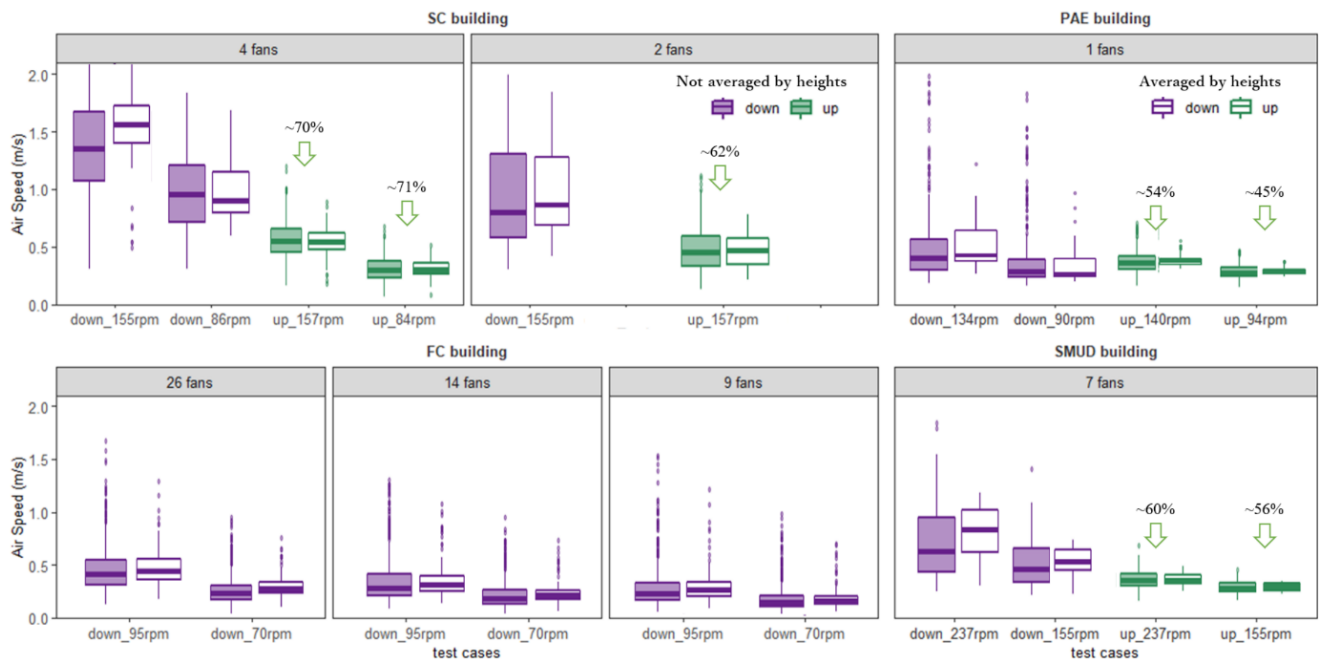

Figure S2. Air speed distribution at 4 sites for different (i) operating directions (downward – purple; upward – green); (ii) fan rotational speed; (iii) operating fan number (if available); and (iv) before and after averaging by heights.

As described earlier in this guide, air speed generated by ceiling fan increases linearly with the fan rotational speed. The field measurement also confirmed higher mean air speed in all sites when ceiling fans are operating at higher speed. In addition, when ceiling fans were rotating at higher speed, the resulting air speed was found dispersed in wider range, meaning that a larger air speed gradient was created regardless of airflow direction.

The SC and FC buildings allow air speed measurement with reduced number of fans in operation. Results showed the mean air speed is positively proportional to the square root of the number of operating ceiling fans. For the SC building, the mean air speed dropped by 32 % when reducing 4 fans to 2 fans. For the FC buildings, the mean air speed decreased by 15-25 % and 23-46 % when reducing 26 ceiling fans to 14 and 9 fans respectively.

Cooling effect

Cooling effect is the temperature reduction (in °C or °F) perceived by the occupant with elevated air speed compared to the condition without air movement under the same temperature. Figure S3 summarizes the magnitude of cooling effect for each testing condition and building. At the same rotational speed, the cooling effect with upward flow (1-2 °C [2-4 °F]) was lower than the downward flow condition (2-4 °C [4-7 °F]), resulting in a 19-76 % reduction, especially with increased number of operating ceiling fans within the space. The uniformity of the cooling effect depends on the layout and number of the operating fans. The highest cooling effect was found under the operating fans and generally reduced as the distance from the fan increased. These are important findings since one ultimate function of ceiling fan is to offset the thermal sensation of increasing the cooling setpoint temperature in air-conditioned space.

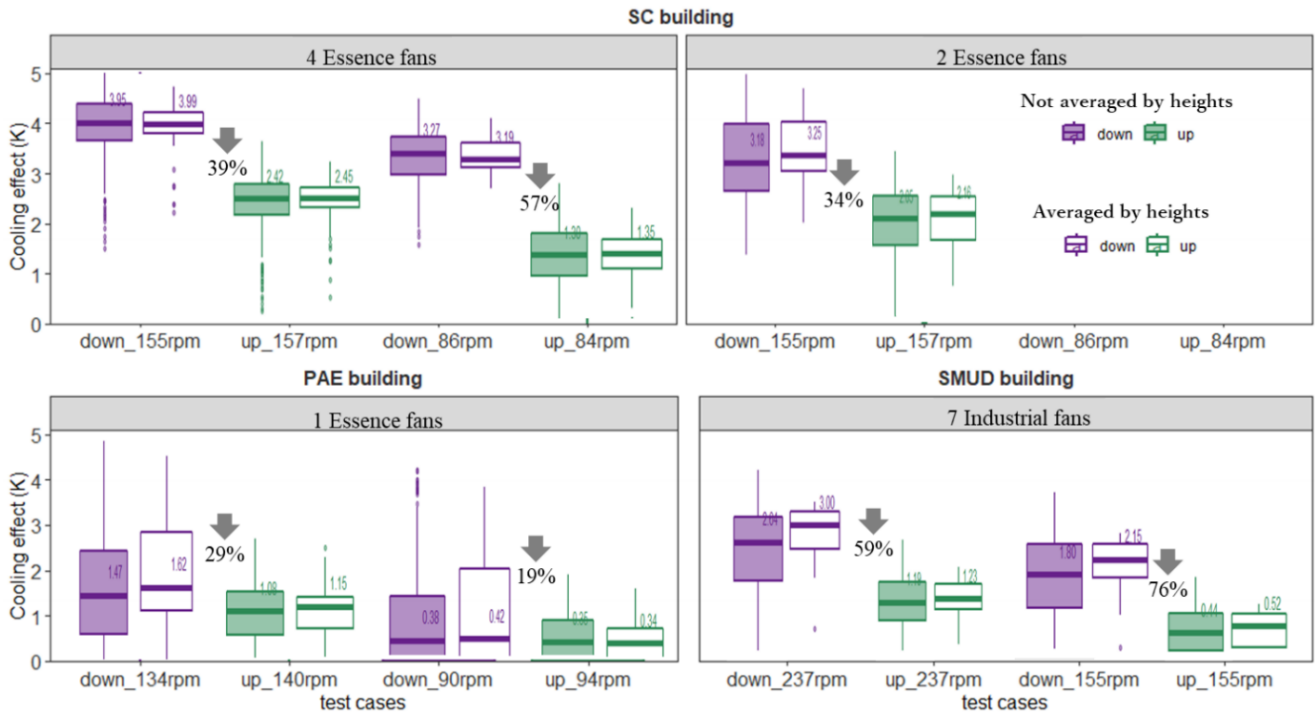

Figure S3 Cooling effects in different test conditions and buildings. Characteristics of the plot are the same as describing in Figure S2

Multiple fan interaction

The room's air speed magnitude and its distribution are affected by multiple ceiling fans operated simultaneously. Figure S4 shows the air speed contours when three fans were arranged linearly (left) or diagonally (right) with the same space. The three grey lines represent the air speed measurement horizontally every 0.2 m [0.6 ft] and vertically at 0.1, 0.6, 1.1, and 1.7 m [0.3, 2, 3.6, 5.6 ft] distance. For each fan arrangement (i.e., linear or diagonal), the average air speeds among the three sections and the percentage of low (< 0.3 m/s [60 fpm]), medium (0.3 - 1.2 m/s [60 - 240 fpm]), and high (> 1.2 m/s [240 fpm]) air speed is presented. The results suggest multiple fans operated at diagonal layout could provide higher average air speed (0.54 m/s [105 fpm]) and higher percentage of medium air speed (72.3 %), resulting in more uniformity of air speed than fans arranged at linear layout.

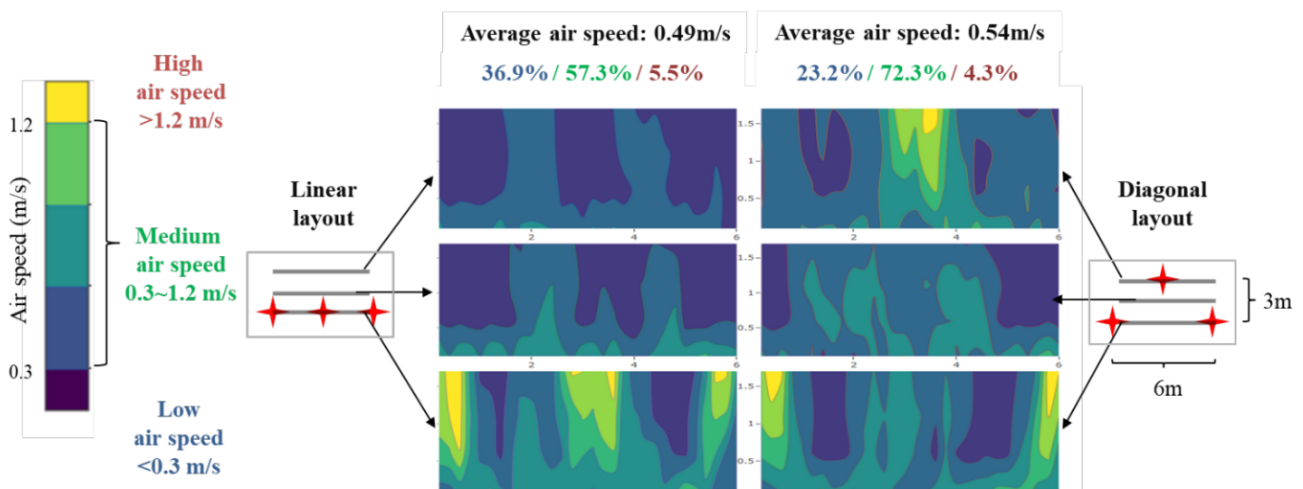

Figure S4 Air speed distribution for linear and diagonal ceiling fans operation layout.

Effects of furniture

Furniture is an important aspect for elevated air speed by ceiling fans design in real buildings. Lower average air speed was found at on-site measurement when compared to the simulated air speed profile using the CBE Ceiling Fan Design Tool for similar fans and room configuration setting. It suggested that presence of furniture in space would impede the air movement path in real buildings, leading to overestimation of air speed in the simulation model. An increased percentage of furniture in space would reduce the actual air speed performance, leading to larger differences between the predicted and measured air speeds. In addition, furniture also affects the vertical profile of air speed. Figure S5 compares the on-site average air speed with and without tables at four measurement height. It showed the presence of tables blocked downward-moving air from the ceiling fan, resulting in faster air speed (0.05 - 0.1 m/s [10 - 20 fpm]) above table level, but lower air speed (0.24 m/s reduction [47 fpm]) at ankle height.

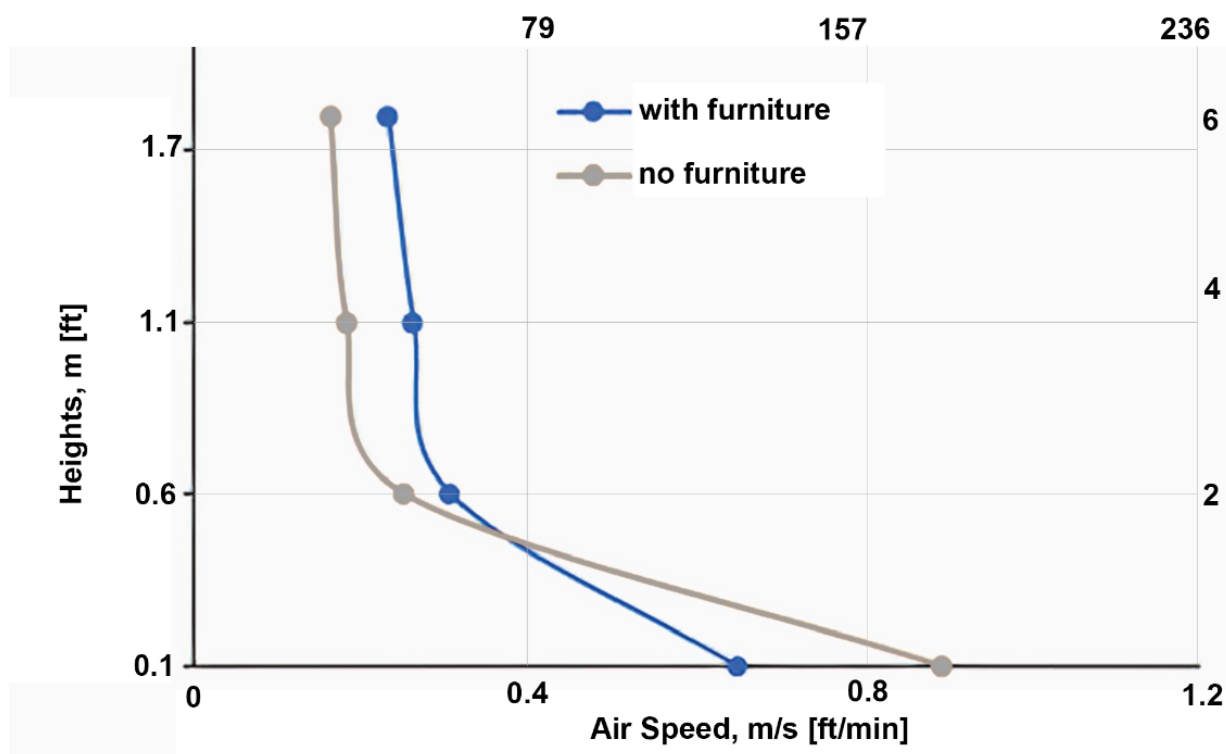

Figure S5 Vertical air speed distribution comparison with or without furniture in space.

Insights from this study

This study demonstrates on-site air speed measurement results in four buildings. The results are helpful for building practitioners to plan for existing and future building design staging with ceiling fans. Some important highlights include: (i) downward airflow fans setting is prioritized with higher air speed and cooling effect in space, but upward flow setting could provide better air speed uniformity; (ii) evenly-placed fans layout is beneficial for the magnitude and uniformity of air speeds in space; and (iii) presence of furniture would impede the air speed distribution by fan, resulting in lower actual air speed on-site when compared to the predicted air speed profile using simulation tool.

Commercial building in Singapore

Background

This is a six-week study implementing ceiling fan with air conditioning in a Singaporean office building. Singapore is located at the tropical climate region, with daily mean outdoor air temperature and humidity of 26 - 29 °C [79 - 84 °F] and 75-85 %. This study examines the performance of HVAC strategy with increased cooling temperature setpoints and elevated air movement produced by ceiling fans in terms of occupants' perception to the environment and the corresponding energy consumption. DC motor ceiling fans (Haiku I-Series 60 inches, Big Ass Fans) were used to provide air movement within the space. Figure S6 shows the office plan and ceiling fans location in the target building. Details of this field study are available in this paper ([Lipczynska et al., 2018](#)).

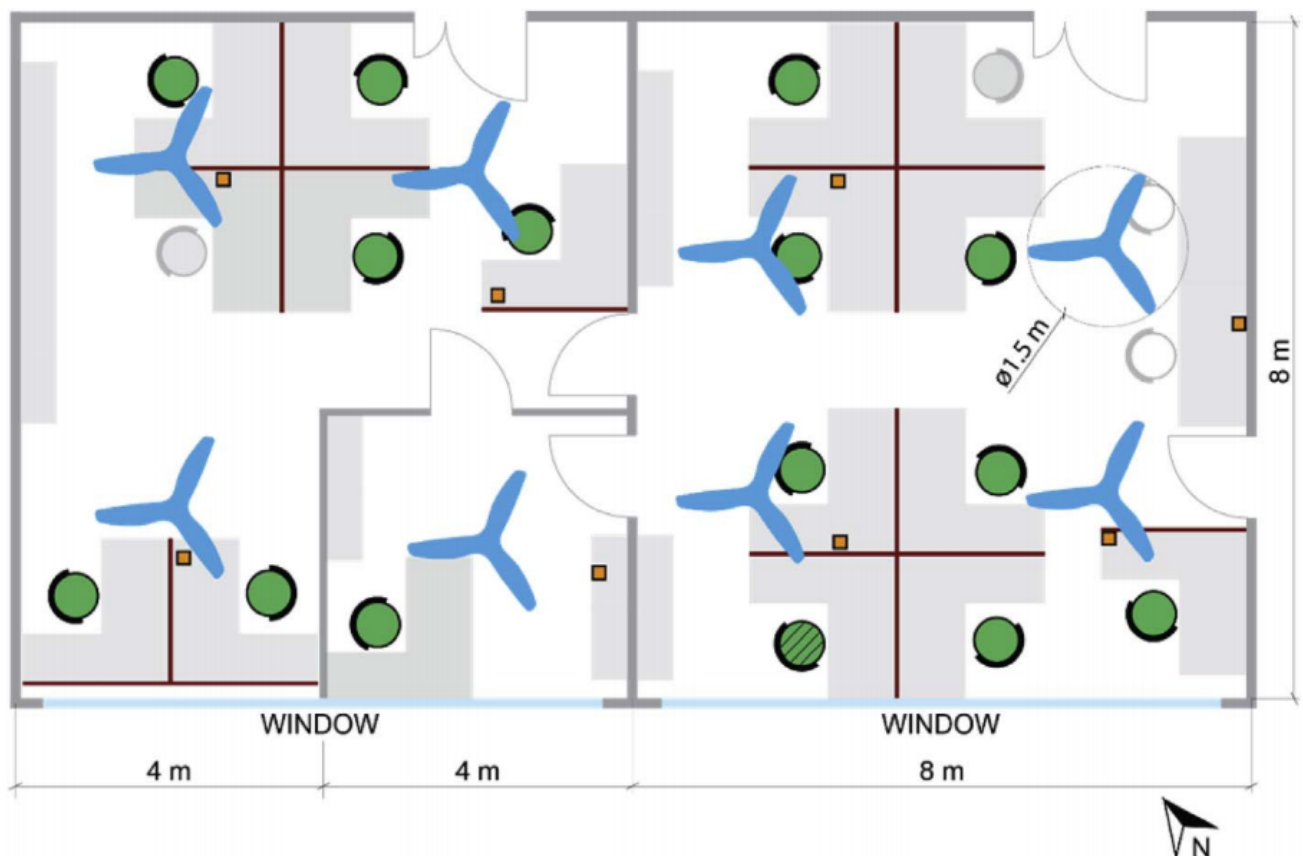

Figure S6. Plan view of the studies office space. Green seats represent occupants participating in the study.

Study methods

The study lasted for 6 weeks from May – July 2016. It examines occupants' perception to the environment and corresponding energy consumption in HVAC system under three conditions: (i) typical air-conditioning settings at 23 °C [73 °F] without fan, (ii) increased cooling temperature setpoint to 26 °C [79 °F] with elevated air movement by fans, and (iii) repeated condition (ii) but increased temperature to 27 °C [81 °F]. Occupants were able to adjust the ceiling fan speed freely anytime in condition (ii) and (iii). Air temperature and humidity data were recorded for both indoor and outdoor conditions. HVAC energy consumption through fan coil units and the ceiling fans was captured for 16 days throughout the study period. For the condition at 27 °C [81 °F], the fan coil units were turned off to achieve the target indoor temperature.

Subjective survey was conducted to characterize occupants' thermal comfort (thermal sensation, acceptability, and preference), air movement (acceptability and preference), and self-reported well-being (i.e., concentration ability, level of sleepiness, and perceived productivity).

Thermal acceptability and preference

Figure S7 summarizes the survey results on subjects' thermal acceptability and thermal preference. Highest thermal acceptability (91 %) was reported when the cooling temperature setpoint was at 26 °C [79 °F] and ceiling fan were in operation. This was the only condition that met the requirements of ASHRAE 55 for widely accepted indoor environmental conditions (i.e., acceptability >80 %). Further increasing the cooling temperature setpoint to 27 °C [81 °F] with air conditioning turned off reduced thermal acceptability to 77 %, but this acceptability rate was still found higher than the conventional HVAC setting (at 23 °C [73 °F] without fan) in Singapore (which generated 58 % acceptance).

A total of 78 % of occupants preferred "no change" in thermal conditions, implying they were considered adequate at 26 °C [79 °F] with fans control. In conventional air-conditioned settings, i.e., 23 °C [73 °F] without fans, 63 % of the respondents preferred a "warmer" working environment. This indicates conventional air conditioning setting could generate overcooling, as higher thermal unacceptability rate was found when compared to other conditions with ceiling fans. When air conditioning was turned off at 27 °C [81 °F] indoor temperature, 54 % of the occupants preferred a "cooler" environment even when ceiling fans were in operation, showing a performance limitation, which means temperatures above 26 °C would decrease occupants' comfort.

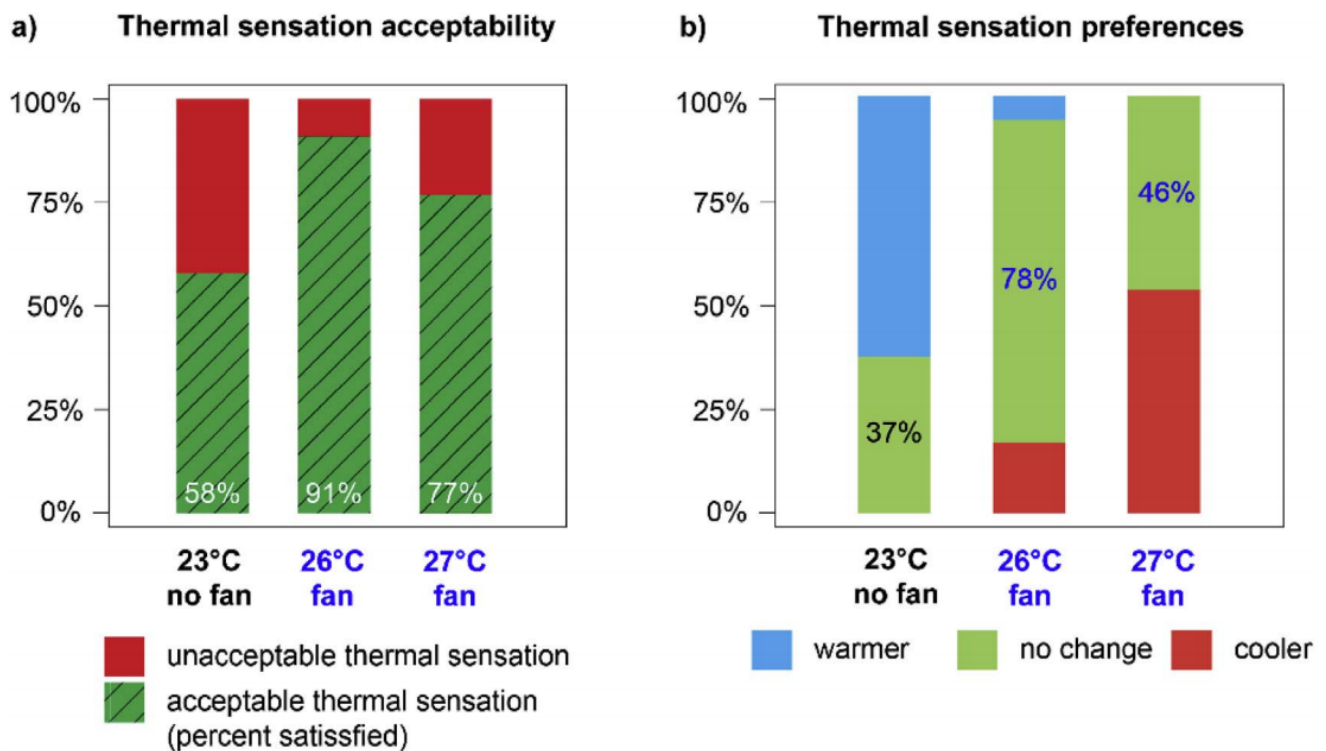

Figure S7. Subjective responses to thermal acceptability and thermal preference under three tested conditions.

Self-reported well-being

Figure S8 plots the occupant's self-reported level of sleepiness, concentration, and work productivity, for the 3 tested thermal conditions. In general, participants reported relatively alert, easy to concentrate, and high in productivity in all conditions. Statistically, the median of most cases was significantly different ($p < 0.05$), but the effect of all these differences is negligible. It means that increasing room temperature and air movement in workspace will not bring any observable downside to subject's alertness, level of concentration, and productivity when compared to conventional air conditioning office operating at cooler temperature setpoint without fan.

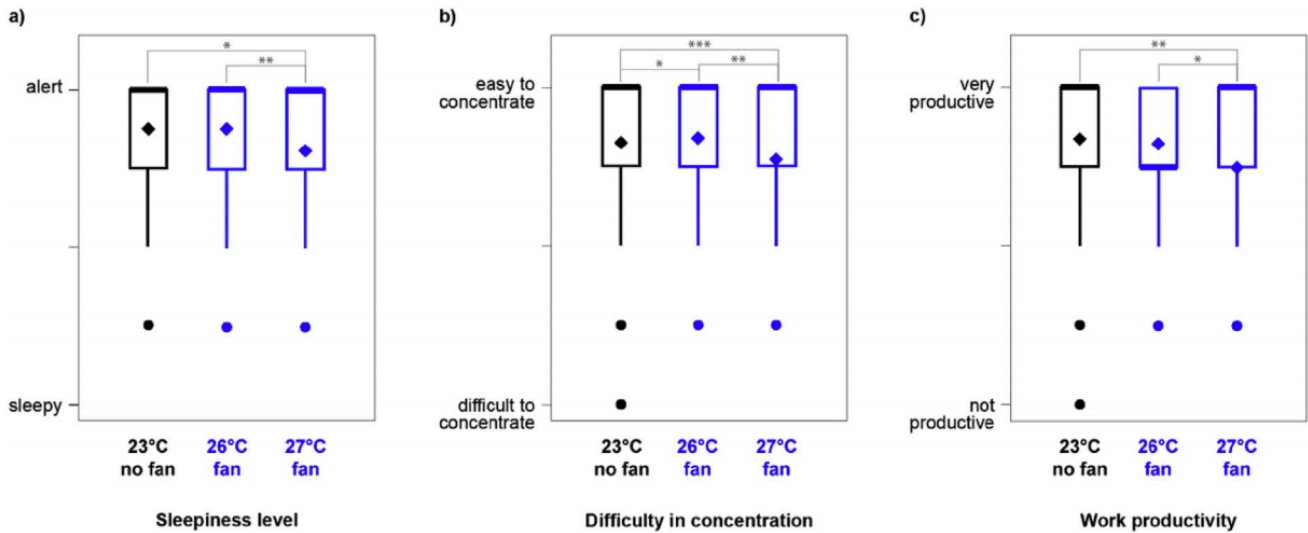

Figure S8. Self-reported levels of sleepiness, concentration, and productivity. Asterisk shows significance in terms of median difference at: * $p < 0.05$, ** $p < 0.01$, *** $p < 0.001$.

HVAC energy usage

Table S2 presents the recorded daily electrical energy usage for the fan coil units and the ceiling fans. Time-averaged total daily energy consumption (for the fan coils and ceiling fans when included) at 23 °C [73 °F] without ceiling fan and at 26 °C [79 °F] with ceiling fans were 34.5 kWh and 23.6 kWh respectively. This means increasing the cooling temperature setpoint by 3 °C [5 °F] with ceiling fans available, approximately saved 32 % of energy in the HVAC system. In addition, it is highlighted that the energy use for operating the ceiling fans consumed less than 1 % of the total energy consumption. Turning off the air conditioning system, and fully depending on the elevated air speed from ceiling fan for cooling did not substantially increase the ceiling fans energy consumption (~ 0.16 kWh).

Table S2 Daily consumption of electrical energy during the field study

Daily consumption of electrical energy measured in one zone during the experiment. The maximum total energy values for each condition are in bold font.

Case	Date	Mean outdoor air temp., °C	Total number of working hours	Fan coil energy usage, kWh	Ceiling fan energy usage, kWh	Total energy usage, kWh	Time-averaged total daily energy usage, kWh
23 °C no fan	6/16/2016	27.8	6.0	24.03	–	24.03	34.45
	6/17/2016	25.5	8.0	42.27	–	42.27	
26 °C fan	5/26/2016	28.9	7.0	20.59	0.16	20.75	23.56
	5/27/2016	30.7	9.5	19.29	0.12	19.41	
	5/30/2016	27.9	10.5	27.87	0.17	28.04	
	5/31/2016	29.8	9.5	23.01	0.16	23.18	
	6/01/2016	26.7	12.0	18.64	0.07	18.72	
	6/02/2016	28.1	7.0	12.85	0.14	13.00	
	6/30/2016	30.5	7.0	22.71	0.12	22.83	
27 °C fan	6/20/2016	28.7	9.0	–	0.20	0.20	0.16
	6/21/2016	29.7	9.0	–	0.22	0.22	
	6/22/2016 ^a	26.5	3.5	–	0.09 ^a	0.09 ^a	
	6/24/2016	26.0	9.0	–	0.13	0.13	
	6/27/2016	29.3	9.0	–	0.14	0.14	
	6/28/2016	28.9	9.0	–	0.17	0.17	
	6/29/2016	28.2	9.0	–	0.11	0.11	

^a Half day in the office.

Insights from this study

This field study shows an example of a real workspace in tropical climate region that with ceiling fan operating with air conditioning system. The study proved that increasing the setpoint temperature from 23 °C [73 °F] to 26 °C [79 °F] and including ceiling fans operation not only resulted in substantial HVAC energy saving, but also enhanced occupants' thermal comfort. In addition, it showed employee's alertness, concentration and work productivity were not hindered by the increase of cooling setpoint temperature, nor the air movement in working environment. More importantly, this study was conducted in Singapore with yearly round hot and humid climate, which implies this intervention (AC + Fan) can satisfy occupants' comfort even in tropical climate region, been applicable to all other climate conditions.

Commercial and residential buildings in California

Background

This is a 2.5 year-long field study in 4 sites, composing 8 commercial and 6 residential zones, in central California (hot / dry climate), demonstrating the difference in user behavior and energy performance for automated ceiling fans operated with air conditioning system (after renovation) when compared with the conventional air-conditioning system (before renovation). Effectiveness on the ceiling fans plus air conditioning control strategy has been demonstrated in this field study (Miller et al., 2021). The control strategy consisted of setting ceiling fans to automatically turn on for cooling before HVAC, and then operate together with air conditioning enabled raising air conditioning cooling temperature setpoints.

Study methods

The study was mainly composed of three stages: baseline, retrofit, and intervention. The baseline period lasted one year from Jul 2017 – June 2018. During this period, the indoor and outdoor temperature, relative humidity, lighting, and the current draw from the air-conditioning system (compressors and fan coils) were recorded in the target buildings. Also, on-site occupants' thermal comfort responses were surveyed. During the retrofit period, June – July 2018, 99 automated ceiling fans were installed in each of the selected buildings. Thereafter, in the intervention period, from July 2018 – October 2019, the target buildings were operated with both automated ceiling fans and the HVAC system. In the intervention period, the same physical measurement (both environmental parameters and energy consumption with ceiling fans) and subjective survey conducted in the baseline period were repeated. Figure S9 indicates the field study timeline.

The automated ceiling fans installed in this study were all integrated with brushless direct current motor, with power consumption ranging from 2 to 53 W depending on fan size. The installed fans operate automatically based on infrared sensors on the fan hub detecting temperature and occupancy. Also, the fans were configured to operate when spaces were occupied or reaching above the adjustable temperature setpoint at 23.3 °C [74 °F]. The fan speed increased with temperature up to an adjustable maximum automatic level, then the air conditioning turned on to cool the space. Figure S9 visualizes the control strategy. At all times, occupants could manually override the fan control using handheld remotes or smartphone apps.

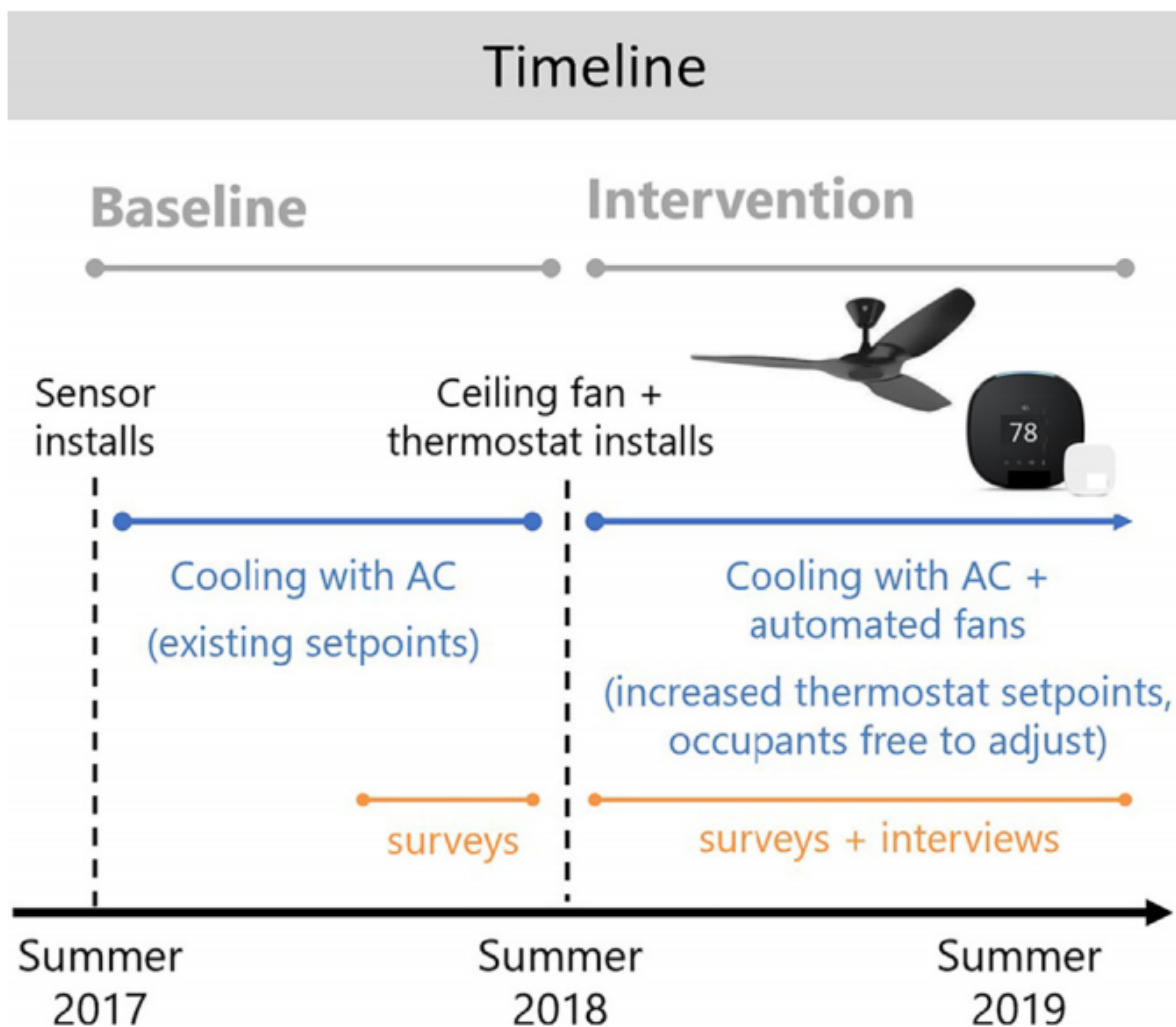

Figure S9. Field study timeline indicating baseline (pre-retrofit) and intervention (post-retrofit) periods.

Indoor / Outdoor temperature

Figure S10 shows an increased indoor temperature during the intervention (AC + fans) compared to the baseline period (AC only) period by an average of 1.9 °C [3.4 °F] across all sites and all hours. Assuming 'still air' conditions during the baseline period (air speeds < 0.05 m/s [10 fpm]), and air speeds up to 0.5 m/s [100 fpm] in the intervention period, the respective comfort temperature ranges estimated from ASHRAE Standard 55 in typical office conditions are 22.2 - 25.6 °C [72 - 78 °F] and 22.2 - 28.3 °C [72 - 83 °F]. For the baseline period, 46 % of the hours from all sites (including unoccupied hours) were within the comfort temperature range, while 84 % of the hours in the intervention period with ceiling fans were within the comfort temperature range. This result suggests that occupants could be more comfortable in conditions where ceiling fans are operating together with air conditioning at a higher cooling setpoint.

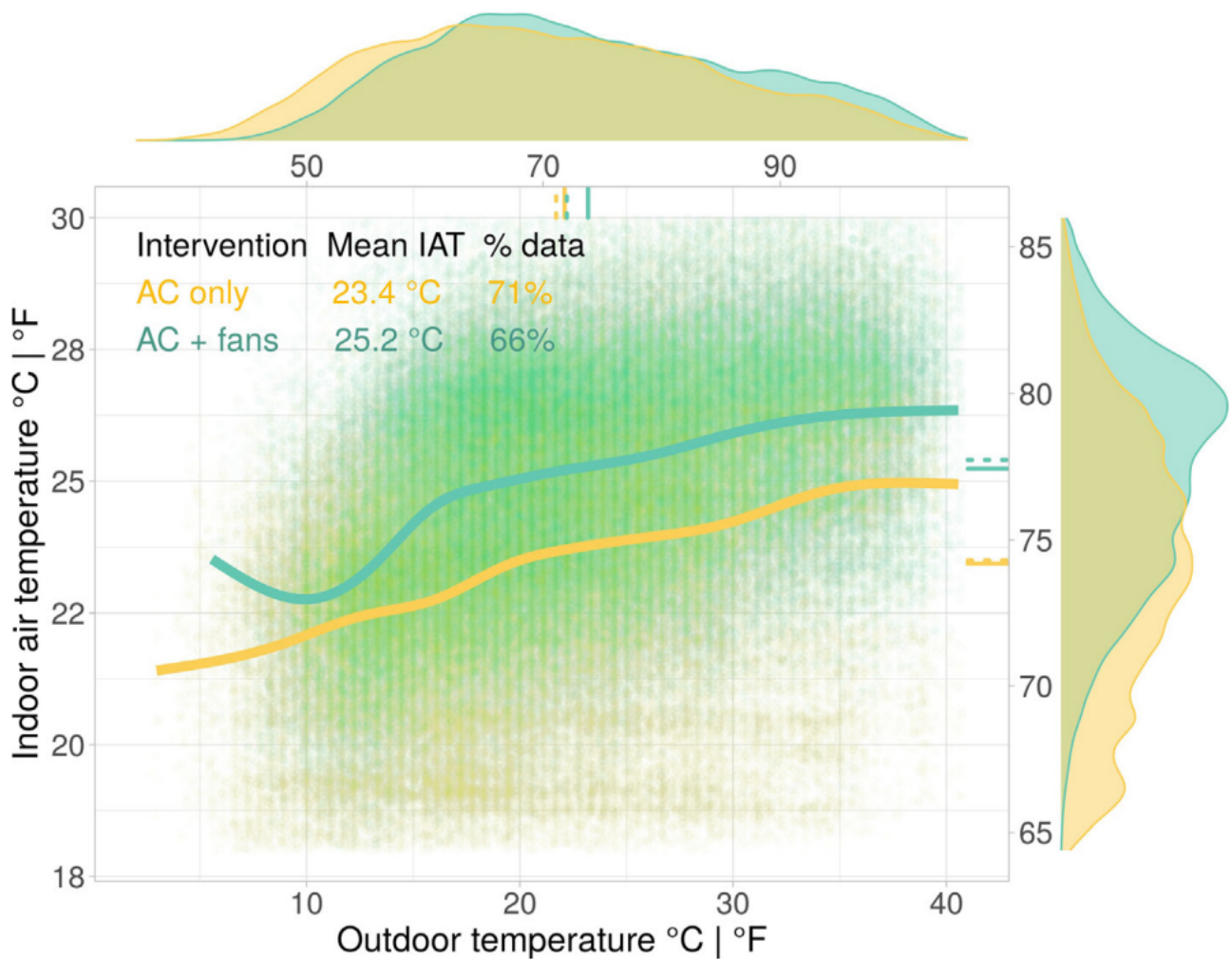

Figure S10. Mean hourly indoor air temperature against outdoor temperature. Dashed lines on x and y axes represent medians, solid lines represent means.

Subjects' responses to thermal comfort

To verify the occupants' actual thermal comfort perception, subjective surveys were conducted in one out of the four sites before and after the installation of ceiling fans. Subjects responded to the thermal comfort question in a 5-point Likert scale: Too warm, comfortably warm, comfortable, comfortably cool, and too cool. Any responses given to the middle three scales are considered comfortable. The results in Figure S11 suggest 82 % of the occupants found themselves comfortable at 22 °C (72 °F) indoor temperature with air conditioning. The percentage of comfortable occupants increased to 93 % in the intervention period where air conditioning was operating at 26 °C [79 °F] setpoint temperature together with ceiling fans. This result gives evidence that the intervention could enhance subjects' thermal comfort compared to the condition operated only with air conditioning.

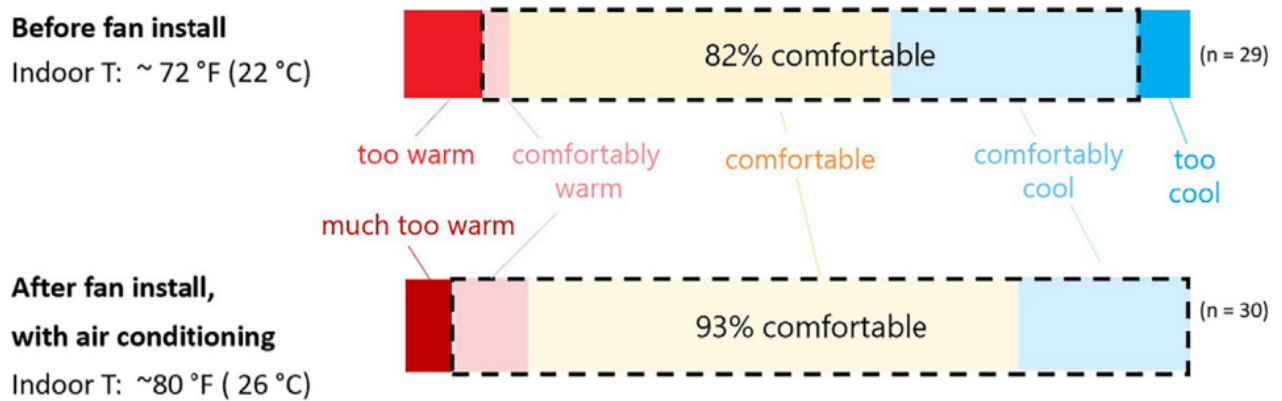

Figure S11 Thermal comfort survey responses at one site before and after retrofit.

HVAC power consumption

Figure S12 summarizes the recorded power consumption for the compressor from HVAC system and for the ceiling fans in all sites. The measured power is normalized by floor area to allow the proper comparison of the energy savings. The normalized mean compressor power consumption for the intervention (AC + fans) is 1.8 W/m² [0.6 Btu/h·ft²], which demonstrated 36 % energy saving during the cooling season (April – October) when compared to baseline conditions (2.8 W/m² [0.9 Btu/h·ft²]). During the warmer months, June – September, the overall energy savings between at 4 – 9pm increased to 41 %.

Ceiling fans were frequently operated during occupancy periods in most zones, resulting in an average operation during 81% and 45% of occupied hours in commercial and residential zones respectively. When averaging across all zones and hours, the normalized mean ceiling fan power was 0.04 W/m² [0.01 Btu/h·ft²], equivalent to only 2 % of the compressor power consumption during the same period. These results reveal two important findings: (i) in practice, huge energy saving potential can be achieved with ceiling fans operating with air conditioning compared to a condition with air conditioning operating alone; and (ii) ceiling fans energy consumption is negligible compared to the energy used in HVAC compressor.

Meanwhile, detailed field study data suggested that the energy saving potential between intervention and baseline condition could be affected by changes in occupancy frequency and duration. Lower energy saving potential is especially found in residential and irregular occupancy commercial buildings. The regularly occupied commercial spaces that maintained comparable staffing and working hours were less affected by this source of variation.

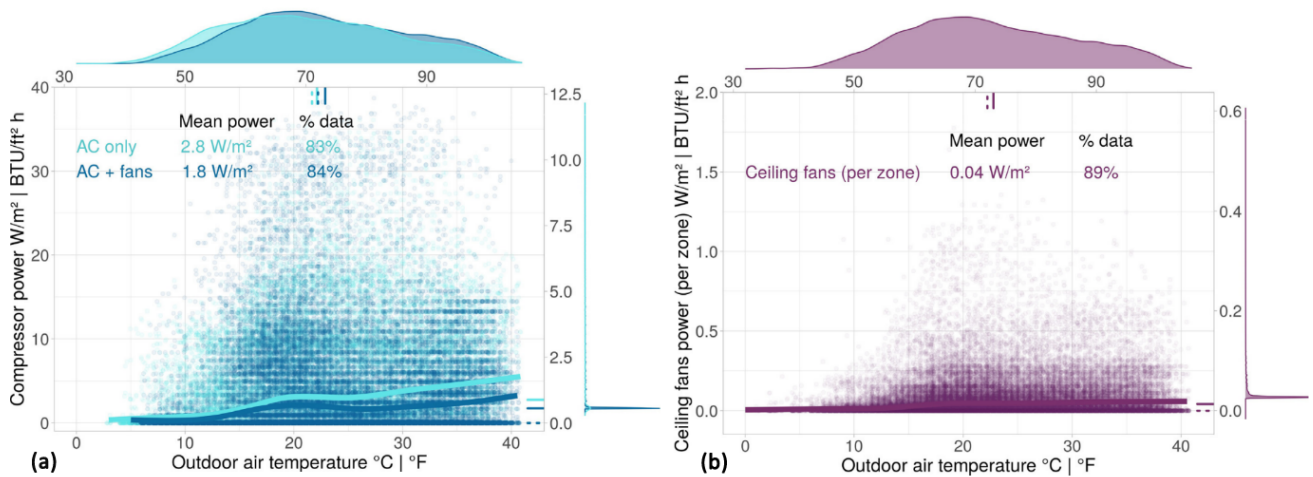

Figure S12. Mean hourly power consumption for (a) air conditioning compressor and (b) ceiling fan. Dashed lines on x-axes and y-axes indicates median, solid line indicates mean.

Insights from this study

This field study demonstrated substantial energy saving potential and improved occupant comfort by the implementation of air movement and air conditioning. Through this field work, we learnt that energy savings and cost effectiveness can be maximized by targeting zones with high cooling demand. Cost can be reduced when this intervention is implemented to new construction at design stage as opposed to retrofit project.

In commercial buildings, the design tip is to ensure air conditioning cooling setpoint remains above fan cooling setpoint by introducing interlock for this control. In residential buildings, especially in bedrooms, the motion-based or infrared-based occupancy sensors in automated ceiling fans may not function properly when occupants are sleeping with blankets.

Zero Energy Building (ZEB) Plus in Singapore

Background

This is a detailed study on cooperating ceiling fans, desk fans, and air conditioning systems in the Zero Energy Building (ZEB) Plus office at the Building and Construction Authority (BCA) in Singapore for thermal satisfaction improvement and cooling energy reduction (see Figure S13). The BCA ZEB Plus is a Green Mark Platinum certified office building renovated in 2019. It is a living laboratory demonstration of an energy-efficient building design and technology solutions in the tropics.



Figure S13. Outlook and internal design (integrating HVAC system with ceiling fans and desk fans) for BCA ZEB Plus. Photo credit: Building and Construction Authority, Singapore (BCA).

Study methods

Before the retrofit, the first floor of this building was a gallery exhibition using a conventional air-conditioning system. The retrofitted office is approximately 675 m² that can accommodate 51 occupants, integrating multiple energy-efficient technologies such as high-efficient lighting control, smart power management, and especially fan-integrated AC system. Fans, desks and HVAC ducts layout is shown in Figure S14. The ceiling fans provide the base air movement to satisfy most of the occupants, while personal desk fans are available for each occupant to maximize workstation micro-environment control.

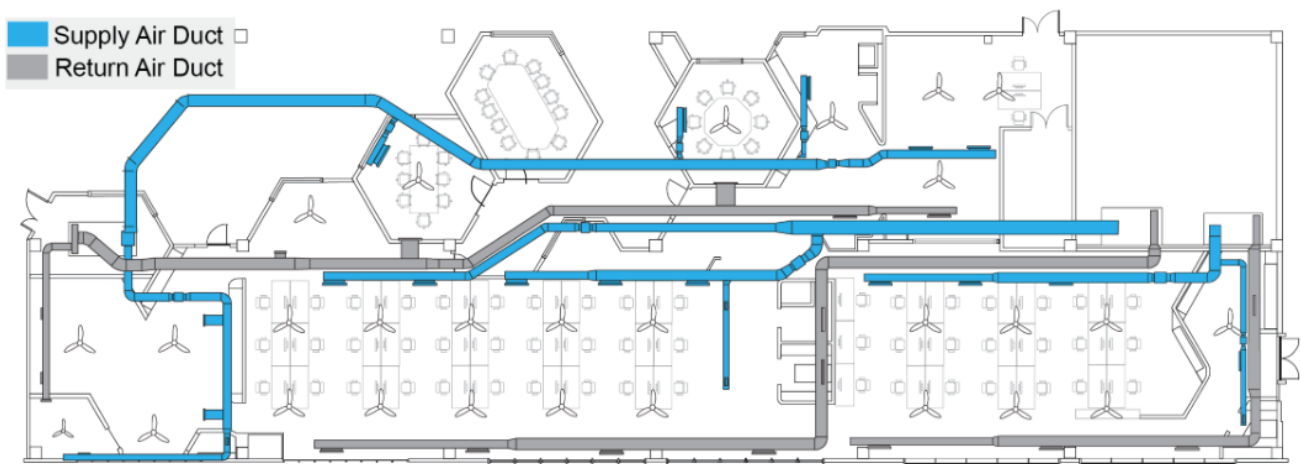

Figure S14. Floor plan in BCA ZEB Plus with supply and return air duct and ceiling fans location.

The study was conducted in 3 phases. In phase 1, we set a temperature setpoint at 26 °C [79 °F] and increase air movement using ceiling and desk fans for 4 weeks to allow the occupants to adapt to the new indoor temperature setting. In phase 2, we aimed to identify the optimal temperature setpoint with personal adjustable air movement by fans. To achieve this, we varied the indoor temperature between 26-28.5°C [79-83 °F] and allowed occupants to operate fans (both ceiling and desk fans) based on their preferences for 4 weeks. During this period, we studied subjects' satisfaction with the indoor temperature and air movement using the right-here-right-now survey, i.e., How satisfied are you with the temperature and air movement? Participants are required to answer these questions in a three-point satisfaction scale: "Satisfied / Neither satisfied nor dissatisfied / Dissatisfied". In phase 3, we conducted a longitudinal measurement for 11 consecutive weeks to thoroughly evaluate the thermal comfort and energy-saving impact of the optimal condition evaluated in phase 2. During phase 3, we alternated the environment and operated system between (i) the new fan-integrated AC system at 26.5 °C [80 °F] indoor temperature setpoint and (ii) conventional AC system at 24 °C [75 °F] temperature setpoint. We also sent a daily survey to the occupants asking their immediate satisfaction with temperature and air movement within the office environment. Detailed energy consumption from the HVAC system (chiller, AHUs, pumps, and cooling tower) and fans (ceiling and desk) were measured for energy-saving comparison.

Thermal comfort

Thermal comfort is a critical requirement to evaluate the effectiveness of the fan-integrated AC system. Based on the experimental results in phase 2, we found the optimal temperature setpoint at ZEB Plus with ceiling fans to elevate air speed in the open plan office was 26.5 °C ± 0.5 °C [80 °F ± 1 °F]. Meanwhile, personal desk fans were provided in each workstation to meet additional cooling needs. Subjective survey on occupants' satisfaction with temperature was conducted in ZEB Plus at 26.5 °C [80 °F] (with fans) and compared with 10 other conventional AC offices in Singapore at 24 °C [75 °F] (without fans) in Figure S15. We found 68 % of the occupants in ZEB Plus were satisfied with the indoor temperature. Additionally, the dissatisfaction with temperature for fan-integrated AC workspace has been reduced by 14 % when compared with conventional AC offices. This demonstrates an improved temperature satisfaction in ZEB Plus with fans despite the workspace being 2.5 °C [5 °F] warmer than common AC offices.

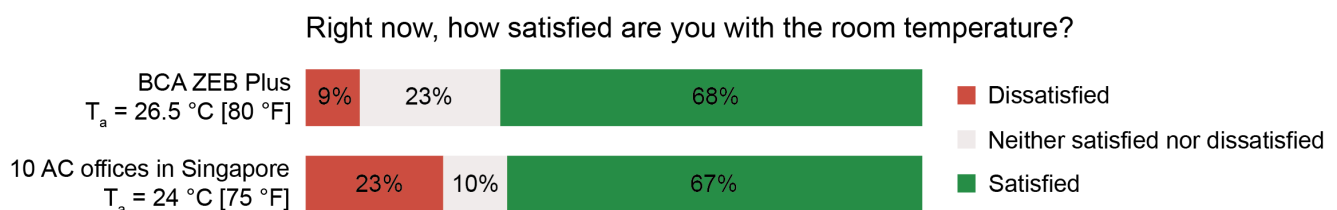

Figure S15. Subjective survey on indoor temperature satisfaction between BCA ZEB PLUS (fan-integrated AC system) and 10 other conventional AC offices (without fans) in Singapore.

Figure S16 showed the results, in phase 3 of the study, when we asked occupants which thermal environment they would prefer between the conditions (i) 24 °C without fans and (ii) 26.5 °C with fans. People who preferred no change (these are the people that are comfortable) increased from 55 % (24 °C without fans condition) to 77 % (26.5 °C and fan-integrated AC condition), indicating that fan-integrated AC gained higher preference of occupants. Moreover, 33 % of occupants preferred a slightly warmer or warmer under 24 °C condition which pointed out the potential discomfort in overcooling conditions. When the setpoint temperature was raised to 26.5 °C with elevated air movement, this negative preference was reduced from 33 % to 9 %. The result provided quantitative evidence that the increased air movement with fans, in general, will not initiate excessive discomfort to the occupants at higher temperature conditions. The fan-integrated AC system worked well in terms of temperature and air movement satisfaction when the occupants were given sufficient long time in adapting to the new system.

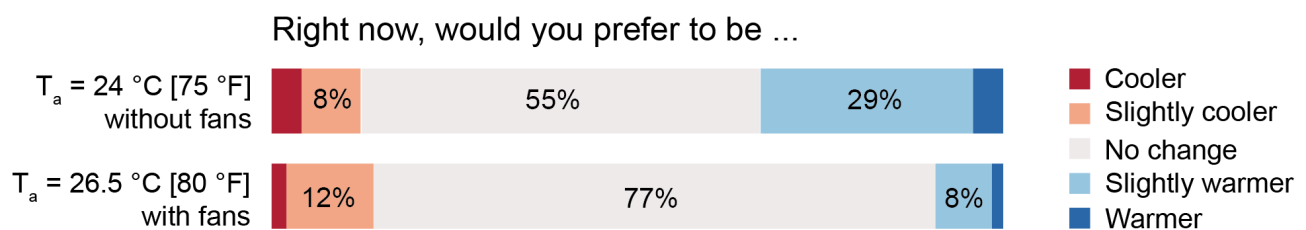

Figure S16. Subject's preference with the thermal environment at (i) temperature setpoint (T_a) = 24 °C without fans and (ii) T_a = 26.5 °C with fans in Phase 3 study.

Energy performance

Besides thermal comfort, energy performance of the fan-integrated AC system has also been investigated. The yearly average outdoor temperature of Singapore is between 25 °C and 31 °C [77 °F and 88 °F]. Air conditioning is necessary in office buildings to maintain thermal comfort. The ZEB Plus was installed with a variable air volume (VAV) air conditioning system and served by three air handling units. The cooling setpoint temperatures were about 23 °C [73 °F] and 26-27 °C [79-81 °F] before and after retrofitting with ceiling fans installed.

In phase 3 of the thermal comfort experiment, we conducted an 11-week study and alternated the office condition between 2 settings: 24 °C without fan and 26.5 °C with both ceiling and desk fans. All the energy measurement data of the air-conditioning system and fans were recorded to directly compare energy performance. Figure S17 shows the energy use intensity (EUI) of HVAC sub-systems including chillers, pumps, AHU, cooling towers and fans in two cases: i) baseline scenario at 24 °C without fan and ii) proposed scenario at 26.5 °C with both ceiling and desk fans. We found the total EUI for the HVAC system is 36.6 kWh/m²-yr and 25 kWh/m²-yr, respectively, for the baseline and proposed scenarios. A 32 % reduction in energy usage (11.6 kWh/m²-yr) is observed in the proposed scenario. The significant energy saving comes from chiller energy usage, then AHU fan and pump. Meanwhile, ceiling and desk fans use only 3.5 % of total energy usage (0.88 kWh/m²-yr). These findings suggest that increasing air movement with fans is an energy-efficient complementary technology to conventional air conditioning in office buildings in the tropics. In fact, energy use in ZEB Plus is lower than 90 % of the office buildings in Singapore based on the building energy benchmarks for commercial buildings from 2017.

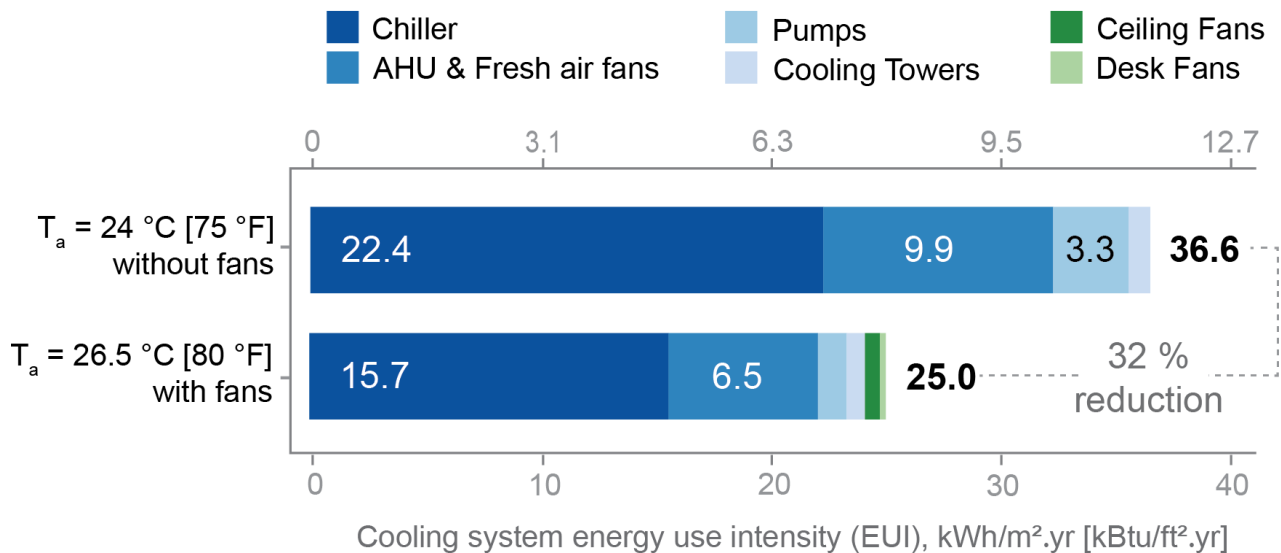

Figure S17. Cooling system energy use intensity at (i) temperature setpoint (T_a) = 24 °C without fans and (ii) T_a = 26.5 °C with fans in Phase 3 study.

Capital cost saving between conventional AC and fan-integrated AC system

Potential cost savings accrued from using fan-integrated AC system are mainly derived from two factors: (i) smaller capacity of AC components and (ii) reduced supply air ducting. To compare the potential cost saving, we redesigned the conventional air-conditioning system with extended supply air duct for air distribution and selected adequate chiller and air handling unit size to support the original design cooling load (air temperature at 24 °C [73 °F]) and estimated the potential construction cost based on average market rate. Figure S18 shows a sector in ZEB Plus comparing the existing installed system layout with ceiling fans (Figure S18b) versus what would be the conventional AC system layout without fans and with more ducts (Figure S18a). This same process was done for the whole floor plan to estimate cost saving.

First, the fan-integrated AC system is operating at indoor temperature setpoints between 25-28 °C [77-82 °F] and supply air temperature between 14-17 °C [57-63 °F]. Instead of the typical chilled water supply temperature at 7 °C [45 °F], the fan-integrated AC system can operate at much higher chilled water supply temperature up to 11 °C [52 °F]. This means that smaller size chiller and AHU can be used in the fan-integrated system approach.

Ceiling and desk fans could mix the zone air more uniformly than the supply air diffusers. The supply air ducts used for distributing diffusers within the occupied zone can be reduced significantly (i.e., only the main supply air duct is needed) when the space is provided with fans. Consequently, a smaller AHU fan size can be selected due to a reduction of static pressure required in the supply air duct.

When compared with the conventional AC system (e.g., Figure S18a), we roughly estimated an overall cost savings of reduced size in chiller (~22 %), reduced size in AHUs (~25 %), and minimized duct work (~25 %) in the fan-integrated AC system design (e.g., Figure S18b) in ZEB Plus. It is worth noting that the capital investments for purchasing and installing ceiling fans in this project are trivial when compared to the above cost savings. In addition, the electricity tariff saving for the HVAC system operating at higher setpoint temperatures (i.e., approximately 25-30 % when increased from 24 °C to 26.5 °C [from 73 °F to 81 °F]) should also be considered.

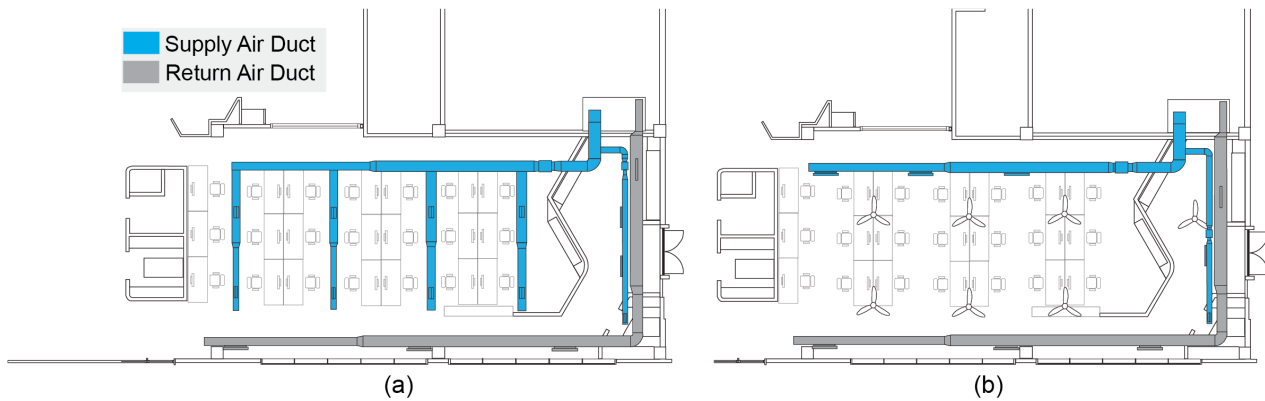

Figure S18. Example of system design layout in ZEB PLUS: (a) conventional AC system with extended supply air duct for air distribution, and (b) existing fan-integrated AC system with ceiling fans.

Insights from this study

This study is the first large-scale deployment of a fan-integrated AC system in office space in Singapore. It demonstrates that the ceiling and desk fans can be integrated efficiently with the HVAC system in tropical climates to achieve better thermal comfort while reducing energy consumption significantly. Besides, the cost saving in initial investment and operation reveals a huge advantage of the fan-integrated AC system over the conventional design. From our experience, the location of ceiling fans should be designed properly to uniformly mix the cooling air for all occupants and to avoid the visual flickering or strobing effect between the lighting fixtures and the operating fans. Lastly, desk fans should be provided for higher granularity of air movement adjustment based on individual needs, especially during the transient period from outdoor to indoor conditions.

Non-ceiling fans study in Singapore

Background

Ceiling fan installation for some buildings is not possible due to limited floor to ceiling height. This case study explored the effectiveness of non-ceiling fan options (i.e., desk fan, towel fan, and pedestal fan) for the application of higher temperature cooling with elevated air speed in a retrofit application.



Figure S19. VENTUS building (sources: SinBerBEST research group).

Study method

Field measurement was carried out in VENTUS, an office building, located at the National University of Singapore (NUS) (See Figure S19). Around 40 occupants doing administration work participated in this study. Before the study, each occupant was given a chance to select one out of four fan types, including desk fan, clip on fan, tower fan, and pedestal fan (see Figure S20), based on their personal preference. These fans have been pre-tested to increase air movement towards occupants and to compensate potential thermal discomfort due to higher temperature setpoint in the workspace. An introductory session was given to the occupants on the study objectives, procedures, and what should be done before the experiment.

The entire study was divided into two stages: (i) the baseline settings (2 weeks) and (ii) the intervention settings (4 weeks). Table S3 summarizes the conditions for both baseline and intervention settings. The baseline settings referred to the conventional air-conditioning system in VENTUS's workspace with temperature setpoint at 24 °C [75 °F] without any fan. In the intervention settings, the indoor temperature was set to 24 °C [75 °F] between 7am - 9am before being increased to 26 °C [79 °F] between 9am - 7pm. A lower temperature set in the morning aimed to improve occupants' initial perception to the thermal environment when they first came into the office. Personal fans were provided to compensate for potential thermal discomfort due to the elevated temperature in space at the beginning of the intervention setting. Each occupant could select one out four fan types as shown in Figure S20, including desk fan, clip on fan, tower fan, and pedestal fan. A duration of four weeks given to the intervention settings is targeted to provide sufficient time for the occupants to adapt to working under higher indoor temperature setpoint with elevated air speed via fans.

Table S3. Experiment settings, duration, and conditions.

Setting	Time Duration	Conditions
Baseline	2 Weeks	Indoor temperature setpoint 24 °C [75 °F]
Intervention	4 Weeks	Indoor temperature setpoint 24 °C [75 °F] (7am-9am) Indoor temperature setpoint 26 °C [79 °F] (9am-7pm) Each occupant was given a fan

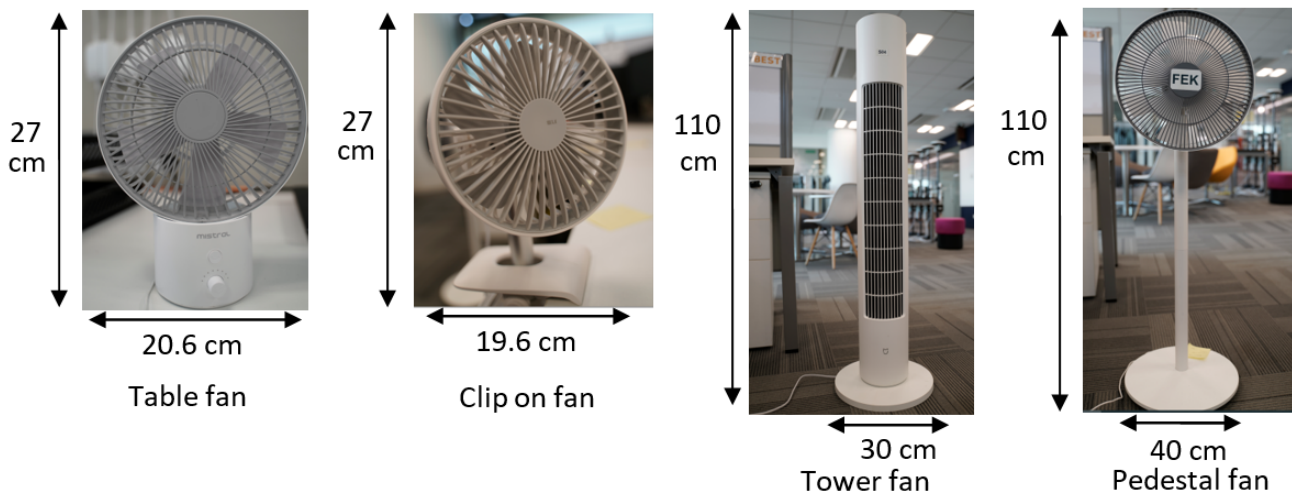

Figure S20. Four fan options are available for occupant's selection.

Physical measurements were conducted to verify the indoor environmental status between baseline and intervention settings. Indoor air temperature, relative humidity, carbon dioxide (CO₂) concentration and outdoor air temperature were recorded in a 5-minute interval. Indoor sensors were placed at 1.3 m height above ground level and approximately 0.6 m away from the occupants. Sensitivity of the sensors were: temperature (+/- 0.5 °C [0.9 °F]), relative humidity (+/- 2 %), and CO₂ (+/- 50 ppm).

Additionally, subjective surveys via web-based platform were conducted to obtain individual's preference with their perceived environment and perception for the usage of fans. Subject's satisfaction regarding thermal comfort, indoor air quality, and overall environment was evaluated using a 5 – point satisfaction scale (Very dissatisfied / Dissatisfied / Neither satisfied nor dissatisfied / Satisfied / Very satisfied). We asked the occupants about their fan usage experience regarding the comfortability of air movement generated by fans, noise level, spatial occupation of fans, and overall happiness in using fans. The subjects were instructed to answer these questions using a 5 – point scale (Strongly disagree / Disagree / Neither agree nor Disagree / Agree / Strongly agree). The environmental satisfaction survey was conducted after both baseline and intervention stages, while the fan related survey was only conducted after the intervention stage.

Physical measurements

Figure S21 summarizes the measured indoor temperature, relative humidity, and CO₂ concentration within the studied zone for both baseline (AC only) and intervention (AC + fans) settings. The mean (min – max) temperature recorded in the baseline and intervention settings was, respectively, 23.1 °C (21.5-25.3 °C) [73.6 °F (70.7-77.5 °F)] and 25.6 °C (25.2-29.2 °C) [78.1 °F (77.4-77.5 °F)]. In the intervention setting, higher temperature levels were occasionally observed in the morning at around 7am right after the air-conditioning system started. The mean (min – max) relative humidity for the baseline and intervention settings was, respectively, 61% (56-71 %) and 68 % (62-76 %). We observed the mean humidity in intervention setting has increased by 7 % when compared to baseline. This could be due to the increased off coil temperature setpoint from the air handling unit, where less moisture is being removed from cooling coil, but the indoor latent load remains. Lastly, we found a higher mean (min – max) CO₂ concentration in the intervention setting 820 ppm (700-920 ppm) than in baseline condition 770 ppm (670-900 ppm). Nevertheless, these recorded CO₂ levels were all well below the general CO₂ threshold (i.e., 1000 ppm) for good indoor air quality in office premises.

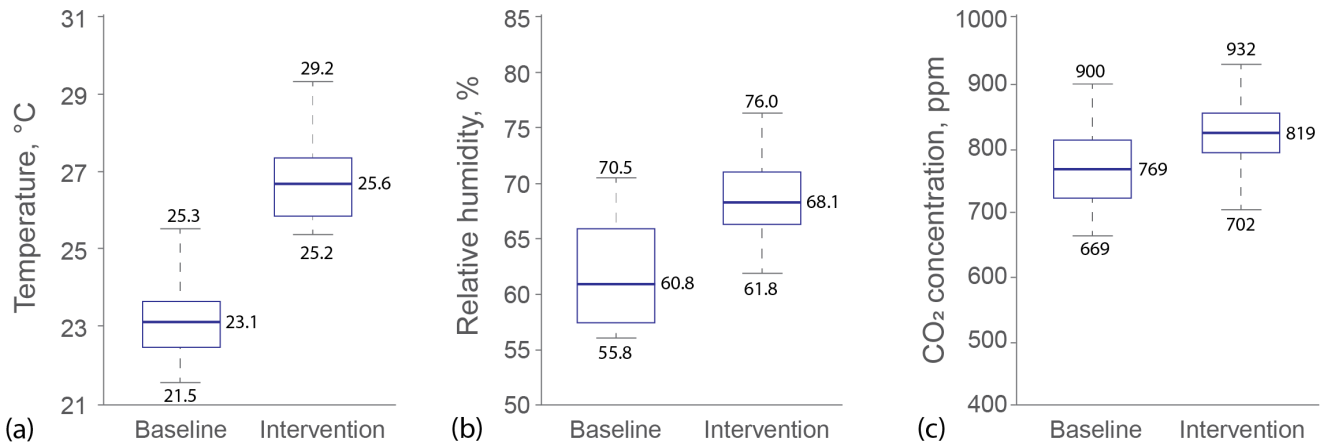

Figure S21. Measured (a) temperature, (b) relative humidity, and (c) CO₂ concentration for both baseline and intervention settings. Whiskers extend to the recorded maximum and minimum values.

Environmental satisfaction

Figure S22 compares the occupant's satisfaction with thermal comfort, indoor air quality (IAQ), and the overall environment between baseline and intervention settings. We found the thermal comfort satisfaction in the intervention settings has increased from 56 % to 64 %, while thermal dissatisfaction has decreased from 21 % to 9 % when compared to the baseline. The results suggest that occupants are thermally more satisfied under higher temperature setpoint (26 °C [79 °F]) with ability to operate personal fans than in the conventional AC setting at lower temperature (24 °C [75 °F]). The additional 3 % of “very dissatisfied” responses in the intervention settings could be due to individual's higher sensitivity to a high indoor temperature resulting from the morning period when the air conditioning just started and have not reached the setpoint yet (max temperatures > 28 °C [82 °F] in the intervention period, see Figure S21). The percentage of satisfactory IAQ has increased from 62 % in baseline to 70 % in the intervention settings, while the percentage of dissatisfaction remained 12 %. In general, we observed an improvement for IAQ in the when subjects can adjust the air speed around them. Meanwhile, an additional 3 % of the subjects responded “very dissatisfied” for IAQ during the intervention. This could be associated with the increased relative humidity in space which returns a sense of stuffiness in the air. Lastly, we found the overall satisfaction has increased from 59 % to 70 %, while dissatisfaction decreased from 12 % to 6 %, when compared the intervention to the baseline settings. These results showed occupants in the tropics are satisfied with higher temperature workspace when they are given personal fans to adjust their surrounding air speed.

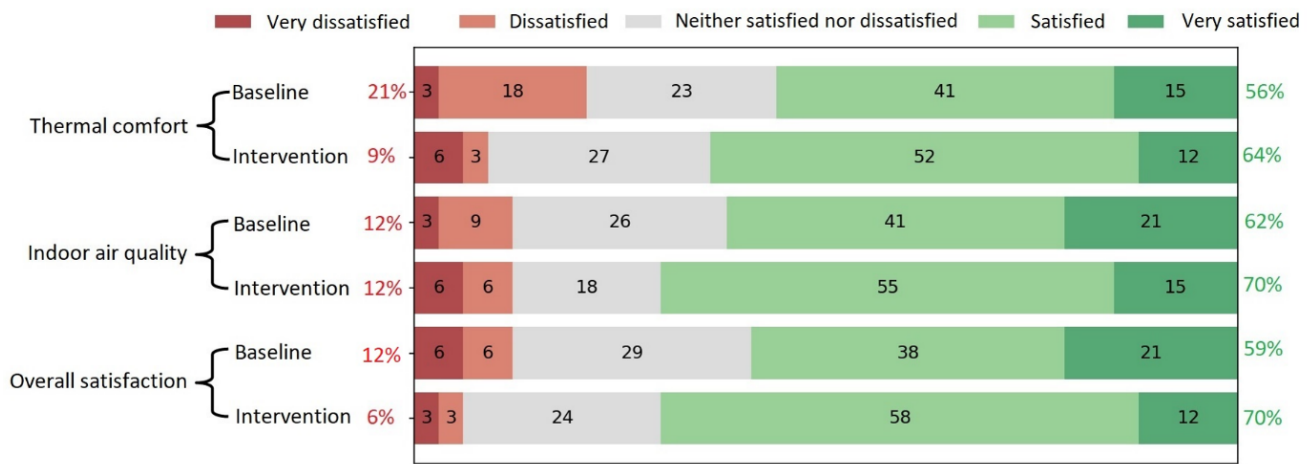

Figure S22. Subject's satisfaction with thermal comfort, indoor air quality and the overall environment in both baseline (AC only) and intervention (AC + fans) settings.

Fan selection and users' feedback

Figure S23 illustrates the occupant's preference regarding the fan types available in this study. We found 18 subjects selected a desk fan, 9 of them picked a pedestal fan, 5 of them took a tower fan, and the remaining 3 chose a clip-on fan. Spatial constraint could be a reason for more subjects selecting desk fan instead of pedestal and tower fans. Despite the small size of clip-on fan, the placed location is limited along the desk's edge, and simply unavailable to be placed in front of the subjects (i.e., desk with partition in the front). In this study, occupants were free to select the fan speed based on their own preference. The average air speed perceived by each occupant is not identical.

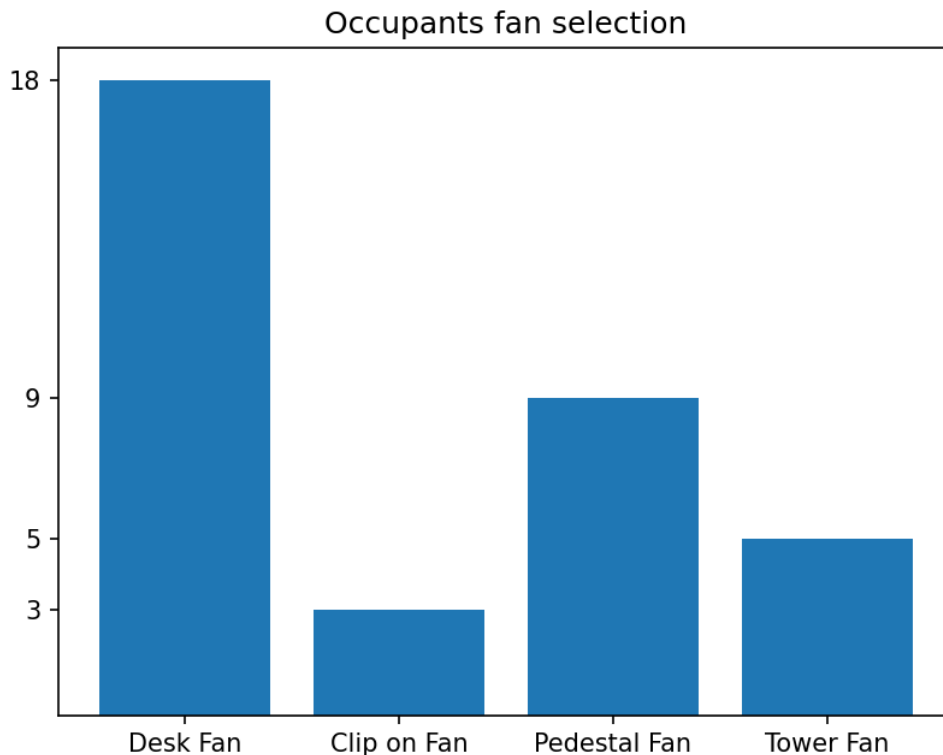

Figure S23. Occupant's preference for different fan types.

Figure S24 presents the subject's feedback regarding their fan usage experience, including how comfortable is the air movement generated by fans, fans noise level, spatial consideration, and overall happiness in using fans. The results showed 54 % of the occupants were thermally comfortable, while 21 % reported uncomfortable, with the air movement from personal fans. Also, we found 53 % of the participants were satisfied with the noise level generated by the fans. Only 17 % of the subjects reported the fans were noisy, among which 50 % of them were using a desk fan, 25 % was using a pedestal fan, and the rest was using a tower fan. We found 8 out of 39 participants (~21 %) responded that the fans have taken up too much of their working space. 5 out of these 8 participants were holding a desk fan and the other 3 were holding a tower fan. It also suggests that approximately 28 % of the desk fan holders and 60 % of the tower fan holders felt the fans are spatially too occupied.

Overall, we found 62 % of occupants (i.e., 25 out of 40) are satisfied with the use of personal fans under higher temperature workspace environment, where only 12 % (i.e., 5 out of 40) of them showed dissatisfaction. In addition, among these 5 dissatisfied individuals, 2 of them also reported thermally uncomfortable when in using fan, 2 of them claimed the fans have taken up too much of their working space, while the remaining one just anyhow not happy with the fan. These findings generally support the idea of using personal fans in workspace with higher temperature setpoint.

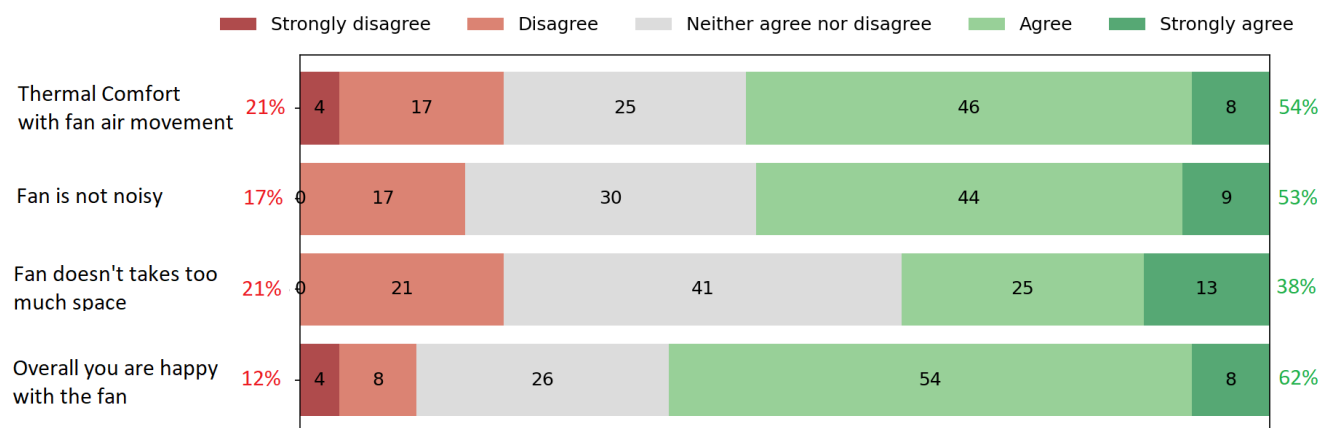

Figure S24. Subject's responses to their fan usage experience.

Other occupants' feedback

During the study, we engaged with some of the occupants to obtain general feedback. In the middle of the intervention period, some participants have reported difficulties in thermally adapting to the new condition, even though personal fans were provided. Thermal dissatisfaction responses were reported early in the morning when the air-conditioning system just started (i.e., temperature may increase up to 29 °C [84 °F]) and during the transient period when occupants were entering the office from outdoor. In addition, some occupants felt that the indoor air was stuffy and there is inadequate air circulation. Nevertheless, such complaints were reduced significantly towards the end of the experiment.

Recommendations

Based on what we have learnt from this field experiment, there are several recommendations to smoothen the transition between traditional air-conditioning systems (without fan) to fan-integrate air-conditioning settings in real buildings.

1. Sufficient communication with the occupants is important. Before the implementation of the fan-integrated air-conditioning approach, an introduction session given to all occupants to explain the rationales, procedures, precautions, expectation, and flexibility (e.g., clothing) is necessary. This session will help the occupants to prepare for the upcoming changes. In addition, continuous monitoring of occupants' feedback regarding thermal comfort, indoor air quality, and the usage of fans is critical. It provides hints to the management officers on how to react and satisfy occupants' needs during the transitional period.
2. Selecting a suitable fan is critical. From our experience, the personal fans being selected for workspace usage should be quiet and not too bulky (i.e., limited discomfort in acoustic and occupied space). It would be best if a few fan choices were provided for the occupants to select based on their own preference.
3. Preparation for additional fans. Additional fans can be deployed in common areas, such as meeting rooms, receptions, and pantries, where different activity occupant levels are expected.
4. Avoids aggressive change in temperature setpoint. During the early stage of the intervention, the increase in temperature setpoint shall not be too large. For example, if the conventional temperature setpoint is 24 °C [75 °F] and the new targeted setpoint with fans is 26 °C [79 °F], we suggest to first to increase the temperature to 25 °C [77 °F] for one or two weeks, followed by 26 °C [79 °F] if the occupants' feedback is positive. The benefits are two-fold: (i) it allows the occupants to progressively adapt to the temperature change, and (ii) it provides a buffer for management officers to collect and resolve occupants' feedback before any further actions are to be taken. Each step change of temperature setpoint is recommended to not exceed 1 °C [1.8 °F].
5. Occupants need time for adaptation. Occupants are used to the conventional air-conditioning setting in the workspace. The concept of increasing convective and evaporative heat loss through higher air speed is physiologically valid, but it takes time for the occupants to adapt to this new cooling strategy. It is expected that some occupants would take longer time for adaptation and reflect thermal discomfort during the early stage of system transformation. Facility managers are advised to be patient and try to resolve the reasons for dissatisfaction. For example, occupants may adopt flexible clothing policy, increase background air circulation, or even temporarily reduce the temperature setpoint in a particular hot day. With respect to the space and system settings, the occupant's adaptation period can be varied.

Insights from this study

This study demonstrates the feasibility for using personal fans (i.e., desk, clip-on, pedestal, and tower fans) to compensate potential thermal discomfort under higher temperature (up to 26 °C [79 °F]) workspace in Singapore. Positive feedback on thermal satisfaction, air quality satisfaction, overall environment satisfaction, and overall happiness from the occupants has been confirmed with the use of fans in the workspace. The findings are beneficial to the buildings that are attempting to adopt higher temperature cooling with elevated air speed strategy but limited to ceiling fans installation (i.e., insufficient floor-to-ceiling height) and major renovations (i.e., high cost). Precautions have been raised when selecting personal fans, including flexibility of fan choices, noise level, and spatial consideration. Lastly, an adaptation period for the occupants is acknowledged when transforming from conventional air-conditioning system to fan-integrated air-conditioning system.

Deep dive on indoor air quality

Research oriented discussion on air movement, indoor air quality (IAQ) and indoor transmission of aerosol infectious agents

Although many studies have shown that elevated air movement can improve the occupants' perceived air quality ([Melikov & Kaczmarczyk, 2012](#); [Schiavon et al., 2017](#); [Zhai et al., 2015](#)), studies on the relationship between air movement and indoor air quality are comparatively limited. Increased air movement does not remove indoor pollutants from a space like ventilation does. However, air movement changes the airflow pattern in the space, which can reduce an occupant's exposure to indoor pollutants and infectious agents in several ways: as discussed below.

Firstly, air movement changes the room airflow pattern by redistributing the supply air, thus diluting local sources of pollutants in the room. In spaces with stagnant air where the ventilation effectiveness is lower than 1, the sources of air pollutants can accumulate in the room locally. Using air-moving devices, such as ceiling fans, the air within the space can be fully mixed, resulting in the ventilation effectiveness of the room to approach 1 (which is a measure of complete air mixing) ([ASHRAE Standard 62.1, 2016](#), Table 6-B) and lowering of the air pollutants levels. However, for other rooms with ventilation effectiveness above 1, such as displacement ventilation ([Yang et al., 2019](#)), using large fans will decrease the effectiveness of indoor pollutants removal by design using such systems.

Increasing air movement has been reported to impact the dynamics of indoor air. Using a ceiling fan or a larger stand fan, air pollutants in the room were fully mixed resulting in a more uniform but lower pollutant concentration ([Benabed et al., 2020](#)). The authors reported that the air pollutant released from a source was dispersed much faster and reached a more uniform concentration within the space using a fan blowing directly to the source than without a fan. In a recent study on indoor airborne transmission of the SARS-CoV-2 virus, fan use was found to help disperse viruses from the breathing zone to the unoccupied upper part of the room, thus, potentially lowering infection risk. Another study shows that using ceiling fans reduced the pollutant concentration in the exposed person's breathing zone by more than 20% ([Li et al., 2021](#)). For upper-room ultraviolet germicidal irradiation system (UVGI) systems typically relies on the natural convection of air within the space to disinfect microorganisms brought from the breathing zone up to the irradiated zones near the ceiling. Using ceiling fans greatly improved the UVGI effectiveness system by mixing the microorganisms-laden air up to the irradiation zone, thus disinfecting them at a higher rate compared to those without using ceiling fans ([Pichurov et al., 2015](#); [Rahman et al., 2014](#); [Rudnick et al., 2015](#); [Zhu et al., 2014](#)).

Secondly, elevated air movement increases the deposition rate of airborne particles onto indoor surfaces such as fan blades and room furniture, floor, ceiling and walls ([Lai, 2002](#); [Thatcher et al., 2002](#)). This process can be understood by the reduction in boundary layer thickness because of increased air movement, thus facilitating the mass transfer of particles onto the surfaces. Although resuspension of particles may also increase with increased air movement ([Salimifard et al., 2017](#)), the resuspension rate is several orders lower than that of deposition. The air movement needed to resuspend deposited from surfaces into the air is typically on an order of 10 m/s ([Mukai et al. 2009](#)) which is higher than most fan speeds.

Lastly, the World Health Organization (WHO) recommends using stand fans (or pedestal fans) by placing them close to an open window to enhance ventilation for naturally ventilated spaces ([World Health Organization, 2021](#)). Evaporation of airborne droplets and water-containing particles can be enhanced via air movement. A simulation study on the ejection process of saliva droplets in the air to mimic real events of human cough showed that increased air velocity will result in the saliva droplets going further with a decreased concentration and liquid droplet size in the wind direction ([Dbouk & Drikakis, 2020](#)). For infectious bioaerosols, this evaporation process and increased mechanical stress may decrease microorganisms' viability within the airborne droplets. In indoor spaces that adopt increased air movement and elevated temperature, the higher air temperature and relative humidity (RH) may affect viability of airborne microorganisms ([Chin et al., 2020](#); [Dabisch et al., 2021](#)). [Lin et al. \(2020\)](#) have noted that RH controls droplet evaporation. The evaporation affects droplet chemistry (solutes become more concentrated as water is lost) which in turn affects the virion's microenvironment and viability. For SARS-CoV-2, changing the room temperature and relative humidity from 23 °C [73 °F] and 40% to 28 °C [82 °F] and 60 % will reduce the virus half-life from 44.8 minutes to 22.6 minutes ([SARS-Airborne calculator](#)).

About this work

Acknowledgment

Acknowledgment and conflict of interest declarations

This work was partly funded by the industry consortium members of the [Center for the Built Environment \(CBE\)](#), [University of California, Berkeley](#) and partly by the [Republic of Singapore's National Research Foundation](#) through the SinBerBEST program.

We thank Samuel Foo, Chuan Seng Lee, Yang Lim Lem, Komang Narendra, Majid Sapar, Yvonne Soh, Kiat Leong Tan, and Irene Yong for their valuable comments and support. We want to thank [Christian Taber](#), [Tim Jukes](#), and [Ole Jochen Stockhausen](#) for the valuable discussions on the use of fans.

This work is based on decades of research on fans. We want to thank some of the key researchers that helped in this process: Edward Arens, Gail Brager, Carlos Roa Duarte, Lindsay Graham, Charlie Huizenga, Ollie Jay, David Lehrer, Aleksandra Lipczyńska, Shuo Liu, Arsens Krikor Melikov, Asit Mishra, Jovan Pantelic, Chandra Sekhar, Costas Spanos, William W Nazaroff, Gwelen Paliaga, Tom Parkinson, Dongyun Rim, Federico Tartarini, Kwok Wai Tham, Yan Bing, Le Yin, and Hui Zhang.

Conflict of interests

The Center for the Built Environment (CBE) at the University of California, Berkeley, with which some of the authors are affiliated, is advised and funded, in part, by many partners that represent a diversity of organizations from the building industry, including manufacturers, building owners, facility managers, contractors, architects, engineers, government agencies, and utilities.

Version

In this page we keep a record of all the versions of the guidebook with the most recent on top

Version 0.9.0 (2023-08-08)

Formal review from SinBerBEST partners completed. This version will be shared broadly to collect more feedback. At this stage, if you have any suggestions for improvement, please contact Stefano Schiavon at schiavon@berkeley.edu.

Version 0.1.0 (2023-06-16)

We launch this first beta version of the guidebook to collect feedback. At this stage, if you have any suggestions for improvement, please contact Zuraimi Sultan at zuraimi_ms@hotmail.com

How to cite this work

We benefit from you citing this free guidebook if you use it

Paul Raftery, Toby Cheung, David Douglass-Jaimes, Máira André, Jiayu Li, Michael Kent, Ken Huynh Khoa, Zuraimi Sultan, Stefano Schiavon. Fans for cooling people guidebook. 2023. <https://cbe-berkeley.gitbook.io/fans-guidebook/>

Please contact [Paul Raftery](mailto:p.raftery@berkeley.edu) (p.raftery@berkeley.edu) and [Stefano Schiavon](mailto:schiavon@berkeley.edu) (schiavon@berkeley.edu) for inquiries about or suggested improvements to this guidebook.