

Lawrence Berkeley National Laboratory

Recent Work

Title

Comparison of Conventional Mixing and Displacement Air Conditioning and Ventilating Systems in U.S. Commercial Buildings

Permalink

<https://escholarship.org/uc/item/22p814cp>

Authors

Seppanen, O.

Fisk, W.J.

Eto, J.H.

et al.

Publication Date

1989-02-01

e. 2



Lawrence Berkeley Laboratory

UNIVERSITY OF CALIFORNIA

APPLIED SCIENCE DIVISION

To be presented at the 1989 Summer Meeting of ASHRAE,
Vancouver, B.C., Canada, June 24-28, 1989, and
to be published in ASHRAE Transactions

RECEIVED
LAWRENCE
BERKELEY LABORATORY

MAY 18 1989

LIBRARY AND
DOCUMENTS SECTION

Comparison of Conventional Mixing and Displacement Air Conditioning and Ventilating Systems in U.S. Commercial Buildings

O. Seppanen, W.J. Fisk, J. Eto, and D.T. Grimsrud

February 1989

TWO-WEEK LOAN COPY

*This is a Library Circulating Copy
which may be borrowed for two weeks.*

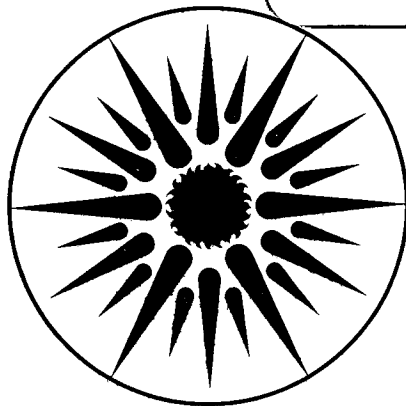

**APPLIED SCIENCE
DIVISION**

e. 2
LBL-26816

DISCLAIMER

This document was prepared as an account of work sponsored by the United States Government. While this document is believed to contain correct information, neither the United States Government nor any agency thereof, nor the Regents of the University of California, nor any of their employees, makes any warranty, express or implied, or assumes any legal responsibility for the accuracy, completeness, or usefulness of any information, apparatus, product, or process disclosed, or represents that its use would not infringe privately owned rights. Reference herein to any specific commercial product, process, or service by its trade name, trademark, manufacturer, or otherwise, does not necessarily constitute or imply its endorsement, recommendation, or favoring by the United States Government or any agency thereof, or the Regents of the University of California. The views and opinions of authors expressed herein do not necessarily state or reflect those of the United States Government or any agency thereof or the Regents of the University of California.

To be presented at the 1989 Summer Meeting of the American Society of Heating, Refrigerating, and Air Conditioning Engineers, June, 1989, Vancouver, B.C. and published in ASHRAE Transactions

COMPARISON OF CONVENTIONAL MIXING AND DISPLACEMENT AIR CONDITIONING AND VENTILATING SYSTEMS IN U.S. COMMERCIAL BUILDINGS

Olli Seppanen*, William J. Fisk, Joe Eto, David T. Grimsrud

Indoor Environment Program
Applied Science Division
Lawrence Berkeley Laboratory
1 Cyclotron Road
Berkeley, CA 94720

February 1989

The work was supported by the Assistant Secretary for Conservation and Renewable Energy, Office of Building and Community Systems, Building Systems Division of the U.S. Department of Energy under Contract DE-AC03-76SF00098 and by the Finnish Academy of Science.

*Professor on Mechanical Engineering, Helsinki University of Technology, Helsinki, Finland. This work was performed during a sabbatical at Lawrence Berkeley Laboratory.

ABSTRACT

During the last few years, a new displacement air distribution system with low velocity air supplied directly to the occupied zone and a displacement flow in the floor-to-ceiling direction has been introduced into office buildings in the Scandinavian countries. The purpose of this study was to evaluate displacement air distribution systems and compare their performance to the performance of traditional variable and constant air flow systems in U.S. office buildings. The loads of a typical large U.S. office building were calculated in four representative U.S. climates (Minneapolis, Seattle, Atlanta, El Paso) with the DOE-2.1C buildings simulation program. The hourly loads and hourly weather data were used as inputs for new computer programs that simulated system performance. Energy consumption, air quality, thermal satisfaction, and the cost of the systems were calculated for three building zones (south, north, core) in each climate. The displacement systems were simulated using results from recent laboratory measurements. The results indicate that displacement systems generally yield superior air quality and thermal comfort compared to conventional systems with air recirculation. The energy consumed by displacement systems with heat recovery or VAV flow control was similar to the energy consumption of conventional air distribution systems operated with recirculation. However, the first cost of displacement systems is substantially higher than the first cost of conventional systems when the maximum cooling load exceeds 13 Btu/h-ft² (40 W/m²) and cooling panels are required. The energy consumption of the traditional VAV systems was low. However, indoor air quality can deteriorate significantly if the combination of minimum supply air flow and minimum outdoor air entry into the air handler do not bring an adequate amount of outdoor air to each region of the building.

INTRODUCTION

Traditionally, the conditioned supply air in a commercial building has been mixed well with room air by special arrangements of air supply diffusers with the primary goal of achieving uniform temperature in the space. Ventilation systems that mix supply and indoor air have been used in virtually all commercial buildings prior to the late 1970s. Instances and perceptions of deteriorated indoor air quality have caused more attention to be paid to the distribution of supply air and to pollutant removal from a ventilated space. Recently, new ways to supply air have been investigated and introduced. The best known is the displacement flow system where air that is slightly cooler than room air is supplied with low velocity to the occupied zone and air is removed at ceiling level. The major goal of this system is to control the environment in the occupied zone of the room, not necessarily in the whole space. When the supply air temperature is lower than room temperature (and, thus, the supply air is more dense than room air) a displacement or piston-like flow pattern in the floor-to-ceiling direction is promoted. Displacement systems create larger vertical gradients of temperature and pollutant concentration than occur with a traditional mixing flow system. A typical configuration of a displacement air distribution system and temperatures is shown in Figure 1.

Displacement ventilation has been used previously in industrial halls with large room height and heat loads with the intention of controlling the environment at the occupied level. In the late 1970s, displacement ventilation was introduced into other types of buildings. The majority of applications are in Scandinavian countries, particularly Norway.

Displacement ventilation systems usually supply 100% outdoor air. This, of course, leads to better air quality but may also lead to higher energy consumption than traditional air distribution systems with air recirculation and economizer cycles. However, the influence of outdoor air supply rates on the energy consumption of a typical office building with a

traditional ventilation system was surprisingly low in a recent study (Eto and Meyer 1988). These findings may make 100% outdoor air systems more attractive in many climates.

The cooling capacity of the air in displacement systems is limited by the high supply air temperature and low flow rates that are chosen to satisfy comfort criteria. Applications with a high cooling load may require radiant cooling panels or other supplementary cooling devices; thus, displacement ventilation may have a higher first cost.

The main differences between "mixing systems" (traditional systems that promote mixing of the indoor air) and displacement air distribution systems have been reported in several laboratory studies (Skaret and Mathisen 1983; Sandberg 1983). The advantages of displacement flow patterns in removing air contaminants have also been shown using a two-zone model (Malmstrom and Ahlgren 1981; Sandberg 1981). Previous reports indicate that displacement ventilation has many attractive features and may be applicable to the U.S. conditions. Reductions in both first cost and energy costs have been reported with displacement systems (Mathisen et al. 1985). Most of the detailed performance data are from laboratory-based tests (Mathisen and Skaret 1983; Palonen et al. 1988). However, existing information has not been adequate for firm conclusions regarding the suitability of displacement ventilation in the U.S. Before any experimental work was begun, it was felt that simulations should be completed. This paper describes the methods and results of simulation-based comparisons of typical mixing and displacement air distribution systems in different climates. Energy consumption and indoor environmental conditions were evaluated using a computer simulation and first costs were estimated based on published unit cost data and information provided by manufacturers.

METHODS

Simulations

A well-documented large high-rise office building was selected for the analysis. The building was placed in four different U.S. climates. Its loads for exterior and interior zones were calculated using the loads section of the DOE-2.1C building simulation program. The hourly loads and hourly weather data were then used as inputs for computer programs (written for this study) which simulated for each hour the performance of displacement and mixing air distribution systems. Based on the hourly heating or cooling loads and ventilation systems data, the supply and return air flow rates and the room air temperatures were computed. These results were used to determine air temperatures in economizer or heat recovery systems. The next major set of routines computed energy usage, pollutant concentrations, and the percentage of occupants that are dissatisfied with the thermal environment. Finally, the operating costs for energy were computed using typical energy prices and the first costs of the systems were compared primarily through the use of published information on unit costs. All calculations were completed for the north, core, and south zones of the building.

A basic assumption in all available building energy simulation programs has been the uniformity of the temperature in each zone; thus, these programs cannot distinguish the differences between displacement systems, with larger vertical gradients in temperature and pollutant concentration, and systems that aim to fully mix the indoor air. This is the primary reason why new programs were required that simulated the major properties of the systems. Relatively simple models for the systems were employed because the major goal of the project was to compare the performance of the systems, not necessarily to calculate absolute performance values.

The calculation of vertical gradients in air temperature and pollutant concentration based on basic physical principles was impractical. Instead, data on the gradients were taken from laboratory measurements and used as inputs to the programs.

Building Description and Operating Schedules

The building model used in the simulation was originally developed for evaluations of revisions of energy conservation standards by Battelle Pacific Northwest Laboratories (1983). For the present analysis, only one building (originally designed for the Washington, D.C., climate) was used for the DOE-2.1C runs. However, the loads for two colder climates were modified so that the envelope of the building met the prescriptive criteria for federal buildings (Federal Register 1987). Operating schedules were taken from the Standard Building Operating Conditions developed for the Building Energy Performance Standards (U.S. DOE 1979). Systems were assumed to operate only between 8 and 19 hours for a total of 4015 hours per year. The major features of the building are summarized in Table 1 and heat transmission coefficients of the envelope in Table 2. The building has been used previously in related studies (Eto and Meyer 1988).

Climate

Four weather conditions were used in the simulation. Minneapolis represents a cold continental climate, Seattle, a mild coastal climate, Atlanta, a hot and humid climate, and El Paso, a hot and dry climate. Heating degree days with a 65 °F base in the four climates, respectively, are 8130, 5530, 3210, and 2870 °F-d (100,000, 63,400, 36,800, and 32,700 °C-h with a 17 °C base). Cooling degree days with an 80 °F base in these four climates are 98, 10, 150 and 506 °F-d (3090, 502, 5240, and 12,400 °C-h with a 24 °C base). The hourly weather data used in the simulations were from the Weather Year for Energy Calculation (WYEC) series developed for ASHRAE (Crow 1981).

Systems

A variable air volume system with reheating was selected as a typical system for exterior zones (without reheating for interior zones). All simulated VAV-systems had the economizer cycle or a heat recovery system. Constant volume (variable supply air temperature) systems with an economizer or heat recovery system or with neither of these features were also simulated. Displacement systems had either temperature control of supply air and

constant flow or both temperature and flow control of supply air. Displacement systems did not recirculate air; however, heat recovery from exhaust air was used in one system. Major system variables were the same for all alternatives (Table 3). The simulated systems are described in Table 4.

PRINCIPLES OF SIMULATION

Loads and Sizing of Systems

The hourly heating and cooling loads generated by the loads section of the DOE-2.1C simulation program are based on an assumption that the indoor temperature is constant (during occupancy) at the desired (thermostat setpoint) temperature. A recalculation of loads based on actual indoor temperatures, which vary from the setpoints primarily due to thermostat dead bands, was considered unnecessary. Descriptive data for the loads are presented in Table 5. Systems were sized based on the maximum loads and weather conditions. The maximum cooling load and a maximum temperature difference between room and supply air of 22 ° F (12 ° C) were used to select the supply air flow of the mixing systems. In the displacement system, the supply air flow was selected based on maximum cooling capacity of air and maximum allowable temperature difference between room [at a height of 2.6 ft (0.8 m)] and supply air temperatures.

Temperature and Humidity Control

An ideal proportional controller was assumed for temperature control. The proportional band was 3.6 ° F (2 ° C) for heating and cooling. No dead band or hysteresis were simulated. Room temperature was 75 ° F (24 ° C) during maximum cooling and 68 ° F (20 ° C) during maximum heating. The maximum humidity ratio for indoor air was 0.012 based on ASHRAE's recommendations (ASHRAE 1981). If necessary, the supply air was cooled and reheated in all systems to maintain the humidity below upper humidity limit. No humidification was used.

Central Equipment

A centrifugal water chiller with maximum COP = 4 was used in all systems. The part load data were taken from the DOE-2.1C system data (LBL 1984). The total pressure drop of the air-handling system and ductwork was assumed to be 7.6 IWG (1900 Pa) for VAV systems and 3.8 IWG (950 Pa) for constant volume systems. In VAV systems, a variable speed fan was used with maximum total efficiency of 60%. Part load power demand for the fans was calculated as in the DOE-2.1C simulation program (LBL 1984).

CONTROL STRATEGIES

Constant Volume Displacement System

The heating or cooling capacity of the constant volume displacement of the supply air system was controlled by varying the supply air temperature primarily by controlling the amount of cooling but using reheat if excessive cooling of the supply air was necessary for humidity control. The air flow was constant both in the cooling and heating mode. The critical performance criteria for the displacement system is the maximum cooling load which can be removed from the space without violating thermal comfort criteria. If the supply air is too cold, the vertical temperature gradient in the space will cause discomfort. High supply air flow reduces the gradient but can cause discomfort due to drafts.

Initial full-scale experiments (Mathisen and Skaret 1983; Esdorn et al. 1987) suggested maxima for cooling loads of 6-10 Btu/h-ft² (20-30 W/m²). However, more recent experiments (Palonen et al. 1988) show that well-designed displacement diffusers can handle loads up to 13 Btu/h-ft² (40 W/m²) without an increase in discomfort. If the cooling load exceeds this value, the simulated systems have ceiling-mounted radiant cooling panels to remove the excess heat. The maximum temperature difference between room air at 2.6 ft (0.8 m) height and supply air is 9 ° F (5 ° C). With cooling loads greater than 13 Btu/h-ft² (40 W/m²), the temperature difference between room air and supply air remains constant

even if the exhaust air and room temperatures continue to increase as illustrated in Figure 2. During the heating demand (minimum loads side of Figure 2), the supply air temperature is increased so that the load is met.

Variable Air Flow Mixing System

The schematic of variable air flow mixing system is shown in Figure 3 and the control strategy is illustrated in Figure 4. Cooling is controlled by the supply flow rate until minimum flow is reached. The supply air temperature difference stays constant down to this point. With smaller cooling loads, the supply air temperature is increased (via less cooling and reheat if necessary for humidity control) and the supply flow maintained at its minimum value. The supply air temperature is further increased to meet the heating load. The supply air temperature was controlled by cooling only. Reheating was used only when air was dehumidified by cooling to a temperature that was lower than the required supply air temperature.

Economizer

An economizer is used with most mixing systems. The economizer cycle (Figure 5) allows the system to control the use of outdoor air for better energy economy. The dampers controlling outdoor air, exhaust air, and return air are positioned so that the desired temperature of the mixture of return air and outdoor air is obtained. When the outdoor air is very warm or cold, the minimum amount of outdoor air is used to conserve energy and reduce the required capacity of heating and cooling equipment. The minimum outdoor air flow meets the minimum ventilation criteria of 20 cfm (10 L/s) per occupant even when a minimum amount of air is being supplied by a VAV system. Although the core zone ventilation systems contained an economizer, this system supplied 100% outside air due to the combination of low loads and the requirements for this minimum outdoor air supply.

Except in core zone systems, more outdoor air is used during times of moderate outdoor temperatures. A maximum amount of outdoor air is used only when the outdoor tempera-

ture is between exhaust and supply air temperatures. In theory, minimum outdoor air should be supplied whenever the outdoor air enthalpy exceeds the exhaust air enthalpy. However, enthalpy is seldom used for the control because of difficulties in the measurement; instead economizer control is based on temperature measurements. To compensate for the use of temperatures in place of enthalpy, the economizer changes to minimum outdoor air when the outdoor temperature is still a few degrees below the exhaust air temperature. This temperature difference, ΔT , is illustrated in Figure 5. In the simulation we used a fixed ΔT of 4 ° F (2 ° C).

Displacement System with VAV Control

The control strategy for displacement ventilation with combined flow rate and temperature control is illustrated in Figure 6. As noted above, the maximum cooling capacity is limited to 13 Btu/h-ft² (40 W/m²); loads exceeding this are removed with radiant cooling panels. Cooling capacity is controlled by varying flow rate until the minimum supply flow rate is reached. When the cooling load decreases further, the supply air temperature is increased (by less cooling) so that small cooling loads are met. Reheat is used during heating demand or whenever the supply air temperature is too low due to precooling necessary for dehumidification.

Heat Recovery

Heat is recovered from the exhaust air using a heat exchanger with capacity control (normally a heat wheel with a variable speed of rotation). During heating of the zone, heat is recovered at full capacity when the required supply air temperature is higher than the output temperature of heat exchanger with its maximum temperature efficiency. With higher outdoor temperatures, the efficiency of heat recovery is controlled (reduced) so that the output temperature of the heat exchanger is the same as the desired supply air temperature. During cooling of the zone, the heat exchanger is not operated when the required supply air temperature is lower than outdoor temperature until outdoor tempera-

ture exceeds the exhaust temperature -- in which case the heat exchanger is used to cool the outdoor air with exhaust air. The maximum temperature efficiency of the heat exchanger was 70%.

AIR QUALITY

Pollutant Removal Effectiveness

The oldest and best-known measure to characterize a system's ability to carry away pollutants is the pollutant removal effectiveness

$$E_c = \frac{C_e}{C_o} \quad (1)$$

where: C_e is the pollutant concentration in exhaust air, and C_o is the spatial average pollutant concentration in the occupied zone (or, in some cases, the entire room). The names *ventilation efficiency* and *ventilation effectiveness* are also sometimes used for E_c . For mixing ventilation systems, a value of unity was used for E_c .

The pollutant removal effectiveness depends on the air flow patterns and pollutant source characteristics. Data from laboratory measurements have been used to evaluate the pollutant removal effectiveness of displacement systems. Because of the vertical variation in concentration, the value of C_o and, thus, the actual value of pollutant removal effectiveness depends on the distance from the floor used to define the occupied zone. The smaller the distance, the higher the effectiveness. Effectiveness usually increases also with system flow rate. Strong local convective heat sources may disturb the flow pattern in the room and decrease the pollutant removal effectiveness.

Extensive measurements of pollutant removal effectiveness have been made in full-scale office rooms (Mathisen and Skaret 1983) with simulated sources of the pollutants emitted by humans. The results depend on the locations of the sources and specific methods of air distribution. Effectiveness values up to 10 were reported; however, a conservative estimate of $E_c = 2$ has been used in the model for displacement ventilation systems during

cooling period simulations. During heating with displacement systems, pollutants and air are assumed to be completely mixed which gives a pollutant removal effectiveness of unity.

Hypothetical Pollutant Source in All Rooms

The air distribution system will affect the air quality in the space both through the rate of supply of outdoor air and the pollutant removal effectiveness. Assuming a constant and uniformly distributed pollutant source, a relative room air concentration of a hypothetical pollutant was calculated from the mass balance equation

$$C_R = \frac{Q_{REF}}{Q_O E_C} C_{REF} \quad (2)$$

where: Q_{REF} is the reference outdoor air flow rate with complete mixing ($E_C = 1$), C_{REF} is the concentration with the flow Q_{REF} , Q_O is the actual outdoor air flow rate, and E_C is the pollutant removal effectiveness. Equation 2 yields the spatial average concentration in the occupied zone (since E_C is based on this spatial-average concentration). This concentration is not necessarily identical to the average concentration in air that is inhaled by building occupants. A reference air flow rate of 20 cfm (10 L/s) per person was selected. We assumed that the filters in the ventilation systems did not remove this hypothetical pollutant. The equation assumes that the pollutant source is located in the ventilated rooms and that its source strength is independent of ventilation rate.

Tobacco Smoke Source in Subset of Rooms

When the pollutant source is in a subset of rooms within a zone (or in the return air ducts of the ventilation system), the use of recirculation air will expose more occupants to the pollutants. The exposure depends on the removal effectiveness of the system and the extent of dilution of the pollutant.

The suspended particles generated by smoking were used as an example of a pollutant generated in selected rooms. Tobacco smoke particle concentrations in the nonsmoking and smoking areas were calculated assuming that one-third of the occupants smoke two

cigarettes per hour (Committee on Indoor Pollutants 1981) in smoking areas and each cigarette generates 15 mg of particles (Offerman et al. 1984). With the typical cigarette smoke particle size, the mass median diameter is 0.5 μ m (Offerman et al. 1984). For this size of particles, most of the commonly used return air filters have low removal efficiency. For a filter with a dust spot efficiency of 50% (Eurovent class EU 5/6), the particle removal efficiency is 20-40% for particle size of 0.5 μ m. A removal efficiency of 20% was used in the calculations. The concentration of tobacco smoke particles in the smoking area was calculated from the equation (based on a mass balance)

$$C_T = \frac{\dot{m}\alpha}{x \cdot Q_0} + \frac{\dot{m}(1-\eta)(1-\alpha)}{Q_0\left(1 + \frac{\eta(1-\alpha)}{\alpha}\right)} \quad (3)$$

where: C_T is the particle concentration in smoking areas, \dot{m} is the particle generation rate, α is outdoor air ratio (outdoor air supply divided by total air supply), η is the removal efficiency of filters located in the supply air stream, and x is the ratio of return air flow from smoking areas to the total return air flow (in calculation $x=0.5$).

Note that, due to a lack of experimental data on the effectiveness in removing tobacco smoke, a pollutant removal effectiveness is not included in Equation 3. Instead, Equation 3 is based on an assumption of perfect mixing of the tobacco smoke particles in the smoking area. Such an assumption will lead to an overprediction of tobacco smoke concentrations at the breathing level in rooms with displacement ventilation. However, the more important influences of ventilation rates, recirculation, and filtration are accounted for in this analysis.

For the nonsmoking areas where the presence of tobacco smoke particles is due to the delivery of recirculated air, the concentration was calculated from equation

$$C_{TN} = \frac{\dot{m}(1-\eta)(1-\alpha)}{Q_0} \left(1 + \frac{\eta(1-\alpha)}{\alpha}\right) \quad (4)$$

where: C_{TN} is the particle concentration in the nonsmoking areas, and η, α, Q_0 are as in Equation (3).

These calculations are based on a simplifying assumption that transport of particles from the smoking to the nonsmoking areas is solely via recirculation in the ventilation system. Transport due to air flows within the occupied space is neglected. This assumption will cause particle concentrations in the smoking areas to be overestimated and concentrations in nonsmoking areas to be underestimated at least in situations where the smoking and nonsmoking areas are not physically isolated. The deposition of tobacco smoke particles on indoor surfaces or on components of the ventilation system other than filters is also neglected.

Vertical Temperature Gradients

The vertical temperature gradient in the room influences the predicted energy performance and thermal comfort. For example, energy demands on chillers will be reduced during periods of cooling if the air in the occupied region of the rooms has a lower temperature than the air that exits the rooms. Laboratory data for the temperature gradient have been used in the model. The gradient is often characterized by the temperature efficiency, E_T , of the air distribution system. The temperature efficiency is defined similar to the pollutant removal effectiveness

$$E_T = \frac{T_E - T_S}{T_R - T_S} \quad (5)$$

where: T_E is the exhaust air temperature, T_R is the room temperature, and T_S is the supply air temperature. This quantity is used to calculate the required supply air temperature when the room temperature and load are known.

The height at which the temperature describes the thermal environment is an important parameter. In the office environment, this height should reflect the thermal sensation of a sitting person; thus, the air temperature at the height of 2.6 ft (0.8 m) has been used as room temperature.

The temperature gradient has been measured in small office rooms with various supply air diffusers and room loads (Mathisen and Skaret 1983; Palonen et al. 1988; Esdorn et al. 1987). Mathisen and Skaret (1983) define the gradient with the ratio

$$E_{T0} = \frac{T_E - T_0}{T_E - T_S} \quad (6)$$

where: T_0 is the temperature 0.16 ft (0.05 m) above floor and 2.0 ft (0.6 m) from the supply air opening of the displacement ventilation system, T_E is exhaust air temperature, and T_S is supply air temperature.

An empirical formula is given for E_{T0}

$$E_{T0} = 2.7 u_o^{0.47} h_o^{0.45}$$

where: h_o is the height (m) of the supply air opening, and u_o is the air velocity (m/s) in the supply air opening.

The relationship between temperature efficiency E_T and E_{T0} is

$$E_T = \frac{1}{1 - \left(1 - \frac{h}{H}\right) E_{T0}} \quad (7)$$

where: h is the height of the defined room temperature, H is the room height, and E_{T0} is the temperature gradient parameter defined in Equation (6).

The experimental range of E_{T0} was 0.3 to 0.7 with an average 0.5, which has been used in simulation. With room height of 10 ft (3.0 m) and room temperature defined at the height of 2.6 ft (0.8 m), the average temperature efficiency becomes 1.58 and the range is 1.28 to 2.

The typical temperatures for displacement ventilation are illustrated in Figure 1. Mathisen and Skaret (1983) warn that the results should not be applied for other rooms. However, independent measurements (Palonen et al. 1988) in an office room with displacement air diffusers constructed by three manufacturers support the data by Mathisen and Skaret.

Outdoor Air Supply Rates

When comparing the systems, one of the most important factors is the design minimum flow rate of outdoor air. Ventilation standards specify the ventilation rate per occupant. At the design stage, however, the design must often be based on the assumed occupant density. Because the heating and cooling needs are usually estimated per floor area, it is practical for design calculations to be based on ventilation rate per floor area. A recent study (Turk et al. 1986) of 38 commercial buildings in the northwestern region of the U.S. showed the range of outdoor air supply to be 0.1 to 0.7 cfm/ft² (0.5 to 3.5 L/s-m²) with a mean of 0.3 cfm/ft² (1.5 L/s-m²) and standard deviation of 0.2 cfm/ft² (0.8 L/s-m²). In the same study, the average *minimum* outdoor air supply for a subset of 14 buildings was 20 cfm (10 L/s) per occupant. This is also the minimum outdoor air supply rate per person in office buildings in the proposed new ASHRAE ventilation standard (ASHRAE 1987). The proposed standard and the current standard (ASHRAE 1981b) both recommend an occupant density of seven persons per 1000 ft² (100 m²) for design purposes if actual occupancy is not known. Converting to an outdoor air flow rate per floor area yields 0.14 cfm/ft² (0.7 L/s-m²). If the ceiling height is 9 ft (2.7 m), the nominal air exchange rate would be 0.9 h⁻¹.

All except one of the systems were designed and operated with minimum outdoor air supply of 0.14 cfm/ft² (0.7 L/s-m²). This limited the maximum flow rate of recirculated air and in some cases, where loads are low, even the minimum supply air flow in VAV systems. For comparison, a VAV system with minimum outdoor air ratio of 0.15 and minimum supply air ratio (ratio of minimum to maximum total rate of air supply) of 0.3 was also simulated. In this system, the minimum outdoor air supply of 20 cfm (10 L/s) per occupant was not maintained.

COMFORT

With the mixing flow pattern, a relatively uniform room temperature has been easy to obtain and the incidence of drafts has been the most important factor leading to thermal discomfort. With displacement ventilation, the vertical temperature gradient is increased,

which may cause thermal discomfort even though the average temperature would be comfortable. In general, draft is not a problem with displacement systems when occupants are a reasonable distance from the supply-air diffuser.

The discomfort caused by a vertical temperature gradient has been studied in a climate chamber (Olesen et al. 1979). The results, presented as the percentage of dissatisfied occupants (Figure 7), have been used to evaluate thermal discomfort with displacement system. Because the temperature gradient varies with thermal loads, the percentage dissatisfied is also a function of loads.

With the mixing flow pattern, the maximum air velocity in the occupied region depends on the air distribution pattern and room loads. Several investigators have collected experimental data that relate air exchange rate, cooling load and maximum velocity. Some of the results from the laboratory and field (Palonen et al. 1988; Larkfeldt 1987; Heiselberg and Nielsen 1987; Kovanen et al. 1987) are presented in Figure 8. The importance of good air distribution with respect to draft and the relationship between room air velocity and supply air flow rate are illustrated.

To evaluate the percentage of dissatisfied occupants because of draft, the following relationship between maximum velocity and supply air was developed and used

$$v_{\max} = 0.0417n \quad (8)$$

where: v_{\max} is the spatial maximum velocity (m/s) of air in occupied zone (this velocity is also a mean value with respect to the short-term fluctuations in velocity), and n is supply air flow per floor area divided by room height (1/h). The discomfort caused by air flow depends on time-average (average with respect to short-term fluctuations) velocity, temperature, and nature of flow. With typical turbulent flow, the relationship between percentage of dissatisfied, time-average velocity of air, and air temperature is given by Equation (9) (Fanger and Christensen 1986, 1987).

$$PPD = 13800 \left(\frac{\bar{v} - 0.04}{t_a - 13.7} + 0.0293 \right)^2 - 0.000857 \quad (9)$$

where: PPD is predicted percentage of dissatisfied, \bar{v} is time-average velocity (m/s), and t_a is air temperature ($^{\circ}$ C). Values of v_{\max} from Equation 8 were input into Equation 9 to estimate PPD. The equation is valid for air temperatures from 66 to 80 $^{\circ}$ F (19 to 26.5 $^{\circ}$ C) when the PPD is smaller than 40%.

RESULTS

The major criteria in the design process are the quality of the indoor environment, first cost, and cost of operating the system. The quality of the indoor environment is indicated by the air quality and thermal satisfaction. First cost depends mainly on the selection of a system and the required capacities of air flow, heating and cooling. The major operating cost consists of the cost of energy. The relative importance of the value of each component in the performance of the systems is subjective, therefore, no attempt has been made to combine all the factors. The scope of this paper also limits the data presented. Energy consumption per unit floor area and average concentrations of a hypothetical pollutant (generated uniformly throughout the building) in all four climates and in the south zone are given in Figure 9, which also gives data from northern and core zones in Minneapolis. The time average concentration of a hypothetical pollutant is presented in relative units. The time average predicted concentrations of tobacco smoke particles in smoking and nonsmoking areas are illustrated for Minneapolis in Figure 10.

The first cost of the systems is mainly influenced by supply air flow and maximum cooling and heating capacity. No attempt has been made to calculate absolute cost of each system. Instead, cost differences relative to the cost of the variable air volume system with economizer (System 1) have been calculated for each system. The results for Minneapolis climate are shown in Figure 11. The unit costs used in the analysis are presented in Table 6. The cost of the standard equipment is taken from published U.S. cost data books (R.S. Means 1988; Lee Saylor 1986). The cost of heat recovery equipment, cooling panels, and displacement ventilation diffusers are based on the data from manufacturers.

Finally, the time average predicted percentage of occupants that are dissatisfied with the thermal environment is presented in Table 7.

DISCUSSION

Air Quality and Energy

The air quality is described using the average concentration of a uniformly generated hypothetical pollutant in the space and the predicted tobacco smoke concentrations. Energy consumption comparisons are based on the sum of heat and electricity requirements, where electricity consumption includes fans and compressors. The air quality, in general, is best with constant volume systems without an economizer or recirculation. The displacement systems, however, lead to similar air quality with better energy economy. The climate or loads seem to have no major influence on this ranking. Only when the loads are very high (in the southern zone) does the air flow in constant flow systems without recirculation become high enough to give substantially better air quality than that provided by a displacement system; however, in these instances the constant volume systems require substantially more energy.

Tobacco smoke concentrations, within smoking areas, are highest with the VAV systems; particularly the system with a minimum outdoor air ratio of 15%. The lowest predicted tobacco smoke concentrations within smoking zones occur for a constant volume system without recirculation that serves south zones. The high outside air flows in this situation lead to low concentrations and high energy consumption. Based on Figure 10, recirculation of indoor air from smoking zones to nonsmoking zones results in significant concentrations of tobacco smoke particles in the nonsmoking areas.

The high use of energy probably precludes the use of the constant flow system except in interior zones where a constant flow system with heat recovery seems to be a reasonable alternative in all climates.

The VAV-performance of displacement systems does not change the air quality or energy consumption significantly in colder climates (Minneapolis and Seattle). Heat recovery improves the energy performance of displacement systems in all climates without any deterioration of air quality. Energy savings due to heat recovery are larger in colder climates.

With respect to energy consumption, the displacement system seems to perform better in warm climates, particularly in El Paso where the savings in heating due to traditional VAV operation are not so significant. The energy performance of the displacement systems can be improved with VAV-control in warm climates.

The worst average air quality is obtained with the VAV system with an economizer cycle with the minimum outdoor air ratio of 0.15 because outside air supply rates are low when loads are small. The good energy economy of this system is obtained at the expense of poor air quality. The results are consistent in all climates and zones. Even if the minimum outdoor air ratio is increased to 0.3, the outdoor air supply can be less than the 20 cfm (10 L/s) per occupant specified in the draft revised ASHRAE ventilation standard. The average air quality is substantially better when the VAV system with economizer is controlled so that the minimum outdoor air supply per occupant is guaranteed, irrespective of thermal loads.

The VAV system with economizer and a guaranteed minimum outdoor air flow per occupant still consumed the second lowest amount of energy for zones with high loads (south zone) in all climates except El Paso where the displacement system with heat recovery consumed slightly less energy. However, with lower loads (north and core zones) both the VAV system with heat recovery and constant flow system with economizer became more attractive with respect to energy consumption. Among these, the VAV-system with heat recovery gives better air quality.

First Cost

The first cost of a system is extremely difficult to estimate. The most accurate cost values would be obtained only through a complete design and bidding process. While comparing systems, the interest is mainly on the relative costs. In this study, the basic variable volume system with economizer and a minimum outdoor air flow 20 cfm (10 L/s) per person (System 1) was selected as the baseline. The cost of other systems was compared to the cost of System 1. The cost difference in heating was estimated based on actual heating power required. Only boilers and burners were considered. The maximum cooling demand was used to estimate the cost of additional mechanical cooling equipment such as chillers and cooling towers. Maximum supply air flow was used to estimate the cost of air-handling equipment except for air diffusers, whose cost was assumed to be dependent only on the type of distribution system and floor area. The cost of heat recovery equipment depended only on the air flow.

The most difficult and important item in the estimates of relative first cost is the price of cooling panels required in displacement systems to supply additional cooling. Because these systems are not used in the U.S., a Scandinavian market price was used and converted to the U.S. dollars per watt of cooling capacity.

The results of the cost comparison are presented in Figure 11 as the difference between incremental and baseline costs for the Minneapolis climate. The results are similar for other climates. The first cost decreases if the minimum outdoor air is decreased or the system operates with constant flow with an economizer cycle. The cost increases substantially with a displacement system in north or south zones due to the additional cooling panels. In the core zone, which may be a large fraction of the total floor area in a large building, and where the cooling load is so low that panels are not required, the cost increase for displacement ventilation is small.

Energy Cost

The cost of energy is also compared to the energy costs of the basic VAV system. The possible influences of peak demand on energy cost have not been included. The results are presented in Figure 11 for Minneapolis conditions where typical cost of electricity is 5.7 cents/kWh and typical cost of natural gas is 1.3 cents/kWh. As expected, the results indicate that energy costs can be decreased by decreasing the minimum outdoor air flow (System 2). The increase of energy costs is significant with constant air flow systems without an economizer. The displacement systems with heat recovery or VAV flow, which provide an excellent air quality and thermal environment, differ little in energy cost from the baseline.

Thermal Environment

The thermal environment is evaluated by estimating dissatisfaction to draft or to the vertical temperature gradient. The results in Table 7 show the average percentage of dissatisfied persons. In general, the displacement ventilation provides better thermal comfort except in core zones where the supply air flow and, thus, incidence of drafts is low even with mixing flow pattern.

In general, the higher the average supply air flow rate, the higher the predicted percentage of dissatisfied. With constant flow systems and mixing flow pattern, the flow rate becomes so high in south zones that the evaluation of discomfort is out of the range of available data.

Reliability of Results

A simulation of this type involves numerous assumptions that may significantly influence the results. This analysis has been based on our estimates of typical or reasonable values for many parameters and we have not investigated the sensitivity of results to these estimates. In addition, the results apply only for the specific ventilation systems and control methods that were modeled.

We expect that our assumptions regarding the temperature efficiency of displacement systems, the efficiency of the heat recovery system, and minimum outside air supply rates have a significant influence on the relative energy performance of the systems. The comparisons of air quality associated with the different systems are expected to be most sensitive to the assumed value of pollutant removal effectiveness of the displacement systems, the minimum outside air supply rates, and the simplifying assumption that tobacco smoke transport from smoking to nonsmoking areas results only from mechanical recirculation. A conservative (low) estimate of pollutant removal effectiveness was utilized for these analyses considering available laboratory data. However, few data are available from field settings and sources of heat, natural convection at exterior walls, movements of people in real buildings may disturb displacement flow patterns and reduce pollutant removal efficiencies. The greatest source of uncertainty in the predictions of the extent of thermal dissatisfaction is probably the uncertainty in the relationship between supply air flow rates and indoor velocities (see Figure 8). The assumed value for the temperature efficiency of displacement systems also influences predictions of thermal dissatisfaction. The most critical assumptions regarding the comparisons of system costs are expected to be: the maximum cooling capacity of displacement systems (since estimates vary and costly cooling panels are required when loads exceed this maximum), and factors which influence the need for cooling panels -- the magnitude of internal heat gains, and the thermal characteristics of the building envelope. Improvements in the building envelope would make the displacement systems more attractive while increased internal heat gains would make the displacement system less attractive. Future simulations should include an investigation of the sensitivity of results to these assumptions.

CONCLUSIONS

Displacement ventilation seems to create much better average air quality in the occupied zone than traditional mixing VAV systems with recirculation. Displacement ventilation systems do not have much influence on the energy consumption; however, their first cost

is significantly increased due to required cooling panels if the cooling load exceeds 13 Btu h-ft² (40 W/m²). Displacement systems also create a better thermal environment than mixing systems.

VAV systems perform with good energy economy and low first cost. Their drawback lies in the potentially high pollution concentrations if the combination of minimum supply air flow rate and minimum outdoor air ratio is not selected based on actual needs. The minimum outdoor air ratio should be always calculated individually for each air-handling unit based on loads in the zone served by the unit.

The constant flow systems with an economizer performed surprisingly well with respect to energy consumption and used less energy than some VAV systems. This is because the constant and low supply air temperature in VAV systems requires more mechanical cooling than is required with constant flow systems that use a greater flow and higher supply air temperature. This finding indicates that large air-handling units with constant supply air temperature be avoided. Better energy economy and air quality will be obtained with smaller units and a variable supply temperature.

ACKNOWLEDGMENTS

The work was supported by the Assistant Secretary for Conservation and Renewable Energy, Office of Building and Community Systems, Building Systems Division of the U.S. Department of Energy under Contract DE-AC03-76SF00098 and by the Finish Academy of Science. Bruce Birdsall in the Building Energy Systems Program at Lawrence Berkeley Laboratory provided valuable information and advice for this study.

REFERENCES

- ASHRAE. 1981. ANSI/ASHRAE Standard 55-1981, "Thermal environmental conditions for human occupancy." Atlanta: American Society of Heating, Refrigeration, and Air Conditioning Engineers, Inc.
- ASHRAE. 1981b. ASHRAE Standard 62-1981. "Ventilation for acceptable indoor air quality." Atlanta: American Society of Heating, Refrigerating and Air Conditioning Engineers, Inc.
- ASHRAE. 1987. ASHRAE Standard 62-1981R. Draft, "Ventilation for acceptable indoor air quality." Atlanta: American Society of Heating, Refrigerating and Air Conditioning Engineers, Inc.
- Batelle Pacific Northwest Laboratories. 1983. Recommendations for energy conservation standards and guidelines for new commercial buildings, volume III, Appendix A -- testing assumptions and inputs. U.S. Department of Energy, DOE/NBB-051/7.
- Committee on Indoor Pollutants. 1981. Indoor Pollutants. National Academy of Sciences, National Academy Press, Washington, D.C.
- Crow, L.W. 1981. "Development of hourly data for weather year for energy calculations (WYEC), including solar data at 21 stations throughout the U.S." ASHRAE Trans. Vol. 87, Part 1, pp. 896-906.
- Esdorn, H., Knabl, H., and Kulpmann, R. 1987. "Air-conditioning, new horizon -- new opportunities." Proceedings of the 4th International Conference on Indoor Air Quality and Climate, Vol. 4, pp. 27-42, Berlin. Published by the Institute for Water, Soil, and Air Hygiene, Berlin.
- Eto, J.H. and Meyer, C. 1988. "The HVAC costs of increased fresh air ventilation rates in office buildings." To be published in ASHRAE Trans.
- Fanger, P. and Christensen, N. 1986. "Perception of draught in ventilation spaces." Ergonomics Vol. 29, No. 2, pp. 215-235.
- Fanger, P. and Christensen, N. 1987. "Prediction of draft," ASHRAE Journal, Jan. 1987, pp. 30-31.
- Federal Register. 1987. "Proposed rules." Vol. 52, No. 87. Wednesday, May 6.
- Heiselberg, P. and Nielsen, P. 1987. "The contaminant distribution in a ventilated room with different air terminal devices," Proceedings of Roomvent - 87, Session 5, June 10-12, Stockholm.

- Kovanen, K., Seppanen, O., Siren, K., and Majanen, A. 1987. "Turbulent air flow measurements in ventilated spaces." Proceedings of the 4th International Conference on Indoor Air Quality and Climate. Vol. 3, pp. 329-333. Published by the Institute for Water, Soil, and Air Hygiene, Berlin.
- Larkfeldt, B. 1987. "Full-scale tests for determining air movements and temperature distributions." Proceedings of Roomvent - 87, Session 5, June 10-12, Stockholm.
- LBL Simulation Research Group and Group Q11, Los Alamos National Laboratory. 1984. "DOE-2 reference manual, version 2.1C." LBL 8706 Rev. 4.
- Lee Saylor, Inc. 1986. Current construction costs, 23rd annual edition. Concord, CA. USA.
- Malmstrom, T-G. and Ahlgren, A. 1982. "Efficient ventilation in office rooms." Environment International 8 pp. 401-408.
- Mathisen, H. and Skaret, E. 1983. "Displacement ventilation in small room." SINTEF Report, STF 15 A84047, Norwegian Institute of Technology, Norway.
- Mathisen, H., Sorlie, R., Skjulsvik, B., Bjerken, S., and Solegaard, T. 1985 "Fortrengnings ventilasjon: kongressalen: royal garden hotel." (Displacement ventilation in the congress hall of royal garden hotel.) SINTEF Report A 85044, Norwegian Institute of Technology, Norway.
- Offerman, F.J., Girman, J.R., and Sextro, R.G. 1984. "Controlling indoor air pollution from tobacco smoke: models and measurements." Proceedings of the 3rd International Conference on Indoor Air Quality and Climate. Vol. 1, pp 257-264. Published by the Swedish Council for Building Research, Stockholm.
- Olesen, B.W., Scholer, M., and Fanger, P.O. 1979. "Discomfort caused by vertical air temperature difference." Proceedings of Indoor Climate, pp. 561-539. Danish Building Research Institute, Copenhagen.
- Palonen, J., Majanen, A., and Seppanen, O. 1988. "Performance of displacement air distribution system in a small office room." Proceedings of CIB Conference Healthy Buildings, Sept. 5-8, Stockholm.
- R.S. Means Company, Inc. 1988. Building construction cost data, 46th annual edition. Kingston, MA, USA.
- Sandberg, M. 1981. "What is ventilation efficiency." Building and Environment Vol. 16, No. 2 pp. 123-135.
- Sandberg, M. 1983. "Ventilation efficiency as a guide to design." ASHRAE Trans. Vol. 89, Part 2B, pp. 455-479.
- Skaret, E. and Mathisen, H.M. 1983. "Ventilation efficiency -- a guide to efficient ventilation." ASHRAE Trans. Vol. 89, Part 2B, pp. 480-495.

Turk, B.H., Brown, J.T., Geisling-Sobotke, K., Frolich, D.A., Grimsrud, D.T., Harrison, J., Koonce, J.F., Prill, R.J., and Revzan, K.L. 1987. "Indoor air quality and ventilation measurements in 38 pacific northwest commercial buildings." Lawrence Berkeley Laboratory, LBL-22312 1/2, Berkeley, CA.

U.S. Department of Energy. 1979. "Standard building operating conditions." DOE/CS-0118.

TABLE 1.
Summary of Office Building Characteristics

Size	597,500 ft ² (55,530 m ²)
Shape	38 floors, 2 basement levels, flattened hexagon in cross-section, approximately 18,000 ft ² /floor (1670 m ² /floor)
Exterior walls	4-inch (0.10 m) concrete, polystyrene insulation, air layer, gypsum board
Glazing	25% of wall area, 17% of net floor area, shading coefficient = 0.23
Occupancy	8 a.m. - 6 p.m. weekdays, with some evening work, 30% occupancy on Saturday, no occupancy on Sundays
Internal Loads	83 BTU/h · ft ² (25.8 W/m ²) lighting; 2.4 BTU/h · ft ² (7.7 W/m ²) equipment
Heating Plant	Gas-fired hot water generators (eff. = 75%)
Cooling Plant	Hermetic centrifugal chillers with cooling tower (chillers COP = 4.0)
Zones	For estimates of loads, building divided into north, south, east, and west zones.

TABLE 2.

Heat Transmission Coefficients in $\text{BTU/h} \cdot \text{ft}^2 \cdot ^\circ\text{F}$ ($\text{W/m}^2 \cdot ^\circ\text{K}$)

	Atlanta	El Paso	Minneapolis	Seattle
Exterior Walls	0.16 (0.91)	0.16 (0.91)	0.125 (0.71)	0.19 (0.85)
Windows	1.38 (7.84)	1.38 (7.84)	0.81 (4.6)	0.81 (4.6)

TABLE 3.
Values of the Most Important System Variables

Room temperature set point, °F (°C)	72 (22)
Room temperature during maximum cooling load, °F (°C)	75 (24)
Room temperature with maximum heating load, °F (°C)	68 (20)
Effective temperature of cooling coil, °F (°C)	50 (10)
Total pressure drop of air-handling system and duct work (supply and return together) with maximum supply air flow, IWG (Pa)	
VAV-systems	7.6 (1900)
Constant flow systems	3.8 (950)
Additional pressure drop of heat exchanger for heat recovery, IWG (Pa)	0.6 (150)
Maximum temperature efficiency of heat recovery system, %	70
Maximum total COP of refrigerating system	4.0
Maximum total efficiency of fans, %	60
Room height, ft (m)	9 (2.7)

TABLE 4.
Simulated Systems

System #	Air Distribution	Air Flow	Design Minimum Outdoor Air	Recirculation	Economizer	Heat Exchanger	Min/Max Supply Flow Ratio	Max Cooling by Air Btu/h-ft ² (W/m ²)
1	M	VAV	20 cfm (10 L/s) per occ.	Y*	Y	N	0.3	ALL
2	M	VAV	15% of supply	Y	Y	N	0.3	ALL
3	M	VAV	20 cfm (10 L/s) per occ.	N	N	Y	0.3	ALL
4	M	CV	20 cfm (10 L/s) per occ.	Y*	Y	N	1.0	ALL
5	M	CV	20 cfm (10 L/s) per occ.**	N	N	Y	1.0	ALL
6	M	CV	20 cfm (10 L/s) per occ.**	N	N	N	1.0	ALL
7	D	CV	20 cfm (10 L/s) per occ.**	N	N	N	1.0	13 (40)
8	D	CV	20 cfm (10 L/s) per occ.**	N	N	Y	1.0	13 (40)
9	D	VAV	20 cfm (10 L/s) per occ.**	N	N	N	0.5	13 (40)

M = mixing flow pattern, D = displacement flow pattern, VAV = variable flow system, CV = constant flow system

* When the loads are low (core zone), the recirculation is not used in order to maintain the design minimum outdoor air flow during all conditions.

** The actual minimum outdoor air flow rate is higher than the design minimum because of high supply flow rate requirements due to cooling loads.

TABLE 5.
Heating and Cooling Loads for each Location and Zone

	Atlanta		El Paso		Minneapolis		Seattle	
	Max.	Avg.	Max.	Avg.	Max.	Avg.	Max.	Avg.
North Zones								
Heating (Btu/h · ft ²)	19.6	5.2	16.8	4.3	14.1	4.6	9.1	3.2
Heating (W/m ²)	62.0	16.3	53.1	13.6	44.5	14.4	28.7	10.0
Cooling (Btu/h · ft ²)	22.2	10.1	24.6	11.7	17.5	7.8	15.7	7.1
Cooling (W/m ²)	70.0	31.9	77.5	36.9	55.3	24.6	49.5	22.3
Core Zones								
Heating (Btu/h · ft ²)	0.0	0.0	0.0	0.0	0.0	0.0	0.0	0.0
Heating (W/m ²)	0.0	0.0	0.0	0.0	0.0	0.0	0.0	0.0
Cooling (Btu/h · ft ²)	7.5	4.4	7.5	4.4	7.5	4.4	7.5	4.4
Cooling (W/m ²)	23.6	14.0	23.6	14.0	23.6	14.0	23.6	14.0
South Zones								
Heating (Btu/h · ft ²)	19.2	5.0	16.8	4.7	16.0	5.0	9.1	3.3
Heating (W/m ²)	60.5	15.8	53.0	14.8	50.3	15.9	28.6	10.3
Cooling (Btu/h · ft ²)	37.6	14.1	41.4	17.6	36.9	12.4	35.9	11.3
Cooling (W/m ²)	118.7	44.5	130.5	55.6	116.4	39.0	113.2	35.7

TABLE 6.
Installed Unit Cost of Air Conditioning Equipment

Boiler including burner (600 HP)	\$ 96.6/HP	=	\$ 9.85/kW
Centrifugal chiller and pumps and pipes (2000 ton)	\$ 400/ton	=	\$ 113/kW
Cooling tower with pumps and pipes	\$ 56/ton	=	\$ 24/kW
Ducts	\$ 1/cfm	=	\$ 2.12/L/S
Air handler (32000 cfm)	\$ 1.05/cfm	=	\$ 2.2/L/S
Return fan (31000 cfm)	\$ 0.3/cfm	=	\$ 0.64/L/S
Economizer	\$ 0.165/cfm	=	\$ 0.35/L/S
Heat recovery with controls	\$ 1/cfm	=	\$ 2/L/S
Cooling panels	\$ 0.3/Btu/h	=	\$ 1/W
VAV - Boxes (650 cfm)	\$ 0.7/cfm	=	\$ 1.49/L/S
Supply air diffusers	\$ 93/ea		
[4-way adjustable, 1 diffuser per 200 ft ² (18.6 m ²)	\$ 0.46/ft ²	=	\$ 5/m ²
Displacement air diffusers	\$ 186/ea		
[1 diffuser per 200 ft ² (18.6 m ²)]	\$ 0.92/ft ²	=	\$ 10/m ²

TABLE 7.
Predicted Percentage of Occupants Thermally Dissatisfied

		CITY AND ZONE*											
System #	System+ Type	MN	MC	MS	SN	SC	SS	AN	AC	AS	EN	EL	ES
1	M,VAV	5.6	2.2	15.6	4.6	2.2	14.6	8.9	2.2	17.5	11.4	2.2	22.3
2	M,VAV	5.6	1.7	15.6	4.6	1.7	14.6	8.9	1.7	17.5	11.4	1.7	22.3
3	M,VAV	5.6	2.2	15.6	4.6	2.2	14.6	8.9	2.2	17.5	11.4	2.2	22.3
4	M,CV	21.3	4.8	**	17.9	4.8	**	30.6	4.8	**	34.7	4.8	**
5	M,CV	21.3	4.8	**	17.9	4.8	**	30.6	4.8	**	34.7	4.8	**
6	M,CV	21.3	4.8	**	17.9	4.8	**	30.6	4.8	**	34.7	4.8	**
7	D,CV	2.7	3.5	4.2	2.4	3.5	3.8	3.7	3.5	4.9	4.4	3.5	6.1
8	D,CV	2.7	3.6	4.2	2.4	3.6	3.8	3.7	3.6	4.9	4.4	3.6	6.1
9	D,VAV	4.9	5.1	5.5	4.7	5.1	9.4	5.4	5.1	6.1	5.8	5.1	7.0

* M = Minneapolis S = Seattle A = Atlanta E = El Paso

N = North C = Core S = South Example: MN = Minneapolis, North Zone

** Flow too high to evaluate with available equations

+ M = Mixing system, D = displacement system, VAV = variable air volume, CV = constant volume

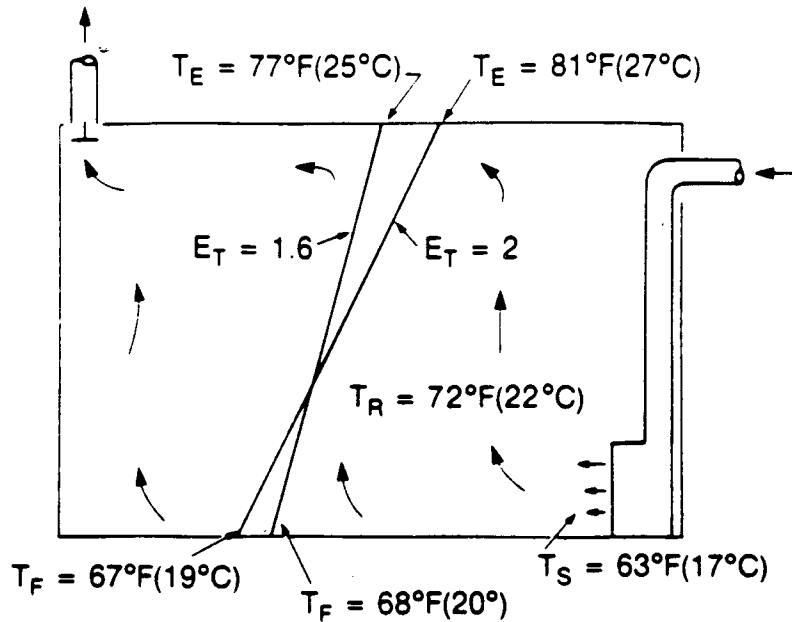

XBL 9901-7001

Figure 1. Illustration of layout, flow patterns, and temperature profile with displacement ventilation. T_E = exhaust air temperature, T_S = supply air temperature, T_R = room temperature, T_F = air temperature close to floor, E_T = temperature efficiency.

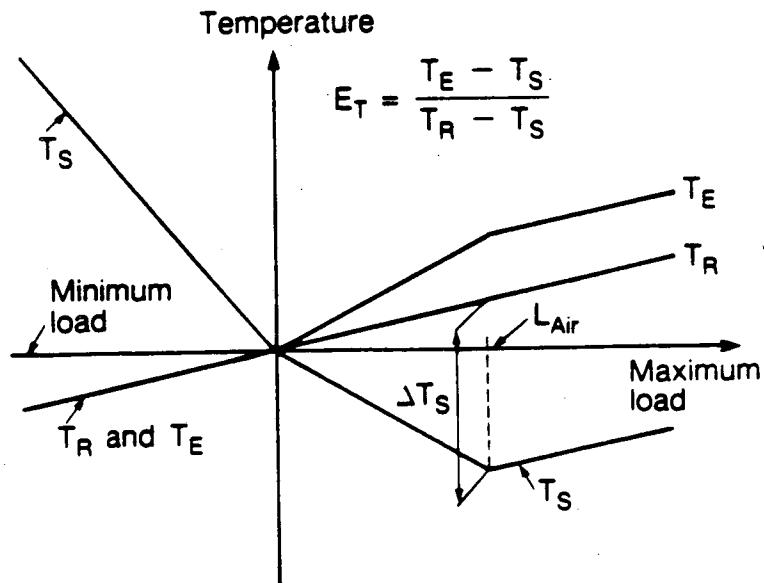

XBL 9901-7002

Figure 2. Control strategy of displacement ventilation with constant air flow. E_T = temperature efficiency. L_{AIR} = maximum cooling by air, ΔT_S = maximum temperature difference between room and supply air, T_E = exhaust temperature, T_S = supply temperature, T_R = room temperature at height 2.6 ft (0.8 m)

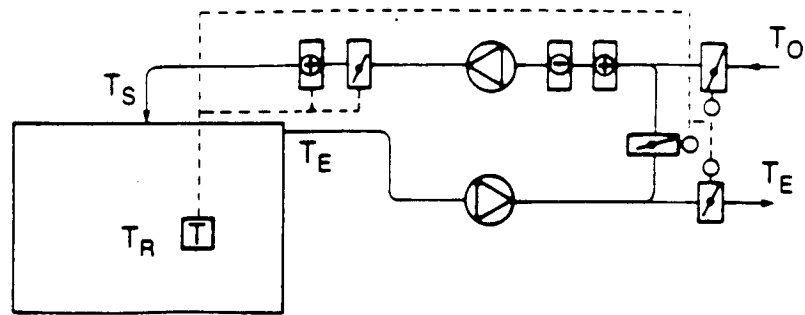

Key:

- | | |
|----------------|-----------------------|
| = thermostat | = flow control damper |
| = heating coil | = fan |
| = cooling coil | = damper actuator |

XBL 8901-7003

Figure 3. Schematic of variable air flow mixing system used in the simulation. T_O = outdoor air temperature, T_E = exhaust temperature, T_S = supply temperature, T_R = room temperature

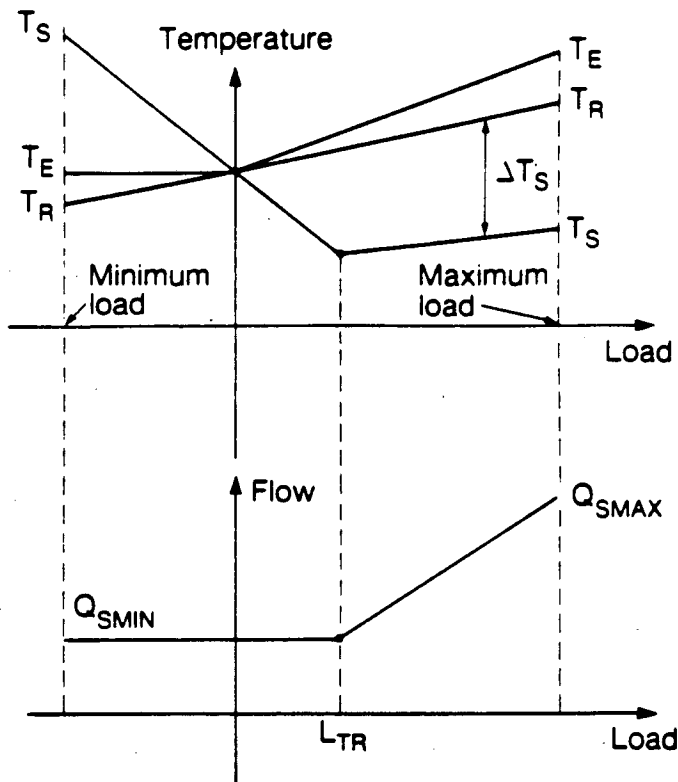

Figure 4. Control strategy of variable air flow mixing system with terminal reheat. T_E = exhaust temperature, T_S = supply temperature, T_R = room temperature ΔT_S = maximum temperature difference between room and supply air, Q_{SMAX} = maximum supply air flow, Q_{SMIN} = minimum supply air flow, L_{TR} = maximum load that can be met with minimum supply air flow. The zone is being heated when loads are to the left of the vertical axis.

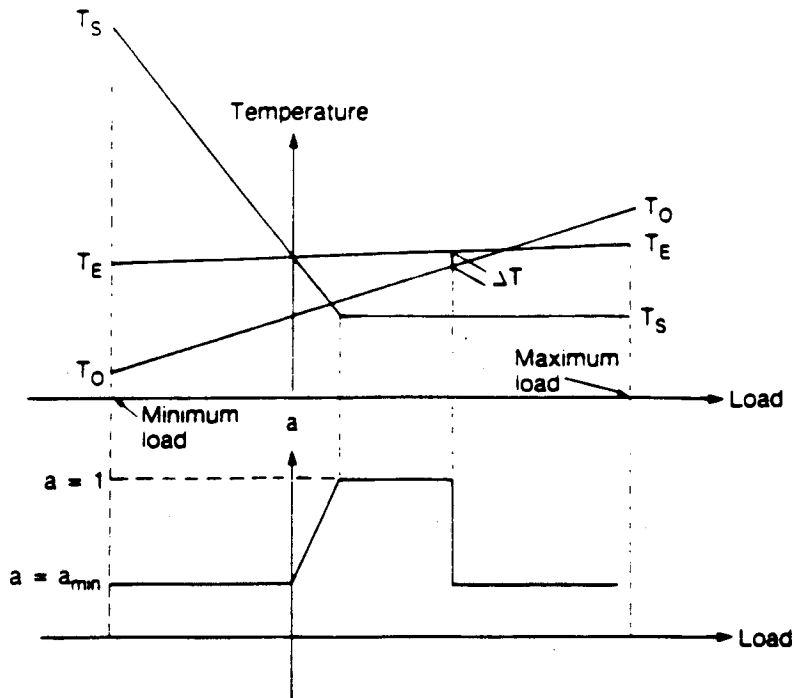

Figure 5. Control strategy of economizer cycle. Outdoor air ratio "a" (Q_o/Q_s) depends on the temperatures in the system and preset temperature difference ΔT between outdoor air and exhaust air. Its minimum value a_{min} depends on minimum outdoor air flow rate. T_E = exhaust temperature, T_S = supply temperature, T_O = outdoor air temperature.

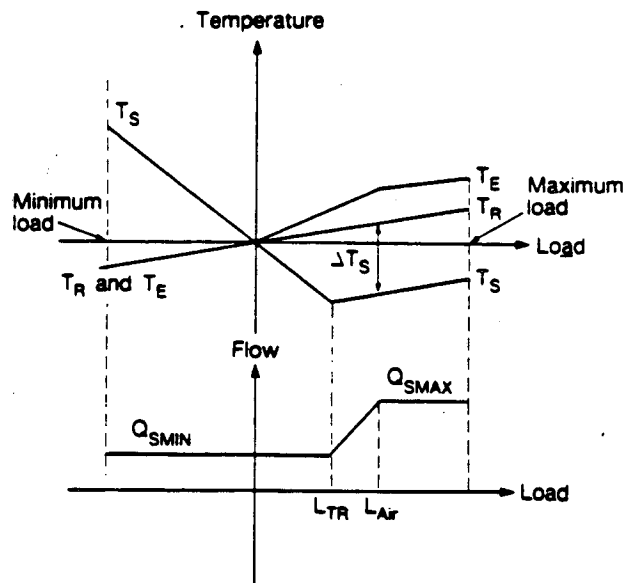

Figure 6. Control strategy of displacement ventilation system with variable air flow and terminal reheat. L_{TR} = the cooling load which still can be met with minimum supply air flow, L_{AIR} = maximum cooling by air, Q_{SMIN} = minimum supply air flow, Q_{SMAX} = maximum supply air flow ΔT_S = maximum temperature difference between room and supply air, T_E = exhaust temperature, T_S = supply temperature, T_R = room temperature at height 2.6 ft (0.8 m).

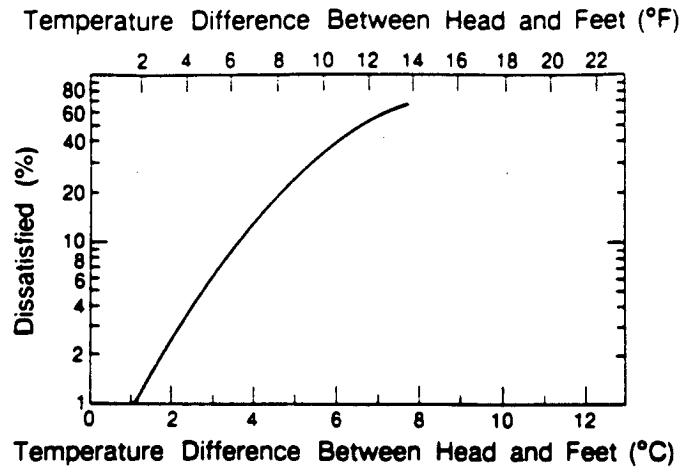
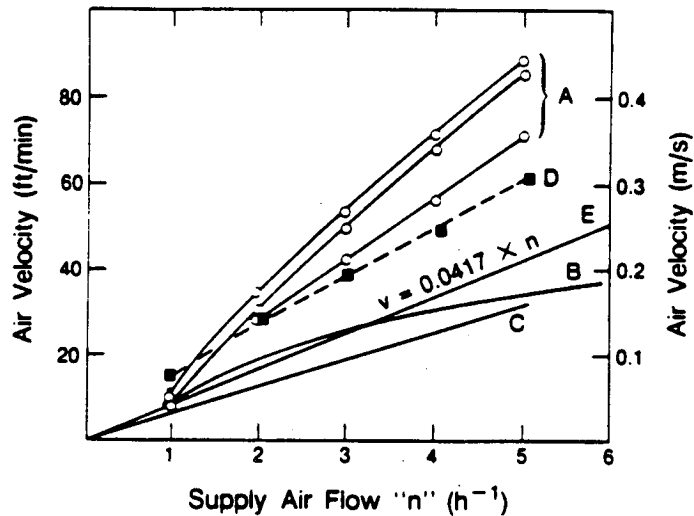

Figure 7. Predicted percentage of dissatisfied depending on the air temperature difference between head 3.6 ft (1.1 m) and ankles 0.3 ft (0.1 m)



XBL 8901-7008

Figure 8. Dependence of room air velocity on the supply air flow expressed in air changes per hour.

- A = Maximum air velocity in occupied zone with three wall diffusers (Heiselberg and Nielsen 1987)
- B = Maximum air velocity in occupied zone with ceiling diffusers (Larkfeldt 1987)
- C = Mean velocity of air in real buildings with various air distribution systems (Kovanen et al. 1987)
- D = Maximum velocity of air in occupied zone with perforated duct diffusers (Palonen et al. 1988)
- E = Approximation for the spatial maximum velocity used in the simulation.

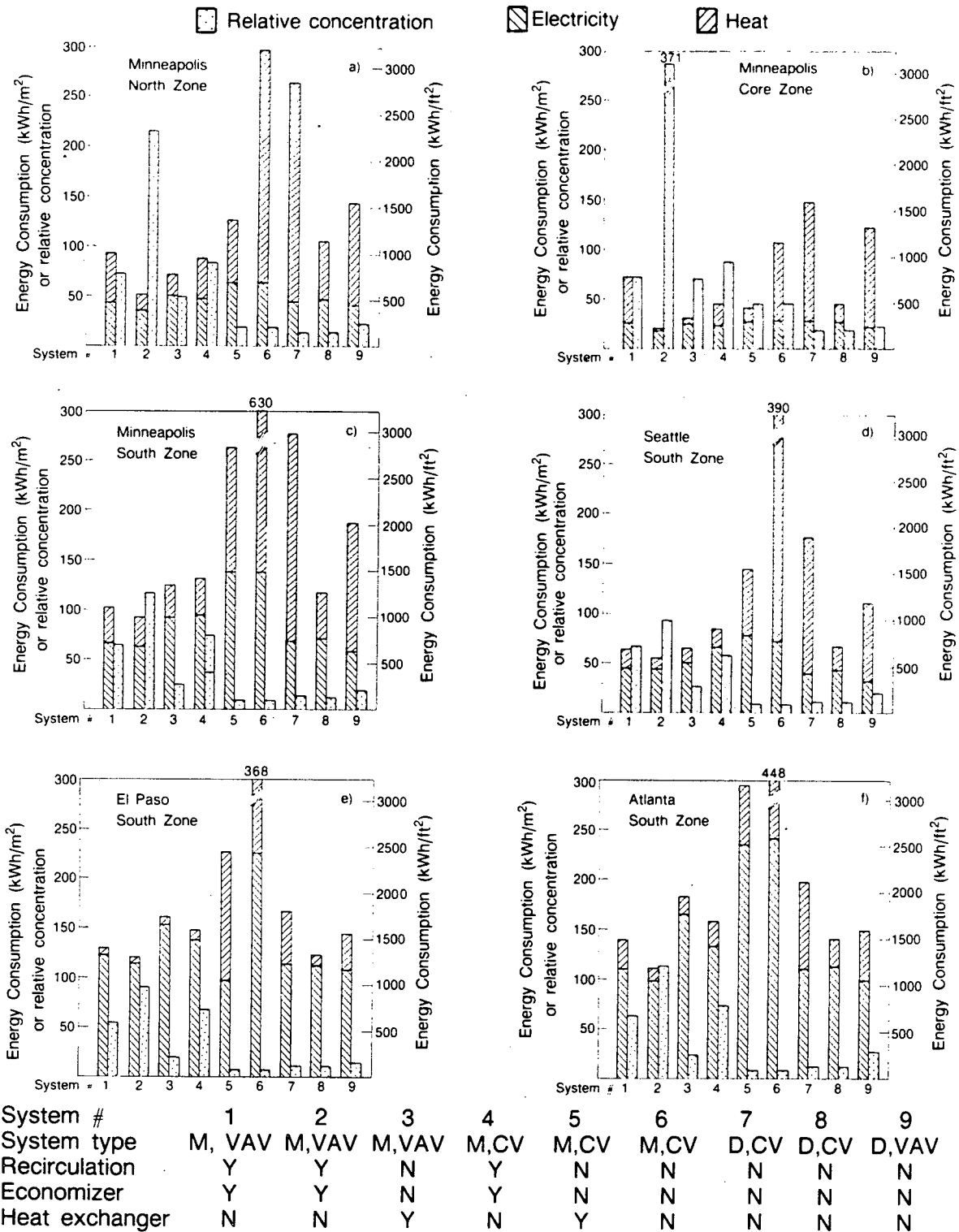

Figure 9. Energy consumption and relative pollutant concentrations for different air conditioning and air distribution systems. The design minimum outside air supply is 20 cfm (10 L/s) per occupant for all systems except No. 2, in which the outside air flow is 15% of the supply air flow. M = mixing system, D = displacement system, VAV = variable air volume, CV = constant volume.

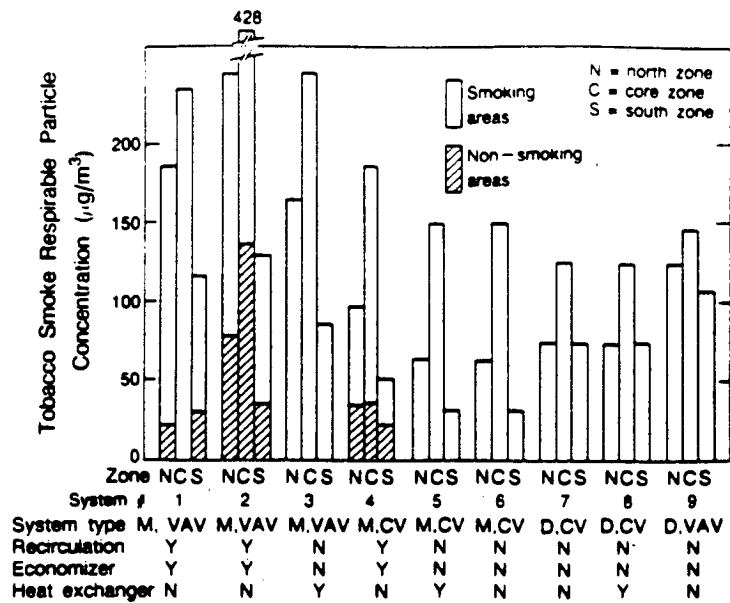

Figure 10. Predicted tobacco smoke respirable particle concentrations in smoking and nonsmoking areas in Minneapolis. Systems Number 3 and Numbers 5 - 9 do not recirculate air; therefore, the predicted concentration in the nonsmoking areas is zero. M = mixing system, D = displacement system, VAV = variable air volume, CV constant volume.

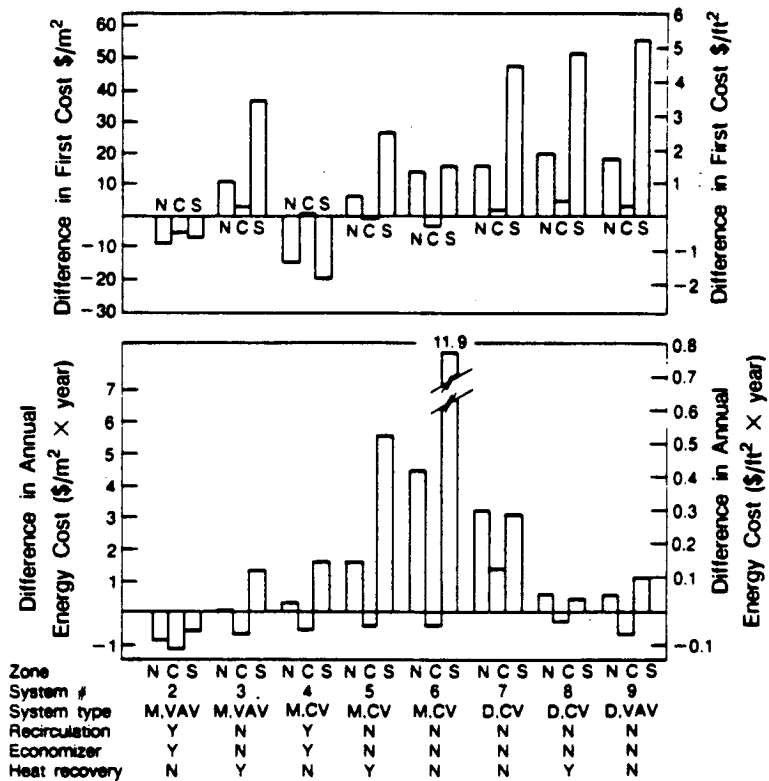

Figure 11. Comparison of first cost and annual energy cost of Systems 2 - 9 to the same costs for System 1 in the Minneapolis climate. The assumed costs of electricity and natural gas are 5.7 cents/kWh and 1.3 cents/kWh, respectively.

LAWRENCE BERKELEY LABORATORY
TECHNICAL INFORMATION DEPARTMENT
1 CYCLOTRON ROAD
BERKELEY, CALIFORNIA 94720