

UC Irvine

UC Irvine Previously Published Works

Title

Evaluation of laser ablation of knee cartilage as an alternative to microfracture surgery: pilot investigations

Permalink

<https://escholarship.org/uc/item/2131k7b4>

ISBN

9780819479440

Authors

Su, Erica
Wong, Brian JF
Sun, Hui
et al.

Publication Date

2010-02-11

DOI

10.1117/12.847126

Copyright Information

This work is made available under the terms of a Creative Commons Attribution License, available at <https://creativecommons.org/licenses/by/4.0/>

Peer reviewed

Evaluation of Laser Ablation of Knee Cartilage as an Alternative to Microfracture Surgery: Pilot Investigations

Erica Su^{*a}, Brian J.F. Wong^a, Hui Sun^b, Tibor Juhasz^b

^aBeckman Laser Institute, UC Irvine, CA 92612

^bDepartment of Ophthalmology, UC Irvine, CA 92612

ABSTRACT

An emerging clinical treatment option for articular cartilage injury includes bone marrow stimulation techniques, such as microfracture, which has grown increasingly popular among athletes. During the microfracture procedure, the surgeon penetrates the subchondral bone with an awl and creates “microholes” deep enough to ensure bleeding from the bone marrow. This procedure triggers a spontaneous repair response that results in the formation of fibrocartilaginous repair tissue. This preliminary study aimed to evaluate the potential use of femtosecond lasers and Erbium:YAG lasers as alternatives to microfracture surgery of the knee by assessing the effects of ablation on bovine femoral condyles. Bovine femoral condyles were obtained and 8mm cube blocks were extracted. The specimen were ablated with various laser dosimetry parameters and observed using a high power dissecting microscope to examine the effects of the lasers. Further imaging with conventional histology (hematoxylin and eosin staining) was done to provide more accurate information. Preliminary results show some carbonization but demonstrate little thermal damage to surrounding tissues. The femtosecond laser offers a more precise and efficient ablation than the Erbium:YAG laser, but both are demonstrated to be possible alternatives to the surgical-skill dependent microfracture procedure.

Keywords: laser, ablation, femtosecond, microfracture surgery, articular cartilage, bone

1. INTRODUCTION

1.1 Articular cartilage injury treatment options

Articular cartilage injury is frequently associated with joint pain, reduced function, and a predisposition to the development of osteoarthritis [1]. Injured articular cartilage is incapable of self-repair and subsequent degeneration may result in the need for total knee arthroplasty [2]. Current surgical repair options for damaged articular cartilage are limited and focus on the stimulation of biological repair. The main clinical treatment options include bone marrow stimulation techniques, such as microfracture, osteochondral graft transplantation, and autologous chondrocyte implantation (ACI) [2]. In recent years, microfracture surgery has grown increasingly popular in the sports world. Numerous professional athletes have undergone the procedure, most notably Greg Oden, Allan Houston, Tracy McGrady and Amar'e Stoudemire. The microfracture technique was adapted by Dr. Steadman to be used in conjunction with arthroscopy [1-2]. After cleaning calcified cartilage, the surgeon uses an awl to penetrate the subchondral bone and create “microholes” that must be deep enough to induce bleeding from the bone marrow [2]. This procedure triggers a spontaneous repair response that results in the formation of fibrocartilaginous repair tissue.

Although this procedure is used with increasing frequency, the technique still has its limitations. Arthroscopy provides for a minimally invasive surgical procedure, but nonetheless relies on a surgical tool. The procedure is performed with an arthroscope, a type of endoscope. After an incision of about 4 mm is made, the arthroscope is inserted into the joint and can be visualized using the small fiberoptic camera. To visualize and reach different areas of the knee, multiple incisions must be made. This limitation in access is a major weakness of relying on a surgical tool, thereby establishing a need to develop improved and more efficient techniques.

*esu2@uci.edu

1.2 Use of laser ablation

Innovative technological developments have made possible many advancements in biological research. One such device platform is laser technology. Lasers and optical technologies have played an increasingly significant role in medicine, particularly in ophthalmology and aesthetic surgery [5]. The Erbium:YAG laser serves as the gold standard for tissue ablation. Its 2.94 μm wavelength is intensely absorbed by water and is efficient for cartilage ablation. In a recent study, Erbium:YAG ablation was successfully applied in liquid environments for cartilage removal without subsequent damage to surround tissues [4].

In addition, femtosecond lasers, normally used for LASIK eye surgery, are emerging as a powerful tool. Femtosecond laser pulse ablation occurs with minimal mechanical or thermal injury [5]. The ultra-short pulse of infrared laser light is tightly focused and generates a high peak light intensity that enables versatile submicron ablation deep within biological samples [3]. The tightly focused pulses ionize material to form the plasma, a mixture of free electrons and ions, in the focal point of the laser beam [5]. Femtosecond laser ablation is very precise because it is confined to the region of ionization and creates little heat outside the targeted area because ablation happens more rapidly than thermal diffusion, and most heated material is carried away with the plume [5].

1.3 Laser ablation of articular cartilage

The goal of this pilot study was to evaluate femtosecond and Erbium:YAG laser ablation of articular cartilage as an alternative to microfracture surgery. The Erbium:YAG laser was selected because it is the gold standard to which femtosecond lasers are compared to; albeit femtosecond laser systems vastly outperform Erbium:YAG devices already. Erbium:YAG merits evaluation because the cost of these devices is substantially lower than femtosecond laser systems, and they tend to be simpler to operate. This study aimed to determine whether or not femtosecond and Erbium:YAG lasers could be used to ablate articular cartilage and bone in a clinically suitable fashion without the appearance of any thermal damage to surrounding tissues. Thermal damages were assessed using a high powered dissecting microscope and conventional histology.

2. MATERIALS AND METHODS

2.1 Bovine sample preparation and laser parameters

Specimen blocks of approximately 8 mm x 8 mm x 8 mm were extracted from bovine femoral condyles. Samples were consistently sawed from the same region of the femoral condyles to insure similar cartilage thicknesses from different animals. Specimens were maintained in normal saline solution upon extraction. Two different lasers were used in this study. The first was the Coherent Ultrafine Erbium:YAG laser ($\lambda=2.94\mu\text{m}$) and the second was a Ti:Sapphire Femtosecond Laser with a Coherent diode pumped Nd:YLF laser system. For the Er:YAG, pulse energies of 0.3J, 0.4J, and 0.5J, or fluences of $8\text{J}/\text{cm}^2$, $12\text{J}/\text{cm}^2$, and $16\text{J}/\text{cm}^2$, pulse repetition rate of 1Hz, and spot diameter of 2mm was used. For the femtosecond laser, laser power of 100 mW to 1.2W and repetition rate of 5 kHz were used.

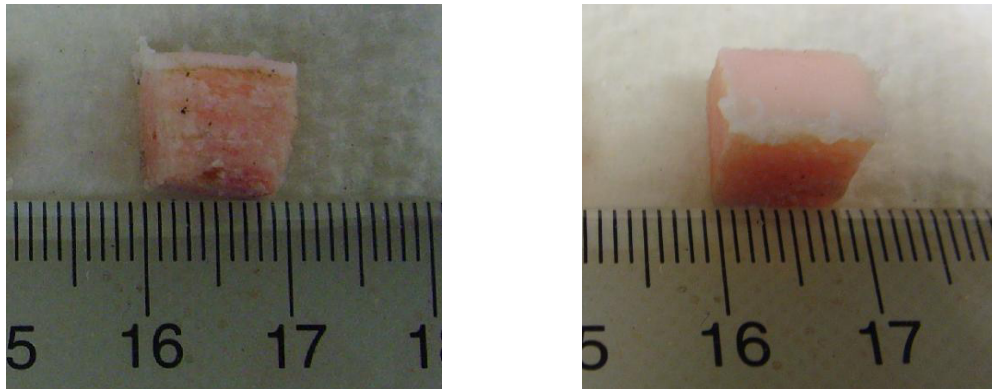

Figure 1. Bovine specimen sample as used in experiments.

2.2 Experimental setup

The bovine bone samples were placed on a flat surface for ablation. For Er:YAG ablation, the specimen was placed on the table and the bulky laser handpiece was clamped and fixed during ablation. For the femtosecond laser, the specimen was placed on a moving xyz stage, as shown in the setup below (Fig. 2). The femtosecond laser beam was focused onto the tissue and a hole 1mm x 1mm x 3mm was ablated by controlling the movement of the xyz stage. The speed of the xyz stage was 20mm per second.

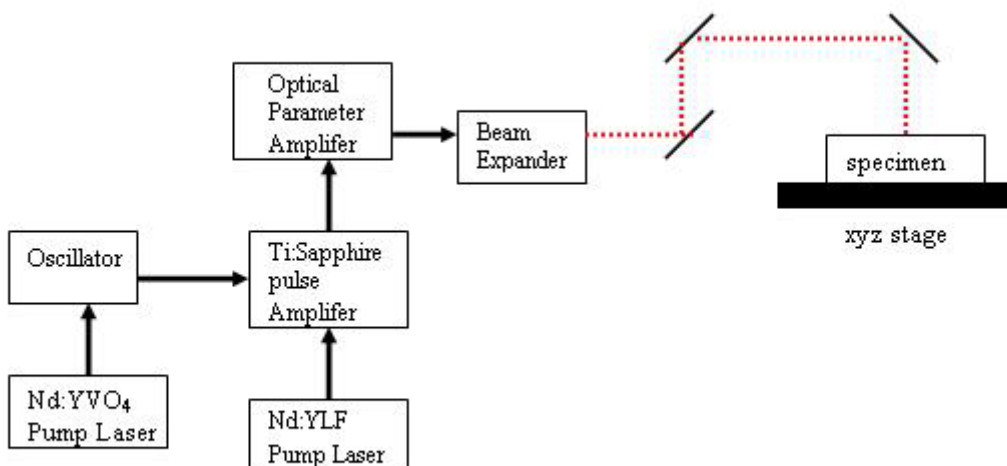

Figure 2. Schematic drawing of Femtosecond laser system setup used in experiment.

3. FEMTOSECOND ABLATION

Femtosecond laser ablation was analyzed after creating holes 1mm x 1mm x 3mm deep. Varying laser powers were used and thermal effects were assessed by how much char was formed around the edges. In addition, conventional histology was used to reveal the actual depth of the ablation and any thermal effects within the hole. The results can be seen in figure 3 shown below. As the laser power increased, the amount of carbonization and damage to the surface increased. A laser power of around 300 mW yielded the best results.

Laser Power	Dissecting Microscope	Histology (H&E)
1.2W		N/A



~600mW	 <p>13.2x</p>	N/A
298mW	 <p>21x</p>	 <p>1.22mm 16x</p>
156mW	 <p>21x</p>	 <p>0.418mm 16x</p>

Figure 3. Femtosecond ablation of cartilage for different laser powers.

4. ERBIUM: YAG ABLATION

Erbium:YAG laser ablation was analyzed after ablating one spot through to the bone with varying pulse energies at 1 Hz. Pulse energies of 0.3J, 0.4J, and 0.5J (fluences of $8\text{J}/\text{cm}^2$, $12\text{J}/\text{cm}^2$, and $16\text{J}/\text{cm}^2$) were used, and the results were analyzed for the number of pulses required to ablate through cartilage to the bone and the effects on surrounding tissues. Further imaging with conventional histology was used to see exact depth of ablation and assess damages to the tissue. Results can be seen in figure 4 shown below. These ablations created rough edges and were not as precise as the femtosecond, but they showed no sign of carbonization.

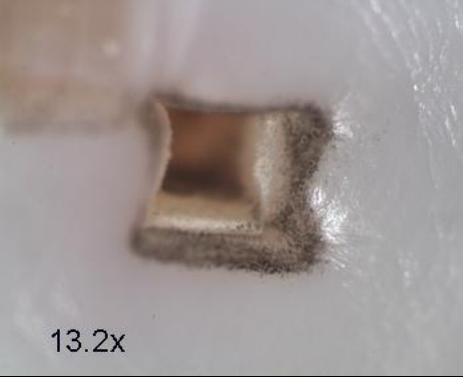
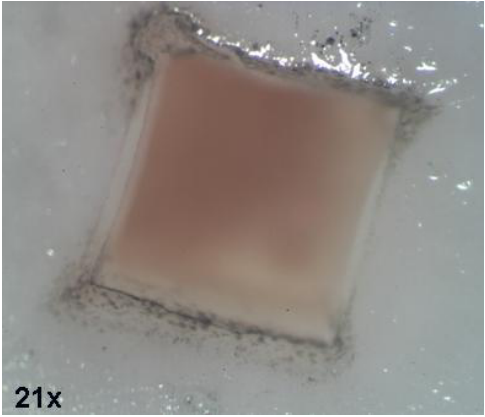
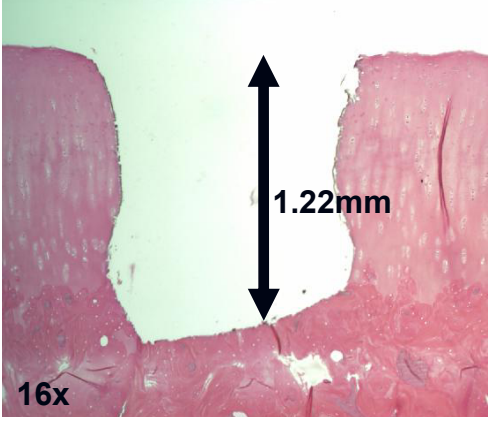
Fluence	8J/cm ²	12J/cm ²	16J/cm ²
Pulses	293 pulses	223 pulses	128 pulses
			
			

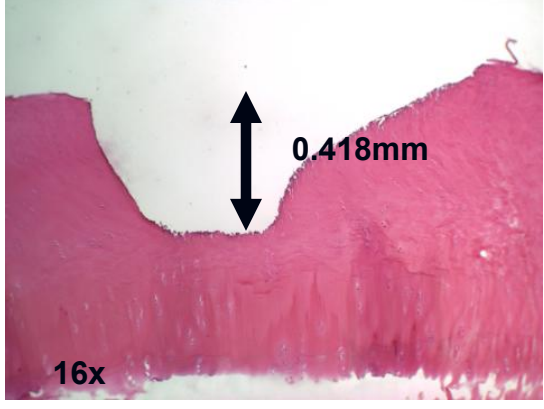
Figure 4. Erbium:YAG ablation of cartilage to bone with varying pulse energies and number of pulses. The first set of images are from the high powered dissecting microscope and the second set is from histology.

5. SUMMARY

This study demonstrated that both the Erbium:YAG and the femtosecond lasers can successfully be applied to articular cartilage removal without seeing any thermal effects on the surface, choosing the right laser parameters. Due to the low efficiency of the femtosecond laser used, the procedure takes approximately 5 hours. In a real clinical setting, the laser would need to operate at a much faster rate than was used. One possible option to consider is flying spot scanner technology coupled with an increased repetition rate. The commercially available Erbium:YAG laser proved to be simpler to use and faster to operate but yielded less precise ablations. As seen from the histology images, the Erbium:YAG laser created rougher edges and less refined ablations compared to the femtosecond laser. In addition, the Erbium:YAG laser would also be harder to deliver in a real clinical setting due to its bulky laser arm and setup.

This experiment is only the first step in evaluating and understanding the possibilities of using these lasers in articular surgery which may ultimately reduce the reliance upon surgical skill to accomplish the technically challenging microfracture operation. Further studies may involve testing other lasers such as picosecond lasers, which offer similar performance as femtosecond lasers.

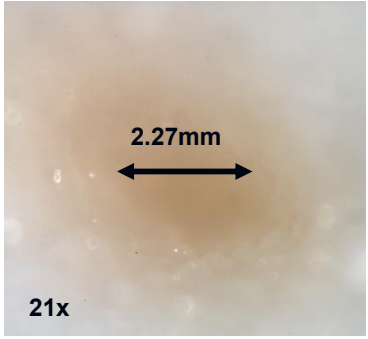
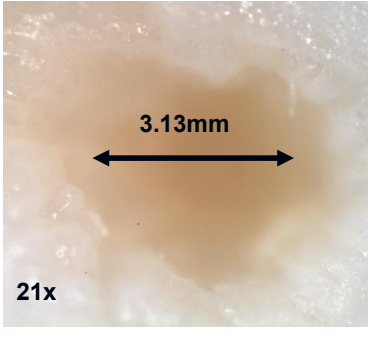
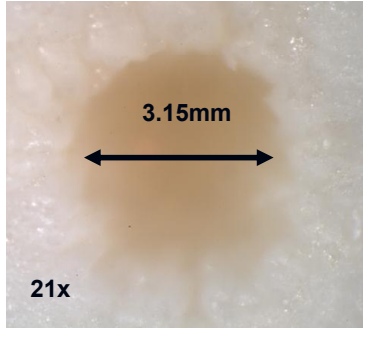
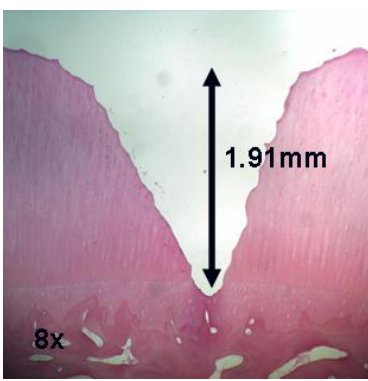
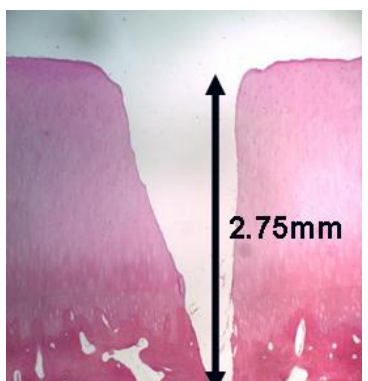
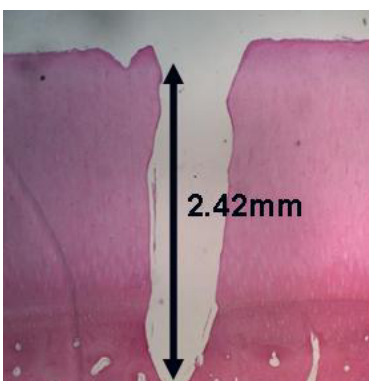
REFERENCES

- [1] Custers, R.J.H., Saris, D.B.F., Dhert, W.J.A., Verbout, A.J., van Rijen, M.H.P., Mastbergen, S.C., Lafeber, F.P.J.G., Creemers, L.B., "Articular Cartilage Degeneration Following the Treatment of Focal Cartilage Defects with Ceramic Metal Implants and Compared with Microfracture," *J Bone Joint Surg Am* 2009 91: 900-910.
- [2] Domayer SE, Welsch GH, Dorotka R, Mamisch TC, Marlovits S, Szomolanyi P, Trattinig S., "MRI Monitoring of Cartilage Repair in the Knee: A Review," *Semin Musculoskelet Radiol* 2008; 12: 302-317.
- [3] Gabel, Christopher V., "Femtosecond lasers in biology: nanoscale surgery with ultrafast optics," *Contemporary Physics*, 49:6, 391- 411.
- [4] Meister J, Franzen R, Gavenis K, Zaum M, Stanzel S, Gutknecht N, Schmidt-Rohlfing B., "Ablation of articular cartilage with an erbium:YAG laser: an ex vivo study using porcine models under real conditions-ablation measurement and histological examination," *Lasers Surg Med.* 2009 Nov;41(9):674-85.
- [5] Wu, Edward C. and Brian J. F. Wong., "Lasers and Optical Technologies in Facial Plastic Surgery," *Arch Facial Plast Surg.* 2008;10(6):381-390.