

# Lawrence Berkeley National Laboratory

## LBL Publications

### Title

Design of a 10-T Superconducting Dipole Magnet Using Niobium-Tin Conductor

### Permalink

<https://escholarship.org/uc/item/1z2248d2>

### Authors

Taylor, C

Meuser, R

Caspi, S

et al.

### Publication Date

1982-11-01



# Lawrence Berkeley Laboratory

UNIVERSITY OF CALIFORNIA

RECEIVED  
LAWRENCE  
BERKELEY LABORATORY

## Accelerator & Fusion Research Division

FEB 9 1983

LIBRARY AND  
DOCUMENTS SECTION

Presented at the 1982 Applied Superconductivity Conference, Knoxville, TN, November 28-December 3, 1982; and to be published in the Proceedings

DESIGN OF A 10-T SUPERCONDUCTING DIPOLE MAGNET USING NIOBIUM-TIN CONDUCTOR

C. Taylor, R. Meuser, S. Caspi, W. Gilbert, W. Hassenzahl, C. Peters, R. Schafer, and R. Wolgast

November 1982

**TWO-WEEK LOAN COPY**  
*This is a Library Circulating Copy which may be borrowed for two weeks. For a personal retention copy, call Tech. Info. Division, Ext. 6782.*

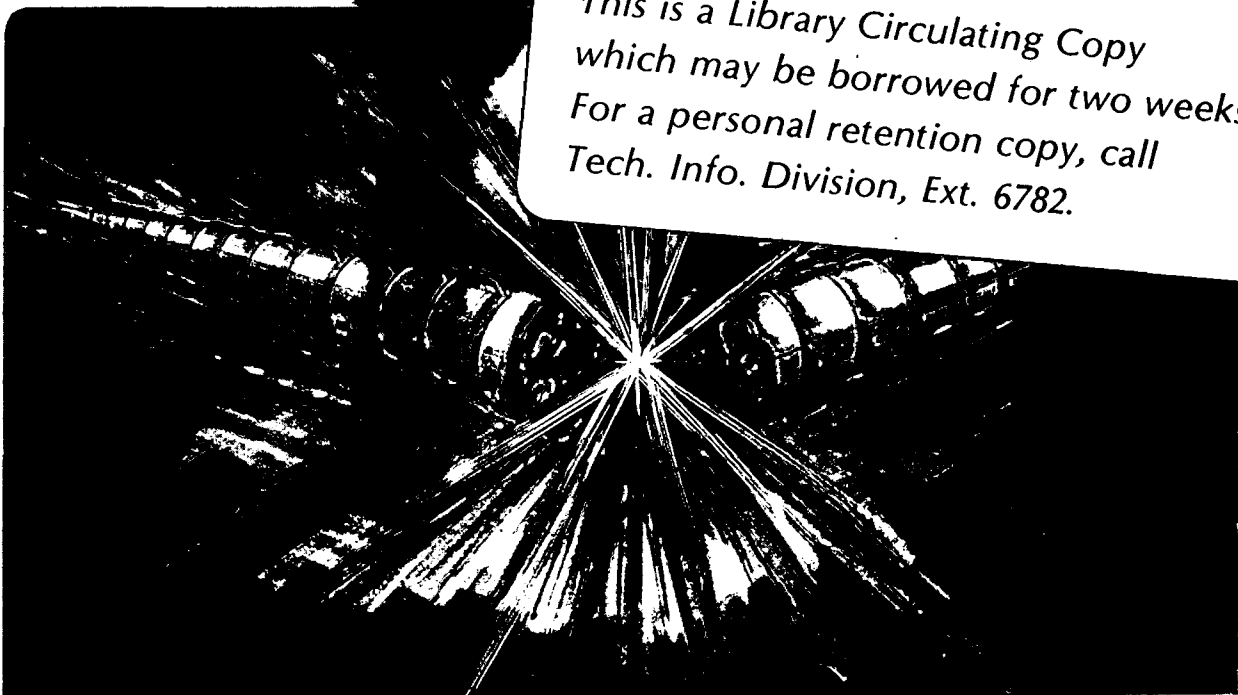

*LBL-14434*

## DISCLAIMER

This document was prepared as an account of work sponsored by the United States Government. While this document is believed to contain correct information, neither the United States Government nor any agency thereof, nor the Regents of the University of California, nor any of their employees, makes any warranty, express or implied, or assumes any legal responsibility for the accuracy, completeness, or usefulness of any information, apparatus, product, or process disclosed, or represents that its use would not infringe privately owned rights. Reference herein to any specific commercial product, process, or service by its trade name, trademark, manufacturer, or otherwise, does not necessarily constitute or imply its endorsement, recommendation, or favoring by the United States Government or any agency thereof, or the Regents of the University of California. The views and opinions of authors expressed herein do not necessarily state or reflect those of the United States Government or any agency thereof or the Regents of the University of California.

DESIGN OF A 10-T SUPERCONDUCTING DIPOLE MAGNET USING NIOBIUM-TIN CONDUCTOR\*

C. Taylor, R. Meuser, S. Caspi, W. Gilbert, W. Hassenzahl  
C. Peters, R. Schafer, R. Wolgast

November 1982

Accelerator and Fusion Research Division  
Lawrence Berkeley Laboratory  
University of California  
Berkeley, California 94720

\*This work was supported by the Director, Office of Energy Research, Office of High Energy and Nuclear Physics, High Energy Physics Division, U. S. Dept. of Energy, under Contract No. DE-AC03-76SF00098.

# DESIGN OF A 10-T SUPERCONDUCTING DIPOLE MAGNET USING NIOBIUM-TIN CONDUCTOR\*

C. Taylor, R. Meuser, S. Caspi, W. Gilbert, W. Hassenzahl, C. Peters, R. Schafer and R. Wolgast  
Lawrence Berkeley Laboratory  
University of California  
Berkeley, CA 94720

In order to minimize the size and cost of conventional facilities -- land, tunneling, shielding, cryogenic and vacuum system -- the dipole magnets for the next generation of particle accelerators must produce as strong a magnetic field as possible. Ten tesla seems to be a reasonable goal, and can be attained by using either niobium-tin conductor at 4.2 K or niobium-titanium at 1.8 K.

The beam diameter in a multi-TeV accelerator, can in principle, be quite small, say 20 mm, depending on the design of the injection and extraction systems, and on beam-cooling technology. Magnet cost is strongly dependent on bore diameter, so there is a strong incentive to minimize that. We believe that a 40-mm bore diameter -- about 60-mm winding inside diameter is feasible and is a reasonable goal for initial research and development.

For such a high field and small bore, there is an incentive to achieve a high overall current density in order to minimize the amount of superconductor. Our design is based on an overall current density of 400 A/sq mm.

With a copper-to-non-copper ratio of 1.0, and allowing space for insulation, the current density in the non-copper area of the wire must be 1000 A/mm<sup>2</sup> at 4.4 K and 10.6 T (10 T in aperture). This is beyond the capability of bronze-process material. However, by the addition of more tin than allowed by the conventional 14 percent maximum possible with copper-tin bronze, much higher current densities are possible and have been demonstrated in small-diameter wires, with external tin added by electroplating before reaction. This process appears to be limited to strands of diameter less than 0.5 mm. However, we have recently initiated development of 1.7 mm "internal tin" conductors to be used in this magnet. A cold-drawing process is used. Tin is placed in the center of a hollow extrusion of copper and niobium filaments, and this composite is cold-drawn. Sixty-one rods are re-bundled into a long billet, and re-drawn to the final size. A critical current of 1400 A/mm<sup>2</sup> has been achieved in samples of the material from the first drawing.<sup>1</sup> After making the wire into an eleven-strand flat cable, which will occur in the next few months, we will fabricate sample windings.

Developmental lengths of large strands for this application have been made by several manufacturers using different processes, and these developments are continuing.

A consequence of minimizing the amount of copper in the conductor is very rapid heating following a quench, requiring discharge in something like 0.5 sec. Then, in order to keep the voltage reasonable, the inductance must be low. This forces the use of a large-cross-section, high-current conductor; winding such a conductor to make a small-bore magnet is difficult.

\*This work was supported by the Director, Office of Energy Research, Office of High Energy and Nuclear Physics, High Energy Physics Division, U. S. Dept. of Energy, under Contract No. DE-AC03-76SF00098.

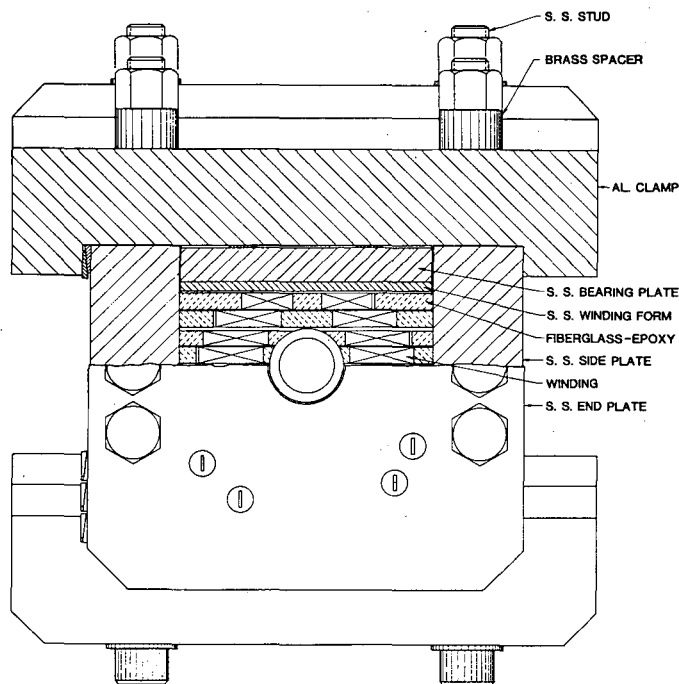

Fig. 1. Cross section of magnet. External structure shown is for development and testing; production version will consist of punched laminations.

LBL has undertaken the development of a magnet using niobium-tin conductor intended to meet the above specifications. The conductor is a Rutherford-type cable consisting of twelve strands of 1.71-mm-diam. wire. Dimensions of the uninsulated cable are 11.0 x 3.0 mm. The configuration chosen (Figs. 1 and 2) consists of flat race-track layers -- four per pole -- with the ends bent up and down to clear the bore. Two coils are wound from a single piece of cable with a cross-over at the inside: the familiar "double pancake" arrangement. Such a configuration lends itself to clamping in such a way as to produce the high pre-stresses required to inhibit separation of the coil from the surrounding structure under the influence of the Lorentz body forces. Also, with such a configuration the maximum operating stress occurs in a low-field region; this might be an advantage. Further, the difficulties associated with winding a heavy conductor to produce a small-bore magnet are minimized.

The windings are clamped in place over a bore tube by a stainless steel structure. Both the bore tube and structure are to be made from laminated stampings. The structure is supported in a laminated soft-iron core which helps restrain the magnetic forces. But, if later studies show a warm-iron configuration to be preferred, the structure will be enlarged to accommodate the magnetic forces.

For the first models, however, a supporting-and-clamping structure made of bars bolted together will be used. And because of the long lead time required for the niobium-tin cable, the first model will employ niobium-titanium conductor and will be operated at 1.8 K. Later, serious attention will be given to "grading" the conductor -- using conductor that is narrower or has a higher ratio of copper to niobium-tin in the low-field regions -- as the potential decrease in the amount of superconductor required is substantial.

At this writing (Nov. 1982) all of the parts for the niobium-titanium magnet are on hand, and practice winding has been performed. Most of the parts and tooling for the niobium-tin magnet are on hand, and delivery of this conductor is expected soon.

References

1. R. E. Schwall, G. M. Ozeryansky, D. W. Hazelton, S. F. Cogan, and R. M. Rose, "Properties and Performance of High Current Density Sn-Core-Processed MF Nb<sub>3</sub>Sn," The Proceedings of the 1982 Applied Superconductivity Conference, Knoxville, TN, November 1982.

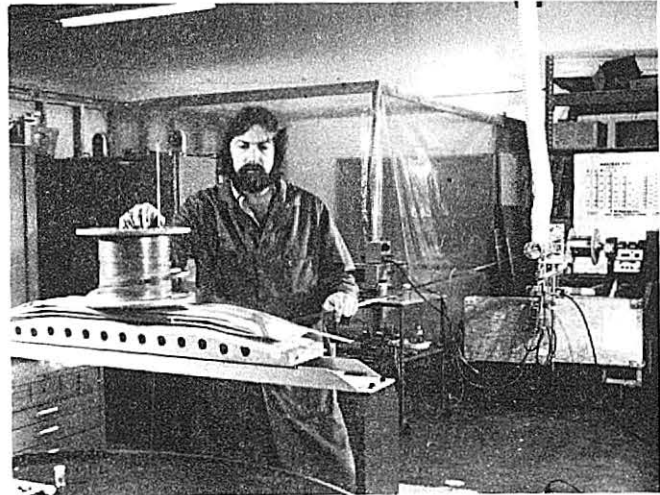

Winding in progress. Machine in background supplies conductor under controlled tension and applies spiral wrap insulation and epoxy coating. Supply spool on the fixture holds conductor for the second layer of the double pancake.

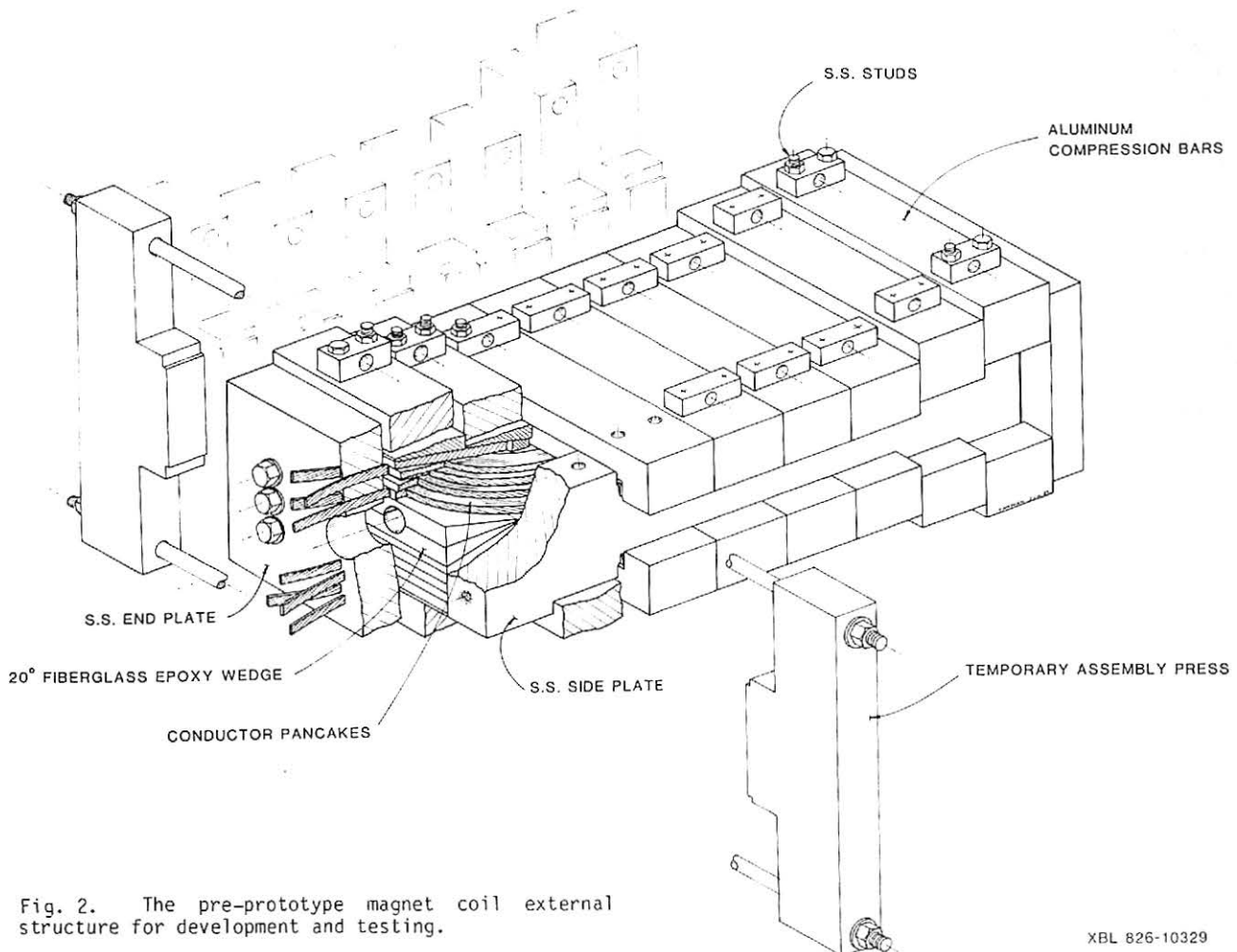
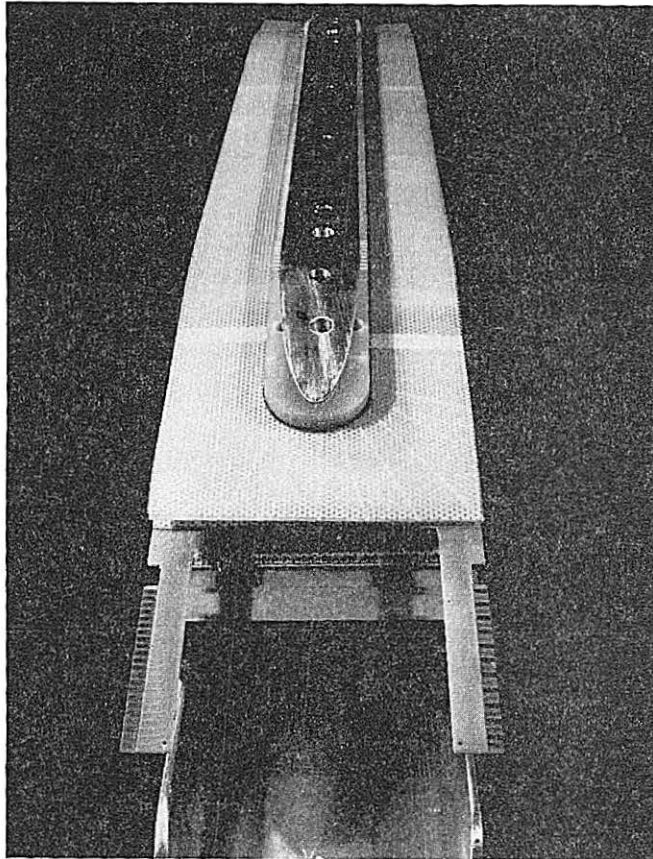
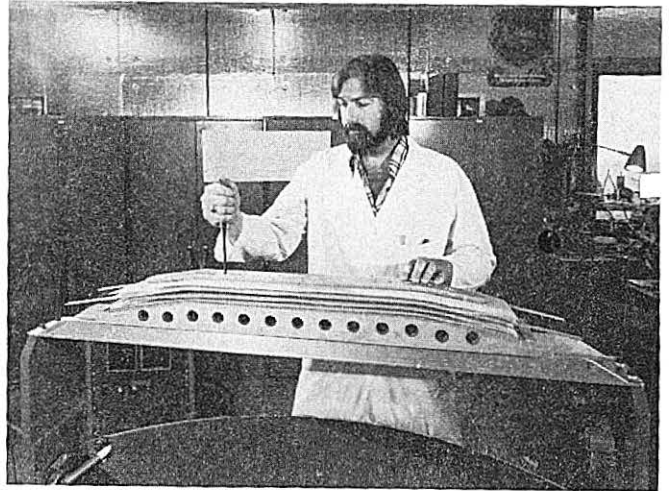

Fig. 2. The pre-prototype magnet coil external structure for development and testing.



Partial assembly of niobium-titanium magnet showing (top to bottom) half bore plug, fiberglass-reinforced epoxy island, insulating and ventilating spacers, and printed-circuit spacer for connections to strain gages and voltage taps.



Islands and inter-layer spacers assembled on winding fixture.

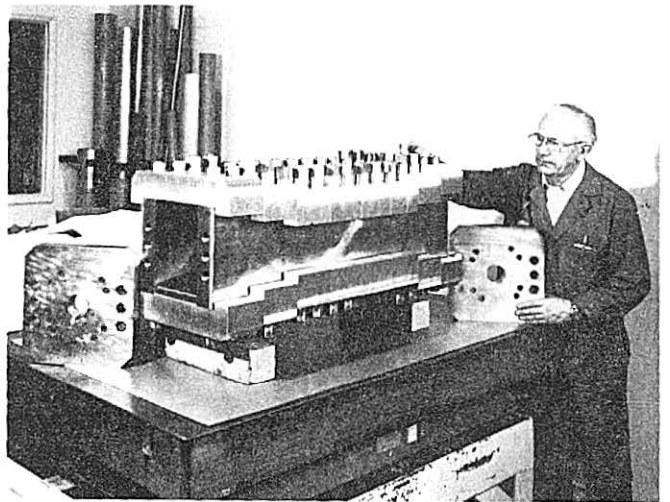

Fixture for clamping and testing niobium-titanium coil.

This report was done with support from the Department of Energy. Any conclusions or opinions expressed in this report represent solely those of the author(s) and not necessarily those of The Regents of the University of California, the Lawrence Berkeley Laboratory or the Department of Energy.

Reference to a company or product name does not imply approval or recommendation of the product by the University of California or the U.S. Department of Energy to the exclusion of others that may be suitable.



TECHNICAL INFORMATION DEPARTMENT  
LAWRENCE BERKELEY LABORATORY  
UNIVERSITY OF CALIFORNIA  
BERKELEY, CALIFORNIA 94720