

Lawrence Berkeley National Laboratory

Lawrence Berkeley National Laboratory

Title

The Energy Saving Potential of Membrane-Based Enthalpy Recovery in Vav Systems for Commercial Office Buildings

Permalink

<https://escholarship.org/uc/item/1t8166j7>

Author

Wang, Liping

Publication Date

2012-08-01

THE ENERGY SAVING POTENTIAL OF MEMBRANE-BASED ENTHALPY RECOVERY IN VAV SYSTEMS FOR COMMERCIAL OFFICE BUILDINGS

Liping Wang¹, Philip Haves¹, and John Breshears²

¹Lawrence Berkeley National Lab, Berkeley, CA

²Architectural Applications, Portland, OR

ABSTRACT

A design tool to evaluate the heat and mass transfer effectiveness and pressure drop of a membrane-based enthalpy exchanger was developed and then used to optimize the configuration of an enthalpy exchanger for minimum pressure drop and maximum heat recovery effectiveness. Simulation was used in a parametric study to investigate the energy saving potential of the enthalpy recovery system. The case without energy recovery and air side economizer was used as a baseline. Two comparison cases for the implementation of enthalpy recovery with and without air side economizer were simulated in EnergyPlus. A case using a desiccant wheel for energy recovery was also investigated for comparison purposes. The simulation results show significant energy saving benefits from applying a low pressure drop, high effectiveness enthalpy exchanger in two US cities representing a range of humid climates. The sensitivity of the energy savings potential to pressure drop and heat and mass transfer effectivenesses is also presented.

INTRODUCTION

Enthalpy exchangers transfer sensible and latent heat between exhaust air and outdoor ventilation air to reduce heating and cooling loads due to mechanical ventilation in HVAC systems. Enthalpy recovery has significant benefits for building types requiring high ventilation rates to dilute indoor air pollutants, and/or those climates where outdoor air ventilation loads accounts for a large fraction of total cooling loads. Membrane-based enthalpy recovery employs a permeable membrane to enable both heat and mass transfer between exhaust air and outdoor air. Using a large surface area, with low air flow rate results in a high effectiveness and a small increase in fan power.

There have been a few recent studies to investigate the performance of membrane-based enthalpy recovery. Zhang and Jiang (1999) conducted experiments and numerical analysis to

investigate the performance of membrane-based enthalpy recovery. Min and Su (2010) developed a mathematical model to predict the thermal and hydraulic performance of a membrane-based energy recovery ventilator, and investigated the relationship between enthalpy effectiveness and channel height and pressure drop. Min and Su (2011) investigated the effects of air temperature and humidity on the performance of a membrane-based energy recovery ventilator operating in both hot and cold conditions. Nasif, et al. (2010) assessed the thermal performance of a membrane-based enthalpy exchanger. Temperature and humidity ratio measurements were carried out to determine the sensible and latent effectivenesses. The performance of an HVAC system coupled to the membrane-based enthalpy exchanger was simulated and the results showed savings of up to 8% in annual energy consumption in a humid climate.

The purposes of the work reported here were 1) to develop a tool for parametric evaluation of various configurations of enthalpy exchanger, and 2) to evaluate the energy saving potential of high performance enthalpy recovery characterized by low pressure drop and high effectiveness when used with a conventional variable-air-volume (VAV) HVAC system.

TOOL FOR HEAT AND MASS TRANSFER ACROSS A WATER-PERMEABLE MEMBRANE

A spreadsheet-based tool for calculating pressure drop and effectiveness for membrane-based enthalpy recovery was developed to conduct parametric studies of various enthalpy recovery configurations. The tool was designed to identify high performance configurations, characterized by high heat and mass transfer effectivenesses and low pressure drop.

The tool is capable of calculating effectiveness and pressure drop for both cross-flow and counter flow geometries, each with a defined number of parallel membrane layers. The tool inputs define the exchanger geometry, the properties of the membrane and the thermal properties of air. Both flat and pleated configurations can be studied using the tool; it was found that flat plate configuration yielded a more favorable trade-off between effectiveness and pressure drop.

The tool uses empirical correlations for heat and mass transfer coefficients and pressure drop relationships listed in ASHRAE (2009), together with the standard effectiveness-NTU relationships for the counterflow and cross-flow exchanger configurations. The schematic

diagram of the membrane-based enthalpy recovery is shown in Figure 1. It is assumed that air flow is uniformly distributed inside each channel.

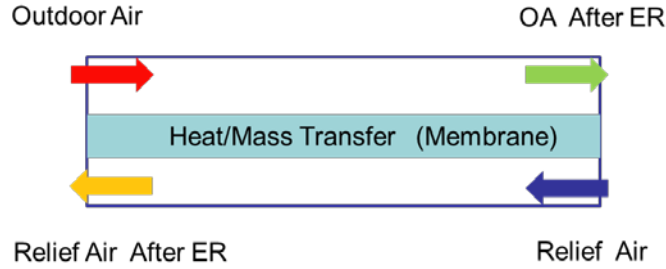

Figure 1 Schematic diagram of membrane-based enthalpy recovery exchanger (OA-outdoor air, ER-enthalpy recovery)

The calculation of effectiveness assumes equal mass flow rates and equal capacity rates on each side of the exchanger.

The heat exchanger effectiveness for cross flow with equal capacity rates and both streams unmixed is:

$$\varepsilon_h = 1 - \exp\left[\frac{e^{-NTU_h^{0.78}} - 1}{NTU_h^{-0.22}}\right] \quad (1)$$

The heat exchanger effectiveness for counter flow with equal capacity rates is:

$$\varepsilon_h = \frac{NTU_h}{NTU_h + 1} \quad (2)$$

The mass exchange effectiveness is analogous the heat exchange effectiveness. The mass exchange effectiveness for cross-flow with equal mass flow rates and both streams unmixed is:

$$\varepsilon_m = 1 - \exp\left[\frac{e^{-NTU_m^{0.78}} - 1}{NTU_m^{-0.22}}\right] \quad (3)$$

and for counter flow is:

$$\varepsilon_m = \frac{NTU_m}{NTU_m + 1} \quad (4)$$

where NTU_h and NTU_m are the Number of Transfer Units, defined by Eq. 5 and Eq. 6, for heat and mass transfer respectively. C , defined by Eq. 7, is the capacity rate of either air stream, m is the air mass flow rate (kg/s) and c_p (J/(kgK)) is the specific heat.

$$NTU_h = U_h A / C \quad (5)$$

$$NTU_m = U_m A / m \quad (6)$$

$$C = mc_p \quad (7)$$

The total heat transfer coefficient U_h (W/m²K) is:

$$\frac{1}{U_h} = \frac{1}{h_s} + \frac{\delta}{\lambda_m} + \frac{1}{h_e} \quad (8)$$

where h_s (W/m²K) and h_e (W/m²K) are the convective heat transfer coefficients for outdoor air stream and relief air stream, respectively, δ (m) is the thickness of the membrane and λ_m (W/mK) is its thermal conductivity.

The total mass transfer coefficient is:

$$\frac{1}{U_m} = \frac{1}{k_s} + r_m + \frac{1}{k_e} \quad (9)$$

where k_s (m/s) and k_e (m/s) are the convective mass transfer coefficients for the outdoor air stream and the relief air stream, r_m (s/m) is the mass transfer resistance of the membrane.

The convective heat transfer coefficient h (W/m²K) and convective mass transfer coefficient k (m/s) can be expressed in terms of the Nusselt number and the Sherwood number (analogous to the Nusselt number) respectively. The Nusselt number is:

$$Nu = hD_h / \lambda \quad (11)$$

and the Sherwood number is:

$$Sh = kD_h / D_v \quad (12)$$

where D_h (m) is the hydraulic diameter and D_v (m²/s) is the diffusivity of water vapor.

The results were examined over a broad range of flow regimes. However, the design strategy adopted for the membrane-based enthalpy recovery exchanger was to maintain operating conditions within the laminar flow regime in order to minimize the ratio of the pressure drop to

the heat and mass transfer. In regular-shaped channels, laminar flow occurs when the Reynolds number, Re , is less than 2300, transitional flow occurs when Re is in the range 2300 - 4000 and turbulent flow occurs when $Re > 4000$. The relationships (Eqs. 13 and 14) used to calculate the Nusselt and Sherwood numbers apply to partially developed laminar flow and are taken from ASHRAE (2009).

$$Nu = 3.66 + \frac{0.065(D_h / L) Re Pr}{1 + 0.04[(D_h / L) Re Pr]^{2/3}} \quad (13)$$

$$Sh = 3.66 + \frac{0.065(D_h / L) Re Sc}{1 + 0.04[(D_h / L) Re Sc]^{2/3}} \quad (14)$$

where L is the length of the flow channel. For flat plate configurations, the reasons for using the relationships for partially developed laminar flow are as following. 1) The flow pattern within the entrance length of the channel is not fully developed. 2) The relationships in ASHRAE (2009) to calculate the Nusselt and Sherwood numbers for developed laminar flow are valid for uniform surface temperature or uniform heat flux; however, these uniform boundary conditions do not apply in the designs considered here.

EVALUATION OF CONFIGURATIONS

To identify the optimum heat exchanger configuration, parametric studies for flat plate membranes and pleated membranes was completed for various featured parameters including aspect ratio, energy recovery area per module, number of layers, number of pleats (for pleated configurations) or gap dimension (for flat plate configurations, the separation distance between uniform membrane layers). A counterflow configuration was assumed in all cases. Unless stated otherwise, the value of the water vapor permeance of the membrane used in the study was fixed.

As shown in Figure 2, when the number of layers is increased, the effectiveness increases and pressure drop decreases for flat configuration. This is also true for pleated configuration.

SAVINGS ASSESSMENT METHODOLOGY

Buildings in two climates in the United States were simulated to investigate the benefits of the technology under consideration. Miami, FL (DOE climate zone: 1A) has a tropical monsoon climate with hot and humid summers and short, warm winters. Atlanta, GA (DOE climate zone: 3A) has a humid subtropical climate with hot humid summers and mild winters. Enthalpy

recovery was implemented in the EnergyPlus model (DOE, 2012) for the DOE Benchmark Mid-size Commercial Office Building (DOE, 2011). This model is widely used to assess and compare the impact of various energy efficiency measures and systems. The building, illustrated in Figure 3, has three stories, 15 thermal zones and a floor area of 4,982 m².

The HVAC system is a packaged VAV system with direct expansion (DX) cooling coils, gas-fired heating coils, supply fans and VAV terminal units with electric reheat. Configurations with and without economizers were simulated. Three different sizes of enthalpy exchanger were implemented. Their effectivenesses are shown in Table 1 and “L”, “M” and “H” denote low effectiveness, medium effectiveness, and high effectiveness, respectively.

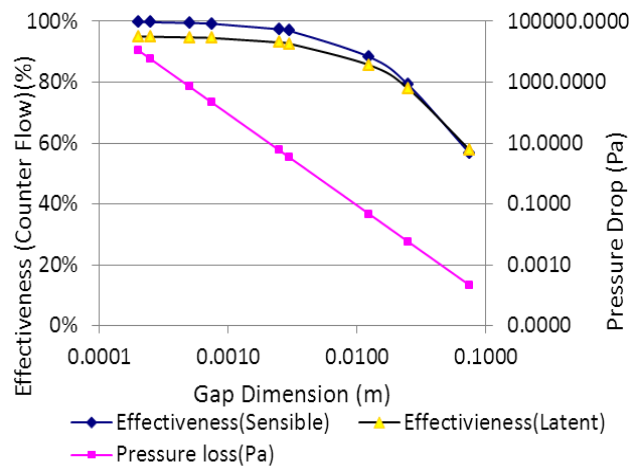

Figure 2 The effects of number of layers on the effectiveness and pressure drop for the flat configuration with aspect ratio =1, normalized energy recovery area per layer=1.2 m²/ (L/s air), gap dimension=3mm

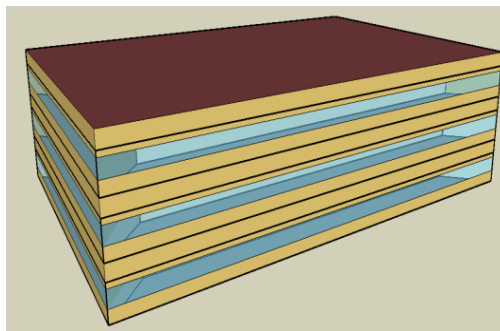

Figure 3 Geometry of the DOE benchmark mid-size commercial office building

Table 1 Enthalpy recovery effectiveness

	L		M		H	
	75% Airflow	100% Airflow	75% Airflow	100% Airflow	75% Airflow	100% Airflow
Sensible	0.75	0.72	0.85	0.81	0.95	0.91
Latent	0.6	0.56	0.8	0.75	0.92	0.89

EVALUATION OF ENERGY SAVING POTENTIAL FOR CONVENTIONAL VAV SYSTEMS

Six different cases were investigated for conventional VAV system.

Case 1: Baseline: no enthalpy recovery, no economizer

A fixed minimum outdoor air flow rate is provided during occupied periods to maintain acceptable indoor air quality.

Case 2: Air side economizer, no enthalpy recovery

The system includes an outdoor air economizer, which can modulate the outside air fraction damper to provide free cooling when the outdoor air conditions are favorable.

Case 3: Enthalpy recovery, no economizer

The optimized recovery technology pre-conditions a fraction of the outside air whenever HVAC system is operating.

Case 4: Enthalpy recovery and air-side economizer

The enthalpy recovery is fully bypassed when the air-side economizer is in free cooling mode and when the outdoor air condition is more favorable than that of the return air, even when the outside air flow rate is at its minimum value. When not in free cooling mode, a variable fraction of the outdoor air stream by-passes the enthalpy exchanger in order to meet the set-point of the supply air outlet temperature. In the EnergyPlus model, the Energy Management System facility is used to integrate the control of the enthalpy exchange bypass with the control of the economizer.

Case 5: Desiccant wheel enthalpy recovery, no economizer

Case 5 is similar to Case 3 except that a desiccant wheel is used in place of a membrane-based enthalpy exchanger, resulting in a substantially higher pressure drop (~251Pa).

Case 6: Desiccant wheel enthalpy recovery and air-side economizer

Case 6 is similar to Case 4 except that a desiccant wheel is used in place of a membrane-based enthalpy exchanger, resulting in a substantially higher pressure drop (~251Pa).

A diagram of the conventional VAV system with the enthalpy recovery ventilation is shown in Figure 4. The enthalpy exchanger is connected to the air side economizer to pre-condition the outdoor supply air at times when the difference between the return air enthalpy and the required supply air enthalpy is less than the difference between outside air enthalpy and the required supply air enthalpy.

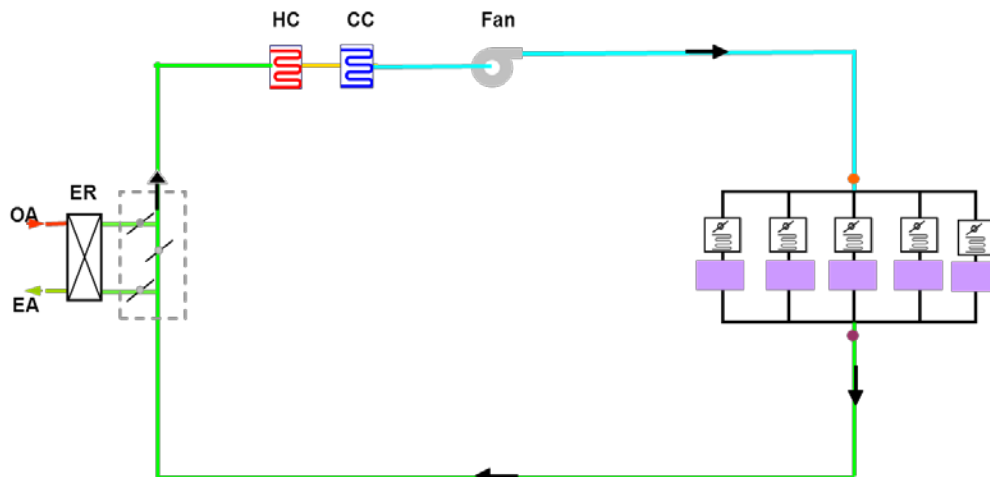

Figure 4 System diagram for conventional VAV system integrated with energy recovery (optimized system, OA-outdoor air, EA-return air, ER-enthalpy recovery, HC-heating coil, CC-cooling coil)

Table 2 summarizes the energy savings predicted for Cases 2-4, relative to the baseline, in terms of HVAC energy use (energy consumption for domestic hot water is not included). The HVAC system includes DX cooling, a direct-fired gas heating coil and electric reheat. In Miami climate, the enthalpy exchanger combined with an outdoor air economizer provides significant savings (11-17%, depending on the effectiveness) while the savings due to the implementation of the economizer are very small (1%).

In the Atlanta climate, Case 4 (coupled system) provides the greatest energy savings (17%); the energy savings due to the implementation of the economizer is about 6% as there are more hours of airside economizer use in Atlanta than in Miami; while Case 3 (with enthalpy recovery and without economizer) provides lower energy savings as an energy penalty is introduced when enthalpy is exchanged between the outside air and the return air when the outdoor conditions are favorable for free cooling. As expected, the energy savings potential increases when the effectiveness of the exchanger is increased. However, whether to select the exchanger with the highest effectiveness needs to be judged on a case-by-case basis, based on a cost/benefit analysis.

Table 2 Annual HVAC energy savings for various HVAC system options – absolute savings per unit floor area and percentage of the Case 1 baseline. L,M and H refer to high, medium and low enthalpy recovery effectiveness, as defined in Table 1. Econ = economizer, Recov = enthalpy recovery.

	CASE 2	CASE 3L	CASE 3M	CASE 3H	CASE 4L	CASE 4M	CASE 4H
Description	Econ only	Recov only	Recov only	Recov only	Recov + Econ	Recov + Econ	Recov + Econ
Miami (kJ/m ²)	189.1	172.8	166.5	162.4	170.0	163.7	158.7
Miami (%)	1%	10%	13%	15%	11%	14%	17%
Atlanta (kJ/m ²)	142.8	140.2	139.2	139.1	121.5	119.5	118.0
Atlanta (%)	6%	2%	3%	3%	15%	16%	17%

Energy savings potential for desiccant wheels assessed using EnergyPlus simulations are listed in Table 3. A commercial product was selected based on the required outdoor air flow rate and conventional sizing practice. The latent and sensible effectivenesses and pressure drop for use in the EnergyPlus model were obtained from the manufacturer’s catalog listed in Table 4. The savings due to the desiccant wheels are significantly less than for membrane-based enthalpy recovery due to the higher pressure drop.

Figures 5 and 6 show the process lines for the base case and the case with medium effectiveness enthalpy recovery plotted on the psychrometric chart for the design condition in Miami climate. To avoid the overlapping of labels for each point, the temperature rise across the supply fan (~0.5K) is not shown. (Note that the design condition is such that an economizer, if one were installed, would be in minimum outside mode and so the process lines are independent of whether an economizer is present.) Figure 5 shows the case without heat recovery. The required

amount of outdoor air (OA) for ventilation is mixed with return air (RA). Then the mixed air (MA) is cooled and dehumidified to the supply air condition (SA); the required reduction in the specific enthalpy of the supply air is 24.9kJ/kg. Figure 6 shows the process with enthalpy recovery; the outdoor air is pre-cooled by the enthalpy exchanger, and the required reduction in the specific enthalpy of the supply air is 7.9kJ/kg less than in the base case.

Table 3 Energy savings for desiccant wheel systems

	CASE 5	CASE 6
	Desiccant wheel only	Desiccant wheel + economizer
Miami (kJ/m ²)	168.7	165.5
Miami (%)	12%	13%
Atlanta (kJ/m ²)	143.7	124.1
Atlanta (%)	-1%	13%

Table 4 Performance data for desiccant wheel

	Sensible Effectiveness	Latent Effectiveness	Pressure drop (Pa)
100% Airflow Heating Condition	80%	72%	251
75% Airflow Heating Condition	83%	77%	
100% Airflow Cooling Condition	80%	72%	
75% Airflow Cooling Condition	83%	77%	

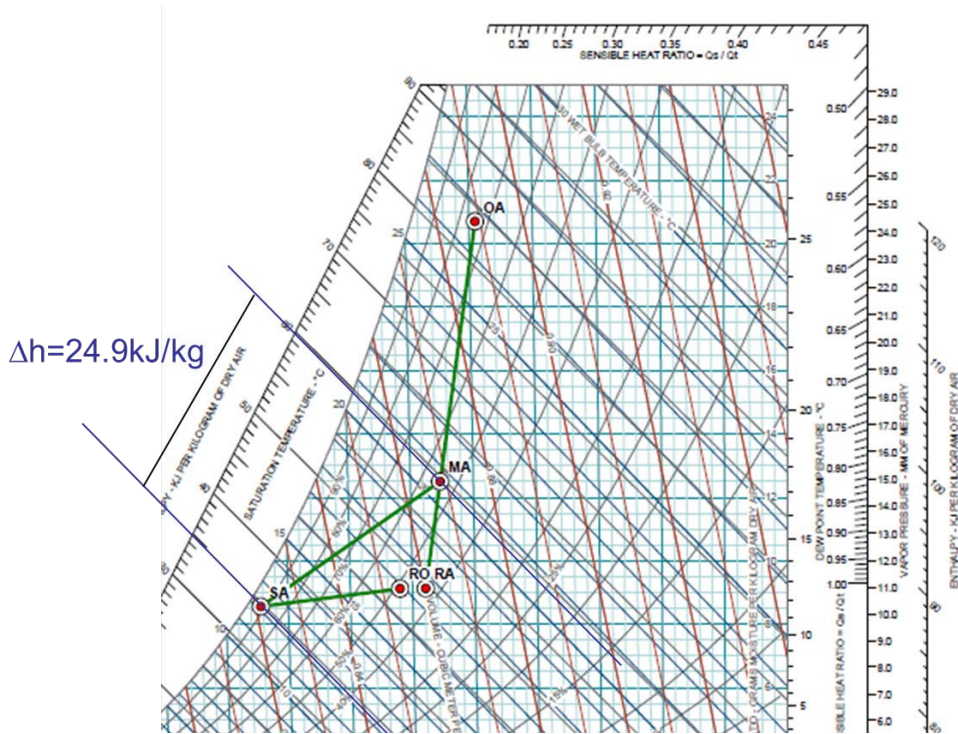

Figure 5 Process without energy recovery and economizer (OA-outdoor air, MA-mixed air, RA- return air, RO-room air, SA- supply air)

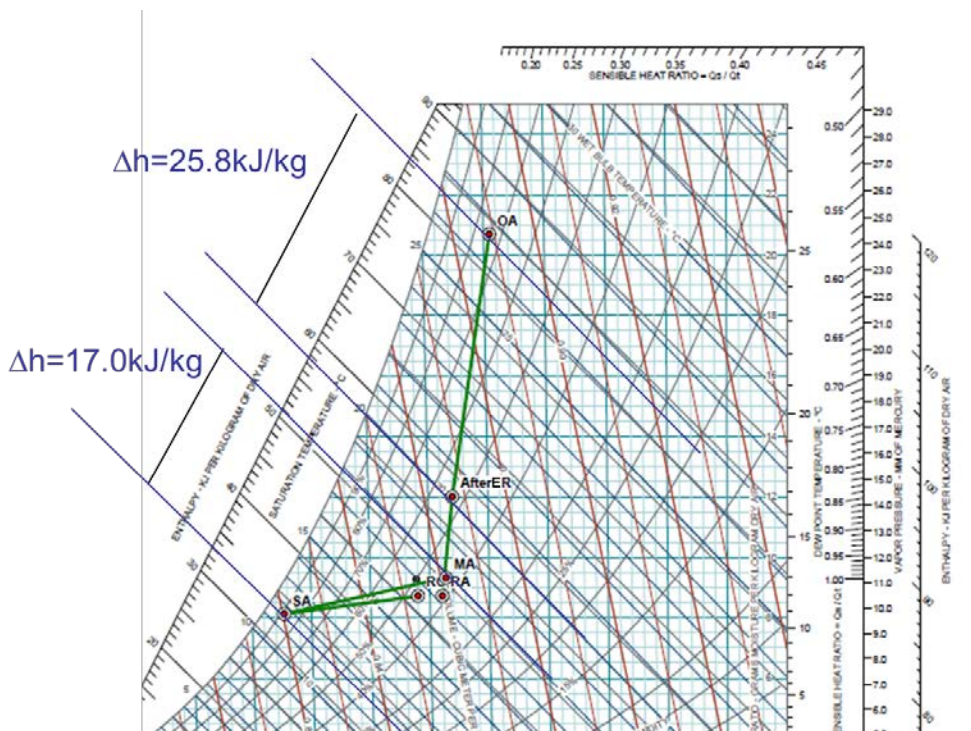

Figure 6 Process with optimized system coupled with air-side economizer (OA-outdoor air, AfterER-outlet of enthalpy exchanger, MA-mixed air, RA- return air, RO-room air, SA- supply air)

To illustrate the performance of the enthalpy exchanger, time series plots of key variables are presented for the summer design day for Miami climate. Figures 7 and 8 show hourly temperature and humidity ratio profiles for the outdoor air, the processed outdoor air after enthalpy recovery and the relief air. It can be seen that sensible heat and water vapor are transferred from the outdoor air to the relief air when building is occupied and outdoor air conditions are not suitable for economizer operation. The hourly fan energy consumption profiles for systems with and without enthalpy recovery are presented and compared in Figure 9. A slight fan energy penalty can be identified when the membrane-based enthalpy recovery is on. The benefits of energy consumptions for HVAC end use can be observed from Figures 10. The hourly values of the COP ratio, defined as the ratio of COP for system with enthalpy recovery to COP for system without enthalpy recovery, are presented in Figure 11. The COP can be increased by as much as 26% through the use of the optimized enthalpy recovery technology.

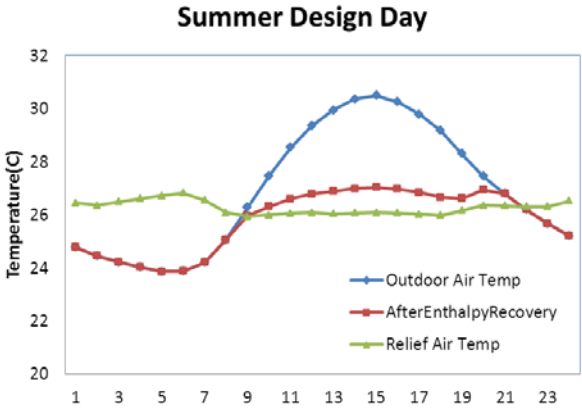

Figure 7 Temperature profile for the summer design day

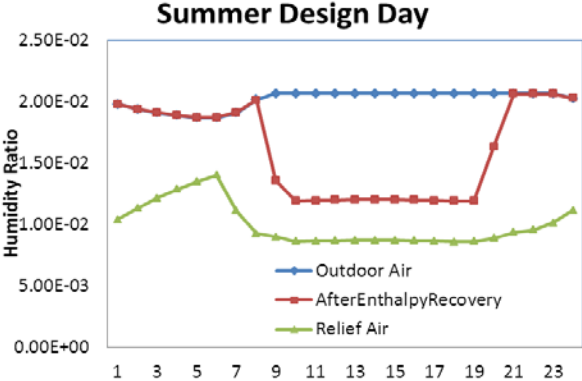

Figure 8 Humidity ratio profile for the summer design day

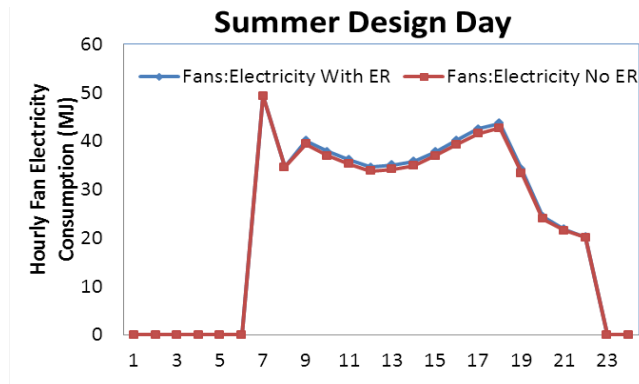

Figure 9 Fan energy consumption profiles for the summer design day

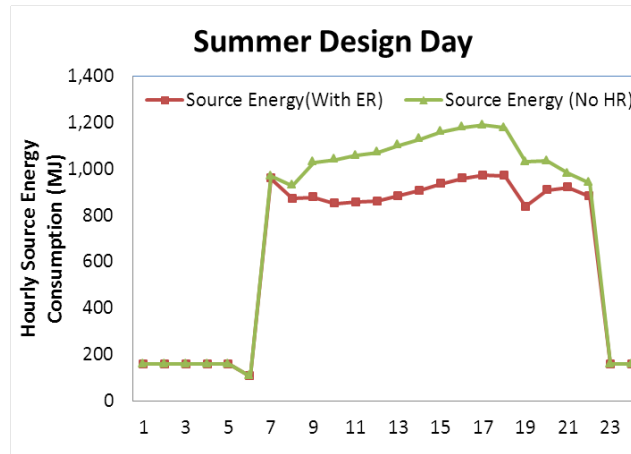

Figure 10 HVAC source energy consumption profile for the summer design day

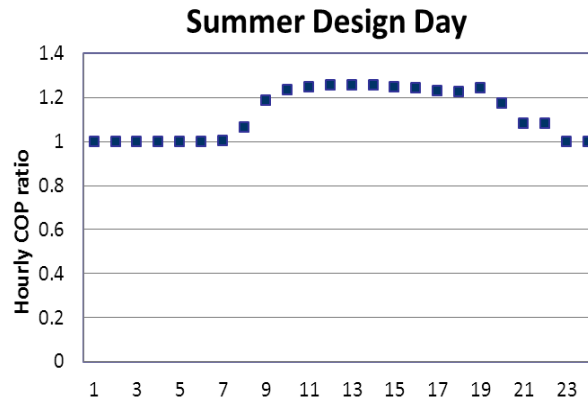

Figure 11 COP ratios for the summer design day

CONCLUSION

A simple design tool was set up to assess the performance of membrane based heat recovery for various configurations. The case of enthalpy recovery combined with an air side economizer provides the greatest energy benefit of the various test cases -17% reduction in annual HVAC

energy consumption in a conventional commercial office building in Miami and Atlanta. The technology raises the system COP by up to 26% over the course of a typical summer design day for Miami climate.

ACKNOWLEDGEMENTS

This work was supported by the Assistant Secretary for Energy Efficiency and Renewable Energy, Office of Building Technology, State and Community Programs of the U.S. Department of Energy under Contract No. DE-AC02-05CH11231 and by the U.S. Department of Energy Advanced Research Projects Agency - Energy.

REFERENCES

ASHRAE 2009. ASHRAE Handbook: Fundamentals, Atlanta, GA

U.S. Department of Energy (DOE), Commercial Reference Buildings; 2011, Available from: http://www1.eere.energy.gov/buildings/commercial_initiative/reference_buildings.html, last accessed on March 28, 2012

U.S. Department of Energy (DOE), Building Technologies Program: EnergyPlus Energy Simulation Software; 2012, Available from: <http://www.energyplus.gov/>, last accessed on June 20, 2012

Min, J., Su, M. 2010 Performance analysis of a membrane-based energy recovery ventilator :Effects of membrane spacing and thickness on the ventilator performance. Applied Thermal Engineering 30: 991-997.

Min, J., Su, M. 2011 Performance analysis of a membrane-based energy recovery ventilator: Effects of outdoor air state. Applied Thermal Engineering 31: 4036-4043.

Nasif, M., Al-Waked, R., Morrison, G., Behnia, M. 2010 Membrane heat exchanger in HVAC energy recovery systems, system energy analysis. Energy and Buildings 42: 1833-1840.

Zhang, L. Z., Jiang, Y. 1999 Heat and mass transfer in a membrane-based energy recovery ventilator. Journal of Membrane Science 163: 29-38.

DISCLAIMER

This document was prepared as an account of work sponsored by the United States Government. While this document is believed to contain correct information, neither the United States Government nor any agency thereof, nor the Regents of the University of California, nor any of their employees, makes any warranty, express or implied, or assumes any legal responsibility for the accuracy, completeness, or usefulness of any information, apparatus, product, or process disclosed, or represents that its use would not infringe privately owned rights. Reference herein to any specific commercial product, process, or service by its trade name, trademark, manufacturer, or otherwise, does not necessarily constitute or imply its endorsement, recommendation, or favoring by the United States Government or any agency thereof, or the Regents of the University of California. The views and opinions of authors expressed herein do not necessarily state or reflect those of the United States Government or any agency thereof or the Regents of the University of California.