

UC Irvine

UC Irvine Previously Published Works

Title

Factors influencing the large-scale distribution of Hg⁰ in the Mexico City area and over the North Pacific

Permalink

<https://escholarship.org/uc/item/1nn4z00v>

Journal

Atmospheric Chemistry and Physics, 8(7)

ISSN

1680-7324

Authors

Talbot, R.
Mao, H.
Scheuer, E.
et al.

Publication Date

2008-04-11

DOI

10.5194/acp-8-2103-2008

Copyright Information

This work is made available under the terms of a Creative Commons Attribution License, available at <https://creativecommons.org/licenses/by/4.0/>

Peer reviewed

Factors influencing the large-scale distribution of Hg° in the Mexico City area and over the North Pacific

R. Talbot¹, H. Mao¹, E. Scheuer¹, J. Dibb¹, M. Avery², E. Browell², G. Sachse², S. Vay², D. Blake³, G. Huey⁴, and H. Fuelberg⁵

¹Institute for the Study of Earth, Oceans, and Space, Climate Change Research Center, University of New Hampshire, Durham, NH 03824, USA

²NASA Langley Research Center, Chemistry and Dynamics Branch, Hampton, VA 23681, USA

³University of California – Irvine, Department of Chemistry, Irvine, CA 92697, USA

⁴Department of Earth and Atmospheric Sciences, Georgia Institute of Technology, Atlanta, GA 30332, USA

⁵Department of Meteorology, Florida State University, Tallahassee, FL 32306, USA

Received: 19 September 2007 – Published in Atmos. Chem. Phys. Discuss.: 2 November 2007

Revised: 13 February 2008 – Accepted: 6 March 2008 – Published: 11 April 2008

Abstract. Gas-phase elemental mercury (Hg°) was measured aboard the NASA DC-8 aircraft during the Intercontinental Chemical Transport Experiment Phase B (INTEX-B) campaign in spring 2006. Flights were conducted around Mexico City and on two subsequent deployments over the North Pacific based out of Honolulu, Hawaii and Anchorage, Alaska. Data obtained from 0.15–12 km altitude showed that Hg° exhibited a relatively constant vertical profile centered around 100 ppqv. Highly concentrated pollution plumes emanating from the Mexico City urban agglomeration revealed that mixing ratios of Hg° as large as 500 ppqv were related to combustion tracers such as CO, but not SO_2 which is presumably released locally from coal burning, refineries, and volcanoes. Our analysis of Mexico City plumes indicated that widespread multi-source urban/industrial emissions may have a more important influence on Hg° than specific point sources. Over the Pacific, correlations with CO, CO_2 , CH_4 , and C_2Cl_4 were diffuse overall, but recognizable on flights out of Anchorage and Honolulu. In distinct plumes originating from the Asian continent the Hg° -CO relationship yielded an average value of ~ 0.56 ppqv/ppbv, in good agreement with previous findings. A prominent feature of the INTEX-B dataset was frequent total depletion of Hg° in the upper troposphere when stratospherically influenced air was encountered. Ozone data obtained with the differential absorption lidar (DIAL) showed that the stratospheric impact on the tropospheric column was a common and pervasive

feature on all flights out of Honolulu and Anchorage. We propose that this is likely a major factor driving large-scale seasonality in Hg° mixing ratios, especially at mid-latitudes, and an important process that should be incorporated into global chemical transport models.

1 Introduction

In the lower troposphere (0–6 km) elemental mercury (Hg°) is observed ubiquitously with contemporary mixing ratios at the parts per quadrillion by volume (ppqv; $1 \text{ ng m}^{-3} = 112 \text{ ppqv}$) level. Accumulation of mercury in lake sediments of both hemispheres shows a worldwide increase in its atmospheric deposition that is highly correlated with industrialization and emissions of CO_2 from combustion of fossil fuels (Lamborg et al., 2002). Although atmospheric measurements are exceedingly sparse, mixing ratios near the Earth's surface appear to have decreased from the mid-1980's to 1990's and stayed constant thereafter (Slemr and Scheel, 1998; Ebinghaus et al., 2002; Slemr et al., 2003; Kim et al., 2005).

The sources and sinks of atmospheric mercury are just beginning to be characterized and quantified. Anthropogenic sources appear to be dominated by emissions from combustion of coal, waste incineration, space heating, transportation, mining, and chlor-alkali facilities (Seigneur et al., 2004, 2006). Natural emissions occur from mercury-enriched soils and vegetation, forest fires, volcanoes, and the oceans (Sigler et al., 2003; Sigler and Lee, 2006; Brunke et al., 2001; Friedli et al., 2001, 2003a, 2003b, 2004; Ebinghaus et al.,



Correspondence to: R. Talbot
(robert.talbot@unh.edu)

2007). Global budget estimates put anthropogenic sources at ~ 2100 metric tons yr^{-1} with roughly twice that amount derived from natural processes and re-emission (Seigneur et al., 2004; Mason and Sheu, 2002; Pacyna and Pacyna, 2002), for a total input of 6000–6500 metric tons yr^{-1} (Streets et al., 2005). However, accurate estimation of natural source strengths is confounded by re-emission of anthropogenic mercury that has deposited to ecosystems and oceans.

There have been few measurements of Hg⁰ over the North Pacific. The first airborne observations were made during the ACE-Asia 2001 campaign over the western Pacific. Plumes containing industrial emissions contained the highest levels that reached 706, 336, and 336 ppqv from China, Korea, and Japan respectively (Friedli et al., 2004). Background concentrations of Hg⁰ from the surface to 7 km were estimated to be about 146 ppqv. Overall, the vertical distribution of Hg⁰ was ~ 224 ppqv at 0.5 km, decreasing slightly to 190 ppqv from 1 to 6 km, and then again sharply to 146 ppqv at 7 km. In a later ground-based study directly downwind of Asian continental outflow at Okinawa, Japan, the mean Hg⁰ concentration was 224 ppqv over the period 23 March to 2 May 2004 (Jaffe et al., 2005).

Asian Hg⁰ emissions have also been assessed through sampling on the U.S. west coast at Mount Bachelor, Oregon. The site is located at 2.7 km altitude, with discrete Asian pollution plume events sampled periodically during springtime. The instrument arrangement measured total gaseous and particulate Hg (TGM) with an average concentration of 198 ppqv from 28 March to 19 May 2004 (Weiss-Penzias et al., 2006). Time periods impacted by Asian emissions were identified by TGM-CO ratios characteristic of Asian sources (~ 0.005 ng m^{-3} /ppbv or 0.56 ppqv/ppbv). The largest of these events (25 April) exhibited a TGM concentration near 280 ppqv, and a TGM-CO ratio of 0.045 ng m^{-3} /ppbv or 5.0 ppqv/ppbv (Jaffe et al., 2005; Weiss-Penzias et al., 2006).

Over the eastern Pacific in spring 2002, Radke et al. (2007) found much lower concentrations where the median ranged from 134 ppqv at 0.5 km to 56 ppqv at 8 km during the Intercontinental Transport and Chemical Transformation Experiment – 2002 (ITCT2K2). Using the variance of their measurements, a lifetime of ~ 100 days was determined for Hg⁰ compared to earlier estimates that suggested a much longer timeframe of 0.5–2 years (Schroeder and Munthe, 1998).

The Tropospheric Chemistry Program (TCP) at the National Aeronautics and Space Administration has conducted airborne science missions over the past 25 years to understand the human impact on the global atmosphere (McNeal et al., 1998). A primary focus has been on quantifying the impact of long-range transport of trace gases and aerosols on the changing chemical composition of the troposphere. Special emphasis has been placed on the North Pacific troposphere due to accelerating Asian emissions during the last two decades (Streets et al., 2001). Four major Pacific expeditions have been conducted by the TCP since 1991 (Hoell et al., 1996, 1997; Jacob et al., 2003), with the Intercontinental

Chemical Transport Experiment Phase B (INTEX-B) being the most recent one in spring 2006. Instrumentation for measurement of Hg⁰ was integrated into the University of New Hampshire (UNH) flight package for INTEX-B to examine its large-scale distribution in North Pacific air masses traveling toward the North American continent.

2 Methods

2.1 Field deployments

The INTEX-B flight series was conducted in two deployments, with the first component based out of Houston, Texas, and the second half split between Honolulu, Hawaii and Anchorage, Alaska. The six Houston flights (4–19 March 2006) were focused on the Mexico City area and the MILAGRO mega-city air quality study occurring there 1–30 March 2006. After a three-week break with the aircraft based at Moffett Field, California, the DC-8 flew three flights out of Honolulu (23–28 April 2006) and then four additional flights from Anchorage (4–12 May 2006). There were an additional 3 transit flights between the hub locations. Mercury measurements were not obtained during the initial transit from Grand Forks, North Dakota to Houston and then on the first local flight (#3) due to a data acquisition problem with the computer. Once this was corrected, data was obtained on all remaining flights.

2.2 Airborne measurements

The inlet arrangement utilized our existing high flow manifold (1500 standard liters per minute) for HNO₃ (Talbot et al., 1997a, 1999). It is designed with a diffuser that boosts the internal pressure of the inlet by up to 150 mbar over ambient to facilitate attaining high flow rates in the upper troposphere, especially when the DC-8 is cruising at Mach 0.88 (Fig. 1). The diffuser and shroud assembly was anodized with mil-spec coating MIL-A-8625E, Chromic Type 1, Class Z with black color. This provided a very hard and smooth surface over the aluminum which reduced drag significantly and acted as an inert surface. The manifold pipe was coated with a vapor deposited fused-silica and heated to 40°C during flight. Flow was maintained by ram pressure and a 400 Hz blower on the exhaust port. For the Hg⁰ measurements the high flow air stream was sub-sampled through a heated (40°C) PFA Teflon line just a few centimeters after the flow entered the main 10 cm diameter manifold (Fig. 1).

A modified Tekran 2537A cold vapor atomic fluorescence spectrometer was used to measure Hg⁰ in a sequential dual channel arrangement with a 150 s time response and limit of detection of ~ 10 ppqv. Constant mass flow of 1.5 standard liters per minute was stabilized through the instrument by the addition of a vacuum source from one of our venturi pumps used for aerosol sampling. The internal pressure of the instrument was maintained during the analysis stage at

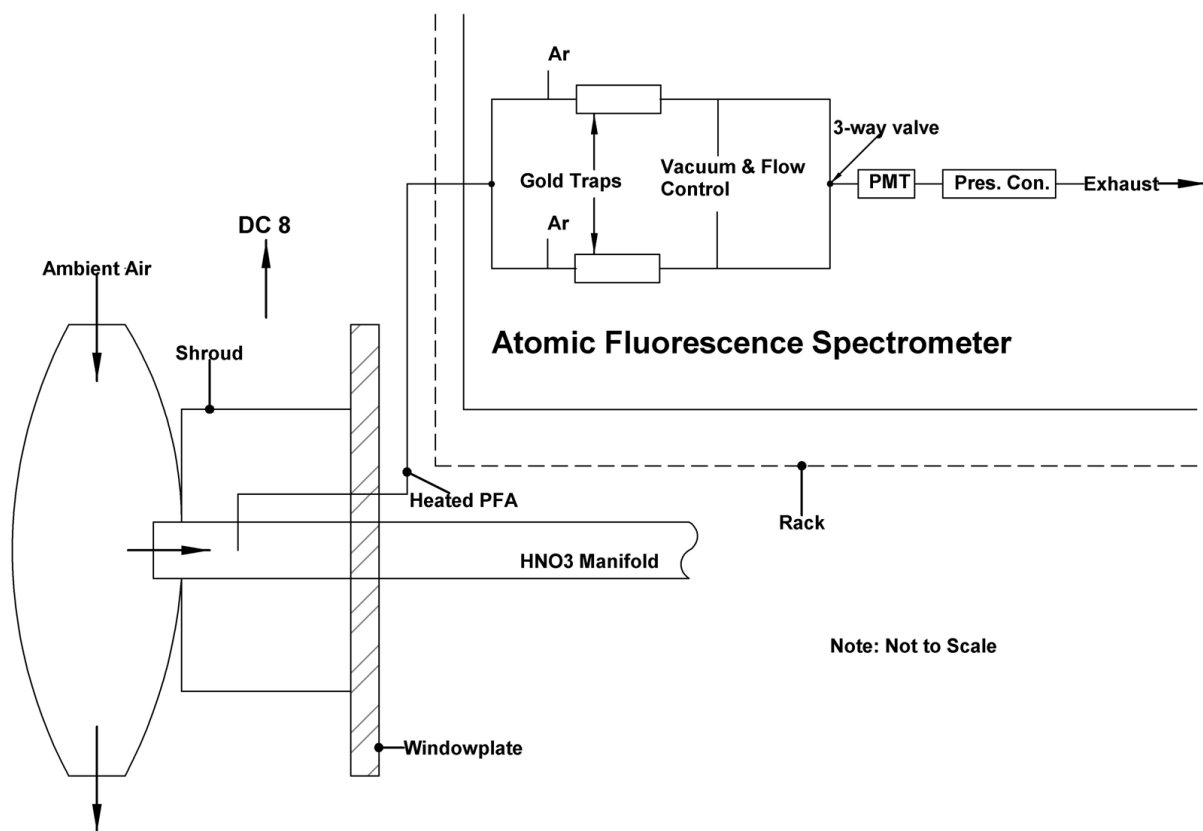

Fig. 1. Schematic representation of custom cold vapor atomic fluorescence spectrometer configured for operation on the DC-8.

a slight overpressure to sea level using upstream control set to 1100 hPa. Mercury-free zero air was generated onboard the DC-8 using cabin air and our own Hg-stripping cartridge train assembly. Zeroing was performed in-flight, and there was no detectable Hg⁰ in the zero air stream at any time during INTEX-B.

To the best of our knowledge, we conducted the first in-flight standard additions for Hg⁰. On non-flight days these were conducted on the ground and then on every science flight at altitudes ranging from 1–12 km. Overall, the Hg⁰ permeation rate was reproducible to within $\pm 9.2\%$ at $0.098 \pm 0.009 \text{ ng min}^{-1}$ ($n=312$). Instrument calibration was cross-checked using injections from the headspace of a thermoelectrically cooled Hg⁰ reservoir (Tekran model 2505). This was done during instrument integration prior to field deployment, and then again back at UNH after INTEX-B was completed. The calibration was reproducible to within $\pm 3\%$ over this five month time period. The response factor (peak area counts $\text{pg}^{-1} \text{ Hg}^0$) was calculated for each of the two channels and found to be constant to $\pm 1\%$ for the entire data set (Fig. 2). The average response factor for each channel (7170 and 7325 counts pg^{-1}) was used in the preparation of the final data to provide an internally consistent data product.

The precision of the measurements was assessed by sampling ambient air at ground level using three co-

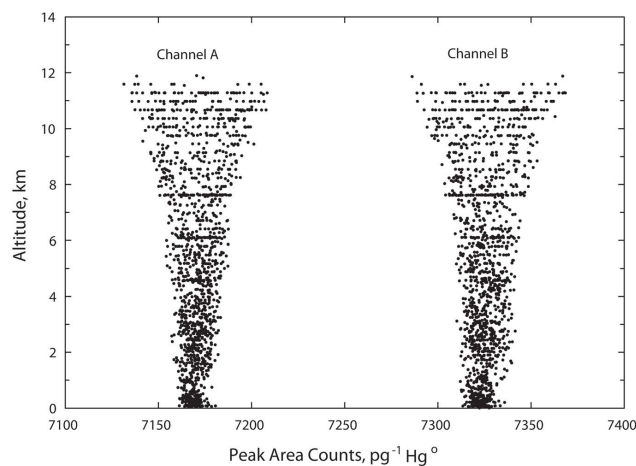

Fig. 2. Response factor of the modified instrument during INTEX-B, including all ambient measurements and standard addition calibrations.

located 2537A instruments. This was done at our local AIRMAP (www.airmap.unh.edu) field site (Thompson Farm) in Durham, New Hampshire (Mao and Talbot, 2004) immediately after the INTEX-B campaign. These

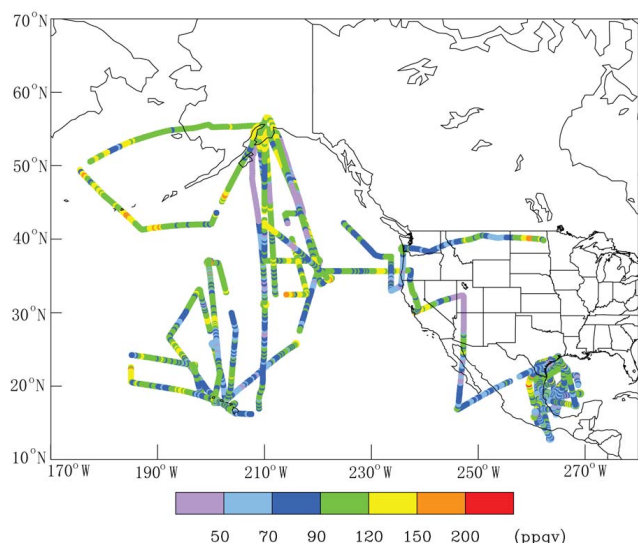

Fig. 3. Large-scale distribution of Hg^o in the Mexico City area and over the North Pacific.

instruments were inter-calibrated using a syringe injection from a Tekran 2505 unit prior to the ambient air measurement time periods. We found that two brand new instruments agreed within $\pm 4\text{--}5\%$, while including a one-year old instrument in the average increased it to $\pm 8\text{--}10\%$. Based on these comparisons, it appears that the precision is on the order of $\pm 10\%$. The accuracy of the Hg^o measurements should be around $\pm 5\%$ due to careful calibration with the headspace injections. This may need to be re-assessed when rigorous calibration standards are available from the US National Institute of Standards and Technology.

The Tekran instrument measures TGM (Hg^o+RGM) as Hg^o (reactive gaseous mercury=RGM=HgCl₂+HgBr₂+HgOBr+...). However, we are not aware of any published information on the direct response of the 2537A to RGM species. At this time we do not have a reliable RGM calibration source in which we have high confidence regarding its operation and output; this is work in progress. In addition, we are unsure of the passing efficiency of RGM through our heated PFA line, but we configured our inlet design to facilitate its quantitative transfer based on extensive experience with airborne HNO₃ measurements. We believe that it should pass RGM with high efficiency based on our current understanding of measuring highly reactive trace gases. In practice the amount of TGM measured over a several minute time interval essentially represents Hg^o unless there is an unusually large amount of RGM present. In most environments, a few minute sampling resolution for RGM is too short to contribute to the measured TGM. Although the distribution of RGM is not known with much certainty, it is predicted to increase with altitude reaching ~ 25 ppqv at 12 km (Selin et al., 2007). Until we have a better understanding of

atmospheric mercury and its speciation, we have chosen to report our TGM measurements as Hg^o.

The complementary data used here from numerous instruments has a long history of inclusion in the DC-8 TCP payload, and the techniques were essentially identical to those described previously by Jacob et al., (2003). Our analysis utilized data for in situ O₃, CO, CO₂, CH₄, hydrocarbons, halocarbons, and remotely sensed O₃ from the DIAL. For the in situ measurements, the TCP data center generated a merged product averaged to the Hg^o time stamp. This was used extensively to understand the principal factors influencing the large-scale distribution of Hg^o during INTEX-B.

3 Large-scale distribution

The large-scale distribution of Hg^o during flights 4–19 is presented in Fig. 3. The majority of Hg^o mixing ratios fell within the range of 60–150 ppqv in all three sampling regions. Exceptions to this were Hg^o mixing ratios of 200–500 ppqv in plumes in the vicinity of Mexico City and Hg^o dropping to essentially zero in air masses at ≥ 10 km altitude that were impacted by stratospheric inputs. Relatively few distinct plumes of Asian continental outflow (> 200 ppqv) were encountered over the eastern North Pacific. These interesting cases of high and low Hg^o are examined in more detail in Sects. 3.2 and 3.3.

The vertical distribution of Hg^o, O₃, and CO, covering the latitudinal band of 14°–62° N over the North Pacific basin, is presented in Fig. 4. An interesting feature of the data from the Mexico City area was the strikingly reduced mixing ratios of CO, and to a lesser extent O₃, above 4 km altitude. Backward trajectories indicated that air masses sampled in the middle and upper troposphere originated over the tropical North Atlantic. To illustrate this point, a 5-day kinematic backward trajectory, calculated by the Florida State University group, is shown in Fig. 5. This trajectory corresponded to a constant altitude leg flown near the midpoint of flight 7. If the trajectories are run backward farther in time, most of them meander in the equatorial region in the Inter-Tropical Convergence Zone. This indicates that these air masses aged photochemically over the remote tropical North Atlantic.

The DIAL data show that there was a preponderance of low O₃ in the 20–40 ppbv range up to 12 km altitude. This was apparent in the DIAL data for every flight conducted in the Mexico City area, and we use flight 7 to depict this pronounced feature in the vertical distribution (Fig. 6). The associated air masses most likely originated at low altitude over the equatorial Atlantic and were lifted to higher altitudes by convective activity, as observed over the Pacific on previous DC-8 airborne missions (Browell et al., 1996, 2001, 2003a). The fact that Hg^o did not follow the sharply decreased altitudinal trend of CO (Fig. 4) indicates that it is not being depleted rapidly in the Tropics. In particular, abundant equatorial OH does not appear to have a large impact on the Hg^o

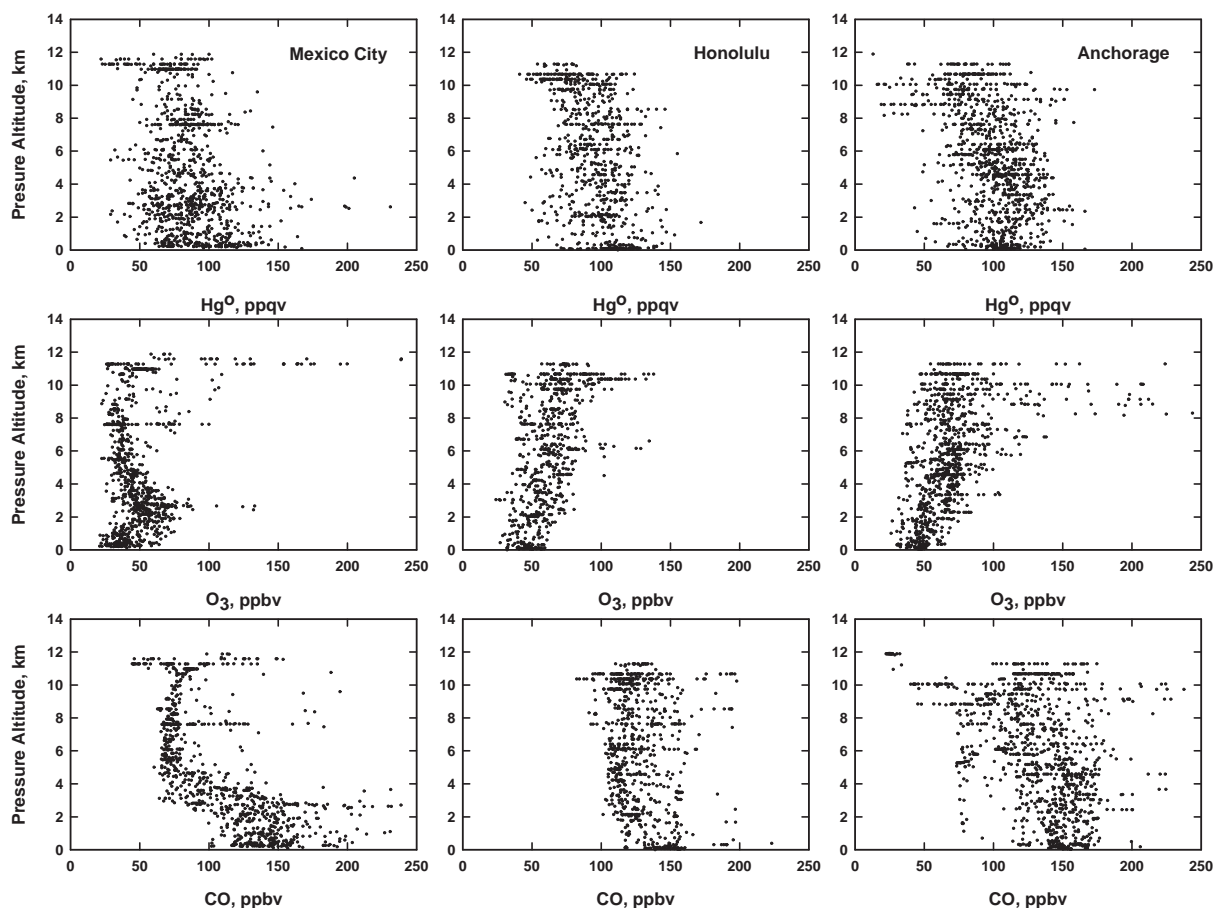

Fig. 4. Vertical distribution of Hg⁰, O₃, and CO covering the latitude band of 14–62° N. Note that the high O₃ and low Hg⁰ present at 11.5 km occurred on the transit flight from Houston, TX to Moffett Field, CA (for details, see Talbot et al., 2007).

distribution. Indeed, slow removal of Hg⁰ in the troposphere by OH was surmised recently through theoretical considerations by Calvert and Lindberg (2005).

Our data provide the first detailed look at the vertical distribution of Hg⁰ in the middle and upper troposphere (Fig. 4). In moving from low to high latitudes we observed the expected patterns in O₃ and CO: (1) a general increase in CO and the presence of distinct plumes due to transport of Asian emissions across the Pacific and, (2) an increasing impact of the stratosphere on the troposphere above 6 km resulting in increased O₃ and decreased CO. The overall corresponding latitudinal trends in Hg⁰ were subtle, as illustrated by the data binned (average ± standard deviation) in 1 km increments (Fig. 7). In the boundary layer mixing ratios of Hg⁰ were essentially indistinguishable between the three study regions. From 2–7 km the average mixing ratio of Hg⁰ was lowest around Mexico City and as much as 25 ppqv higher at mid-to-high latitudes over the North Pacific. Above 8 km there was little variation in the average mixing ratios of Hg⁰ observed during the Mexico City based flights, with values centered around 80 ppqv. As the study area moved north-

ward, sharp decreases in average values were documented. At 11.5 km altitude, the steepest decline occurred in the high latitude flights out of Anchorage where the average mixing ratio of Hg⁰ was 39±42 ppqv with a median of 13 ppqv. These low mixing ratios were driven by the substantial number of 150 s measurement intervals with no detectable Hg⁰ (Talbot et al., 2007).

In the Honolulu area we observed few plumes of Asian pollution ($n=99$ data in plumes) which presumably reduced the overall scatter in Hg⁰ mixing ratios. Our previous work has shown that most of the industrial pollution emanating from Asian sources in springtime is transported across the Pacific at latitudes >40° N (Talbot et al., 1997b, 1999). Data obtained during flights based in Anchorage show a much stronger impact from Asia ($n=247$ data in plumes), and correspondingly more scatter in the Hg⁰ data with higher maximum values. The significant impact of combustion emissions is evident in the whole tropospheric column based on the distribution of CO. In general, the FSU backward trajectories indicated that the Honolulu flights sampled air masses that originated at low latitudes over southern Asia. These regions

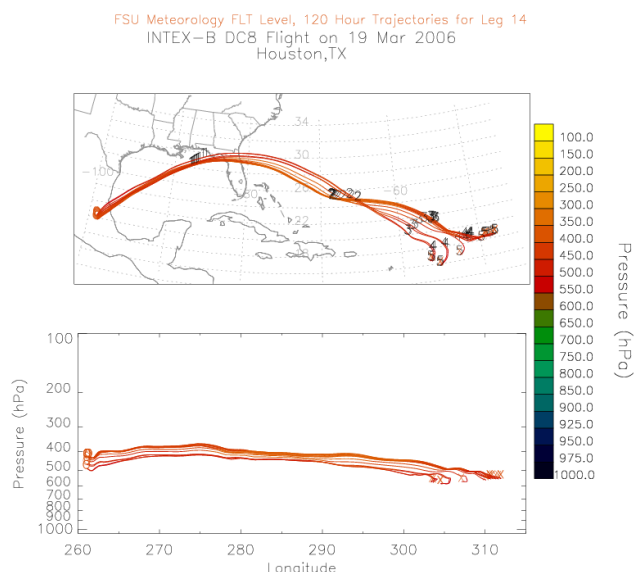

Fig. 5. Kinematic 5-day backward trajectory for the middle troposphere during flight 7.

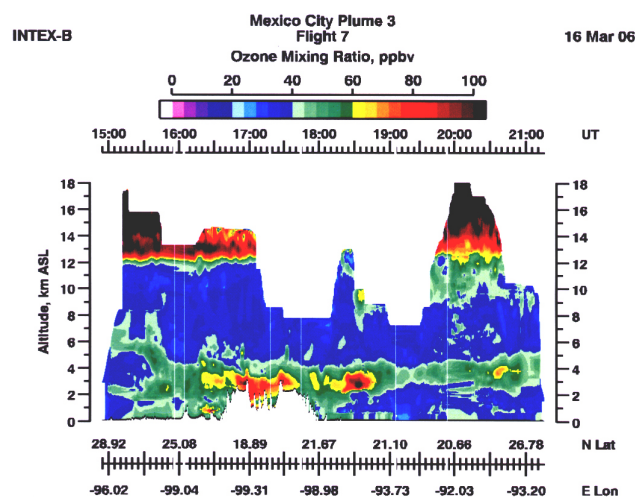

Fig. 6. Vertical distribution of O_3 determined by the DIAL system during flight 7 in the Mexico City area. Note the Mexico City urban plume embedded in $\text{O}_3 < 40$ ppbv background air from the surface to 12 km altitude.

have less urban-industrial sources than coastal northerly areas of China, and could also contain dilute emissions from biomass burning in Southeast Asia.

The lowest average Hg^0 mixing ratios between 2 and 6 km altitude were observed in the Mexico City area (Fig. 7), which potentially could be related to emission of mega-city anthropogenic halogen compounds. On the other hand, the slightly lower Hg^0 was associated with low CO (Fig. 4), and Hg^0 could have been lowered by oxidation during aging in the Tropics. In the Tropics the air is generally moving vertically, so that boundary layer air gets mixed upward. Hg^0

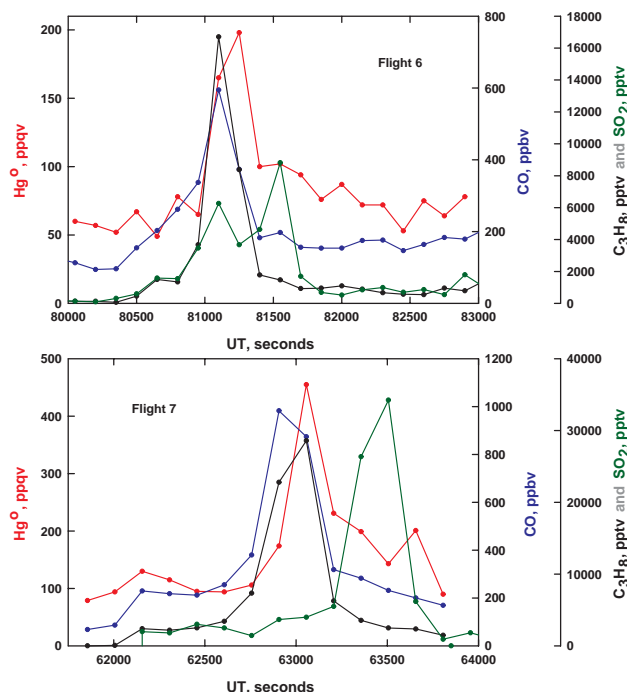

Fig. 7. Vertical distribution of Hg^0 based on binning the data in 1 km altitude increments. The data are plotted as the mean \pm standard deviation.

might be reduced in the marine boundary layer due to its oxidation by halogens, and this air was then transported vertically. A better understanding of the phenomena affecting Hg^0 will require additional measurements and modeling to determine the relative influence of halogen chemistry with subsequent removal of RGM by precipitation scavenging.

There have been few measurements of Hg^0 over the oceans. Laurier et al. (2003) found a relatively constant 280 ppqv over the North Pacific during a May 2002 cruise between Osaka, Japan, and Honolulu, Hawaii. These relatively high concentrations were collected about ~ 10 m above the sea surface and could be influenced by recent oceanic emissions of Hg^0 . During ACE-Asia 2001 over the western Pacific Friedli et al. (2004) observed an average TGM concentration of about ~ 225 ppqv in the marine boundary layer (MBL). Over the eastern Pacific just offshore from California, Oregon, and Washington in spring 2002, measurements of Hg^0 during ITCT2K2 yielded an average MBL concentration of $\sim 135 \pm 22$ ppqv (Radke et al., 2007). The Radke et al. (2007) data are well within the range of our MBL (< 2 km) grand mean value of 105 ± 27 ppqv ($n=691$).

Interestingly, we observed mixing ratios of Hg^0 near 50 ppqv in the boundary layer (< 2 km) in each of the study areas. The occurrence of these low values was about 10% of the time during the Mexico City flights, and decreased to only a few percent in Honolulu and Anchorage. These low values are likely related to halogen oxidation of Hg^0 with

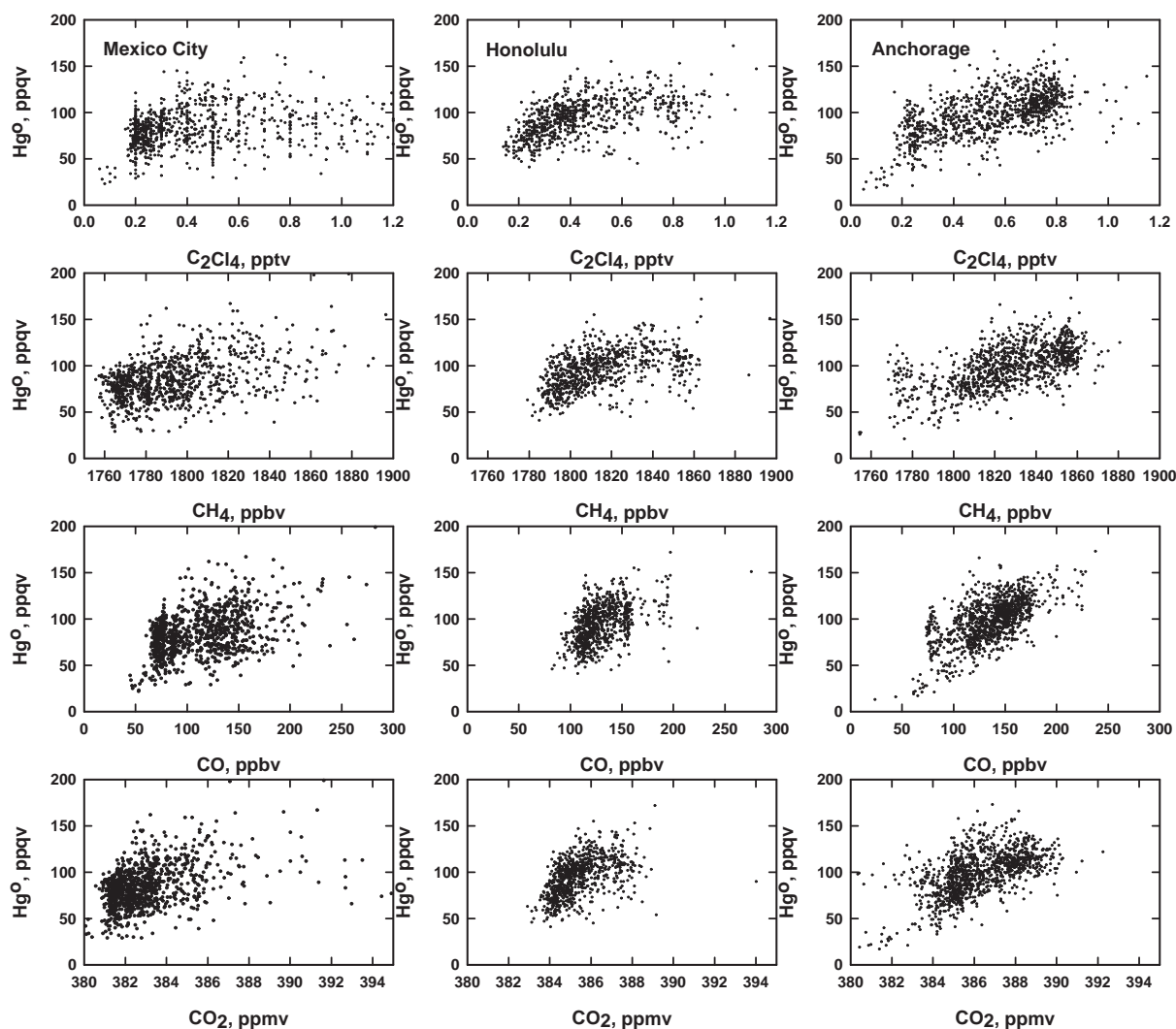

Fig. 8. Regional correlations between Hg° and CO_2 , CO , CH_4 , and C_2Cl_4 .

subsequent removal of RGM in the MBL or from downward transport of stratospheric air containing low Hg° . In most cases of low Hg° in the boundary layer the data indicated that the air masses were aged with relatively small mixing ratios of urban-industrial tracers such as C_2Cl_4 and CHCl_3 . The reason for the low Hg° mixing ratios was not apparent in our data, but likely was caused by a combination of oxidation by halogens (Holmes et al., 2006) and stratospheric air occasionally reaching the surface (Talbot et al., 2007).

3.1 Correlation with source tracer species

Regional correlations between Hg° and CO , CO_2 , CH_4 , and C_2Cl_4 are illustrated in Fig. 8. Although these relationships are somewhat diffuse, they suggest a continental urban source for Hg° in the sampled air masses, especially at latitudes downwind of Asian and possibly European sources. It is well known that there is rapid and substantial export

of polluted air masses to the North Pacific from the Asian continent in springtime (Talbot et al., 1997b; Russo et al., 2003). Kinematic backward trajectories calculated along the INTEX-B flight tracks indicated that the plumes originated over the Asian continent usually 2–3 days prior to our sampling of them (not shown). The general correlation of Hg° with C_2Cl_4 in these plumes is indicative of urban/industrial sources, and there was also an identical relationship with CHCl_3 (not shown) but not halon-1211 (CF_2ClBr) which is a fairly recent specific tracer of Chinese urban emissions (Blake et al., 2003). The apparent correlation of Hg° with CH_4 and other hydrocarbons such as C_2H_6 , C_2H_2 , and C_3H_8 (not shown) likely reflects their co-located sources in Asia such as landfills, wastewater treatment, and bio/fossil fuel burning (Bartlett et al., 2003). There was little or no correlation of Hg° with SO_2 , CO_2 , or aerosol- SO_4^{2-} as might be expected from the large and increasing emissions from coal

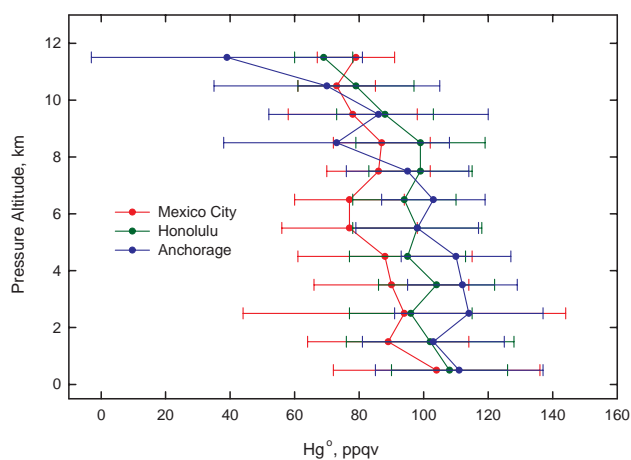

Fig. 9. Selected plume composition at 2.6 km altitude around Mexico City on flights 6 and 7.

combustion in China (Streets et al., 2005). This result probably reflects the influence of wet convective processing on Asian sulfur emissions and a complexity of sources for CO₂.

Overall, the correlations were weaker in the Honolulu dataset and essentially nonexistent around Mexico City except in concentrated pollution plumes. At low latitudes this may have been the result of aged well processed equatorial air masses sampled above 2–3 km altitude. This consequently was reflected in, for example, the range in mixing ratios of CO₂ being several ppmv less at low compared to mid-to-high latitudes (Fig. 8). These trends were present despite CO₂ reaching its seasonal maximum mixing ratio in March (Mexico City) and approaching the high northern latitude minimum in May (Anchorage). This presumably reflects the significant impact of combustion, presumably originating in Asia, on the high latitude atmosphere.

Pollution plumes originating from Mexico City were easily identifiable by their anomalously enriched mixing ratios of C₃H₈ (Blake and Rowland, 1995), on the order of tens of ppbv. The largest mixing ratios of Hg⁰ observed during INTEX-B were also found in these plumes. The plumes, sampled near 2.6 km (i.e., near the altitude of Mexico City), were thin well defined layers rich in combustion related trace gases represented by CO in Fig. 9. The highest mixing ratio of Hg⁰ in the Mexico City plumes approached 500 ppqv (Fig. 9, lower panel), coincident with C₃H₈ levels near 30 ppbv. While some of the C₃H₈ was undoubtedly a combustion byproduct, its exceedingly high mixing ratios and C₂H₆/C₃H₈ ratios <0.5 indicate that leakage is still occurring from liquefied petroleum storage on a massive scale as identified by Blake and Rowland (1995) more than a decade ago. Moreover, many of the layers contained mixing ratios of HCN and CH₃CN at several ppbv which is indicative of combustion contributions from biomass burning. There were not, however, coincidentally enhanced mix-

ing ratios of the biomass burning tracer CH₃Cl, a result that complicates source identification. There was little correspondence between Hg⁰ and SO₂ which presumably is due to emissions from coal combustion, refineries, and active volcanoes in the area. In fact, Hg⁰ and SO₂ were almost anti-correlated in these layers (Fig. 9), and all the other ones encountered during the Mexico City flight series. The plumes sampled during flights 6 and 7 were northeast of the city area and traveling toward the Gulf of Mexico. The flights on these two days covered nearly identical geographic paths. Backward trajectories indicated the air masses were over the Gulf of Mexico the previous day, then traveled directly over the urban area and headed back out to the ocean. The volcano Popocatepetl is south of the city area and at >5 km altitude, so we do not believe it was sampled by the DC-8. Our analysis of the composition of these Mexico City plumes indicates that widespread multi-source urban/industrial emissions may have a more important influence on Hg⁰ than specific point sources.

3.2 Plume Hg⁰ – CO relationships

It is apparent from the vertical distributions of Hg⁰ and CO (Fig. 4) that pollution plumes were sampled in all three study areas. These data were extracted from the dataset by calculating the median CO mixing ratio in 2 km altitude bins to generate subsets with several hundred data points in each. The data corresponding to CO values greater than the median value are plotted in Fig. 10. We were able to fit the data from the flight series in Honolulu and Anchorage with a linear correlation that produced slopes of 0.37 ± 0.07 ppqv/ppbv and 0.66 ± 0.05 ppqv/ppbv respectively. The data obtained around the Mexico City area exhibited too much scatter to reliably determine a relationship between Hg⁰ and CO with the few measurements obtained in the highly concentrated plumes emanating from Mexico City. However, we estimated it to be very similar to the value determined for Honolulu, or around 0.30 ppqv/ppbv based on the sampling of selected plumes (Fig. 9). The lower ratio values around Mexico City and Honolulu compared to higher latitudes might reflect less contribution from coal-combustion and possibly a greater impact of biomass burning emissions. We also examined the Hg⁰–CO₂ relationship in all three study locations, but the scatter was too great to provide meaningful information.

For comparison to our Hg⁰–CO correlations, Jaffe et al. (2005) reported a mean value of 0.63 ± 0.18 ppqv/ppbv determined at Okinawa, Japan and a similar value for Asian plumes sampled at Mount Bachelor, Oregon. The Asian plume data collected at Mount Bachelor between March 2004 and September 2005 was summarized by Weiss-Penzias et al. (2007), and yielded 0.52 ± 0.15 ppqv/ppbv. Friedli et al. (2004) also examined the Hg⁰–CO relationship in Asian emissions over the western Pacific during ACE-Asia-2001. They found no clear relationship and attributed it to the suite of mixed combustion sources sampled in the

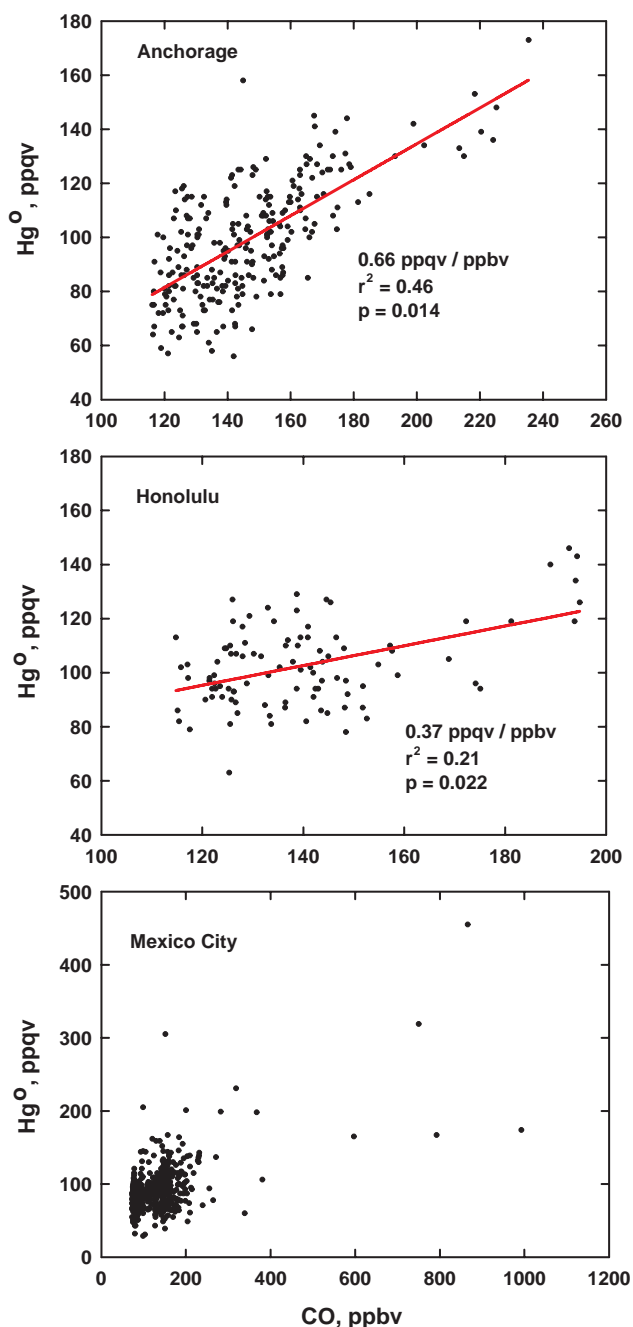

Fig. 10. Relationship between Hg^o and CO in plumes with CO > median value in 2 km altitude bins.

same air masses. In the Shanghai plume, sampled separately, a value of 0.63 ppqv/ppbv was determined. These two studies close to Asia and our data for the central North Pacific all indicate that Asia, in particular continental outflow from China, has a characteristic Hg^o–CO ratio near 0.56 ppqv/ppbv. In the U.S. with lower mercury emissions (Pacyna and Pacyna, 2002), we have determined a distinguishing value for the Northeast of ~ 0.22 ppqv/ppbv (Mao

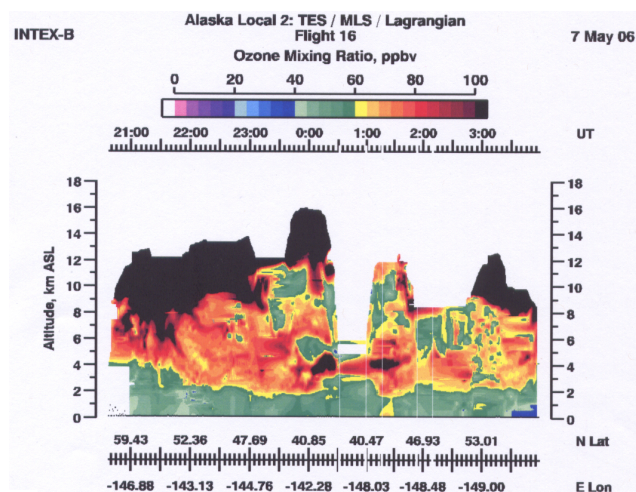

Fig. 11. Vertical distribution of O₃ measured by the DIAL system along the flight track of mission 16. The three regions of Hg^o depletion occurred north of 48° N at 10 km altitude. These regions were well into the lower stratosphere as indicated by the O₃ mixing ratios exceeding 100 ppbv.

et al., 2007). This value is similar to what was found on one flight over the Los Angeles Basin where the Hg^o–CO relationship varied from 0.17 to 0.27 ppqv/ppbv (Radke et al., 2007). Somewhat lower Hg^o–CO emission ratios result from biomass burning in South America, South Africa, Canada, and the U.S., falling within the rather narrow range of $0.67\text{--}2.4 \times 10^{-7}$ mol/mol (~ 0.16 ppqv/ppbv) (Ebinghaus et al., 2007).

3.3 Hg^o depletion in upper troposphere

A prominent feature of the INTEX-B dataset was the frequent total depletion of Hg^o (\sim zero ppqv) in the upper troposphere/lower stratosphere (Figs. 4 and 7; Talbot et al., 2007). Depletion (i.e., Hg^o < 50 ppqv, the minimum observed in the lower troposphere) was observed on four of the six flights flown from Anchorage, Alaska, and on one flight from Houston, Texas to Moffett Field, California during March 2006. The mixing ratios of O₃ in these air masses were commonly 200–400 ppbv, and peaked near 1 ppmv during flight 14. A negative correlation between Hg^o and O₃ was also observed previously at 6–8 km altitude during two ITCT2K2 flights along the US west coast (Radke et al., 2007).

The DIAL data, for example, show that on flight 16 the tropopause folding region north of 48° N indicated that the DC-8 was well within this stratospherically influenced region during three Hg^o depletion events (Fig. 11). It also appears that the stratospheric influence (i.e., elevated O₃) penetrated downward to 2 km altitude. Overall, the DIAL data demonstrate that a pervasive stratospheric impact on the tropospheric column was a common feature of all flights out of Honolulu and especially Anchorage.

Our previous measurements have shown that in tropospheric air impacted by stratospheric inputs there is good correspondence between O₃ and potential vorticity over large regions (Browell et al., 2003 a, b). Mixing of stratospheric and tropospheric air would effectively reduce the mixing ratio of Hg⁰ in the free troposphere by addition of stratospheric air containing little or no Hg⁰. Eventually this impact must filter down into the MBL, but there was no evidence of a gradient in the Hg⁰ mixing ratio at low altitude (Fig. 7). Because tropopause folding events occur with highest frequency in late winter and spring (Seo and Bowman, 2001; Holton et al., 1995), they are likely a major factor driving large-scale seasonality in tropospheric Hg⁰ mixing ratios. In fact, the INTEX-B data probably reflect the minimum annual level of Hg⁰ over the central and North Pacific basins. We note that a stratospheric influence is not evident in the boundary layer over populated mid-latitude continental areas due to active emission/sink processes obscuring the effect. A case in point is in the northeastern US where the UNH AIRMAP ground-based atmospheric mercury monitoring network shows a reproducible seasonality in Hg⁰, driven largely by local removal processes, with the highest mixing ratios occurring in late March/early April and the lowest levels in late September/early October (Mao et al., 2007).

4 Conclusions

Our findings increase the complexity required to simulate atmospheric mercury with a global chemical transport model. Atmospheric Hg⁰ at high latitudes over the north Pacific is impacted by heavy industrial emissions, including coal-combustion. General urban emissions appear to be important in the Honolulu area, and this may include biomass burning emissions from Southeast Asia. Around Mexico City there appears to be a general influence on Hg⁰ from all types of combustion, and perhaps the volcanic emissions from Popocatepetl, although we seemingly did not sample this source directly. Reduced mixing ratios of Hg⁰ in the middle troposphere around Mexico City may be related to emissions of anthropogenic halogen species. At all three study sites we observed reduced mercury (<50 ppqv) at low altitude, but could not determine the reason for it. It is likely related to oxidation by halogen species, perhaps ones with a natural source from the ocean, and subsidence of Hg⁰ depleted air. At high altitude there was a significant impact of reduced Hg⁰ mixing ratios from inputs of stratospheric air. Clearly, global atmospheric mercury cycling is multifaceted and very detailed simultaneous measurements of Hg⁰, RGM, and Hg^P are highly desirable to gain increased insight on processes revealed by our dataset and better inform regional and global models.

Acknowledgements. We thank the flight crew of the NASA DC-8 aircraft for their help with this field deployment and another successful airborne sciences mission. This work was

supported by the NASA Tropospheric Chemistry Program under grant #NNG06GA56G and the NOAA AIRMAP grant #NA06OAR4600189 to UNH.

Edited by: A. B. Guenther

References

- Bartlett, K. B., Sachse, G. W., Slate, T., Harward, C., and Blake, D. R.: Large-scale distribution of CH₄ in the western North Pacific: Sources and transport from the Asian continent, *J. Geophys. Res.*, 108(D20), 8807, doi:10.1029/2002JD003076, 2003.
- Blake, D. R. and Rowland, F. S.: Urban leakage of liquefied petroleum gas and its impact on Mexico City air quality, *Science*, 269, 953–956, 1995.
- Blake, N. J., Blake, D. R., Simpson, I. J., Meinardi, S., Swanson, A. L., Lopez, J. P., Katzenstein, A. S., Barletta, B., Shirai, T., Atlas, E., Sachse, G., Avery, M., Vay, S., Fuelberg, H. E., Kiley, C. M., Kita, K., and Rowland, F. S.: NMHCs and halocarbons in Asian continental outflow during the Transport and Chemical Evolution over the Pacific (TRACE-P) Field Campaign: Comparison with PEM-West B, *J. Geophys. Res.*, 108(D20), 8806, 2003.
- Browell, E. V., Fenn, M. A., Butler, C. F., Grant, W. B., Merrill, J., Newell, R. E., Bradshaw, J. D., Sandholm, S., Anderson, B., Bandy, A. R., Bachmeier, A. S., Blake, D. R., Davis, D. D., Gregory, G. L., Heikes, B., Kondo, Y., Liu, S., Rowland, F. S., Sachse, G. W., Singh, H., Talbot, R. W., and Thornton, D. C.: Large-scale air mass characteristics observed over Western Pacific during summertime, *J. Geophys. Res.*, 101(D1), 1691–1712, 1996.
- Browell, E. V., Fenn, M. A., Butler, C. F., Grant, W. B., Ismail, S., Ferrare, R. A., Kooi, S. A., Brackett, V. G., Clayton, M. B., Avery, M. A., Barrick, J. D. W., Fuelberg, H. E., Maloney, J. C., Newell, R. E., Zhu, Y., Mahoney, M. J., Anderson, B. E., Blake, D. R., Brune, W. H., Heikes, B. G., Sachse, G. W., Singh, H. B., and Talbot, R. W.: Large-scale air mass characteristics observed over the remote tropical Pacific Ocean during March–April 1999: Results from PEM-Tropics B field experiment, *J. Geophys. Res.*, 106(D23), 32,481–32,501, 2001.
- Browell, E. V., Fenn, M. A., Butler, C. F., Grant, W. B., Brackett, V. G., Hair, J. W., Avery, M. A., Newell, R. E., Hu, Y., Fuelberg, H. E., Jacob, D. J., Anderson, B. E., Atlas, E. L., Blake, D. R., Brune, W. H., Dibb, J. E., Fried, A., Heikes, B. G., Sachse, G. W., Sandholm, S. T., Singh, H. B., Talbot, R. W., Vay, S. A., and Weber, R. J.: Large-scale ozone and aerosol distributions, air mass characteristics, and ozone fluxes over the western Pacific Ocean in late winter/early spring, *J. Geophys. Res.*, 108(D20), 8805, doi:10.1029/2002JD003290, 2003a.
- Browell, E. V., Hair, J. W., Butler, C. F., Grant, W. B., DeYoung, R. J., Fenn, M. A., Brackett, V. G., Clayton, M. B., Brasseur, L. A., Harper, D. B., Ridley, B. A., Klonecki, A. A., Hess, P. G., Emmons, L. K., Tie, X., Atlas, E. L., Cantrell, C. A., Wimmers, A. J., Blake, D. R., Coffey, M. T., Hannigan, J. W., Dibb, J. E., Talbot, R. W., Flocke, F., Weinheimer, A. J., Fried, A., Wert, B., Snow, J. A., and Lefer, B. L.: Ozone, aerosol, potential vorticity, and trace gas trends observed at high-latitudes over North America from February to May 2000, *J. Geophys. Res.*, 108(D4), 8369, doi:10.1029/2001JD001390, 2003b.

- Brunke, E. G., Labyschagne, C., and Slemr, F.: Gaseous mercury emissions from a fire in the Cape Peninsula, South Africa, during January 2000, *Geophys. Res. Lett.*, 28, 1483–1496, 2001.
- Calvert, J. G. and Lindberg, S. E.: Mechanisms of mercury removal by O₃ and OH in the atmosphere, *Atmos. Environ.*, 39, 3355–3367, 2005.
- Ebinghaus, R., Kock, H. H., Coggins, A. M., Spain, T. G., Jennings, S. G., and Temme C. H.: Long-term measurements of atmospheric mercury at Mace Head, Irish west coast, between 1995 and 2001, *Atmos. Environ.*, 36, 5267–5276, 2002.
- Ebinghaus, R., Slemr, F., Brenninkmeijer, C. A. M., van Velthoven, P., Zahn, A., Hermann, M., O’Sullivan, D. A., and Oram, D. E.: Emissions of gaseous mercury from biomass burning in South America in 2005 observed during CARIBIC flights, *Geophys. Res. Lett.*, 34, L08813, doi:10.1029/2006GL028866, 2007.
- Friedli, H. R., Radke, L. F., and Lu, J. Y.: Mercury in smoke from biomass fires, *Geophys. Res. Lett.*, 28(17), 3223–3226, 2001.
- Friedli, H. R., Radke, L. F., Lu, J. Y., Banic, C. M., Leaitch, W. R., and MacPherson, J. I.: Mercury emissions from burning of biomass from temperate North American forests: laboratory and airborne measurements, *Atmos. Environ.*, 37, 253–267, 2003a.
- Friedli, H. R., Radke, L. F., Prescott, R., Hobbs, P. V., and Sinha, P.: Mercury emissions from the August 2001 wildfires in Washington State and an agricultural waste fire in Oregon and atmospheric mercury budget estimates, *Global Biogeochem. Cycles*, 17(2), 1039, doi:10.1029/2002GB001972, 2003b.
- Friedli, H. R., Radke, L. F., Prescott, R., Li, P., Woo, J.-H., and Carmichael, G. R.: Mercury in the atmosphere around Japan, Korea, and China as observed during the 2001 ACE-Asia field campaign: Measurements, distributions, sources, and implications, *J. Geophys. Res.*, 109, D19S25, doi:10.1029/2003JD004244, 2004.
- Hoell, J. M., Davis, D. D., Liu, S. C., Newell, R., Shipham, M., Akimoto, H., McNeal, R. J., Bendura, R. J., and Drewry, J. W.: Pacific Exploratory Mission-West (PEM-West A): September–October 1991, *J. Geophys. Res.*, 101(D1), 1641–1654, 1996.
- Hoell, J. M., Davis, D. D., Liu, S. C., Newell, R. E., Akimoto, H., McNeal, R. J., and Bendura, R. J.: The Pacific Exploratory Mission-West Phase B: February–March, 1994, *J. Geophys. Res.*, 102(D23), 28 223–28 240, 1997.
- Holmes, C. D., Jacob, D. J., and Yang, X.: Global lifetime of elemental mercury against oxidation by atomic bromine in the free troposphere, *Geophys. Res. Lett.*, 33, L20808, doi:10.1029/2006GL027176, 2006.
- Holton, J. R., Haynes, P. H., McIntyre, M. E., Douglass, A. R., Rood, R. B., and Pfister, L.: Stratosphere-troposphere exchange, *Rev. Geophys.*, 33, 403–439, 1995.
- Jacob, D. J., Crawford, J. H., Kleb, M. M., Connors, V. S., Bendura, R. J., Raper, J. L., Sachse, G. W., Gille, J. C., Emmons, L., and Heald, C. L.: Transport and Chemical Evolution over the Pacific (TRACE-P) aircraft mission: Design, execution, and first results, *J. Geophys. Res.*, 108(D20), 9000, doi:10.1029/2002JD003276, 2003.
- Jaffe, D., Prestbo, E., Swartzendruber, P., Weiss-Penzias, P., Kato, S., Takami, A., Hatakeyama, S. and Kajii, Y.: Export of atmospheric mercury from Asia, *Atmos. Environ.*, 39, 3029–3038, 2005.
- Kim, K.-H., Ebinghaus, R., Schroeder, W. H., Blanchard, P., Kock, H. H., Steffen, A., Froude, F. A., Kim, M.-Y., Hong, S., and Kim, J.-H.: Atmospheric mercury concentrations from several observatory sites in the northern hemisphere, *J. Atmos. Chem.*, 50, 1–24, 2005.
- Lamborg, C. H., Fitzgerald, W. F., Damman, A. W. H., Benoit, J. M., Balcom, P. H., and Engstrom, D. R.: Modern and historic atmospheric mercury fluxes in both hemispheres: Global and regional mercury cycling implications, *Global Biogeochem. Cycles*, 16(4), 1104, doi:10.1029/2001GB001847, 2002.
- Laurier, F. J. G., Mason, R. P., Whalin, L., and Kato, S.: Reactive gaseous mercury formation in the North Pacific Ocean’s marine boundary layer: A potential role of halogen chemistry, *J. Geophys. Res.*, 108(D17), 4529, doi:10.1029/2003JD003625, 2003.
- Mao, H., and Talbot, R.: Role of meteorological processes in two New England ozone episodes during summer 2001, *J. Geophys. Res.*, 109, D20305, doi:10.1029/2004JD004850, 2004.
- Mao, H., Talbot, R., Sigler, J., Sive, B., and Hegarty, J.: Seasonal and diurnal variations of Hg^o over New England, *Atmos. Chem. Phys.*, 8, 1403–1421, 2008, <http://www.atmos-chem-phys.net/8/1403/2008/>.
- Mason, R. P., and Sheu, G.-R.: Role of the ocean in the global mercury cycle, *Global Bio. Cycles*, 16(4), 1093, doi:10.1029/2001GB001440, 2002.
- McNeal, R. J., Jacob, D. J., Davis, D. D., and Liu, S. C.: NASA Global Tropospheric Experiment, *IGACTivities Newsletter*, No. 13, NOAA Pacific Marine Environmental Laboratory, Seattle, Washington. Available at: <http://www.igac.noaa.gov/newsletter/highlights/1998/gte.php>, 1998.
- Pacyna, E. G. and Pacyna, J. M.: Global emission of mercury from anthropogenic sources in 1995, *Water, Air, and Soil Pollution*, 137, 149–165, 2002.
- Radke, L. F., Friedli, H. R., and Heikes, B. G.: Atmospheric mercury over the NE Pacific during spring 2002: Gradients, residence time, upper troposphere lower stratosphere loss, and long-range transport, *J. Geophys. Res.*, 112, D19305, doi:10.1029/2005JD005828, 2007.
- Russo, R. S., Talbot, R. W., Dibb, J. E., Scheuer, E., Seid, G., Jordan, C. E., Fuelberg, H. E., Sachse, G. W., Avery, M. A., Vay, S. A., Blake, D. R., Blake, N. J., Atlas, E., Fried, A., Sandholm, S. T., Tan, D., Singh, H. B., Snow, J., and Heikes, B. G.: Chemical composition of Asian continental outflow over the western Pacific: Results from Transport and Chemical Evolution over the Pacific (TRACE-P), *J. Geophys. Res.*, 108(D20), 8804, doi:10.1029/2002JD003184, 2003.
- Schroeder, W. H. and Munthe, J.: Atmospheric mercury - an overview, *Atmos. Environ.*, 5, 809–822, 1998.
- Seigneur, C., Vijayaraghavan, K., Lohman, K., Karamchandani, P., and Scott, C.: Global source attribution for mercury deposition in the United States, *Environ. Sci. Technol.* 38, 555–569, 2004.
- Seigneur, C., Vijayaraghavan, K., and Lohman, K.: Atmospheric mercury chemistry: Sensitivity of global model simulations to chemical reactions, *J. Geophys. Res.*, 111, D22306, doi:10.1029/2005JD006780, 2006.
- Selin, N. E., Jacob, D. J., Park, R. J., Yantosca, R. M., Strode, S., Jaeglé, L., and Jaffe, D.: Chemical cycling and deposition of atmospheric mercury: Global constraints from observations, *J. Geophys. Res.*, 112, D02308, doi:10.1029/2006JD007450, 2007.
- Seo, K.-H. and Bowman, K. P.: A climatology of isentropic cross-tropopause exchange, *J. Geophys. Res.*, 106, 28 159–28 172, 2001.

- Sigler, J. M., and Lee, X.: Gaseous mercury in background forest soil in the northeastern United States, *J. Geophys. Res.*, 111, G02007, doi:10.1029/2005JG000106, 2006.
- Sigler, J. M., Lee, X., and Munger, W.: Emission and long-range transport of gaseous mercury from a large-scale Canadian boreal forest fire, *Environ. Sci. Technol.*, 37, 4343–4347, 2003.
- Slemr, F., Brunke, E.-G., Ebinghaus, R., Temme, C., Munthe, J., Wängberg, I., Schroeder, W., Steffen, A., and Berg, T.: World-wide trend of atmospheric mercury since 1977, *Geophys. Res. Lett.*, 30(10), 1516, doi:10.1029/2003GL016954, 2003.
- Slemr, F. and Scheel, H. E.: Trends in atmospheric mercury concentrations at the summit of the Wank Mountain, Southern Germany, *Atmos. Environ.*, 32(5), 845–853, 1998.
- Streets, D. G., Hao, J., Wu, Y., Jiang, J., Chan, M., Tian, H., and Feng, X.: Anthropogenic mercury emissions in China, *Atmos. Environ.*, 39, 7789–7806, 2005.
- Streets, D. G., Tsai, N. Y., Akimoto, H., and Oka, K.: Trends in emissions of acidifying species in Asia, 1985–1997, *Water, Air and Soil Pollution*, 130, 187–192, doi:10.1023/A:1013883628877, 2001.
- Talbot, R. W., Dibb, J. E., Lefer, B. L., Scheuer, E., Bradshaw, J. D., Sandholm, S. T., Smyth, S., Blake, D. R., Blake, N. J., Sachse, G. W., Collins, Jr., J. E., and Gregory, G. L.: Large scale distributions of tropospheric nitric, formic, and acetic acids over the western Pacific basin during wintertime, *J. Geophys. Res.*, 102, 28 303–28 313, 1997a.
- Talbot, R. W., et al.: Chemical characteristics of continental outflow from Asia to the troposphere over the western Pacific Ocean during February–March 1994: Results from PEM-West B, *J. Geophys. Res.*, 102, 28 255–28 274, 1997b.
- Talbot, R. W., Dibb, J. E., Scheuer, E. M., Kondo, Y., Koike, M., Singh, H. B., Salas, L. B., Fukui, Y., Ballentine, J. O., Meads, R. F., Miller, T. M., Hunton, D. E., Viggiano, A. A., Blake, D. R., Blake, N. J., Atlas, E., Flocke, F., Jacob, D. J., and Jaegle, L.: Reactive nitrogen budget during the NASA SONEX mission, *Geophys. Res. Lett.*, 26, 3057–3060, 1999.
- Talbot, R., Mao, H., Scheuer, E., Dibb, J., and Avery, M.: Total depletion of Hg⁰ in the upper troposphere–lower stratosphere, *Geophys. Res. Lett.*, 34, L23804, doi:10.1029/2007GL031366, 2007.
- Weiss-Penzias, P., Jaffe, D. A., Swartzendruber, P., Dennison, J. B., Chand, D., Hafner, W., and Prestbo, E.: Observations of Asian air pollution in the free troposphere at Mount Bachelor Observatory during the spring of 2004, *J. Geophys. Res.*, 111, D10304, doi:10.1029/2005JD006522, 2006.
- Weiss-Penzias, P., Jaffe, D., Swartzendruber, P., Hafner, W., Chand, D., and Prestbo, E.: Quantifying Asian and biomass burning sources of mercury using the Hg/CO ratio in pollution plumes observed at the Mount Bachelor observatory, *Atmos. Environ.*, 41, 4366–4379, 2007.