

UC Riverside

UC Riverside Previously Published Works

Title

Proactive demand-side participation: Centralized versus transactive demand-Supply coordination

Permalink

<https://escholarship.org/uc/item/1cf312gx>

Authors

Ostadijafari, Mohammad
Bedoya, Juan Carlos
Wang, Wei
[et al.](#)

Publication Date

2022-05-01

DOI

10.1016/j.epsr.2022.107789

Peer reviewed

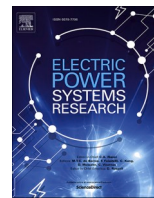

Proactive demand-side participation: Centralized versus transactive demand-Supply coordination[☆]

Mohammad Ostadijafari^a, Juan Carlos Bedoya^{1,b}, Wei Wang^c, Anamika Dubey^{*,a},
Chen-Ching Liu^{1,b}, Nanpeng Yu^c

^a School of Electrical Engineering and Computer Science, Washington State University, Pullman WA 99164, USA

^b Bradley Department of Electrical and Computer Engineering, Virginia Polytechnic Institute and State University, Blacksburg VA 24060, USA

^c Electrical and Computer Engineering, University of California, Riverside, Riverside CA 92521, USA

ARTICLE INFO

Keywords:

Proactive demand-side participation
Demand flexibility
Joint demand-supply coordination
Prosumers

ABSTRACT

The active participation of demand-side flexible resources in the wholesale market price formation and load dispatch process is crucial to encouraging demand-side participation. This calls for a joint supply-demand coordination mechanism to fully take advantage of the flexible resources in distribution systems, including distributed energy resources (DERs) and responsive loads (RLs). This paper aims at comparing and evaluating the centralized and transactive distribution-level market coordination mechanisms. We introduce the centralized and transactive demand-supply coordination mechanisms for the distribution-level market and elaborate on the structural difference between the two frameworks. Relevant metrics and test scenarios are proposed for a meaningful comparison. The key observations of the comparative study are generalized from the perspective of different entities in the market: fixed loads, flexible loads, DERs, and conventional generators. It is observed that while the centralized approach leads to socially optimum solutions, the transactive approach by allowing for competitive bidding at the distribution-level, results in clearing higher flexible demand, and thus higher electricity cost at the transmission-level. As a result, DERs and fixed loads receive a higher surplus in the centralized approach, while conventional generators and flexible loads are more profitable in the transactive approach.

1. Introduction

The electric power grid is rapidly transforming with the high penetrations of distributed energy resources (DERs) and with the introduction of the responsive loads (RLs) and active demand-side resources [1]. These changes, along with misaligned infrastructure, alternative energy sources, and high aggregate peak time usage, are resulting in uncertain demand and supply imbalances leading to low operational and economic efficiency. The value of demand response (DR) resources in improving the grid's operational efficiency has been widely recognized by the smart grid community [2]. Demand response mechanisms incentivize prosumers – consumers that can feed energy into the grid – to shift their load patterns [3].

Current industry practices for DR integration include various direct and indirect load control methods [4]. While direct control methods

send load dispatch signals to customers' flexible resources, indirect control methods provide incentives to influence the customers' load consumption indirectly. Despite all the efforts in harnessing DR, proactive customers' engagement remains low [5], and the efforts required for implementing the DR at the current level customer engagement (e.g., monitoring prices bid flexibility at the markets, etc.) exceed the possible gains. Along with the technological limitations in enabling automated responses, the lack of adequate incentives is another primary reason for low customer engagement in DR programs. Under the existing mechanisms, customers passively react to change in the electricity price and load curtailment signals from the utilities [6]. This motivates new mechanisms to enable a higher level of DR engagement via proactive customer engagement by allowing prosumers to bid their demand-side flexibility and participate in the wholesale market price-formation and resource dispatch process [7,8].

[☆] This work has been supported in part by the U.S. Department of Energy (DOE) under Award DE-0E00840.

* Corresponding author.

E-mail addresses: m.ostadijafari@wsu.edu (M. Ostadijafari), bedojuan@vt.edu (J.C. Bedoya), wwang031@ucr.edu (W. Wang), anamika.dubey@wsu.edu (A. Dubey), ccliu@vt.edu (C.-C. Liu), nyu@ece.ucr.edu (N. Yu).

¹ A majority of this work was done while authors were at Washington State University, Pullman, USA.

Along with proactive engagement, there is a need to determine appropriate pricing or other incentive signals to extract the desired grid benefits by coordinating heterogeneous proactive consumers. Many methods have been proposed to coordinate resources using different mechanisms such as power pooling, dynamic/real-time pricing, transactive energy control, and other game-theoretic models; see review articles [4,9,10]. While there is a vast literature on coordinating prosumers, none compare these mechanisms in terms of economic impacts, specifically concerning different market participants.

1.1. Literature review

In this section, first, we provide a brief review of the state-of-the-art methods that investigate only demand-side or supply-side coordination, followed by a discussion on the necessity of using the joint demand-supply mechanisms at the distribution-level. Next, we introduce the main joint demand-supply approaches and provide the literature review for them. Finally, we summarize the main research gaps in this domain and situate our work.

Demand or supply coordination: There are several methods to incentivize a higher level of DR participation that either target demand-side or supply-side coordination. Regarding the demand-side participation, most of the efforts have been focused on price-based DR programs that incentivize customers to change their energy consumption patterns in response to time-varying electricity prices or for other incentives such as critical peak rebates. For example, price-based DR for different types of household appliances considering customer satisfaction [11], hybrid price-based DR for residential microgrids [12], incentive-based DR for the residential customer to reduce network peaks [13], and coordination of electric vehicles' (EVs) power for grid frequency support [14] are introduced. On the supply-side coordination, several methods have been proposed to activate grid services from DERs while accounting for inherent generation uncertainty. For example, coordination of DERs plus energy storage devices [15], plug-in EVs [16], and coordinated scheduling DERs for optimizing buildings' energy [17] are discussed in the related literature.

Necessity for the joint demand-supply coordination: Although coordinating demand and supply separately can improve service reliability and reduce the peak load, it poses limitations on taking the full advantage of all flexible resources. The earlier efforts in this domain focused on coordinating different types of controllable loads and DERs for the individual buildings. For example, the co-scheduling algorithms for buildings' heating, ventilation, and air conditioning (HVAC) systems plus buildings' inflexible loads with a PV [18] or HVAC system plus EV with a battery energy storage system (BESS) [19] are proposed. However, the heterogeneity of DR resources and the fact that these resources can be utilized in the distribution systems as independent entities call for holistic approaches to coordinating them with the distribution system. To address these issues, joint supply-demand coordination mechanisms for the distribution system have been lately explored in the related literature. The frameworks for the joint demand-supply at the distribution-level can be categorized into centralized and transactive control methods. The centralized control approach advocates passing the bid-formation and pricing problem all the way to the individual customer nodes. On the other hand, the transactive control approach promotes bilateral transactions and peer-to-peer trading among distribution-level prosumers. Moving forward, any distribution-level demand-supply coordination approach needs to be integrated into the hierarchical wholesale market framework. Note that the distribution-level markets based on either ideology are currently non-existent in practice.

Centralized demand-supply coordination: The centralized approach usually involves a hierarchical interaction among different network entities, including individual customers, distribution system operators (DSOs), and transmission system operators (TSOs). Individual customers proactively participate in DR by generating demand bids upon

scheduling their flexible loads such as buildings' HVAC systems [6], BESSs [20], and EVs [21] to reduce the cost of electricity usage. DSO/aggregator acts as an aggregator of the individual customer demand bids and bid the aggregated demand-bid curve to the wholesale market [22,23]. For example, reference [22] proposes an approach to profitably bid the aggregated residential DR resources in a day-ahead wholesale market considering the uncertainty of prices, and reference [23] proposes a bidding approach to coordinate aggregated DR in the day-ahead energy and secondary reserve markets. Finally, after receiving all demand bids and supply offers, a central entity (i.e., representing the TSO) clears all power transactions by optimizing social welfare criteria [24]. It is worth mentioning that some research such as [1,25] have proposed methods for demand-supply coordination using distributed optimization approaches. However, these methods still solve the demand-supply dispatch problem for optimal social welfare, albeit in a distributed manner. Thus, the ideology is still centralized from market participants' perspective and hence not differentiated here from the centralized demand-supply coordination structure.

Transactive demand-supply coordination: In the transactive coordination approach, market participants aim at maximizing their individual interests by transacting energy with other participants. Essentially, transactive mechanisms allow for the negotiation and bilateral transactions among the market participants. Most of the recent efforts in this domain have been focused on transactive energy (TE); see review articles [26–28]. Based on the Gridwise Architecture Council (GWAC), TE is defined as “a set of economic and control mechanisms that allows the dynamic balance of supply and demand across the entire electrical infrastructure using value as a key operational parameter” [29]. TE enables prosumers to trade the energy or ancillary services without affecting the grid functionality [30]. Furthermore, it can solve the potential operational conflicts between the transmission and distribution systems regarding prosumer flexibility usage [31]. Different problems of TE, such as agent modeling [32], contract design, and computational efficiency [33], have been investigated in the literature. Along these lines, in our recent work [34], we proposed a fully decentralized TE framework to coordinate and settle transactions among prosumers. While the architecture for coordination at the distribution-level is decentralized, it needs to be integrated with the hierarchical wholesale market [35]. Thus, in the proposed transactive framework for demand-supply coordination, we assume the DSO/aggregator submits the aggregated demand bid/supply offer, that is uncleared at the distribution-level market, to the TSO. The TSO, same as in the centralized approach, gathers all generation and demand bids and clears the socially optimum transactions. Note that the main distinction between the centralized and transactive approach lies in the demand-supply coordination at the distribution-level.

Although the studies mentioned above are based on different mathematical methodologies, they can be broadly categorized as centralized and transactive control structures. The existing literature is limited in comparing these two structures. In [28], the authors briefly compare these approaches based on implementation-related issues such as reliability, installation difficulty, implementation costs and computation facilities cost. However, none of the existing literature in this domain presents a comparison of the two mechanisms, centralized and transactive, towards their effects on different market participants. The distribution-level agents are heterogeneous with different economic implications of participating in one vs. another framework. It is essential to study these approaches' economic profitability from different market participants' perspectives since even with successful engineering implementation, lack of economic incentives may result in low participation of proactive customers. Moving forward, as the distribution-level market becomes mainstream, an economic comparison is essential to provide insights on the profitability of each mechanism for different market entities. While we understand that the retail energy market may be situated somewhere between the purely centralized and purely transactive architectures, the comparison presented in this paper still

adds to the state-of-the-art by providing useful insights into how different market actors are affected when participating in markets aligned with these two extremes.

1.2. Contributions

This paper provides a comprehensive study of the centralized and transactive coordination mechanisms for joint supply-demand resources in the distribution-level market. First, we introduce the centralized and transactive demand-supply coordination approaches based on our prior work, see [6] and [34], respectively. Note that while the centralized approach targets optimal social welfare, the transactive coordination mechanism converges to competitive market solutions. To enable comparison, we modify and expand the previously proposed market structures, as needed. Specifically, the centralized approach in [6] is modified to include the high levels of DER penetrations in the market-clearing process. Also, the structure of the transactive approach in [34] is expanded to allow for a seamless integration of the proactive agents present at the distribution system with the hierarchical wholesale market. Next, we design a test system that includes transmission system, primary and secondary feeders of distribution system, and building loads with DERs. Thus, it is comprehensive enough to represent a general power system with different control hierarchies. The designed test system allows for performing comparison study of different coordination mechanisms under high-levels of DER and RL penetrations. For example, we represent the price-responsiveness of the load as a piece-wise linear function with demand decreasing with the increase in price, representing the inverse relationship between demand and price. These functional relations can model a diverse group of flexible loads within buildings. The DERs are modeled as power injections that can sell their generation at both distribution and transmission-level markets. Thus, any distribution system with diverse technologies for flexible loads and DERs can be modeled using the representations adopted in this paper. Next, we introduce several metrics to compare the performances of both coordination methods using comprehensive simulation studies. The introduced metrics are chosen in a way to provide the generalized results which are valid for any test system. Specifically, our conclusions are not dependent on the system-level parameters (e.g., lines parameters), loads, generations, and the network structure. To the best knowledge of the authors, this is the first paper to provide a comprehensive comparison of the different market-clearing mechanisms for their impacts on different market actors. Specifically, this paper aims at answering the following questions regarding different mechanisms for coordinating flexible resources at the distribution-level:

- How do the centralized and transactive demand-supply coordination mechanisms at the distribution-level affect the wholesale energy market-clearing and resource dispatch process?
- How does the economic impact of the two coordination mechanisms differ for different distribution-level market participants (e.g., flexible loads, fixed loads, DERs)?
- How are the economic impacts of the centralized and transactive approaches affected by different real-world scenarios such as increasing DERs' size, flexible loads' size, and demand-side elasticity?

1.3. Structure of the paper

The rest of the paper is organized as follows: Section 2 describes the centralized and transactive control structures for the distribution-level markets and their integration within the hierarchical wholesale market. Section 3 illustrates the framework used for the comparison including the test system and the proposed metrics. Section 4 details the results with the help of different case studies. Section 5 summarizes the main observations followed by concluding remarks in Section 6.

2. Structure of the markets

The hierarchical framework for both, centralized and transactive, market coordination methods is shown in Fig. 1. The proposed framework integrates demand response and network optimization through the interactions of three key decision making entities: building energy scheduling controller, DSO/aggregator, and TSO [6]. Specifically, at the customer-level, we develop algorithms to enable the proactive consumers (e.g., smart buildings) to participate in the power system resource dispatch and price formation process. At the distribution system level, both centralized and transactive approaches are explored for coordinating the operations of large-scale flexible loads and DERs. Finally, at the transmission-level, the TSO clears the aggregated demand and supply offers. Each of these steps are detailed in this section.

2.1. Building level model: Demand-bid curves

In the proposed framework, at the customer-level of both market coordination methods, buildings participate in the market by curtailing/shifting their flexible load demands. To do so, buildings should be equipped with intelligent controllers with an efficient algorithm to manage their flexible loads such as HVAC systems and BESSs. The controller minimizes the building's operating energy cost by scheduling the energy consumption of various subsystems and controlling the usage of heterogeneous energy supply sources while satisfying the requirements from building occupants. Each controller constructs the price-demand bid curve that captures the demand-side flexibility of the building subject to variable electricity prices. In this section, we introduce the model for the building's flexible loads, the MPC-based energy management algorithm to co-schedule HVAC and BESS, and the algorithm to create demand bid curves.

2.1.1. Modeling Buildings' flexible loads

This section describes the models for the building's thermal load, HVAC power consumption, and local BESS used in this paper.

Building Thermal Load Model: Thermal model of a building is usually obtained by modeling the building as a first-order RC network [36]. Buildings are modeled with n thermal nodes; m of them represent rooms. Then, using the equations used in [36] to describe rooms' and walls' temperatures, and after linearization, the following state-space equations representing the building thermal model are obtained:

$$\mathbf{x}^{t+1} = \mathbf{A}\mathbf{x}^t + \mathbf{B}\mathbf{u}^t + \mathbf{E}\mathbf{d}^t, \quad \mathbf{y}^t = \mathbf{C}\mathbf{x}^t \quad (1)$$

where, $\mathbf{d}^t \in \mathbb{R}^l$ is the vector of environmental disturbance (with l number of the disturbance elements such as external temperature, solar radiation and internal gains, etc.); $\mathbf{A} \in \mathbb{R}^{n \times n}$, $\mathbf{B} \in \mathbb{R}^{n \times m}$, $\mathbf{C} \in \mathbb{R}^{m \times n}$ and $\mathbf{E} \in \mathbb{R}^{n \times l}$ are matrices obtained from a building thermal model representing time-invariant building parameters (see [37] for more details); For the

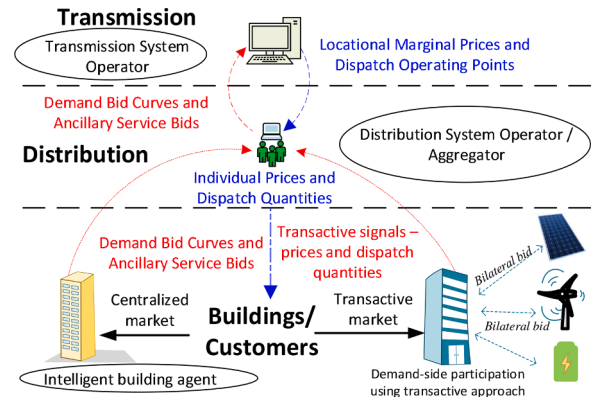

Fig. 1. Market development within hierarchical control Framework.

Given: $\underline{\lambda}$ and $\bar{\lambda}$

- 1: Divide $[\underline{\lambda} - \bar{\lambda}]$ to L steps and define $\lambda_{inc} = (\bar{\lambda} - \underline{\lambda})/(L - 1)$
- 2: **for** $i = 1 : L$ **do**
- 3: $\lambda^i = \underline{\lambda} + \lambda_{inc}(i - 1)$
- 4: Do MPC-based energy scheduling algorithm and obtain P_T^i .
- 5: Store P_T^i and λ^i as the abscissa and ordinate of a price-demand pair. Connect isolated price-demand pairs sequentially.
- 6: **end for**

Algorithm 1. Demand bid curve generation

sampling time t , $\mathbf{x}^t \in \mathbb{R}^n$ is the state vector representing the temperature of the network nodes; $\mathbf{u}^t \in \mathbb{R}^m$ is the vector of input variables whose elements (u_i^t) are air mass flow into each thermal zone i ; \mathbf{y}^t is the output vector of the system (rooms temperature).

HVAC Power Consumption Model: The HVAC cooling system power consumption is due to the fan and chiller of the HVAC system, and it is calculated as follows:

$$P_H^t = c_1(\mathbf{u}^t)^3 + c_2(\mathbf{u}^t)^2 + c_3\mathbf{u}^t + c_4 \quad (2)$$

In (2), P_H^t the HVAC cooling system power consumption. Constants c_1 , c_2 , c_3 and c_4 are obtained based on the results of [6].

Local BESS Model: The dynamics for the BESS can be formulated based on the model presented in [18,38] as follows:

$$SOC^{t+1} = (1 - \nu)SOC^t + \rho \frac{P_{c,d}^t}{Q_{bat}} \tau \quad (3)$$

$$E^- \leq SOC^{t+1} \leq E^+ \quad (4)$$

$$-d_r \leq P_{c,d}^t \leq c_r \quad (5)$$

Specifically, the BESS state of charge is updated based on (3) where SOC^t and $P_{c,d}^t$ are the state of charge and charging/discharging power of BESS at sampling time k , respectively; ν , ρ , Q_{bat} and τ are the energy decay rate, round-trip efficiency, capacities of the BESSs and length of the time-step, respectively. Constraints (4) and (5) bound the BESS SOC and charging/discharging limits, respectively, where, E^+ and E^- are the upper and limits of energy; d_r is the maximum discharge rate and c_r is the maximum charge rate. In this formulation, $P_{c,d}^t > 0$ and $P_{c,d}^t < 0$ denote the charging and discharging status of the BESS, respectively.

Discussion on generalization to other heating/cooling loads and time-shiftable loads: It should be noted that since the HVAC system is solely responsible for 40% of the buildings energy consumption [39], we consider it as a representative of the buildings heating and cooling loads in this work. However, the demand flexibility of the buildings can be provided by other heating and cooling systems such as combined heat and power (CHP), auxiliary boilers (AB), absorption chiller, and heat pumps (HPs), and so on. Although each of these loads has its own dynamics, they can be included in the building-level optimization problem, as investigated in related literature [40]. A similar flexible demand-bid curve can be generated at the building-level by leveraging the flexibility of heating and cooling loads other than the HVAC system used in this paper. Likewise, other time-shiftable loads can be integrated for the DR with additional constraints regarding their scheduling time [41]. Thus, other flexible loads can be easily integrated with the proposed approach to generate the price-sensitive demand curve.

2.1.2. MPC-Based Building energy scheduling algorithm

It is assumed that each building is equipped with an intelligent controller. The objective of this controller is to optimally co-schedule the HVAC system with the BESS of the building such that it can optimize the net cost of transacted energy for the specified prediction window while ensuring that the desired level of comfort is met for its occupants [42]. The problem is formulated as an MPC-based algorithm with the objective of minimizing the building's total electricity usage for given energy

prices. The problem formulation is detailed below:

$$\underset{\mathbf{u}^t}{\text{Min}} \sum_{k=t}^{t+W-1} \lambda^k \cdot P_T^k \quad (6)$$

Subject to:

$$P_T^t = P_H^t + P_{c,d}^t, \quad P_T^t \geq 0 \quad (7)$$

$$\underline{\mathbf{u}} \leq \mathbf{u}^t \leq \bar{\mathbf{u}} \quad (8)$$

$$\underline{\mathbf{y}}^t \leq \mathbf{y}^t \leq \bar{\mathbf{y}}^t \quad (9)$$

constraints (1)-(5)

The objective function in (6) aims at minimizing the electricity usage cost, where λ^t and P_T^t are the price of energy and total power consumption of the building at the time t , respectively. Equation (7) states that the total power consumption of the building is due to consumed power by its flexible load (the HVAC system and the BESS charging/discharging). In constraint (8), $\underline{\mathbf{u}}$ and $\bar{\mathbf{u}}$ are lower and upper limits of the air mass flow, respectively; in constraint (9), $\underline{\mathbf{y}}^t$ and $\bar{\mathbf{y}}^t$ are lower and upper limits of room temperature at time t , respectively. Note that the thermal building model and the BESS dynamics are included in the formulation as constraints (1)-(5).

At each sampling time t , solving the minimization problem (6) with its constraints results in the optimal mass air flow rate trajectory $[\mathbf{u}^t, \mathbf{u}^{t+1}, \dots, \mathbf{u}^{t+W-1}]$ and battery charging/discharging trajectory $[P_{c,d}^t, P_{c,d}^{t+1}, \dots, P_{c,d}^{t+W-1}]$ for a prediction window from t to $t + W - 1$. The algorithm requires one-day ahead prediction information regarding the building's occupancy pattern [43], environmental disturbances, and energy prices. After obtaining the optimal mass air flow rate and charging/discharging trajectories, only the first entry of these trajectories, \mathbf{u}^t and $P_{c,d}^t$, is implemented to control the HVAC system and BESS operation. Next, the sampling time and the prediction window is advanced by one time-interval and the minimization problem is solved again from $t + 1$ to $t + W$. The same process continues for the next time steps, and repeatedly a constrained optimization problem is solved to choose the control actions using predictions of future costs, disturbances, and constraints.

Discussion on different types of MPC-based algorithms for the HVAC system: Several MPC-based algorithms for energy management of buildings' HVAC systems, based on different building thermal load models are proposed in the literature. Some of these methods consider the effects of model uncertainty and environmental disturbances on building thermal dynamics and HVAC system control. Building thermal model dynamic is nonlinear and usually is linearized based on Jacobian approach around an equilibrium point, i.e., the set-point temperature [37]. However, this approach is not valid when the room temperature varies significantly, which is when the building is overheated or over-cooled to gain economic benefits [39]. Therefore, [44] uses main nonlinear building thermal load model to minimize the cost of transacted energy while meeting the HVAC system's requirements and satisfying the comfort level of the occupants. Due to computational complexity of the nonlinear building thermal load model, [42] proposes a feedback linearization technique that can mimic the behavior of the

nonlinear thermal building model. Regarding the model uncertainty and environmental disturbances in the building thermal load model, many articles consider a perfect prediction of disturbances and ignore the model uncertainty [6,39]. However, this approximation may lead to violating the comfort level of the occupants. Thus, robust approaches based on the min-max MPC [45] and tube-based MPC [36] are proposed to solve this issue. Note that the design of an efficient MPC based controller is a complicated and separate problem. Since the focus of this paper is to provide a comprehensive study of coordination mechanisms for joint supply-demand resources in the distribution-level market, rather than studying the efficiency of the MPC controller for buildings energy management, a simplified linearized model (based on Jacobian-linearization) assuming a perfect prediction of disturbances, is used in this paper.

2.1.3. Price-responsive demand-Bid curve generation

The price-responsive demand bid curve is a set of pairs of electricity demand and price forecasts that show the willingness of individual buildings to purchase a certain volume of electricity based on the corresponding price at each sampling time [6]. Demand bid curve generation is based on [6] and summarized in Algorithm 1. Specifically, the range of the forecasting energy prices $[\underline{\lambda} - \bar{\lambda}]$ is divided into L segments, preferably with equal incremental length as: $\underline{\lambda}, \underline{\lambda} + \lambda_{inc}, \underline{\lambda} + 2\lambda_{inc}, \dots, \bar{\lambda}$ which makes $L + 1$ of possible prices (line 1). During each iteration, a possible price for interval t is set for λ^t while keeping price forecasts for the rest of the time intervals fixed (lines 3). For each price point, the MPC-based scheduling algorithm detailed in Section 2.1.2 is performed to find the total power demand of the building for the current sampling time (line 4). The energy price λ^t , and the corresponding power demand (P_T^d), constitutes the new point of the demand bid curve (line 5). The obtained price-demand pairs form the demand bid curve for the current time interval.

2.2. Distribution-level models: Demand-Supply coordination

The primary difference between proposed centralized and transactive demand-supply coordination methods is the mechanism used for energy transactions within the distribution system. In the centralized approach, the building-level demand-bid curves are sent to the DSO. The DSO aggregates the building-level demand-bid curves to generate an aggregated economic demand-bid curve. The TSO clears the supply offers (from generators) and aggregated demand bids (from distribution customers) by solving a security constrained economic dispatch (SCED) problem. On the other hand, in the transactive demand-supply coordination approach, after the price-demand bid curve is obtained, transactions are cleared through a mechanism of simultaneous auctions. In this coordination approach, the DSO supervises participants intended transactions and proposes new transactions that minimally affect participants interests when operational security is threatened. Furthermore, after all bilateral transactions are cleared at the distribution-level, any flexible and fixed demand that cannot be provided by distribution-level bidders is aggregated by the DSO and sent to the TSO. The TSO runs SCED problem, same as the centralized market, and clears DSOs demand-bids. After clearing the market in the transmission-level and for both approaches, the DSO is responsible for disaggregating the distribution system dispatch operating point into individual customers.

Note that in this work, we assume that the distribution network owner (DNO) and DSO are a single entity² responsible for retail aggregation. This follows from the US's current retail aggregation situation, where, in most US states, retail aggregators are not open to competition [46]. While some jurisdictions in US and European markets allow

competitive DER aggregators, the DNO often competes with the retail aggregators to provide aggregation services. Also, a combined DNO/SO entity is responsible for aggregating customers when they do not choose the competitive aggregators or when an aggregator can no longer serve them. The competition among independent aggregators is a separate problem and is not discussed in this paper. In the proposed structures in this paper, the DNO/SO or simply DSO is assumed to be responsible for the distribution system's load aggregation. Furthermore, it is assumed that the DNO/SO can only purchase electricity from the wholesale market and cannot sell the unused electricity back to the market.

2.2.1. Centralized coordination

Under the hierarchical framework [6], the individual demand bid curves of buildings along with DERs and fixed loads are first aggregated at the distribution system level. The aggregated demand-bid curve is then submitted to the electricity wholesale market for economic dispatch at the transmission system level. In order to obtain the aggregated demand bid curve, a three-phase optimal power flow problem (OPF) is solved for the distribution system at the primary feeder level for different nodal prices [47]. The three-phase OPF for the distribution system is formulated as the following:

$$\max_d \sum_{i=1}^{N_D} \sum_{\varphi=1}^3 (C_{i,\varphi}^d - C_{i,\varphi}^g) - \lambda_0^g \sum_{\varphi=1}^3 P_{0,\varphi}^g \quad (10)$$

Subject to:

$$C_{i,\varphi}^d = \sum_{j=1}^{K_{i,\varphi}^d} \lambda_{i,\varphi}^d(j) P_{i,\varphi}^d(j), \forall i = 1, \dots, N, \varphi = 1, 2, 3 \quad (11)$$

$$C_{i,\varphi}^g = \sum_{j=1}^{K_{i,\varphi}^g} \lambda_{i,\varphi}^g(j) P_{i,\varphi}^g(j), \forall i = 1, \dots, N, \varphi = 1, 2, 3 \quad (12)$$

$$\mathbf{PB}(\mathbf{P}^d, \mathbf{P}^g, \mathbf{P}^l) = \mathbf{0} \quad (13)$$

$$\mathbf{PF}(\mathbf{P}^d, \mathbf{P}^g, \mathbf{P}^l) \leq \overline{\mathbf{PF}} \quad (14)$$

There are total $N_D + 1$ nodes in the distribution network, where the primary feeder or substation is denoted as node 0. The objective of the optimal power flow problem is to maximize the total social welfare (10). At the substation, the prices of three phases are the same as λ_0^g . $C_{i,\varphi}^d$, $C_{i,\varphi}^g$ are the customer utility function and generation cost function at node i with phase φ , which are defined in (11) and (12) respectively. $K_{i,\varphi}^d$ ($K_{i,\varphi}^g$) is the number of segments of demand bid (supplier offer) curve of buildings (distributed generations) at node i with phase φ . $\lambda_{i,\varphi}^d(j)$ ($\lambda_{i,\varphi}^g(j)$) is the price j -th segment of the demand bid (supply offer) curve. $P_{i,\varphi}^d(j)$ ($P_{i,\varphi}^g(j)$) is the corresponding demand (generation) quantity of the j -th segment. Equation (13) is the power balancing constraint. The line flow limit constraint is represented as in (14). \mathbf{P}^d , \mathbf{P}^g , \mathbf{P}^l are the vectors of building demands, distributed generations and fixed loads. \mathbf{PF} is the vector of line flow limits. To construct the aggregated demand bid curve, the optimal power flow problems are solved with nodal prices at the substation across the predicted price range $[\underline{\lambda}_0^g, \bar{\lambda}_0^g]$ with interval λ_{inc} as in Algorithm 2. The three-phase ACOPF problem formulated in (10)-(14) is nonlinear and nonconvex. We adopt the chordal conversion-based convex iteration algorithm [47] to convert it into an iterative convex programming problem, which can be efficiently solved by commercial semidefinite programming solvers.

2.2.2. Transactive demand-Supply coordination

We detail the transactive approach for the joint supply-demand coordination at the distribution-level, first introduced in our prior work, see [34]. Here, we define demand-side resources as asker agents and

² In some instances, the term "DNO/SO" is used to emphasize that DSO and DNO are considered a single entity.

Given: $\underline{\lambda}_0^g$ and $\bar{\lambda}_0^g$

- 1: Divide the range $[\underline{\lambda}_0^g - \bar{\lambda}_0^g]$ to L steps and define the price increment as: $\lambda_{inc} = 1/L(\bar{\lambda}_0^g - \underline{\lambda}_0^g)$
- 2: **for** $i = 1 : L$ **do**
- 3: **if** $i = 1$ **then**
- 4: $\lambda_0^g = \underline{\lambda}_0^g$
- 5: **else if** $i = L$ **then**
- 6: $\lambda_0^g = \bar{\lambda}_0^g$
- 7: **else**
- 8: $\lambda_0^g = \underline{\lambda}_0^g + \lambda_{inc}$
- 9: **end if**
- 10: Solve the optimal power flow problem (10) to (14)
- 11: Store $P_0^g = \sum_{\psi=1}^3 P_{0,\psi}^g$ and λ as the abscissa and ordinate of a price-demand pair.
- 12: **end for**

Algorithm 2. Aggregated bid curve generation

supply-side resources as the bidder agents³ In the proposed transactive approach, the asker and the bidder agents complete the power transactions at the distribution-level using a simultaneous auction mechanism. The proposed approach leads to bilateral power transactions that are agreed on in a decentralized manner by the market participants at the distribution-level. Proactive loads and DERs transact power according to their preferences using Markovitz portfolio optimization and simultaneous auction mechanisms. The transactions are reported to the DSO, which monitors for system's operational constraints under the expected trading conditions. If the operational constraints are violated, the DSO proposes a new set of bilateral transactions to the market participants, such that the new trading conditions minimally differ from those reported earlier. The market participants have the option to accept or decline the new transactions proposed by the DSO; however, we anticipate that since the new transactions are close to those previously proposed, a large number of market participants will accept the revised set of transactions.

The steps to obtain the bilateral transactions by the market participants are detailed next:

1) *Bidding Portfolio Optimization:* In the bidding portfolio problem each supplier (bidder agent) selects a set of L askers (neighboring nodes) to transact energy. The percentage of energy to be bilaterally transacted with each asker agent (w_i for $i = 1, \dots, L$) is determined by solving a Markowitz portfolio optimization (MPO) problem. The resulting MPO is a convex optimization problem that minimizes the investment portfolio volatility (15)-(18) for a minimum rate of return margin (RoRM).

$$\text{Min}_{w_{g,l}} w_{g,l}^T \Sigma_g w_{g,l} \quad (15)$$

Subject to:

$$\sum_{l=1}^L \bar{r}_{g,l} w_{g,l} \geq \text{RoRM}_g \quad (16)$$

$$\sum_{l=1}^L w_{g,l} = 1 \quad (17)$$

$$0 \leq w_{g,l} \leq 1 \quad \forall l = 1, \dots, L \quad (18)$$

The objective function in (15) represents portfolio variance; $r_{g,l}$ represents the rate of return that bidder g would obtain by selling energy to asker l ; $\bar{r}_{g,l}$ is the expected value of $r_{g,l}$; Σ corresponds to the covariance matrix of the portfolio and is calculated using (19).

³ In this paper, "askers" and "bidders" are used interchangeably for buildings and DERs, respectively.

$$\Sigma = \begin{bmatrix} E[(r_{g,1} - \bar{r}_{g,1})^2] & \dots & E[(r_{g,1} - \bar{r}_{g,1})(r_{g,L} - \bar{r}_{g,L})] \\ \vdots & \ddots & \vdots \\ E[(r_{g,L} - \bar{r}_{g,L})(r_{g,1} - \bar{r}_{g,1})] & \dots & E[(r_{g,L} - \bar{r}_{g,L})^2] \end{bmatrix} \quad (19)$$

The characterization of the behavior of the random variable, $r_{g,l}$, is required to calculate the expected values and correlation entries of Σ . First, (20)-(21) are used to normalize the L price-demand curves' generation capacity (C_g) and bilateral bid price ($P_{g,l}$). The N sample points are obtained upon sampling the normalized demand-bid curves, i.e., $q_{g,l,n}$, $p_{g,l,n}$, where $n = 1, \dots, N$ (see Fig. 2).

$$q_{g,l,n} = \frac{Q_{l,n}}{C_g}, \quad \forall n = 1, \dots, N \text{ and } l = 1, \dots, L \quad (20)$$

$$p_{g,l,n} = \frac{P_{l,n}}{P_{g,l}}, \quad \forall n = 1, \dots, N \text{ and } l = 1, \dots, L \quad (21)$$

where, $Q_{l,n}$ and $P_{l,n}$ represent abscissa and ordinate of demand-bid curve for the asker agent l .

Next, $r_{g,l,n}$ is calculated as in (22), the mean value $\bar{r}_{g,l}$ is calculated in (23), and joint moments or entries (i,j) of covariance matrix are calculated in (24).

$$r_{g,l,n} = p_{g,l,n} - 1 \quad (22)$$

$$\bar{r}_{g,l} = \frac{1}{N} \sum_{n=1}^N r_{g,l,n} \quad (23)$$

$$\Sigma_{|i||j|} = \frac{1}{N} \sum_{n=1}^N (r_{g,i,n} - \bar{r}_{g,i}) - (r_{g,j,n} - \bar{r}_{g,j}) \quad (24)$$

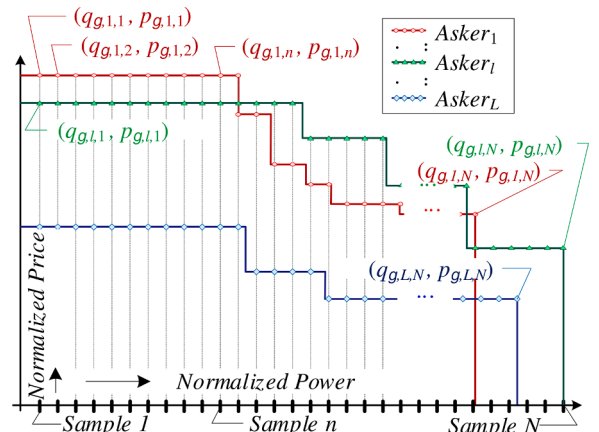

Fig. 2. Sampling of the scaled price-power curves.

Finally, upon solving the quadratic optimization problem, the bilateral generation bid offered by bidder g to the asker l is calculated using (25).

$$G_{g,l} = W_{g,l} \cdot C_g \quad (25)$$

2) *Simultaneous auction transactions clearing*: After the bidders have sent their bilateral bids to the asker agents, asker agents simultaneously clear the power transactions by means of a second price sealed bid auction (SPSBA). Second-price auction is an application of the Vickrey mechanisms [48]. Each asker executes the following procedures:

- Asker agent sorts the received bids in ascending order of the price to form a non-decreasing aggregated bid price curve.
- The crossing point between demand and aggregated bid curve is determined. This point defines the power transaction equilibrium, i. e. the amount of power to be transacted correspond to all the bids of the aggregate bid price curve located at the left side of the equilibrium point.
- Clearing price for each of this transactions, is determined based on a second price rule. For instance, in the transaction between asker l and bidder g , asker l runs the same auction but without considering the contributions of bidder g . The price associated to the equilibrium point of this second auction determined the transaction price between asker l and bidder g .

Finally, after askers' and bidders' transactions have been cleared, remaining power surplus, fixed loads, and not supplied flexible demand is scaled in the transmission-level to be considered in SCED problem.

2.3. Transmission-level model: Integration with wholesale electricity market

At the transmission-level, the aggregated demand bids at the substation-level, and the supplier offers are submitted to the wholesale electricity market. The TSO clears the demand and generation quantities and determines the locational marginal prices by solving SCED problem. Note that the TSO is also responsible for managing the frequency regulation services via traditional ancillary service markets. In this paper, we assume that the ancillary services at the bulk grid level are managed hierarchically via TSO by coordinating different DSOs that are responsible for aggregating distribution-level assets, and other ancillary service providers that are directly controllable by the TSO [23]. As per the distribution-level ancillary services, such as reactive power and voltage control, they are managed separately by the DSOs by optimally scheduling the reactive power resources [34].

At the transmission-level, typically a linearized single-phase problem is formulated as follows [6]:

$$\max_d \sum_{i=1}^{N_T} (C_i^d - C_i^g) \quad (26)$$

Subject to:

$$C_i^d = \sum_{j=1}^{K_i^d} \lambda_i^d(j) P_i^d(j), \forall i = 1, 2, \dots, N \quad (27)$$

$$C_i^g = \sum_{j=1}^{K_i^g} \lambda_i^g(j) P_i^g(j), \forall i = 1, 2, \dots, N \quad (28)$$

$$P_i^g = \sum_{j=1}^{K_i^g} P_i^g(j), P_i^d = \sum_{j=1}^{K_i^d} P_i^d(j), \forall i = 1, \dots, N \quad (29)$$

$$P_i^{inj} = P_i^g - P_i^d, \forall i = 1, \dots, N \quad (30)$$

$$\left| \sum_{i=1}^N GSF_i^b P_i^{inj} \right| \leq \overline{PF}^b, \forall b \in \mathbf{B} \quad (31)$$

$$\underline{P}_i^g \leq P_i^g \leq \overline{P}_i^g, \forall i = 1, \dots, N \quad (32)$$

where N_T is the total number of nodes in a transmission system. $C_{i,\varphi}^d, C_{i,\varphi}^g$ are the single-phase utility function and generation cost function at node i , which are defined in (27) and (28) respectively. $K_i^d (K_i^g)$ is the number of segments of single-phase demand bid (supplier offer) curve at node i . $\lambda_i^d(j) (\lambda_i^g(j))$ is the price of the j -th segment of the demand bid (supply offer) curve. $P_i^d(j) (P_i^g(j))$ is the corresponding demand (generation) quantity of the j -th segment. Equation (30) defines the power injection at node $i (P_i^{inj})$ equals the power generation at node $i (P_i^g)$ minus the power demand at node $i (P_i^d)$. The line flow constraints are enforced as in (31), where the line flow is calculated with the generation shift factor of branch b with node $i (GSF_i^b)$. \overline{PF}^b is line flow limit of branch b . \mathbf{B} is the set of branches. The generation capacity limit for node i is as shown in (32), where \underline{P}_i^g and \overline{P}_i^g are the corresponding lower and upper limits.

2.4. Disaggregation

After the electricity wholesale market clears, the locational marginal price λ_0^g at a substation level is settled. The optimal power flow problem in a distribution system (10)-(14) is solved again to determine the dispatch points of individual buildings and distributed generations.

3. Market comparison framework

We briefly compare the structures of the previously described market coordination methods, and introduce the test system and metrics used for performing the comparison studies. We also detail the different assumptions made for a consistent and valid comparison of the two market coordination mechanisms.

3.1. Structural differences

We assume that the required hardware and software infrastructure and essential protocols are available for implementing both market coordination methods. Specifically, for both market coordination approaches, buildings are assumed to be equipped with smart controllers that are programmed for proactive demand-side participation. The controller minimizes the building's operating energy cost by scheduling the energy consumption of various sub-metered loads and controlling the usage of heterogeneous energy supply sources while satisfying the requirements of building occupants. Similarly, we assume that the necessary communication infrastructure is available to continuously exchange information among market actors in both market coordination methods [49]. The centralized approach requires two-way communication between each building/DER and the DSO, and the transactive approach requires peer-to-peer communication between distribution-level market participants with the DSO. Furthermore, it is assumed that the appropriate protocols are in place to manage the contracts among market participants. This is especially crucial for the transactive approach as the market's economic reliability is highly dependent on the money exchanged after the energy transactions [50]. Finally, note that the calculation of these infrastructure costs for implementing the markets is a different problem, and it is out of the scope of this work.

The primary difference between proposed centralized and transactive demand-supply coordination methods is the mechanism used for energy transactions within the distribution system. In the centralized approach, DSO aggregates the building-level demand bid curves bids to the wholesale market. The aggregated demand bid curve represents the

overall willingness-to-pay for all distribution-level customers. Next, at the transmission-level wholesale market, the aggregated demand-bid offers (from DSO) and the supply offers (from generators) are cleared by solving SCED problem. The dispatched generation and demand are sent to generators and DSOs in the system, respectively. Then, the DSO disaggregates the dispatched demand and sends the dispatched demand to each building. The energy-scheduling controller coordinates various flexible loads in the building to ensure that the overall building electricity consumption equals the dispatched amount of electricity as indicated by the DSO.

In the transactive approach, after the price-demand bid curve is obtained for each building, transactions are cleared through a mechanism of simultaneous auctions. The transactive framework consists of a TE environment where the responsive loads (askers) release their electricity requirements through the price-demand bid curves. Next, a set of potential providers termed “bidders” such as DERs, energy storage, or other responsive loads willing to reduce consumption, bid to supply askers requirements. Then, askers individually clear the supply bids using a second-price sealed-bid auction mechanism. Remaining power surplus, fixed loads, and not supplied flexible demand is scaled in the transmission-level to be considered in the SCED problem. Finally, after clearing the market, the disaggregation process is performed, similar to the centralized approach.

3.2. Description of the test system

The test system comprised of integrated transmission, distribution and customer-level models used in this work is shown in Fig. 3. We employ the IEEE 9-bus test system as the transmission system model where bus-5, bus-6, and bus-8 are connected to their sub-transmission systems. The quadratic cost functions, $C(G_i) = aP_{G_i}^2 + bP_{G_i} + c$, are used for conventional generators where a , b and c are corresponding parameters for the generator G_i , and they are defined in Table 1.

Each sub-transmission system of the transmission nodes is connected to five 230kV/115-kV, 20 MVA transformers; where the secondary each of these transformers is connected to four 115kV/416-V, 5 MVA distribution substation transformers. Each distribution substation transformer is supplying a distribution feeder that is modeled using IEEE 13-bus test system. The secondary feeder model is added to each of the primary feeder load nodes (nodes 633, 634, 611 and 684) of the 13-bus test system. Each secondary feeder connected to the primary load bus supplies 24 or 32 buildings in each phase (depending on the phase of the system) as indicated in Table 2. In addition, we assume each distribution feeder to be equipped with 50% PV penetration equipped at the building level; this leads to 116 PVs per distribution feeder. This simulation set up leads to a total of 232 buildings (asker agents) with 116 DERs (bidder agents) for each distribution feeder. Since a total of 20 IEEE 13-bus feeders are connected to each transmission load bus, a total of 232×20 buildings and a total of 116×20 DERs are connected to each

Table 1
Parameters of the cost functions for the conventional generators .

Generator	Parameter		
	a	b	c
G_1	0.015	0.016	0.020
G_2	50	60	70
G_3	1600	1200	8500

Table 2
Number of the buildings in each phase of the secondary feeder system .

Nodes	Number of buildings		
	Ph-1	Ph-2	Ph-3
633	32	32	32
634	24	24	24
652	32	0	0
611	0	0	32

transmission load bus (see Table 3). Thus, we simulate a massive test system for market simulations.

Other than the illustrated modifications in the following sections, the rest of the simulation parameters (line parameters, fixed loads and etc.) for both the transmission and the distribution test systems are same as those in the standard IEEE-9 bus [51] and IEEE 13-bus test systems [52].

3.3. Metrics for comparison

3.3.1. Power dispatch in the transmission-level (Metric-1)

In the centralized approach, demand bid curves of individual asker agents, fixed loads, and bidder agents generation capacities (as negative loads) are aggregated for downstream of each transmission node to be cleared at the transmission-level. Similarly, in the transactive approach, after the distribution-level market is cleared, any uncleared flexible loads and DERs generation along with the fixed loads downstream of each transmission node are aggregated to be cleared at the transmission-level. Specifically, the TSO solves SCED problem to obtain the volumes of power allocated to each of the transmission nodes. We refer to these volumes of power dispatch in the transmission-level as Metric-1 to compare the volumes of electricity cleared in the two market coordination methods.

Table 3
Number of different devices connected to each transmission node .

sub-transmission transformer	primary feeder	secondary feeder	Building	DER
5	20	160	4640	2320

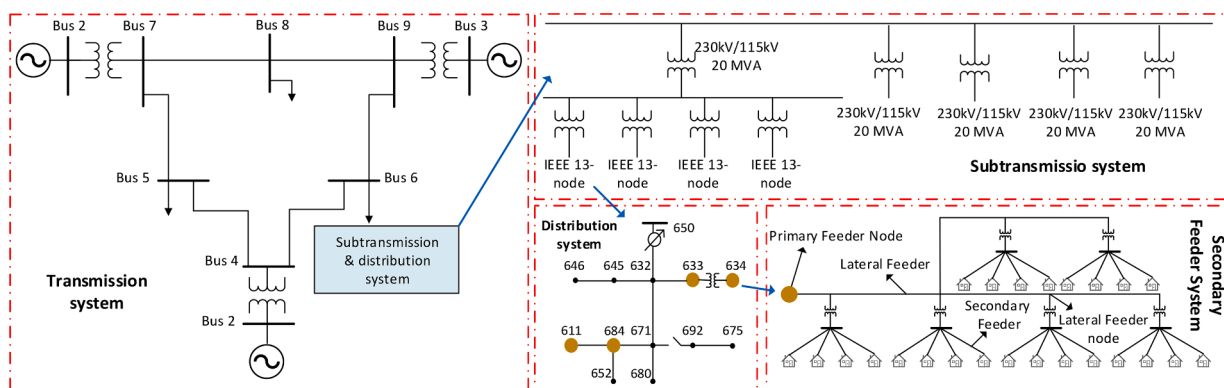

Fig. 3. Test system.

3.3.2. Market-Clearing price (Metric-2)

Along with the volumes of power cleared, solving the SCED problem in the transmission-level results in locational marginal price (LMP) of the electricity at each transmission bus. In the centralized market coordination scheme, this is the price that all the distribution customers supplied by the given transmission node pay for purchasing electricity; the quantity is determined by the price-demand bid curve for the individual customers. However, in the transactive coordination mechanism, different participating entities may end up paying different prices (from the nodal LMP) for electricity. The transactive approach is comprised of two levels. Initially, the asker agents are cleared at the distribution-level market via the method of simultaneous auctions at the bid prices provided by the bidder agents (see Section 2.2). However, similar to the centralized approach, any uncleared flexible load demand (uncleared at the distribution-level market) and fixed loads are cleared at the transmission-level at price equal to the nodal LMP obtained by solving SCED problem. We refer to the former and latter clearing prices for the transactive approach as “distribution-level” and “transmission-level” clearing prices. Thus, clearing price (Metric-2) is defined for the centralized market coordination, and individually for the distribution-level and transmission-level of the transactive approach.

3.3.3. Average cleared demand for the buildings (Metric-3)

In the centralized approach, the power demand, including buildings’ flexible demands, is determined (cleared) by solving SCED problem at the transmission-level. Note that this includes power generation capacities of bidding agents which are considered as negative loads in aggregated demand bid curves to be used in SCED problem. The power demand for the buildings is obtained after subtracting the generation bids of the bidder agents and power demands of the fixed loads from the total cleared electricity demand at the transmission bus. However, in the transactive demand-supply coordination approach, the asker agents may be cleared at the distribution-level transactive market or at the transmission-level market; thus, buildings have different volumes of electricity demand based on whether they were cleared at the transmission or distribution levels. The average cleared demand of buildings (Metric-3) is defined for the centralized approach, and individually for the distribution-level and transmission-level in the transactive approach.

3.3.4. Consumer and producer surplus (Metric-4)

This metric is used to quantify the surplus that consumers (producers) receive from purchasing (selling) goods/services in a market. Specifically, consumer surplus is defined as the difference between the price customers are willing to pay for goods/services and the price that they end up paying. That is, if consumers purchase a good for less than the maximum price that they were willing to pay, they receive a consumer surplus. Similarly, producer surplus is defined as the difference between the price producers are willing to supply for a commodity and the price that they receive. That is, if producers sell a good for more than the minimum price that they were willing to sell, they receive a producer surplus. This is graphically shown in Fig. 4, where demand and supply curves are denoted by D and S, respectively. Note that the intersection of the supply and demand curves specified as the price of P1 and demand

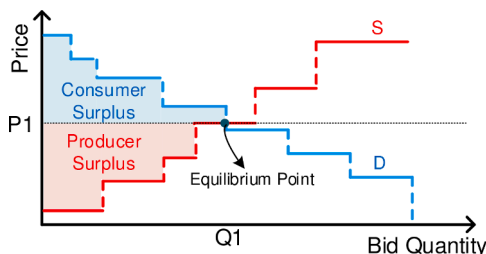

Fig. 4. Consumer and producer surplus (metric-4).

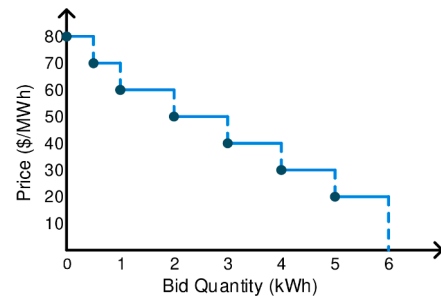

Fig. 5. Demand bid curve used in Experiment 4.1 (varying DERs’ sizes).

quantity of Q1, is the equilibrium point of this market. This is where the quantity demanded and the quantity supplied are equal. The price P1 is the equilibrium price or market-clearing price, and the quantity Q1 is the equilibrium quantity of the market.

3.4. Assumptions and parameters for comparison

For a valid comparison between the two market coordination mechanisms, the simulations should be based on identical assumptions and parameters. However, due to the structural differences between the two coordination mechanisms, we made some minor modifications in the simulations for the transactive approach; these changes and associated rationale are described in this section. We also detail other assumptions that we made for the simulation studies for both methods.

In the centralized market coordination approach, we assume that asker agents have the same demand-bid curves, which intuitively means asker agents have same power consumption behavior. However, this assumption is not valid for the transactive approach. That is, the transactive approach is the auction-based market, and asker agents should have different power demands to maintain the competitive nature of the market. This is analogous to a real auction in any market where the same price offer by markets participants eliminates the competition in the market. With the same rationale, generation capacities of bidder agents should be different. Therefore, we use zero-mean Gaussian noise with a small variance to generate a different set of demand bid quantities and generation capacities for each asker and bidder agents, respectively, in the transactive approach. Note that as the main goal of this work is to provide a comparison between market coordination methods, we try to modify the systems in such a way that both methods end up with the same features. Thus, although such a variation differentiates the demand bid curves of the asker agents and capacities of bidder agents, due to zero-mean Gaussian noise, the considered characteristics for asker and bidder agents in both methods are similar enough for a comparative study. Note that in the rest of this work and for ease of use, when discussing the transactive approach, we may say the demand bid quantities of asker agents and generation capacities of bidder agents are the same, while we differentiate them slightly using zero-mean Gaussian noise. Similarly, bidder agents should have different demand-bids based on which they compete to provide power to the asker agents. Again, this is analogous to any auction-based market where all sellers cannot sell the same goods with the same prices. The different bidding prices in bidder agents can be due to their location, capacities, and design parameters. To mitigate this concern, we choose random values for the bidding price of bidder agents bounded by pre-specified maximum and minimum limits. The minimum bidding price should be chosen equal to the cost of generation. The maximum bidding price should be less than the price of energy offered by the wholesale energy provider. This is consistent with the fact that asker agents prefer to purchase energy from the wholesale energy provider when the price is equal to those offered by bidder agents. Minimum and maximum cost of generation considered in this work for bidder agents (DERs) are 20 \$/MWh and 80 \$/MWh, respectively. The other assumption is that trans-

mission nodes are identical, i.e., they serve identical distribution systems. This means that all distribution systems (primary feeders) downstream of a transmission node have the same load demand and DER generation capacities.

4. Simulations

In this section, we perform a comparative analysis of the centralized and transactive demand-supply coordination approaches based on the metrics explained in Section 3.3. Several experiments with different parameters of the test systems are simulated to understand their effects on the market-clearing and resources dispatch process. Specifically, we compare introduced metrics when the simulated test system is populated with different levels of DER penetrations, varying flexible load size, and load elasticity. Table 4 summarizes the main simulation parameters of the experiments in this section, where the parameters of this table are explained thoroughly in the related experiments.

4.1. Effects of DERs sizes

In this experiment (termed as “Experiment 4.1”), we consider three test cases based on different generation capacities for DERs. Specifically, the DERs sizes are set to 6 kW (case A1), 3 kW (case A2), and 0 kW (case A3) representing the high, medium, and zero DERs penetration levels, respectively. A typical demand bid curve of the residential buildings is used for all three cases (see Fig. 5). Note that for the case A3 (with zero DERs), the results for both centralized and transactive methods are the same. This is because, in this case, there are no bidder agents and hence the transactive coordination among distribution-level agents is not possible. The findings in terms of the comparison metrics are discussed below.

- **Power Dispatch at the Transmissions level (Metric-1):** Fig. 6 shows the comparison results based on this metric. On increasing the DER sizes, the power dispatch for the transmission nodes decreases for both market coordination approaches. This is because, the DERs offset the loads, hence, reduce the aggregated load demand. The transactive approach, however, leads to a higher aggregated load demand compared to the centralized approach for the cases with equal DER sizes. That is, the distribution-level market in the transactive coordination approach results in clearing of additional flexible loads and hence additional power demand compared to the centralized approach.
- **Market-Clearing Price (Metric-2):** The reduced demand at the transmission-level due to increasing the DERs sizes leads to a lower market-clearing prices for both centralized and transactive approaches (see Metric-2 in Table 5). However, as the cleared demand at the transmission-level is higher for the transmission-level market of the transactive approach when compared to centralized approach, the market-clearing prices (Metric-2) are also higher. Furthermore, increasing the DER sizes leads to a decrease in market-clearing prices at the distribution-level market of the transactive approach. This is because, upon increasing the generation capacities for a constant amount of load demand at the distribution-level, the market becomes

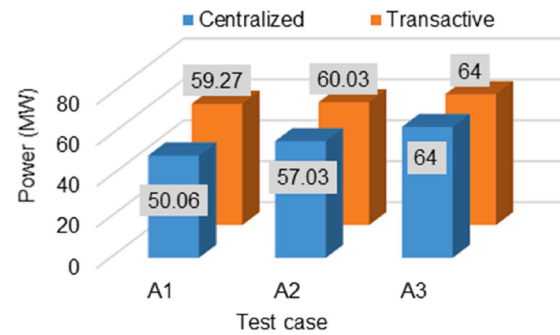

Fig. 6. Metric-1 (Power Dispatch in the Transmission-level) based on test cases in Experiment 4.1 (Varying DERs’ sizes).

Table 5

Comparison of both coordination approaches based on Metric-2 (Market-Clearing Price) and Metric-3 (Average Cleared Demand for the Buildings) for test cases in Experiment 4.1 (varying DERs’ sizes) .

	Metric-2 (\$/MWh)			Metric-3 (kW)		
	A1	A2	A3	A1	A2	A3
Centralized	60.65	61.32	61.98	1	1	1
Transactive (transmission-level)	61.53	61.6	61.98	0	1	1
Transactive (distribution-level)	32.9	36.18	NA	2.97	1.74	NA

less competitive and the buildings can purchase additional energy at a lower cost.

- **Average Cleared Demand for the Buildings (Metric-3):** For the centralized approach, increasing the DER sizes does not affect the volume of the cleared demand for the buildings (see metric 3 in Table 5). For the distribution-level of the transactive approach, a higher DER capacity clears more flexible demands for the buildings. The cleared demand is different at the transmission-level market of the transactive approach. For example, for case A1 with 6 kW DERs, all the flexible load demands of buildings (2.97 kW per building on average) are cleared at the distribution-level using available DERs, i.e., for this case, no flexible demand is cleared in the transmission-level market. However, as DER sizes are decreased to 3 kW, additional flexible demands for the buildings are cleared at the transmission-level. This amounts to on an average 1 kW of flexible demand. As expected, for the extreme case with no DER generation, all flexible demand is cleared at the transmission-level.
- **Consumer and Producer Surplus (Metric 4):** Fig. 7a shows that for both market coordination methods, increasing DER sizes leads to a decrease in the conventional generators surplus. However, due to an overall higher load demand, conventional generators benefit more in the transactive approach compared to the centralized approach. On the contrary, the DERs are more profitable and have a higher surplus in the centralized approach compared to the transactive approach (see Fig. 7b). This is because, the DERs, to be competitive in transactive approach, need to sell electricity to buildings at a cost lower than the wholesale market-clearing price. However, in the

Table 4

Summary of the parameters used for different experiments in Section 4.

Parameter	Experiment 4.1 ^a			Experiment 4.2 ^b			Experiment 4.3 ^c		
	A1	A2	A3	B1	B2	B3	C1	C2	C3
DER Sizes (kW)	6	3	0	6	6	6	6	6	6
Demand bid curve	Fig. 5	Fig. 5	Fig. 5	$\alpha = 0.66$	$\alpha = 0.50$	$\alpha = 0$	$m_{avg} = -0.5$	$m_{avg} = -0.75$	$m_{avg} = -1$

^a The identical demand bid curve (see Fig. 5) is used for the buildings in this experiment.

^b The demand bid curves for this experiment is generated by modifying the demand-bid curve in Fig. 5 based on different load flexibility (see Section 4.2).

^c The demand bid curves for this experiment is generated by modifying the demand-bid curve in Fig. 5 based on different load elasticity (see Section 4.3).

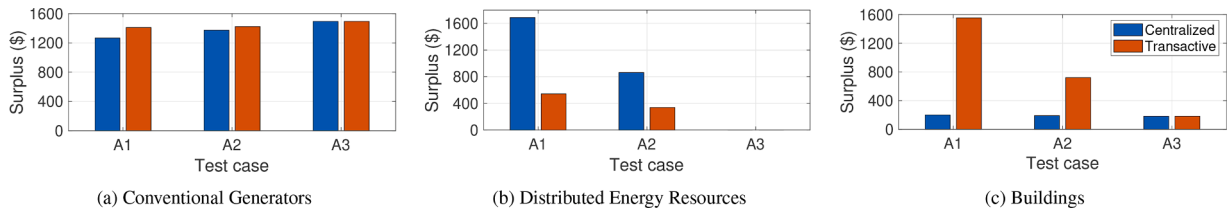

Fig. 7. Metric-4 (Consumer and Producer Surplus) for market’s units based on coordination approaches for test cases in Experiment 4.1 (varying DERs sizes).

centralized approach, the DERs are compensated at the wholesale market-clearing price; thus, they have a higher surplus. Finally, the flexible loads (in buildings) receive a higher surplus in the transactive approach (see Fig. 7c). This is because, the distribution-level retail market in transactive coordination approach provides more competitive prices to the flexible loads compared to the wholesale market-clearing price. This leads to clearing of a higher amount of flexible load demand due to lower retail prices. The fixed loads, however, pay a higher price for electricity consumption in the transactive approach.

4.2. Effects of flexible load size

In this experiment (termed as “Experiment 4.2”), we investigate the effects of increasing load flexibility for the buildings. First, we define a measure to quantify load flexibility as α defined by (33).

$$\alpha = \frac{\max(P_{flex})}{\max(P_{flex}) + P_{fix}} \quad (33)$$

where, $\max(P_{flex})$ and P_{fix} are the maximum flexible and fixed loads in a building, respectively. We vary the load flexibility of the building by varying the value of α .

We simulate three test cases with buildings having different load flexibility (see Table 6). The demand bid curves for each test case is generated by modifying the demand-bid curve in Fig. 5 as per the parameters in Table 6. Note that, in all test cases, the buildings have the same maximum power demand. Also, DER sizes are assumed to be constant and equal to 6 kW for all test cases. Note that for case B3 (with no flexible load), the results for both centralized and transactive methods are the same. This is because, for this case, there are no flexible loads in the system. Hence, the transactive coordination among distribution-level agents is not possible. In what follows, the findings of this experiments in terms of the comparison metrics are provided.

- **Power Dispatch at the Transmissions level (Metric-1):** Fig. 8 shows that for both market coordination approaches a higher load flexibility decreases the amount of power dispatched at the transmission-level. This is because, it is more economical to clear lesser demand by the transmission-level economic dispatch algorithm by effectively leveraging the flexible loads. Also, for the cases with same load flexibility indices (i.e. with equal flexible load sizes), the distribution-level market in the transactive coordination approach ends up clearing a higher aggregated load demand compared to the centralized approach. This implies that transactive approach is more competitive than the centralized approach for loads with same flexibility.

Table 6 Parameters for test cases in Experiment 4.2 (varying load flexibility) .

	$\max(P_{flex})$	P_{fix}	α
Case B1	4	2	0.66
Case B2	3	3	0.50
Case B3	0	6	0

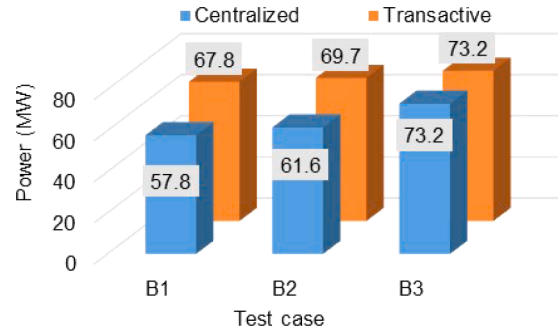

Fig. 8. Metric-1 (Power Dispatch in the Transmission-level) based on test cases in Experiment 4.2 (Varying flexible load size).

- **Market-Clearing Price (Metric-2):** For both centralized and transactive (at the transmission-level) approaches, an increase in cleared load demand upon decreasing the load flexibility leads to a higher market-clearing price at the transmission-level (see Table 7). Further, at the transmission-level, the market-clearing prices are higher for the transactive approach compared to the centralized approach. This is because, transactive approach clears more demand at the transmission-node. On the contrary, decreasing load flexibility leads to lower average market-clearing prices at the distribution-level of the transactive demand-supply coordination approach. This is because, higher load flexibility provides greater opportunity for the bidder agents to bid at higher electricity prices thus, resulting in a higher average distribution-level prices.
- **Average Cleared Demand for the Buildings (Metric-3):** For both centralized and transactive (transmission-level) approaches, decreasing load flexibility increases the amount of total cleared demands for each building to satisfy the corresponding fixed load demands (see metric 3 in Table 7). However, at the distribution-level of the transactive approach, reducing the flexible load size reduces the demand cleared at the distribution-level. This is because, the distribution-level market of the transactive approach becomes less competitive upon reducing the amount of flexible loads.
- **Consumer and Producer Surplus (Metric-4):** The results are shown in Fig. 9a. For both coordination methods, decreasing the flexible load sizes (from case B1 to B3) leads to an increase in the conventional generators surplus. For each case, the market surplus is higher in the transactive approach compared to the centralized approach. Furthermore, DERs observe higher surplus by participating in the centralized approach, i.e., by selling energy at the transmission-level

Table 7 Comparison of both coordination approaches based on Metric-2 (Market-Clearing Price) and Metric-3 (Average Cleared Demand for the Buildings) for test cases in Experiment 4.2 (varying flexible load size) .

	Metric-2 (\$/MWh)			Metric-3 (kW)		
	B1	B2	B3	B1	B2	B3
Centralized	61.39	61.76	62.87	2.7	3.5	6
Transactive (transmission-level)	62.35	62.53	62.87	2	3	6
Transactive (distribution-level)	29.47	27.7	NA	2.8	2.2	NA

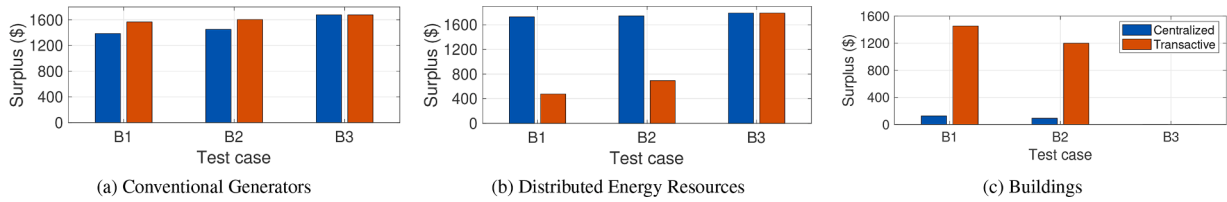

Fig. 9. Metric-4 (Consumer and Producer Surplus) for market’s units based on coordination approaches for test cases in Experiment 4.2 (varying load size) .

market-clearing price. Note that in the transactive approach, DERs participate in the competitive distribution-level retail market and end up bidding at a price lower than the transmission-level clearing price thus making less surplus. As the size of flexible load is decreased (fixed load size is increased), lesser amount of DERs are cleared at the distribution-level of the transactive approach. The unused generation is utilized to clear fixed load demands at the transmission-level at a comparatively high price, thus, increasing the DER surplus. Fig. 9c shows that buildings surplus decreases significantly with the decrease in flexible load size, and it reaches zero case B3 for both markets. As the customer surplus is a direct result of its flexibility, this observation is as expected. Furthermore, the buildings’ benefit more in the transactive approach as they purchase a higher volume of energy for their flexible loads at lower prices from DERs in the transactive distribution-level market. On the contrary, the fixed loads end up paying a higher cost of energy in the transactive vs. the centralized approach.

4.3. Effects of demand-side elasticity

Next, we analyze the effects of the elasticity of the buildings’ flexible loads on centralized and transactive approaches. We define load elasticity as a metric to measure the ability of the building to shift/curtail its demand based on the price. Specifically, for a unit increase in the price of electricity (e.g., 1 \$/kWh), a building with a higher load elasticity is willing to shift/curtail more of its demand compared to those with a lower load elasticity. The load elasticity is quantified using the average slopes of the demand-bid curves, (34) and (35).

$$m(i) = \frac{P(i+1) - P(i)}{Price(i+1) - Price(i)} \text{ for } i = 1, \dots, n - 1 \tag{34}$$

$$m_{avg} = \frac{\sum_{i=1}^{n-1} m(i)}{n - 1} \tag{35}$$

where, $m(i)$ is the slope of i^{th} line segment, and m_{avg} is the average slope of the demand-bid curve. The average slope of each demand-bid curve is used as an index for comparing the elasticity of buildings load demands.

Three test cases are simulated by varying the load elasticity with high (case C1), medium (case C2), and low (case C3) values. The demand bid curve in the Fig. 5 is modified for different test cases in this experiment such that the cases with high, medium and low elasticity have average slopes of $m_{avg} = -0.5$ (case C1), $m_{avg} = -0.75$ (case C2), and $m_{avg} = -1$ (case C3), respectively. Also, DER sizes are assumed to be constant and equal to 6 kW for all test cases. The findings are detailed below.

- **Power Dispatch at the Transmissions level (Metric-1):** For the centralized approach, less power is dispatched at the transmission-level upon decreasing the load elasticity (see Fig. 10). This is because, the social optimum dictates clearing of more load demand when the load is more elastic. However, for the transactive approach, load elasticity does not affect the dispatch at the transmission-level. In this case, regardless of the load elasticity, only fixed demand is cleared at the transmission-level; all flexible demand of the system is cleared in the distribution-level. Finally, compared to centralized approach, for cases with equal load elasticity, the transactive

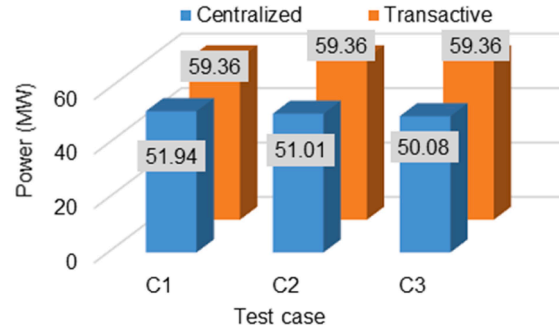

Fig. 10. Metric-1 (Power Dispatch in the Transmission-level) based on test cases in Experiment 4.3 (varying load elasticity).

approach clears higher load demand as it clears a larger amount of flexible load.

- **Market-Clearing Price (Metric-2):** The results shown in Table 8 follow from the observations of Metric-1. For the centralized approach, decreasing load elasticity, reduces the market-clearing prices as lesser demand is dispatched at the transmission-level. However, for the transmission-level market of the transactive approach, all cases have the same clearing price as the same amount of power is dispatched (Metric-1). Also, compared to the centralized approach, the market-clearing prices are higher for the transactive approach as the transactive approach clears a higher amount of demand at the transmission-level. Finally, it is observed that upon decreasing the load elasticity, the market-clearing prices decrease at the distribution-level market of the transactive approach. This is because lower load elasticity makes the transactive distribution-level market less competitive for DERs and hence they settle at a lower average price.
- **Average Cleared Demand for the Buildings (Metric-3):** For centralized approach, decreasing load elasticity, clears lesser flexible demand for the building (see Table 8). For the transactive approach, regardless of the load elasticity, all flexible demand is cleared at the distribution-level market. The transactive approach, however, clears a higher amount of flexible load demand, 3 kW for each test case.
- **Consumer and Producer Surplus (Metric-4):** It is observed that, compared to the centralized approach, conventional generators incur more surplus in the transactive approach as they sell more power at a higher price (see Fig. 11a). Further, while the surplus for conventional generators reduces with the reduction in load elasticity, for transactive case, they incur same surplus regardless of the load

Table 8

Comparison of both coordination approaches based on Metric-2 (Market-Clearing Price) and Metric-3 (Average Cleared Demand for the Buildings) for test cases in Experiment 4.3 (varying load elasticity) .

	Metric-2 (\$/MWh)			Metric-3 (kW)		
	C1	C2	C3	C1	C2	C3
Centralized	60.83	60.74	60.64	1.4	1.2	1
Transactive (transmission-level)	61.54	61.54	61.54	0	0	0
Transactive (distribution-level)	46.22	42.81	37	3	3	3

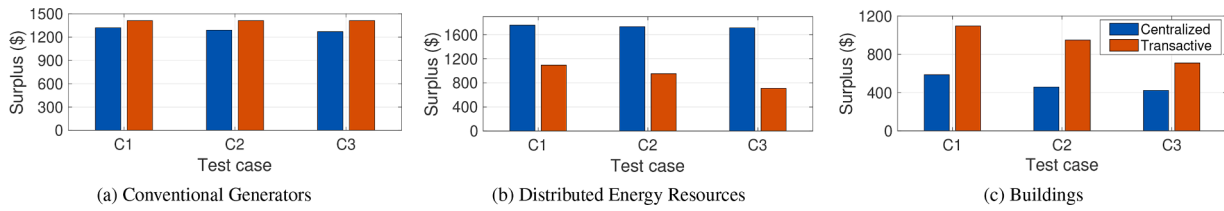

Fig. 11. Metric-4 (Consumer and Producer Surplus) for market’s units based on coordination approaches for test cases in Experiment 4.3 (varying load elasticity) .

elasticity. On the contrary, DERs incur more surplus in the centralized approach as they sell at the transmission-level clearing price, which is higher than the average distribution-level clearing prices in the transactive approach (see Fig. 11b). Further, for the transactive approach, DER surplus decreases upon decreasing the load elasticity while the surplus is same for all the cases in the centralized approach due to same market-clearing prices. As for the buildings, they incur higher surplus from participating in the transactive approach due to the more competitive bidding prices offered by DERs at the distribution-level transactive market. Further, for both centralized and transactive approaches, the consumer surplus decreases upon decreasing the load elasticity.

5. Summary of the observations

A summary of key observations is presented in Tables 9 and 10. Also, the general observations based-on the results of the market coordination comparison study are listed below:

- The centralized market coordination approach leads to overall lower power consumption for the transmission and distribution systems. This is because the cleared flexible demand for each building is much lower compared to the average amount of cleared demand in the distribution-level market in the transactive coordination approach. The competitive prices in the distribution-level lead to a higher value of cleared flexible demand in the transactive approach. As a result, compared to the transactive approach, the wholesale market-clearing prices are lower for the centralized approach.
- In the transactive approach, the buildings on average end up paying much lower prices for their electricity consumption compared to the centralized approach. This, however, comes at the cost of increased energy prices for the feeders fixed loads.
- In the centralized approach, higher elasticity for flexible demand leads to a lower power consumption for both the transmission and the distribution systems. In the transactive approach, higher elasticity for the flexible load demand does not change the power consumption and LMP in the transmission system. However, as the elasticity of the flexible load demand increases, the average price of the transacted energy between agents increases.
- The transactive approach usually benefits (higher surplus) conventional generators and buildings (flexible loads), while the centralized approach benefits DERs and fixed loads.

Table 9 Comparing market participants’ profit based on the coordination approaches (✓shows the higher profit for the corresponding market participant) .

	Market Participants			
	DERs	Flexible Loads (buildings)	Fixed Loads	Conventional Generators
Centralized Approach	✓		✓	
Transactive Approach		✓		✓

Table 10

Comparing different parameters for the centralized and transactive market coordination approaches (✓shows a higher value is realized for the specific parameter in the given coordination approach) .

	Parameter			
	Energy cost for feeder’s flexible loads	Energy cost for feeders fixed loads	Market-clearing prices at the wholesale-level	Total Power Consumption
Centralized Approach	✓			
Transactive Approach		✓	✓	✓

6. Conclusions

Harnessing the demand-side flexibility of a large number of demand response (DR) resources calls for joint supply-demand coordination mechanisms to allow active participation of DR resources into the wholesale market price formation and load dispatch process. This work presented a comprehensive study of the centralized and transactive demand-supply coordination mechanisms for supply and demand resources at the distribution system level. The centralized approach is based on a hierarchical interaction among different network entities, including individual customers, distribution system operators (DSOs), and transmission system operators (TSOs). In this approach, individual customers proactively participate in DR by generating demand bids; then, the demand bids and available DERs generation in distributions system are aggregated by the DSOs. DSOs submit the aggregated demand bids to the TSO, where all power transactions are cleared by optimizing the social welfare criteria. In the transactive coordination approach, market participants maximize their individual interests by transacting electric energy with other participants and perform separate computational tasks; then, the aggregated demand/supply, that is uncleared at the distribution-level market, are cleared by the TSO. These coordination methods are simulated using a comprehensive test system and thoroughly compared using different metrics under several test scenarios. The economic impacts of each coordination scheme on different distribution-level participants and also on the wholesale market are detailed. Generally, it is observed that the centralized coordination scheme is more profitable for the DERs and fixed loads, while the transactive approach is more profitable for conventional generators and flexible loads. Also, it was observed that the market-clearing price and power consumption at the transmission-level are higher in the case of the transactive coordination approach.

CRediT authorship contribution statement

Mohammad Ostadijafari: Methodology, Investigation, Data curation, Writing – original draft. Juan Carlos Bedoya: Data curation, Writing – original draft. Wei Wang: Data curation, Writing – original draft. Anamika Dubey: Conceptualization, Supervision, Writing – review & editing. Chen-Ching Liu: Supervision, Writing – review & editing. Nanpeng Yu: Supervision, Writing – review & editing.

Declaration of Competing Interest

The authors declare that they have no known competing financial interests or personal relationships that could have appeared to influence the work reported in this paper.

References

- [1] J.C. Bedoya, C.-C. Liu, G. Krishnamoorthy, A. Dubey, Bilateral electricity market in a distribution system environment, *IEEE Trans Smart Grid* 10 (6) (2019) 6701–6713.
- [2] F.E.R. Commission, et al., A national assessment of demand response potential, Federal Energy Regulatory Commission, Washington, DC (2009).
- [3] M.H. Albadi, E.F. El-Saadany, A summary of demand response in electricity markets, *Electr. Power Syst. Res.* 78 (11) (2008) 1989–1996.
- [4] R. Deng, Z. Yang, M. Chow, J. Chen, A survey on demand response in smart grids: mathematical models and approaches, *IEEE Trans. Ind. Inf.* 11 (3) (2015) 570–582, <https://doi.org/10.1109/TII.2015.2414719>.
- [5] Federal Energy Regulatory Commission (FERC), A national assessment of demand response potential, <https://www.ferc.gov/legal/staff-reports/06-09-demand-response.pdf>.
- [6] T. Wei, Q. Zhu, N. Yu, Proactive demand participation of smart buildings in smart grid, *IEEE Trans. Comput.* 65 (5) (2016) 1392–1406.
- [7] N. Yu, T. Wei, Q. Zhu, From passive demand response to proactive demand participation. 2015 IEEE International Conference on Automation Science and Engineering (CASE), IEEE, 2015, pp. 1300–1306.
- [8] R. El Geneidy, B. Howard, Contracted energy flexibility characteristics of communities: analysis of a control strategy for demand response, *Appl Energy* 263 (2020) 114600.
- [9] J.S. Vardakas, N. Zorba, C.V. Verikoukis, A survey on demand response programs in smart grids: pricing methods and optimization algorithms, *IEEE Communications Surveys Tutorials* 17 (1) (2015) 152–178, <https://doi.org/10.1109/COMST.2014.2341586>.
- [10] D.S. Kirschen, Demand-side view of electricity markets, *IEEE Trans. Power Syst.* 18 (2) (2003) 520–527, <https://doi.org/10.1109/TPWRS.2003.810692>.
- [11] Y. Liu, L. Xiao, G. Yao, S. Bu, Pricing-based demand response for a smart home with various types of household appliances considering customer satisfaction, *IEEE Access* 7 (2019) 86463–86472.
- [12] H.J. Monfared, A. Ghasemi, A. Loni, M. Marzband, A hybrid price-based demand response program for the residential micro-grid, *Energy* 185 (2019) 274–285.
- [13] C. Vivekananthan, Y. Mishra, G. Ledwich, F. Li, Demand response for residential appliances via customer reward scheme, *IEEE Trans Smart Grid* 5 (2) (2014) 809–820.
- [14] K. Kaur, N. Kumar, M. Singh, Coordinated power control of electric vehicles for grid frequency support: milp-based hierarchical control design, *IEEE Trans Smart Grid* 10 (3) (2018) 3364–3373.
- [15] H. Mehrjerdi, Multilevel home energy management integrated with renewable energies and storage technologies considering contingency operation, *J. Renewable Sustainable Energy* 11 (2) (2019) 025101.
- [16] A. Ahmadian, B. Mohammadi-Ivatloo, A. Elkamel, A review on plug-in electric vehicles: introduction, current status, and load modeling techniques, *J. Mod Power Syst. Clean Energy* (2020).
- [17] M.A.A. Pedrasa, T.D. Spooner, I.F. MacGill, Coordinated scheduling of residential distributed energy resources to optimize smart home energy services, *IEEE Trans Smart Grid* 1 (2) (2010) 134–143.
- [18] M. Ostadjafari, A. Dubey, Y. Liu, J. Shi, N. Yu, Smart building energy management using nonlinear economic model predictive control. 2019 IEEE Power Energy Society General Meeting (PESGM), 2019, pp. 1–5, <https://doi.org/10.1109/PESGM40551.2019.8973669>.
- [19] T. Wei, Q. Zhu, M. Maasoumy, Co-scheduling of HVAC control, EV charging and battery usage for building energy efficiency. Proceedings of the 2014 IEEE/ACM International Conference on Computer-Aided Design, IEEE Press, 2014, pp. 191–196.
- [20] H. Mohsenian-Rad, Optimal bidding, scheduling, and deployment of battery systems in California day-ahead energy market, *IEEE Trans. Power Syst.* 31 (1) (2015) 442–453.
- [21] C.S. Antúnez, J.F. Franco, M.J. Rider, R. Romero, A new methodology for the optimal charging coordination of electric vehicles considering vehicle-to-grid technology, *IEEE Trans. Sustainable Energy* 7 (2) (2016) 596–607.
- [22] M. Ostadjafari, R.R. Jha, A. Dubey, Aggregation and bidding of residential demand response into wholesale market. 2020 IEEE Texas Power and Energy Conference (TPEC), 2020, pp. 1–6.
- [23] J. Iria, P. Scott, A. Attarha, Network-constrained bidding optimization strategy for aggregators of prosumers, *Energy* 207 (2020) 118266.
- [24] M. Javadi, T. Amraee, F. Capitanescu, Look ahead dynamic security-constrained economic dispatch considering frequency stability and smart loads, *International Journal of Electrical Power & Energy Systems* 108 (2019) 240–251.
- [25] D. Wu, J. Lian, Y. Sun, T. Yang, J. Hansen, Hierarchical control framework for integrated coordination between distributed energy resources and demand response, *Electr. Power Syst. Res.* 150 (2017) 45–54.
- [26] S. Chen, C.-C. Liu, From demand response to transactive energy: state of the art, *J. Mod Power Syst. Clean Energy* 5 (1) (2017) 10–19.
- [27] Z. Liu, Q. Wu, S. Huang, H. Zhao, Transactive energy: A review of state of the art and implementation. 2017 IEEE Manchester PowerTech, IEEE, 2017, pp. 1–6.
- [28] O. Abrishambaf, F. Lezama, P. Faria, Z. Vale, Towards transactive energy systems: an analysis on current trends, *Energy Strategy Reviews* 26 (2019) 100418.
- [29] K. Kok, S. Widergren, A society of devices: integrating intelligent distributed resources with transactive energy, *IEEE Power Energy Mag.* 14 (3) (2016) 34–45, <https://doi.org/10.1109/MPE.2016.2524962>.
- [30] H.K. Nunna, D. Srinivasan, Multiagent-based transactive energy framework for distribution systems with smart microgrids, *IEEE Trans. Ind. Inf.* 13 (5) (2017) 2241–2250.
- [31] J. Hu, G. Yang, C. Ziras, K. Kok, Aggregator operation in the balancing market through network-constrained transactive energy, *IEEE Trans. Power Syst.* 34 (5) (2018) 4071–4080.
- [32] P.H. Divshali, B.J. Choi, H. Liang, Multi-agent transactive energy management system considering high levels of renewable energy source and electric vehicles, *IET Generation, Transmission & Distribution* 11 (15) (2017) 3713–3721.
- [33] L. Tesfatsion, Electric Power Markets in Transition: Agent-based Modeling Tools for Transactive Energy Support. Handbook of computational economics volume 4, Elsevier, 2018, pp. 715–766.
- [34] J.C. Bedoya, M. Ostadjafari, C.C. Liu, A. Dubey, Decentralized transactive energy for flexible resources in distribution systems, *IEEE Trans. Sustainable Energy* (2020) 1–10.
- [35] F.A. Rahimi, A. Ipakchi, Transactive energy techniques: closing the gap between wholesale and retail markets, *The Electricity Journal* 25 (8) (2012) 29–35.
- [36] M. Ostadjafari, A. Dubey, Tube-based model predictive controller for buildings heating ventilation and air conditioning (HVAC) system, *IEEE Syst. J.* (2020) 1–10.
- [37] M.M. Haghghi, A.L. Sangiovanni-Vincentelli, Modeling and optimal control algorithm design for HVAC systems in energy efficient buildings, Masters report (2011).
- [38] M. Ostadjafari, R.R. Jha, A. Dubey, Conservation voltage reduction by coordinating legacy devices, smart inverters and battery. 2019 North American Power Symposium (NAPS), 2019, pp. 1–6.
- [39] M. Ostadjafari, A. Dubey, Linear model-predictive controller (LMPC) for buildings heating ventilation and air conditioning (HVAC) system. 2019 IEEE Conference on Control Technology and Applications (CCTA), 2019, pp. 617–623, <https://doi.org/10.1109/CCTA.2019.8920657>.
- [40] M. Di Somma, G. Graditi, P. Siano, Optimal bidding strategy for a DER aggregator in the day-ahead market in the presence of demand flexibility, *IEEE Trans. Ind. Electron.* 66 (2) (2018) 1509–1519.
- [41] M. Ostadjafari, R.R. Jha, A. Dubey, Demand-side participation via economic bidding of responsive loads and local energy resources, *IEEE Open Access Journal of Power and Energy* (2020) 1–12, <https://doi.org/10.1109/OAJPE.2020.3035536>.
- [42] M. Ostadjafari, A. Dubey, N. Yu, Linearized price-responsive HVAC controller for optimal scheduling of smart building loads, *IEEE Trans Smart Grid* 11 (4) (2020) 3131–3145.
- [43] J. Shi, N. Yu, W. Yao, Energy efficient building HVAC control algorithm with real-time occupancy prediction, *Energy Procedia* 111 (C) (2017).
- [44] Y. Liu, N. Yu, W. Wang, X. Guan, Z. Xu, B. Dong, T. Liu, Coordinating the operations of smart buildings in smart grids, *Appl Energy* 228 (2018) 2510–2525.
- [45] M. Maasoumy, M. Razmara, M. Shahbakhti, A.S. Vincentelli, Handling model uncertainty in model predictive control for energy efficient buildings, *Energy Build* 77 (2014) 377–392.
- [46] S. Burger, J.D. Jenkins, C. Battle López, J.I. Pérez Arriaga, Restructuring revisited: competition and coordination in electricity distribution systems (2018).
- [47] W. Wang, N. Yu, Chordal conversion based convex iteration algorithm for three-phase optimal power flow problems, *IEEE Trans. Power Syst.* 33 (2) (2018) 1603–1613.
- [48] W. Vickrey, Counterspeculation, auctions, and competitive sealed tenders, *J Finance* 16 (1) (1961) 8–37.
- [49] M. Ostadjafari, J.C. Bedoya, A. Dubey, C.-C. Liu, Bilateral market for distribution-level coordination of flexible resources using volttron. 2021 IEEE Madrid PowerTech, 2021, pp. 1–6, <https://doi.org/10.1109/PowerTech46648.2021.9495086>.
- [50] A. Hahn, R. Singh, C.-C. Liu, S. Chen, Smart contract-based campus demonstration of decentralized transactive energy auctions. 2017 IEEE Power & energy society innovative smart grid technologies conference (ISGT), IEEE, 2017, pp. 1–5.
- [51] A.R. Al-Roomi, Power Flow Test Systems Repository, 2015, <https://al-roomi.org/p-ower-flow>.
- [52] W.H. Kersting, Radial distribution test feeders, *IEEE Trans. Power Syst.* 6 (3) (1991) 975–985.