

# UC Office of the President

## ITS reports

### Title

Is It OK to Get in a Car with a Stranger? Risks and Benefits of Ride-pooling in Shared Automated Vehicles

### Permalink

<https://escholarship.org/uc/item/1cb6n6r9>

### Authors

Sanguinetti, Angela

Kurani, Ken

Ferguson, Beth

### Publication Date

2019-02-01

# Is it OK to Get in a Car with a Stranger? Risks and Benefits of Ride-pooling in Shared Automated Vehicles

A Research Report from the University of California Institute of Transportation Studies

Angela Sanguinetti, Research Environmental Psychologist, Institute of Transportation Studies, University of California, Davis

Ken Kurani, Associate Researcher, Institute of Transportation Studies, University of California, Davis

Beth Ferguson, Assistant Professor, Department of Design, University of California, Davis

*February 2019*

## Technical Report Documentation Page

<b>1. Report No.</b> UC-ITS-2018-20	<b>2. Government Accession No.</b> N/A	<b>3. Recipient's Catalog No.</b> N/A	
<b>4. Title and Subtitle</b> Is It OK to Get in a Car with a Stranger? Risks and Benefits of Ride-pooling in Shared Automated Vehicles		<b>5. Report Date</b> February 2019	
		<b>6. Performing Organization Code</b> ITS-Davis	
<b>7. Author(s)</b> Angela Sanguinetti, Ph.D., <a href="http://orcid.org/0000-0002-9008-7175">http://orcid.org/0000-0002-9008-7175</a> Ken Kurani, Ph.D., <a href="https://orcid.org/0000-0002-4597-4795">https://orcid.org/0000-0002-4597-4795</a> Beth Ferguson, <a href="https://orcid.org/0000-0001-7319-2590">https://orcid.org/0000-0001-7319-2590</a>		<b>8. Performing Organization Report No.</b>	
<b>9. Performing Organization Name and Address</b> Institute of Transportation Studies, Davis 1605 Tilia Street Davis, CA 95616		<b>10. Work Unit No.</b> N/A	
		<b>11. Contract or Grant No.</b> UC-ITS-2018-20	
<b>12. Sponsoring Agency Name and Address</b> The University of California Institute of Transportation Studies <a href="http://www.ucits.org">www.ucits.org</a>		<b>13. Type of Report and Period Covered</b> Final Report (January 2018 – October 2018)	
		<b>14. Sponsoring Agency Code</b> UC ITS	
<b>15. Supplementary Notes</b> DOI:10.7922/G27M064Z			
<b>16. Abstract</b> We currently know little about what to expect regarding ride-pooling in shared automated vehicles (SAVs). Who will be willing to share rides, with whom, and under what conditions? This report details the efforts and results funded by two seed grants that converged on these questions. A broad-based literature review and review of automated vehicle (AV designs) leads to the articulation of potential risks and benefits of the pooled SAV experience and potential design solutions and supports, respectively. Risks could be related to compromised personal space, security, control, and convenience. Design features that might mitigate these risks include large windows to afford a high degree of visibility into and out of the vehicle, spacious seating and legroom (relative to larger shared vehicles like buses, trains, and planes), access to a remote human administrator who can observe inside the vehicle at all times, easy means to program private stops that are nearby one's ultimate origins and destinations (to maintain privacy), and options for large groups or associations to "own" a particular vehicle (e.g., a female only SAV). Benefits of pooled SAVs could be related to restoration and social capital. Design features that could support these benefits include themed interiors; quizzes, games and ambient entertainment; augmented reality windshields; flexible seating allowing riders to face each other; accommodations for food and drink; ensuring broad access; and making SAVs a canvas for local art. The reports ends with a proposed research agenda highlighting the importance of qualitative engagement with consumers to understand the issues related to: switching to pooled SAVs from various dominant travel modes (e.g., private cars, ride-hailing, public transit); leveraging analogous modes (e.g., pooled ride-hailing) to study the potential of pooled SAVs; and conducting experiments to understand the influence of various features of the pooled SAV experience that will impact consumer adoption. This report can inform SAV designers, policy-makers, private transit service providers, and other stakeholders about behavioral and design factors that will impact uptake of pooled SAVs.			
<b>17. Key Words</b> Intelligent vehicles, vehicle sharing, risk analysis, policy analysis, safety and security, passengers, behavior		<b>18. Distribution Statement</b> No restrictions.	
<b>19. Security Classif. (of this report)</b> Unclassified	<b>20. Security Classif. (of this page)</b> Unclassified	<b>21. No. of Pages</b> 42	<b>22. Price</b> N/A

## **About the UC Institute of Transportation Studies**

The University of California Institute of Transportation Studies (UC ITS) is a network of faculty, research and administrative staff, and students dedicated to advancing the state of the art in transportation engineering, planning, and policy for the people of California. Established by the Legislature in 1947, ITS has branches at UC Berkeley, UC Davis, UC Irvine, and UCLA.

## **Acknowledgements**

This study was made possible through funding received by the University of California Institute of Transportation Studies from the State of California via the Public Transportation Account and the Road Repair and Accountability Act of 2017 (Senate Bill 1). The authors would like to thank the State of California for its support of university-based research, and especially for the funding received for this project. The authors would also like to thank undergraduate research assistants Jamie Oka and Timothea Wang for their literature review and design contributions, Steph Phillips and Lily Byrne from Lyft for their time and feedback, and Sanaea Kakalia, Devin Jacobsen, and Franky Kwan for choosing our topic for their industrial design studio project.

## **Disclaimer**

The contents of this report reflect the views of the author(s), who are responsible for the facts and the accuracy of the information presented herein. This document is disseminated under the sponsorship of the State of California in the interest of information exchange. The State of California assumes no liability for the contents or use thereof. Nor does the content necessarily reflect the official views or policies of the State of California. This report does not constitute a standard, specification, or regulation.

# Is It OK to Get in a Car with a Stranger? Risks and Benefits of Ride-pooling in Shared Automated Vehicles

---

UNIVERSITY OF CALIFORNIA INSTITUTE OF TRANSPORTATION STUDIES

February 2019

**Angela Sanguinetti**, *Research Environmental Psychologist, Plug-In Hybrid & Electric Vehicle Research Center, Institute of Transportation Studies, University of California, Davis*

**Beth Ferguson**, *Assistant Professor, Department of Design, University of California, Davis*

**Ken Kurani**, *Associate Researcher, Plug-In Hybrid & Electric Vehicle Research Center, Institute of Transportation Studies, University of California, Davis*

*[page intentionally left blank]*

## TABLE OF CONTENTS

Executive Summary.....	iv
Background .....	1
Risks of Pooled SAVs and Design Solutions .....	7
Personal Space .....	7
Security .....	9
Control and Convenience.....	11
Benefits of Pooled SAVs and Design Supports.....	14
Restorative Environments.....	14
Vehicles for Social Capital .....	17
Research Agenda.....	21
Deeper Dive into Consumer Perceptions .....	22
Quantifying Perceived Risks and Benefits and Intentions to Use.....	23
Discrete Choice Experiments with Pooled SAV Design Features.....	23
References .....	25
Appendix A: Student Projects .....	29

## List of Tables

Table 1. SAVs in Operation .....	1
Table 2. AV Car Design Concepts .....	4
Table 3. AV Shuttle Design Concepts .....	6



**List of Figures**

Figure 1. Seat Squeeze .....8

Figure 2. Flip-up Seating ..... 12

Figure 3. Mitigating the Risks of Ride-Pooling in SAVs ..... 13

Figure 4. Natural Interiors..... 15

Figure 5. Public Transport as Art Canvas ..... 15

Figure 6. Augmented Reality Windshield. .... 16

Figure 7. Flexible Seating ..... 19

Figure 8. Creating Benefits for Ride-Pooling in SAVs..... 20

## Executive Summary

Estimates of the effects of deploying large fleets of shared automated vehicles (SAVs) vary from large negative effects (more and longer trips) to large positive effects (more accessible mobility and reduced traffic, emissions, and energy use). For example, if SAVs replace private light duty passenger vehicles without an increase in riders per vehicle, and make travelling easier and/or more affordable, vehicle-miles-travelled per capita may increase. In addition, if light duty passenger SAVs become an affordable and convenient alternative to public transportation, public transit users may shift to SAVs, putting more vehicles on the road. Thus, the actual impacts of SAVs will depend, perhaps quite heavily, on users' willingness to share rides (i.e., ride-pool). There are many factors that could inhibit potential SAV users' willingness to ride-pool, such as sacrifices in comfort and travel time, as well as perceived and real threats to physical safety and privacy.

We currently know little about what to expect regarding ride-pooling in SAVs. Who will be willing to share rides, with whom, and under what conditions? What can be done to encourage ride-pooling in SAVs? Answers to these questions are required to produce credible estimates of, and maximize, the potential for SAVs to affect passenger travel and its economic, energy, and emissions consequences. This report details the efforts and results funded by two seed grants that converged on these questions.

One seed grant was focused on understanding the dimensions of personal space and privacy in SAVs and their implications for riders' comfort and safety. The main objective was to develop a research agenda. Tasks included reviewing relevant literature on personal space and related topics, particularly in the context of shared transportation, in order to understand how it might influence consumer uptake of ride-pooling in SAVs. The other seed grant supported an exploration into potential design solutions for promoting ride-pooling in SAVs. Tasks included incorporating this topic into an undergraduate industrial design studio course, supporting student projects, and highlighting promising design concepts.

Both seed grants enabled us to network with potential industry partners and solicit their feedback as we developed our research agenda, thus improving our chances of securing future funding. These conversations influenced the focus of our research agenda. Specifically, we incorporated considerations of the potential human and social benefits of ride-pooling in SAVs.

This report presents: (a) a literature review to aid understanding the potential dimensions of personal *and* social space in SAVs, (b) potential design solutions to mitigate risks and to maximize user benefits, and (c) a proposed research agenda. This report can inform SAV designers, policy-makers, private transit service providers, and other stakeholders of behavioral factors that will impact ride-pooling in SAVs.

Through review of relevant literature, we identified the following potential dimensions of the pooled SAV experience that could present risks to users: personal space, security (physical safety and data privacy), and control and convenience. Design features that could help mitigate

these risks include large windows to afford a high degree of visibility into and out of the vehicle, spacious seating and legroom (relative to larger shared vehicles like buses, trains, and planes), seats oriented forward with individual armrests, a real-time map-based navigation display, access to a remote human administrator who can observe inside the vehicle at all times, personal climate and lighting controls, good lighting so all passengers can observe each other, access to an emergency button or switch at all times for all passengers, easy means to program private stops that are nearby one's ultimate origins and destinations, and options for large groups or associations to "own" a particular vehicle (e.g., a female only SAV).

Drawing on popular literature about pooled ride-hailing, as well as a variety of social and environmental psychology concepts and theories, we discuss the potential benefits of pooled SAVs in two categories: SAVs as restorative environments and SAVs as vehicles for social capital. Features that create a sense of being away from one's daily routines, positive distractions, and opportunities for leisure and fun could create a restorative experience to let riders relax and elevate their mood. These could include themed interiors, quizzes, games and ambient entertainment, augmented reality windshields, and natural elements. Features that enable and encourage social interaction, highlight what riders have in common, and celebrate local diversity can help generate social capital. These include allowing riders to face each other, accommodating food and drink, ensuring broad access, and making SAVs a canvas for local art.





Our proposed research agenda to further explore potential dimensions of personal and social space in SAVs includes three methods of data collection: (1) Qualitative research to explore and expand on the potential risks and benefits of pooled SAVs suggested and hypothesized in our review; (2) Survey research to quantify the prevalence of perceived risks and benefits identified/confirmed in (1) and their influence on consumers' willingness to use pooled SAVs; and (3) Experimental research to assess the impact of design features on willingness to use pooled SAVs. In addition to these data collection methods, we hope to continue to engage students in industrial design courses to create solutions for sustainable future mobility via pooled SAVs. We would also continue to update our literature review on consumer risks and benefits of the SAV ride-pooling experience, as well as broader research on similar issues in the context of other travel modes.

## Background

Projections of the future of urban transportation suggest the convergence of “three revolutions”—vehicle electrification, automation, and shared mobility—could halve global CO<sub>2</sub> emissions by 2050 (Fulton, Mason, and Meroux, 2017). However, the impact of any initiative to enhance sustainability of transport systems involves human behavior, and thus is a function of both technical potential and behavioral plasticity (Stern, 2011). Behavioral plasticity refers to the degree to which consumers will actually adopt new technologies and practices.

The present research focuses on shared automated vehicles (SAVs). More particularly, we focus on SAVs operating at the Society of Automation Engineer’s (SAE’s) level 5 automation, i.e., vehicles that have no human driver. Early deployments of such vehicles include short, fixed route shuttles (e.g., first- and last-mile routes in city centers). Recently, SAVs are expanding into ride-hailing services—sometimes called “robo-taxis.” Waymo, developed by Google and now its own subsidiary, is the first to launch a project like this, but Daimler-Bosch and GM also plan to launch fleets of automated, driverless taxis by 2020. Table 1 lists early SAV deployments.

**Table 1. SAVs in Operation**

Project Name	SAV Model & Manufacturer	Date Started and Location(s)	Route	Passenger Capacity
Waymo 	Chrysler Pacifica Hybrid mini-van	2017: Phoenix, AZ 2018: Cities in WA, CA, TX, MI, GA	Dynamic ride- hailing	7
ParkShuttle 	Connexion	2006: Rivium, Netherlands	Fixed (1800 meters)	22
CityMobil2, and other 	EasyMile EZ10	2014: Temporary pilots or ongoing deployments in 20 countries	Fixed	10 or 15
Olli 	Olli	2016: Chandler, AZ; Knoxville, TN; National Harbor, MD; Tempe, AZ	Fixed	8

A particularly important case of behavioral plasticity with respect to these SAVs is whether and under what conditions people who currently or would otherwise travel by private car will

share part of their trip in an automated vehicle with strangers. We refer to this case as *ride-pooling in SAVs* or *pooled SAVs*, which involve sharing a part of a trip in one vehicle, as distinct from other modes considered “shared” that involve sharing a vehicle for separate trips (e.g., ridesharing as a synonym for ride-hailing, car-sharing, or bike-sharing). Ride-pooling is critical to achieving the carbon reductions outlined in Fulton et al. (2017). Thus, understanding behavioral plasticity with respect to sharing rides in SAVs with strangers is essential to credible estimates of impacts on passenger travel and its energy and emissions consequences.

We currently know little about prospective SAV users’ willingness to ride-pool. The few studies that have addressed the issue show little willingness to adopt such ride-pooling. For example, Piao et al. (2016) and Bansal and colleagues (Bansal and Kockleman, 2018; Bansal, Kockleman, and Singh, 2016) surveyed public opinion (in France and Texas, respectively) and both arrived at the same statistic: 16% of survey respondents were agreeable to something like pooled SAVs. (Piao et al. asked about using automated cars for car-sharing/pooling schemes; Bansal et al. asked who was comfortable sharing a ride with a stranger.)

Research on analogous travel modes can also provide insights about who might use pooled SAVs. Carpooling, particularly pooled ride-hailing (e.g., Lyft Line and UberPool), is comparable to pooled SAVs. In pooled ride-hailing, the user elects to share parts of their ride with a stranger for a discounted service fee. Ride-hailing companies are likely to be early adopters of AVs since they will enable the same service without the need to pay drivers.

However, it is not reasonable to assume that consumers of these analogous modes will be more prone to use pooled SAVs. For example, a dynamic ridesharing carpool system at University of Washington drew a different clientele than a conventional carpool system (Dailey, Loseff, and Meyers, 1999).

In a recent survey about ride-hailing in the most populous US metropolitan statistical areas (Dawes, 2016), 52% of respondents said the option to save money by sharing a ride with other passengers made them want to use Uber or Lyft more often, but 14% said it made them want to use Uber or Lyft less. Henao (2017) suggested that early users of Uber and Lyft pooled services did not actually wish to share, but were willing to gamble on the chance of sharing (hoping they would not get a match) in order to take advantage of the discount.

Krueger, Rashidi, and Rose (2016) combined the two above approaches of surveying prospective SAV users and considering whether they would be switching to pooled SAVs from comparable (versus dissimilar) modes. Their results suggested public transit users would be keen to *stop* riding with strangers if the SAV solo-rider option were available (by shifting away from public transit), but they would not be more likely than others to use pooled SAV services. On the other hand, Krueger et al. found that users of carsharing services were more likely than others to use pooled SAVs.

In sum, there is reason to believe solo-ridership in SAVs may be much more prevalent than ride-pooling if both options are available, even among travelers of comparable current modes.

There are many factors that could inhibit potential SAV users' willingness to ride-pool, such as sacrifices in comfort and travel time, as well as perceived and real threats to physical safety and privacy. Research is needed to understand how these factors may influence different segments of the population in different trip contexts. The results could inform strategies to mitigate the risks of pooled SAVs.

In addition to understanding the risks of pooled SAVs for prospective consumers, it is important to consider potential benefits—especially for those who currently travel by private cars. Relative advantage of an innovative technology compared to alternatives, as perceived by the consumer, is an important factor contributing to adoption (Rogers, 2010). In fact, perceived benefits often outweigh perceived risks when consumers are assessing new technologies; that is, if they see benefits they will be less concerned about the risks (Starr, 1969). This has been found in a comparable context of connected home technologies, where consumers who perceived more benefits were less concerned with data privacy and security (Sanguinetti, 2018).

Benefits of pooled SAVs include reduced traffic congestion and pollution, but these are indirect consequences for individual consumers. Direct, immediate benefits are needed to support adoption of new behaviors (Cooper, Heron, and Heward, 2007). Pricing schemes can incentivize ride-pooling. However, using financial incentives exclusively to promote ride-pooling is insufficient, as they will likely be negligible for many potential users, and riders who cannot afford a solo-rider option might feel exposed to uncomfortable and unsafe conditions.







Additionally, lowering prices for pooled SAVs may increase their competition with public transportation. There could also be human and social benefits to pooled vs. private SAVs if the pooled options provide innovative amenities or services that support occupants' preferences and desired activities during a ride.

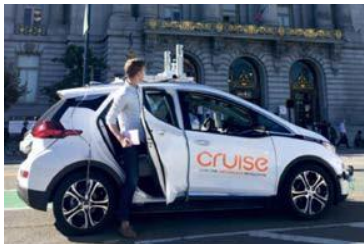

Since pooled SAVs do not exist outside a few small demonstration programs, there is a critical opportunity to inform their design to create the most positive experience while mitigating risks. Although this topic has started to receive some attention, most new design concepts for light duty passenger AVs are not geared towards pooling. Tables 2 and 3 list some early AV design concepts.

The present research reviews relevant literature to understand dimensions of the pooled SAV experience that could influence prospective users' willingness to ride-pool with strangers. First, we consider dimensions related to risks and potential design solutions to mitigate those risks. Then we consider dimensions related to benefits and potential design supports to achieve those benefits. There are numerous design considerations for AVs and SAVs in

general, but we are concerned specifically with dimensions that may have particular relevance to pooling. Finally, we articulate a research agenda to answer questions and test hypotheses emergent from this review.





**Table 2. AV Car Design Concepts**

Concept	Design	Passenger Capacity	Unique Design Features
IDEO		4	-Swivel seats -Glass shell
Renault Ez-Go		6	-Sofa-type seating in a semicircle -Glass panorama roof -Large windows -Large entrance / exit door that is wheelchair and stroller friendly
GM Cruise AV		6	-Conventional design -Has steering wheel and brake
Smart Vision EQ ForTwo		2	-Mini size -Personalization (user's name displayed on the front of the car)
Renault Symbioz		4	-Contemporary living room feel -Swiveling arm chairs -Expansive windows -Coffee table
Audi Aicon		2-4	-Seats can slide back and forth to change car from 2 to 4-seater. -Similar to first class airline cabin

Concept	Design	Passenger Capacity	Unique Design Features
Volkswagen Sedric		4	<ul style="list-style-type: none"> <li>-Flip-up seat for extra space</li> <li>-Transparent LED display on windshield enables augmented reality</li> <li>-Spacious interior, warm colors create a train cabin feeling</li> </ul>
Waymo		7	<ul style="list-style-type: none"> <li>-Conventional design (hybrid minivan by Fiat Chrysler)</li> </ul>
MOIA Volkswagen		6	<ul style="list-style-type: none"> <li>-Personal USB ports</li> <li>-Personal lighting controls</li> </ul>



**Table 3. AV Shuttle Design Concepts**

Concept	Design	Passenger Capacity	Unique Design Features
EasyMile's EZ10		15	<ul style="list-style-type: none"> <li>-8 seats and standing room for 7</li> <li>-Designed for very short distances</li> <li>-Mobility access ramp</li> </ul>
Johnny Culkin mini Routemaster		16+	<ul style="list-style-type: none"> <li>-Seats and standing room</li> <li>-Cargo affordances</li> </ul>
Olli		8	<ul style="list-style-type: none"> <li>-Seats and standing room</li> <li>-Bench seating</li> <li>-Interactive display</li> <li>-Cameras with remote human monitor observing at all times</li> </ul>
e-Palette Toyota		12+	<ul style="list-style-type: none"> <li>-Bus-like design</li> <li>-Multi-use (ride-hailing, delivery service, or mobile shop)</li> <li>-Standing room</li> </ul>
Volkswagen I.D Buzz		8	<ul style="list-style-type: none"> <li>-Described as a "tablet on wheels"</li> <li>-Moveable center console</li> <li>-Flexible seating arrangement</li> <li>-Full skylight roof</li> </ul>

## Risks of Pooled SAVs and Design Solutions

Dimensions of the pooled SAV experience that could pose real or perceived risks to users include jeopardy of personal space, security, control, convenience, and affordances for riders prone to motion sickness. This section defines these dimensions, reviews relevant literature, and poses potential design solutions.

### Personal Space

Sommer (1969) defined personal space as follows: “The emotionally-tinged zone around the human body that people feel is ‘their space.’ Its dimensions are not fixed but vary according to internal state, age, culture, and context.” Hall (1966) defined four levels of interpersonal distance (each with a close and far phase): intimate, personal, social, and public. For Americans, the measured averages of these differences are: less than 18 inches for intimate, 1.5–4 feet for personal, 4–12 feet for social, and 12–25 feet for public. Intimate and personal distances are considered within one’s personal space.

On average, Americans’ personal space is infringed upon when a stranger comes within 4 feet. This happens in virtually all forms of public transportation, and in cars with multiple passengers. We don’t feel uncomfortable in cars with people we know because we are comfortable with them at intimate or personal distance. Some typical spatial dimensions for seating in public transport and other public places are provided in Figure 1.

In public transportation, we have personal defense mechanisms that mitigate the discomfort we feel when our personal space is violated. Personal defense mechanisms include closed body language, body orientation away from others (e.g., facing forward rather than toward other passengers in an elevator), and avoiding eye contact. This is called “civil inattention” and serves to avoid making others uncomfortable when you are too close to comfortably engage with them socially (social distance). However, these strategies do not *eliminate* discomfort. For example, Evans and Wener (2007) found that train passengers experienced stress as measured by multiple indices (self-report, salivary cortisol, performance after effects) when they had to sit close to other passengers; overall density of the train car did not have these adverse effects.

Interpersonal distance is not the only consideration for personal space. Seating configuration also plays a role, and can help mitigate the discomfort experienced when within personal or intimate distance of a stranger. The recent redesign of train cars for the San Francisco Bay Area Rapid Transit (BART) provides an example (Marshall, 2016). The rows of two seats are oriented forward rather than facing each other, which was causing discomfort (harder to avoid eye contact). This is called sociofugal design, which discourages social interaction, and was deemed desirable for BART because it is used mainly by solo commuters.

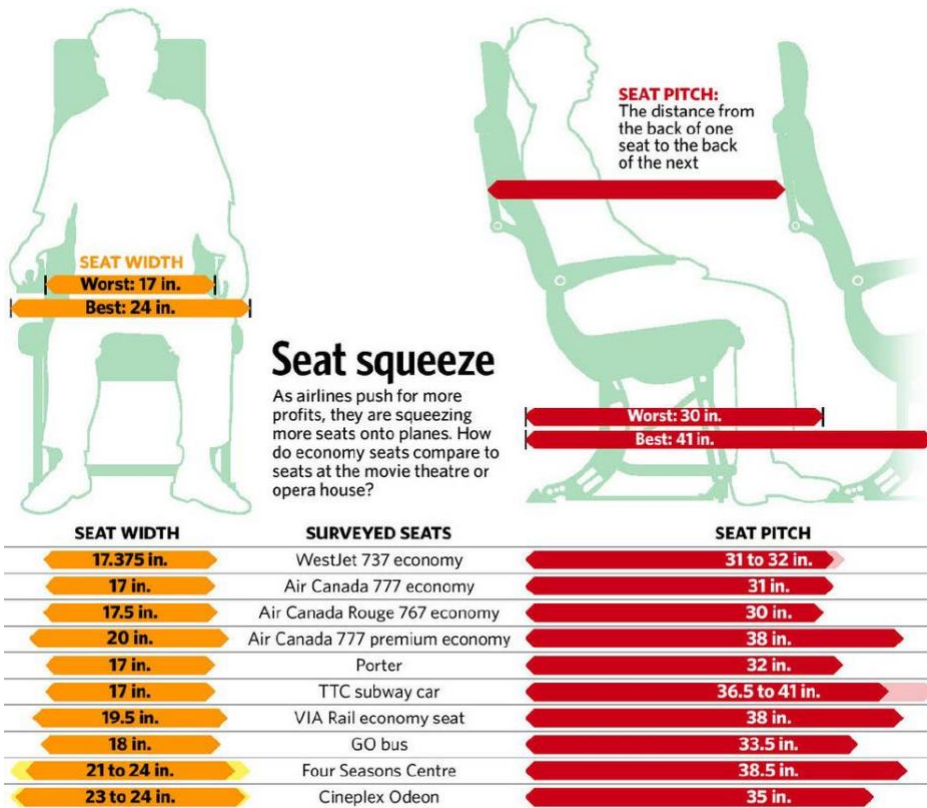

## Six Seat Strengths

NEW BART SEATS TO EASE YOUR RIDE



**Figure 1. Seating Design Considerations**

Sources: (top) Toronto Star, (bottom) bart.gov/news/articles/2016/news20160616-0

Time also interacts with proxemics (spatial distances and configurations) to impact perceptions of personal space in public transit. It is easier to tolerate short periods of crowding. Subway stops give momentary relief from crowding as passengers get off and others get on. Elevators are similar to conventional passenger vehicles in terms of size, but we only share those with strangers for brief periods and there are strict norms of civil inattention that would be stressful to maintain for longer periods.

Perception of crowding and violations of personal space may be more likely when sharing space with strangers in a car or small shuttle (compared to most public transport vehicles), and for prolonged periods of time (compared to an elevator). Thus, it is critical to consider design strategies to protect personal space. “Territorial props” are one such strategy, such as armrests and tables, that increase perceptions of protected personal space (Evans and Wener, 2007). Merat et al. (2017) noted that current examples of pooled SAVs (typically 8-10 passenger shuttle buses) have not made these kinds of accommodations.

Territorial props in SAVs could include personal armrests (two designated to each passenger, rather than one to be shared between two passengers as is common in airplanes). Some seats could also have tables, e.g., that fold out from the armrests. Personal storage space, perhaps under the seat, could further increase perceptions of ample personal space.

Making provisions to protect personal space in SAVs could mean a trade-off in vehicle efficiency (and fleet owner profits), since these specifications might increase vehicle size and mass. However, if they increase ride-pooling, these increases might be more efficient, profitable, and humane to give people the personal space that encourages/facilitates use of pooled SAVs. More research is required to understand these trade-offs.

## Security

Sharing a ride with a stranger in an SAV could also present risks to users’ security, including their personal physical and emotional safety. Concern about the safety of riding with transportation network company (TNC) drivers has been a barrier for ride-hailing (Chaudhry, El-Amine, and Shakshuki, 2018). That is despite some level of vetting on the part of the TNC, and driver rating systems. In an SAV pooling situation, TNCs would not be able to vet riders as extensively, and likely would not have much incentive to do so. Passenger rating systems have been considered, but limiting access based on passenger reviews could create equity issues.

There are also potential privacy risks related to information co-riders can access about each other, such as home and work locations. This has been discussed in the context of ride-hailing, where drivers have access to passenger information (Pham et al., 2017), and as a broader issue with location-based apps (Myles, Friday, and Davies, 2003). However, ride-pooling adds the additional, new concern of disclosing location information to fellow passengers.

These issues, particularly physical safety, have already received some attention in the literature on SAVs. Piao et al. (2016) surveyed residents of La Rochelle, France, about their attitudes towards the CityMobil2 automated buses that were operating there as a demonstration

project. Safety concerns were common. Evening and nighttime trips were especially worrisome, as was the risk of disclosing travel location. Pham et al. (2017) suggested a system where exact origin and destination information can be kept private. A pooled SAV service could give users the option to enter “private” pick-up and drop-off locations near their actual origin and destination and choose to use those locations as defaults or on a trip-by-trip basis.

Although level 5 SAVs will not need a human operator, the riders may require one to feel at ease—perhaps at least in the early deployments of robo-taxis. In Piao et al., only 40% of the participants who reported being willing to use an automated bus said they would do so without a human supervisor aboard. In contrast, riders of the automated ParkShuttle in Rivium, Netherlands, reported that video surveillance was as acceptable as a human monitor (Dekker, 2017). Front and rear surveillance cameras are being used in some early SAV design concepts. Cameras should be clearly marked, or signage provided, to ensure that passengers are aware of surveillance, per defensible space theory (discussed below). In the Ollie (described in Tables 1 and 3), there is a remote human monitor observing the interior at all times during a ride.

In lieu of the physical presence of a human driver or monitor, a TNC could recruit “ambassadors,” who have been to chaperone pooled SAV rides. (Perhaps these ambassadors could be former drivers now paid for serving this role, or frequent riders incentivized by a discount.) Another interesting option would be a humanoid robot driver. Lee et al. (2015) found that a remote control car was perceived as more intelligent, safe, and trustworthy when it appeared to be controlled by a humanoid robot rather than an iPhone.

An in-person, human remote, or robot monitor, along with well-marked video surveillance, would help create a secure image, which is one of the tenets of defensible space (Newman, 1972)—an environmental design approach to crime prevention. Defensible space theory is a useful framework for considering other SAV design features to mitigate the safety risks of ride-pooling. Other tenets include natural surveillance, milieu, safe adjoining areas, and territoriality.

Natural surveillance refers to eyes on a space, or the ability for people in a space to both see and be seen. Early SAV designs are incorporating large windows (Tables 2 and 3). A focus group study in La Rochelle concerning the CityMobil2 project found that automated bus users appreciated the high degree of visibility afforded by the vehicle’s large windows (Dziennus et al., as cited in Merat, Madigan, and Nordoff, 2017). This is likely because of an impact on perceived defensible space from allowing visibility into as well as out of the SAV. For these reasons, windows in SAVs should not be heavily tinted and interiors should be well-lit.

Natural surveillance in this context will interact with milieu—the location of a space, e.g., its proximity to emergency services. The milieu of a SAV is, of course, mobile, therefore defensible space will vary. It will be greater in bustling city centers where speeds are slower and there are many people around to observe inside the vehicle, and less out on open rural roads or high-speed freeways. Sidewalks and directly adjacent buildings could be designed as safe adjoining areas that enable and encourage visibility into SAVs on the street.

Territoriality in defensible space theory refers to perceived control and ownership of a space. People are more likely to watch out for and report problems when they have a sense of ownership over the space and opportunities to take action to protect it. Creating a sense of ownership is an interesting challenge for SAVs. Limiting a particular fleet to a certain group of people would help (e.g., women-only, similar professionals with verified employer), but might prove difficult for logistical and ethical reasons. Another strategy could be to create identity around the vehicles rather than the passengers, e.g., a person could own a membership, giving them access to a particular type or set of vehicles, which could help the user identify with *his* or *her* SAV (e.g., I use “the pink cars”). If the exact same vehicle could be reliably hailed by the same person, this would be the ultimate use of this strategy to create territoriality.

Creating opportunities to report issues is an easier problem. Other have cited the importance of an emergency button or hotline (Nordhoff et al., 2016b, as cited in Merat, 2017). An emergency stop button at every seat would be necessary to provide easy access to all during travel. SAV service apps could also have easy reporting features. Uber has added safety features to their app, which include allowing users to share trip status with up to five “trusted contacts” so they can know when you arrive safely (with options to share all trips or nighttime only). It also added a “911 assistance” button in some cities that automatically calls 911 and sends the dispatcher your location and trip information.

Some other considerations for enhanced physical safety are handrails to help passengers get around other passengers when entering and exiting, and sensors to prevent doors from closing on slower passengers. Regular maintenance will also be crucial for keeping a tidy SAV; broken windows theory refers to the well-supported phenomenon that dilapidated and ill-kept spaces are more prone to crime because this is a sign that nobody is watching or reporting problems (Wilson and Kelling, 1982).

## Control and Convenience

Cleanliness can also mitigate real and perceived risks of exposure to germs or unpleasant odors and conditions that are of concern with any shared transit system, but more so when sharing a ride in a smaller car with strangers. This is related to perceived control over one’s environment. Perceived control over environmental conditions (i.e., feeling you have the ability to control something whether or not you act on it) mitigates stress responses from aversive environmental stimuli (Averill, 1973; Paciuk, 1990). Barriers related to perceived control will be more pronounced for private car users looking to switch to pooled SAVs compared to public transit users and, perhaps to a lesser extent, for ride-hailers, whose control over environmental conditions in the vehicle is already somewhat limited.

SAV cleanliness can be supported by using non-porous and easy-to-clean (e.g., waterproof) surface materials, for floors, seats, and other interiors. Perceived control of thermal comfort can be enhanced by providing personal controls and vents for air conditioning and heating. Lights at each seat that can be adjusted would also support perceived control. SAV service apps can allow users to report when cleaning is needed and provide other feedback about the vehicle conditions. For example, just the opportunity to provide feedback on thermal conditions

can improve occupants' overall satisfaction with temperatures (Sanguinetti et al., 2016). A map displaying real-time navigation visible to all occupants could also support perceived control by letting passengers know at all times where they are and when they are scheduled to arrive at their destination.

Finally, convenience, efficiency, and reliability are critical qualities of a pooled SAV service that can compete with private vehicles and solo ride-hailing. Longer travel times with pooled SAVs will be a challenge to overcome. Something like carpool lanes could give pooled SAVs an advantage to balance out time delays and possibly even make it the more expedient mode.

We do value time as money to a degree, but we are much less willing to gamble with time (Leclerc, Schmitt, and Dube, 1995). Consumers may be persuaded to accept longer travel times to save money, but it would be a much tougher sell to get people to accept additional uncertainty in travel times. Therefore, it is critical that pooled SAVs be as reliable as possible. Reliability also requires efficiency, so loading/unloading times for multiple passengers should be predictable and short.

This means getting on and off should be easy for all riders, with minimal height difference between the floor of the car and the curb. Flip-up seating in SAV designs help to accommodate physically-challenged people, those with wheelchairs, walkers, baby strollers, and other necessary cargo (Figure 2). Cargo should be accommodated in the vehicle (e.g., personal storage space under each seat), rather than an exterior trunk, perhaps with the option to reserve extra space as needed, or hail a specialized SAV designed for passengers with more cargo.

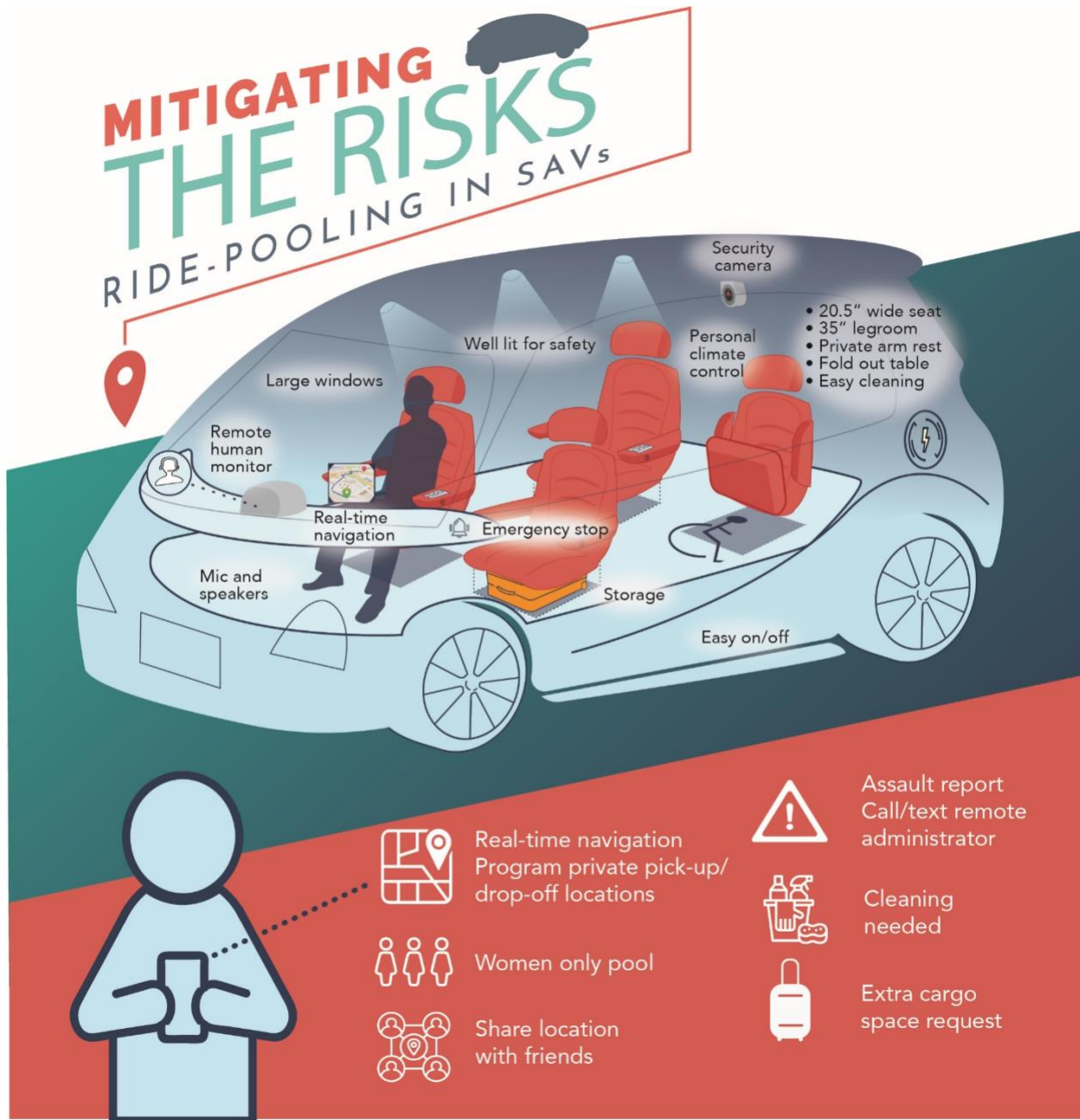

**Figure 2. Flip-up Seating**

*Designer and Source: The Volkswagen Sedric Concept SAV ([www.discover-sedric.com](http://www.discover-sedric.com))*

Private vehicles have a strong relative advantage in terms of cargo affordances. Not only can people travel with more cargo, they can also use their vehicle for all-day convenient storage. Pooled SAVs could potentially offer locker space if they could guarantee the same vehicle would be available to a particular user at different times of the day (e.g., commute to work, then gym, then home). This would also enhance territoriality.

Figure 3 summarizes and illustrates the design features we hypothesize would mitigate risks of ride-pooling in SAVs and thus increase prospective users' willingness to use this new mode.



**Figure 3. Mitigating the Risks of Ride-Pooling in SAVs**  
 Created by Jamie Oka, Beth Ferguson, and Angela Sanguinetti.



## Benefits of Pooled SAVs and Design Supports

Car interiors have historically been relatively minimalistic, although technological advances have led to increasing digital entertainment provisions for passengers. Cars can almost be considered “liminal spaces,” which are transitional and thus do not require a lot of environmental supports for user activities (apart from vehicle controls for the driver). More definitional examples of liminal spaces are stairways, hallways, and parking lots.

With automated vehicles (AVs), there are myriad opportunities for new car interior design that would benefit the rider. However, most of the creative activity in this domain is focused on private vehicles, as illustrated by the title of this New York Times article: “Envisioning the car of the future as a living room on wheels” (Taub, 2017). Creating new benefits for pooled SAVs requires even more creativity.

In this section we draw on social science concepts and theories to understand potential benefits of pooled SAVs. In considering the relevance of each theory to pooled SAVs, we identified design features that could encourage pooling. The degree to which these features can be integrated into the pooled SAV experience *and not* the solo-AV experience will help create a relative advantage.

### Restorative Environments

Restorative environments are sites that provide relief from stress and accumulated strains on attention (Kaplan, 1995; Ulrich et al., 1991). Pristine nature is the iconic setting for restoration. For example, parks, nature preserves, and gardens have been widely studied as restorative sites; however, built spaces can also be restorative. For example, monasteries, museums, and plazas have also been studied as restorative environments (Abdulkarim and Nasar, 2014; S. Kaplan, Bardwell, and Slakter, 1993; Ouellette, R. Kaplan, and S. Kaplan, 2005).

Two prominent theories describe the mechanisms underlying restorative environments: psychophysiological stress recovery theory (Ulrich et al., 1991) and attention restoration theory (ART; R. Kaplan, 1995). The former describes the role of restorative environments in recovery from stress and illness via effects on the parasympathetic nervous system. ART posits that restorative environments restore capacity to engage in directed (i.e., focused) attention—a capacity that is taxed by daily demands and becomes fatigued.

ART specifies four qualities of restorative environments: Being Away, Fascination, Extent, and Compatibility (R. Kaplan, S. Kaplan, and Ryan, 1998; Kaplan, 1995). Being Away refers to physical or mental distance from daily stressors. Compatibility refers to the degree to which the environment matches the user’s needs. Fascination, or Soft Fascination, gives people the opportunity to focus their attention with little effort, allowing their mind to wander and relax. Extent refers to scope and coherence; scope can create a sense of mystery by suggesting there is more to explore, while coherence means that elements of the site make sense together, creating a legible environment that people can understand.

AVs, including pooled SAVs, could be designed to function as restorative environments. Some design concepts are already moving in this direction. For example, Figure 4 shows a design by BMW that incorporates nature (i.e., lots of wood surfaces and moss growing beneath the seats). Natural elements can add to a sense of Being Away, Fascination, and Extent.



**Figure 4. Natural Interiors**  
*Source: Taub, 2016; design by BMW.*

Other features that support a sense of Being Away and Fascination could include themed and artistic interiors. For example, subway cars in Taipei, Taiwan, were redesigned with sports themes (Eldredge, 2017), giving riders a sense of being in a different place away from daily demands. The cars also incorporated interesting facts about the sports. The swimming pool car quickly became a favorite setting for selfies (Figure 5). Water is another natural element that is often featured in restorative environments.



**Figure 5. Public Transport Designed with a Sports Theme**  
*Source: Eldredge, 2017.*

Augmented reality (AR) is a sure way to expand the scope of pooled SAVs, and thus the quality of Extent. Apple is already working on an AR windshield for AVs (Soltero). AR could be extended around all windows of the vehicle; large windows could also support scope. Figure 6 shows how augmented reality could also add legibility to the environment by labeling points of interest. If riders are interested in particular types of locations, they could request to have those locations identified in a 360-degree augmented reality screen, perhaps via in-vehicle voice assistance; this would contribute to Compatibility.

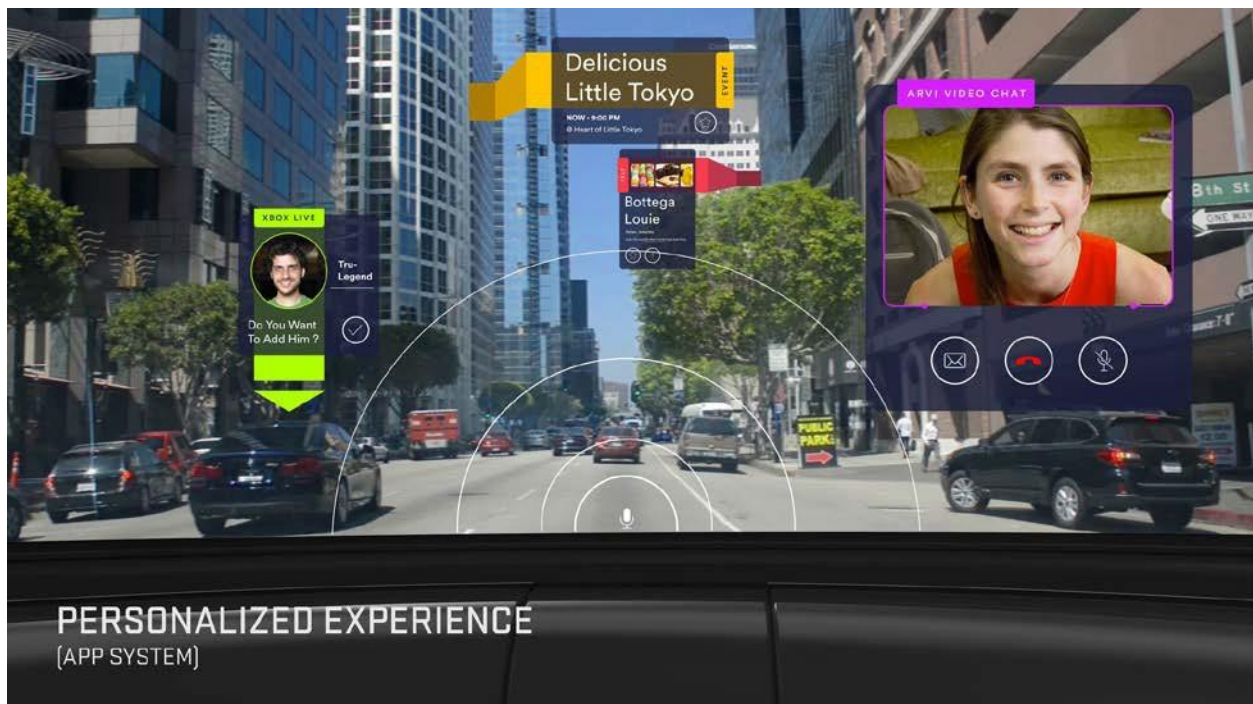

**Figure 6. Augmented Reality Windshield**

*Source: Taub, 2016.*

Other ways to increase Compatibility could include allowing users to create a profile on the pooled SAV service app with preferences for entertainment (music, podcasts, etc.; Nordhoff, Van Arem, and Happee, 2016). The service could find commonalities between passengers regarding these preferences and provide mutually preferred ambience accordingly. Personal outlets and WiFi could be provided for private entertainment.

Compatibility can be considered apart from the idea of restoration. For example, features could support riders who want to work in the vehicle (WiFi, outlets, lighting, and tables). Working is not restorative (it requires focused attention), but if it is how the rider wishes to use their travel time, he/she will be more inclined to choose a travel mode that supports the activity.

Riders might also wish to socialize, which can contribute to restoration and improve general mood. For example, Epley and Schroeder (2014) found that talking to strangers during public transit made for a more positive experience. We now turn to an exploration of SAVs as social spaces.

## Vehicles for Social Capital

Early observations of Lyft's and Uber's pooled ride-hailing services included that many riders do not actually wish to share; rather, they are just willing to gamble on the chance of sharing (hoping they don't get a match) in order to take advantage of the discounted service fee attached to a pooled ride (e.g., Henao, 2017). On the other hand, there has been a recent surge in media stories suggesting these services have interesting social benefits. Many of these stories compare UberPool and Lyft Line (now Lyft Shared) to popular social media dating and professional networking sites (Tinder and LinkedIn, respectively).

One article (CBS8, 2018) reports on a recent survey (September 2018) of over 1,000 ride-hailers. Although less than half of the participants had used pooled ride-hailing, over 30% of those who had, reported making a useful social connection on a shared ride. This suggests the social benefits of pooled ride-hailing could be quite prevalent and potentially motivate SAV users to share rides.

Uber had a program called UberENTREPRENEUR in 2015 that encouraged small business owners to drive for Uber to promote their business, and encouraged riders to ask their driver about it. Despite this early example of leveraging social benefits of ride-sharing and the growing body of anecdotal evidence in popular media, there has been virtually no academic research on the topic. However, social science theories can help us understand these phenomena.

First, the concept of social capital is relevant. Social capital (SC) refers to the social networks characterized by mutual trust, cooperation, and reciprocity (e.g., exchanging of goods and services) that contribute to community, culture, and economy (Putnam, 2000). Putnam described the deterioration of social capital in the US and how urban sprawl has contributed to its decline because people spend lots of time alone in their private cars.

Currie and Stanley (2008) theorized implications of public transit (i.e., pooled travel) for social capital. Pertinent to our topic, they noted that public transport creates opportunities for social interaction: "While interactions with others on public transport are probably not very 'deep' or 'strong,' these interactions represent some of society's most extensive opportunities to interact with people outside the individual's common social circles. As such, it has good potential for developing bridging SC." Bridging SC refers to the spreading of resources between networks, "allowing people to access multiple networks and therefore resources and opportunities."

Evans and Wener (2006) found that commuter stress, e.g., related to unreliable train service or delays, prompted strangers to interact more frequently. Although commiserating about a shared frustration or collaborating about potential solutions could help build social capital, unreliability in a pooled SAV service would also discourage use. However, the environmental psychology concept of triangulation (Whyte, 1980) via "triangulating features" could accomplish the same function in a purely positive manner.

Triangulation, identified by Whyte in the context of small urban plazas, is when some shared stimulus prompts strangers to interact. Features like a sculpture or live performers can create a

social bond around a shared experience. An SAV could incorporate work of local artists, contributing to community identity and providing triangulation. The Taipei subway sport themes are an excellent example. That project was commissioned to drive interest and publicity for the Universiade international sport event that Taipei hosted—building community around the event.

Another concept that is relevant to designing SAVs for social benefits is the idea of third places (Oldenburg, 1989). A third place, in relation to home as the first place and work as the second, is a public place where people socialize. Oldenburg argued that individuals derive part of their identity and fulfillment from participating in third places, and that third places are foundational to a democratic society. Third places foster social capital.

SAV design could be guided by characteristics of third places to promote social interaction and social capital. These characteristics include a welcoming and comfortable atmosphere for all, which could have a playful tone. Warm lighting and comfortable seats could make SAVs welcoming. Themed designs could be relevant here again, which might include cultural themes to celebrate diversity in a community. Cooperative games and trivia could be designed into SAVs, reminiscent of the popular show *Cash Cab* that took place in New York City taxis.

Accessibility is crucial for third places, which are typically free or inexpensive and open to all public. Costs associated with different types of SAVs should not create or exacerbate equity issues that result in segregation of riders by socioeconomic characteristics. SAV design features for accessibility mentioned previously include seats that fold away to allow room for wheelchairs, strollers, walkers, etc.

In third places, one typically sees familiar faces, but also new ones. SAV services could give users the option to select other riders in their pool (co-workers, friends made on pooled rides, etc.). They could also offer incentives for “bringing a friend.”

Finally, third places often have food and drink available. This may not be practical for SAVS (though one could imagine the popularity of a Starbucks SAV), but cup holders, tables, and perhaps small vending machines could be included. The cost of these amenities in terms of SAV maintenance and its impact on rider fees would need to be considered.

For our final consideration, we come full circle back to the principles of proxemics. Just as personal space is influenced by interpersonal distances, seating orientations, and territorial props, so is social space. As previously noted, a general guideline for social space when face-to-face is 4-12 feet. When sitting much closer together, especially in the absence of territorial props, SAV riders may not feel comfortable socializing (and may instead engage in civil inattention).

Many AV designs are envisioning seating orientations where passengers face each other, which is conducive to social interaction (Figure 10). This is called sociopetal design, as opposed to sociofugal design, which deters social interaction (e.g., sitting back to back). Diels et al. (2017) distinguished “a ‘stagecoach’ or ‘shared space’ model of SAV seating, which facilitates social

interactions, for example by positioning seats towards each other, versus a ‘cocoon’ or ‘individual space’ model which emphasizes the independence and isolation of the individual,” and noted “of particular interest may be the ability to swap between these two experiences” (p. 6). Swivel seats in design concepts by Ideo and McKinsey are intended to create this flexibility (Figure 7). A practical concern with orienting seats different ways is a probable higher level of carsickness (Diels et al.).



**Figure 7. Flexible Seating**

*Designer and source: Ideo (left) and McKinsey (right).*

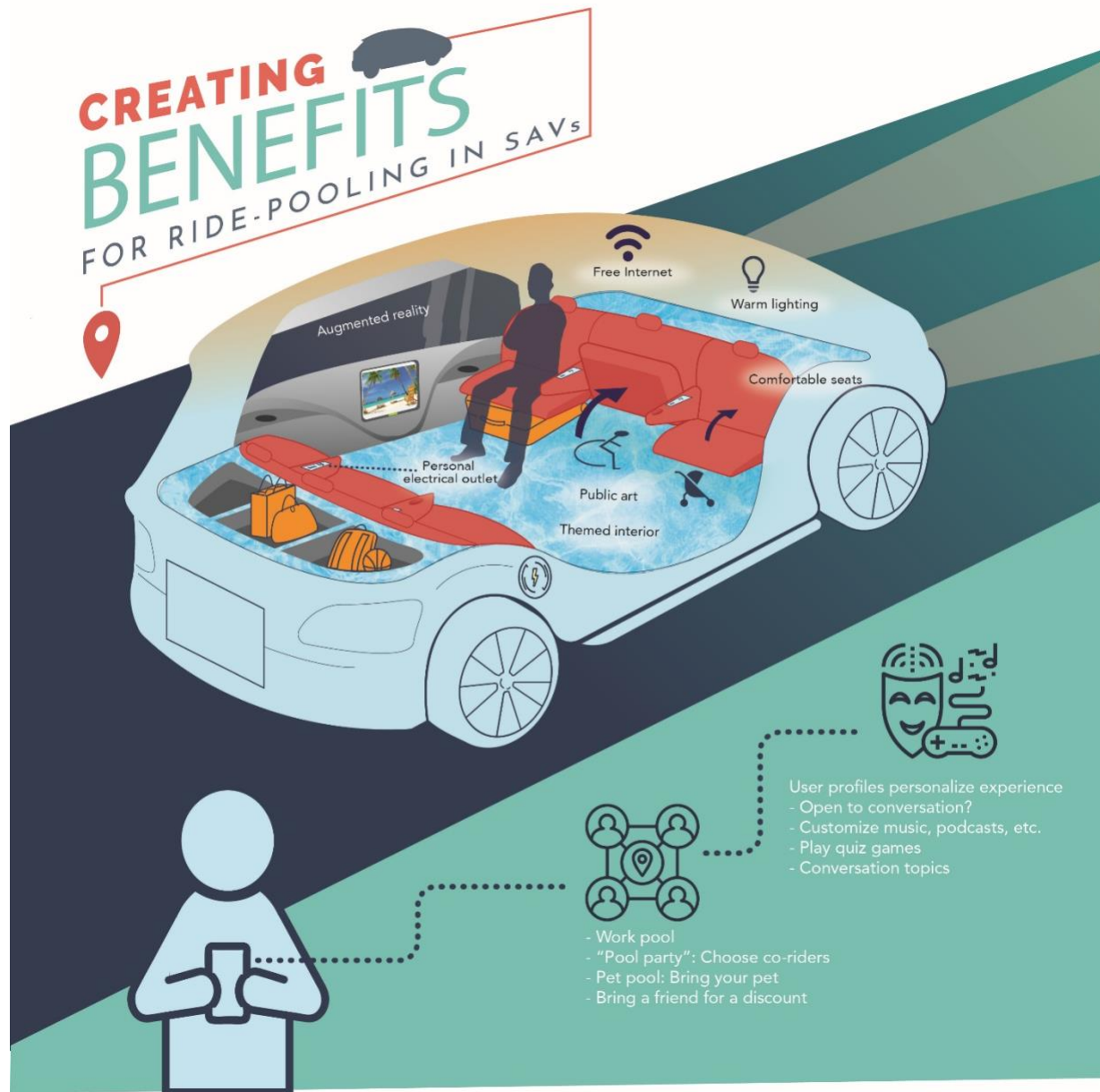

**Figure 8. Creating Benefits for Ride-Pooling in SAVs**  
 Created by Jamie Oka, Beth Ferguson, and Angela Sanguinetti.

## Research Agenda

As a preliminary to our research agenda, we first summarize the limitations of our review above in understanding the potential for consumer adoption of pooled SAVs. First, we noted that there is a lack of qualitative research examining the perceptions, attitudes, and needs of different consumer groups that will be expected to switch to pooled SAVs for the benefits of this new technology to be actualized. For example, the issues are likely to be very different for predominantly private vehicle drivers compared to those who regularly use ride-hailing or to multi-modal consumers.

Second, it is difficult to predict how many people would be willing to ride-pool in SAVs since the mode currently exists only in limited contexts. Some research has examined users' and non-users' responses to small-scale SAV projects involving 8-10 passenger buses that travel at low speeds on short first/last mile routes in dense urban areas in European cities (Dekker, 2017; Piao et al., 2016). However, the results of these studies may not generalize to other contexts (ride-pooling for longer trips in smaller vehicles in the US). Surveys of consumers without experience of pooled SAVs have not been clear about the visuals and language used to expose participants to the concept of pooled SAVs (Krueger et al., 2016), or they portrayed a specific intimate design (Becker and Axhausen, 2017); these response primes should be expected to heavily influence responses. Until there are more real-world SAV examples, more creative, carefully considered, and immersive strategies are needed to introduce consumers to the concept of pooled SAVs and then more accurately gauge their attitudes and intentions toward this emerging travel mode.

Finally, we noted that insights can be gleaned from analogous travel modes, such as public transportation, pooled ride-hailing, and even elevators. Pooled SAVs may be introduced on a large scale first by TNCs, due to the potential profit of removing the driver from ride-hailing services. Furthermore, pooled ride-hailing services represent the closest analogy to pooled SAVs and thus should be further studied to help form expectations and strategies for pooled SAV adoption. What we currently know about who uses pooled ride-hailing services, under what conditions, and with what motivations, is anecdotal and unsystematic.

Based on these considerations and hypotheses emerging from our review, as well as conversations with ride-hailing companies Lyft and Uber, we developed a research agenda to further investigate potential risks and benefits of pooled SAVs. Our general research questions are:

1. What are consumers' perceptions of risks and benefits of pooled SAVs when considering switching from current modes, e.g., what is the perspective of private car drivers? Of carsharing users? Of carpoolers? Of ride-hailers?
2. What insights can be gleaned about pooled SAVs risks and benefits from users of the closest analogous mode, i.e., pooled ride-hailing?
3. How could pooled SAV design impact consumers' perceptions of risks and benefits?



Answers to these questions are critical for understanding who will pool rides in SAVs and under what conditions.

Our research agenda includes three data collection methods:

1. Qualitative research to explore and expand on the potential risks and benefits of pooled SAVs suggested and hypothesized in our review above;
2. Survey research to quantify the prevalence of perceived risks and benefits identified/confirmed in item 1. and their influence on consumers' willingness to use pooled SAVs; and,
3. Experimental research to assess the impact of design features on willingness to use pooled SAVs.

In addition to these data collection methods, we hope to continue to engage students in industrial design courses to create solutions for sustainable future mobility via pooled SAVs. Appendix A presents the industrial design studio student projects that were sponsored by this seed funding. We would also continue to update our literature review on consumer risks and benefits of the SAV ride-pooling experience, as well as broader research on similar issues in the context of other travel modes.

### **Deeper Dive into Consumer Perceptions**

This phase of our research agenda addresses the aforementioned lack of qualitative engagement by researchers to date with prospective users of pooled SAVs. We will conduct interviews of households or individuals as well as small group interactions such as focus groups or workshops with users of various travel modes, e.g., private automobiles, carsharing, carpooling, and ride-hailing.

This phase has two main goals. The first is understanding the important dimensions of their current travel mode(s) that relate to their prospective attitudes and intentions regarding pooled SAVs, e.g., how they value the qualities of personal space, security, control, convenience, restoration, and sociability in their travel. The second goal is to ask people to design their perceived optimal pooled SAV experience. These activities are not expected to actually produce optimal SAV system designs; rather, they reveal how respondents perceive the potential risks and benefits of SAVs and how they would propose to minimize the former and maximize the latter.

These goals will be addressed in both "personal" and "social" research settings; interviews (personal) and focus groups (social) will be conducted with samples of users of various modes. The use of both personal and social settings allows comparison and contrast of respondents in each setting with the goal of observing changes that occur as respondents move from the former to the latter setting. Such changes may include learning, shifts of values and desires, and changes in their "optimal" vehicle, system performance, and design. In addition, this shift during the research process from personal to social settings may reveal changes required in moving from, say, privately owned cars to pooled SAVs. To be clear, the same respondents will

be interviewed in both a personal setting and invited to participate in a focus. These social research settings would combine respondents with different dominant travel modes. See Kurani et al. 2018 for a prior application of this staged qualitative research design applied to electric vehicles.

### **Quantifying Perceived Risks and Benefits and Intentions to Use**

Our second phase of research would be a survey distributed to users of various transportation modes, with emphasis on drawing a large sample of pooled ride-hailing users. This sample will be national (or at least multi-regional) if sufficient funding is secured, or limited to California if necessary. The overarching aim of this phase is to generalize to larger populations the consumer perceptions of pooled SAVs articulated in the qualitative research described above.

We propose a large survey with stratified sampling to represent users of various transportation modes, including a large sample of pooled ride-hailing users, since pooled ride-hailing is the most comparable travel mode to pooled SAVs that exists currently in the US. We hypothesize these consumers will be more amenable to pooled SAVs than consumers who do not travel by this mode, and we can use the survey to quantify the prevalence of benefits and problems experienced in this analogous mode and understand this group's motivations for choosing the pooling option. We will also survey consumers who use other transport modes, e.g., public transit, private automobiles, and carsharing. We will explore demographic and psychographic predictors of preference for pooled SAVs in these different consumer groups, as well as motivations and conditions under which participants would consider using pooled SAVs (e.g., trip type, trip length, number of other riders, time delays, price differences, etc.).

We will ask participants to consider the prospect of pooled SAVs (with creative visualizations) and report how their transportation choices might be impacted. Based on the interactive gaming techniques pioneered by Kurani, Turrentine, and Sperling (1996) for studying electric vehicles (and subsequently applied across many years and multiple countries, e.g., Axsen, Kurani, and Burke [2010], Axsen and Kurani [2013], and Axsen, Goldberg, and Bailey [2016]), we will design interactive games for use in the survey for respondents to create SAV designs that enhance the probability of broad uptake by travelers.

### **Discrete Choice Experiments with Pooled SAV Design Features**

Since SAVs do not exist outside a few small programs, there is now a critical opportunity to inform the design of the vehicles and services to create the most positive experience for ride-pooling and mitigate threats to personal space, privacy, and safety.

As part of this research, we developed hypotheses about SAV design features that could promote users' willingness to share a ride with a stranger. The third data collection method in our research agenda is a series of experiments to test these hypotheses. We would propose to develop an online testing instrument with creative graphic and/or video displays of SAVs. Using discrete choice analysis, we will calculate potential SAV users' willingness to pay for a pooled ride in a conventionally designed vehicle compared to one with strategic features. Strategic

features will aim to mitigate risks (e.g., large windows for increased visibility and safety) and create benefits (e.g., social opportunities).

The testing interface will resemble a TNC app and include images of SAV design alternatives. Depending on the source(s) and amount of funding, as well as the research partners, we will recruit participants from one or more of the following: UC Davis student body, Amazon Mechanical Turk, TNC users. Participants will be asked to envision various SAV ride-hailing scenarios and prospectively choose whether or not they would share a ride with strangers, and how much they would pay for solo-rider versus pooled options.

Discrete choice analysis will yield a willingness-to-pay metric for various designs or design attributes. Testing may involve both discrete design features (e.g., conventional windows versus large windows to enhance safety by providing a high degree of visibility into the vehicle) as well as composite designs (e.g., a conventional vehicle vs. a vehicle with multiple attributes to mitigate risks to safety and privacy or to increase social opportunities and onboard entertainment). The testing instrument and protocol will also enable future experiments with other vehicle and program design features (e.g., passenger rating systems, travel time estimates).

## References

- Abdulkarim, D., and Nasar, J. L. (2014). Are livable elements also restorative? *Journal of Environmental Psychology*, 38, 29–38. <http://doi.org/10.1016/j.jenvp.2013.12.003>
- Alonso-Mora, J., Samaranayake, S., Wallar, A., Frazzoli, E., and Rus, D. (2017). On-demand high-capacity ride-sharing via dynamic trip-vehicle assignment. *Proceedings of the National Academy of Sciences*. doi: 10.1073/pnas.1611675114
- Averill, J. R. (1973). Personal control over aversive stimuli and its relationship to stress. *Psychological Bulletin*, 80(4), 286.
- Axsen, J. and Kurani K. S. (2013) Hybrid, Plug-in Hybrid, or Electric: What do car buyers want? *Energy Policy*, 61, 532-543.
- Axsen, J., Kurani, K. S., and Burke, A. (2010). Are batteries ready for plug-in hybrids? *Transport Policy*, 17(3), 173-182.
- Axsen, J., Goldberg, S., and Bailey, J. (2016) How might potential future plug-in electric vehicle buyers differ from current “Pioneer” owners? *Transportation Research Part D: Transport and Environment*, 47, 357–370,
- Bansal, P., and Kockelman, K. M. (2018). Are we ready to embrace connected and self-driving vehicles? A case study of Texans. *Transportation*, 1-35.
- Bansal, P., Kockelman, K. M., and Singh, A. (2016). Assessing public opinions of and interest in new vehicle technologies: an Austin perspective. *Transportation Research Part C: Emerging Technologies*, 67, 1-14.
- Becker, F., and Axhausen, K. W. (2017). Predicting the Use of Automated Vehicles. [First results from the pilot survey]. In *17th Swiss Transport Research Conference (STRC 2017)*. STRC.
- CBS8 (2018). “Forget Tinder and LinkedIn. Ridesharing is the new social centre.” Retrieved from: <http://www.cbs8.com/story/39169132/forget-tinder-and-linkedin-ridesharing-is-the-new-social-centre>
- Chaudhry, B., El-Amine, S., and Shakshuki, E. (2018). Passenger Safety in Ride-Sharing Services. *Procedia computer science*, 130, 1044-1050.
- Cooper, J. O., Heron, T. E., and Heward, W. L. (2007). *Applied behavior analysis*.
- Currie, G., and Stanley, J. (2008). Investigating links between social capital and public transport. *Transport Reviews*, 28(4), 529-547.
- Dailey, D. J., Loseff, D., and Meyers, D. (1999). Seattle smart traveler: dynamic ridematching on the World Wide Web. *Transportation Research Part C: Emerging Technologies*, 7(1), 17-32.
- Dawes, M. (2016). *Perspectives on the Ridesourcing Revolution: surveying individual attitudes toward Uber and Lyft to inform urban transportation policymaking* (Doctoral dissertation, Massachusetts Institute of Technology).
- Evans, G. W., and Wener, R. E. (2007). Crowding and personal space invasion on the train: Please don't make me sit in the middle. *Journal of Environmental Psychology*, 27(1), 90-94.

- Evans, G. W., and Wener, R. E. (2006). Rail commuting duration and passenger stress. *Health Psychology, 25*(3), 408.
- Dekker, M. J. Riding a Self-Driving Bus to Work.
- Eldredge, B. (2017, July 19). "Taipei's subway trains get surreal interior redesign." *Curbed*.
- Fulton, L., Mason, J., and Meroux, D. (2017). Three Revolutions in Urban Transportation. *UC Davis and ITDP*.
- Gardner, B., and Abraham, C. (2007). What drives car use? A grounded theory analysis of commuters' reasons for driving. *Transportation Research Part F: Traffic Psychology and Behaviour, 10*(3), 187-200.
- Hall, E. T. (1966). *The hidden dimension* (Vol. 609). Garden City, NY: Doubleday.
- Henao, A. (2017). *Impacts of Ridesourcing—Lyft and Uber—on Transportation Including VMT, Mode Replacement, Parking, and Travel Behavior* (Doctoral dissertation, University of Colorado at Denver).
- Kaplan, S. (1995). The restorative benefits of nature: Toward an integrative framework. *Journal of Environmental Psychology, 15*(3), 169–182. [http://doi.org/10.1016/0272-4944\(95\)90001-2](http://doi.org/10.1016/0272-4944(95)90001-2)
- Kaplan, S., Bardwell, L. V., and Slakter, D. B. (1993). The Museum as a Restorative Environment. *Environment and Behavior, 25*(6), 725–742. <http://doi.org/10.1177/0013916593256004>
- Krueger, R., Rashidi, T. H., and Rose, J. M. (2016). Preferences for shared autonomous vehicles. *Transportation Research Part C: Emerging Technologies, 69*, 343-355.
- Kurani, K. S., Caperello, N., TyreeHageman, J., and Davies, J. (2018) Symbolism, signs, and accounts of electric vehicles in California. *Energy Research and Social Science 46*: 345–355.
- Kurani, K. S., Turrentine, T., and Sperling, D. (1996). Testing electric vehicle demand in 'hybrid households' using a reflexive survey. *Transportation Research Part D: Transport and Environment, 1*(2), 131-150.
- Leclerc, F., Schmitt, B. H., and Dube, L. (1995). Waiting time and decision making: Is time like money? *Journal of Consumer Research, 22*(1), 110-119.
- Marshall, A. (Nov. 4, 2016). "Hidden art of designing trains for anti-social commuters." *Wired*. Retrieved from: [www.wired.com/2016/11/hidden-art-designing-trains-anti-social-commuters/](http://www.wired.com/2016/11/hidden-art-designing-trains-anti-social-commuters/)
- Merat, N., Madigan, R., and Nordhoff, S. (2016, December). Human Factors, User Requirements, and User Acceptance of Ride-Sharing in Automated Vehicles. In *International Transport Forum Roundtable on Cooperative Mobility Systems and Automated Driving* (pp. 6-7).
- Myles, G., Friday, A., and Davies, N. (2003). Preserving privacy in environments with location-based applications. *IEEE Pervasive Computing, 1*(1), 56-64.
- Newman, O. (1972). *Defensible space* (p. 264). New York: Macmillan.

- Oldenburg, R. (1989). *The great good place: Café, coffee shops, community centers, beauty parlors, general stores, bars, hangouts, and how they get you through the day*. Paragon House Publishers.
- Ouellette, P., Kaplan, R., and Kaplan, S. (2005). The monastery as a restorative environment. *Journal of Environmental Psychology, 25*(2), 175–188.  
<http://doi.org/10.1016/j.jenvp.2005.06.001>
- Paciuk, M. T. (1990). The role of personal control of the environment in thermal comfort and satisfaction at the workplace. In R.I. Selby, K.H. Anthony, J. Choi, and B. Orland eds., *Coming of age*. Environmental Design Research Association (EDRA) 21, pp. 303-312. Oklahoma City, Okla. U.S.
- Pham, A., Dacosta, I., Jacot-Guillarmod, B., Huguenin, K., Hajar, T., Tramèr, F., ... and Hubaux, J. P. (2017). PrivateRide: A privacy-enhanced ride-hailing service. *Proceedings on Privacy Enhancing Technologies, 2017*(2), 38-56.
- Piao, J., McDonald, M., Hounsell, N., Graindorge, M., Graindorge, T., and Malhene, N. (2015). *Public Opinions towards Implementation of Automated Buses in Urban Areas* (No. ITS-2632).
- Putnam, R. D. (2000). *Bowling alone: America's declining social capital*. In *Culture and politics* (pp. 223-234). Palgrave Macmillan, New York.
- Rogers, E. M. (2010). *Diffusion of innovations*. Simon and Schuster.
- SAE (2016). *Taxonomy and Definitions for Terms Related to Driving Automation Systems for OnRoad Motor Vehicles*, Accessed at: [http://standards.sae.org/j3016\\_201609/](http://standards.sae.org/j3016_201609/)
- Sanguinetti, A., Karlin, B., and Ford, R. (2018). Understanding the path to smart home adoption: Segmenting and describing consumers across the innovation-decision process. *Energy Research and Social Science, 46*, 274-283.
- Sanguinetti, A., Pritoni, M., Salmon, K., Morejohn, J., and Modera, M. Using occupant feedback to drive energy efficiency across an entire university campus. *Proceedings of American Council for an Energy Efficient Economy 2016 Summer Study on Energy Efficiency in Buildings*.
- Soltero, R. (2018, August 9). "Apple wants to make a futuristic AR windshield for autonomous cars." iDROPNEWS. Retrieved from: [www.idropnews.com/news/apple-wants-to-make-a-futuristic-ar-windshield-for-autonomous-cars/79826/](http://www.idropnews.com/news/apple-wants-to-make-a-futuristic-ar-windshield-for-autonomous-cars/79826/)
- Sommer, R. (1969). *Personal Space. The Behavioral Basis of Design*.
- Starr, C. (1969). Social benefit versus technological risk. *Science, 1232-1238*.
- Stern, P. C. (2011). Contributions of psychology to limiting climate change. *American Psychologist, 66*(4), 303.
- Taub, E. (2017, June 15). "Envisioning the Car of the Future as a Living Room on Wheels" *New York Times*. Retrieved from: [www.nytimes.com/2017/06/15/automobiles/wheels/driverless-cars-interior.html](http://www.nytimes.com/2017/06/15/automobiles/wheels/driverless-cars-interior.html)

Ulrich, R. S., Simons, R. F., Losito, B. D., Fiorito, E., Miles, M. A., and Zelson, M. (1991). Stress recovery during exposure to natural and urban environments. *Journal of Environmental Psychology*, 11(3), 201–230. [http://doi.org/10.1016/S0272-4944\(05\)80184-7](http://doi.org/10.1016/S0272-4944(05)80184-7)

Whyte, W. H. (1980). *The social life of small urban spaces*. Project for Public Spaces.

Wilson, J. Q., and Kelling, G. L. (1982). Broken windows. *Atlantic Monthly*, 249(3), 29-38.

## Appendix A: Student Projects

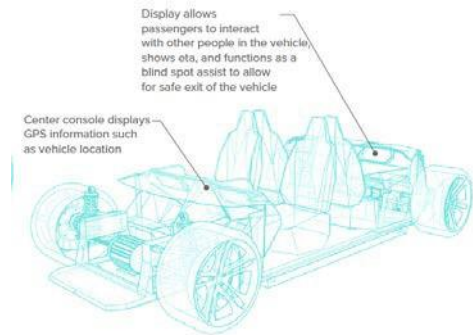

UC Davis Industrial Design course student prototypes [1] Devin Jacobsen [2] Sanaea Kakalia [3] Franky Kwan

Full posters follow on the next pages.



# “PODOMOTIVE”

## Autonomous Vehicle Share Platform

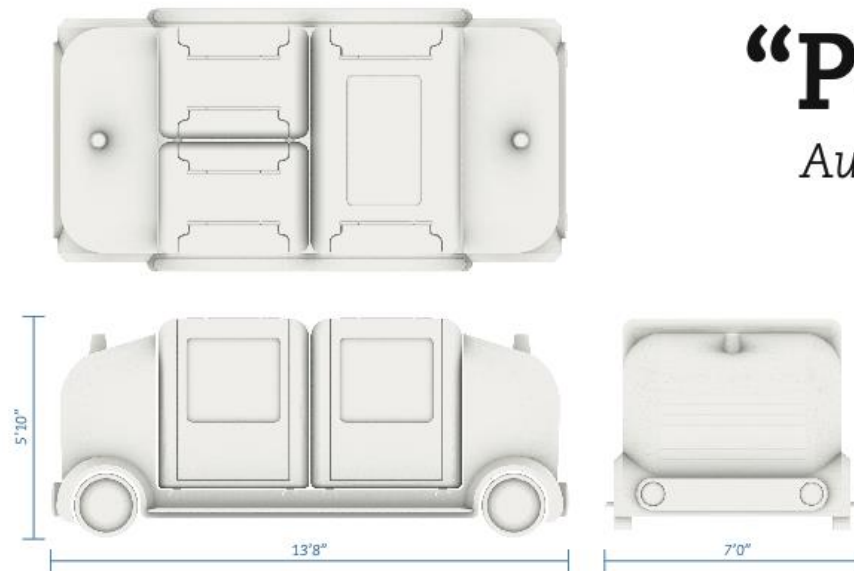

Modular transportation pods available in a variety of sizes to suit every group, luggage, and accessibility needs.

Universal transfer platform allows pods to be moved individually or in large groups via multiple wheeled and railed mediums to maximize speed and efficiency.

Integrates with home delivery systems. Passengers can have lunch, groceries or their latest online order waiting for them in their next pod.

Settings such as music, lighting and seating can be saved so that pod arrives pre-adjusted to user's preferences. Making every pod feel like *their* pod.

Modular system results in less downtime for maintenance and upgrades.

Users can enjoy privacy and anonymity from their fellow passengers.

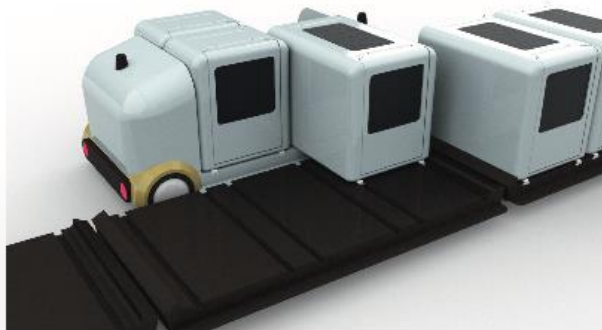

# THE WORK POD: A SHARED AUTONOMOUS VEHICLE DESIGN

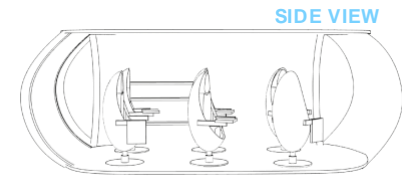
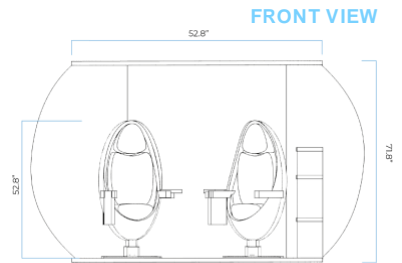
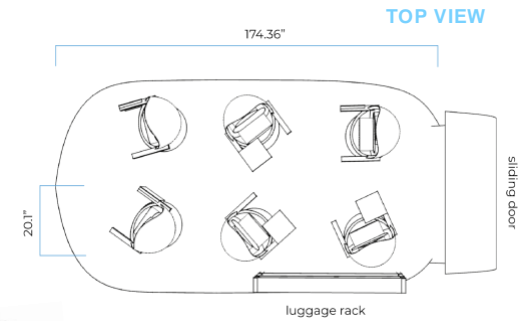

SIDE VIEW

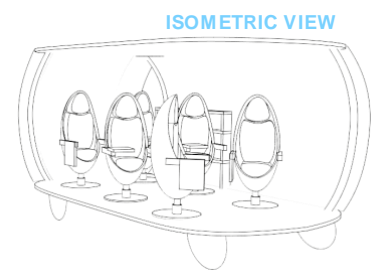

ISOMETRIC VIEW

This SAV design is meant to be utilized as a home-to-work commute module. The focus of this project was the chair and how its design could lead to different interactions, giving the user an opportunity to create a social or private space. The chairs are able to rotate, allowing for collaboration and conversation, or can be left as is. The desks tuck away neatly to the side when not used, but can easily be lifted for a comfortable work environment, allowing users to be productive on-the-go.

Fabrication techniques and materials used include: Rhinoceros, Ultimaker 3 and Cura, Adobe CC.

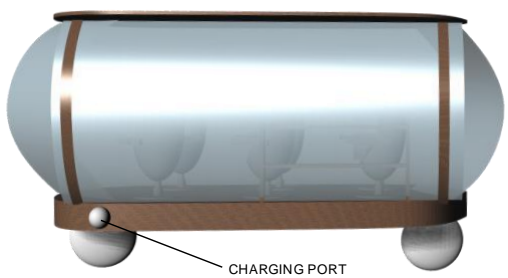

3D PRINTED PROTOTYPE

# Project 3 Autonomous Vehicle

