

UC Irvine

UC Irvine Previously Published Works

Title

Global, regional, and national incidence and mortality for HIV, tuberculosis, and malaria during 1990–2013: a systematic analysis for the Global Burden of Disease Study 2013

Permalink

<https://escholarship.org/uc/item/19b0x0mc>

Journal

The Lancet, 384(9947)

ISSN

0140-6736

Authors

Murray, Christopher JL
Ortblad, Katrina F
Guinovart, Caterina
[et al.](#)

Publication Date

2014-09-01

DOI

10.1016/s0140-6736(14)60844-8

Peer reviewed

Published in final edited form as:

Lancet. 2014 September 13; 384(9947): 1005–1070. doi:10.1016/S0140-6736(14)60844-8.

Global, regional, and national incidence and mortality for HIV, tuberculosis, and malaria during 1990–2013: a systematic analysis for the Global Burden of Disease Study 2013

A full list of authors and affiliations appears at the end of the article.

Summary

Background—The Millennium Declaration in 2000 brought special global attention to HIV, tuberculosis, and malaria through the formulation of Millennium Development Goal (MDG) 6. The Global Burden of Disease 2013 study provides a consistent and comprehensive approach to disease estimation for between 1990 and 2013, and an opportunity to assess whether accelerated progress has occurred since the Millennium Declaration.

Methods—To estimate incidence and mortality for HIV, we used the UNAIDS Spectrum model appropriately modified based on a systematic review of available studies of mortality with and without antiretroviral therapy (ART). For concentrated epidemics, we calibrated Spectrum models to fit vital registration data corrected for misclassification of HIV deaths. In generalised epidemics, we minimised a loss function to select epidemic curves most consistent with prevalence data and demographic data for all-cause mortality. We analysed counterfactual scenarios for HIV to assess years of life saved through prevention of mother-to-child transmission (PMTCT) and ART. For tuberculosis, we analysed vital registration and verbal autopsy data to estimate mortality using cause of death ensemble modelling. We analysed data for corrected case-notifications, expert opinions on the case-detection rate, prevalence surveys, and estimated cause-specific mortality using Bayesian meta-regression to generate consistent trends in all parameters.

Correspondence to: Christopher J L Murray.

Contributors: CJLM, ADL, and TV prepared the first draft. CJLM, KFO, CG, SSL, TMW, DAR, EAD, NG, RMB, JCB, HCD, LD, JAS, DEP, TDF, BKP, EKJ, MSC, ADL, and TV finalised the draft based on comments from other authors and reviewer feedback. CJLM, SSL, and TV had the idea for the study and provided overall guidance. CJLM, KFO, CG, SSL, TMW, DAR, EAD, NG, HW, MN, DD, KRH, KF, DEP, TDF, ADF, and TV did all modeling. CJLM, KFO, CG, SSL, TMW, DAR, EAD, NG, RMB, HW, HCD, DD, DEP, ADF, and TV did the statistical analysis of model results. All other authors provided data, developed models, reviewed results, initiated modeling infrastructure, and reviewed the paper.

† Authors listed alphabetically

‡ Joint senior authors

Declaration of interests: CC has received consultancy, lecture fees and honoraria from AMGEN, GSK, Alliance for Better Bone Health, MSD, Eli Lilly, Pfizer, Novartis, Servier, Merck, Medtronic and Roche. LD has been funded by and acted as a consultant to UNAIDS, UNODC, and WHO. BD Gessner works for AMP which receives grant specific support from Crucell, GSK, Novartis, Pfizer, and SanofiPasteur and unrestricted support from SanofiPasteur all for work on vaccines and vaccine preventable diseases. Related to the current work, AMP receives grant support from GSK for work on issues related to malaria vaccines. KBG received the NHMRC-Gustav Nossal scholarship sponsored by CSL in 2012. This award is peer-reviewed through the standard NHMRC peer-review process; CSL played no part in selection of the awardee. PJ is supported by a career development fellowship from the Wellcome Trust, Public Health Foundation of India and a Consortium of United Kingdom Universities. Walter Mendoza is program analyst at the UNFPA country office in Peru, which not necessarily endorses the study. JAS has received research grants from Takeda and Savient and consultant fees from Savient, Takeda, Regeneron and Allergan. JAS is a member of the executive of OMERACT, an organization that develops outcome measures in rheumatology and receives arms-length funding from 36 companies; a member of the American College of Rheumatology's Guidelines Subcommittee of the Quality of Care Committee; and a member of the Veterans Affairs Rheumatology Field Advisory Committee.

We analysed malaria mortality and incidence using an updated cause of death database, a systematic analysis of verbal autopsy validation studies for malaria, and recent studies (2010–13) of incidence, drug resistance, and coverage of insecticide-treated bednets.

Findings—Globally in 2013, there were 1.8 million new HIV infections (95% uncertainty interval 1.7 million to 2.1 million), 29.2 million prevalent HIV cases (28.1 to 31.7), and 1.3 million HIV deaths (1.3 to 1.5). At the peak of the epidemic in 2005, HIV caused 1.7 million deaths (1.6 million to 1.9 million). Concentrated epidemics in Latin America and eastern Europe are substantially smaller than previously estimated. Through interventions including PMTCT and ART, 19.1 million life-years (16.6 million to 21.5 million) have been saved, 70.3% (65.4 to 76.1) in developing countries. From 2000 to 2011, the ratio of development assistance for health for HIV to years of life saved through intervention was US\$4498 in developing countries. Including in HIV-positive individuals, all-form tuberculosis incidence was 7.5 million (7.4 million to 7.7 million), prevalence was 11.9 million (11.6 million to 12.2 million), and number of deaths was 1.4 million (1.3 million to 1.5 million) in 2013. In the same year and in only individuals who were HIV-negative, all-form tuberculosis incidence was 7.1 million (6.9 million to 7.3 million), prevalence was 11.2 million (10.8 million to 11.6 million), and number of deaths was 1.3 million (1.2 million to 1.4 million). Annualised rates of change (ARC) for incidence, prevalence, and death became negative after 2000. Tuberculosis in HIV-negative individuals disproportionately occurs in men and boys (versus women and girls); 64.0% of cases (63.6 to 64.3) and 64.7% of deaths (60.8 to 70.3). Globally, malaria cases and deaths grew rapidly from 1990 reaching a peak of 232 million cases (143 million to 387 million) in 2003 and 1.2 million deaths (1.1 million to 1.4 million) in 2004. Since 2004, child deaths from malaria in sub-Saharan Africa have decreased by 31.5% (15.7 to 44.1). Outside of Africa, malaria mortality has been steadily decreasing since 1990.

Interpretation—Our estimates of the number of people living with HIV are 18.7% smaller than UNAIDS's estimates in 2012. The number of people living with malaria is larger than estimated by WHO. The number of people living with HIV, tuberculosis, or malaria have all decreased since 2000. At the global level, upward trends for malaria and HIV deaths have been reversed and declines in tuberculosis deaths have accelerated. 101 countries (74 of which are developing) still have increasing HIV incidence. Substantial progress since the Millennium Declaration is an encouraging sign of the effect of global action.

Funding—Bill & Melinda Gates Foundation.

Introduction

The Millennium Declaration in 2000 brought special global attention to HIV, tuberculosis, and malaria through the formulation of Millennium Development Goal 6 (MDG 6). The high priority status of these three diseases in the development community was confirmed through the creation of the Global Fund to Fight AIDS, Tuberculosis and Malaria in 2002. Bilateral initiatives such as the President's Emergency Plan for AIDS Relief and the President's Malaria Initiative also added substantial new resources. From 2000 to 2011, multilaterals, bilaterals, foundations, and non-governmental organisations have invested US \$51.6 billion for HIV, \$11.3 billion for malaria, and \$8.3 billion for tuberculosis (price in 2011 US dollars) in development assistance for health (DAH).¹ Substantial benefits of these

investments have been documented in several studies.²⁻⁹ In the lead up to the MDG deadline of 2015 and amid the global debate on development goals post-2015, important questions have been raised about the advantages and disadvantages of maintaining focus on these three diseases.^{5,10-18} The rise of the importance of non-communicable diseases in some regions of the developing world¹⁹⁻²⁶ have led to calls for goals that cover a broader range of diseases.^{10,15,17,19,20,24,25,27,28} At the same time, ambitious goals of zero tuberculosis incidence and deaths and zero HIV incidence and deaths have been formulated by some groups;²⁹⁻³⁴ the Secretary-General of the UN had already established a goal of zero malaria deaths by 2015.³⁵ Understanding the distribution and trends of these three diseases and how they have been affected by the MDG era is an important input to this wider debate.^{12,36}

Because of their prominence, there are major UN efforts on an annual basis to track the epidemiology of these three diseases. UNAIDS now produces country estimates of HIV incidence, prevalence, and death every year.³⁷ Over many years, they have developed a sophisticated modelling approach to track the epidemic—their primary input in generalised epidemics is annual antenatal clinic sero-surveillance data and periodic household surveys that include blood testing.^{38,39} The annual Global Tuberculosis Report from the World Health Organization (WHO) provides estimates of incidence and deaths from tuberculosis by country. Crucial inputs to the assessment of incidence are case notifications and national expert opinion on the case-detection rate, and separate modelling of cause of death data from vital registration systems and verbal autopsy studies. For the World Malaria Report, WHO uses a complicated strategy to estimate incidence and mortality that varies by region and age group. For child malaria deaths in sub-Saharan Africa, the main inputs are verbal autopsy studies and estimated malaria risk. Estimates are adjusted post-hoc for coverage of insecticide-treated bednets (ITNs). Outside of sub-Saharan Africa and for low-transmission countries in Africa reported case numbers are combined with an assumed case-fatality rate. These three efforts have provided important insights into the geographical distribution and likely trends in the diseases.

Despite these efforts, extraordinary uncertainty exists at the country-level in the burden of all three. The burdens of HIV and malaria are concentrated in sub-Saharan Africa; countries that, other than South Africa, have very poor vital registration and incomplete notification systems. Tuberculosis is concentrated in Asia and southern Africa where a few more countries have better data systems but there are still huge gaps in information. Modelling strategies for tracking the diseases have evolved to be necessarily complex in view of the incomplete and often conflicting nature of the data. For HIV and malaria, UN modelling efforts explicitly use information about intervention delivery and assumed benefits of intervention. The distinction between data for disease outcomes and data for intervention coverage driving the results of these efforts is blurred. In the more complex modelling strategies, the compounded effect of uncertainty about different parameters can be hard to characterise. Efforts to model the three diseases are largely independent of each other—the exception is recent coordinated efforts to understand the intersection of tuberculosis and HIV.⁴⁰

The Global Burden of Disease 2010 Study provided a comprehensive update on levels and trends of a large number of diseases, injuries, and risk factors for 187 countries from 1990 to

2010.⁴¹⁻⁴⁸ The Global Burden of Disease collaboration is now generating annual updates, the first of which is the Global Burden of Disease, Injuries, and Risk Factors Study 2013 (GBD 2013). The GBD 2013 provides an opportunity to examine the evidence on the levels and trends in the three MDG 6 diseases within the comprehensive and coherent framework of the GBD. Compared with GBD 2010, we have given special emphasis in the GBD 2013 to incorporate new data, to more rigorously identify and incorporate further key sources of uncertainty, and to incorporate adjustments for the biases that are present in different data sources. A crucial aspect of the GBD effort is to quantify time trends; comparing trends from 1990 to 2000 and from 2000 to 2013 provides an opportunity to see if there has been accelerated progress since the Millennium Declaration. The GBD 2013 supersedes all previously published GBD results.

Methods

Overview

The overall conceptual and analytical framework for the GBD is described elsewhere.⁴¹⁻⁴⁸ Major refinements of the analytical approach for different diseases and risk factors are explored in other papers.⁴⁹⁻⁵¹ We summarise here the methods used for the analysis of the three diseases, emphasising refinements since the GBD 2010. All refinements in methods have been applied to the full 1990–2013 time series to ensure comparability of results. Metadata for input sources used in the GBD 2013 will be available in the Global Health Data Exchange on publication of the full GBD 2013 results.

HIV

For the GBD 2010, we primarily used estimates of prevalence and mortality developed by UNAIDS. The main modification was the requirement that the sum of cause-specific mortality from each cause in a country, age, sex, and year group equalled the estimate of all-cause mortality for that country, age, and sex group generated through the analysis of demographic sources.⁴³ Modifications of HIV deaths through this internal consistency process did not lead to revisions of incidence or prevalence for HIV in a particular age-sex-country-year. For the GBD 2013, we have sought to develop a set of estimates of incidence, prevalence, and mortality from HIV that are internally consistent with each other and also meet the GBD requirement that the sum of each cause of death equals all-cause mortality. Internally consistent means the incidence, prevalence, and death figures are mathematically possible given that prevalence is a function of past incidence, remission, and death rates for any age cohort.

Modified Spectrum Model—UNAIDS uses two key analytical components in their epidemiological estimation. The Estimation and Projections Package (EPP) is used to estimate incidence trajectories that are consistent with prevalence surveys and other prevalence measurements such as antenatal clinic serosurveillance.⁵² Spectrum is a compartmental HIV progression model used to generate age-specific incidence, prevalence, and death rates from the EPP incidence curves and assumptions about intervention scale-up and local variation in epidemiology.⁵³ We have recoded Spectrum in Python, an open source higher level language that can easily be run on a parallelised computational cluster,

following the exact structure of Spectrum to facilitate faster computation required for the uncertainty analysis and consistency analysis with all-cause mortality. We have also made four important modifications to the assumptions.

First, we have altered the Spectrum assumptions about mortality without antiretroviral therapy (ART). Following UNAIDS assumptions, mortality is modelled as shown in figure 1. The death and progression rates between CD4 categories vary by age according to four age-groups, 15–24 years, 25–34 years, 35–44 years, and 45 years or older. UNAIDS estimates a single set of progression and death rates by first fitting a Weibull distribution to data from three east African seroconverter cohorts from the ALPHA network and one miners cohort from South Africa,⁵⁴ and then selecting a set of progression and death rates in Excel Solver that minimises the sum of the squared differences between the predicted and Weibull survival probabilities.^{55,56} Uncertainty in their estimates for this component was approximated by assuming a coefficient of variation of 0.05 for each mortality rate. To better characterise uncertainty in the progression and death rates, we systematically reviewed the literature on mortality without ART. We searched terms related to pre-ART or ART-naïve survival since seroconversion—exact search terms are in the appendix (p 132). After screening, we identified 13 cohort studies that included the cohorts used by UNAIDS from which we extracted survival at each 1-year point after infection. We modelled the logit of the conditional probability of death between years in these studies using the following formula:

$$\text{logit}(m_{ijk}) = \beta_0 + \sum_{i=1}^4 \beta_{1i} a_i + \sum_{j=1}^{12} \beta_{2j} t_j + u_k + \varepsilon_{ijk}$$

In the formula, m is conditional probability of death from year t_j to t_{j+1} , a_i is an indicator variable for age group at seroconversion (15–24 years, 25–34 years, 35–44 years, and 45 years or older), t_j is an indicator variable of year since seroconversion, and u_k is a study-level random effect. By sampling the variance-covariance matrix of the regression coefficients and the study level random effect, we generated 1000 survival curves for each age group that capture the systematic variation in survival across the available studies (figure 2, appendix p 18). Across all age groups, median survival ranges from 3.6 years to 29.5 years. For each of the 1000 survival curves, we use the UNAIDS optimisation framework to find a set of progression and death rates that minimises the sum of the squared errors for the fit to the survival curve. For the death rates generated from the optimisation, the coefficient of variation across the set of 1000 is 0.44–1.00 depending on the age-group, which is substantially higher than the UNAIDS assumption of 0.05.

Second, for mortality on ART, UNAIDS used data from five regional cohorts from the IeDEA network to directly estimate death rates by age, sex, and CD4 count, which have been used as the default for all countries in a region.^{57,58} Through their country consultation process some of these defaults have been modified. For example, Myanmar assumes a constant mortality rate by initial CD4 group, without any variation by age, sex, or time on treatment. To better characterise real variation in the death rates on ART across programmes, we searched the published literature. Using the terms “HIV”, “mortality”, and

“antiretroviral therapy” we identified 4996 titles. Screening the abstracts and papers yielded 102 total papers for extraction (appendix p 133). These included mortality and loss to follow-up data for 80 cohorts, age hazard ratios for 40 cohorts, and sex hazard ratios for 86 cohorts. We corrected reported probabilities of death for loss to follow-up using an update of the approach developed by Verguet and colleagues.⁵⁹ Verguet and colleagues used tracing and follow-up studies to empirically estimate the relation between death in loss to follow-up and the rate of loss to follow-up. We used DisMod-MR 2.0 to do a meta-regression of the data for on-ART mortality by initial CD4 count separately for high-income countries, GBD developing countries outside of sub-Saharan Africa, and sub-Saharan Africa (appendix p 7). We meta-analysed region-specific age hazard ratios using DisMod-MR 2.0, and region-specific sex hazard ratios using the Stata command *metan*. The age and sex hazard ratios were applied to the CD4-specific mortality rates, accounting for the distribution of ages and sexes in the mortality data. We used 1000 draws from the posterior distribution for each age, sex, and CD4 category for conditional probabilities of death for 0–6 months, 7–12 months, and 13–24 months after initiation of ART as inputs to Spectrum. Table 1 shows HIV-specific mortality rates for people aged 25–34 years on ART in sub-Saharan Africa (see appendix pp 136–38 for HIV-specific mortality for other age groups and regions).

Third, to better capture variation in the age-pattern of incidence, we used the UNAIDS distributions of the relative incidence by age prepared for UNAIDS based on selected cohort studies. To capture the possibility that there is greater variation across countries in the age incidence pattern than in these studies, we increased the uncertainty ranges by an arbitrary 50%.

Fourth, for all other input parameters including the number of individuals receiving ART, prevention of mother-to-child transmission (PMTCT), or co-trimoxazole prophylaxis, we randomly sampled a uniform distribution from 0.9 to 1.1 and used the draw to adjust each parameter. For the sex ratio of incidence, we sampled a wider but arbitrary range from 0.8 to 1.2, because the demographic data in many generalised epidemics indicate that there is less of a difference between the sexes than seen in the population prevalence surveys.

Generalised epidemics—UNAIDS identified 41 countries as generalised epidemics; this distinction is important because for these epidemics the primary sources of information about prevalence come from antenatal clinic serosurveillance and household surveys. In addition to these 41 countries, we have included in this category Senegal, Niger, and India because of the availability of population-based surveys. Prevalence data from countries with generalised epidemics has been analysed by UNAIDS using EPP to generate 1000 samples of incidence curves for people aged 15–49 years consistent with the prevalence data. For each of these 1000 incidence curves, we randomly sampled the parameter distributions for all input parameters ten times to generate 10 000 epidemic curves of incidence, prevalence, and death by age and sex. The selection of 10 000 iterations was based on testing that it would ensure stable uncertainty intervals. Some of these 10 000 death curves exceed in one or more age-sex-year groups the estimate of all-cause mortality based on demographic sources. Because the demographic estimates of all-cause mortality are based on substantial empirical data, these HIV epidemic curves are unlikely to represent reality. These mismatches occur more often in southern Africa. We identified the 250 modified Spectrum

curves and all-cause mortality curves that are most consistent with each other. We define a loss function using the following formula:

$$e_r = \sum_t \sum_a \sum_s \max \left(0, m_{r,t,a,s}^{HIV} - 0.8 \cdot m_{r,t,a,s}^{all-cause} \right)$$

For run r of a given country, excess mortality, e , is equal to the sum of all non-zero differences between HIV mortality, m^{HIV} , and 0.8 times a randomly selected all-cause mortality draw, $m^{all-cause}$, across all year-age-sex combinations (t , a , and s , respectively). We compared the Spectrum estimates to 0.8 times the all-cause estimates because this is the highest recorded fraction of deaths in any age-group in any country's cause of death data due to HIV. We randomly paired each of the 10 000 modified spectrum outputs with one of the 1000 all-cause mortality curves generated from the demographic analysis. The 250 pairs that minimised the loss function were selected. When more than 250 have a loss function equal to zero, we randomly chose among this set. We resampled the 250 draws to 1000; 250 are used with resampling for computational convenience. The appendix (pp 18–20) shows mortality at ages 15–59 years from the full set of 10 000 modified spectrum models and the subset that is selected through the matching process for Uganda, South Africa, and Ghana. Demographic data matching selects in South Africa epidemic curves that are at the low end of the distribution with longer median survival; in Uganda this effect is slightly less pronounced and in Ghana pre-matching and post-matching were identical.

Concentrated epidemics with vital registration data—UNAIDS estimates for concentrated epidemics depend critically on two inputs: first, the assessment of prevalence of HIV in high-risk groups (people who inject drugs, men who have sex with men, and female sex workers) for which there is much information in many countries;⁶⁰⁻⁷² and second, assumptions on the percentage of the population in high-risk groups. Although there is guidance on measurement,⁷³ real data in most countries are limited. In many countries, UNAIDS estimates are based on local opinion. Resulting assumptions have been highly variable across countries. For example, Uruguay defines 4.5% of its population as men who have sex with men while neighbouring Argentina defines only 1% of its population as men who have sex with men. An alternative source in many countries is cause of death data from national vital registration systems. To track the epidemic using cause of death data can require up to three important adjustments. First, in some middle-income countries, vital registration is incomplete. Wang and colleagues have used death distribution methods⁴³ to assess completeness in all countries with vital registration; we have used this information to correct upwards incomplete registration. Second, a key aspect of the GBD is to redistribute deaths that are assigned to immediate or intermediate causes of death rather than underlying causes of death (garbage codes).⁷⁴ In addition to garbage codes, because HIV was not included in the International Classification of Diseases (ICD)-9 until 1986 and not implemented in many countries until later, deaths were often assigned to other codes such as graft versus host disease or Kaposi's sarcoma. Third, in some places, because of stigma or misdiagnosis, HIV deaths can be assigned to other underlying causes of death such as tuberculosis, endocrine disorders, meningitis, or encephalitis. Birnbaum and colleagues developed a method to identify these misclassified deaths.⁷⁵ We applied this method to all

countries. Misclassification of HIV deaths in Birnbaum and colleagues' method is based on fulfilling three criteria. First, the temporal trend for a cause should coincide with the HIV epidemic. Second, the pattern of the relative death rate by age should shift towards the ages of 15–49 years during the epidemic years. Third, the temporal and age-pattern shifts cannot be explained by other known epidemiological trends. Applying these methods, we transfer deaths from 47 causes in 52 countries. Figure 3 shows the number of HIV deaths directly coded to HIV, the number of deaths re-assigned to HIV from garbage code redistribution, and the number of deaths from the application of the HIV misclassification method for Thailand and Russia. The height of the bar is the final number of deaths in each age group.

For countries with corrected vital registration, we imputed missing years of data to generate a complete time series for HIV from the estimated start year of the epidemic using spatial-temporal Gaussian Process Regression (ST-GPR).^{43,76,77} ST-GPR using a linear mean function and a Matern covariance has been widely used for time-series estimation in global health descriptive studies such as for tobacco prevalence, obesity prevalence, or child and adult mortality. To generate an internally consistent set of incidence, prevalence, and death curves with uncertainty, we used the observed HIV death numbers to calibrate the modified Spectrum models. First, we started with a modified Spectrum model constructed based on the analysis of high-risk groups— where no high-risk group analysis was available we used a regional default model. Second, for each of the 1000 draws from this model, we modified the incidence at time t by the ratio of observed deaths to modified spectrum deaths at time $t + \lambda$, where λ is the lag between incidence and death. We drew from a distribution of lags of 10–15 years to generate 6000 different adjusted incidence curves. For incidence for the last λ time periods, we drew a random weight between 0 and 1 from a uniform distribution and used it to calculate a weighted average of adjusted incidence in year $t + \lambda$ and unadjusted incidence multiplied by the deaths ratio in year $t + \lambda$. Using these modified incidence curves, we reran the modified Spectrum generating 6000 possible epidemic curves. As a final step, for each of these 6000 we computed the mean squared error of predicted deaths compared with observed deaths. The 1000 curves with the lowest mean squared error were selected as the final set for analysis. Figure 4 shows the results of this process for Panama and the comparison with the UNAIDS high-risk group analysis; the corrected vital registration data suggest a much smaller epidemic with different timing.

Concentrated epidemics with high-risk group analysis and insufficient or no cause of death data—There were 17 countries with concentrated epidemics where we had no or insufficient vital registration or verbal autopsy data to inform our cause of death analysis. For these countries we ran modified Spectrum to output 1000 draws of incidence, randomly selecting 1000 time series of the death ratios generated in the process described above, and multiplying each draw of incidence by the selected set of ratios. We selected incidence adjustments only for countries with a cumulative number of HIV deaths greater than 5000 to avoid exaggerated stochastic variation in the ratios. We then derived estimates of mortality by running the adjusted incidence curves back through Spectrum. By using random draws across these countries, the average correction and uncertainty in this correction is propagated into the corrections for these countries with little or no data.

Concentrated epidemics with no high-risk group analysis and no cause of death data—For 13 countries (Andorra, United Arab Emirates, Iraq, Federated States of Micronesia, Libya, Marshall Islands, State of Palestine, Solomon Islands, Timor-Leste, Vanuatu, Samoa, Tonga, and North Korea) no analysis of high-risk groups has been undertaken and no cause of death data are available. For these countries, we picked regional or neighbouring countries to approximate the death rate. We used these approximate death rates to fit a Spectrum model. In all these cases, the number of estimated deaths was less than 250 per year.

Comparisons to prevalence survey data—As a form of empirical validation, we compared our final estimated prevalence with national population-based surveys collected through the Demographic and Health Surveys, AIDS Indicator Surveys, the 2005–2006 Indian National Family Health Survey, and the 2012 South African National HIV Prevalence, Incidence, and Behaviour Survey.⁷⁸⁻⁸⁰ In total, we extracted data from 46 surveys in 35 countries between 2001 and 2012. These surveys had response rates for HIV testing ranging from 63% in male respondents in Malawi in 2004 to 98% for both sexes in Rwanda in 2011; median response rate was 85%. These comparisons are made for adults aged 15–49 by sex and 5-year age groups. We tested for significant differences in means ($p < 0.05$) for each estimate and compared the distribution of survey estimates to GBD and UNAIDS via ordinary least squares (OLS) regression with robust standard errors to account for heteroscedasticity.

HIV intervention counterfactual scenario—Spectrum uses as inputs the numbers reported by governments of individuals receiving PMTCT, co-trimoxazole, and child and adult ART. To help understand the role of interventions including ART, PMTCT, and co-trimoxazole prophylaxis, we have rerun the final 1000 modified Spectrum models for each country using a no intervention counterfactual scenario. We turn all HIV-related interventions to zero including ART, PMTCT, and co-trimoxazole prophylaxis for all years. We compared the number of deaths and person-years lived each year from the base case to this counterfactual to assess the changes due to intervention. Using published results on DAH for HIV, we computed the ratio of DAH to years of life saved.

Tuberculosis

For the GBD 2010, we estimated tuberculosis mortality and then estimated population incidence through mixed effects regression as a function of tuberculosis mortality, case-notifications, and an indicator variable for health system access used as a proxy for completeness of registration. For GBD 2013, we have shifted to using all available data for different outcomes and simultaneously estimating incidence, remission, excess mortality, prevalence, and cause-specific mortality using the GBD Bayesian meta-regression environment, DisMod-MR 2.0 (appendix p 11). There are four potential sources of information to estimate national levels and trends for tuberculosis in a country: annual case notifications, expert judgment on the case-detection rate, prevalence surveys, and cause of death data. Additionally, to facilitate convergence of the meta-regression, estimated excess mortality and remission rates have been used. The approach is predicated on the principle that incidence, prevalence, and mortality might be measured imperfectly and that a statistical

triangulation of all the sources for a country will provide a more robust assessment. Our meta-regression analysis was done for all forms of tuberculosis. As a final step we estimated incidence, prevalence, and death in individuals who are HIV-positive and those who are HIV-negative. We explain in more detail the preparation of each of these sources.

Adjusted case notifications and incidence—Case definitions for tuberculosis since 1995 have been standardised by WHO and widely applied. Countries have varied however in the completeness of reporting for younger age-groups and some countries have reported only pulmonary smear-positive cases for selected years. We use the age and sex-specific notifications in our analysis and impute the missing age-groups for three forms of tuberculosis notifications (pulmonary smear-positive, pulmonary smear-negative, or extra-pulmonary) in two steps. First, for each country-sex category with missing age-groups in some years, we imputed the missing values by regressing the log of the case notification rate on dummy variables for 5-year age-groups and random effects on year using all the data for a country over the interval 1990–2013.

Second, we estimated the relation between all forms of tuberculosis and smear-positive tuberculosis and the relation between all forms and bacteriologically positive tuberculosis. Using country-years with complete notifications (all three forms), we used a compositional analysis model to simultaneously estimate the fraction of cases due to all three forms as a function of dummy variables for 5-year age-groups and sex and the smear-positive tuberculosis rate. This regression was used to impute missing values for pulmonary smear-negative and extra-pulmonary cases. Because of substantial variation in the diagnostic rates for extrapulmonary tuberculosis and the potential for misclassification, we used the predicted values for extrapulmonary cases for all countries from the regression.

At the country-level several smear-unknown and relapsed cases are recorded that are not captured in the age-specific and sex-specific notifications. We used the relation between these forms and pulmonary smear-positive cases in the country-level data to inflate the adjusted age-specific and sex-specific pulmonary smear-positive notifications used in our analysis. Case notifications, however, do not capture all true incidence cases in the population. Case notifications can be incomplete because some cases are not diagnosed and some diagnosed cases are not reported to the national tuberculosis programme. Population-based incidence studies for tuberculosis based on active surveillance are rare and have not been done at the national level.⁸¹ In the absence of direct measurement of true incidence, the case detection rate must be approximated. Since 2008, WHO has been consulting with national tuberculosis programme managers in 96 countries to collect expert opinion on the case detection rate including some notion of subjective uncertainty.⁸² For the remaining countries, case-detection estimates are based on the judgment of WHO staff. We divided adjusted case notifications by the estimated case detection rate to generate the incidence inputs used for DisMod-MR 2.0. We expanded the subjective uncertainty intervals reported so they are at a minimum plus or minus 20% from the estimated values or for values less than 20% we assume the standard error is half the midpoint estimate.

Tuberculosis prevalence surveys—Prevalence surveys have been periodically undertaken in a few countries such as South Korea and China. WHO standardised the

protocol and the Global Fund to Fight AIDS, Tuberculosis and Malaria has helped fund 24 surveys in 21 countries between 2002 and 2013 with 12 additional surveys in eight new countries planned.⁸²⁻⁸⁴ Because the prevalence rates for tuberculosis are often comparatively low (eg, 200 per 100 000 population), prevalence surveys need to be large to provide breakdowns by age and sex. On the basis of the literature and country reports, we have identified 27 national and 24 subnational prevalence surveys in 24 countries spanning the time period 1985–2013. We have included in our analysis, surveys reporting on pulmonary smear-positive tuberculosis and bacteriologically positive tuberculosis. We included in the Bayesian meta-regression study level dummy variables for the different measured outcomes with the reference category being bacteriologically positive. We allowed for non-sampling variance for sub-national surveys to be larger which effectively down-weighted their importance for the estimation in a given country. Because mortality and incidence data are for all forms of tuberculosis, we adjusted prevalence surveys to account for extra pulmonary cases using the same factors used in the adjustment of case notification data.

Mortality—We used 2731 country-years of nationally representative vital registration data and 166 site-years of verbal autopsy data to estimate tuberculosis mortality. Vital registration data were adjusted for garbage coding following GBD algorithms^{74,85} and misclassified HIV deaths described above. We modelled deaths by age and sex for tuberculosis using the Cause of Death Ensemble modelling (CODEm) approach.⁷⁶ CODEm has been extensively used in global cause of death analyses.⁷⁴ Using CODEm, we tested a wide range of potential models and used out-of-sample predictive validity to select the best individual models and the best ensemble of these models. The appendix (pp 152–186) shows details on the application of CODEm to tuberculosis. We ran CODEm separately for male and female individuals. The final ensemble models selected had a root-mean squared error of the log of the age-specific death rate of 0.29 in-sample and 0.63 out-of-sample for males and 0.70 in-sample and 1.05 out-of-sample for females. In the out-of-sample predictive validity testing (cross-validation), the coverage of the 95% data prediction uncertainty interval was 93% and 91% for males and females, respectively.

CODEm results are largely informed by ICD-coded data, which by definition exclude tuberculosis mortality in HIV-positive individuals. The overall Bayesian model, however, is for all forms of tuberculosis in HIV-negative and HIV-positive people because prevalence data rarely distinguish HIV status. We estimated the fraction of HIV deaths due to tuberculosis-HIV and added these to tuberculosis mortality in HIV-negative people. The model for the fraction of tuberculosis-HIV mortality was based on 1022 country-years of data when cause of death data for tuberculosis-HIV and HIV overall were available. We estimated the relation between the logit-transformed fraction of HIV deaths due to tuberculosis-HIV and the log-transformed tuberculosis death rate, a dummy variable for sex, year, and country random effects. We used this regression to predict the fraction of HIV deaths due to tuberculosis-HIV in all countries.

Remission and excess mortality estimates—To help inform the model, we generated a Bayesian prior for remission by examining the ratio of incidence to prevalence in the

country-years where prevalence surveys have been undertaken. We used a simple regression with random effects to generate priors for countries with surveys and those without. Cause-specific mortality estimates inform estimates of prevalence through excess mortality in DisMod-MR 2.0. To provide the model with the range of age-specific and sex-specific excess mortality hazards associated with tuberculosis we analysed historical data where we had both tuberculosis mortality data and incidence data that were believed to be nearly complete. For this analysis, we used the WHO case notifications from 1980 onwards with the supplement of age-sex-specific case notifications back to the 1950s for Australia, Canada, the UK, USA, Japan, and Germany. Case notification data were combined with tuberculosis deaths recorded in the vital registration systems to generate 743 country-year observations from 70 countries that could be used to inform our analysis. We estimated the relation between incidence and mortality for each sex, by regressing the logit-transformed ratio of incidence to mortality against age, lag-distributed income per head, and country random effects. The addition of HIV prevalence off-ART to the regression gave inconsistent coefficients between females and males and was not included in the final model. We estimated the relation between incidence and prevalence as a function of lag-distributed income per head with country random effects. We transformed predicted death to incidence ratios and incidence to prevalence ratios into estimates of excess mortality and remission using the mathematical relations between them (appendix p 7).

DisMod-MR 2.0—For each country we included in the DisMod-MR 2.0 estimation the adjusted case notifications, prevalence survey data if available, estimated excess mortality hazard by age and sex, estimated remission, and the tuberculosis-HIV adjusted cause-specific mortality estimates from our CODEm model. DisMod-MR 2.0 provides internally consistent estimates for 1990, 1995, 2000, 2005, 2010, and 2013 for 188 countries of incidence, remission, excess mortality, prevalence, and cause-specific mortality using all forms of data or priors in the estimation. Figure 5 shows the internally consistent fit for Kenya in 2013. For intervening years, we interpolated rates.

Estimating tuberculosis incidence, prevalence, and death in individuals who are HIV-positive—We used tuberculosis all-forms estimates from DisMod-MR 2.0 to estimate incidence and prevalence in HIV-positive people using a relative risk approach. We reviewed the literature using the search terms “incidence”, “risk ratio”, “HIV”, “tuberculosis”, and “antiretroviral therapy” and used meta-regression to estimate a relative risk of tuberculosis incidence in HIV-positive individuals in the absence of ARTs based on seven studies⁸⁶⁻⁹² of 8.7 (95% CI 5.9–11.7). Findings from previous studies show that the relative risk of tuberculosis incidence is a function of CD4 count and ART; to parse out the increasing risk ratios of tuberculosis by decreasing CD4 count and the decreasing risk ratio on ART we used data from the Badri and colleagues’ study.⁹³ The relative risks we calculated from this analysis were 15.7 (10.6–21.1) for a CD4 cell count less than 200, 10.8 (7.3–14.5) for a cell count of 200–350, 3.2 (2.2–4.3) for a count greater than 350, and 1.7 (1.2–2.3) for the on-ART category. We computed population-attributable fractions for each category using the outputs of Spectrum above. For prevalence, we assumed that each category of incident tuberculosis cases in HIV-positive individuals has the same duration. Tuberculosis-HIV mortality was estimated as described above.

Malaria

Murray and colleagues developed estimates of mortality and incidence for malaria for the GBD 2010.^{74,94} They estimated malaria mortality using vital registration and verbal autopsy data analysed using CODEm. Published community incidence studies were meta-analysed to generate a model of incidence as a function of mortality, age, sex and region. We have modified this method for the GBD 2013 update. Much debate emerged since the publication of that analysis on the validity of verbal autopsy for adult malaria deaths.⁹⁵⁻¹⁰⁰ For the GBD 2013, we undertook a systematic review of the literature on the validity of verbal autopsy for malaria. Our inclusion criteria were validation studies that used physician-certified verbal autopsies, reported both sensitivity and specificity for malaria, and had hospital diagnosis as the gold standard. However, the quality of the gold standards used in these studies was variable, and in some of them malaria cases were not confirmed with a blood smear or did not use a case definition with a threshold of parasitaemia. We identified seven studies.¹⁰¹⁻¹⁰⁷ We first tested in a meta-regression if there was any statistically significant difference between studies with and without parasitaemia confirmation and identified none. We meta-analysed these studies to estimate sensitivity and specificity, separately for children and adults. Forest plots for adult and children are shown in figure 6. As a sensitivity analysis, we used this correction but it leads to substantially larger numbers of estimated deaths in adults from malaria (appendix p 21). We have chosen not to correct the data for the main results of this paper because it would adjust deaths in adults upwards which is contrary to expert opinion in the literature.

In view of the fact that we have not applied the sensitivity and specificity corrections, we have instead modified the redistribution of garbage codes such as fever of unknown origin or ill-defined deaths, so that we do not redistribute garbage codes to malaria in adults. We have also updated all the times-series covariates tested in the models: rainfall, health-system access, antimalarial drug resistance weighted by drug use, ITN coverage, indoor residual spraying coverage, income per head, and educational attainment. We have also included in the model the 2010 *P falciparum* parasite rate (PfPR) map from the Malaria Atlas Project.¹⁰⁸ A coherent analysis of PfPR overtime is underway but was not available for this analysis (see the appendix pp 223–40 for details on the CODEm model analysis). As in the Murray and colleagues study, we developed separate models for sub-Saharan Africa and outside of Africa (with the exception of South Africa, which was modelled with countries outside of Africa, given the low malaria endemicity), age under 5 years and 5 years or higher, and males and females.

For countries that have only or mainly *Plasmodium vivax* transmission we used the number of deaths by year and age from vital registration data as a simple predictor of malaria mortality using a negative binomial regression model.

We estimated malaria cases separately for three sets of countries, which were divided on the basis of the availability and quality of malaria incidence data (see appendix pp 241–42 for the list of countries). The first group contained countries with unavailable or unreliable malaria case reporting systems. We estimated malaria incidence in these countries using a mortality-incidence model, in which we predicted malaria incidence by regressing the log-

transformed study-level incidence on the log-transformed malaria mortality rate, age-group indicators, a sub-Saharan Africa indicator, an indicator distinguishing active versus passive case detection (set to active when generating predictions), and the ratio of the site-specific PfPR to national PfPR (from MAP 2010; set to the value 1 when generating predictions so that the estimates are nationally representative). In this model, the incidence data came from available studies and the mortality data came from our CODEm analysis. The second group included countries for which there were incomplete administrative data, for which we predicted malaria incidence by regressing incidence data from the World Malaria Report 2013 on national-level PfPR. We corrected for underreporting using a composite indicator for health system access as a proxy. The third group contained countries with complete and reliable administrative case reports, for which we used reported numbers as published in the World Malaria Report.

CoDCorrect algorithm

As with all causes of death analysed for the GBD, we require that the sum of each individual cause of death for a country, age, sex, and year equals the estimate of all-cause mortality. The CoDCorrect algorithm rescales the sum of causes at the individual draw level. The effect of this simple algorithm is to change causes that have larger uncertainty intervals if there is a mismatch between the sum of cause-specific mortality and all-cause mortality. To preserve the relations between incidence, prevalence, and death that come from the Spectrum analysis, the entire epidemic curve for HIV is scaled in CoDCorrect.

Role of the funding source

The sponsor of the study had no role in study design, data collection, data analysis, data interpretation, or writing of the report. The authors had access to the data in the study and the final responsibility to submit the paper for publication.

Results

Figure 7 shows the estimated trend in global numbers of incident cases, people living with HIV (prevalence), and deaths from HIV. Global HIV incidence peaked in 1997 with 2.8 million (95% uncertainty intervals 2.7 to 3.1) new infections and has since decreased at 2.7% (2.0 to 3.1) per year. From 1997 to 2005, incidence decreased at 3.8% (3.0 to 4.6) per year and from 2005 to 2013 at 1.6% (0.6 to 2.4) per year. New infections in children decreased from 340 000 (323 000 to 363 000) in 2000 to 134 000 (123 000 to 152 000) in 2013 at an annualised rate of change (ARC) of -7.2% (-7.8 to -6.4%), while new infections in adults decreased from 2.3 million (2.1 million to 2.4 million) to 1.7 million (1.6 million to 2.0 million), falling at 2.4% (1.6 to 3.0) per year, on average, during this period. Annual incidence estimated by UNAIDS is uniformly higher in the years shown and shows a sharper rate of decrease. Prevalence of individuals infected with HIV has steadily risen to 29.2 million (28.1 million to 31.7 million) in 2013 rising more rapidly from 1990 until about 2000 at an annual rate of change of 10.6% (10.1 to 11.3), and increasing at 1.2% (0.9 to 1.4) per year since (figure 7). Compared with UNAIDS's estimations, our estimation for 2012 suggest 6.6 million fewer individuals living with HIV. 32.0% of this difference is in sub-Saharan Africa and 68.0% is elsewhere. Figure 7 shows trends for HIV deaths compared

with UNAIDS estimations, with a peak mortality of 1.7 million (1.6 million to 1.9 million) in 2005. Annual mortality has subsequently fallen to 1.3 million (1.3 million to 1.5 million) in 2013, an ARC of -3.1% (-4.0 to 2.2). While the time trend of mortality estimated by UNAIDS is similar to ours, the estimated number of deaths is substantially greater. At the peak of the epidemic in 2005, our revised assessment of the HIV epidemic suggests 635 000 fewer deaths than UNAIDS's estimates, although the difference (240 000) narrows substantially by 2012, the last year available from UNAIDS. For the interval 2005–12, the UNAIDS ARC for death numbers was -5.0% (-5.6 to -4.5), reflecting the lower assumed death rates on ART in the UNAIDS version of Spectrum.

New HIV infections are concentrated in young adults and to a much lesser extent, in children under 5 years of age (figure 8); 4.1% (3.8 to 4.5) of new infections occur in individuals older than 60 years. New cases in 2013 occurred equally in both sexes. However, there are more infections in women than men at ages 15–24 years. Incidence in children, and in older adults, is similar for both sexes. Showing a mean survival time of more than 10 years in most countries and age-groups, the age pattern of deaths peaks in women at ages 35–39 years and in men at 40–44 years (figure 8). More deaths are in male individuals (53.9% [51.9 to 56.1]) than in female individuals. The proportion of deaths that occur beyond age 60 years (6.8% [6.2 to 7.4]) is larger than the proportion of incident cases that occur beyond age 60 years (4.1% [3.8 to 4.5]).

Table 2 shows the ARCs for 1990–2000 and 2000–13 for incidence, prevalence, and death for the 21 GBD regions and the world. ARCs between two fixed time periods need to be interpreted bearing in mind that measures of the HIV epidemic such as incidence and death will have peaked and decreased in particular countries at different times during the interval. Nevertheless, our findings show the accelerated progress in most of the world's regions. The only regions with a reversal in the ARC such that incidence was decreasing but in the later period is increasing or stagnating are southeast Asia, high-income North America, western Europe, Australasia, and Tropical Latin America. The reversal in southeast Asia can be explained by the large decrease in the 1990s achieved by a successful campaign to reduce infection through commercial sex encounters in Thailand, the country in the region with the largest epidemic. The reversal of incidence trends in North America might show a wearing off of the effect of public health measures to reduce the risk of transmission in men who have sex with men.

Age-standardised HIV incidence rates per 100 000 population (figure 9) in 2013 ranged from less than 0.7 in a group of countries ringing the Eastern Mediterranean, parts of northern and central Europe, and Mongolia, to more than 570 in South Africa, Lesotho, and Swaziland. HIV infection follows distinct geographic patterns with continued high levels of infection throughout eastern and southern Africa, with some exceptions. Rwanda, Burundi, DR Congo, Congo, and Gabon all have incidence rates less than 120 per 100 000 population, lower than their neighbouring countries. Incidence rates vary widely in sub-Saharan Africa, but are more homogenous across countries in Asia as well as North and South America. Important exceptions to these patterns include incidence rates above 15 per 100 000 population in many Caribbean countries. Incidence rates are notably higher in Portugal and Ukraine, as well as Russia and some Central Asian republics. Figure 9 shows

prevalence rates in countries in 2013. Geographical patterns are similar to incidence, although some differences are noteworthy. Prevalence levels are highest in Botswana, Lesotho, and Swaziland (above 12 000 per 100 000 population). There is substantial variation within sub-Saharan Africa; prevalence rates in Botswana, for example, are 15 times higher than in the DR Congo and 40 times higher than in Niger. In southeast Asia, prevalence is substantially higher in Thailand and Papua New Guinea. Prevalence rates are comparatively high in parts of Europe and central Asia (Portugal, Spain, Ukraine, Russia, and Kazakhstan) and in Latin America and the Caribbean (Panama, Honduras, Belize, Guatemala, Guyana, Suriname, Haiti, Dominican Republic, Jamaica, and Bahamas) prevalence levels exceed 220 per 100 000 population. Comparison of incidence and prevalence in figure 9 draws attention to some differences for countries in their comparative ranking, such as for Sweden and Australia. Cross-national variations in HIV mortality rates per 100 000 population, largely mirror the pattern reported for prevalence, varying from less than 0.2 in northern and central Europe and the Eastern Mediterranean, to more than 520 in southern Africa, a roughly 2500-fold difference (figure 10). Table 3 shows more detail on the estimated number of new infections and deaths in 2013 for both sexes, individually and combined, for 188 countries, along with ARCs in age-standardised incidence and death rates for both sexes combined.

By comparing the estimated number of person-years lived in a no-intervention scenario with actual estimates, we can compute the years of life saved through ART, PMTCT, and cotrimoxazole prophylaxis. Figure 11 shows cumulative years of life saved by GBD region as a result of these interventions during three phases of scale-up. From 1990 to 2003, 1.5 million years of life (1.2 million to 1.9 million) were saved, of which only 22.7% (14.2 to 32.1) were in populations living in developing countries, largely in Brazil. The number of years of life saved increased substantially in the period 2004 to 2008 to 3.9 million (3.2 million to 4.7 million), and the share in populations in developing countries increased to 52.6% (44.1 to 62.2). Between 2009 and 2013, the number of life-years saved was 13.7 million (11.8 million to 15.7 million). A much greater share (40.8% [33.8 to 47.6]) of these life-years saved were in eastern and southern sub-Saharan Africa, and a further 12.1% (9.0 to 15.7) in western sub-Saharan Africa. Other regions to benefit substantially from HIV interventions include high-income North America, western Europe, and south Asia. The number of years of life saved continues to grow rapidly due both to the continued expansion of ART and the cumulative effect of infections prevented in children. By 2013, the global cumulative number of years of life saved was 19.1 million (16.6 million to 21.5 million); 14.2% (12.4 to 16.2) at ages younger than 15 years, 49.7% (45.8 to 53.4) at age 15–49 years, and 36.1% (32.7 to 39.5) at 50 years of age or older.

Since 2000, cumulative DAH for HIV up through 2011 totals \$51.6 billion, of which \$32.7 billion can be traced to specific developing country programmes in 2011 US dollars.¹⁰⁹ Comparison of the total amount invested in HIV prevention and treatment to the years of life saved during 2000–11 yields in developing countries a ratio of \$4498 per life-year saved. The ratio of DAH for HIV to years of life saved varies widely from \$2.38 in Uruguay per life-year saved to \$1.87 million in Mongolia per life-year saved.

The scale-up of ART has been variable across countries. Because of the temporal dynamics of the epidemic in different countries, comparisons of intervention scale-up are confounded by the timing of incidence. Nevertheless, the appendix (p 22) shows a crude comparison of years of life saved over the age of 15 years divided by prevalent cases in people older than 15 years in 2013. This ratio ranges from less than 0.07 in countries with minimal intervention to more than 0.49 in many high-income countries. In developing countries, Brazil stands out with a ratio of 0.37. In the next tier, with ratios between 0.28 and 0.35 includes many countries in Latin America and Botswana, Namibia, Thailand, Cambodia, South Korea, and some countries in central Europe. In eastern and southern Africa, Ethiopia, Rwanda, and Burundi we saw higher ratios than in many of their neighbouring countries. Pronounced variation within regions points to the historical variation in the timing of the epidemic response.

Figure 12 shows a comparison of our estimated prevalence for country-age-sex groups against national population prevalence surveys. This comparison provides a rough check that at the end of the modelling process our assessment remains consistent with population-based prevalence measurements as well as being consistent with data for all-cause mortality. In general, there is a strong correlation (0.96) of our country-age-sex estimates with survey prevalence—UNAIDS prevalence is also correlated (0.96) with survey data. However, in 21% of cases, there is a statistically significant difference (19% for UNAIDS). The coefficients obtained by regressing both GBD and UNAIDS estimates on survey estimates showed that both methods tended to be slightly higher than the surveys; however, only the UNAIDS coefficient was a statistically significantly larger than one: UNAIDS, 1.08 (1.03 to 1.13); GBD, 1.02 (0.98 to 1.06). Country-specific graphs comparing GBD, UNAIDS, and survey prevalences by age and sex are shown in the appendix (p 24).

Figure 13 shows the temporal changes of tuberculosis incident case numbers, the number of prevalent cases, and the number of deaths from 1990 to 2013. Total tuberculosis numbers are shown as well as numbers for tuberculosis in individuals who are HIV-negative. The number of incident cases for tuberculosis in individuals who are HIV-negative has increased from 5.0 million (4.8 million to 5.1 million) in 1990 to 7.1 million (6.9 million to 7.3 million) in 2013—a 1.5% (1.4 to 1.6) annual change. Prevalence in 1990 and 2013 was 1.6 times higher than incidence, implying a duration of 20 months on average for a case. Prevalence rates increased slightly between 1990 and 2000 (ARC 0.4% [0.2 to 0.6]) but decreased by 1.3% (1.4 to 1.2) per year from 2000 to 2013. Deaths from tuberculosis in individuals who are HIV-negative are decreasing at a faster rate, from 1.8 million (1.7 million to 1.9 million) in 1990 to 1.3 million (1.2 million to 1.4 million) in 2013—a -1.4% (-1.9 to -1.0) annual change. Decreases in death numbers and increases in incidence numbers implies that the case-fatality rate has been falling over the period; the ratio of deaths to incidence overall went from 0.36 (0.33 to 0.39) in 1990 to 0.18 (0.16 to 0.20) in 2013—a -2.9% (-3.4 to -2.5) per year rate of change. Most global tuberculosis incidence cases and deaths in individuals who are HIV-negative are in men and boys, 64.0% (63.6 to 64.3) for incidence and 64.7% (60.8 to 70.3) for mortality (figure 14). Although age-specific rates rise with age up to 70 years, in view of the comparatively young age-structure of countries with substantial burden of tuberculosis in individuals who are HIV-negative,

83.2% (82.6 to 83.8) of cases and 58.8% (56.7 to 60.6) of deaths were in people younger than 60 years in 2013.

Table 4 shows a summary at the global and regional level of the ARCs for age-standardised rates of incidence, prevalence, and deaths for tuberculosis in individuals who are HIV-negative (see the appendix p 203 for tuberculosis including HIV-positive individuals). At the global level, age-standardised mortality rates decreased by 3.3% (4.1 to 2.6), whereas incidence remained stable (0.0% [-0.2 to 0.2]) and prevalence rates increased by 0.4% (0.2 to 0.6) during the period 1990 to 2000. Global decreases continued in the period 2000 to 2013 for mortality (-3.7% [-4.4 to -3.0]) whereas incidence decreased by 0.6% (0.7 to 0.5) and prevalence decreased by 1.3% (1.4 to 1.2). Across regions, in the period 2000 to 2013, incidence rate ARCs in individuals who are HIV-negative ranged from 0.8% (0.6 to 1.0) in Oceania to -3.3% (-3.6 to -3.1) in high-income North America. 16 of 21 regions had a greater decrease (or at least a smaller increase) in the incidence rate from 2000 to 2013 than for 1990 to 2000. Mortality rate decreases in HIV-negative individuals were greater in the period 2000 to 2013 than the decreases in prevalence in all 21 regions. The global decline in prevalence from 2000 to 2013 is largely accounted for by the large decreases in just two regions: east and south Asia. In south Asia, which accounts for 34.8% (33.9 to 35.6) of incident cases and 47.7% (43.5 to 51.8) of deaths in 2013, the ARCs for 2000 to 2013 were -1.1% (-1.3 to -0.8) for incidence, -2.4% (-2.7 to -2.2) for prevalence, and -4.2% (-5.6 to -2.9) for mortality. Accelerated decreases in prevalence, incidence and mortality occurred in east Asia from 2000 to 2013: -3.2% (-3.4 to -2.9) for prevalence, -2.1% (-2.4 to -1.9) for incidence, and -7.5% (-8.5 to -6.6) for mortality. The tuberculosis trend in eastern Europe has reversed: in the 1990s, mortality, incidence, and prevalence rates were all increasing, with ARCs of 8.3% (5.5 to 9.1), 1.3% (1.0 to 1.7), and 1.7% (1.4 to 2.0), respectively. However, in the period 2000 to 2013 the trends for all three of these indicators have improved, with ARCs of -4.8% (-7.6 to -3.9), -0.6% (-0.8 to -0.4), and -0.7% (-1.0 to -0.5). Table 5 shows incidence and deaths by country in 2013 along with ARCs for age-standardised rates.

Figure 15 shows maps of age-standardised incidence rates and death rates for tuberculosis in individuals who are HIV-negative in 2013. Age-standardised incidence of tuberculosis in individuals who are HIV-negative is more than 200 per 100 000 population in 24 countries in sub-Saharan Africa as well as in North Korea, Timor-Leste, Cambodia, Laos, Philippines, and Kiribati (figure 15). There are an additional 16 countries with rates of more than 150 per 100 000 population that include Bangladesh, Myanmar, India, Pakistan, Ethiopia, and Malawi. Figure 15 also shows tuberculosis death rates in individuals who are HIV-negative which are above 10 per 100 000 population in all countries in sub-Saharan Africa and increase to more than 50 per 100 000 population in 40 countries. Among middle-income countries outside of sub-Saharan Africa, Afghanistan, Indonesia, India, Myanmar, and the Philippines stand out as countries with death rates higher than 50 per 100 000 population. The highest age-standardised death rates in Latin America and the Caribbean are in Haiti followed by Bolivia and Peru. Death rates per 100 000 population are highly variable in north Africa and the Middle East, ranging from very low in Syria (0.5 [0.3 to 0.9]) and Jordan (0.8 [0.6 to 1.0]) to high in Morocco [14.3 [11.2 to 17.5]) and Yemen (19.9 [11.5 to 41.5]) in 2013. Eastern Europe and central Asia stand out with death rates that are

substantially higher than western or central Europe. China has lower rates of death than eastern Europe and central Asia. Our findings are mostly consistent with the list of high-burden countries used by WHO; however, our top 22 countries in terms of case numbers or death numbers that are not on the WHO high-burden list include South Korea, North Korea, and Madagascar for case numbers and Angola and Zambia for mortality. WHO high-burden countries that did not make our top 22 list for case numbers include Afghanistan, Cambodia, and Tanzania, and the WHO high-burden countries that did not make our top 22 list for mortality include Brazil and Cambodia.

Trends in the annual number of new cases of malaria, and annual deaths from malaria, are shown in figure 16 for the period since 1990. Global incidence seems to have peaked in 2003 at 232 million cases (143 million to 387 million) and has since fallen by about 29% to 165 million new cases (95 million to 284 million) in 2013. There is massive uncertainty around these estimates: the 2013 estimate, for example, could be anywhere between 95 million and 284 million. The estimates of new malaria cases in the World Malaria Report fall within the uncertainty intervals of the GBD estimates with a mean number of new cases in 2012 of 207 million (135 million to 287 million). By contrast with incidence data, the World Malaria Report estimates of malaria deaths are slightly lower (figure 16). There are also some important differences in the timing of the peak and decline in malaria mortality. Annual malaria deaths began to decline from a peak of 1·2 million (1·1 million to 1·4 million) in 2004 to about 855 000 (703 000 to 1 032 000) in 2013, having increased from 888 000 (793 000 to 993 000) in 1990. According to the World Malaria Report,¹¹⁰ malaria caused about 627 000 deaths in 2012, having reached a peak of about 900 000 around the turn of the century. The age-sex pattern of global malaria incident cases and deaths in 2013 is shown in figure 17. The largest number of cases is in people younger than 15 years. Malaria deaths, by contrast, are concentrated in children younger than 5 years, although malaria caused between 10 000 and 25 000 deaths in each 5-year age group beyond age 15 years, so that the cumulative fraction of malaria deaths in adults reaches 33·75%.

Globally, age-standardised malaria incidence and death rates were increasing in the period 1990–2000 (table 6), but many regions outside of sub-Saharan Africa and north Africa and the Middle East had decreases in age-standardised incidence, death rates, or both. In the period since 2000, all regions including sub-Saharan Africa had decreases in age-standardised incidence and death rates. Incidence decreased by 38% (37 to 40) in central Asia since 2000, a result of increased malaria elimination efforts in the region. Figure 18 shows the geographical distribution of the age-standardised incidence rate in 2013. The geographical distribution of the age-standardised mortality rate (figure 18) shows a similar pattern with the highest rates in Mozambique, Burkina Faso, Guinea-Bissau, Mali, Sierra Leone, The Gambia, and Guinea. Rwanda stands out as having low rates compared with its neighbouring countries. Outside of Africa, Yemen, India, Myanmar, and Papua New Guinea have death rates higher than 7·5 per 100 000 population. In southeast Asia, Thailand and Malaysia have achieved very low death rates. Table 7 shows incidence and death numbers by country in 2013 along with ARCs for age-standardised rates. Four countries have over 5 million cases a year including India with over 60 million cases, Nigeria (30 million), DR Congo (with 6 million), and Mozambique (6 million). Three countries—Nigeria, DR Congo, and India—account for roughly 50% of all malaria deaths in 2013.

Discussion

HIV, tuberculosis, and malaria remain major health challenges in 2013. The mean age of death differs substantially between them, at 15.3 years for malaria, 38.6 years for HIV, and 52.9 years for tuberculosis in HIV-negative individuals, which means that the burden in terms of years of life lost varies across the diseases. Tuberculosis deaths have decreased globally since 1990, and after 2000 incidence, prevalence, and death have all decreased. HIV incidence peaked in 1997 and mortality peaked in 2005 with substantial declines since the peak in each. Malaria incidence and mortality peaked and began declining in 2004 with substantial drops in the number of child deaths in sub-Saharan Africa over the past 5 years. There is substantial variation both in levels and trends for all three diseases across countries. HIV and malaria incidence and death are concentrated in sub-Saharan Africa whereas tuberculosis burden is more widespread but most pronounced in south and southeast Asia.

From our analysis of HIV data, our findings show that the HIV epidemic is smaller than estimated by UNAIDS. Our global epidemic curve for mortality ranges was lower than estimated by UNAIDS for every year; at the peak in 2005 our estimates are 27.0% lower and in 2012 are 14.5% lower. Our estimates of global prevalence differ from UNAIDS's by 17.1% in 2005 and 18.7% in 2012. The substantial differences in the number of deaths stem from two key differences in these analyses. First, in the 125 concentrated epidemics with some cause of death data for mortality due to HIV, our estimated mortality is 52.2% lower in 2000 and 58.4% lower in 2012 than UNAIDS's estimates. Our prevalence estimates are, for example, 36.3% lower for Panama, 52.2% lower for Colombia, and 58.4% lower in Russia. Second, in the large generalised epidemics, selecting epidemic curves that are consistent with prevalence data, all-cause mortality, and available studies on survival with and without ART shifted median survival up. For example, in southern Africa, median survival off ART for the age-group 25–34 years increased from 10.5 years to 11.5 years. Longer or shorter survival off ART in some countries could be explained by genetic factors,¹¹¹⁻¹¹⁵ co-factors such as the presence of other diseases like malaria,¹¹⁶⁻¹¹⁸ differential access to treatments for opportunistic infections, or other co-factors that have not been described. These findings are important in terms of identifying the magnitude and comparative burden of HIV. Table 8 outlines the differences between our HIV/AIDS estimation strategy and that of UNAIDS.

Comparison of population-based surveys with our estimates of prevalence suggest reasonable alignment and the regression analysis of estimated prevalence on measured prevalence suggest there is not systematic tendency in our estimates to overestimate or underestimate prevalence. However, much variation exists by age and sex with nearly one in five of our age-sex specific prevalence estimates statistically different than the survey prevalences. Several potential explanations for this variation exist. Our assumptions about the relative incidence pattern by country might not be true at the local level. Differential non-response in the surveys by age and sex is also a potential factor. The adjustments made through the demographic matching and CoDCorrect algorithm could contribute to the differences. More analysis on a country-by-country basis will be helpful in exploring these issues in future research.

Revisions of the global epidemiology of HIV of this magnitude—in view of the weakness of direct measurement of incidence and death—should not be surprising. As prevalence surveys became more widely available, UNAIDS revised downward their global prevalence estimates by 18% in 2007 and their global mortality estimates by nearly 24%.¹¹⁹ Taking into account more data for survival on and off ART and incorporating all-cause mortality data has led to revisions of a similar magnitude. Our revisions also suggests that there is greater uncertainty for incidence, prevalence, and death than previously estimated. Irrespective of the specific estimates generated from imperfect data, however, our assessment of prevalence continues to point to the very large and steadily growing numbers of infected individuals, many of whom are in need of antiretroviral therapy. Great progress has been achieved reducing infections in children (62.4% reduction since the incidence peak in 2002) due to the scale-up of interventions. The continued 1.7 million new infections per year in adults, down 32.7% from the peak of the epidemic at the global scale, however, is a stark reminder of the continuing epidemic.

A key finding that confirms many local, regional, and global studies¹²⁰⁻¹²⁵ is that interventions, especially ART, PMTCT, and co-trimoxazole, have had a profound effect. Cumulatively, 19.1 million years of life have been saved since 1996, 5.7 million in developed countries and 13.4 million in developing countries, where the ratio of DAH to years of life saved is less than \$4500 for the average of the period 2000–11. In view of the very rapid increase in years of life saved in 2012 and 2013, the ratio for the period 2000–13 when DAH figures are available will probably be much lower. The scale-up, number of lives saved, and comparatively low price per year of life saved is one of the major achievements in global health in the past decade. Many groups—local, national, and global—deserve credit for this accomplishment. DAH does not count national contributions to the cost of HIV programmes; real variation in the ratio of the total cost per year of life saved is probably much smaller because many middle-income countries receive little DAH and fund most HIV interventions from their own resources. Micro-economic studies of the cost per years of life saved have also reported wide variation across locations.¹²⁶⁻¹²⁸ We would expect, given investments in initial programme start-up including capital equipment investments, that the ratio of DAH to life-years saved will decrease over time. With prevalence growing 5.8% per year over the past 5 years, the need to learn from more efficient programmes is paramount. Our analysis of survival on ART shows wide variation in programme outcomes within sub-Saharan Africa. Counterfactual analysis of what might happen if all programmes achieved the levels of mortality seen in the programmes with the best outcomes or even what would happen if high-income country on-ART death rates were achieved would help shed further light on the importance of quality improvement for future HIV death reductions. Improving cost-effectiveness of ART programmes will require a process of continuously documenting costs, outcomes, and efficiency along with a mechanism for shared learning across programmes on improving quality. HIV infected intravenous drug users have not benefited as much from treatment as those infected through sexual transmission. Regions with an ongoing increase in mortality from HIV in the 2000–13 period are high-income Asia Pacific, central and eastern Asia, eastern and central Europe, north Africa and the Middle East, Oceania, and southern and western sub-Saharan. In a number of these regions large proportions of HIV cases are in intravenous drug users for

whom countries might be less inclined to provide treatment services. Even in countries with a greater emphasis on harm-reduction strategies, drug users might still be a more difficult group for health services to reach.¹²⁹

Age-standardised tuberculosis mortality rates including tuberculosis in HIV-positive individuals at the global level changed at -2.8% (-3.6 to -2.2) per year from 1990 to 2000 and around a percentage point faster from 2000 to 2013 (-3.7% [-4.4 to -3.0%]) per year. When examining tuberculosis mortality in individuals who are HIV-negative, the acceleration was smaller, from -3.3 (-4.1 to -2.6) to -3.7% (-4.4 to -3.0) change per year but still statistically significant. There has been comparatively little decrease in the global age-standardised tuberculosis incidence rates in HIV-negative individuals although some regions such as south Asia and east Asia have seen accelerated declines since 2000. Prevalence has decreased much faster than incidence, which is consistent with earlier and more effective treatment-shortening durations. In addition to shorter duration, the death to incidence ratio changed from 0.36 in 1990 to 0.18 in 2013, also a likely consequence of treatment. There has been much regional and country variation in progress on tuberculosis with the ARC for mortality ranging from -10.3% to 2.5% from 1990 to 2013 and the ARC for incidence ranging from -3.3% to 2.5% over the same period. This variation implies that more rapid progress is possible at the global scale if lessons can be learned from countries with more rapid achievement. Since 2000, as for HIV and malaria, global progress in terms of prevalence and mortality has accelerated. We are unable to compute the extra years of life saved for tuberculosis as we can for HIV; but the comparatively small DAH for tuberculosis over the period 2000–11 (\$8.3 billion) has been associated over this time period with greater reductions in incidence, prevalence, and death rates. Tuberculosis is different from HIV and malaria in that the rising incidence and death rates with age mean that demographic ageing of the world's population in the absence of other changes will naturally lead to higher numbers of cases and deaths. Demographic changes in essence slow the progress of tuberculosis control; a factor that should be built into considerations of funding and programme strategy. The established links between alcohol, diabetes, tobacco smoking and tuberculosis also mean that trends in these risk factors can modulate trends in tuberculosis.¹³¹⁻¹³³ In this analysis, we have not separately examined the incidence, prevalence, and mortality related to multi-drug resistant tuberculosis (MDR-TB). There are concerns that even in places with substantial decreases in tuberculosis incidence, prevalence, and death such as in China, MDR-TB might be a substantial challenge.^{82,133-136} Modelling studies have shown that under specific circumstances MDR-TB could reverse important gains made in combatting tuberculosis.^{82,136,137} Future revisions of the burden of disease should examine more carefully the evidence on the levels and trends in MDR-TB.

Our results for tuberculosis differ from WHO estimates in some important ways. In general, we estimate higher mortality, lower prevalence and incidence, and a smaller fraction of tuberculosis related to HIV. Our estimates of prevalence are driven by the available prevalence surveys and are not back calculated from incidence. Our incidence estimates start with case-notifications corrected for missing age-groups and case types such as smear-negative pulmonary or extrapulmonary and expert judgment of the case-detection rate. For some countries, with implausibly large numbers of smear-negative and extra-pulmonary cases notified in individuals younger than 15 years, we have excluded these data from the

analysis. However, the Bayesian meta-regression identifies a solution for incidence that is consistent with prevalence data and estimates of cause-specific mortality. Because this analysis is undertaken using age-specific and sex-specific rates, it also takes into account the changing relations between incidence, prevalence, remission, excess mortality, and cause-specific mortality with age and sex. Because true incidence in any country is not known, our estimates as well as WHO's depend on expert judgment on the case-detection rate. Systematic bias in the estimated case-detection rate, particularly for earlier time periods, will affect not only the volume of estimated tuberculosis cases but also time trends. India accounts for 27.1% (26.3 to 27.9) of global incident cases in 2013; systematic errors in the estimated incidence in India in the 1990s would have a profound effect on global trends. Perhaps more importantly, our assessment of global trends for death are similar to WHO but differ for prevalence and somewhat for incidence. Because total age-sex-specific case notifications reported to WHO for smear-positive pulmonary tuberculosis have continued to increase—by 1.1 million in 2000, 2.3 million in 2005, and 2.5 million in 2012—differences in time trends stem from assumptions about the case-detection rate and, in our study, the incorporation of information from prevalence surveys and all-cause mortality. Table 9 outlines the differences between our tuberculosis estimation strategy and that of WHO.

Malaria burden rose steadily until 2004 and has since decreased. The Global Fund, President's Malaria Initiative, and other bilateral and private initiatives have spent \$11.3 billion in DAH from 2000 to 2011. The hypothesis that global action has been an important factor in these declines is highly plausible.^{6,110,138-141} The decline in our assessment is driven by the statistical model fitted to the available but sparse verbal autopsy data. Key independent variables in the model that drive this estimated decline are resistance for first-line agents and ITN coverage. Noor and colleagues'¹⁴² assessment of trends in PfPR from 2000 to 2010 indicate that some countries such as Malawi, Zambia, or DR Congo have had substantial scale-up of ITNs with minimal reduction or increases in PfPR. Explanations for the mismatch between ITN scale-up and changes in PfPR could lie in the estimation of any of PfPR, ITNs, or local factors that affect who actually receives and uses ITNs, or it could be a function of other factors—eg, climatic changes over this period. There could also be important threshold or saturation effects for ITNs on PfPR. While the substantial decline in child mortality in the past 5 years is welcome news, understanding the relative role of artemisin in combination treatment scale-up and vector control is challenging and might vary by country. The variability in the relation between ITNs and PfPR at the national level emphasises the risks of simply assuming that ITN scale-up at the national level will yield the percentage reduction in child deaths seen in the randomised trials; a strategy used by Child Health Epidemiology Reference Group (CHERG) in their child mortality estimates. It is also important to note that the CHERG models did not include a first-line drug resistance as a covariate. Our findings show this to be an important predictor in the Africa models in particular and a key driver of the temporal trend noted in this region. Table 10 outlines the differences between our malaria estimation strategy and that of WHO.

MDG6 brought global attention to these three diseases, ushering in an unprecedented focus on specific diseases in the broader development agenda. Despite many who questioned the wisdom of a focus on specific diseases, there has been accelerated progress on HIV, malaria, and tuberculosis since 2000. In the case of HIV, our estimation strategy allows for direct

quantification of years of life saved, which have been substantial. For tuberculosis and malaria, we see accelerated reductions in deaths and cases compared with the decade before the Millennium Declaration. Rigorously assigning causality to these accelerations to the global collective action catalysed by the Millennium Declaration is beyond the scope of this paper and likely impossible in view of the data limitations. Nevertheless, as governments and the global community debate the nature, scope, and utility of setting new global targets post-2015, these findings should be taken into consideration.

Our comparative analysis of these three diseases shows pronounced differences in data gaps and measurement challenges. Antenatal clinic serosurveillance and population surveys in generalised epidemics have been a powerful tool for tracking evolution of the HIV epidemic with real data collected on an annual basis. Cause of death data in many countries with concentrated epidemics also provide a timely way to examine the effect of HIV. But, national data for the outcome of ART is weak. Measures such as retention in care and loss to follow-up are often incomplete and difficult to compare across facilities, programmes, and countries. UNAIDS and our modelling do not routinely use national data for treatment outcomes and depend on cohort or published studies. In view of the huge effect of ART on death and prevalence, more accurate and continuous monitoring of ART outcomes and costs must be a high priority. By contrast with HIV, tuberculosis treatment outcomes are highly standardised and reported to WHO at least through the end of treatment. However, real-time data for the time-trends of tuberculosis is hard to come by. Case notifications can only be interpreted by resorting to expert opinion on the case detection rate, and prevalence surveys are infrequent and require large sample sizes. A system analogous to the antenatal clinic serosurveillance for tuberculosis would be possible if new diagnostics emerge that can quantitatively assess load of bacilli in an infected individual. Pending such a technological advance, more frequent prevalence surveys and perhaps capture-recapture studies⁸² are the only direct measurement available to track evolution of the epidemic. In our study, ARC for incidence and prevalence 2000 to 2013 is correlated (0.93). Information about malaria clinical cases and deaths is much weaker than for HIV or tuberculosis. Case reports are very incomplete. Most deaths occur in places without vital registration systems. Verbal autopsy is widely believed to exaggerate malaria deaths, especially in adults,¹⁴³⁻¹⁴⁵ in view of the tendency to overdiagnose malaria in African hospital settings;¹⁴⁶⁻¹⁴⁹ our systematic review of validation studies, though, shows low sensitivity (33%) and low specificity (93%). Bias is a function of both sensitivity and specificity. If these validation studies that are published are correct we might be underestimating and not overestimating malaria deaths in adults and children in areas with substantial malaria and the reverse in areas with little malaria. The only comparatively easy-to-measure outcome related to malaria is the *P falciparum* parasite rate. Local surveys have been usefully collated and analysed by Noor and colleagues and the Malaria Atlas Project.¹⁴² These data provide hard evidence on the trends in a measurable outcome; the challenge is that there is a loose relation in the available data between PfPR and incidence or mortality. In view of how important malaria is, the state of monitoring systems for malaria burden is poor. Repeated verbal autopsy studies combined with carefully designed validation studies would be helpful. Better data for the incidence of clinical episodes confirmed with rapid diagnostic tests and how it varies as a function of the PfPR would improve incidence estimation.

Findings for these three diseases draw attention to the difference between ICD-assigned underlying cause of death and the total mortality attributable to a disease including pathways through which a disease aggravates other disorders. ICD rules treat disorders—not just these three diseases—in this regard in substantially different ways. All deaths directly related to pregnancy and childbirth and any deaths aggravated by pregnancy are counted as maternal deaths. For HIV, all deaths in individuals who are HIV-positive are assigned to HIV unless they are due to completely incidental causes such as a road traffic injury. Following this convention, tuberculosis deaths in HIV-positive people are assigned to HIV not tuberculosis. In the case of malaria, there has long been the recognition that malaria might increase the risk of death in children and adults from other causes such as septicaemia or chronic kidney disease.¹⁵⁰⁻¹⁵² Early studies after the country-by-country elimination or rapid control of malaria documented rapid changes in deaths from pneumonia and chronic kidney disease,^{153,154} suggesting the full effects of malaria on mortality are greater than the ICD-coded malaria deaths. The ITN randomised controlled trials based on verbal autopsy documented that about half of the declines in under-5 mortality were in causes other than malaria assigned through a verbal autopsy.^{155,156} Our understanding of the magnitude of each disease is affected by the at-times arbitrary rules governing assigning causes of death.

There are two important general observations from our analysis of HIV compared with prior analyses that might be relevant to other diseases. First, we saw that concentrated epidemics have been systematically over estimated by a factor on average of more than two. Overestimation is most likely related to a tendency to overestimate the size of high-risk groups for which little information exists. Why would expert judgment be, on average, so wrong? The disconnect in many countries between expert judgment and the results emerging from the analysis of cause of death data should caution researchers in the future from too much dependence on expert judgment in descriptive epidemiology. Second, we saw a systematic under-estimation of uncertainty in many countries in the UNAIDS analysis. Their assessment for South Africa, for example, had for 2010 an uncertainty interval with a coefficient of variation of 0.03. Our assessment before matching on all-cause mortality had a coefficient of variation about six times higher (0.19) in the same year. There is a general tendency, we believe, in many modelling efforts to underestimate uncertainty when arbitrary assumptions about parameters are made. For example, the default assumptions for uncertainty in the UNAIDS Spectrum model is a coefficient of variation 0.05 for mortality on and off ART. We find from our empirical analysis coefficients of variation that range from 0.44 (in the age group 15–24 years and CD4 count greater than 500) to 1.00 (in people aged 45 years or older and a CD4 count greater than 500). In other words, uncertainty in these parameters seems to have been underestimated, with the real value approximately ten times larger. This is not a critique of the UNAIDS Spectrum modelling effort, rather a reminder that statistical analysis of parameter uncertainty often shows that we know much less than we think.

Our analysis of HIV in India based on the 2005–06 National Family Health Survey and antenatal clinic serosurveillance suggests that in 2002 there were 287 000 (199 000 to 377 000) deaths. Cause of death data, however, are available from several sources all pointing to substantially lower numbers of deaths than UNAIDS high-risk group analysis. Using data for 2001–03, investigators in the Million Death Study reported an estimated 59 000–140 000

deaths in 2004. The urban Medical Certification of Causes of Death system recorded a peak age-standardised death rate in 6.3 per 100 000 population, which is equivalent at the national level to 57 000 deaths. We did not use these sources in our assessment; the substantial mismatch between our estimates draws attention to the need for improved understanding of causes of death in India.

Some global health efforts to develop robust estimates of the burden of disease sometimes end up using both empirical measurement on incidence, prevalence, and cause-specific mortality plus coverage of interventions and assumed effectiveness of interventions. The blending of real measurement of outcome and assumed mapping of interventions to outcome is justified because recent scale-up of interventions might not be accounted for in the sparse measurements that are available. We used the modified Spectrum model to map ART coverage into likely changes in mortality from HIV. These findings are lent support in some countries by measured declines in all-cause mortality or cause-specific mortality but in other countries are based entirely on the presumed relation between intervention roll-out and mortality. Many examples of such blending of data for outcome and intervention coverage exist: CHERG estimates of decreases in child deaths due to ITNs and *Hemophilus influenza* type B vaccine coverage are not based on any statistical relation but on the assumption that interventions will yield the decreases seen in randomised trials. These are reasonable assumptions but fundamental differences exist between observing the change in outcome as opposed to assuming the outcome has changed; this difference is not immediately evident in global health estimation efforts. It can yield circular analyses in which estimates are used by other authors to assess impact. In general, in the GBD 2013, we have sought to use largely empirical data and statistical associations seen in the data to make estimates. But for HIV in particular, we have used the approach embodied in Spectrum.

This analysis of data for HIV, tuberculosis, and malaria has many limitations in view of the ambition to track incidence, prevalence, and mortality for 188 countries from 1990 to 2013. First, ART estimates for 2013 are highly preliminary. Countries have reported ART scale-up through 2012 and provided estimates for 2013. Many of these estimates were aspirational and we have used growth rates over the 5 years 2008–12 to adjust these 2013 estimates. Second, we have not independently validated the country reports of ART scale-up. We have added to the uncertainty by randomly varying ART scale-up by sampling a uniform distribution from plus to minus 10% but this presumes that, on average, ART scale-up is not exaggerated. Third, we have used 102 studies of ART outcomes to inform our assumptions of death rates on ART. There was much variation across sites. More recent programmes might be achieving better outcomes than previous studies have shown if there has been shared learning across programmes. Available studies might also be biased towards better outcomes through the publication bias; poor programmes are unlikely to seek to publish their results. There was insufficient national data to use local information about each country on ART programmes. Our estimates might be biased up or down for a given country because local ART outcomes might be better or worse than the sub-Saharan Africa average. Future rounds of estimation will be substantially improved by more robust ART treatment outcome data obtained from nationally representative samples of patients on ART across a wider range of countries. Fourth, we have sought to find epidemic curves for the major

generalised epidemics that are both consistent with available prevalence data and all-cause mortality data derived from sources such as vital registration or sibling histories in household surveys. The process of matching all-cause mortality draws and Spectrum outputs that are consistent also substantially reduces uncertainty. In view of the mismatch of these data sources, we are probably underestimating uncertainty in these countries. Fifth, we have not modified the UNAIDS assumptions for survival in children infected with HIV. However, published studies from high-income countries pre-ART suggest much higher survival.¹⁵⁷ Our estimates of death in the age-groups 5–9 years and 10–14 years might therefore be exaggerated. Sixth, our estimates of uncertainty for HIV could be underestimated because some of our uncertainty ranges for parameter inputs have been selected arbitrarily and true variation, for example, in age-sex patterns of incidence might be larger. The idea that variations in age-sex patterns of incidence might be larger is lent support by the number of age-sex-country-years in which our estimates of prevalence are different to those available from national prevalence surveys. Seventh, on the basis of debate over the burden of malaria in adults, we chose not to redistribute garbage code deaths onto malaria in verbal autopsy studies in adults, which led to a reduction in the estimated number of adult malaria deaths. Although this choice was informed by expert opinion, it was not based on any direct data. Even without the redistribution of garbage codes, the percentage of deaths occurring in adults in Africa is still high and has to be interpreted with caution in view of the potential for misclassification bias in verbal autopsies. Alternatively, the choice not to redistribute ill-defined codes onto malaria might bias our adult deaths downwards. Eighth, Noor and colleagues have published PfPR for 2000 and 2010.¹⁴² A full time-series of PfPR would be a useful covariate for modelling the burden of malaria. The Malaria Atlas Project is working on such time-series analysis of PfPR and when it is finalised it would strengthen the analysis of malaria trends. Ninth, our uncertainty intervals for malaria incidence and mortality incorporate sampling uncertainty, non-sampling uncertainty, and model-specification uncertainty, but do not incorporate the uncertainty that can stem from misclassification biases in verbal autopsy. Uncertainty is probably underestimated due to the limitations of verbal autopsy for malaria in children and adults. Tenth, findings from other studies in countries such as The Gambia suggest substantial decreases in malaria in these settings; in our analysis of mortality, however, these types of studies have not been used.^{158,159} Eleventh, our analysis of tuberculosis assumes that local expert judgment about the case-detection rate is unbiased; this assumption, however, might be incorrect for countries with higher or lower case-detection rates. Twelfth, our uncertainty intervals for tuberculosis incidence and prevalence generated from DisMod-MR 2.0 are probably underestimated. The intervals are narrow because we have extensive data inputs for essentially all countries in the form of adjusted case-notifications and CODEm estimates of all-cause mortality. Although each data point has substantial uncertainty, the meta-regression produces narrow estimates of the predicted mean value for an age-sex-country-year because of the extensive and often consistent data. These intervals do not capture the potential for systematic error in some of the data-processing steps such as the use of the expert-based case-detection rate. Despite these important limitations, the GBD approach has many advantages, primarily because it is a comprehensive and clearly documented approach to disease burden estimation that examines all the available data and invests substantial

effort into standardisation of definitions, data adjustments, and modelling across all diseases and injuries.

The focus of the global health community on action to reduce HIV/AIDS, tuberculosis, and malaria, enshrined in MDG6, was not only appropriate in 2000 at the Millennium Declaration, but is increasingly relevant now in view of the slow but important progress that disease control strategies have yielded, particularly since 2005. Much remains to be done, however: although evidence now exists that the implementation of known interventions is beginning to have an effect, it is probably less than is widely believed, or hoped. But these interventions are working, and need to be rapidly scaled up with more funding, more emphasis on national health system strengthening in key affected countries to increase access to them by the poor, and more targeted research to accelerate progress. What is also clear from this analysis as we enter the final phase of the MDG era is how little we reliably know in many countries to track progress. Rapidly reducing the massive uncertainty that surrounds the measurement of these diseases, particularly malaria, will be essential if we are to better monitor, and respond to, evidence about progress, or not, with their control.

Supplementary Material

Refer to Web version on PubMed Central for supplementary material.

Authors

Christopher J L Murray, Katrina F Ortblad, Caterina Guinovart, Stephen S Lim, Timothy M Wolock, D Allen Roberts, Emily A Dansereau, Nicholas Graetz, Ryan M Barber, Jonathan C Brown, Haidong Wang, Herbert C Duber, Mohsen Naghavi, Daniel Dicker, Lalit Dandona, Joshua A Salomon, Kyle R Heuton, Kyle Foreman, David E Phillips, Thomas D Fleming, Abraham D Flaxman, Bryan K Phillips, Elizabeth K Johnson, Megan S Coggeshall, Foad Abd-Allah[†], Semaw Ferede[†], Jerry P Abraham[†], Ibrahim Abubakar[†], Laith J Abu-Raddad[†], Niveen Me Abu-Rmeileh[†], Tom Achoki[†], Austine Olufemi Adeyemo[†], Arsène Kouablan Adou[†], José C Adsuar[†], Emilie Elisabet Agardh[†], Dickens Akena[†], Mazin J Al Kahbouri[†], Deena Alasfoor[†], Mohammed I Albittar[†], Gabriel Alcalá-Cerra[†], Miguel Angel Alegretti[†], Zewdie Aderaw Alemu[†], Rafael Alfonso-Cristancho[†], Samia Alhabib[†], Raghib Ali[†], Francois Alla[†], Peter J Allen[†], Ubai Alsharif[†], Elena Alvarez[†], Nelson Alvis-Guzman[†], Adansi A Amankwaa[†], Azmeraw T Amare[†], Hassan Amini[†], Walid Ammar[†], Benjamin O Anderson[†], Carl Abelardo T Antonio[†], Palwasha Anwari[†], Johan Ärnlöv[†], Valentina S Arsic Arsenijevic[†], Ali Artaman[†], Rana J Asghar[†], Reza Assadi[†], Lydia S Atkins[†], Alaa Badawi[†], Kalpana Balakrishnan[†], Amitava Banerjee[†], Sanjay Basu[†], Justin Beardsley[†], Tolesa Bekele[†], Michelle L Bell[†], Eduardo Bernabe[†], Tariku Jibat Beyene[†], Neeraj Bhala[†], Ashish Bhalla[†], Zulfiqar A Bhutta[†], Aref Bin Abdulhak[†], Agnes Binagwaho[†], Jed D Blore[†], Berrak Bora Basara[†], Dipan Bose[†], Michael Brainin[†], Nicholas Breitborde[†], Carlos A Castañeda-Orjuela[†], Ferrán Catalá-López[†], Vineet K Chadha[†], Jung-Chen Chang[†], Peggy Pei-Chia Chiang[†], Ting-Wu Chuang[†], Mercedes Colomar[†], Leslie Trumbull Cooper[†], Cyrus Cooper[†], Karen J Courville[†], Benjamin C Cowie[†], Michael H Criqui[†], Rakhi

Dandona[†], Anand Dayama[†], Diego De Leo[†], Louisa Degenhardt[†], Borja Del Pozo-Cruz[†], Kebede Deribe[†], Don C Des Jarlais[†], Muluken Dessalegn[†], Samath D Dharmaratne[†], U ur Dilmen[†], Eric L Ding[†], Tim R Driscoll[†], Adnan M Durrani[†], Richard G Ellenbogen[†], Sergey Petrovich Ermakov[†], Alireza Esteghamati[†], Emerito Jose A Faraon[†], Farshad Farzadfar[†], Seyed-Mohammad Fereshtehnejad[†], Daniel Obadare Fijabi[†], Mohammad H Forouzanfar[†], Urbano Fra. Paleo[†], Lynne Gaffikin[†], Amiran Gamkrelidze[†], Fortuné Gbètoho Gankpé[†], Johanna M Geleijnse[†], Bradford D Gessner[†], Katherine B Gibney[†], Ibrahim Abdelmageem Mohamed Ginawi[†], Elizabeth L Glaser[†], Philimon Gona[†], Atsushi Goto[†], Hebe N Gouda[†], Harish Chander Gugnani[†], Rajeev Gupta[†], Rahul Gupta[†], Nima Hafezi-Nejad[†], Randah Ribhi Hamadeh[†], Mouhanad Hammami[†], Graeme J Hankey[†], Hilda L Harb[†], Josep Maria Haro[†], Rasmus Havmoeller[†], Simon I Hay[†], Mohammad T Hedayati[†], Ileana B Heredia Pi[†], Hans W Hoek[†], John C Hornberger[†], H Dean Hosgood[†], Peter J Hotez[†], Damian G Hoyt[†], John J Huang[†], Kim M Iburg[†], Bulat T Idrisov[†], Kaire Innos[†], Kathryn H Jacobsen[†], Panniyammakal Jeemon[†], Paul N Jensen[†], Vivekanand Jha[†], Guohong Jiang[†], Jost B Jonas[†], Knud Juel[†], Haidong Kan[†], Ida Kankindi[†], Nadim E Karam[†], André Karch[†], Corine Kakizi Karema[†], Anil Kaul[†], Norito Kawakami[†], Dhruv S Kazi[†], Andrew H Kemp[†], Andre Pascal Kengne[†], Andre Keren[†], Maia Kereselidze[†], Yousef Saleh Khader[†], Shams Eldin Ali Hassan Khalifa[†], Ejaz Ahmed Khan[†], Young-Ho Khang[†], Irma Khonelidze[†], Yohannes Kinfu[†], Jonas M Kinge[†], Luke Knibbs[†], Yoshihiro Kokubo[†], S Kosen[†], Barthelemy Kuate Defo[†], Veena S Kulkarni[†], Chanda Kulkarni[†], Kaushalendra Kumar[†], Ravi B Kumar[†], G Anil Kumar[†], Gene F Kwan[†], Taavi Lai[†], Arjun Lakshmana Balaji[†], Hilton Lam[†], Qing Lan[†], Van C Lansingh[†], Heidi J Larson[†], Anders Larsson[†], Jong-Tae Lee[†], James Leigh[†], Mall Leinsalu[†], Ricky Leung[†], Yichong Li[†], Yongmei Li[†], Graça Maria Ferreira De Lima[†], Hsien-Ho Lin[†], Steven E Lipshultz[†], Shiwei Liu[†], Yang Liu[†], Belinda K Lloyd[†], Paulo A Lotufo[†], Vasco Manuel Pedro Machado[†], Jennifer H Maclachlan[†], Carlos Magis-Rodriguez[†], Marek Majdan[†], Christopher Chabila Mapoma[†], Wagner Marcenes[†], Melvin Barrientos Marzan[†], Joseph R Masci[†], Mohammad Taufiq Mashal[†], Amanda J Mason-Jones[†], Bongani M Mayosi[†], Tasara T Mazorodze[†], Abigail Cecilia Mckay[†], Peter A Meaney[†], Man Mohan Mehndiratta[†], Fabiola Mejia-Rodriguez[†], Yohannes Adama Melaku[†], Ziad A Memish[†], Walter Mendoza[†], Ted R Miller[†], Edward J Mills[†], Karzan Abdulmuhsin Mohammad[†], Ali H Mokdad[†], Glen Liddell Mola[†], Lorenzo Monasta[†], Marcella Montico[†], Ami R Moore[†], Rintaro Mori[†], Wilkister Nyaora Moturi[†], Mitsuru Mukaigawara[†], Kinnari S Murthy[†], Aliya Naheed[†], Kovin S Naidoo[†], Luigi Naldi[†], Vinay Nangia[†], K M Venkat Narayan[†], Denis Nash[†], Chakib Nejjari[†], Robert G Nelson[†], Sudan Prasad Neupane[†], Charles R Newton[†], Marie Ng[†], Muhammad Imran Nisar[†], Sandra Nolte[†], Ole F Norheim[†], Vincent Nowaseb[†], Luke Nyakarahuka[†], In-Hwan Oh[†], Takayoshi Ohkubo[†], Bolajoko O Olusanya[†], Saad B Omer[†], John Nelson Opio[†], Orish Ebere Orisakwe[†], Jeyaraj D Pandian[†], Christina Papachristou[†], Angel J Paternina Caicedo[†], Scott B Patten[†], Vinod K Paul[†], Boris Igor Pavlin[†], Neil Pearce[†], David M Pereira[†], Aslam Pervaiz[†], Konrad Pesudovs[†], Max Petzold[†], Farshad Pourmalek[†], Dima Qato[†], Amado D Quezada[†], D Alex Quistberg[†], Anwar Rafay[†], Kazem Rahimi[†], Vafa Rahimi-Movaghar[†], Sajjad Ur Rahman[†], Murugesan

Raju[†], Saleem M Rana[†], Homie Razavi[†], Robert Quentin Reilly[†], Giuseppe Remuzzi[†], Jan Hendrik Richardus[†], Luca Ronfani[†], Nobhojit Roy[†], Nsanzimana Sabin[†], Mohammad Yahya Saeedi[†], Mohammad Ali Sahraian[†], Genesis May J Samonte[†], Monika Sawhney[†], Ione J C Schneider[†], David C Schwebel[†], Soraya Seedat[†], Sadaf G Sepanlou[†], Edson E Servan-Mori[†], Sara Sheikhabahaei[†], Kenji Shibuya[†], Hwashin Hyun Shin[†], Ivy Shiue[†], Rupak Shivakoti[†], Inga Dora Sigfusdottir[†], Donald H Silberberg[†], Andrea P Silva[†], Edgar P Simard[†], Jasvinder A Singh[†], Vegard Skirbekk[†], Karen Sliwa[†], Samir Soneji[†], Sergey S Soshnikov[†], Chandrashekar T Sreeramareddy[†], Vasiliki Kalliopi Stathopoulou[†], Konstantinos Stroumpoulis[†], Soumya Swaminathan[†], Bryan L Sykes[†], Karen M Tabb[†], Roberto Tchio Talongwa[†], Eric Yeboah Tenkorang[†], Abdullah Sulieman Terkawi[†], Alan J Thomson[†], Andrew L Thorne-Lyman[†], Jeffrey A Towbin[†], Jefferson Traebert[†], Bach X Tran[†], Zacharie Tsala Dimbuene[†], Miltiadis Tsilimbaris[†], Uche S Uchendu[†], Kingsley N Ukwaja[†], Selen Begüm Uzun[†], Andrew J Vallely[†], Tommi J Vasankari[†], N Venketasubramanian[†], Francesco S Violante[†], Vasilii Victorovich Vlassov[†], Stein Emil Vollset[†], Stephen Waller[†], Mitchell T Wallin[†], Linhong Wang[†], XiaoRong Wang[†], Yanping Wang[†], Scott Weichenthal[†], Elisabete Weiderpass[†], Robert G Weintraub[†], Ronny Westerman[†], Richard A White[†], James D Wilkinson[†], Thomas Neil Williams[†], Solomon Meseret Woldeyohannes[†], John Q Wong[†], Gelin Xu[†], Yang C Yang[†], Yuichiro Yano[†], Gokalp Kadri Yentur[†], Paul Yip[†], Naohiro Yonemoto[†], Seok-Jun Yoon[†], Mustafa Younis[†], Chuanhua Yu[†], Kim Yun Jin[†], Maysaa El Sayed Zaki[†], Yong Zhao[†], Yingfeng Zheng[†], Maigeng Zhou[†], Jun Zhu[†], Xiao Nong Zou[†], Alan D Lopez[‡], and Theo Vos[‡]

Institute for Health Metrics and Evaluation (Prof C J L Murray DPhil, K F Ortblad MPH, C Guinovart PhD, S S Lim PhD, T M Wolock BA, D A Roberts BS, E A Dansereau BA, N Graetz BS, R M Barber BS, J C Brown MAIS, H Wang PhD, H C Duber MD, M Naghavi PhD, D Dicker BS, Prof L Dandona MD, K R Heuton BS, D E Phillips BS, T D Fleming BS, A D Flaxman PhD, B K Phillips BA, E K Johnson BA, M S Coggeshall BA, M H Forouzanfar MD, Prof A H Mokdad PhD, M Ng PhD, Prof T Vos PhD), Harborview and University of Washington Medicine, Seattle, WA, USA (Prof R G Ellenbogen MD), **University of Washington, Seattle, WA, USA** (R Alfonso-Cristancho PhD, Prof B O Anderson MD, P N Jensen MPH, D A Quistberg PhD); Public Health Foundation of India, New Delhi, India (Prof L Dandona, R Dandona PhD, G A Kumar PhD, K S Murthy MPH); **Imperial College London, London, UK** (K Foreman MPH, Prof T N Williams MD); **Harvard School of Public Health** (E L Ding ScD), **Harvard University, Cambridge, MA, USA** (Prof J A Salomon PhD); Faculty of Medicine, Cairo-University, Cairo, Egypt (Prof F Abd-Allah MD); College of Health Sciences, School of Public Health (S F Abera MSc), **Mekelle University, Mekelle, Ethiopia** (Y A Melaku MPH); University of Texas School of Medicine San Antonio, San Antonio, TX, USA (J P Abraham MD); **University College London, London, UK** (Prof I Abubakar PhD); Weill Cornell Medical College in Qatar, Doha, Qatar (L J Abu-Raddad PhD); Institute of Community and Public Health-Birzeti University, Ramallah, West Bank, Occupied Palestinian Territory (N M Abu-Rmeileh PhD); **Ministry of Health, Gaborone, Botswana** (T Achoki MD); Evidence For Action (MamaYe), Freetown, Western

Area, Sierra Leone (A O Adeyemo MHM); Association Ivoirienne Pour Le Bien Etre Familial, Abidjan, Côte d'Ivoire (A K Adou MD); **University of Extremadura, Cáceres, Spain** (Prof J C Adsuar PhD, U Fra.Paleo PhD); Institution of Public Health Sciences, Stockholm, Sweden (E E Agardh PhD); **Makerere University, Kampala, Uganda** (D Akena PhD, L Nyakarahuka MPH); **Ministry of Health, Muscat, Oman** (M J Al Kahbouri PhD, D Alasfoor MSc); **Independent, Damascus, Syria** (M I Albittar MSc); Grupo de Investigación en Ciencias de la Salud y Neurociencias (CISNEURO), Cartagena de Indias, Colombia (G Alcalá-Cerra MD); Facultad de Medicina, Departamento de Medicina Preventiva y Social, Universidad de la República, Montevideo, Uruguay (M A Alegretti MD); **Debre Markos University, Debre Markos, Ethiopia** (Z A Alemu MPH); National Guard Health Affairs, Riyadh, Saudi Arabia (S Alhabib PhD); **University of Oxford, Oxford, UK** (R Ali MSc, Prof S I Hay DPhil, K Rahimi DM); School of Public Health, University of Lorraine, Nancy, France (Prof F Alla PhD); **Ministry of Health, Belmopan, Cayo, Belize** (P J Allen MPH); Charité Universitätsmedizin Berlin, Berlin, Germany (U Alsharif DMD, S Nolte PhD, C Papachristou PhD); **Government, Madrid, Spain** (E Alvarez PhD); Universidad de Cartagena, Cartagena de Indias, Colombia (Prof N Alvis-Guzman PhD, A J Paternina Caicedo MSc); **Albany State University, Albany, GA, USA** (Prof A A Amankwaa PhD); Department of Epidemiology, University of Groningen, Groningen, The Netherlands and College of Medicine and Health Sciences, Bahir Dar University, Bahir Dar, Ethiopia (A T Amare MPH); Kurdistan Environmental Health Research Center, Kurdistan University of Medical Sciences, Sanandaj, Kurdistan, Iran (H Amini MSPH); **Ministry of Public Health, Beirut, Lebanon**(Prof W Ammar PhD, H L Harb MPH); College of Public Health, University of the Philippines Manila, Manila, Philippines (C A T Antonio MD, E J A Faraon MD); **UNFPA, Kabul, Afghanistan** (P Anwari MSc); **Uppsala University, Uppsala, Sweden** (J Ärnlov PhD, Prof A Larsson PhD); **Malaria & Other Parasitic Diseases Division** (C K Karema MSc), **Ministry of Health, Kigali, Rwanda** (A Binagwaho MMed [Ped], I Kankindi MSc); Institute of Microbiology and Immunology, School of Medicine, University of Belgrade, Belgrade, Serbia (Prof V S Arsic Arsenijevic PhD); **Median Inc, Windsor, ON, Canada** (A Artaman PhD); South Asian Public Health Forum, Islamabad, Pakistan (R J Asghar MD); Mashhad University of Medical Sciences, Mashhad, Iran (R Assadi PhD); Ministry of Health, Wellness, Human Services and Gender Relations, Castries, St. Lucia (L S Atkins MPH); Public Health Agency of Canada, Toronto, ON, Canada (A Badawi PhD); **Sri Ramachandra University, Chennai, India** (Prof K Balakrishnan PhD); **University of Birmingham, Birmingham, UK** (A Banerjee DPhil); **Stanford University School of Medicine** (L Gaffikin DrPH), **Stanford University** (S Basu PhD), Stanford, CA, USA; Oxford University, Ho Chi Minh City, Vietnam (J Beardsley MBChB); **Madawalabu University, Bale Goba, Ethiopia** (T Bekele MPH); **Yale University, New Haven, CT, USA** (Prof M L Bell PhD, J J Huang MD); **King's College London, London, UK** (E Bernabe PhD); **Addis Ababa University, Addis Ababa, Ethiopia** (T J Beyene MSC, K Deribe MPH); **Wellington Hospital, Wellington, New Zealand** (N Bhala DPhil); Postgraduate Institute of Medical Education and Research, Chandigarh, India (A Bhalla MD, Prof V Jha DM); Aga

Khan University Medical Center, Nairobi, Kenya (Prof Z A Bhutta PhD); University of Missouri-Kansas City, Kansas City, MO, USA (A Bin Abdulhak MD); General Practice and Primary Health Care Academic Centre (P P Chiang PhD), University of Melbourne, Melbourne, VIC, Australia (J D Blore PhD, A Lakshmana Balaji MBBS, Prof A D Lopez PhD, R G Weintraub MB); Murdoch Children's Research Institute, Royal Children's Hospital, Melbourne, VIC, Australia (R G Weintraub); **General Directorate of Health Research** (B Bora Basara PhD, G K Yentur PhD), **Ministry of Health, Ankara, Turkey** (Prof U Dilmen MD, S B Uzan MD); **World Bank, Washington, DC, USA** (D Bose PhD); **Danube-University Krems, Krems, Austria** (Prof M Brainin PhD); **University of Arizona, Tucson, AZ, USA** (Prof N Breitborde PhD); Colombian National Health Observatory, Instituto Nacional de Salud, Bogota, Colombia (C A Castañeda-Orjuela MSc); Division of Pharmacoepidemiology and Pharmacovigilance, Spanish Medicines and Healthcare Products Agency (AEMPS), Ministry of Health, Madrid, Spain (F Catalá-López PhD); National Tuberculosis Institute, Bangalore, India (V K Chadha MD); Institute of Epidemiology and Preventive Medicine (H Lin ScD), **National Taiwan University, Taipei, Taiwan** (Prof J Chang PhD); Department of Parasitology, College of Medicine, Taipei Medical University, Taipei, Taiwan and Center for International Tropical Medicine, College of Medicine, Taipei Medical University, Taipei, Taiwan (Prof T Chuang PhD); **UNICEM, Montevideo, Uruguay** (M Colomar MSc); **Mayo Clinic, Rochester, MN, USA** (Prof L T Cooper MD); MRC Lifecourse Epidemiology Unit, University of Southampton, Southampton, UK (Prof C Cooper FMedSci); Hospital Dr. Gustavo N. Collado, Chitre, Herrera, Panama (K J Courville MD); Victorian Infectious Diseases Reference Laboratory, North Melbourne, VIC, Australia (B C Cowie PhD, J H Maclachlan MSc); University of California, San Diego, La Jolla, CA, USA (Prof M H Criqui MD); **Emory University School of Medicine** (A Dayama MD), **Emory University, Atlanta, GA, USA** (Prof Y Liu PhD, Prof K M V Narayan MD, S B Omer PhD); **Griffith University, Brisbane, QLD, Australia** (Prof D De Leo DSc); **The Kirby Institute** (A J Vallely PhD), University of New South Wales, Sydney, NSW, Australia (Prof L Degenhardt PhD); **University of Auckland, Auckland, New Zealand** (B Del Pozo-Cruz PhD); **Beth Israel Medical Center, New York, NY, USA** (Prof D C Des Jarlais PhD); Africa Medical and Research Foundation in Ethiopia, Addis Ababa, Ethiopia (M Dessalegn MPH); **University of Peradeniya, Peradeniya, Sri Lanka** (S D Dharmaratne MD); **Sydney School of Public Health** (T R Driscoll PhD), **University of Sydney, Sydney, NSW, Australia** (J Leigh PhD); National Institutes of Health, Montgomery Village, MD, USA (A M Durrani MD); The Institute of Social and Economic Studies of Population at the Russian Academy of Sciences, Moscow, Russia (Prof S P Ermakov DSc); **Non-Communicable Diseases Research Center** (F Farzadfar MD), **Endocrinology and Metabolism Research Center** (Prof A Esteghamati MD, N Hafezi-Nejad MD, S Sheikhabahaei MD), **Sina Trauma and Surgery Research Center** (Prof V Rahimi-Movaghar MD), **MS Research Center** (M A Sahraian MD), **Digestive Diseases Research Institute** (S G Sepanlou MD), Tehran University of Medical Sciences, Tehran, Iran; Department of Neurobiology, Care Sciences and Society (NVS) (S Fereshtehnejad MD), Department of Medical Epidemiology and

Biostatistics (Prof E Weiderpass PhD), **Karolinska Institutet, Stockholm, Sweden** (R Havmoeller PhD); **Heller Graduate School, (D O Fijabi MBBS), Heller School for Social Policy and Management (E L Glaser MSc), Brandeis University, Waltham, MA, USA** (B T Idrisov MD); National Centre for Disease Control and Public Health, Tbilisi, Georgia (A Gamkrelidze PhD, M Kereselidze PhD, I Khonelidze MPA); Clinique Coopérative de Parakou, Parakou, Borgou, Benin (F G Gankpé MD); Division of Human Nutrition, Wageningen University, Wageningen, Netherlands (J M Geleijnse PhD); **Agence de Medecine Preventive, Paris, France** (B D Gessner MD); **Eastern Health Clinical School (B K Lloyd PhD), Monash University, Melbourne, VIC, Australia** (K B Gibney MBBS); Turning Point, Eastern Health, Fitzroy, VIC, Australia (B K Lloyd); College of Medicine, University of Hail, Hail, Saudi Arabia (I A M Ginawi MD); University of Massachusetts Medical School, Worcester, MA, USA (Prof P Gona PhD); Department of Diabetes Research, National Center for Global Health and Medicine, Tokyo, Japan (A Goto PhD); **School of Population Health (D G Hoy PhD), University of Queensland, Brisbane, QLD, Australia** (H N Gouda PhD, L Knibbs PhD); Public Health Division, Secretariat of the Pacific Community, Noumea, New Caledonia (D G Hoy); Saint James School of Medicine, Kralendijk, Bonaire, Netherlands Antilles (Prof H C Gugnani PhD); **Fortis Escorts Hospital, Jaipur, India** (R Gupta PhD); Kanawha Charleston Health Department, Charleston, WV, USA (R Gupta MD); **Arabian Gulf University, Manama, Bahrain** (Prof R R Hamadeh DPhil); Wayne County Department of Health and Human Services, Detroit, MI, USA (M Hammami MD); School of Medicine and Pharmacology, University of Western Australia, Perth, WA, Australia (Prof G J Hankey MD); Parc Sanitari Sant Joan de Déu, CIBERSAM, University of Barcelona, Sant Boi de Llobregat, Barcelona, Spain (Prof J M Haro MD); Mazandaran University of Medical Sciences, Sari, Mazandaran, Iran (Prof M T Hedayati PhD); National Institute of Public Health of Mexico, Cuernavaca, Morelos, Mexico (I B Heredia Pi PhD, F Mejia-Rodriguez MD, A D Quezada MSc, Prof E E Servan-Mori MSc); Parnassia Psychiatric Institute, The Hague, Netherlands (Prof H W Hoek MD); **Cedar Associates, Menlo Park, CA, USA** (Prof J C Hornberger MD); Albert Einstein College of Medicine, Bronx, NY, USA (Prof H D Hosgood PhD); **Baylor College of Medicine, Houston, TX, USA** (Prof P J Hotez PhD); **Aarhus University, Aarhus, Denmark** (K M Iburg PhD); National Institute for Health Development, Tallinn, Estonia (K Innos PhD, M Leinsalu PhD); **George Mason University, Fairfax, VA, USA** (K H Jacobsen PhD); Centre for Chronic Disease Control, New Delhi, India (P Jeemon PhD); Tianjin Centers for Diseases Control and Prevention, Tianjin, China (Prof G Jiang MD); Department of Ophthalmology, Medical Faculty Mannheim of the University of Heidelberg, Mannheim, Germany (Prof J B Jonas MD); The National Institute of Public Health, Copenhagen, Denmark (Prof K Juel PhD); **Fudan University, Shanghai, China** (Prof H Kan MD); **University of Balamand, Beirut, Lebanon** (Prof N E Karam MD); Helmholtz Centre for Infection Research, Braunschweig, Germany and German Center for Infection Research (DZIF), Hannover-Braunschweig site, Germany (A Karch MD); **Oklahoma State University, Tulsa, OK, USA** (A Kaul MD); **School of Public Health (Prof N**

Kawakami MD), **University of Tokyo, Tokyo, Japan** (Prof K Shibuya MD); University of California San Francisco, San Francisco, CA, USA (D S Kazi MD); **University of São Paulo, São Paulo, Brazil** (Prof A H Kemp PhD, Prof P A Lotufo DrPH); South African Medical Research Council, Cape Town, Western Cape, South Africa (A P Kengne PhD); Cardiology, Hadassah Ein Kerem University Hospital, Jerusalem, Israel (Prof A Keren MD); Jordan University of Science and Technology, Al-Ramtha, Jordan (Prof Y S Khader ScD); **Supreme Council of Health, Doha, Qatar** (S E A H Khalifa MSc); Health Services Academy, Islamabad, Punjab, Pakistan (E A Khan MPH); Institute of Health Policy and Management, Seoul National University College of Medicine, Seoul, South Korea (Prof Y Khang PhD); **University of Canberra, Canberra, ACT, Australia** (Y Kinfu PhD); Department of Infectious Disease Epidemiology, Division of Infectious Disease Control and Department of Health Statistics, Division of Epidemiology (R A White PhD), Norwegian Institute of Public Health, Oslo, Norway (J M Kinge PhD, Prof V Skirbekk PhD, Prof S E Vollset MD); Department of Preventive Cardiology, Department of Preventive Medicine and Epidemiologic Informatics, National Cerebral and Cardiovascular Center, Suita, Osaka, Japan (Y Kokubo PhD); Center for Community Empowerment, Health Policy & Humanities, NIHRD, Jakarta, Indonesia (S Kosen MD); **University of Montreal, Montreal, QC, Canada** (Prof B Kuate Defo PhD); **Arkansas State University, Jonesboro, AR, USA** (V S Kulkarni PhD); Rajrajeshwari Medical College & Hospital, Bangalore, Karnataka, India (Prof C Kulkarni PhD); International Institute for Population Sciences, Mumbai, Maharashtra, India (K Kumar MPS); Indian Institute of Public Health, Public Health Foundation of India, Gurgaon, Haryana, India (R B Kumar MD); **Boston Medical Center, Boston, MA, USA** (G F Kwan MD); **Fourth View Consulting, Tallinn, Estonia** (T Lai PhD); Institute of Health Policy and Development Studies, National Institutes of Health, Manila, Philippines (Prof H Lam PhD); **National Cancer Institute, Rockville, MD, USA** (Q Lan PhD); **IAPB and Vision 2020 LA, Weston, FL, USA** (V C Lansingh PhD); London School of Hygiene and Tropical Medicine, Bloomsbury, UK (H J Larson PhD, Prof N Pearce PhD); **Korea University, Seoul, South Korea** (Prof J Lee PhD, Prof S Yoon PhD); University at Albany, The State University of New York, Rensselaer, NY, USA (R Leung PhD); National Center for Chronic and Non-communicable Disease Control and Prevention, Chinese Center for Disease Control and Prevention, Beijing, China (Y Li MPH, S Liu PhD, Prof L Wang MD, Prof M Zhou PhD); **Genentech, Inc, South San Francisco, CA, USA** (Y Li PhD); **Unidade Local de Saude de Matosinhos** (G M Lima BSc), **Northern Region Health Administration** (V M P Machado MSc), Public Health Department, Porto, Portugal; Wayne State University, Miami, FL, USA (S E Lipshultz MD); Centro Nacional para la Prevención y el Control del VIH/SIDA, Mexico City, Mexico (C Magis-Rodriguez PhD); Department of Public Health, Faculty of Health Sciences and Social Work, Trnava University, Trnava, Slovakia (M Majdan PhD); **University of Zambia, Lusaka, Zambia** (C C Mapoma PhD); **Queen Mary, University of London, London, UK** (Prof W Marcenes PhD); University of the East Ramon Magsaysay Medical Center, Quezon City, Philippines (M B Marzan MSc); Elmhurst Hospital Center, Mount Sinai Services, Elmhurst, NY, USA (Prof J R Masci MD);

Ministry of Public Health, Kabul, Afghanistan (M T Mashal PhD); **University of York, York, UK** (A J Mason-Jones PhD); Faculty of Health Sciences, Hatter Institute for Cardiovascular Research in Africa (Prof K Sliwa PhD), University of Cape Town, Cape Town, Western Cape, South Africa (Prof B M Mayosi DPhil); AIDC EC, Port Elizabeth, Eastern Cape, South Africa (T T Mazorodze MA); **EmergentCorp, Belize City, Belize** (A C Mckay PhD); **Pereleman School of Medicine** (P A Meaney MD), University of Pennsylvania, Philadelphia, PA, USA (Prof D H Silberberg MD); Janakpuri Superspecialty Hospital, New Delhi, India (Prof M M Mehndiratta MD); **Ministry of Health, Riyadh, Saudi Arabia** (Prof Z A Memish MD, M Y Saeedi PhD); **UNFPA, Lima, Peru** (W Mendoza MD); Pacific Institute for Research & Evaluation, Calverton MD, USA and Centre for Population Health Research, Curtin University, Perth, WA, Australia, (T R Miller PhD); **University of Ottawa, Ottawa, ON, Canada** (E J Mills PhD); **University of Salahaddin, Erbil, Iraq** (K A Mohammad PhD); University of Papua New Guinea, Port Moresby, NCD, Papua New Guinea (Prof G L Mola MD); Institute for Maternal and Child Health-IRCCS "Burlo Garofolo," Trieste, Italy (L Monasta DSc, M Montico Msc, L Ronfani PhD); **University of North Texas, Denton, TX, USA** (Prof A R Moore PhD); National Center for Child Health and Development, Setagaya, Tokyo, Japan (R Mori PhD); **Egerton University, Egerton, Rift Valley, Kenya** (W N Moturi PhD); Tokyo Medical and Dental University, Bunkyo-ku, Tokyo, Japan (M Mukaigawara MD); International Centre for Diarrhoeal Diseases Research, Dhaka, Bangladesh (A Naheed PhD); University of KwaZulu-Natal, Durban, KwaZulu-Natal, South Africa (Prof K S Naidoo PhD); Azienda Ospedaliera papa Giovanni XXIII, Bergamo, Italy (Prof L Naldi MD); **Suraj Eye Institute, Nagpur, Maharashtra, India** (Prof V Nangia MD); School of Public Health, City University of New York, New York, NY, USA (Prof D Nash PhD); **Faculty of Medicine, Fez, Morocco** (Prof C Nejjari PhD); National Institute of Diabetes and Digestive and Kidney Diseases, Phoenix, AZ, USA (R G Nelson PhD); Norwegian Center for Addiction Research (SERAF), University of Oslo, Oslo, Norway (S P Neupane MBBS); Kenya Medical Research Institute Wellcome Trust Programme, Kilifi, Kenya (Prof C R Newton MD); **Aga Khan University, Karachi, Pakistan** (M I Nisar MSc); **University of Bergen, Bergen, Norway** (Prof O F Norheim PhD, Prof S E Vollset); **Polytechnic of Namibia, Windhoek, Namibia** (V Nowaseb MSc); **Kyung Hee University, Seoul, Korea** (I Oh PhD); Teikyo University School of Medicine, Tokyo, Japan (Prof T Ohkubo MD); Center for Healthy Start Initiative, Ikoyi, Lagos, Nigeria (B O Olusanya PhD); Lira District Local Government, Lira Municipal Council, Northern Uganda, Uganda (J N Opio MPH); Toxicology Unit, Faculty of Pharmacy, University of Port Harcourt, Port Harcourt, Rivers State, Nigeria (Prof O E Orisakwe PhD); Christian Medical College Ludhiana, Ludhiana, India (Prof J D Pandian MD); **University of Calgary, Calgary, AB, Canada** (Prof S B Patten PhD); **AIIMS, New Delhi, India** (Prof V K Paul MD); **Independent, Waigani, NCD, Papua New Guinea** (B I Pavlin MD); 3B's Research Group-Biomaterials, Biodegradables and Biomimetics, University of Minho, Headquarters of the European Institute of Excellence on Tissue Engineering and Regenerative Medicine and ICVS/3B's-PT Government Associate Laboratory, Braga, Portugal (Prof D M Pereira PhD); Postgraduate Medical Institute,

Lahore, Punjab, Pakistan (A Pervaiz MHA); **Flinders University, Adelaide, SA, Australia** (Prof K Pesudovs PhD); Centre for Applied Biostatistics, Sahlgrenska Academy, University of Gothenburg, Gothenburg, Sweden (Prof M Petzold PhD); University of British Columbia, Vancouver, BC, Canada (F Pourmalek PhD); College of Pharmacy, University of Illinois, Chicago, IL, USA (Prof D Qato PhD); **Contech Intl., Lahore, Punjab, Pakistan** (A Rafay MS); **Hamad Medical Corporation, Doha, Qatar** (S U Rahman FRCPCH); **University of Missouri, Columbia, MO, USA** (M Raju PhD); Department of Public Health, University of the Punjab, Lahore, Punjab, Pakistan (S M Rana PhD); **Center for Disease Analysis, Louisville, CO, USA** (H Razavi PhD); **Private consultant, Cairns, QLD, Australia** (R Q Reilly MPH); IRCCS Mario Negri Institute for Pharmacological Research, Centro Anna Maria Astori, Bergamo, Italy (Prof G Remuzzi MD); Erasmus MC, University Medical Center Rotterdam, Rotterdam, Netherlands (Prof J H Richardus PhD); **BARC Hospital, Mumbai, Maharashtra, India** (Prof N Roy MD); **Rwanda Bio-Medical Center, Kigali, Rwanda** (N Sabin MD); National HIV/AIDS & STI Surveillance and Strategic Information Unit, National Epidemiology Center, Department of Health, Manila, National Capital Region, Philippines (G M J Samonte MD); **Marshall University, Huntington, WV, USA** (M Sawhney PhD); Federal University of Santa Catarina, Florianópolis, Brazil (I J C Schneider PhD); University of Alabama at Birmingham, Birmingham, AL, USA (Prof D C Schwebel PhD, J A Singh MD); Stellenbosch University, Cape Town, Western Cape, South Africa (Prof S Seedat PhD); **Health Canada, Ottawa, ON, Canada** (H H Shin PhD, S Weichenthal PhD); **Heriot-Watt University, Edinburgh, UK** (I Shiue PhD); **Center for Clinical Global Health Education** (R Shivakoti PhD), Johns Hopkins Bloomberg School of Public Health, Johns Hopkins University, Baltimore, MD, USA (B X Tran PhD); **Reykjavik University, Reykjavik, Iceland** (Prof I D Sigfusdottir PhD); Instituto Nacional de Epidemiología Dr Juan H Jara, Mar del Plata, Buenos Aires, Argentina (A P Silva MgSc); Surveillance and Health Services Research Program American Cancer Society, Atlanta, GA, USA (E P Simard PhD); **Dartmouth College, Lebanon, NH, USA** (S Soneji PhD); Federal Research Institute for Health Organization and Informatics of Ministry of Health of the Russian Federation, Moscow, Russia (S S Soshnikov PhD); Faculty of Medicine and Health Sciences, University Tunku Abdul Rahman, Kajang, Selangor, Malaysia (C T Sreeramareddy MD); Centre Hospitalier Nord Deux-Sevres, Bressuire, France (V K Stathopoulou MD); KEELPNO (Centre for Disease Control, Greece, dispatched to "Alexandra" General Hospital of Athens), Athens, Greece (K Stroumpoulis PhD); National Institute for Research in Tuberculosis, Chennai, Tamil Nadu, India (S Swaminathan MD); Department of Criminology, Law and Society (and Sociology), University of California-Irvine, Chicago, IL, USA (B L Sykes PhD); **University of Illinois, Champaign, IL, USA** (K M Tabb PhD); Ministry of Health-MINSANTE, Yaounde, Centre, Cameroon (R T Talongwa MD); **Memorial University, St John's, NL, Canada** (E Y Tenkorang PhD); Department of Anesthesiology, University of Virginia, Charlottesville, VA, USA, and Department of Anesthesiology, King Fahad Medical City, Riyadh, Saudi Arabia (A S Terkawi MD); Adaptive Knowledge Management, Victoria, BC, Canada (A J Thomson PhD); The Earth Institute, Columbia University, New York, NY, USA

(A L Thorne-Lyman ScD); Cincinnati Children's Hospital Medical Center, Cincinnati, OH, USA (Prof J A Towbin MD); University of Southern Santa Catarina, Palhoça, Santa Catarina, Brazil (Prof J Traebert PhD); Department of Population Sciences and Development, Faculty of Economics and Management, University of Kinshasa, Kinshasa, Democratic Republic of the Congo (Z Tsala Dimbuene PhD); Department of Medicine, University of Crete, Heraklion, Greece (Prof M Tsilimbaris PhD); Department of Veterans Affairs, Washington, DC, USA (U S Uchendu MD); Department of Internal Medicine, Federal Teaching Hospital Abakaliki, Abakaliki, Ebonyi State, Nigeria (K N Ukwaja MD); UKK Institute for Health Promotion Research, Tampere, Finland (Prof T J Vasankari PhD); Neuroscience Centre, Raffles Hospital, Singapore, Singapore (N Venketasubramanian MD); **University of Bologna, Bologna, Italy** (Prof F S Violante MD); **Higher School of Economics, Moscow, Russia** (Prof V V Vlassov MD); Uniformed Services University of Health Sciences, Bethesda, MD, USA (S Waller MD); VA Medical Center and Georgetown University Neurology Department, Washington, DC, USA (M T Wallin MD); Shandong University Affiliated Jinan Central Hospital, Jinan, China (X R Wang PhD); National Office for Maternal and Child Health Surveillance, Chengdu, China (Prof Y Wang BS, Prof J Zhu MD); **University of Marburg, Marburg, Germany** (R Westerman PhD); **University of Miami, Miami, FL, USA** (J D Wilkinson MD); Institute of Public Health, University of Gondar, Gondar, Ethiopia (S M Woldeyohannes MPH); Ateneo School of Medicine and Public Health, Pasig City, Metro Manila, Philippines (J Q Wong MD); Nanjing University School of Medicine, Jinling Hospital, Nanjing, China (Prof G Xu PhD); University of North Carolina at Chapel Hill, Chapel Hill, NC, USA (Y C Yang PhD); Division of Cardiovascular Medicine, Jichi Medical University School of Medicine, Shimotsuke, Tochigi, Japan (Y Yano MD); The University of Hong Kong, Hong Kong, Hong Kong (Prof P Yip PhD); National Center of Neurology and Psychiatry, Kodira, Tokyo, Japan (N Yonemoto MPH); **Jackson State University, Jackson, MS, USA** (Prof M Younis PhD); Department of Epidemiology and Biostatistics, School of Public Health and Global Health Institute, Wuhan University, Wuhan, China (Prof C Yu PhD); TCM MEDICAL TK SDN BHD, Nusajaya, Johor Bahru, Malaysia (K Yun Jin PhD); **Mansoura Faculty of Medicine, Mansoura, Egypt** (Prof M E S Zaki MD); **Chongqing Medical University, Chongqing, China** (Prof Y Zhao MD); Zhongshan Ophthalmic Center, Sun Yat-sen University, Guangzhou, China (Y Zheng PhD); Cancer Institute/Hospital, Chinese Academy of Medical Sciences, Beijing, China (Prof X N Zou MD)

Affiliations

Institute for Health Metrics and Evaluation (Prof C J L Murray DPhil, K F Ortblad MPH, C Guinovart PhD, S S Lim PhD, T M Wolock BA, D A Roberts BS, E A Dansereau BA, N Graetz BS, R M Barber BS, J C Brown MAIS, H Wang PhD, H C Duber MD, M Naghavi PhD, D Dicker BS, Prof L Dandona MD, K R Heuton BS, D E Phillips BS, T D Fleming BS, A D Flaxman PhD, B K Phillips BA, E K Johnson BA, M S Coggeshall BA, M H Forouzanfar MD, Prof A H Mokdad PhD, M Ng PhD, Prof T Vos PhD), Harborview and University of Washington Medicine, Seattle, WA, USA

(Prof R G Ellenbogen MD), **University of Washington, Seattle, WA, USA** (R Alfonso-Cristancho PhD, Prof B O Anderson MD, P N Jensen MPH, D A Quistberg PhD); Public Health Foundation of India, New Delhi, India (Prof L Dandona, R Dandona PhD, G A Kumar PhD, K S Murthy MPH); **Imperial College London, London, UK** (K Foreman MPH, Prof T N Williams MD); **Harvard School of Public Health (E L Ding ScD), Harvard University, Cambridge, MA, USA** (Prof J A Salomon PhD); Faculty of Medicine, Cairo-University, Cairo, Egypt (Prof F Abd-Allah MD); College of Health Sciences, School of Public Health (S F Abera MSc), **Mekelle University, Mekelle, Ethiopia** (Y A Melaku MPH); University of Texas School of Medicine San Antonio, San Antonio, TX, USA (J P Abraham MD); **University College London, London, UK** (Prof I Abubakar PhD); Weill Cornell Medical College in Qatar, Doha, Qatar (L J Abu-Raddad PhD); Institute of Community and Public Health-Birzeti University, Ramallah, West Bank, Occupied Palestinian Territory (N M Abu-Rmeileh PhD); **Ministry of Health, Gaborone, Botswana** (T Achoki MD); Evidence For Action (MamaYe), Freetown, Western Area, Sierra Leone (A O Adeyemo MHM); Association Ivoirienne Pour Le Bien Etre Familial, Abidjan, Côte d'Ivoire (A K Adou MD); **University of Extremadura, Cáceres, Spain** (Prof J C Adsuar PhD, U Fra.Paleo PhD); Institution of Public Health Sciences, Stockholm, Sweden (E E Agardh PhD); **Makerere University, Kampala, Uganda** (D Akena PhD, L Nyakarahuka MPH); **Ministry of Health, Muscat, Oman** (M J Al Kahbouri PhD, D Alasfoor MSc); **Independent, Damascus, Syria** (M I Albittar MSc); Grupo de Investigación en Ciencias de la Salud y Neurociencias (CISNEURO), Cartagena de Indias, Colombia (G Alcalá-Cerra MD); Facultad de Medicina, Departamento de Medicina Preventiva y Social, Universidad de la República, Montevideo, Uruguay (M A Alegretti MD); **Debre Markos University, Debre Markos, Ethiopia** (Z A Alemu MPH); National Guard Health Affairs, Riyadh, Saudi Arabia (S Alhabib PhD); **University of Oxford, Oxford, UK** (R Ali MSc, Prof S I Hay DPhil, K Rahimi DM); School of Public Health, University of Lorraine, Nancy, France (Prof F Alla PhD); **Ministry of Health, Belmopan, Cayo, Belize** (P J Allen MPH); Charité Universitätsmedizin Berlin, Berlin, Germany (U Alsharif DMD, S Nolte PhD, C Papachristou PhD); **Government, Madrid, Spain** (E Alvarez PhD); Universidad de Cartagena, Cartagena de Indias, Colombia (Prof N Alvis-Guzman PhD, A J Paternina Caicedo MSc); **Albany State University, Albany, GA, USA** (Prof A A Amankwaa PhD); Department of Epidemiology, University of Groningen, Groningen, The Netherlands and College of Medicine and Health Sciences, Bahir Dar University, Bahir Dar, Ethiopia (A T Amare MPH); Kurdistan Environmental Health Research Center, Kurdistan University of Medical Sciences, Sanandaj, Kurdistan, Iran (H Amini MSPH); **Ministry of Public Health, Beirut, Lebanon**(Prof W Ammar PhD, H L Harb MPH); College of Public Health, University of the Philippines Manila, Manila, Philippines (C A T Antonio MD, E J A Faraon MD); **UNFPA, Kabul, Afghanistan** (P Anwari MSc); **Uppsala University, Uppsala, Sweden** (J Ärnlöv PhD, Prof A Larsson PhD); **Malaria & Other Parasitic Diseases Division** (C K Karema MSc), **Ministry of Health, Kigali, Rwanda** (A Binagwaho MMed [Ped], I Kankindi MSc); Institute of Microbiology and Immunology, School of Medicine, University of Belgrade, Belgrade, Serbia (Prof V S Arsic

Arsenijevic PhD); **Median Inc, Windsor, ON, Canada** (A Artaman PhD); South Asian Public Health Forum, Islamabad, Pakistan (R J Asghar MD); Mashhad University of Medical Sciences, Mashhad, Iran (R Assadi PhD); Ministry of Health, Wellness, Human Services and Gender Relations, Castries, St. Lucia (L S Atkins MPH); Public Health Agency of Canada, Toronto, ON, Canada (A Badawi PhD); **Sri Ramachandra University, Chennai, India** (Prof K Balakrishnan PhD); **University of Birmingham, Birmingham, UK** (A Banerjee DPhil); **Stanford University School of Medicine** (L Gaffikin DrPH), **Stanford University** (S Basu PhD), Stanford, CA, USA; Oxford University, Ho Chi Minh City, Vietnam (J Beardsley MBChB); **Madawalabu University, Bale Goba, Ethiopia** (T Bekele MPH); **Yale University, New Haven, CT, USA** (Prof M L Bell PhD, J J Huang MD); **King's College London, London, UK** (E Bernabe PhD); **Addis Ababa University, Addis Ababa, Ethiopia** (T J Beyene MSc, K Deribe MPH); **Wellington Hospital, Wellington, New Zealand** (N Bhala DPhil); Postgraduate Institute of Medical Education and Research, Chandigarh, India (A Bhalla MD, Prof V Jha DM); Aga Khan University Medical Center, Nairobi, Kenya (Prof Z A Bhutta PhD); University of Missouri-Kansas City, Kansas City, MO, USA (A Bin Abdulhak MD); General Practice and Primary Health Care Academic Centre (P P Chiang PhD), University of Melbourne, Melbourne, VIC, Australia (J D Blore PhD, A Lakshmana Balaji MBBS, Prof A D Lopez PhD, R G Weintraub MB); Murdoch Children's Research Institute, Royal Children's Hospital, Melbourne, VIC, Australia (R G Weintraub); **General Directorate of Health Research** (B Bora Basara PhD, G K Yentur PhD), **Ministry of Health, Ankara, Turkey** (Prof U Dilmen MD, S B Uzan MD); **World Bank, Washington, DC, USA** (D Bose PhD); **Danube-University Krems, Krems, Austria** (Prof M Brainin PhD); **University of Arizona, Tucson, AZ, USA** (Prof N Breitborde PhD); Colombian National Health Observatory, Instituto Nacional de Salud, Bogota, Colombia (C A Castañeda-Orjuela MSc); Division of Pharmacoepidemiology and Pharmacovigilance, Spanish Medicines and Healthcare Products Agency (AEMPS), Ministry of Health, Madrid, Spain (F Catalá-López PhD); National Tuberculosis Institute, Bangalore, India (V K Chadha MD); Institute of Epidemiology and Preventive Medicine (H Lin ScD), **National Taiwan University, Taipei, Taiwan** (Prof J Chang PhD); Department of Parasitology, College of Medicine, Taipei Medical University, Taipei, Taiwan and Center for International Tropical Medicine, College of Medicine, Taipei Medical University, Taipei, Taiwan (Prof T Chuang PhD); **UNICEM, Montevideo, Uruguay** (M Colomar MSc); **Mayo Clinic, Rochester, MN, USA** (Prof L T Cooper MD); MRC Lifecourse Epidemiology Unit, University of Southampton, Southampton, UK (Prof C Cooper FMedSci); Hospital Dr. Gustavo N. Collado, Chitre, Herrera, Panama (K J Courville MD); Victorian Infectious Diseases Reference Laboratory, North Melbourne, VIC, Australia (B C Cowie PhD, J H Maclachlan MSc); University of California, San Diego, La Jolla, CA, USA (Prof M H Criqui MD); **Emory University School of Medicine** (A Dayama MD), **Emory University, Atlanta, GA, USA** (Prof Y Liu PhD, Prof K M V Narayan MD, S B Omer PhD); **Griffith University, Brisbane, QLD, Australia** (Prof D De Leo DSc); **The Kirby Institute** (A J Vallely PhD), University of New South Wales, Sydney, NSW, Australia (Prof L Degenhardt PhD); **University of**

Auckland, Auckland, New Zealand (B Del Pozo-Cruz PhD); **Beth Israel Medical Center, New York, NY, USA** (Prof D C Des Jarlais PhD); Africa Medical and Research Foundation in Ethiopia, Addis Ababa, Ethiopia (M Dessalegn MPH); **University of Peradeniya, Peradeniya, Sri Lanka** (S D Dharmaratne MD); **Sydney School of Public Health** (T R Driscoll PhD), **University of Sydney, Sydney, NSW, Australia** (J Leigh PhD); National Institutes of Health, Montgomery Village, MD, USA (A M Durrani MD); The Institute of Social and Economic Studies of Population at the Russian Academy of Sciences, Moscow, Russia (Prof S P Ermakov DSc); **Non-Communicable Diseases Research Center** (F Farzadfar MD), **Endocrinology and Metabolism Research Center** (Prof A Esteghamati MD, N Hafezi-Nejad MD, S Sheikhabahaei MD), **Sina Trauma and Surgery Research Center** (Prof V Rahimi-Movaghar MD), **MS Research Center** (M A Sahraian MD), **Digestive Diseases Research Institute** (S G Sepanlou MD), Tehran University of Medical Sciences, Tehran, Iran; Department of Neurobiology, Care Sciences and Society (NVS) (S Fereshtehnejad MD), Department of Medical Epidemiology and Biostatistics (Prof E Weiderpass PhD), **Karolinska Institutet, Stockholm, Sweden** (R Havmoeller PhD); **Heller Graduate School**, (D O Fijabi MBBS), **Heller School for Social Policy and Management** (E L Glaser MSc), **Brandeis University, Waltham, MA, USA** (B T Idrisov MD); National Centre for Disease Control and Public Health, Tbilisi, Georgia (A Gamkrelidze PhD, M Kereselidze PhD, I Khonelidze MPA); Clinique Coopérative de Parakou, Parakou, Borgou, Benin (F G Gankpé MD); Division of Human Nutrition, Wageningen University, Wageningen, Netherlands (J M Geleijnse PhD); **Agence de Medecine Preventive, Paris, France** (B D Gessner MD); **Eastern Health Clinical School** (B K Lloyd PhD), **Monash University, Melbourne, VIC, Australia** (K B Gibney MBBS); Turning Point, Eastern Health, Fitzroy, VIC, Australia (B K Lloyd); College of Medicine, University of Hail, Hail, Saudi Arabia (I A M Ginawi MD); University of Massachusetts Medical School, Worcester, MA, USA (Prof P Gona PhD); Department of Diabetes Research, National Center for Global Health and Medicine, Tokyo, Japan (A Goto PhD); **School of Population Health** (D G Hoy PhD), University of Queensland, Brisbane, QLD, Australia (H N Gouda PhD, L Knibbs PhD); Public Health Division, Secretariat of the Pacific Community, Noumea, New Caledonia (D G Hoy); Saint James School of Medicine, Kralendijk, Bonaire, Netherlands Antilles (Prof H C Gugnani PhD); **Fortis Escorts Hospital, Jaipur, India** (R Gupta PhD); Kanawha Charleston Health Department, Charleston, WV, USA (R Gupta MD); **Arabian Gulf University, Manama, Bahrain** (Prof R R Hamadeh DPhil); Wayne County Department of Health and Human Services, Detroit, MI, USA (M Hammami MD); School of Medicine and Pharmacology, University of Western Australia, Perth, WA, Australia (Prof G J Hankey MD); Parc Sanitari Sant Joan de Déu, CIBERSAM, University of Barcelona, Sant Boi de Llobregat, Barcelona, Spain (Prof J M Haro MD); Mazandaran University of Medical Sciences, Sari, Mazandaran, Iran (Prof M T Hedayati PhD); National Institute of Public Health of Mexico, Cuernavaca, Morelos, Mexico (I B Heredia Pi PhD, F Mejia-Rodriguez MD, A D Quezada MSc, Prof E E Servan-Mori MSc); Parnassia Psychiatric Institute, The Hague, Netherlands (Prof H W Hoek MD); **Cedar**

Associates, Menlo Park, CA, USA (Prof J C Hornberger MD); Albert Einstein College of Medicine, Bronx, NY, USA (Prof H D Hosgood PhD); **Baylor College of Medicine, Houston, TX, USA** (Prof P J Hotez PhD); **Aarhus University, Aarhus, Denmark** (K M Iburg PhD); National Institute for Health Development, Tallinn, Estonia (K Innos PhD, M Leinsalu PhD); **George Mason University, Fairfax, VA, USA** (K H Jacobsen PhD); Centre for Chronic Disease Control, New Delhi, India (P Jeemon PhD); Tianjin Centers for Diseases Control and Prevention, Tianjin, China (Prof G Jiang MD); Department of Ophthalmology, Medical Faculty Mannheim of the University of Heidelberg, Mannheim, Germany (Prof J B Jonas MD); The National Institute of Public Health, Copenhagen, Denmark (Prof K Juel PhD); **Fudan University, Shanghai, China** (Prof H Kan MD); **University of Balamand, Beirut, Lebanon** (Prof N E Karam MD); Helmholtz Centre for Infection Research, Braunschweig, Germany and German Center for Infection Research (DZIF), Hannover-Braunschweig site, Germany (A Karch MD); **Oklahoma State University, Tulsa, OK, USA** (A Kaul MD); **School of Public Health** (Prof N Kawakami MD), **University of Tokyo, Tokyo, Japan** (Prof K Shibuya MD); University of California San Francisco, San Francisco, CA, USA (D S Kazi MD); **University of São Paulo, São Paulo, Brazil** (Prof A H Kemp PhD, Prof P A Lotufo DrPH); South African Medical Research Council, Cape Town, Western Cape, South Africa (A P Kengne PhD); Cardiology, Hadassah Ein Kerem University Hospital, Jerusalem, Israel (Prof A Keren MD); Jordan University of Science and Technology, Al-Ramtha, Jordan (Prof Y S Khader ScD); **Supreme Council of Health, Doha, Qatar** (S E A H Khalifa MSc); Health Services Academy, Islamabad, Punjab, Pakistan (E A Khan MPH); Institute of Health Policy and Management, Seoul National University College of Medicine, Seoul, South Korea (Prof Y Khang PhD); **University of Canberra, Canberra, ACT, Australia** (Y Kinfu PhD); Department of Infectious Disease Epidemiology, Division of Infectious Disease Control and Department of Health Statistics, Division of Epidemiology (R A White PhD), Norwegian Institute of Public Health, Oslo, Norway (J M Kinge PhD, Prof V Skirbekk PhD, Prof S E Vollset MD); Department of Preventive Cardiology, Department of Preventive Medicine and Epidemiologic Informatics, National Cerebral and Cardiovascular Center, Suita, Osaka, Japan (Y Kokubo PhD); Center for Community Empowerment, Health Policy & Humanities, NIHRD, Jakarta, Indonesia (S Kosen MD); **University of Montreal, Montreal, QC, Canada** (Prof B Kuate Defo PhD); **Arkansas State University, Jonesboro, AR, USA** (V S Kulkarni PhD); Rajrajeshwari Medical College & Hospital, Bangalore, Karnataka, India (Prof C Kulkarni PhD); International Institute for Population Sciences, Mumbai, Maharashtra, India (K Kumar MPS); Indian Institute of Public Health, Public Health Foundation of India, Gurgaon, Haryana, India (R B Kumar MD); **Boston Medical Center, Boston, MA, USA** (G F Kwan MD); **Fourth View Consulting, Tallinn, Estonia** (T Lai PhD); Institute of Health Policy and Development Studies, National Institutes of Health, Manila, Philippines (Prof H Lam PhD); **National Cancer Institute, Rockville, MD, USA** (Q Lan PhD); **IAPB and Vision 2020 LA, Weston, FL, USA** (V C Lansingh PhD); London School of Hygiene and Tropical Medicine, Bloomsbury, UK (H J Larson PhD, Prof N Pearce PhD); **Korea University, Seoul,**

South Korea (Prof J Lee PhD, Prof S Yoon PhD); University at Albany, The State University of New York, Rensselaer, NY, USA (R Leung PhD); National Center for Chronic and Non-communicable Disease Control and Prevention, Chinese Center for Disease Control and Prevention, Beijing, China (Y Li MPH, S Liu PhD, Prof L Wang MD, Prof M Zhou PhD); **Genentech, Inc, South San Francisco, CA, USA** (Y Li PhD); **Unidade Local de Saude de Matosinhos** (G M Lima BSc), **Northern Region Health Administration** (V M P Machado MSc), Public Health Department, Porto, Portugal; Wayne State University, Miami, FL, USA (S E Lipshultz MD); Centro Nacional para la Prevención y el Control del VIH/SIDA, Mexico City, Mexico (C Magis-Rodriguez PhD); Department of Public Health, Faculty of Health Sciences and Social Work, Trnava University, Trnava, Slovakia (M Majdan PhD); **University of Zambia, Lusaka, Zambia** (C C Mapoma PhD); **Queen Mary, University of London, London, UK** (Prof W Marcenés PhD); University of the East Ramon Magsaysay Medical Center, Quezon City, Philippines (M B Marzan MSc); Elmhurst Hospital Center, Mount Sinai Services, Elmhurst, NY, USA (Prof J R Masci MD); **Ministry of Public Health, Kabul, Afghanistan** (M T Mashal PhD); **University of York, York, UK** (A J Mason-Jones PhD); Faculty of Health Sciences, Hatter Institute for Cardiovascular Research in Africa (Prof K Sliwa PhD), University of Cape Town, Cape Town, Western Cape, South Africa (Prof B M Mayosi DPhil); AIDC EC, Port Elizabeth, Eastern Cape, South Africa (T T Mazorodze MA); **EmergentCorp, Belize City, Belize** (A C McKay PhD); **Pereleman School of Medicine** (P A Meaney MD), University of Pennsylvania, Philadelphia, PA, USA (Prof D H Silberberg MD); Janakpuri Superspecialty Hospital, New Delhi, India (Prof M M Mehndiratta MD); **Ministry of Health, Riyadh, Saudi Arabia** (Prof Z A Memish MD, M Y Saeedi PhD); **UNFPA, Lima, Peru** (W Mendoza MD); Pacific Institute for Research & Evaluation, Calverton MD, USA and Centre for Population Health Research, Curtin University, Perth, WA, Australia, (T R Miller PhD); **University of Ottawa, Ottawa, ON, Canada** (E J Mills PhD); **University of Salahaddin, Erbil, Iraq** (K A Mohammad PhD); University of Papua New Guinea, Port Moresby, NCD, Papua New Guinea (Prof G L Mola MD); Institute for Maternal and Child Health-IRCCS “Burlo Garofolo,” Trieste, Italy (L Monasta DSc, M Montico Msc, L Ronfani PhD); **University of North Texas, Denton, TX, USA** (Prof A R Moore PhD); National Center for Child Health and Development, Setagaya, Tokyo, Japan (R Mori PhD); **Egerton University, Egerton, Rift Valley, Kenya** (W N Moturi PhD); Tokyo Medical and Dental University, Bunkyo-ku, Tokyo, Japan (M Mukaigawara MD); International Centre for Diarrhoeal Diseases Research, Dhaka, Bangladesh (A Naheed PhD); University of KwaZulu-Natal, Durban, KwaZulu-Natal, South Africa (Prof K S Naidoo PhD); Azienda Ospedaliera papa Giovanni XXIII, Bergamo, Italy (Prof L Naldi MD); **Suraj Eye Institute, Nagpur, Maharashtra, India** (Prof V Nangia MD); School of Public Health, City University of New York, New York, NY, USA (Prof D Nash PhD); **Faculty of Medicine, Fez, Morocco** (Prof C Nejjari PhD); National Institute of Diabetes and Digestive and Kidney Diseases, Phoenix, AZ, USA (R G Nelson PhD); Norwegian Center for Addiction Research (SERAF), University of Oslo, Oslo, Norway (S P Neupane MBBS); Kenya Medical Research Institute Wellcome Trust Programme, Kilifi, Kenya (Prof C R Newton MD);

Aga Khan University, Karachi, Pakistan (M I Nisar MSc); **University of Bergen, Bergen, Norway** (Prof O F Norheim PhD, Prof S E Vollset); **Polytechnic of Namibia, Windhoek, Namibia** (V Nowaseb MSc); **Kyung Hee University, Seoul, Korea** (I Oh PhD); Teikyo University School of Medicine, Tokyo, Japan (Prof T Ohkubo MD); Center for Healthy Start Initiative, Ikoyi, Lagos, Nigeria (B O Olusanya PhD); Lira District Local Government, Lira Municipal Council, Northern Uganda, Uganda (J N Opio MPH); Toxicology Unit, Faculty of Pharmacy, University of Port Harcourt, Port Harcourt, Rivers State, Nigeria (Prof O E Orisakwe PhD); Christian Medical College Ludhiana, Ludhiana, India (Prof J D Pandian MD); **University of Calgary, Calgary, AB, Canada** (Prof S B Patten PhD); **AIIMS, New Delhi, India** (Prof V K Paul MD); **Independent, Waigani, NCD, Papua New Guinea** (B I Pavlin MD); 3B's Research Group-Biomaterials, Biodegradables and Biomimetics, University of Minho, Headquarters of the European Institute of Excellence on Tissue Engineering and Regenerative Medicine and ICVS/3B's-PT Government Associate Laboratory, Braga, Portugal (Prof D M Pereira PhD); Postgraduate Medical Institute, Lahore, Punjab, Pakistan (A Pervaiz MHA); **Flinders University, Adelaide, SA, Australia** (Prof K Pesudovs PhD); Centre for Applied Biostatistics, Sahlgrenska Academy, University of Gothenburg, Gothenburg, Sweden (Prof M Petzold PhD); University of British Columbia, Vancouver, BC, Canada (F Pourmalek PhD); College of Pharmacy, University of Illinois, Chicago, IL, USA (Prof D Qato PhD); **Contech Intl., Lahore, Punjab, Pakistan** (A Rafay MS); **Hamad Medical Corporation, Doha, Qatar** (S U Rahman FRCPCH); **University of Missouri, Columbia, MO, USA** (M Raju PhD); Department of Public Health, University of the Punjab, Lahore, Punjab, Pakistan (S M Rana PhD); **Center for Disease Analysis, Louisville, CO, USA** (H Razavi PhD); **Private consultant, Cairns, QLD, Australia** (R Q Reilly MPH); IRCCS Mario Negri Institute for Pharmacological Research, Centro Anna Maria Astori, Bergamo, Italy (Prof G Remuzzi MD); Erasmus MC, University Medical Center Rotterdam, Rotterdam, Netherlands (Prof J H Richardus PhD); **BARC Hospital, Mumbai, Maharashtra, India** (Prof N Roy MD); **Rwanda Bio-Medical Center, Kigali, Rwanda** (N Sabin MD); National HIV/AIDS & STI Surveillance and Strategic Information Unit, National Epidemiology Center, Department of Health, Manila, National Capital Region, Philippines (G M J Samonte MD); **Marshall University, Huntington, WV, USA** (M Sawhney PhD); Federal University of Santa Catarina, Florianópolis, Brazil (I J C Schneider PhD); University of Alabama at Birmingham, Birmingham, AL, USA (Prof D C Schwebel PhD, J A Singh MD); Stellenbosch University, Cape Town, Western Cape, South Africa (Prof S Seedat PhD); **Health Canada, Ottawa, ON, Canada** (H H Shin PhD, S Weichenthal PhD); **Heriot-Watt University, Edinburgh, UK** (I Shiuie PhD); **Center for Clinical Global Health Education** (R Shivakoti PhD), Johns Hopkins Bloomberg School of Public Health, Johns Hopkins University, Baltimore, MD, USA (B X Tran PhD); **Reykjavik University, Reykjavik, Iceland** (Prof I D Sigfusdottir PhD); Instituto Nacional de Epidemiología Dr Juan H Jara, Mar del Plata, Buenos Aires, Argentina (A P Silva MgSc); Surveillance and Health Services Research Program American Cancer Society, Atlanta, GA, USA (E P Simard PhD); **Dartmouth College, Lebanon, NH, USA** (S Soneji PhD); Federal Research Institute for Health Organization and

Informatics of Ministry of Health of the Russian Federation, Moscow, Russia (S S Soshnikov PhD); Faculty of Medicine and Health Sciences, University Tunku Abdul Rahman, Kajang, Selangor, Malaysia (C T Sreeramareddy MD); Centre Hospitalier Nord Deux-Sevres, Bressuire, France (V K Stathopoulou MD); KEELPNO (Centre for Disease Control, Greece, dispatched to “Alexandra” General Hospital of Athens), Athens, Greece (K Stroumpoulis PhD); National Institute for Research in Tuberculosis, Chennai, Tamil Nadu, India (S Swaminathan MD); Department of Criminology, Law and Society (and Sociology), University of California-Irvine, Chicago, IL, USA (B L Sykes PhD); **University of Illinois, Champaign, IL, USA** (K M Tabb PhD); Ministry of Health-MINSANTE, Yaounde, Centre, Cameroon (R T Talongwa MD); **Memorial University, St John’s, NL, Canada** (E Y Tenkorang PhD); Department of Anesthesiology, University of Virginia, Charlottesville, VA, USA, and Department of Anesthesiology, King Fahad Medical City, Riyadh, Saudi Arabia (A S Terkawi MD); Adaptive Knowledge Management, Victoria, BC, Canada (A J Thomson PhD); The Earth Institute, Columbia University, New York, NY, USA (A L Thorne-Lyman ScD); Cincinnati Children’s Hospital Medical Center, Cincinnati, OH, USA (Prof J A Towbin MD); University of Southern Santa Catarina, Palhoça, Santa Catarina, Brazil (Prof J Traebert PhD); Department of Population Sciences and Development, Faculty of Economics and Management, University of Kinshasa, Kinshasa, Democratic Republic of the Congo (Z Tsala Dimbuene PhD); Department of Medicine, University of Crete, Heraklion, Greece (Prof M Tsilimbaris PhD); Department of Veterans Affairs, Washington, DC, USA (U S Uchendu MD); Department of Internal Medicine, Federal Teaching Hospital Abakaliki, Abakaliki, Ebonyi State, Nigeria (K N Ukwaja MD); UKK Institute for Health Promotion Research, Tampere, Finland (Prof T J Vasankari PhD); Neuroscience Centre, Raffles Hospital, Singapore, Singapore (N Venketasubramanian MD); **University of Bologna, Bologna, Italy** (Prof F S Violante MD); **Higher School of Economics, Moscow, Russia** (Prof V V Vlassov MD); Uniformed Services University of Health Sciences, Bethesda, MD, USA (S Waller MD); VA Medical Center and Georgetown University Neurology Department, Washington, DC, USA (M T Wallin MD); Shandong University Affiliated Jinan Central Hospital, Jinan, China (X R Wang PhD); National Office for Maternal and Child Health Surveillance, Chengdu, China (Prof Y Wang BS, Prof J Zhu MD); **University of Marburg, Marburg, Germany** (R Westerman PhD); **University of Miami, Miami, FL, USA** (J D Wilkinson MD); Institute of Public Health, University of Gondar, Gondar, Ethiopia (S M Woldeyohannes MPH); Ateneo School of Medicine and Public Health, Pasig City, Metro Manila, Philippines (J Q Wong MD); Nanjing University School of Medicine, Jinling Hospital, Nanjing, China (Prof G Xu PhD); University of North Carolina at Chapel Hill, Chapel Hill, NC, USA (Y C Yang PhD); Division of Cardiovascular Medicine, Jichi Medical University School of Medicine, Shimotsuke, Tochigi, Japan (Y Yano MD); The University of Hong Kong, Hong Kong, Hong Kong (Prof P Yip PhD); National Center of Neurology and Psychiatry, Kodira, Tokyo, Japan (N Yonemoto MPH); **Jackson State University, Jackson, MS, USA** (Prof M Younis PhD); Department of Epidemiology and Biostatistics, School of Public Health and Global Health Institute, Wuhan University, Wuhan, China (Prof C Yu PhD); TCM

MEDICAL TK SDN BHD, Nusajaya, Johor Bahru, Malaysia (K Yun Jin PhD);
Mansoura Faculty of Medicine, Mansoura, Egypt (Prof M E S Zaki MD);
Chongqing Medical University, Chongqing, China (Prof Y Zhao MD); Zhongshan
 Ophthalmic Center, Sun Yat-sen University, Guangzhou, China (Y Zheng PhD);
 Cancer Institute/Hospital, Chinese Academy of Medical Sciences, Beijing, China
 (Prof X N Zou MD)

Acknowledgments

We thank the countless individuals who have contributed to the Global Burden of Disease Study 2013 in various capacities. We would like to acknowledge the extensive support from all staff members at the Institute for Health Metrics and Evaluation and specifically thank: Michael F MacIntyre, Peter Speyer, and Summer Lockett Ohno for their management of the Global Burden of Disease Study 2013; Kelsey Pierce for her valuable assistance; Peter Speyer, James Bullard, Serkan Yalcin, Edgar Sioson, Evan Laurie, Charles Atkinson, and Andrew Ernst for their tireless support of the computational infrastructure necessary to produce the results; Linda A Ettinger for her expert administrative support; Peter Speyer, Abigail McLain, James Hancock, Marissa Iannarone, and Eden Stork for their persistent and invaluable work to gain access to and catalogue as much data as possible to inform the estimates; Stan Biryukov for his assistance with the tuberculosis database; Henry Apfel and Madeline Moyer for data extraction and processing; Christopher Margono, Michelle Subart, Lavanya Singh and Margaret Lind for assistance with galleys; Matthew M Coates, Carly E Levitz, Chelsea A Lidell, Meghan D Mooney, and Austin E Schumaker for production of all-cause mortality estimates; Amelia Bertozzi-Villa for review of Python coding of the Spectrum model. We would also like to acknowledge Mary Mahy, Keith Sabin and John Stover for sharing the UNAIDS EPP files with us and especially John Stover for responding to multiple queries regarding Spectrum. Additionally, Ibrahim Abubakar would like to acknowledge the UK National Institute for Health Research and MRC for funding. Laith J Abu-Raddad would like to acknowledge the support of Qatar National Research Fund (NPRP 04-924-3-251) who provided the main funding for generating the data provided to the GBD-IHME effort. Gabriel Alcalá-Cerra would like to acknowledge institutional support from Health Sciences and Neurosciences (CISNEURO) Research Group. Louisa Degenhardt is supported by an Australian National Health and Medical Research Council Principal Research Fellowship (#1041742). Dr. Des Jarlais would like to acknowledge funding from NIH Grant DA R01 003574. KD is supported by a Wellcome Trust Fellowship in Public Health and Tropical Medicine [grant number 099876]. Prof. Giuseppe Remuzzi would like to acknowledge the International Society of Nephrology (ISN) for their support of his involvement in the GBD 2013. JAS is supported by grants from the Agency for Health Quality and Research Center for Education and Research on Therapeutics (AHRQ CERTs) U19 HS021110, National Institute of Arthritis, Musculoskeletal and Skin Diseases (NIAMS) P50 AR060772 and U34 AR062891, National Institute of Aging (NIA) U01 AG018947, National Cancer Institute (NCI) U10 CA149950, and research contract CE-1304-6631 from the Patient Centered Outcomes Research Institute (PCORI). JAS is also supported by the resources and the use of facilities at the VA Medical Center at Birmingham, Alabama, USA. Dr. Soneji was supported by the National Center for Advancing Translational Sciences grant number KL2TR001088. Karen M Tabb would like to acknowledge her current support: Lemann Institute Faculty Research Grant, University of Illinois. Andrew J Vallely is supported by a Training Fellowship from the National Health and Medical Research Council (NHMRC), Australia. Gelin Xu is currently funded by the Nature Science Foundation of China (NSFC, 81070922). No individuals acknowledged received additional compensation for their efforts.

References

1. Institute for Health Metrics and Evaluation. Financing Global Health 2013: Transition in an Age of Austerity. IHME; Seattle, WA: 2013.
2. Floyd K, Fitzpatrick C, Pantoja A, Raviglione M. Domestic and donor financing for tuberculosis care and control in low-income and middle-income countries: an analysis of trends, 2002-11, and requirements to meet 2015 targets. *Lancet Glob Health*. 2013; 1:e105-15. [PubMed: 25104145]
3. Creese A, Floyd K, Alban A, Guinness L. Cost-effectiveness of HIV/AIDS interventions in Africa: a systematic review of the evidence. *Lancet*. 2002; 359:1635-43. [PubMed: 12020523]
4. Vassall A, Remme M. Financing tuberculosis control: promising trends and remaining challenges. *Lancet Glob Health*. 2013; 1:e62-63. [PubMed: 25104150]
5. Hecht R, Stover J, Bollinger L, Muhib F, Case K, de Ferranti D. Financing of HIV/AIDS programme scale-up in low-income and middle-income countries, 2009-31. *Lancet*. 2010; 376:1254-60. [PubMed: 20934597]

6. Snow RW, Guerra CA, Mutheu JJ, Hay SI. International funding for malaria control in relation to populations at risk of stable *Plasmodium falciparum* transmission. *PLoS Med.* 2008; 5:e142. [PubMed: 18651785]
7. Snow RW, Okiro EA, Gething PW, Atun R, Hay SI. Equity and adequacy of international donor assistance for global malaria control: an analysis of populations at risk and external funding commitments. *Lancet.* 2010; 376:1409–16. [PubMed: 20889199]
8. Korenromp EL, Hosseini M, Newman RD, Cibulskis RE. Progress towards malaria control targets in relation to national malaria programme funding. *Malar J.* 2013; 12:18. [PubMed: 23317000]
9. Waddington, C.; Martin, J.; Walford, V. Trends in International Funding for Malaria Control. HLSP Institute; London, UK: 2005. http://rbm.who.int/docs/hlsp_report.pdf [accessed February 26, 2014]
10. Waage J, Banerji R, Campbell O, et al. The Millennium Development Goals: a cross-sectoral analysis and principles for goal setting after 2015 Lancet and London International Development Centre Commission. *Lancet.* 2010; 376:991–1023. [PubMed: 20833426]
11. Dye C, Glaziou P, Floyd K, Raviglione M. Prospects for tuberculosis elimination. *Annu Rev Public Health.* 2013; 34:271–86. [PubMed: 23244049]
12. United Nations. The Millennium Development Goals Report 2013. United Nations; New York, NY: 2013. <http://www.un.org/millenniumgoals/pdf/report-2013/mdg-report-2013-english.pdf> [accessed February 26, 2014]
13. Clemens MA, Kenny CJ, Moss TJ. The Trouble with the MDGs: Confronting Expectations of Aid and Development Success. *World Dev.* 2007; 35:735–51.
14. Atun R, Raviglione M, Marais B, Zumla A. Tuberculosis control is crucial to achieve the MDGs. *Lancet.* 2010; 376:940–41. [PubMed: 20851247]
15. Lomazzi M, Borisch B, Laaser U. The Millennium Development Goals: experiences, achievements and what's next. *Glob Health Action.* 2014; 7:23695. [PubMed: 24560268]
16. Fehling M, Nelson BD, Venkatapuram S. Limitations of the Millennium Development Goals: a literature review. *Glob Public Health.* 2013; 8:1109–22. [PubMed: 24266508]
17. Stuckler D, Basu S, McKee M. Drivers of inequality in Millennium Development Goal progress: a statistical analysis. *PLoS Med.* 2010; 7:e1000241. [PubMed: 20209000]
18. Vitoria M, Granich R, Gilks CF, et al. The global fight against HIV/AIDS, tuberculosis, and malaria: current status and future perspectives. *Am J Clin Pathol.* 2009; 131:844–48. [PubMed: 19461091]
19. Alleyne G, Binagwaho A, Haines A, et al. Lancet NCD Action Group. Embedding non-communicable diseases in the post-2015 development agenda. *Lancet.* 2013; 381:566–74. [PubMed: 23410606]
20. MEDICC. NCDs: can healthy synergies replace fatal interactions? *MEDICC Rev.* 2013; 15:3.
21. WHO. WEF. From Burden to 'Best Buys': Reducing the Economic Impact of Non-Communicable Diseases in Low- and Middle-Income Countries. World Economic Forum; 2011. http://www3.weforum.org/docs/WEF_WHO_HE_ReducingNonCommunicableDiseases_2011.pdf [accessed February 26, 2014]
22. WEF. Harvard School of Public Health. Glob. Econ. Burd. Non-Commun. Dis. World Econ. Forum; The Global Economic Burden of Non-communicable Diseases. <http://www.weforum.org/reports/global-economic-burden-non-communicable-diseases> [accessed February 27, 2014]
23. [accessed February 27, 2014] 2011 High Level Meeting on the Prevention and Control of Non-communicable Diseases. <https://www.un.org/en/ga/ncdmeeting2011/>
24. Alliance NCD. Tackling Non-communicable Diseases to Enhance Sustainable Development. NCD Alliance; 2014. http://ncdalliance.org/sites/default/files/NCD%20Alliance%20-%20NCDs%20and%20Sustainable%20Development%20Brief_0.pdf [accessed February 26, 2014]
25. Beaglehole R, Bonita R, Horton R, et al. Lancet NCD Action Group; NCD Alliance. Priority actions for the non-communicable disease crisis. *Lancet.* 2011; 377:1438–47. [PubMed: 21474174]
26. Abegunde DO, Mathers CD, Adam T, Ortegón M, Strong K. The burden and costs of chronic diseases in low-income and middle-income countries. *Lancet.* 2007; 370:1929–38. [PubMed: 18063029]

27. Shiffman J. Has donor prioritization of HIV/AIDS displaced aid for other health issues? *Health Policy Plan.* 2008; 23:95–100. [PubMed: 18156161]
28. Vandemoortele J, Delamonica E. Taking the MDGs Beyond 2015: Hasten Slowly. *IDS Bull.* 2010; 41:60–69.
29. UNAIDS. 2011-2015 Strategy: Getting to Zero. Joint United Nations Programme on HIV/AIDS; 2010. http://www.unaids.org/en/media/unaids/contentassets/documents/unaidspublication/2010/JC2034_UNAIDS_Strategy_en.pdf
30. Treatment Action Group. [accessed March 5, 2014] The Zero Declaration. 2012. <http://www.treatmentactiongroup.org/tb/advocacy/zero-declaration>
31. Department for International Development. UKAID. Towards zero infections: The UK's position paper on HIV in the developing world. 2011. https://www.gov.uk/government/uploads/system/uploads/attachment_data/file/67523/twds-zero-infs-pos-paper-hiv-dev-wrld.pdf
32. South Africa Info Reporter. South Africa's HIV/Aids battle plan. 2012. [SouthAfrica.infohttp://www.southafrica.info/about/health/aids-prevention.htm#.UxZ1nfdXg9](http://www.southafrica.info/about/health/aids-prevention.htm#.UxZ1nfdXg9)
33. WHO. Roadmap for Childhood Tuberculosis. 2013. http://apps.who.int/iris/bitstream/10665/89506/1/9789241506137_eng.pdf
34. Stop, TB. Towards Zero TB Deaths In Children. WHO; 2012. Partnership. No More Crying, No More Dying. http://www.stoptb.org/assets/documents/news/ChildhoodTB_report_singles.pdf
35. Ki-moon, B. [accessed March 5, 2014] Secretary-General's message on World Malaria Day. 2011. [un.orghttp://www.un.org/sg/statements/?nid=5219](http://www.un.org/sg/statements/?nid=5219)
36. Wagstaff, A. The Millennium Development Goals for Health: Rising to the Challenges. World Bank Publications; 2004.
37. UNAIDS. AIDSinfo Database. Joint United Nations Programme on HIV/AIDS; 2013. <http://www.aidsinfoonline.org/devinfo/libraries/asp/Home.aspx>
38. Stover J, Brown T, Marston M. Updates to the Spectrum/Estimation and Projection Package (EPP) model to estimate HIV trends for adults and children. *Sex Transm Infect.* 2012; 88(suppl 2):i11–16. [PubMed: 23172341]
39. UNAIDS. Methodology – Understanding the HIV estimates. Geneva, Switzerland: 2013. http://www.unaids.org/en/media/unaids/contentassets/documents/epidemiology/2013/gr2013/20131118_Methodology.pdf
40. Pretorius C, Menzies NA, Chindelevitch L, et al. The potential effects of changing HIV treatment policy on tuberculosis outcomes in South Africa: results from three tuberculosis-HIV transmission models. *AIDS.* 2014; 28(suppl 1):S25–34. [PubMed: 24468944]
41. Murray CJ, Ezzati M, Flaxman AD, et al. GBD 2010: a multi-investigator collaboration for global comparative descriptive epidemiology. *Lancet.* 2012; 380:2055–58. [PubMed: 23245598]
42. Murray CJ, Ezzati M, Flaxman AD, et al. GBD 2010: design, definitions, and metrics. *Lancet.* 2012; 380:2063–66. [PubMed: 23245602]
43. Wang H, Dwyer-Lindgren L, Lofgren KT, et al. Age-specific and sex-specific mortality in 187 countries, 1970-2010: a systematic analysis for the Global Burden of Disease Study 2010. *Lancet.* 2012; 380:2071–94. [PubMed: 23245603]
44. Salomon JA, Vos T, Hogan DR, et al. Common values in assessing health outcomes from disease and injury: disability weights measurement study for the Global Burden of Disease Study 2010. *Lancet.* 2012; 380:2129–43. [PubMed: 23245605]
45. Salomon JA, Wang H, Freeman MK, et al. Healthy life expectancy for 187 countries, 1990-2010: a systematic analysis for the Global Burden Disease Study 2010. *Lancet.* 2012; 380:2144–62. [PubMed: 23245606]
46. Vos T, Flaxman AD, Naghavi M, et al. Years lived with disability (YLDs) for 1160 sequelae of 289 diseases and injuries 1990-2010: a systematic analysis for the Global Burden of Disease Study 2010. *Lancet.* 2012; 380:2163–96. [PubMed: 23245607]
47. Murray CJL, Vos T, Lozano R, et al. Disability-adjusted life years (DALYs) for 291 diseases and injuries in 21 regions, 1990-2010: a systematic analysis for the Global Burden of Disease Study 2010. *Lancet.* 2012; 380:2197–223. [PubMed: 23245608]
48. Lim SS, Vos T, Flaxman AD, et al. A comparative risk assessment of burden of disease and injury attributable to 67 risk factors and risk factor clusters in 21 regions, 1990-2010: a systematic

- analysis for the Global Burden of Disease Study 2010. *Lancet*. 2012; 380:2224–60. [PubMed: 23245609]
49. The GBD 2013 Collaboration. Global, Regional, and National Burden of Disease for 322 Disease and Injuries and 68 Risk Factors, 1990-2013: A Systematic Analysis. In preparation.
 50. The GBD 2013 Collaboration. Global, Regional, and National Levels of Age-Specific Mortality and 266 Causes of Death, 1990-2013: A Systematic Analysis. In preparation.
 51. The GBD 2013 Collaboration. Global, Regional, and National Prevalence and Disability for 318 Disease and Injuries and Their 2,435 Sequelae, 1990-2013: A Systematic Analysis. In preparation.
 52. Ghys PD, Brown T, Grassly NC, et al. The UNAIDS Estimation and Projection Package: a software package to estimate and project national HIV epidemics. *Sex Transm Infect*. 2004; 80(suppl 1):i5–9. [PubMed: 15249692]
 53. Brown T, Grassly NC, Garnett G, Stanecki K. Improving projections at the country level: the UNAIDS Estimation and Projection Package 2005. *Sex Transm Infect*. 2006; 82(suppl 3):iii34–40. [PubMed: 16735291]
 54. Todd J, Glynn JR, Marston M, et al. Time from HIV seroconversion to death: a collaborative analysis of eight studies in six low and middle-income countries before highly active antiretroviral therapy. *AIDS*. 2007; 21(suppl 6):S55–63. [PubMed: 18032940]
 55. Ghys PD, Zaba B, Prins M. Survival and mortality of people infected with HIV in low and middle income countries: results from the extended ALPHA network. *AIDS*. 2007; 21(suppl 6):S1–4. [PubMed: 18032932]
 56. Hallett TB, Zaba B, Todd J, et al. ALPHA Network. Estimating incidence from prevalence in generalised HIV epidemics: methods and validation. *PLoS Med*. 2008; 5:e80. [PubMed: 18590346]
 57. McGowan CC, Cahn P, Gotuzzo E, et al. Cohort Profile: Caribbean, Central and South America Network for HIV research (CCASAnet) collaboration within the International Epidemiologic Databases to Evaluate AIDS (IeDEA) programme. *Int J Epidemiol*. 2007; 36:969–76. [PubMed: 17846055]
 58. Nash D, Katyal M, Brinkhof MWG, et al. ART-LINC Collaboration of IeDEA. Long-term immunologic response to antiretroviral therapy in low-income countries: a collaborative analysis of prospective studies. *AIDS*. 2008; 22:2291–302. [PubMed: 18981768]
 59. Verguet S, Lim SS, Murray CJL, Gakidou E, Salomon JA. Incorporating loss to follow-up in estimates of survival among HIV-infected individuals in sub-Saharan Africa enrolled in antiretroviral therapy programs. *J Infect Dis*. 2013; 207:72–79. [PubMed: 23100567]
 60. UNAIDS. Global Report: UNAIDS report on the global AIDS epidemic 2013. Joint United Nations Programme on HIV/AIDS; 2013. http://www.unaids.org/en/media/unaids/contentassets/documents/epidemiology/2013/gr2013/UNAIDS_Global_Report_2013_en.pdf [accessed 26 Feb 2014]
 61. WHO. Case Study on Estimating HIV Infection in a Concentrated Epidemic: Lessons from Indonesia. WHO; 2004. <http://www.who.int/hiv/pub/epidemiology/indonesia/en/> [accessed February 27, 2014]
 62. Papworth E, Ceesay N, An L, et al. Epidemiology of HIV among female sex workers, their clients, men who have sex with men and people who inject drugs in West and Central Africa. *J Int AIDS Soc*. 2013; 16(suppl 3):18751. [PubMed: 24321113]
 63. Bautista-Arredondo S, Colchero MA, Romero M, Conde-Glez CJ, Sosa-Rubí SG. Is the HIV epidemic stable among MSM in Mexico? HIV prevalence and risk behavior results from a nationally representative survey among men who have sex with men. *PLoS ONE*. 2013; 8:e72616. [PubMed: 24039786]
 64. Ruan Y, Liang S, Zhu J, et al. Gender and ethnic disparities of HIV and syphilis seroconversions in a 4-year cohort of injection drug users. *Southeast Asian J Trop Med Public Health*. 2013; 44:842–53. [PubMed: 24437319]
 65. Decker MR, Wirtz AL, Moguilnyi V, et al. Female Sex Workers in Three Cities in Russia: HIV Prevalence, Risk Factors and Experience with Targeted HIV Prevention. *AIDS Behav*. 2014; 18:562–72. [PubMed: 23929034]

66. Miller WM, Buckingham L, Sánchez-Domínguez MS, Morales-Miranda S, Paz-Bailey G. Systematic review of HIV prevalence studies among key populations in Latin America and the Caribbean. *Salud Publica Mex.* 2013; 55(suppl 1):S65–78. [PubMed: 23918059]
67. Mason K, Ketende S, Peitzmeier S, et al. A cross-sectional analysis of population demographics, HIV knowledge and risk behaviors, and prevalence and associations of HIV among men who have sex with men in the Gambia. *AIDS Res Hum Retroviruses.* 2013; 29:1547–52. [PubMed: 23875674]
68. Li D, Wang L, Lin W, et al. HIV and syphilis infections among street-based female sex workers in China, 2010–2012. *Chin Med J (Engl).* 2014; 127:707–11. [PubMed: 24534227]
69. Sajadi L, Mirzazadeh A, Navadeh S, et al. HIV prevalence and related risk behaviours among female sex workers in Iran: results of the national biobehavioural survey, 2010. *Sex Transm Infect.* 2013; 89(suppl 3):iii37–40. [PubMed: 24191292]
70. Mathers BM, Degenhardt L, Ali H, et al. 2009 Reference Group to the UN on HIV and Injecting Drug Use. HIV prevention, treatment, and care services for people who inject drugs: a systematic review of global, regional, and national coverage. *Lancet.* 2010; 375:1014–28. [PubMed: 20189638]
71. Mathers BM, Degenhardt L, Phillips B, et al. 2007 Reference Group to the UN on HIV and Injecting Drug Use. Global epidemiology of injecting drug use and HIV among people who inject drugs: a systematic review. *Lancet.* 2008; 372:1733–45. [PubMed: 18817968]
72. Prüss-Ustün A, Wolf J, Driscoll T, Degenhardt L, Neira M, Calleja JMG. HIV due to female sex work: regional and global estimates. *PLoS ONE.* 2013; 8:e63476. [PubMed: 23717432]
73. UNAIDS. WHO. Guidelines for measuring national HIV prevalence in population-based surveys. Joint United Nations Programme on HIV/AIDS; Geneva: 2005. http://data.unaids.org/pub/manual/2005/20050101_gs_guidemeasuringpopulation_en.pdf
74. Lozano R, Naghavi M, Foreman K, et al. Global and regional mortality from 235 causes of death for 20 age groups in 1990 and 2010: a systematic analysis for the Global Burden of Disease Study 2010. *Lancet.* 2012; 380:2095–128. [PubMed: 23245604]
75. Birnbaum JK, Murray CJ, Lozano R. Exposing misclassified HIV/AIDS deaths in South Africa. *Bull World Health Organ.* 2011; 89:278–85. [PubMed: 21479092]
76. Foreman KJ, Lozano R, Lopez AD, Murray CJ. Modeling causes of death: an integrated approach using CODEm. *Popul Health Metr.* 2012; 10:1. [PubMed: 22226226]
77. Ng M, Freeman MK, Fleming TD, et al. Smoking prevalence and cigarette consumption in 187 countries, 1980–2012. *JAMA.* 2014; 311:183–92. [PubMed: 24399557]
78. USAID. Demographic Health Surveys Program. <http://www.dhsprogram.com/>
79. International Institute for Population Sciences. National Family Health Survey, India. Mumbai, India: <http://www.rchiips.org/nfhs/>
80. Simbayi, L.; Shisana, O.; Rehle, T.; et al. Human Sciences Resource Council. South African National HIV Prevalence, Incidence and Behaviour Survey, 2012. 2014. <http://www.hsrb.ac.za/en/research-outputs/view/6871>
81. Dye C, Lönnroth K, Jaramillo E, Williams BG, Raviglione M. Trends in tuberculosis incidence and their determinants in 134 countries. *Bull World Health Organ.* 2009; 87:683–91. [PubMed: 19784448]
82. WHO. Global tuberculosis report 2013. 2013. http://apps.who.int/iris/bitstream/10665/91355/1/9789241564656_eng.pdf
83. WHO. Tuberculosis prevalence surveys: a handbook. WHO; 2011. http://www.who.int/tb/advisory_bodies/impact_measurement_taskforce/resources_documents/thelimebook/en/ [accessed February 26, 2014]
84. WHO. Global Task Force on TB Impact Measurement. National TB prevalence surveys; 2014.
85. Naghavi M, Makela S, Foreman K, O'Brien J, Pourmalek F, Lozano R. Algorithms for enhancing public health utility of national causes-of-death data. *Popul Health Metr.* 2010; 8:9. [PubMed: 20459720]
86. Sonnenberg P, Glynn JR, Fielding K, Murray J, Godfrey-Faussett P, Shearer S. How soon after infection with HIV does the risk of tuberculosis start to increase? A retrospective cohort study in South African gold miners. *J Infect Dis.* 2005; 191:150–58. [PubMed: 15609223]

87. Allen S, Batungwanayo J, Kerlikowske K, et al. Two-year incidence of tuberculosis in cohorts of HIV-infected and uninfected urban Rwandan women. *Am Rev Respir Dis.* 1992; 146:1439–44. [PubMed: 1456559]
88. Braun MM, Badi N, Ryder RW, et al. A retrospective cohort study of the risk of tuberculosis among women of childbearing age with HIV infection in Zaire. *Am Rev Respir Dis.* 1991; 143:501–04. [PubMed: 2001057]
89. Keizer ST, Langendam MM, van Deutekom H, Coutinho RA, van Ameijden EJC. How does tuberculosis relate to HIV positive and HIV negative drug users? *J Epidemiol Community Health.* 2000; 54:64–68. [PubMed: 10692965]
90. Leroy V, Msellati P, Lepage P, et al. Four years of natural history of HIV-1 infection in african women: a prospective cohort study in Kigali (Rwanda), 1988-1993. *J Acquir Immune Defic Syndr Hum Retrovirol.* 1995; 9:415–21. [PubMed: 7600110]
91. Houben RMGJ, Glynn JR, Mboma S, et al. The impact of HIV and ART on recurrent tuberculosis in a sub-Saharan setting. *AIDS.* 2012; 26:2233–39. [PubMed: 22951633]
92. Ferreira MM, Ferrazoli L, Palaci M, et al. Tuberculosis and HIV infection among female inmates in São Paulo, Brazil: a prospective cohort study. *J Acquir Immune Defic Syndr Hum Retrovirol.* 1996; 13:177–83. [PubMed: 8862283]
93. Badri M, Wilson D, Wood R. Effect of highly active antiretroviral therapy on incidence of tuberculosis in South Africa: a cohort study. *Lancet.* 2002; 359:2059–64. [PubMed: 12086758]
94. Murray CJL, Rosenfeld LC, Lim SS, et al. Global malaria mortality between 1980 and 2010: a systematic analysis. *Lancet.* 2012; 379:413–31. [PubMed: 22305225]
95. Byass P, de Courten M, Graham WJ, et al. Reflections on the global burden of disease 2010 estimates. *PLoS Med.* 2013; 10:e1001477. [PubMed: 23843748]
96. Lynch M, Korenromp E, Eisele T, et al. New global estimates of malaria deaths. *Lancet.* 2012; 380:559. [PubMed: 22883496]
97. Bates M, O’Grady J, Mudenda V, Shibemba A, Zumla A. New global estimates of malaria deaths. *Lancet.* 2012; 380:560–61. [PubMed: 22883498]
98. Chambers RG. UN Envoy’s response to estimates of global malaria mortality. *Lancet.* 2012; 379:707–08. [PubMed: 22357104]
99. Shah NK, Kumar A, Valecha N. New global estimates of malaria deaths. *Lancet.* 2012; 380:560. [PubMed: 22883499]
100. White NJ, Dondorp AM, Faiz A, Mishra S, Hien TT. New global estimates of malaria deaths. *Lancet.* 2012; 380:559–60. [PubMed: 22883497]
101. Snow RW, Armstrong JR, Forster D, et al. Childhood deaths in Africa: uses and limitations of verbal autopsies. *Lancet.* 1992; 340:351–55. [PubMed: 1353814]
102. Mpimbaza A, Filler S, Katureebe A, et al. Validity of verbal autopsy procedures for determining malaria deaths in different epidemiological settings in Uganda. *PLoS ONE.* 2011; 6:e26892. [PubMed: 22046397]
103. Nykanen M, Tamaona W, Cullinan T, Van Oosterzee V, Ashorn P. Verbal autopsy as a technique to establish causes of infant and child mortality. *East Afr Med J.* 1995; 72:731–34. [PubMed: 8904066]
104. Todd JE, De Francisco A, O’Dempsey TJ, Greenwood BM. The limitations of verbal autopsy in a malaria-endemic region. *Ann Trop Paediatr.* 1994; 14:31–36. [PubMed: 7516132]
105. Setel PW, Whiting DR, Hemed Y, et al. Validity of verbal autopsy procedures for determining cause of death in Tanzania. *Trop Med Int Health.* 2006; 11:681–96. [PubMed: 16640621]
106. Chandramohan D, Maude GH, Rodrigues LC, Hayes RJ. Verbal autopsies for adult deaths: their development and validation in a multicentre study. *Trop Med Int Health.* 1998; 3:436–46. [PubMed: 9657505]
107. Murray CJL, Lozano R, Flaxman AD, et al. Using verbal autopsy to measure causes of death: the comparative performance of existing methods. *BMC Med.* 2014; 12:5. [PubMed: 24405531]
108. Gething PW, Patil AP, Smith DL, et al. A new world malaria map: *Plasmodium falciparum* endemicity in 2010. *Malar J.* 2011; 10:378. [PubMed: 22185615]

109. Dieleman JL, Graves CM, Templin T, et al. Global health development assistance remained steady in 2013 but did not align with recipients' disease burden. *Health Aff (Millwood)*. 2014; 33:878–86. [PubMed: 24714869]
110. WHO. [accessed 10 Mar 2014] World Malaria Report. 2013. 2013. http://www.who.int/malaria/publications/world_malaria_report_2013/report/en/
111. Yang X, Jiao YM, Wang R, et al. High CCR5 density on central memory CD4+ T cells in acute HIV-1 infection is mostly associated with rapid disease progression. *PLoS ONE*. 2012; 7:e49526. [PubMed: 23185351]
112. International HIV Controllers Study. Pereyra F, Jia X, et al. The major genetic determinants of HIV-1 control affect HLA class I peptide presentation. *Science*. 2010; 330:1551–57. [PubMed: 21051598]
113. Herbeck JT, Gottlieb GS, Winkler CA, et al. Multistage genomewide association study identifies a locus at 1q41 associated with rate of HIV-1 disease progression to clinical AIDS. *J Infect Dis*. 2010; 201:618–26. [PubMed: 20064070]
114. Freguja R, Gianesin K, Del Bianco P, et al. Polymorphisms of innate immunity genes influence disease progression in HIV-1-infected children. *AIDS*. 2012; 26:765–68. [PubMed: 22269973]
115. Freguja R, Gianesin K, Zanchetta M, De Rossi A. Cross-talk between virus and host innate immunity in pediatric HIV-1 infection and disease progression. *New Microbiol*. 2012; 35:249–57. [PubMed: 22842595]
116. Hewitt K, Steketee R, Mwapasa V, Whitworth J, French N. Interactions between HIV and malaria in non-pregnant adults: evidence and implications. *AIDS*. 2006; 20:1993–2004. [PubMed: 17053345]
117. Flateau C, Le Loup G, Pialoux G. Consequences of HIV infection on malaria and therapeutic implications: a systematic review. *Lancet Infect Dis*. 2011; 11:541–56. [PubMed: 21700241]
118. Umunyana, J. [accessed 11 Apr 2014] Incidence of Malaria in HIV-infected and uninfected and Rwandan women from 2005 to 2011. 2014. <http://wiredspace.wits.ac.za/handle/10539/14502>
119. UNAIDS. 2007 AIDS Epidemic Update. 2007. http://data.unaids.org/pub/epislides/2007/2007_epiupdate_en.pdf
120. Donnell D, Baeten JM, Kiarie J, et al. Partners in Prevention HSV/HIV Transmission Study Team. Heterosexual HIV-1 transmission after initiation of antiretroviral therapy: a prospective cohort analysis. *Lancet*. 2010; 375:2092–98. [PubMed: 20537376]
121. Attia S, Egger M, Müller M, Zwahlen M, Low N. Sexual transmission of HIV according to viral load and antiretroviral therapy: systematic review and meta-analysis. *AIDS*. 2009; 23:1397–404. [PubMed: 19381076]
122. Jackson DJ, Chopra M, Doherty TM, et al. Good Start Study Group. Operational effectiveness and 36 week HIV-free survival in the South African programme to prevent mother-to-child transmission of HIV-1. *AIDS*. 2007; 21:509–16. [PubMed: 17301570]
123. Dabis F, Bequet L, Ekouevi DK, et al. ANRS 1201/1202 DITRAME PLUS Study Group. Field efficacy of zidovudine, lamivudine and single-dose nevirapine to prevent peripartum HIV transmission. *AIDS*. 2005; 19:309–18. [PubMed: 15718842]
124. Mermin J, Lule J, Ekwaru JP, et al. Effect of co-trimoxazole prophylaxis on morbidity, mortality, CD4-cell count, and viral load in HIV infection in rural Uganda. *Lancet*. 2004; 364:1428–34. [PubMed: 15488218]
125. Chintu C, Bhat GJ, Walker AS, et al. CHAP trial team. Co-trimoxazole as prophylaxis against opportunistic infections in HIV-infected Zambian children (CHAP): a double-blind randomised placebo-controlled trial. *Lancet*. 2004; 364:1865–71. [PubMed: 15555666]
126. Freedberg KA, Losina E, Weinstein MC, et al. The cost effectiveness of combination antiretroviral therapy for HIV disease. *N Engl J Med*. 2001; 344:824–31. [PubMed: 11248160]
127. Goldie SJ, Yazdanpanah Y, Losina E, et al. Cost-effectiveness of HIV treatment in resource-poor settings—the case of Côte d'Ivoire. *N Engl J Med*. 2006; 355:1141–53. [PubMed: 16971720]
128. Cleary SM, McIntyre D, Boulle AM. The cost-effectiveness of antiretroviral treatment in Khayelitsha, South Africa—a primary data analysis. *Cost Eff Resour Alloc*. 2006; 4:20. [PubMed: 17147833]

129. Degenhardt L, Mathers BM, Wirtz AL, et al. What has been achieved in HIV prevention, treatment and care for people who inject drugs, 2010-2012? A review of the six highest burden countries. *Int J Drug Policy*. 2014; 25:53–60. [PubMed: 24113623]
130. Narasimhan P, Wood J, Macintyre CR, Mathai D. Risk factors for tuberculosis. *Pulm Med*. 2013; 2013:828939. DOI:10.1155/2013/828939. [PubMed: 23476764]
131. Bates MN, Khalakdina A, Pai M, Chang L, Lessa F, Smith KR. Risk of tuberculosis from exposure to tobacco smoke: a systematic review and meta-analysis. *Arch Intern Med*. 2007; 167:335–42. [PubMed: 17325294]
132. Lönnroth K, Jaramillo E, Williams BG, Dye C, Ravignione M. Drivers of tuberculosis epidemics: the role of risk factors and social determinants. *Soc Sci Med*. 2009; 68:2240–46. [PubMed: 19394122]
133. Espinal MA. The global situation of MDR-TB. *Tuberculosis (Edinb)*. 2003; 83:44–51. [PubMed: 12758188]
134. Zignol M, Hosseini MS, Wright A, et al. Global incidence of multidrug-resistant tuberculosis. *J Infect Dis*. 2006; 194:479–85. [PubMed: 16845631]
135. Zhao Y, Xu S, Wang L, et al. National survey of drug-resistant tuberculosis in China. *N Engl J Med*. 2012; 366:2161–70. [PubMed: 22670902]
136. WHO. Global tuberculosis control 2010. http://www.who.int/tb/publications/global_report/2010/en/
137. Mehra M, Cossrow N, Kambili C, Underwood R, Makkar R, Potluri R. Assessment of tuberculosis burden in China using a dynamic disease simulation model. *Int J Tuberc Lung Dis*. 2013; 17:1186–94. [PubMed: 23827732]
138. Malaria Funding & Resource Utilization: The First Decade of Roll Back Malaria. 2010. Roll Back Malaria.
139. Otten M, Aregawi M, Were W, et al. Initial evidence of reduction of malaria cases and deaths in Rwanda and Ethiopia due to rapid scale-up of malaria prevention and treatment. *Malar J*. 2009; 8:14. [PubMed: 19144183]
140. Steketee RW, Campbell CC. Impact of national malaria control scale-up programmes in Africa: magnitude and attribution of effects. *Malar J*. 2010; 9:299. [PubMed: 20979634]
141. O’Meara WP, Mangeni JN, Steketee R, Greenwood B. Changes in the burden of malaria in sub-Saharan Africa. *Lancet Infect Dis*. 2010; 10:545–55. [PubMed: 20637696]
142. Noor AM, Kinyoki DK, Mundia CW, et al. The changing risk of *Plasmodium falciparum* malaria infection in Africa: 2000-10: a spatial and temporal analysis of transmission intensity. *Lancet*. 2014 DOI:10.1016/S0140-6736(13)62566-0.
143. WHO. Q & A on malaria mortality estimates. 2012. http://www.searo.who.int/entity/malaria/WHOGMP_burden_estimates_qa.pdf
144. Shah NK. Defining & counting malaria deaths. *Indian J Med Res*. 2012; 135:270–72. [PubMed: 22561610]
145. Shah NK, Dhariwal AC, Sonal GS, Gunasekar A, Dye C, Cibulskis R. Malaria-attributed death rates in India. *Lancet*. 2011; 377:991. author reply 994-95. [PubMed: 21420545]
146. Crump JA, Morrissey AB, Nicholson WL, et al. Etiology of severe non-malaria febrile illness in Northern Tanzania: a prospective cohort study. *PLoS Negl Trop Dis*. 2013; 7:e2324. [PubMed: 23875053]
147. Reyburn H, Mbatia R, Drakeley C, et al. Overdiagnosis of malaria in patients with severe febrile illness in Tanzania: a prospective study. *BMJ*. 2004; 329:1212. [PubMed: 15542534]
148. Nadjm B, Mtove G, Amos B, et al. Severe febrile illness in adult hospital admissions in Tanzania: a prospective study in an area of high malaria transmission. *Trans R Soc Trop Med Hyg*. 2012; 106:688–95. [PubMed: 23022040]
149. Makani J, Matuja W, Liyombo E, Snow RW, Marsh K, Warrell DA. Admission diagnosis of cerebral malaria in adults in an endemic area of Tanzania: implications and clinical description. *QJM*. 2003; 96:355–62. [PubMed: 12702784]
150. Snow RW, Korenromp EL, Gouws E. Pediatric mortality in Africa: plasmodium falciparum malaria as a cause or risk? *Am J Trop Med Hyg*. 2004; 71(suppl):16–24. [PubMed: 15331815]

151. Scott JAG, Berkley JA, Mwangi I, et al. Relation between falciparum malaria and bacteraemia in Kenyan children: a population-based, case-control study and a longitudinal study. *Lancet*. 2011; 378:1316–23. [PubMed: 21903251]
152. Shanks GD, Hay SI, Bradley DJ. Malaria's indirect contribution to all-cause mortality in the Andaman Islands during the colonial era. *Lancet Infect Dis*. 2008; 8:564–70. [PubMed: 18599354]
153. Gray RH. The decline of mortality in Ceylon and the demographic effects of malaria control. *Popul Stud (Camb)*. 1974; 28:205–29. [PubMed: 11630544]
154. Giglioli G. Changes in the pattern of mortality following the eradication of hyperendemic malaria from a highly susceptible community. *Bull World Health Organ*. 1972; 46:181–202. [PubMed: 4624339]
155. D'Alessandro U, Olaleye BO, McGuire W, et al. Mortality and morbidity from malaria in Gambian children after introduction of an impregnated bednet programme. *Lancet*. 1995; 345:479–83. [PubMed: 7861874]
156. Alonso PL, Lindsay SW, Armstrong JR, et al. The effect of insecticide-treated bed nets on mortality of Gambian children. *Lancet*. 1991; 337:1499–502. [PubMed: 1675368]
157. Darby SC, Ewart DW, Giangrande PL, Spooner RJ, Rizza CR, UK Haemophilia Centre Directors' Organisation. Importance of age at infection with HIV-1 for survival and development of AIDS in UK haemophilia population. *Lancet*. 1996; 347:1573–79. [PubMed: 8667864]
158. Ceesay SJ, Casals-Pascual C, Erskine J, et al. Changes in malaria indices between 1999 and 2007 in The Gambia: a retrospective analysis. *Lancet*. 2008; 372:1545–54. [PubMed: 18984187]
159. Ceesay SJ, Casals-Pascual C, Nwakanma DC, et al. Continued decline of malaria in The Gambia with implications for elimination. *PLoS ONE*. 2010; 5:e12242. [PubMed: 20805878]
160. Futures Institute. [accessed Feb 26, 2014] AIM: a computer program for making HIV/AIDS projections and examining the demographic and social impacts of AIDS. <https://spectrummodel.zendesk.com/attachments/token/6eixeawlonxjg7/?name=AIM+2014+English.pdf>
161. Liu L, Johnson HL, Cousens S, et al. Global, regional, and national causes of child mortality: an updated systematic analysis for 2010 with time trends since 2000. *Lancet*. 2012; 379:2151–61. [PubMed: 22579125]
162. WHO. [accessed Jun 12, 2014] World Malaria Report 2008. <http://www.who.int/malaria/publications/atoz/9789241563697/en/>
163. Hay SI, Okiro EA, Gething PW, et al. Estimating the Global Clinical Burden of Plasmodium falciparum Malaria in 2007. *PLoS Med*. 2010; 7:e1000290. [PubMed: 20563310]
164. Snow, RW.; Newton, CRJC. The public health burden of *Plasmodium falciparum* malaria in Africa: deriving the numbers. The Disease Control Priorities Project (DCPP); Washington DC: 2003. p. 75 Working Paper Number 11

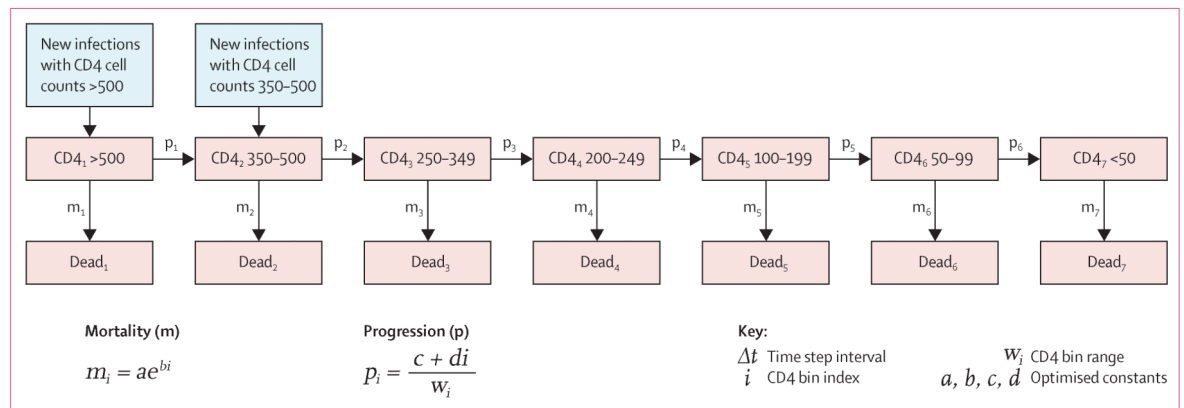

Figure 1. UNAIDS compartmental model for estimating mortality in HIV-positive individuals in the absence of ART
 ART=antiretroviral therapy.

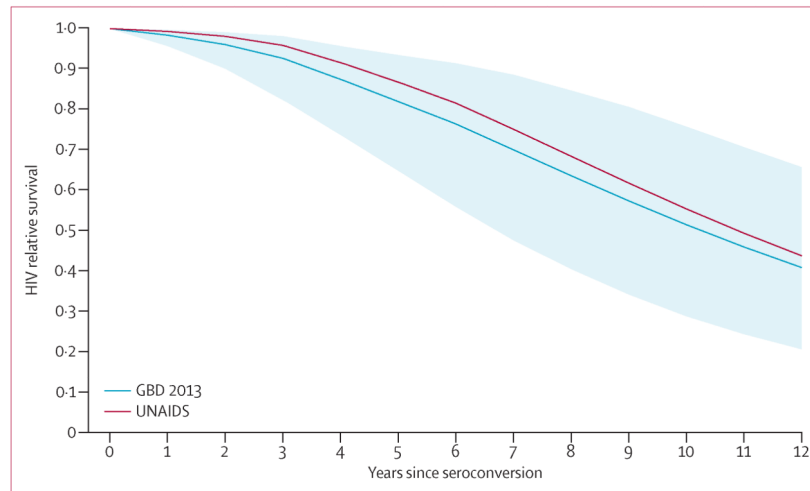

Figure 2. HIV relative survival after seroconversion for male and female individuals aged 25–34 years based on the analysis of 13 ART-naive cohort studies

Solid lines show means; shaded area shows 95% uncertainty intervals (uncertainty intervals not available for UNAIDS data). ART=antiretroviral therapy.

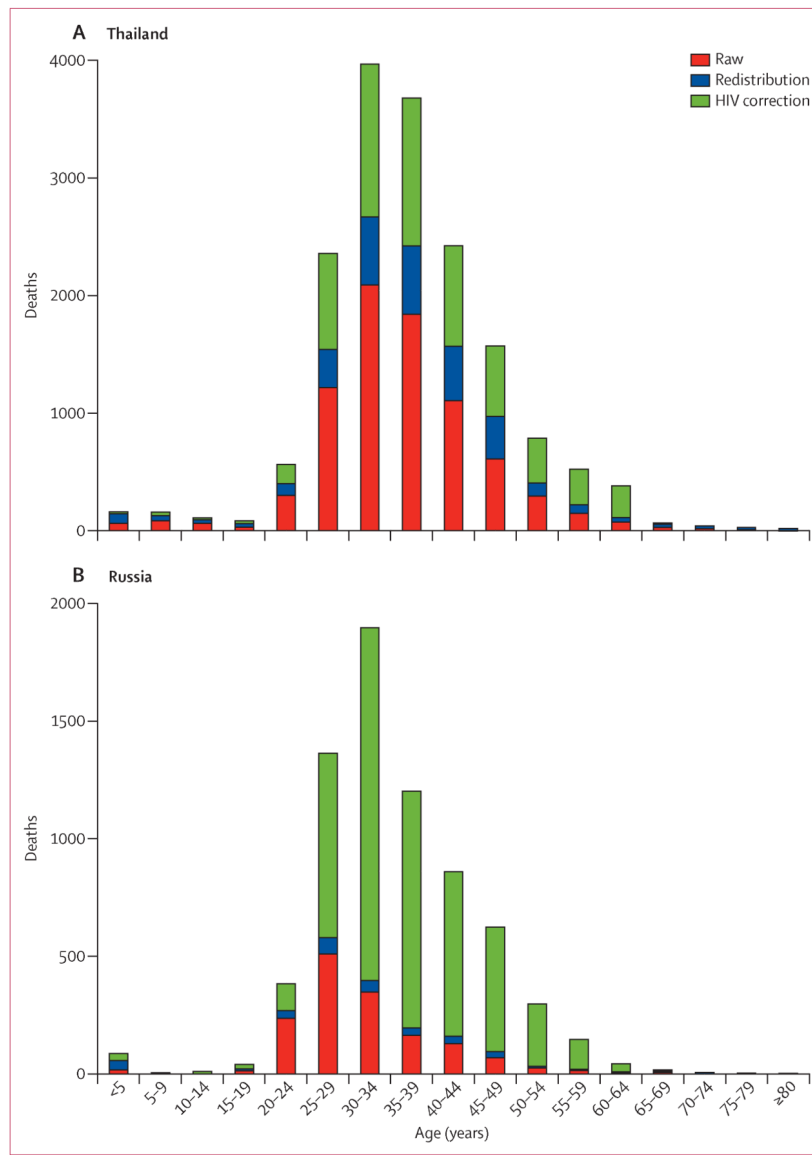

Figure 3. HIV deaths in Thailand (A) and Russia (B) by age in 2005 for both sexes combined
 Data are for vital registration deaths assigned to HIV (red), deaths coded to garbage codes redistributed to HIV (blue), and misclassified deaths reassigned to HIV (green). The height of the bar is the final number of deaths in each age group.

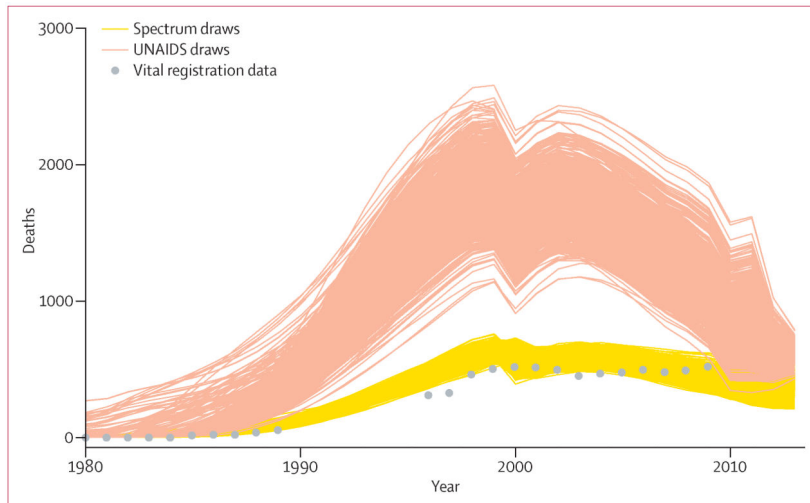

Figure 4. Vital registration inputs, and Spectrum and UNAIDS HIV mortality draws for Panama

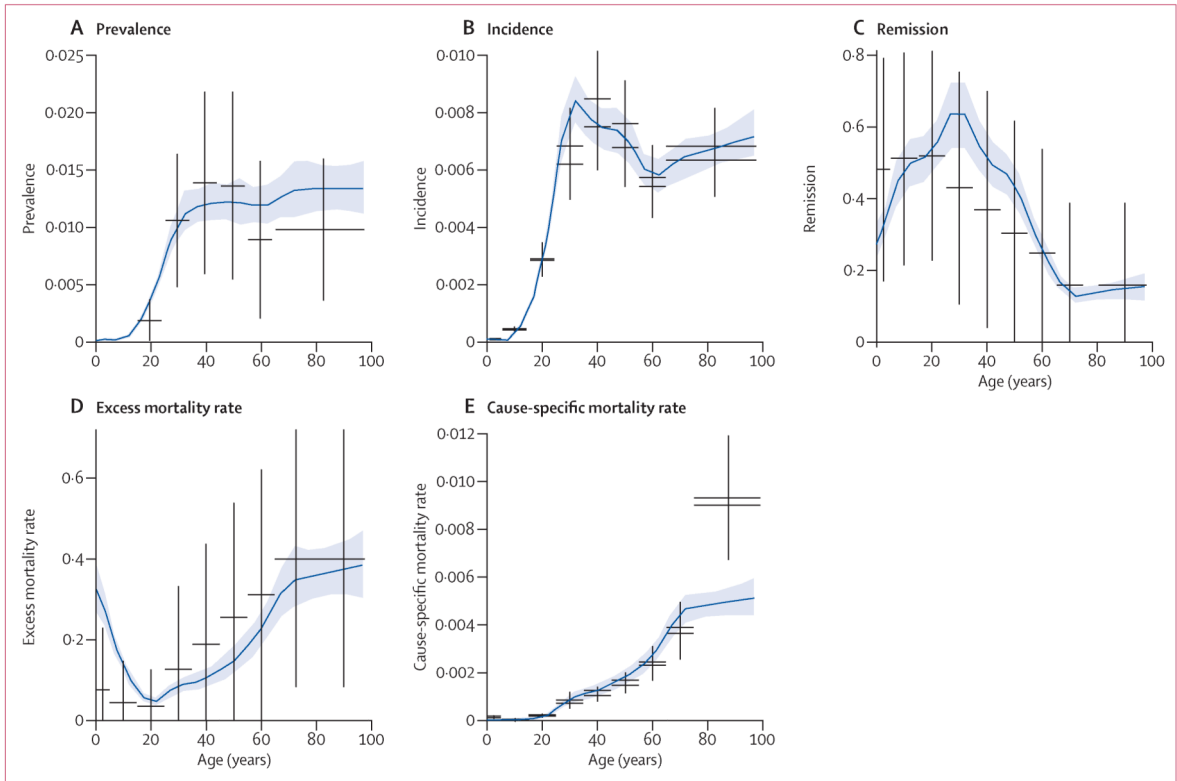

Figure 5. Bayesian meta-regression estimates for tuberculosis prevalence (A), incidence (B), remission (C), excess mortality (D), and cause-specific mortality (E) for male individuals in Kenya, 2013

For each observation in black, the length of the horizontal bar refers to the age interval of the observation and the length of the vertical bar refers to the uncertainty interval. To stabilise estimates, all data from 2008 to 2013 are included.

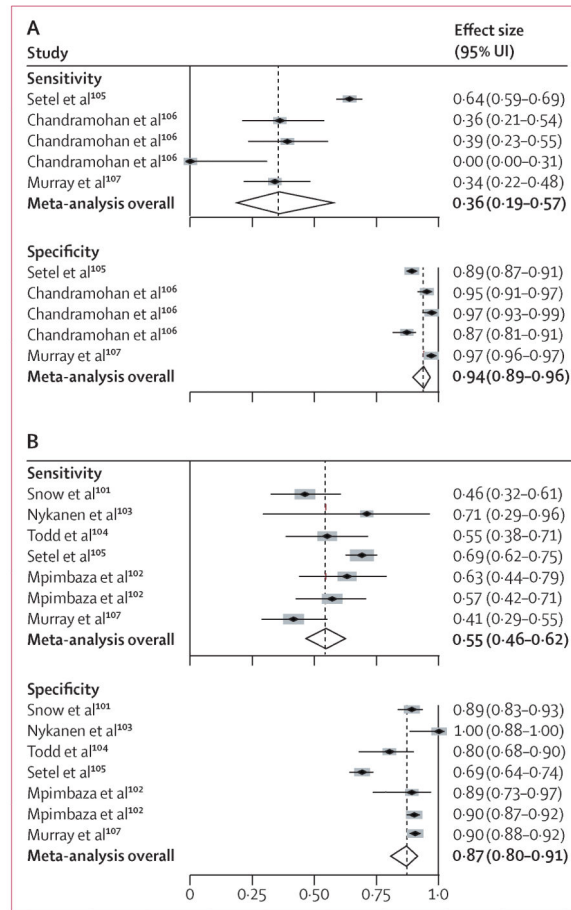

Figure 6. Meta-analysis of published validation studies of verbal autopsy for malaria in adults (A) and children (B), both sexes combined

The solid lines show 95% uncertainty intervals (ui); the dotted lines show the point estimate of the pooled estimate (the diamond). The age cutoff for children is <15 years.

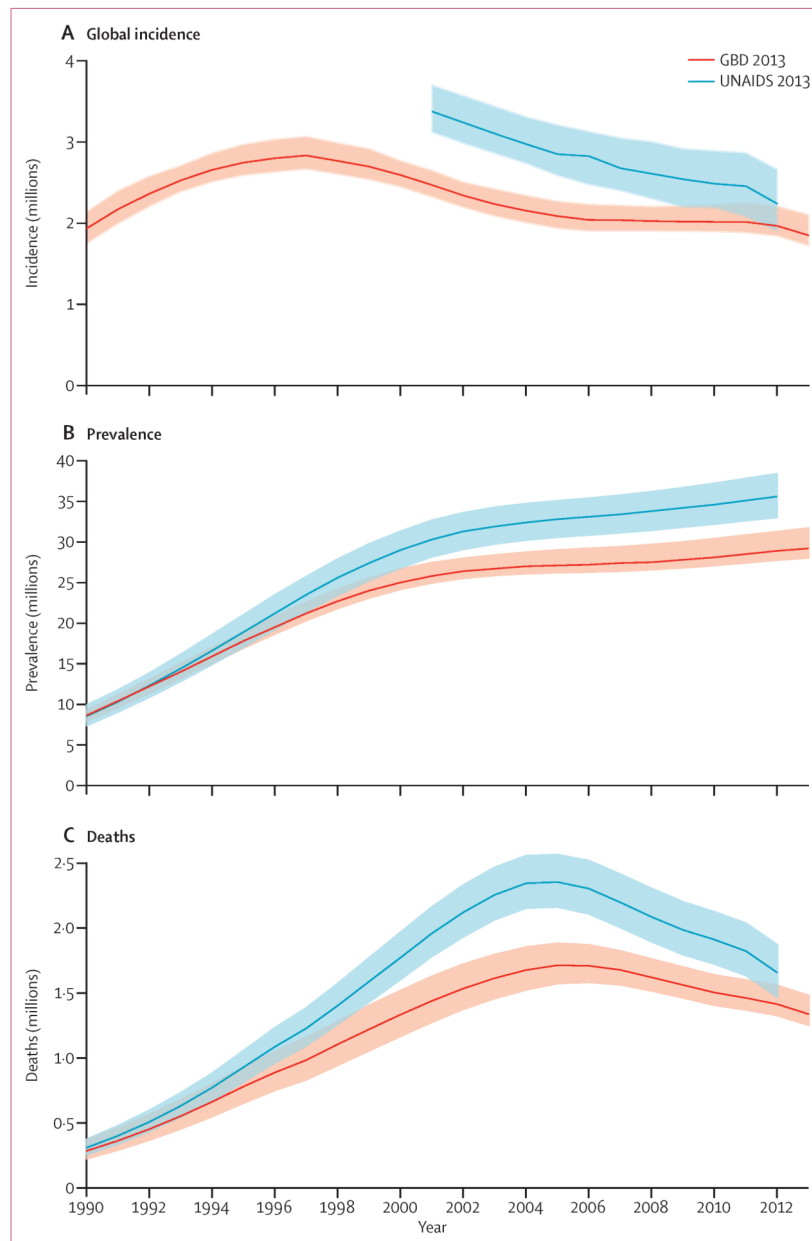

Figure 7. Global HIV incidence (A), prevalence (B), and mortality (C), 1990-2013, for all ages and both sexes combined

Shaded areas are 95% uncertainty intervals.

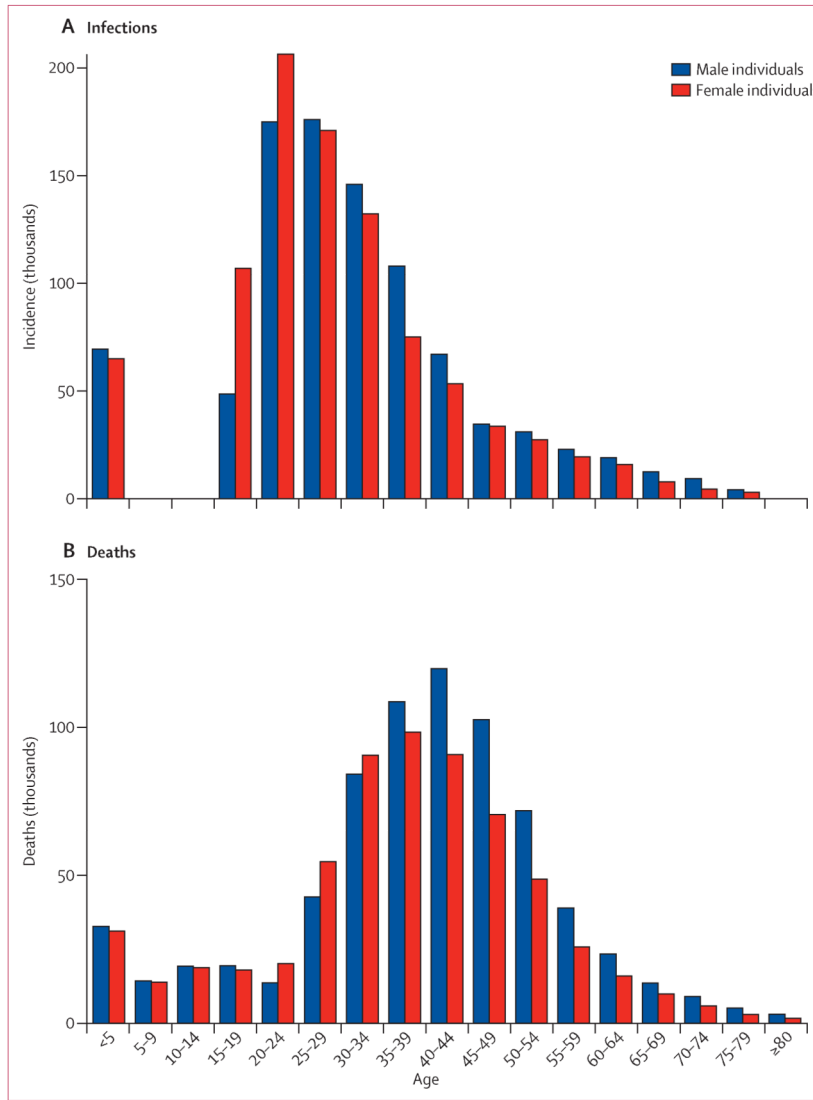

Figure 8. Global age-sex distribution of new HIV infections (A) and deaths (B) in 2013

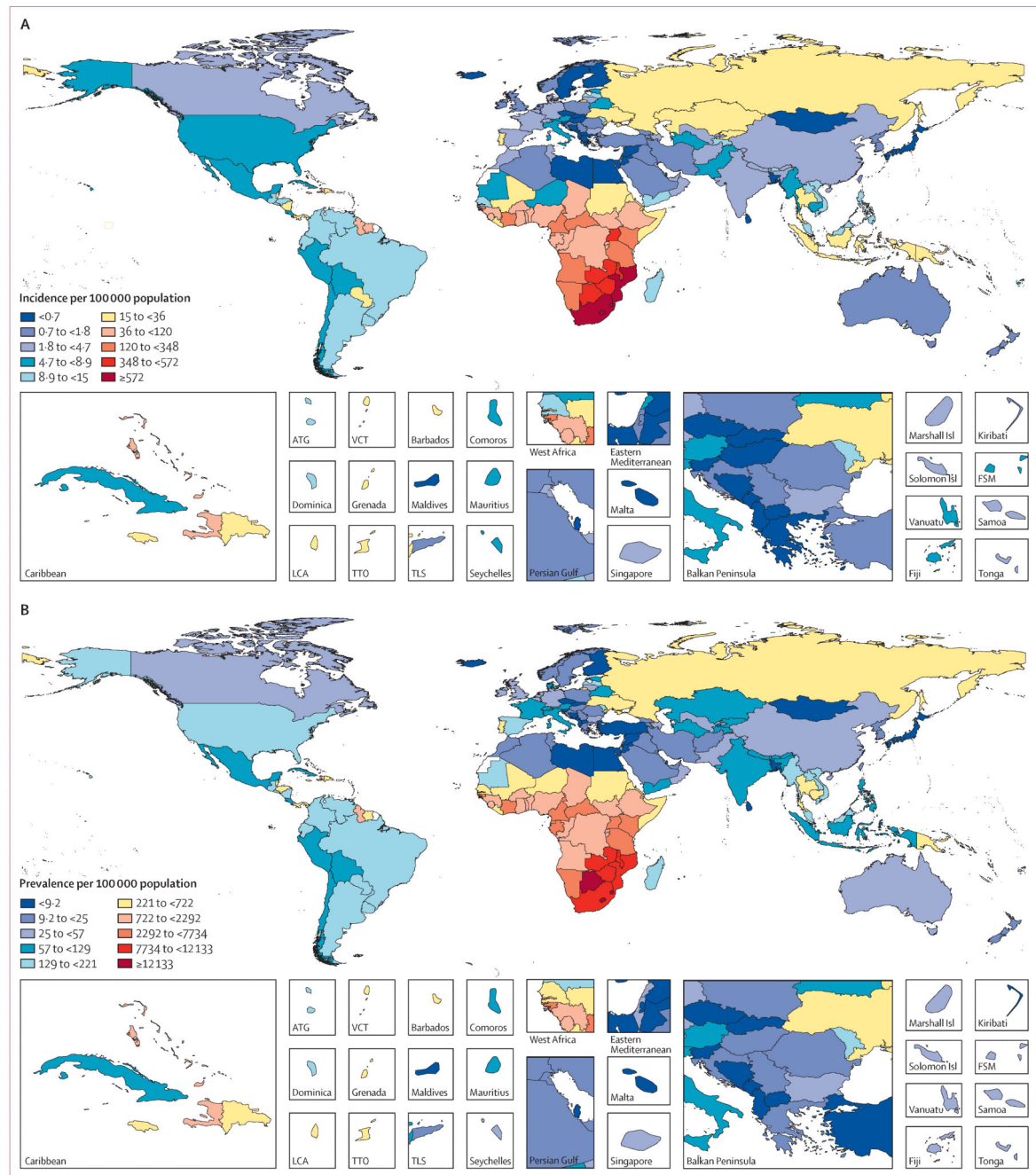

Figure 9. Age-standardised HIV incidence (A) and prevalence (B) in 2013, both sexes
 ATG=Antigua and Barbuda. VCT=Saint Vincent and the Grenadines. Isl=Islands.
 FSM=Federated States of Micronesia. LCA=Saint Lucia. TTO=Trinidad and Tobago.
 TLS=Timor-Leste.

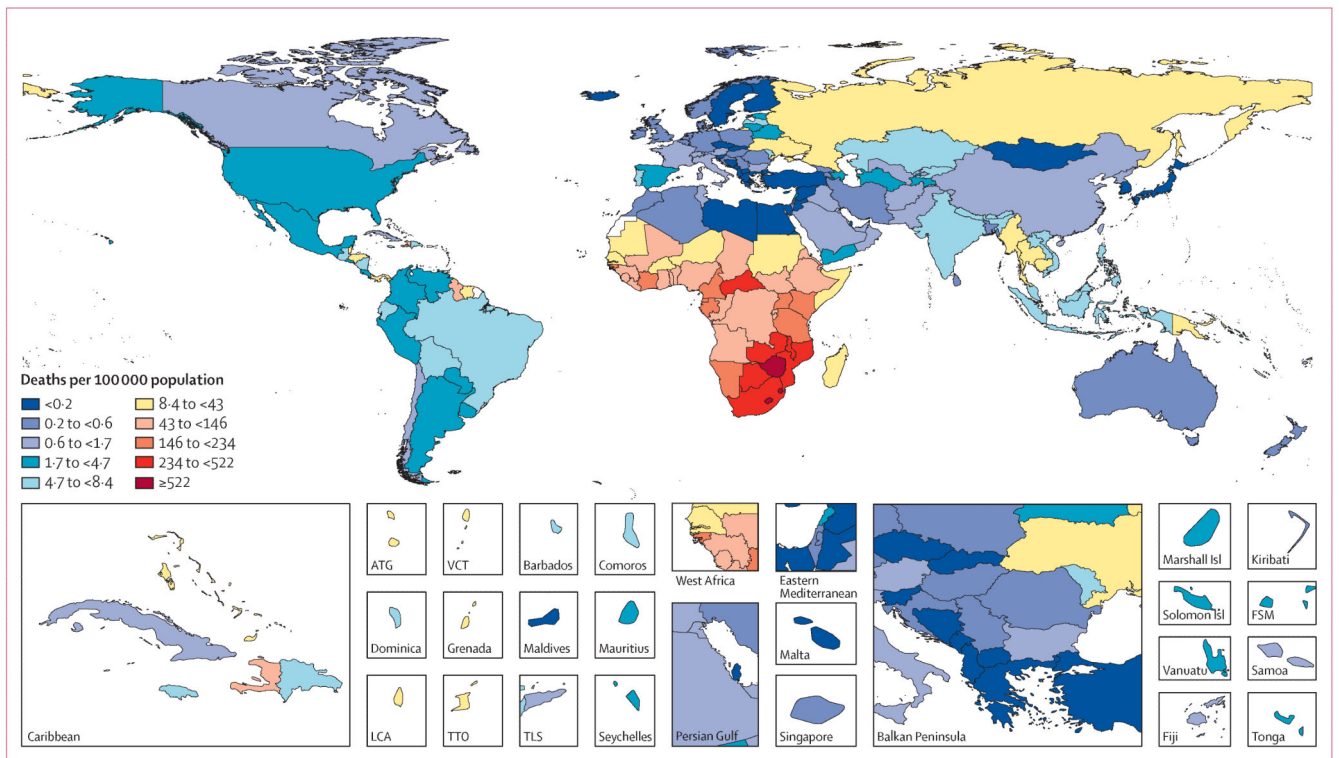

Figure 10. Age-standardised HIV mortality in 2013, both sexes
 ATG=Antigua and Barbuda. VCT=Saint Vincent and the Grenadines. Isl=Islands.
 FSM=Federated States of Micronesia. LCA=Saint Lucia. TTO=Trinidad and Tobago.
 TLS=Timor-Leste.

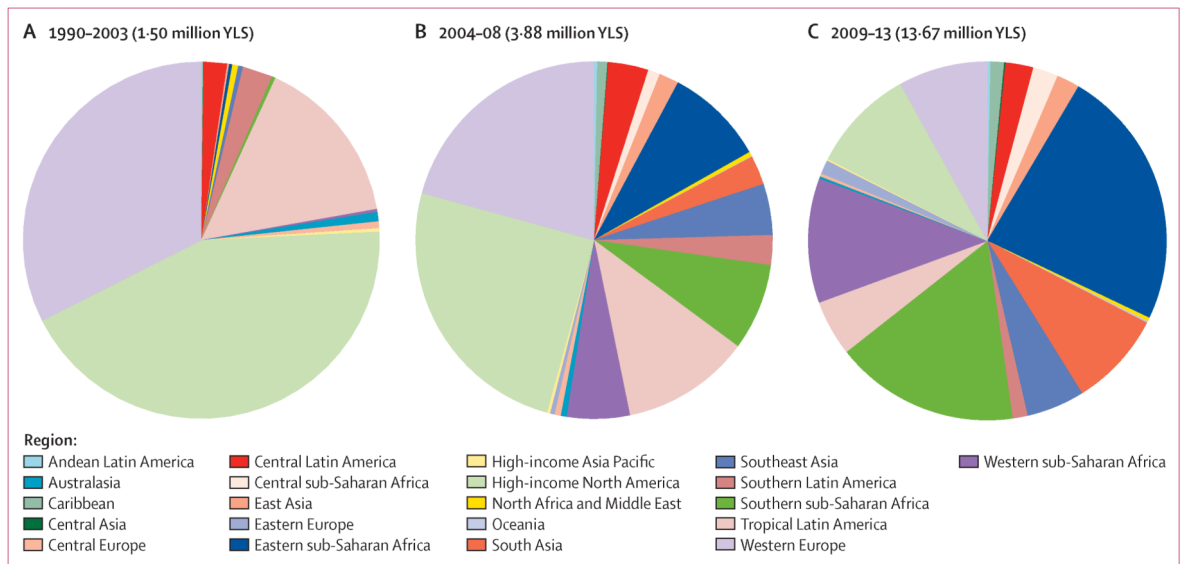

Figure 11. Years of life saved (YLS) through prophylactic treatment by region in 1990–2003 (A), 2004–08 (B), and 2009–13 (C), both sexes

Treatment includes antiretroviral therapy, prevention of mother-to-child transmission, and co-trimoxazole prophylaxis.

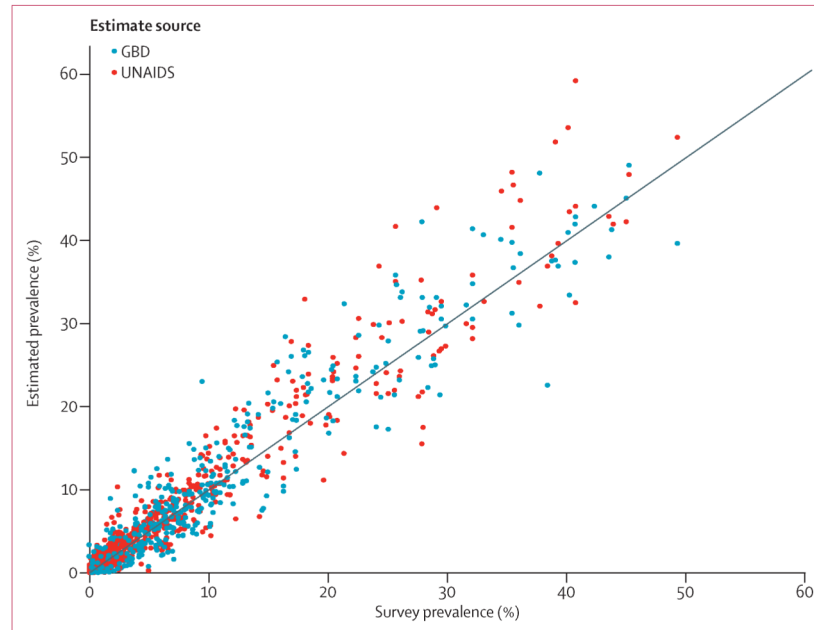

Figure 12. Comparison of 43 national HIV prevalence survey results for people aged 15–49 to prevalence estimates from the GBD 2013 and UNAIDS for the same year and age-group Each point corresponds to an estimate for a particular country, survey year, sex, and 5-year age group. The solid line indicates the line of equivalence.

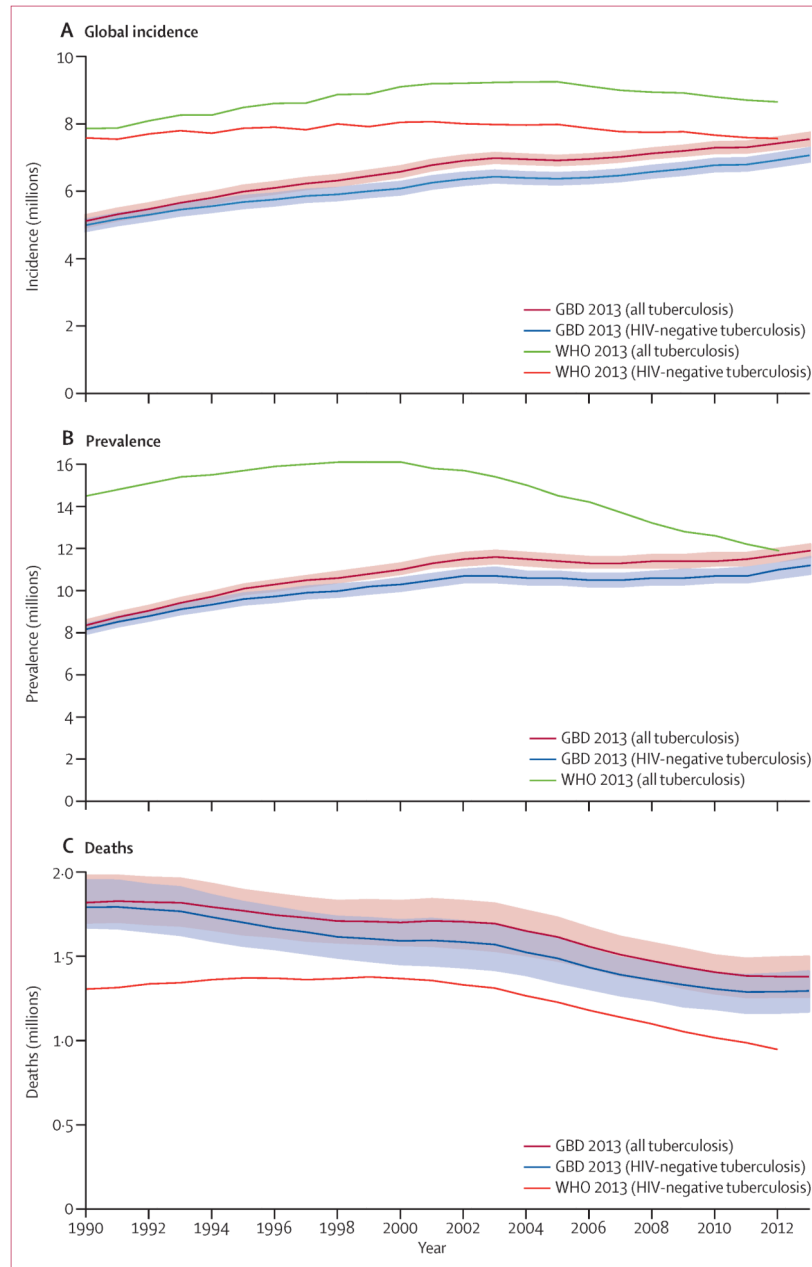

Figure 13. Global tuberculosis incidence (A), prevalence (B), and deaths (C), 1990-2013, for all ages and both sexes combined

Shaded areas show 95% uncertainty intervals.

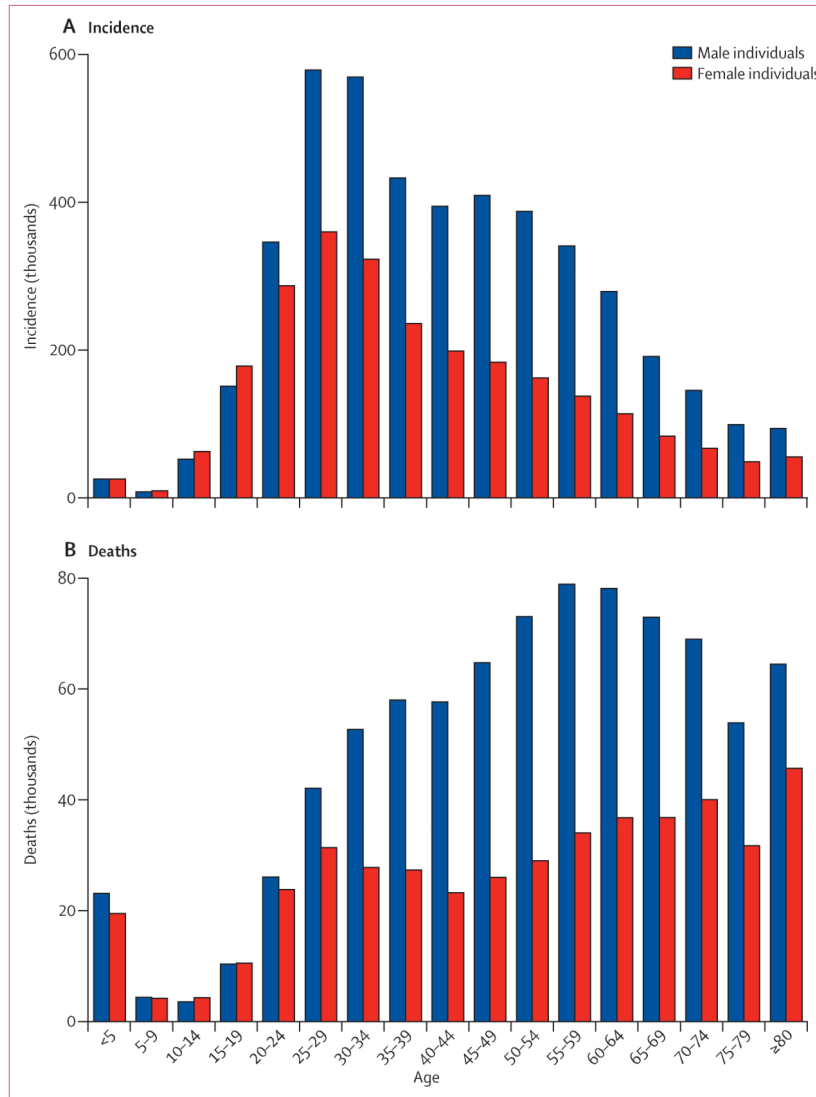

Figure 14. Global age-sex distribution of tuberculosis incidence (A) and deaths (B) in HIV-negative individuals in 2013

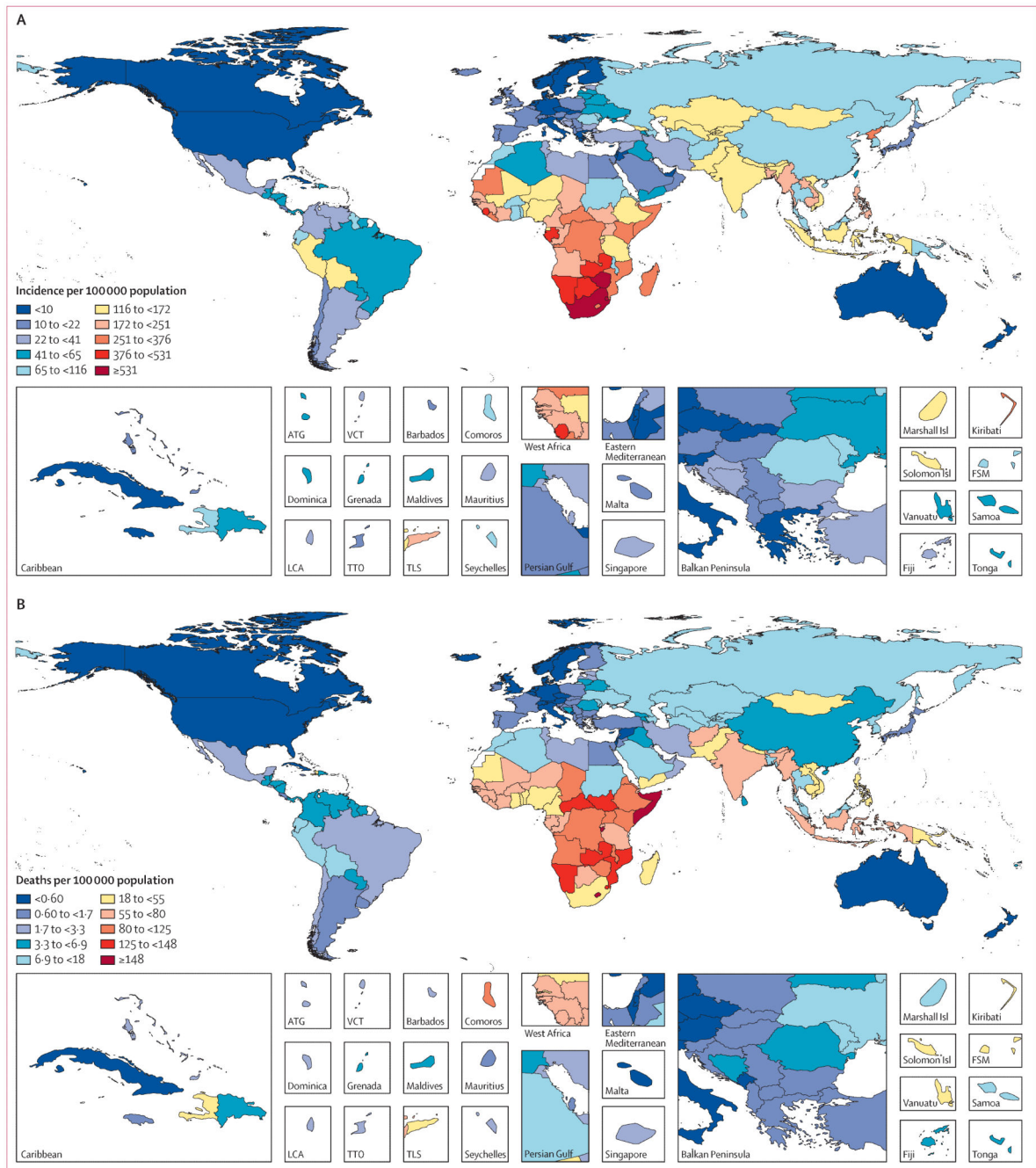

Figure 15. Age-standardised tuberculosis incidence (A) and death rates (B) in HIV-negative individuals in 2013, both sexes

ATG=Antigua and Barbuda. VCT=Saint Vincent and the Grenadines. Isl=Islands.

FSM=Federated States of Micronesia. LCA=Saint Lucia. TTO=Trinidad and Tobago.

TLS=Timor-Leste.

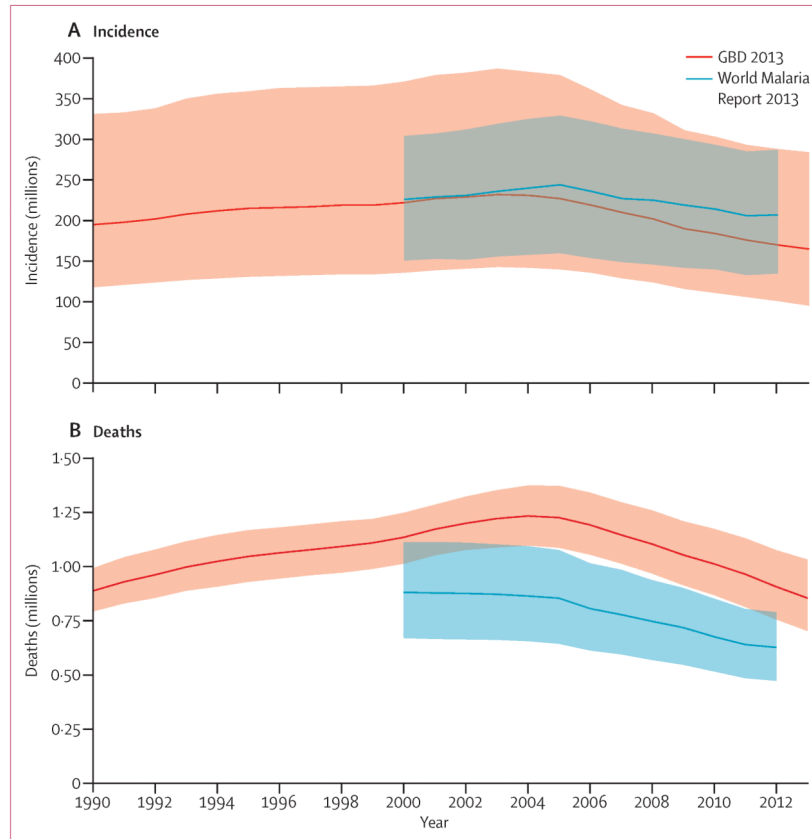

Figure 16. Global malaria incidence (A) and deaths (B), 1990–2013, for all ages and both sexes combined

Shaded areas are 95% uncertainty intervals.

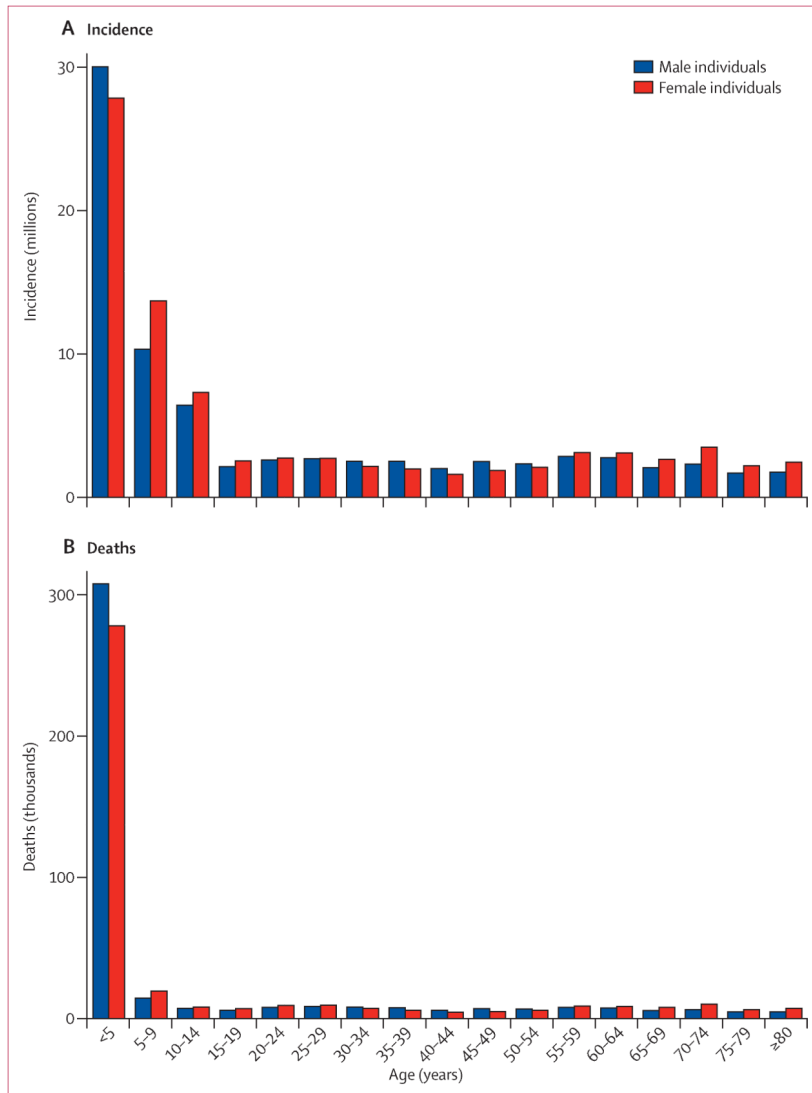

Figure 17. Global age-sex distribution of malaria incidence (A) and deaths (B) in 2013

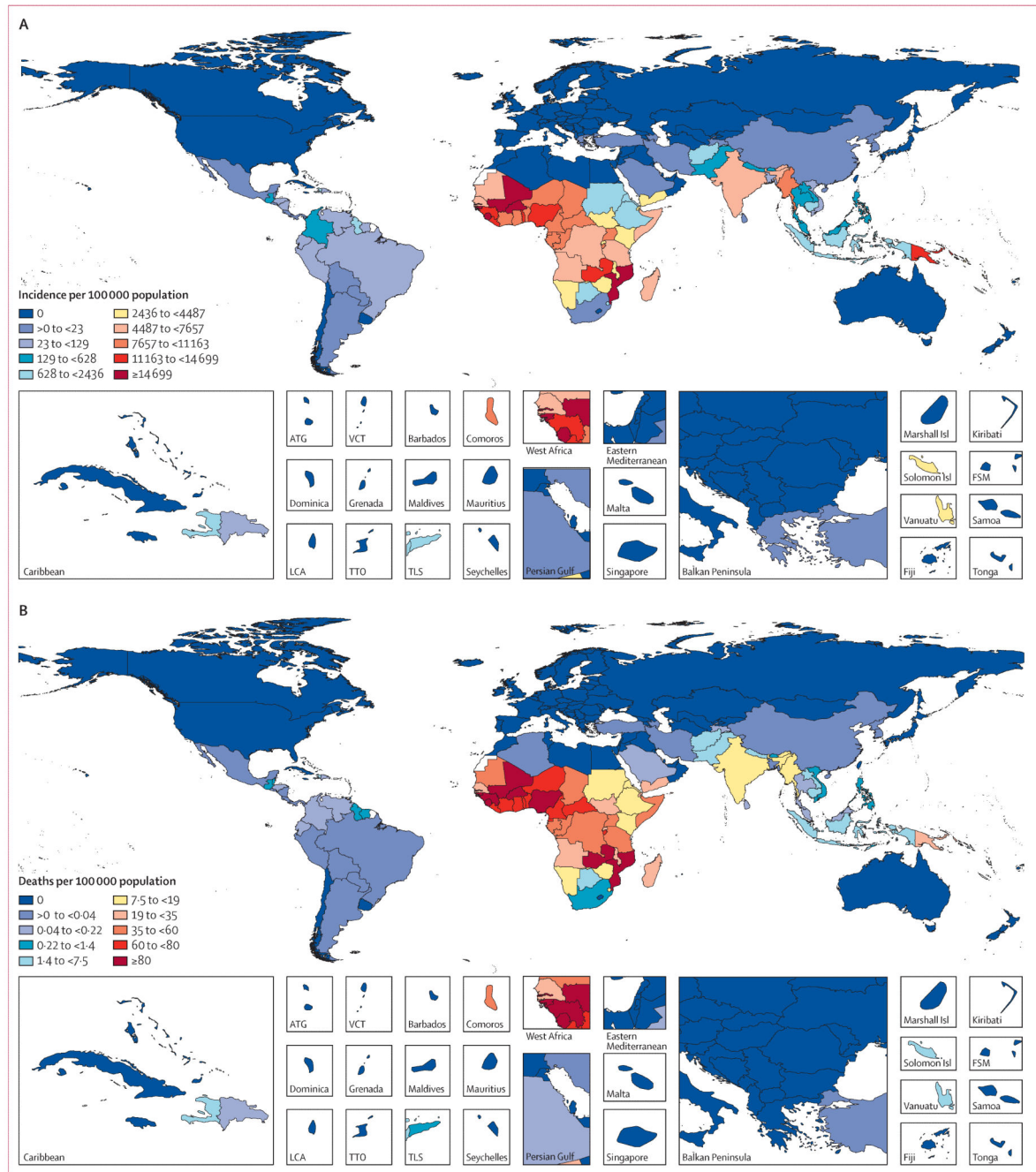

Figure 18. Age-standardised malaria incidence (A) and death (B) rates in 2013, both sexes
 ATG=Antigua and Barbuda. VCT=Saint Vincent and the Grenadines. Isl=Islands.
 FSM=Federated States of Micronesia. LCA=Saint Lucia. TTO=Trinidad and Tobago.
 TLS=Timor-Leste.

Table 1
HIV-specific mortality rates for adults aged 25–34 years on antiretroviral therapy in sub-Saharan Africa, by time since initiation, sex, and initial CD4 count (per 100 person-years)

	Women (time since initiation)			Men (time since initiation)		
	0–6 months	7–12 months	13–24 months	0–6 months	7–12 months	13–24 months
<50 CD4 cells per μL	40.6 (20.4–71.5)	8.9 (6.0–13.4)	4.0 (2.7–5.7)	53.1 (26.5–93.5)	11.6 (7.9–17.5)	5.2 (3.6–7.5)
50–99 CD4 cells per μL	17.4 (12.2–25.0)	6.5 (5.0–8.4)	3.0 (2.3–3.9)	22.8 (16.2–32.4)	8.6 (6.5–11.2)	3.9 (3.0–5.1)
100–199 CD4 cells per μL	14.1 (10.4–18.4)	5.7 (4.4–7.2)	2.6 (2.0–3.3)	18.4 (13.6–24.2)	7.4 (5.8–9.5)	3.4 (2.6–4.3)
200–249 CD4 cells per μL	12.5 (8.9–16.6)	5.1 (3.8–6.5)	2.4 (1.8–3.1)	16.3 (11.6–21.7)	6.6 (4.9–8.6)	3.1 (2.3–4.0)
250–349 CD4 cells per μL	10.7 (7.0–14.8)	4.4 (3.0–6.0)	2.0 (1.4–2.7)	14.0 (9.3–19.4)	5.7 (3.9–7.8)	2.6 (1.8–3.6)
350–499 CD4 cells per μL	8.1 (4.7–12.0)	3.1 (1.8–4.8)	1.4 (0.7–2.2)	10.5 (6.0–15.8)	4.1 (2.4–6.2)	1.8 (1.0–2.8)
500 CD4 cells per μL	6.3 (0.9–11.0)	2.3 (0.1–4.4)	0.9 (0.0–2.0)	8.2 (1.2–14.7)	3.0 (0.1–5.7)	1.2 (0.0–2.6)

Data in parentheses are 95% uncertainty intervals.

Table 2
Age-standardised HIV/AIDS incidence, prevalence, and mortality rates, and annualised rates of change for both sexes for 21 Global Burden of Disease regions

	Age-standardised rates in 2013 (per 100 000 population)			Annualised rate of change (%)					
	Incidence	Prevalence	Mortality	1990–2000			2000–2013		
				Incidence	Prevalence	Mortality	Incidence	Prevalence	Mortality
Worldwide	24.84 (23.10 to 28.26)	400.98 (385.51 to 435.10)	18.51 (17.38 to 20.46)	1.27 (0.24 to 2.16)	8.87 (8.36 to 9.52)	13.62 (11.93 to 15.38)	-3.92 (-4.50 to -3.15)	-0.20 (-0.42 to 0.05)	-1.54 (-2.36 to -0.59)
High-income Asia Pacific	0.49 (0.28 to 0.70)	7.22 (4.81 to 9.97)	0.10 (0.08 to 0.13)	7.74 (3.65 to 13.26)	6.94 (5.12 to 9.46)	0.77 (-1.11 to 2.92)	-1.55 (-5.91 to 1.57)	6.29 (4.49 to 8.22)	1.13 (-0.55 to 3.20)
Central Asia	7.02 (3.62 to 15.56)	61.98 (38.09 to 105.12)	2.67 (1.52 to 4.08)	8.17 (-3.90 to 19.78)	13.11 (1.09 to 24.09)	21.91 (9.43 to 33.39)	4.18 (-2.22 to 12.58)	5.46 (1.76 to 9.62)	2.65 (-2.01 to 5.83)
East Asia	2.28 (1.31 to 4.09)	26.37 (14.36 to 41.32)	0.77 (0.60 to 1.05)	38.86 (27.75 to 62.64)	41.29 (30.82 to 62.45)	45.26 (29.11 to 70.18)	1.41 (-3.60 to 6.83)	8.07 (4.79 to 11.46)	6.09 (2.91 to 10.38)
South Asia	2.69 (0.85 to 5.51)	93.97 (84.36 to 112.06)	5.42 (4.43 to 7.18)	-9.72 (-15.85 to -5.81)	3.91 (1.89 to 5.98)	13.67 (7.68 to 23.47)	-13.93 (-19.71 to -8.09)	-7.85 (-8.67 to -6.64)	-11.58 (-14.45 to -7.11)
Southeast Asia	13.88 (6.66 to 41.04)	176.39 (113.22 to 421.49)	7.54 (3.90 to 23.55)	-10.46 (-15.54 to -4.52)	8.07 (5.78 to 12.44)	29.51 (25.47 to 33.97)	1.29 (-2.74 to 7.36)	0.97 (-0.78 to 3.51)	-3.87 (-6.62 to 1.36)
Australasia	1.50 (0.81 to 2.32)	35.09 (22.80 to 50.24)	0.37 (0.26 to 0.53)	-7.07 (-11.53 to -3.51)	-1.86 (-3.67 to -0.18)	-11.88 (-14.40 to -9.10)	0.41 (-1.27 to 2.85)	1.07 (-0.53 to 2.49)	-4.51 (-6.49 to -2.60)
Caribbean	32.24 (25.95 to 39.68)	497.47 (450.24 to 551.29)	23.30 (19.26 to 29.15)	-6.32 (-8.01 to -4.81)	1.07 (-0.46 to 3.04)	9.02 (4.68 to 12.88)	-2.93 (-4.21 to -1.46)	-0.83 (-1.46 to -0.25)	-6.04 (-6.91 to -5.03)
Central Europe	0.95 (0.71 to 1.23)	16.62 (13.41 to 20.11)	0.44 (0.37 to 0.51)	1.29 (-1.78 to 4.40)	8.90 (6.61 to 11.36)	8.06 (6.44 to 10.09)	-0.55 (-3.44 to 2.08)	2.37 (1.20 to 3.44)	0.19 (-1.28 to 1.41)
Eastern Europe	22.58 (16.56 to 31.65)	263.86 (209.53 to 347.22)	11.14 (8.75 to 14.14)	25.17 (18.06 to 34.84)	18.47 (14.57 to 24.08)	13.07 (9.88 to 16.41)	-1.53 (-3.75 to 0.86)	4.75 (3.18 to 6.14)	8.51 (6.41 to 10.74)
Western Europe	3.26 (2.56 to 4.22)	80.97 (66.16 to 99.08)	1.06 (0.90 to 1.24)	-9.15 (-14.34 to -5.01)	0.92 (-0.14 to 2.04)	-6.75 (-8.06 to -5.34)	0.05 (-1.77 to 2.05)	0.60 (-0.21 to 1.62)	-3.59 (-4.72 to -2.25)
Andean Latin America	7.96 (4.64 to 16.84)	106.52 (76.06 to 171.80)	3.92 (2.40 to 9.39)	1.91 (-16.44 to 14.95)	11.70 (2.21 to 21.36)	19.73 (11.89 to 28.79)	-1.09 (-6.07 to 4.63)	1.15 (-1.96 to 4.60)	-3.52 (-6.58 to 0.62)
Central Latin America	9.43 (7.48 to 11.55)	139.92 (118.12 to 167.80)	4.08 (3.13 to 6.16)	-2.00 (-8.23 to 1.40)	7.04 (3.66 to 9.32)	13.13 (10.27 to 16.05)	-0.64 (-1.81 to 0.37)	0.99 (-1.33 to 2.31)	-5.46 (-7.10 to -3.86)

	Age-standardised rates in 2013 (per 100 000 population)			Annualised rate of change (%)					
	Incidence	Prevalence	Mortality	1990–2000			2000–2013		
				Incidence	Prevalence	Mortality	Incidence	Prevalence	Mortality
Southern Latin America	10·11 (7·11 to 14·94)	173·57 (144·31 to 210·86)	3·12 (2·23 to 4·10)	−0·75 (−4·84 to 3·85)	8·44 (5·39 to 12·40)	10·00 (6·17 to 13·76)	−0·24 (−3·40 to 3·08)	2·60 (1·08 to 3·97)	−2·76 (−5·37 to −0·65)
Tropical Latin America	11·64 (8·93 to 15·83)	188·35 (125·90 to 244·16)	4·83 (3·83 to 6·09)	−7·15 (−10·27 to −3·64)	2·20 (0·13 to 4·56)	1·09 (−2·41 to 6·19)	0·37 (−1·16 to 2·50)	1·10 (−0·25 to 2·23)	−2·20 (−4·57 to 0·01)
North Africa and Middle East	2·84 (1·93 to 4·93)	26·45 (21·31 to 39·26)	1·66 (1·26 to 2·39)	11·52 (0·35 to 25·42)	16·98 (7·18 to 30·42)	20·66 (9·81 to 35·43)	−0·35 (−4·01 to 5·02)	1·94 (−0·71 to 5·64)	3·05 (−0·99 to 7·85)
High-income North America	7·43 (3·46 to 17·16)	135·49 (78·21 to 220·57)	2·65 (1·68 to 3·69)	−8·87 (−13·56 to −3·10)	−3·31 (−6·16 to −1·52)	−10·20 (−13·49 to −7·99)	2·01 (−3·23 to 9·49)	1·24 (−1·09 to 4·97)	−2·89 (−5·95 to −0·10)
Oceania	16·09 (11·07 to 22·43)	341·52 (287·06 to 403·52)	18·80 (13·86 to 25·16)	15·64 (5·25 to 27·08)	23·43 (17·21 to 30·47)	31·68 (27·45 to 36·49)	−9·47 (−11·74 to −7·34)	0·30 (−2·04 to 3·13)	1·21 (−3·80 to 6·92)
Central sub-Saharan Africa	94·53 (78·72 to 113·99)	1328·37 (1222·40 to 1439·78)	94·45 (81·17 to 111·04)	−0·25 (−1·66 to 0·93)	2·92 (1·96 to 3·97)	5·71 (3·57 to 8·17)	−3·89 (−5·15 to −2·60)	−1·43 (−2·09 to −0·78)	−2·42 (−3·47 to −1·14)
Eastern sub-Saharan Africa	177·08 (163·51 to 191·29)	3416·89 (3249·05 to 3609·25)	164·58 (154·75 to 175·06)	−3·87 (−4·99 to −2·81)	5·92 (5·27 to 6·51)	14·50 (12·89 to 16·00)	−4·40 (−5·14 to −3·65)	−1·74 (−1·98 to −1·51)	−3·78 (−4·82 to −2·65)
Southern sub-Saharan Africa	647·13 (606·40 to 693·70)	11 850·47 (11 368·38 to 12 327·29)	511·41 (467·65 to 556·63)	10·60 (9·80 to 11·47)	21·69 (21·08 to 22·58)	31·17 (28·62 to 33·63)	−4·58 (−5·16 to −4·00)	1·13 (0·90 to 1·35)	3·41 (1·54 to 4·88)
Western sub-Saharan Africa	90·89 (77·20 to 107·09)	1833·57 (1692·97 to 1999·25)	114·36 (103·20 to 127·44)	5·79 (3·88 to 8·08)	13·12 (11·69 to 14·69)	18·75 (16·65 to 21·01)	−7·26 (−8·40 to −6·19)	−0·84 (−1·56 to −0·20)	0·82 (−0·38 to 2·01)

Data in parentheses are 95% uncertainty intervals.

Table 3
HIV/AIDS incidence and deaths for all ages by sex and annualised rates of change for 21 Global Burden of Disease regions and 188 countries

	Annualised rate of change (%)													
	All ages incidence and deaths (2013)				1990–2000				2000–13					
	Male population		Female population		Total		Incidence		Deaths		Incidence		Deaths	
Incidence	Deaths	Incidence	Deaths	Incidence	Deaths	Incidence	Deaths	Incidence	Deaths	Incidence	Deaths	Incidence	Deaths	
Worldwide	924 776 (845 603 to 1 104 526)	723 124 (670 708 to 831 754)	922 869 (863 238 to 1 007 549)	617 850 (570 414 to 677 695)	1 847 645 (1 719 830 to 1 01 652)	1 340 974 (1 257 838 to 1 482 611)	1 847 645 (1 719 830 to 1 01 652)	1 340 974 (1 257 838 to 1 482 611)	1 27 (0.24 to 2.16)	13.62 (11.93 to 15.38)	1.27 (0.24 to 2.16)	13.62 (11.93 to 15.38)	-3.92 (-4.50 to -3.15)	-1.54 (-2.36 to -0.59)
Developed countries	74 405 (57 060 to 104 422)	35 884 (29 743 to 43 334)	20 947 (15 405 to 29 844)	8746 (6465 to 11 375)	95 352 (72 788 to 132 862)	44 630 (36 750 to 53 676)	95 352 (72 788 to 132 862)	44 630 (36 750 to 53 676)	1.53 (-1.30 to 4.82)	-5.46 (-7.13 to -4.17)	1.53 (-1.30 to 4.82)	-5.46 (-7.13 to -4.17)	-0.35 (-2.27 to 2.45)	2.18 (0.76 to 3.83)
Developing countries	850 371 (777 712 to 1 030 189)	687 240 (636 836 to 792 586)	901 923 (842 259 to 987 825)	609 104 (562 000 to 668 733)	1752 294 (1 631 535 to 014 476)	1296 344 (1 214 834 to 435 882)	1752 294 (1 631 535 to 014 476)	1296 344 (1 214 834 to 435 882)	0.74 (-0.35 to 1.70)	15.07 (12.86 to 17.34)	0.74 (-0.35 to 1.70)	15.07 (12.86 to 17.34)	-4.32 (-4.92 to -3.48)	-2.01 (-2.87 to -1.00)
High-income Asia Pacific	590 (352 to 847)	149 (120 to 185)	268 (144 to 407)	58 (41 to 104)	857 (493 to 1228)	207 (164 to 270)	857 (493 to 1228)	207 (164 to 270)	11.4 (3.65 to 13.26)	0.77 (-1.11 to 2.92)	11.4 (3.65 to 13.26)	0.77 (-1.11 to 2.92)	-1.55 (-5.91 to 1.57)	1.13 (-0.55 to 3.20)
Brunei	43 (32 to 57)	32 (27 to 40)	7 (5 to 11)	2 (1 to 4)	50 (37 to 68)	35 (29 to 44)	50 (37 to 68)	35 (29 to 44)	3.21 (-10.55 to 12.48)	21.17 (14.06 to 29.36)	3.21 (-10.55 to 12.48)	21.17 (14.06 to 29.36)	0.02 (-2.14 to 2.46)	-0.61 (-2.49 to 1.95)
Japan	153 (86 to 230)	45 (30 to 67)	55 (31 to 82)	17 (11 to 24)	208 (120 to 308)	61 (43 to 90)	208 (120 to 308)	61 (43 to 90)	3.28 (-0.33 to 7.00)	-2.54 (-4.84 to -0.11)	3.28 (-0.33 to 7.00)	-2.54 (-4.84 to -0.11)	-0.54 (-4.55 to 1.91)	-2.26 (-4.86 to -0.13)
Singapore	52 (23 to 110)	16 (9 to 30)	26 (11 to 56)	7 (4 to 12)	78 (35 to 164)	23 (14 to 42)	78 (35 to 164)	23 (14 to 42)	-13.07 (-20.83 to -1.69)	12.38 (5.24 to 20.14)	-13.07 (-20.83 to -1.69)	12.38 (5.24 to 20.14)	3.37 (-4.69 to 11.26)	-4.29 (-8.00 to -0.43)
South Korea	342 (118 to 591)	56 (37 to 82)	179 (62 to 308)	32 (19 to 77)	522 (184 to 874)	88 (57 to 148)	522 (184 to 874)	88 (57 to 148)	15.87 (9.91 to 26.23)	-3.51 (-8.50 to 2.60)	15.87 (9.91 to 26.23)	-3.51 (-8.50 to 2.60)	-3.46 (-10.76 to 0.83)	6.76 (2.61 to 11.41)
Central Asia	4490 (2252 to 10 200)	1711 (965 to 2561)	1784 (913 to 3521)	497 (265 to 801)	6274 (3253 to 13 832)	2207 (1270 to 3346)	6274 (3253 to 13 832)	2207 (1270 to 3346)	8.17 (-3.90 to 19.78)	21.91 (9.43 to 33.39)	8.17 (-3.90 to 19.78)	21.91 (9.43 to 33.39)	4.18 (-2.22 to 12.58)	2.65 (-2.01 to 5.83)
Armenia	20 (9 to 42)	6 (3 to 10)	5 (2 to 10)	1 (0 to 2)	25 (11 to 51)	7 (4 to 12)	25 (11 to 51)	7 (4 to 12)	87.64 (54.77 to 144.28)	89.27 (52.19 to 137.94)	87.64 (54.77 to 144.28)	89.27 (52.19 to 137.94)	-1.36 (-10.11 to 4.10)	14.06 (7.12 to 24.32)
Azerbaijan	315 (141 to 603)	161 (45 to 320)	83 (37 to 158)	32 (9 to 78)	398 (177 to 764)	193 (53 to 395)	398 (177 to 764)	193 (53 to 395)	16.42 (4.71 to 36.74)	22.22 (7.00 to 33.51)	16.42 (4.71 to 36.74)	22.22 (7.00 to 33.51)	3.19 (-3.81 to 8.75)	8.45 (0.42 to 15.03)
Georgia	45 (22 to 74)	8 (6 to 10)	23 (11 to 38)	3 (2 to 4)	68 (34 to 110)	11 (8 to 14)	68 (34 to 110)	11 (8 to 14)	34.85 (24.05 to 45.34)	35.00 (21.69 to 50.13)	34.85 (24.05 to 45.34)	35.00 (21.69 to 50.13)	8.01 (3.08 to 13.16)	11.71 (8.46 to 14.92)

	Annualised rate of change (%)													
	All ages incidence and deaths (2013)						1990–2000						2000–13	
	Male population			Female population			Total			Incidence			Deaths	
	Incidence	Deaths	Incidence	Deaths	Incidence	Deaths	Incidence	Deaths	Incidence	Deaths	Incidence	Deaths	Incidence	Deaths
Kazakhstan	2177 (510 to 7608)	899 (212 to 1708)	633 (141 to 2224)	173 (30 to 429)	2810 (647 to 9972)	1072 (240 to 2118)	10.31 (-2.644 to 45.69)	28.30 (5.67 to 85.36)	5.73 (-7.49 to 27.27)	28.30 (5.67 to 85.36)	5.73 (-7.49 to 27.27)	28.30 (5.67 to 85.36)	3.14 (-8.16 to 8.76)	
Kyrgyzstan	683 (115 to 1720)	214 (60 to 379)	195 (33 to 511)	43 (6 to 93)	878 (151 to 2218)	257 (68 to 469)	-2.16 (-16.93 to 16.12)	25.71 (12.31 to 38.25)	11.06 (0.14 to 20.67)	25.71 (12.31 to 38.25)	11.06 (0.14 to 20.67)	25.71 (12.31 to 38.25)	3.14 (-6.69 to 10.25)	
Mongolia	4 (0 to 20)	1 (0 to 4)	2 (0 to 9)	0 (0 to 1)	6 (0 to 29)	1 (0 to 6)	-27.80 (-44.31 to -6.63)	0.06 (-13.83 to 15.83)	30.42 (1.12 to 52.69)	0.06 (-13.83 to 15.83)	30.42 (1.12 to 52.69)	0.06 (-13.83 to 15.83)	-7.87 (-22.36 to 9.43)	
Tajikistan	391 (72 to 989)	108 (18 to 247)	455 (81 to 1139)	145 (14 to 290)	846 (154 to 2119)	253 (33 to 537)	10.63 (-23.93 to 51.46)	19.30 (-4.33 to 63.17)	8.54 (-3.57 to 23.08)	19.30 (-4.33 to 63.17)	8.54 (-3.57 to 23.08)	19.30 (-4.33 to 63.17)	4.76 (-10.22 to 17.68)	
Turkmenistan	338 (76 to 1209)	114 (49 to 213)	128 (28 to 461)	34 (15 to 65)	466 (103 to 1667)	148 (65 to 272)	5.29 (-29.36 to 34.92)	21.57 (-2.08 to 68.63)	6.55 (-5.74 to 27.61)	21.57 (-2.08 to 68.63)	6.55 (-5.74 to 27.61)	21.57 (-2.08 to 68.63)	3.16 (-3.99 to 7.62)	
Uzbekistan	518 (297 to 789)	200 (115 to 348)	259 (152 to 403)	66 (36 to 130)	777 (458 to 1188)	266 (156 to 466)	11.31 (-0.46 to 23.84)	31.77 (21.98 to 41.37)	-3.01 (-7.00 to 0.37)	31.77 (21.98 to 41.37)	-3.01 (-7.00 to 0.37)	31.77 (21.98 to 41.37)	-3.85 (-8.97 to 0.63)	
East Asia	25 342 (14 456 to 45 002)	9317 (7316 to 12 472)	10 968 (6165 to 19 647)	3259 (2213 to 4653)	36 310 (20 768 to 64 990)	12 575 (9827 to 17 026)	38.86 (27.75 to 62.64)	45.26 (29.11 to 70.18)	1.41 (-3.60 to 6.83)	45.26 (29.11 to 70.18)	1.41 (-3.60 to 6.83)	45.26 (29.11 to 70.18)	6.09 (2.91 to 10.38)	
China	24 843 (13 863 to 44 316)	89 88 (7010 to 12 114)	10 822 (6058 to 19 487)	3157 (2118 to 4554)	35 665 (20 128 to 64 616)	12 145 (9418 to 16 555)	38.58 (27.80 to 49.41)	45.85 (28.95 to 79.48)	1.47 (-3.62 to 7.00)	45.85 (28.95 to 79.48)	1.47 (-3.62 to 7.00)	45.85 (28.95 to 79.48)	5.99 (2.76 to 10.39)	
North Korea	189 (56 to 380)	152 (118 to 194)	91 (29 to 185)	75 (56 to 98)	280 (83 to 565)	227 (179 to 287)	21.59 (12.20 to 37.57)	33.79 (21.86 to 53.69)	-1.88 (-12.11 to 4.93)	33.79 (21.86 to 53.69)	-1.88 (-12.11 to 4.93)	33.79 (21.86 to 53.69)	8.90 (6.28 to 12.71)	
Taiwan (Province of China)	309 (113 to 743)	176 (129 to 246)	55 (20 to 130)	26 (18 to 39)	365 (135 to 873)	203 (148 to 283)	28.85 (16.22 to 48.47)	35.27 (20.08 to 55.54)	-1.66 (-12.16 to 13.51)	35.27 (20.08 to 55.54)	-1.66 (-12.16 to 13.51)	35.27 (20.08 to 55.54)	10.02 (6.43 to 15.42)	
South Asia	28 607 (9 436 to 63 683)	52 794 (41 230 to 70 403)	17 265 (5343 to 30 460)	30 592 (20 739 to 41 289)	45 872 (14 702 to 93 994)	83 387 (68 991 to 106 495)	-9.72 (-15.85 to -5.81)	13.67 (7.68 to 23.47)	-13.93 (-19.71 to -8.09)	13.67 (7.68 to 23.47)	-13.93 (-19.71 to -8.09)	13.67 (7.68 to 23.47)	-11.58 (-14.45 to -7.11)	
Afghanistan	325 (40 to 1346)	117 (11 to 597)	127 (15 to 541)	47 (4 to 215)	452 (55 to 1897)	163 (16 to 824)	2.20 (-19.25 to 18.88)	8.71 (-3.05 to 28.80)	5.71 (-2.95 to 16.86)	8.71 (-3.05 to 28.80)	5.71 (-2.95 to 16.86)	8.71 (-3.05 to 28.80)	2.16 (-5.67 to 9.65)	
Bangladesh	710 (459 to 1212)	390 (303 to 505)	431 (272 to 713)	181 (109 to 273)	1141 (754 to 1885)	571 (441 to 753)	12.62 (-20.78 to 41.01)	59.57 (36.71 to 81.23)	1.68 (-2.46 to 6.44)	59.57 (36.71 to 81.23)	1.68 (-2.46 to 6.44)	59.57 (36.71 to 81.23)	1.87 (-1.75 to 6.80)	

	Annualised rate of change (%)													
	All ages incidence and deaths (2013)						1990-2000						2000-13	
	Male population			Female population			Total			Incidence			Deaths	
	Incidence	Deaths	Incidence	Deaths	Incidence	Deaths	Incidence	Deaths	Incidence	Deaths	Incidence	Deaths	Incidence	Deaths
Bhutan	36 (5 to 168)	20 (3 to 94)	43 (6 to 197)	20 (2 to 101)	79 (11 to 368)	40 (5 to 199)	8.81 (-8.17 to 21.25)	18.88 (6.58 to 30.69)	2.90 (-3.96 to 13.81)	5.11 (-1.62 to 11.75)				
India	18 408 (2247 to 23 936)	49 345 (38 882 to 63 680)	12 649 (1845 to 16 944)	29 318 (20 048 to 38 653)	31 057 (4091 to 39 459)	78 662 (66 173 to 96 173)	-9.78 (-15.95 to -5.85)	13.72 (7.78 to 23.46)	-16.29 (-27.75 to -11.94)	-11.84 (-14.55 to -7.73)				
Nepal	710 (96 to 2864)	1202 (103 to 6065)	372 (51 to 1512)	326 (23 to 2170)	1082 (151 to 4424)	1527 (130 to 8087)	36.93 (13.55 to 63.73)	30.17 (14.86 to 46.41)	-12.91 (-20.16 to -1.74)	2.47 (-4.47 to 8.63)				
Pakistan	8418 (1124 to 39 250)	1721 (140 to 7984)	3643 (497 to 15 460)	701 (49 to 3405)	12 061 (1617 to 54 744)	2422 (191 to 11 133)	11.79 (-6.98 to 25.04)	14.11 (4.32 to 25.39)	15.09 (6.58 to 26.35)	11.47 (3.15 to 19.37)				
Southeast Asia	65 708 (32 957 to 184 964)	38 199 (20 695 to 552)	26 753 (10 929 to 87 732)	10 141 (4248 to 852)	92 460 (44 216 to 273 917)	48 340 (24 900 to 426)	-10.46 (-15.54 to -4.52)	29.51 (25.47 to 33.97)	1.29 (-2.74 to 7.36)	-3.87 (-6.62 to 1.36)				
Cambodia	904 (137 to 4475)	1073 (125 to 6154)	490 (71 to 2349)	330 (40 to 1330)	1394 (208 to 6873)	1403 (168 to 7430)	-7.21 (-25.86 to 7.49)	34.36 (19.14 to 48.40)	-7.75 (-15.10 to 3.78)	-11.46 (-15.95 to -5.90)				
Indonesia	29 204 (3669 to 127 307)	9846 (666 to 48 942)	15 954 (2027 to 70 429)	4601 (227 to 24 839)	45 159 (5646 to 194 375)	14 446 (912 to 72 555)	0.00 (0.00 to 0.00)	0.00 (0.00 to 0.00)	28.07 (13.66 to 46.43)	87.51 (52.11 to 113.93)				
Laos	576 (83 to 2427)	239 (25 to 1388)	242 (34 to 1061)	80 (7 to 501)	818 (120 to 3481)	320 (32 to 1862)	13.35 (-5.81 to 27.67)	19.67 (7.19 to 35.71)	-0.18 (-7.62 to 10.96)	1.11 (-5.62 to 8.15)				
Malaysia	3070 (2313 to 4137)	1994 (1680 to 2469)	469 (325 to 674)	131 (74 to 226)	3539 (2655 to 4799)	2125 (1774 to 2652)	3.67 (-10.07 to 12.94)	21.63 (14.52 to 29.80)	-0.25 (-2.43 to 2.20)	-0.65 (-2.52 to 1.91)				
Maldives	0 (0 to 0)	0 (0 to 0)	0 (0 to 0)	0 (0 to 0)	0 (0 to 0)	0 (0 to 0)	-9.47 (-14.88 to -4.94)	14.92 (10.85 to 17.60)	-8.71 (-17.42 to -1.64)	-6.22 (-11.69 to -2.61)				
Myanmar	3215 (422 to 18 254)	5831 (635 to 31 666)	924 (119 to 5048)	920 (103 to 5732)	4139 (557 to 23 177)	6751 (743 to 38 390)	9.78 (-8.01 to 23.04)	45.14 (31.23 to 54.70)	-15.43 (-24.74 to -3.19)	-6.13 (-11.88 to 1.03)				
Philippines	6590 (3411 to 11 564)	3607 (2424 to 4613)	2670 (1362 to 4666)	1466 (967 to 1924)	9260 (4907 to 16 077)	5073 (3423 to 6397)	2.00 (-15.41 to 13.40)	23.37 (11.46 to 36.25)	2.32 (-2.51 to 8.42)	1.04 (-2.36 to 2.86)				
Sri Lanka	84 (52 to 135)	43 (32 to 57)	49 (31 to 79)	20 (12 to 29)	133 (82 to 211)	63 (46 to 83)	11.34 (4.50 to 16.40)	29.55 (26.10 to 32.38)	-0.15 (-3.60 to 3.65)	1.04 (-2.02 to 3.54)				
Thailand	8657 (4349 to 13 097)	9421 (5777 to 15 345)	3879 (1907 to 5996)	2173 (1354 to 3324)	12 536 (6320 to 18 644)	11 595 (7310 to 18 164)	-27.50 (-43.89 to -17.76)	29.04 (24.91 to 32.94)	3.21 (-7.02 to 15.57)	-9.64 (-13.16 to -5.95)				

	Annualised rate of change (%)											
	All ages incidence and deaths (2013)				Female population				Total			
	Male population		Deaths		Incidence		Deaths		Incidence		Deaths	
Timor-Leste	9 (4 to 35)	3 (2 to 6)	5 (2 to 19)	2 (1 to 3)	13 (7 to 54)	5 (4 to 9)	30.46 (16.69 to 49.60)	39.58 (17.00 to 61.09)	-1.90 (-7.73 to 11.22)	10.23 (4.43 to 50.18)		
Vietnam	13 311 (6001 to 22 013)	6087 (4485 to 8580)	2035 (914 to 3405)	404 (271 to 603)	15 346 (7019 to 25 391)	6492 (4817 to 9107)	26.87 (15.01 to 36.30)	34.21 (25.75 to 44.35)	-2.57 (-9.79 to 2.24)	6.69 (3.36 to 11.31)		
Australasia	392 (211 to 608)	105 (70 to 157)	51 (27 to 79)	15 (10 to 23)	444 (240 to 689)	120 (82 to 174)	-7.07 (-11.53 to -3.51)	-11.88 (-14.40 to -9.10)	0.41 (-1.27 to 2.85)	-4.51 (-6.49 to -2.60)		
Australia	358 (181 to 576)	94 (60 to 146)	45 (22 to 72)	13 (7 to 20)	403 (203 to 645)	107 (70 to 160)	-7.60 (-12.57 to -3.82)	-11.94 (-14.74 to -8.91)	0.29 (-1.59 to 2.88)	-4.61 (-6.80 to -2.48)		
New Zealand	34 (19 to 61)	10 (7 to 15)	7 (3 to 12)	2 (1 to 4)	41 (22 to 73)	13 (8 to 18)	-0.07 (-4.38 to 5.45)	-11.22 (-13.58 to -9.33)	0.95 (-3.48 to 7.30)	-3.80 (-6.68 to -1.05)		
Caribbean	7561 (6045 to 9227)	5654 (4692 to 7082)	6961 (5436 to 8854)	4805 (3661 to 6350)	14 521 (11 695 to 17 898)	10 459 (8670 to 13 050)	-6.32 (-8.01 to -4.81)	9.02 (4.68 to 12.88)	-2.93 (-4.21 to -1.46)	-6.04 (-6.91 to -5.03)		
Antigua and Barbuda	9 (4 to 21)	7 (5 to 9)	4 (2 to 9)	3 (2 to 4)	13 (6 to 29)	10 (8 to 12)	-5.71 (-13.65 to 4.72)	15.77 (9.28 to 27.19)	-2.30 (-8.08 to 6.04)	-4.62 (-7.05 to -2.67)		
Barbados	49 (33 to 76)	21 (14 to 33)	21 (14 to 33)	6 (4 to 9)	69 (48 to 108)	27 (19 to 40)	-2.18 (-6.56 to 1.26)	13.21 (11.66 to 14.86)	-0.14 (-2.54 to 3.38)	-7.07 (-9.61 to -4.41)		
Belize	73 (38 to 115)	37 (24 to 50)	45 (23 to 72)	12 (7 to 17)	118 (63 to 188)	49 (32 to 65)	15.27 (5.16 to 27.29)	35.46 (29.57 to 42.53)	-5.02 (-10.63 to -0.61)	-2.45 (-6.17 to 0.55)		
Cuba	698 (446 to 1003)	186 (146 to 239)	217 (136 to 321)	35 (25 to 50)	916 (585 to 1309)	221 (175 to 284)	8.96 (3.54 to 12.14)	10.21 (7.74 to 12.60)	3.26 (0.73 to 6.30)	-1.61 (-3.64 to 1.33)		
Dominica	5 (2 to 15)	4 (2 to 6)	3 (1 to 8)	2 (1 to 3)	7 (2 to 23)	5 (4 to 9)	-8.82 (-28.52 to 0.28)	10.81 (3.49 to 21.57)	-1.49 (-9.18 to 13.52)	-5.87 (-9.11 to -1.67)		
Dominican Republic	1089 (417 to 1746)	445 (306 to 621)	693 (264 to 1139)	206 (139 to 292)	1783 (699 to 2830)	650 (459 to 893)	0.57 (-8.57 to 4.79)	19.83 (16.78 to 23.02)	-3.22 (-9.66 to -0.13)	-7.69 (-10.58 to -5.15)		
Grenada	18 (8 to 55)	11 (9 to 13)	10 (4 to 31)	5 (4 to 6)	28 (13 to 87)	16 (13 to 19)	-2.69 (-12.50 to 30.67)	15.29 (9.87 to 25.13)	-3.02 (-8.75 to 7.03)	-4.70 (-6.66 to -3.09)		

	Annualised rate of change (%)														
	Male population			Female population			Total			1990-2000			2000-13		
	Incidence	Deaths	Incidence	Deaths	Incidence	Deaths	Incidence	Deaths	Incidence	Deaths	Incidence	Deaths	Incidence	Deaths	
Hungary	35 (1 to 73)	43 (33 to 56)	8 (0 to 18)	8 (5 to 11)	43 (2 to 90)	51 (39 to 66)	1.04 (-1.27 to 4.30)	-3.52 (-5.69 to -0.65)	-7.63 (-29.64 to 0.40)	-5.44 (-7.02 to -3.66)	8.80 (-6.31 to 18.34)	14.07 (3.70 to 25.04)	-1.38 (-10.27 to 6.27)	2.47 (-1.54 to 6.00)	
Macedonia	2 (0 to 3)	1 (1 to 2)	1 (0 to 2)	1 (0 to 1)	3 (1 to 6)	2 (1 to 3)	8.80 (-6.31 to 18.34)	14.07 (3.70 to 25.04)	-1.38 (-10.27 to 6.27)	2.47 (-1.54 to 6.00)	8.80 (-6.31 to 18.34)	14.07 (3.70 to 25.04)	-1.38 (-10.27 to 6.27)	2.47 (-1.54 to 6.00)	
Montenegro	1 (0 to 2)	1 (0 to 1)	1 (0 to 1)	0 (0 to 1)	1 (0 to 4)	1 (1 to 2)	-7.56 (-30.37 to 5.80)	13.19 (3.02 to 22.95)	1.33 (-14.79 to 19.86)	-1.24 (-7.99 to 3.21)	-7.56 (-30.37 to 5.80)	13.19 (3.02 to 22.95)	1.33 (-14.79 to 19.86)	-1.24 (-7.99 to 3.21)	
Poland	359 (166 to 555)	189 (147 to 236)	110 (49 to 178)	37 (26 to 52)	469 (217 to 728)	226 (177 to 281)	-1.31 (-7.24 to 3.30)	20.93 (15.87 to 27.41)	-1.80 (-8.76 to 2.35)	1.00 (-1.25 to 3.10)	-1.31 (-7.24 to 3.30)	20.93 (15.87 to 27.41)	-1.80 (-8.76 to 2.35)	1.00 (-1.25 to 3.10)	
Romania	180 (97 to 277)	101 (69 to 139)	117 (63 to 185)	42 (29 to 62)	298 (162 to 453)	143 (99 to 194)	4.19 (-3.96 to 13.76)	21.05 (15.17 to 35.98)	-1.83 (-7.61 to 3.00)	-0.70 (-4.26 to 2.20)	4.19 (-3.96 to 13.76)	21.05 (15.17 to 35.98)	-1.83 (-7.61 to 3.00)	-0.70 (-4.26 to 2.20)	
Serbia	73 (31 to 132)	28 (14 to 52)	24 (10 to 45)	7 (3 to 17)	97 (41 to 177)	35 (17 to 67)	-11.33 (-20.97 to -0.67)	4.62 (1.63 to 7.84)	10.23 (2.52 to 19.43)	-3.11 (-8.73 to 2.27)	-11.33 (-20.97 to -0.67)	4.62 (1.63 to 7.84)	10.23 (2.52 to 19.43)	-3.11 (-8.73 to 2.27)	
Slovakia	12 (6 to 24)	4 (2 to 5)	5 (2 to 9)	1 (1 to 1)	17 (8 to 33)	5 (3 to 6)	6.92 (1.24 to 12.86)	17.06 (12.39 to 24.48)	3.51 (-1.36 to 8.87)	3.04 (-0.55 to 5.98)	6.92 (1.24 to 12.86)	17.06 (12.39 to 24.48)	3.51 (-1.36 to 8.87)	3.04 (-0.55 to 5.98)	
Slovenia	12 (2 to 30)	3 (1 to 6)	2 (0 to 5)	0 (0 to 1)	14 (2 to 35)	3 (1 to 6)	-6.64 (-13.05 to 10.19)	-1.26 (-7.91 to 8.38)	11.29 (-0.09 to 20.62)	1.76 (-4.88 to 6.93)	-6.64 (-13.05 to 10.19)	-1.26 (-7.91 to 8.38)	11.29 (-0.09 to 20.62)	1.76 (-4.88 to 6.93)	
Eastern Europe	41 070 (30 301 to 58 405)	22 838 (18 002 to 28 949)	11 207 (7772 to 15 653)	4823 (3063 to 7241)	52 277 (38 281 to 73 913)	27 662 (21 651 to 35 479)	25.17 (18.06 to 34.84)	13.07 (9.88 to 16.41)	-1.53 (-3.75 to 0.86)	8.51 (6.41 to 10.74)	25.17 (18.06 to 34.84)	13.07 (9.88 to 16.41)	-1.53 (-3.75 to 0.86)	8.51 (6.41 to 10.74)	
Belarus	573 (362 to 820)	379 (244 to 531)	127 (77 to 190)	35 (23 to 50)	699 (439 to 1013)	413 (277 to 571)	29.51 (16.04 to 51.15)	42.29 (28.40 to 98.54)	0.09 (-3.53 to 3.25)	9.91 (5.90 to 12.80)	29.51 (16.04 to 51.15)	42.29 (28.40 to 98.54)	0.09 (-3.53 to 3.25)	9.91 (5.90 to 12.80)	
Estonia	77 (44 to 111)	26 (21 to 36)	20 (12 to 29)	5 (3 to 7)	97 (55 to 139)	31 (24 to 42)	50.08 (34.32 to 73.58)	57.11 (44.12 to 89.50)	-2.04 (-7.16 to 0.54)	11.41 (7.09 to 16.50)	50.08 (34.32 to 73.58)	57.11 (44.12 to 89.50)	-2.04 (-7.16 to 0.54)	11.41 (7.09 to 16.50)	
Latvia	134 (75 to 226)	69 (47 to 98)	115 (69 to 189)	73 (53 to 100)	249 (148 to 408)	142 (108 to 189)	16.45 (10.92 to 22.03)	13.96 (8.23 to 19.03)	1.42 (-3.52 to 6.38)	9.21 (6.44 to 11.94)	16.45 (10.92 to 22.03)	13.96 (8.23 to 19.03)	1.42 (-3.52 to 6.38)	9.21 (6.44 to 11.94)	
Lithuania	48 (26 to 88)	38 (24 to 55)	85 (46 to 160)	77 (52 to 108)	133 (74 to 243)	116 (77 to 157)	3.04 (-0.95 to 7.72)	9.24 (6.12 to 13.00)	0.92 (-3.70 to 6.42)	2.14 (-0.56 to 4.26)	3.04 (-0.95 to 7.72)	9.24 (6.12 to 13.00)	0.92 (-3.70 to 6.42)	2.14 (-0.56 to 4.26)	
Moldova	444 (270 to 674)	233 (139 to 321)	104 (62 to 161)	31 (20 to 46)	548 (336 to 827)	264 (162 to 359)	13.94 (6.78 to 24.00)	12.03 (7.78 to 19.63)	4.17 (-0.57 to 8.83)	4.08 (0.20 to 7.96)	13.94 (6.78 to 24.00)	12.03 (7.78 to 19.63)	4.17 (-0.57 to 8.83)	4.08 (0.20 to 7.96)	

	Annualised rate of change (%)																			
	All ages incidence and deaths (2013)				Female population				Total				1990–2000				2000–13			
	Male population		Deaths		Incidence		Deaths		Incidence		Deaths		Incidence		Deaths		Incidence		Deaths	
Russia	30 851 (22 352 to 46 994)	14 423 (10 797 to 19 740)	6672 (4431 to 10 667)	1715 (903 to 3196)	37 523 (27 617 to 57 331)	16 138 (11 963 to 22 526)	25.22 (15.86 to 50.69)	9.60 (6.86 to 13.39)	0.70 (-1.22 to 3.57)	8.66 (5.96 to 11.53)	8943 (4013 to 14 168)	7670 (5455 to 10 529)	4084 (1803 to 6534)	2889 (1515 to 4597)	13 027 (5869 to 20 307)	10 558 (7415 to 14 758)	30.36 (16.36 to 72.39)	32.65 (11.72 to 119.99)	-6.10 (-12.25 to -2.28)	8.50 (5.63 to 11.93)
Western Europe	11 225 (8795 to 14 694)	4336 (3542 to 5326)	2896 (2225 to 3750)	1168 (948 to 1457)	14 122 (11 057 to 18 340)	5504 (4591 to 6583)	-9.15 (-14.34 to -5.01)	-6.75 (-8.06 to -5.34)	0.05 (-1.77 to 2.05)	-3.59 (-4.72 to -2.25)	18 (4 to 40)	5 (2 to 7)	4 (1 to 9)	1 (0 to 2)	22 (5 to 48)	6 (3 to 8)	3.38 (-24.91 to 15.91)	2.70 (-5.28 to 20.32)	0.56 (-7.50 to 13.32)	-1.09 (-6.77 to 4.30)
Austria	439 (111 to 1114)	58 (25 to 105)	108 (28 to 281)	15 (7 to 29)	547 (142 to 1378)	73 (32 to 129)	2.62 (-1.67 to 10.93)	-4.20 (-8.86 to 1.90)	7.82 (0.38 to 15.57)	5.51 (0.00 to 10.23)	155 (66 to 283)	41 (25 to 66)	64 (28 to 116)	18 (11 to 32)	219 (93 to 392)	59 (39 to 86)	-2.70 (-10.42 to 3.11)	3.37 (0.16 to 6.76)	-0.80 (-6.58 to 4.69)	-1.48 (-4.16 to 1.11)
Belgium	3 (1 to 6)	1 (0 to 1)	2 (1 to 3)	0 (0 to 1)	4 (2 to 9)	1 (1 to 2)	19.87 (-13.23 to 34.14)	26.48 (16.01 to 41.70)	-1.36 (-11.44 to 24.06)	3.17 (-0.67 to 8.77)	202 (87 to 433)	28 (15 to 44)	40 (17 to 87)	6 (3 to 9)	242 (105 to 518)	34 (19 to 52)	-5.46 (-10.62 to 0.51)	-11.24 (-15.04 to -7.09)	4.04 (-1.37 to 12.18)	-1.13 (-4.49 to 3.19)
Finland	20 (10 to 37)	6 (4 to 8)	5 (2 to 10)	2 (1 to 2)	25 (12 to 46)	7 (5 to 10)	-0.56 (-5.45 to 3.94)	0.82 (-1.64 to 3.99)	0.46 (-4.77 to 5.57)	-2.06 (-4.73 to -0.10)	1816 (840 to 3599)	839 (486 to 1335)	503 (223 to 999)	229 (139 to 366)	2319 (1076 to 4501)	1068 (658 to 1636)	-3.96 (-8.52 to 6.36)	-12.37 (-15.59 to -8.23)	-0.43 (-4.61 to 5.10)	-2.80 (-5.51 to 0.66)
France	1401 (827 to 2299)	435 (285 to 623)	306 (172 to 523)	99 (62 to 150)	1707 (1023 to 2796)	535 (354 to 752)	-2.80 (-5.95 to 2.02)	-10.02 (-12.93 to -6.57)	2.24 (0.02 to 5.13)	-3.15 (-4.75 to -1.14)	39 (22 to 54)	10 (7 to 15)	13 (7 to 18)	3 (2 to 5)	51 (30 to 71)	14 (9 to 20)	3.56 (0.73 to 9.42)	-11.52 (-15.44 to -6.10)	-1.99 (-6.00 to 0.18)	-2.49 (-5.44 to 0.06)
Greece	1 (0 to 1)	0 (0 to 0)	0 (0 to 0)	0 (0 to 0)	1 (0 to 2)	0 (0 to 0)	-0.85 (-6.56 to 4.83)	-1.07 (-4.21 to 2.38)	-0.31 (-6.77 to 7.62)	-3.09 (-6.63 to 0.48)										

	Annualised rate of change (%)																						
	All ages incidence and deaths (2013)						1990-2000						2000-13										
	Male population			Female population			Total			Incidence			Deaths										
Ireland	40 (18 to 73)	12 (8 to 18)	18 (8 to 32)	6 (4 to 9)	57 (26 to 105)	17 (12 to 25)	0.83 (-7.24 to 6.66)	4.51 (0.68 to 9.85)	-2.78 (-9.97 to 3.14)	4.51 (0.68 to 9.85)	-3.64 (-6.79 to -0.86)	52 (25 to 94)	13 (9 to 20)	58 (28 to 106)	14 (10 to 20)	-0.89 (-7.21 to 3.44)	6.06 (3.40 to 8.34)	-0.89 (-7.21 to 3.44)	6.06 (3.40 to 8.34)	-2.94 (-5.17 to -0.78)			
Italy	2328 (1269 to 3636)	775 (492 to 1290)	646 (346 to 1042)	242 (144 to 407)	2974 (1631 to 4601)	1017 (651 to 1549)	-16.06 (-27.75 to -4.02)	-8.82 (-12.23 to -5.51)	1.90 (-0.40 to 6.14)	-8.82 (-12.23 to -5.51)	-3.07 (-5.22 to -0.46)	Luxembourg	1 (1 to 2)	0 (0 to 1)	1 (1 to 2)	0 (0 to 1)	3.47 (-5.21 to 13.05)	27.76 (19.37 to 41.86)	-2.35 (-8.82 to 2.40)	27.76 (19.37 to 41.86)	-2.39 (-6.22 to 0.92)		
Malta	1 (0 to 2)	0 (0 to 1)	0 (0 to 1)	0 (0 to 0)	1 (1 to 3)	0 (0 to 1)	-17.62 (-23.63 to -11.72)	0.34 (-3.00 to 4.44)	4.19 (-2.47 to 12.25)	0.34 (-3.00 to 4.44)	-5.36 (-9.13 to -1.84)	Netherlands	236 (106 to 456)	73 (40 to 125)	51 (22 to 99)	17 (9 to 30)	287 (128 to 552)	91 (52 to 147)	-12.47 (-19.81 to -5.75)	-3.00 (-6.29 to -0.13)	0.76 (-5.61 to 6.65)	-4.36 (-7.46 to -1.54)	
Norway	26 (12 to 45)	8 (5 to 14)	23 (11 to 41)	7 (4 to 12)	49 (23 to 84)	15 (10 to 23)	-4.16 (-13.90 to 1.95)	1.34 (-1.81 to 6.43)	-1.95 (-8.14 to 2.80)	1.34 (-1.81 to 6.43)	-3.79 (-7.12 to -1.07)	Portugal	1978 (906 to 3669)	679 (436 to 944)	394 (184 to 752)	146 (85 to 234)	2371 (1102 to 4392)	825 (574 to 1109)	-0.31 (-7.39 to 5.92)	12.07 (6.83 to 18.41)	-1.18 (-7.84 to 4.58)	12.07 (6.83 to 18.41)	-3.32 (-5.86 to -0.67)
Spain	1811 (1180 to 2780)	1075 (627 to 1618)	408 (254 to 639)	252 (140 to 416)	2219 (1454 to 3387)	1327 (792 to 1976)	-15.24 (-19.37 to -10.81)	-5.11 (-7.45 to -2.22)	-1.34 (-4.32 to 0.83)	-5.11 (-7.45 to -2.22)	-6.66 (-9.66 to -4.50)	Sweden	46 (20 to 82)	15 (9 to 24)	15 (6 to 26)	5 (3 to 9)	61 (26 to 108)	20 (13 to 30)	-9.91 (-18.59 to -2.93)	-1.05 (-3.98 to 1.43)	-2.54 (-8.88 to 1.44)	-1.05 (-3.98 to 1.43)	-5.28 (-8.03 to -2.79)
Switzerland	251 (85 to 539)	79 (43 to 131)	111 (39 to 241)	36 (20 to 59)	362 (124 to 782)	115 (69 to 175)	-19.00 (-24.99 to -8.36)	-6.25 (-9.63 to -2.61)	6.82 (0.92 to 12.82)	-6.25 (-9.63 to -2.61)	-3.43 (-6.63 to -0.05)	UK	349 (24 to 964)	178 (119 to 255)	125 (9 to 342)	68 (43 to 104)	474 (33 to 1316)	246 (168 to 333)	0.83 (-5.08 to 7.15)	-4.45 (-7.40 to -1.00)	-8.49 (-27.01 to -0.11)	-4.45 (-7.40 to -1.00)	-1.57 (-4.46 to 0.53)
Andean Latin America	3316 (1938 to 7058)	1588 (987 to 3617)	1225 (683 to 2571)	465 (240 to 1304)	4541 (2649 to 9597)	2053 (1258 to 4917)	1.91 (-16.44 to 14.95)	19.73 (11.89 to 28.79)	-1.09 (-6.07 to 4.63)	19.73 (11.89 to 28.79)	-3.52 (-6.58 to 0.62)												

	Annualised rate of change (%)															
	All ages incidence and deaths (2013)				Total				1990-2000				2000-13			
	Male population		Female population		Incidence		Deaths		Incidence		Deaths		Incidence		Deaths	
Bolivia	396 (13 to 1969)	446 (46 to 2345)	181 (5 to 845)	171 (12 to 1043)	577 (18 to 2770)	617 (59 to 3398)	21.87 (-12.59 to 47.06)	46.78 (11.24 to 77.78)	21.87 (-12.59 to 47.06)	46.78 (11.24 to 77.78)	21.87 (-12.59 to 47.06)	46.78 (11.24 to 77.78)	-11.15 (-29.50 to 2.73)	-1.91 (-11.59 to 8.44)		
Ecuador	1711 (997 to 3749)	687 (495 to 1081)	607 (350 to 1341)	193 (114 to 330)	2318 (1378 to 5097)	880 (645 to 1409)	8.55 (-4.91 to 19.31)	18.12 (11.55 to 27.83)	8.55 (-4.91 to 19.31)	18.12 (11.55 to 27.83)	8.55 (-4.91 to 19.31)	18.12 (11.55 to 27.83)	0.17 (-3.88 to 7.10)	1.89 (-1.82 to 8.67)		
Peru	1209 (503 to 3735)	455 (287 to 790)	437 (182 to 1330)	101 (64 to 178)	1646 (695 to 5100)	556 (357 to 960)	-4.68 (-29.03 to 15.07)	18.81 (9.18 to 30.45)	-4.68 (-29.03 to 15.07)	18.81 (9.18 to 30.45)	-4.68 (-29.03 to 15.07)	18.81 (9.18 to 30.45)	0.23 (-4.84 to 10.22)	-8.83 (-12.74 to -3.34)		
Central Latin America	17 775 (14 156 to 21 628)	7555 (6042 to 9924)	5706 (4418 to 7440)	1965 (1207 to 4529)	23 480 (18 630 to 28 703)	9521 (7325 to 14 456)	-2.00 (-8.23 to 1.40)	13.13 (10.27 to 16.05)	-2.00 (-8.23 to 1.40)	13.13 (10.27 to 16.05)	-2.00 (-8.23 to 1.40)	13.13 (10.27 to 16.05)	-0.64 (-1.81 to 0.37)	-5.46 (-7.10 to -3.86)		
Colombia	4464 (2799 to 6030)	1712 (1294 to 2358)	1188 (754 to 1645)	321 (219 to 482)	5651 (3627 to 7520)	2033 (1553 to 2791)	7.92 (-4.88 to 15.09)	29.60 (23.63 to 34.51)	7.92 (-4.88 to 15.09)	29.60 (23.63 to 34.51)	7.92 (-4.88 to 15.09)	29.60 (23.63 to 34.51)	-0.44 (-2.72 to 2.70)	-2.88 (-5.92 to 0.76)		
Costa Rica	291 (206 to 395)	110 (81 to 143)	74 (51 to 103)	20 (14 to 27)	366 (261 to 497)	130 (95 to 167)	0.21 (-4.92 to 4.30)	7.98 (5.90 to 10.21)	0.21 (-4.92 to 4.30)	7.98 (5.90 to 10.21)	0.21 (-4.92 to 4.30)	7.98 (5.90 to 10.21)	0.59 (-2.11 to 3.52)	-4.58 (-7.00 to -2.56)		
El Salvador	536 (258 to 852)	184 (124 to 275)	249 (117 to 418)	59 (39 to 87)	785 (382 to 1262)	243 (166 to 358)	1.30 (-5.70 to 8.69)	17.00 (10.64 to 22.67)	1.30 (-5.70 to 8.69)	17.00 (10.64 to 22.67)	1.30 (-5.70 to 8.69)	17.00 (10.64 to 22.67)	-2.27 (-7.03 to 0.09)	-6.24 (-9.58 to -2.90)		
Guatemala	1163 (545 to 1944)	465 (271 to 733)	679 (308 to 1139)	185 (108 to 308)	1841 (858 to 3044)	650 (384 to 1011)	19.84 (10.31 to 32.38)	32.69 (26.07 to 41.94)	19.84 (10.31 to 32.38)	32.69 (26.07 to 41.94)	19.84 (10.31 to 32.38)	32.69 (26.07 to 41.94)	-4.85 (-13.12 to -0.29)	-0.24 (-5.99 to 5.65)		
Honduras	381 (54 to 1630)	537 (49 to 2613)	508 (75 to 2243)	586 (38 to 3056)	889 (131 to 3925)	1123 (91 to 5692)	-11.00 (-26.53 to 0.94)	14.55 (4.46 to 23.16)	-11.00 (-26.53 to 0.94)	14.55 (4.46 to 23.16)	-11.00 (-26.53 to 0.94)	14.55 (4.46 to 23.16)	-6.65 (-14.25 to 3.99)	-11.51 (-16.65 to -5.96)		
Mexico	7066 (4827 to 9603)	3076 (2343 to 4368)	1797 (1214 to 2539)	514 (339 to 800)	8863 (6156 to 12 054)	3590 (2763 to 5024)	-6.14 (-11.86 to -2.01)	9.58 (6.71 to 12.81)	-6.14 (-11.86 to -2.01)	9.58 (6.71 to 12.81)	-6.14 (-11.86 to -2.01)	9.58 (6.71 to 12.81)	-0.20 (-1.20 to 0.41)	-6.62 (-8.53 to -4.22)		
Nicaragua	978 (522 to 1739)	199 (130 to 284)	407 (215 to 741)	53 (29 to 94)	1386 (736 to 2471)	252 (165 to 364)	19.78 (6.54 to 35.63)	14.90 (3.90 to 38.22)	19.78 (6.54 to 35.63)	14.90 (3.90 to 38.22)	19.78 (6.54 to 35.63)	14.90 (3.90 to 38.22)	10.61 (2.14 to 17.90)	11.62 (6.35 to 16.80)		
Panama	500 (295 to 763)	282 (193 to 410)	167 (95 to 263)	58 (35 to 107)	666 (392 to 1011)	340 (233 to 505)	-8.12 (-15.64 to -2.07)	12.99 (9.44 to 16.66)	-8.12 (-15.64 to -2.07)	12.99 (9.44 to 16.66)	-8.12 (-15.64 to -2.07)	12.99 (9.44 to 16.66)	-0.88 (-4.14 to 0.97)	-6.63 (-10.00 to -2.21)		
Venezuela	2396 (1506 to 3591)	992 (770 to 1470)	637 (386 to 968)	168 (111 to 248)	3033 (1912 to 4504)	1160 (900 to 1687)	1.77 (-9.28 to 12.66)	17.73 (9.64 to 32.27)	1.77 (-9.28 to 12.66)	17.73 (9.64 to 32.27)	1.77 (-9.28 to 12.66)	17.73 (9.64 to 32.27)	-0.32 (-3.01 to 3.08)	-5.43 (-8.14 to -1.48)		

	Annualised rate of change (%)															
	All ages incidence and deaths (2013)				Total				1990–2000				2000–13			
	Male population		Female population		Incidence		Deaths		Incidence		Deaths		Incidence		Deaths	
Southern Latin America	4938 (3436 to 7580)	1722 (1230 to 2253)	1593 (1084 to 2210)	291 (171 to 490)	6531 (4590 to 9658)	2013 (1437 to 2650)	1000 (617 to 1376)	–0.24 (–3.40 to 3.08)	–0.75 (–4.84 to 3.85)	10.00 (6.17 to 13.76)	–0.24 (–3.40 to 3.08)	–5.37 to –0.65	–0.99 (–4.42 to 1.51)	–0.24 (–3.40 to 3.08)	–2.76 (–5.37 to –0.65)	
Argentina	3459 (2343 to 4525)	1396 (937 to 1932)	1310 (859 to 1785)	231 (113 to 420)	4769 (3211 to 6214)	1627 (1082 to 2247)	937 (529 to 1337)	–0.87 (–4.70 to 3.65)	–0.87 (–4.70 to 3.65)	9.37 (5.29 to 13.37)	–0.99 (–4.42 to 1.51)	–2.74 (–5.78 to –0.30)	–0.99 (–4.42 to 1.51)	–0.99 (–4.42 to 1.51)	–2.74 (–5.78 to –0.30)	
Chile	1162 (399 to 3636)	219 (132 to 386)	184 (60 to 558)	34 (20 to 57)	1346 (461 to 4214)	253 (154 to 441)	16.21 (5.51 to 26.62)	–0.85 (–13.55 to 11.49)	–0.85 (–13.55 to 11.49)	16.21 (5.51 to 26.62)	2.44 (–5.07 to 14.88)	–5.29 (–9.44 to –0.24)	2.44 (–5.07 to 14.88)	2.44 (–5.07 to 14.88)	–5.29 (–9.44 to –0.24)	
Uruguay	317 (197 to 457)	107 (58 to 227)	98 (60 to 149)	26 (16 to 48)	415 (257 to 600)	133 (77 to 275)	14.36 (–0.41 to 26.97)	6.73 (–12.63 to 23.80)	6.73 (–12.63 to 23.80)	14.36 (–0.41 to 26.97)	0.36 (–4.96 to 5.94)	4.14 (0.28 to 9.24)	0.36 (–4.96 to 5.94)	0.36 (–4.96 to 5.94)	4.14 (0.28 to 9.24)	
Tropical Latin America	17 874 (13 687 to 24 490)	8091 (6273 to 10 287)	7958 (5860 to 11 125)	2353 (1676 to 3175)	25 832 (19 842 to 35 094)	10 444 (8400 to 13 074)	1.09 (–2.41 to 6.19)	–7.15 (–10.27 to –3.64)	–7.15 (–10.27 to –3.64)	1.09 (–2.41 to 6.19)	0.37 (–1.16 to 2.50)	–2.20 (–4.57 to 0.01)	0.37 (–1.16 to 2.50)	0.37 (–1.16 to 2.50)	–2.20 (–4.57 to 0.01)	
Brazil	17 156 (13 016 to 23 725)	7912 (6086 to 10 130)	7661 (5536 to 10 846)	2305 (1628 to 3122)	24 817 (18 802 to 34 189)	10 217 (8168 to 12 829)	0.99 (–2.54 to 6.14)	–7.34 (–10.43 to –3.78)	–7.34 (–10.43 to –3.78)	0.99 (–2.54 to 6.14)	0.28 (–1.27 to 2.43)	–2.26 (–4.65 to 0.02)	0.28 (–1.27 to 2.43)	0.28 (–1.27 to 2.43)	–2.26 (–4.65 to 0.02)	
Paraguay	718 (376 to 1377)	179 (132 to 254)	297 (148 to 573)	47 (30 to 78)	1015 (533 to 1909)	227 (169 to 326)	16.01 (10.41 to 26.36)	9.89 (–2.03 to 20.95)	9.89 (–2.03 to 20.95)	16.01 (10.41 to 26.36)	2.29 (–3.20 to 8.98)	0.94 (–2.22 to 4.82)	2.29 (–3.20 to 8.98)	2.29 (–3.20 to 8.98)	0.94 (–2.22 to 4.82)	
North Africa and Middle East	11 022 (7339 to 19 715)	5905 (4360 to 8749)	4482 (3048 to 7671)	2181 (1582 to 3191)	15 503 (10 523 to 27 132)	8087 (6008 to 11 698)	20.66 (9.81 to 35.43)	11.52 (0.35 to 25.42)	11.52 (0.35 to 25.42)	20.66 (9.81 to 35.43)	–0.35 (–4.01 to 5.02)	3.05 (–0.99 to 7.85)	–0.35 (–4.01 to 5.02)	–0.35 (–4.01 to 5.02)	3.05 (–0.99 to 7.85)	
Algeria	370 (144 to 953)	68 (45 to 110)	334 (126 to 815)	50 (29 to 95)	704 (278 to 1737)	118 (78 to 197)	31.05 (19.30 to 58.72)	22.04 (1.42 to 55.08)	22.04 (1.42 to 55.08)	31.05 (19.30 to 58.72)	3.63 (–4.30 to 14.24)	2.06 (–4.20 to 10.92)	3.63 (–4.30 to 14.24)	3.63 (–4.30 to 14.24)	2.06 (–4.20 to 10.92)	
Bahrain	25 (15 to 47)	11 (8 to 15)	10 (5 to 19)	4 (3 to 5)	35 (20 to 66)	15 (11 to 19)	19.32 (9.48 to 41.05)	4.50 (–10.68 to 20.37)	4.50 (–10.68 to 20.37)	19.32 (9.48 to 41.05)	2.66 (–1.34 to 7.95)	1.52 (–1.64 to 8.28)	2.66 (–1.34 to 7.95)	2.66 (–1.34 to 7.95)	1.52 (–1.64 to 8.28)	
Egypt	208 (121 to 315)	54 (36 to 76)	175 (100 to 264)	55 (40 to 72)	383 (224 to 568)	109 (81 to 143)	20.36 (16.78 to 24.35)	8.02 (3.18 to 13.53)	8.02 (3.18 to 13.53)	20.36 (16.78 to 24.35)	5.61 (0.35 to 10.52)	4.30 (1.75 to 6.54)	5.61 (0.35 to 10.52)	5.61 (0.35 to 10.52)	4.30 (1.75 to 6.54)	
Iran	1246 (572 to 2287)	308 (191 to 441)	152 (66 to 282)	17 (9 to 28)	1398 (641 to 2550)	325 (201 to 464)	42.61 (11.52 to 101.76)	32.59 (7.25 to 56.24)	32.59 (7.25 to 56.24)	42.61 (11.52 to 101.76)	5.64 (–0.97 to 13.56)	12.98 (5.92 to 19.99)	5.64 (–0.97 to 13.56)	5.64 (–0.97 to 13.56)	12.98 (5.92 to 19.99)	
Iraq	318 (143 to 685)	139 (101 to 181)	185 (83 to 417)	72 (52 to 98)	503 (227 to 1092)	211 (159 to 273)	21.16 (12.84 to 44.26)	5.61 (–7.68 to 23.46)	5.61 (–7.68 to 23.46)	21.16 (12.84 to 44.26)	2.85 (–2.60 to 9.54)	2.38 (–1.00 to 5.44)	2.85 (–2.60 to 9.54)	2.85 (–2.60 to 9.54)	2.38 (–1.00 to 5.44)	

	Annualised rate of change (%)																			
	All ages incidence and deaths (2013)				Female population				Total				1990–2000				2000–13			
	Male population		Deaths		Incidence		Deaths		Incidence		Deaths		Incidence		Deaths		Incidence		Deaths	
Jordan	8 (4 to 17)	5 (3 to 6)	10 (5 to 21)	5 (4 to 6)	19 (10 to 37)	9 (7 to 11)	10.32 (-4.09 to 38.26)	27.10 (18.13 to 53.81)	1.09 (-3.61 to 7.21)	1.60 (-1.86 to 5.63)										
Kuwait	55 (32 to 101)	24 (18 to 35)	25 (13 to 48)	9 (7 to 13)	80 (45 to 149)	33 (25 to 46)	4.81 (-10.41 to 20.69)	19.61 (9.84 to 41.52)	2.49 (-1.51 to 7.82)	1.53 (-1.69 to 10.13)										
Lebanon	241 (7 to 1200)	89 (8 to 471)	93 (3 to 435)	26 (2 to 173)	334 (10 to 1662)	116 (10 to 645)	20.24 (-5.86 to 65.16)	4.87 (-5.96 to 19.21)	5.79 (-14.18 to 19.40)	6.76 (-4.92 to 17.15)										
Libya	15 (7 to 32)	7 (5 to 8)	12 (6 to 24)	5 (4 to 6)	27 (13 to 55)	11 (9 to 14)	10.67 (-2.77 to 39.02)	23.15 (14.81 to 48.67)	3.01 (-1.88 to 8.66)	4.20 (1.56 to 7.24)										
Morocco	343 (213 to 548)	108 (72 to 161)	294 (187 to 452)	61 (42 to 96)	637 (403 to 980)	169 (117 to 255)	21.12 (11.44 to 27.17)	29.89 (26.98 to 33.37)	0.53 (-2.02 to 4.36)	4.19 (0.82 to 8.25)										
Oman	180 (92 to 388)	31 (23 to 43)	43 (21 to 91)	7 (4 to 12)	223 (114 to 480)	38 (28 to 53)	28.03 (9.34 to 65.46)	34.56 (22.53 to 65.06)	1.78 (-4.83 to 11.39)	4.86 (0.85 to 13.07)										
Palestine	20 (10 to 42)	6 (5 to 7)	11 (5 to 22)	3 (2 to 4)	31 (15 to 64)	9 (8 to 11)	17.60 (3.68 to 45.75)	22.60 (11.17 to 47.43)	5.85 (0.32 to 12.81)	10.89 (8.35 to 13.98)										
Qatar	8 (3 to 20)	4 (2 to 5)	1 (0 to 3)	0 (0 to 1)	10 (3 to 23)	4 (2 to 6)	-2.05 (-14.81 to 18.73)	10.34 (-0.04 to 37.07)	3.15 (-2.65 to 11.69)	-1.70 (-5.16 to 2.00)										
Saudi Arabia	354 (168 to 771)	197 (140 to 318)	206 (100 to 436)	87 (62 to 118)	559 (272 to 1200)	283 (206 to 415)	2.20 (-14.17 to 18.84)	19.30 (8.77 to 44.67)	2.77 (-1.56 to 9.53)	1.49 (-2.03 to 7.73)										
Sudan	4999 (2880 to 9359)	4154 (2976 to 5843)	1934 (1141 to 3575)	1533 (1040 to 2244)	6933 (4020 to 12757)	5687 (4109 to 8024)	11.50 (-2.67 to 34.18)	22.51 (8.28 to 53.14)	-4.10 (-9.07 to 2.83)	2.62 (-2.11 to 9.16)										
Syria	0 (0 to 1)	0 (0 to 0)	1 (0 to 1)	0 (0 to 0)	1 (0 to 3)	0 (0 to 1)	25.96 (9.85 to 59.84)	34.00 (20.32 to 67.81)	1.74 (-4.46 to 8.97)	7.05 (2.48 to 13.48)										
Tunisia	227 (31 to 1041)	53 (4 to 284)	94 (13 to 435)	19 (1 to 110)	322 (44 to 1443)	72 (6 to 388)	12.85 (-14.69 to 44.00)	22.94 (-2.16 to 61.79)	11.96 (0.97 to 22.98)	2.76 (-6.40 to 12.29)										
Turkey	408 (233 to 698)	107 (85 to 142)	195 (110 to 331)	42 (31 to 59)	602 (351 to 1029)	149 (120 to 198)	25.03 (20.34 to 29.29)	28.45 (22.14 to 48.56)	1.99 (-1.56 to 7.16)	9.82 (6.51 to 15.83)										
United Arab Emirates	304 (175 to 560)	101 (76 to 128)	77 (42 to 150)	27 (19 to 36)	382 (217 to 704)	128 (97 to 161)	4.68 (-10.37 to 20.37)	19.26 (9.51 to 40.77)	2.45 (-1.53 to 7.73)	1.37 (-1.78 to 8.62)										

	Annualised rate of change (%)															
	All ages incidence and deaths (2013)				Total				1990–2000				2000–13			
	Male population		Female population		Incidence		Deaths		Incidence		Deaths		Incidence		Deaths	
Yemen	1677 (215 to 7497)	433 (45 to 2027)	625 (77 to 2998)	156 (10 to 807)	2302 (289 to 10 511)	589 (56 to 2857)	817 (-12.05 to 27.46)	17.84 (-1.57 to 44.45)	8.17 (-12.05 to 27.46)	17.84 (-1.57 to 44.45)	10.06 (1.53 to 21.58)	7.14 (-1.35 to 16.57)				
High-income North America	20 227 (9394 to 47 347)	7959 (4591 to 11 627)	6193 (2730 to 14 401)	2560 (1398 to 4064)	26 420 (12 244 to 61 760)	10 518 (6635 to 14 804)	-8.87 (-13.56 to -3.10)	-10.20 (-13.49 to -7.99)	-8.87 (-13.56 to -3.10)	-10.20 (-13.49 to -7.99)	2.01 (-3.23 to 9.49)	-2.89 (-5.95 to -0.10)				
Canada	720 (253 to 1205)	263 (173 to 392)	134 (47 to 242)	57 (33 to 95)	854 (297 to 1445)	319 (215 to 458)	-9.30 (-17.42 to -3.34)	-10.55 (-12.93 to -8.22)	-9.30 (-17.42 to -3.34)	-10.55 (-12.93 to -8.22)	-0.75 (-9.26 to 3.88)	-4.81 (-8.13 to -1.82)				
USA	19 503 (8675 to 46 702)	7694 (4306 to 11 351)	6058 (2608 to 14 298)	2503 (1333 to 4016)	25 561 (11 370 to 60 381)	10 197 (6265 to 14 519)	-8.86 (-13.93 to -2.53)	-10.19 (-13.64 to -7.88)	-8.86 (-13.93 to -2.53)	-10.19 (-13.64 to -7.88)	2.13 (-3.39 to 9.82)	-2.80 (-5.96 to 0.06)				
Oceania	1137 (774 to 1591)	1461 (1043 to 2000)	515 (359 to 721)	255 (160 to 372)	1652 (1148 to 2288)	1716 (1249 to 2335)	15.64 (5.25 to 27.08)	31.68 (27.45 to 36.49)	15.64 (5.25 to 27.08)	31.68 (27.45 to 36.49)	-9.47 (-11.74 to -7.34)	1.21 (-3.80 to 6.92)				
Federated States of Micronesia	2 (1 to 4)	1 (0 to 1)	3 (1 to 5)	1 (0 to 1)	5 (2 to 9)	1 (1 to 2)	1.63 (-6.48 to 6.93)	17.73 (13.87 to 23.24)	1.63 (-6.48 to 6.93)	17.73 (13.87 to 23.24)	5.41 (-2.00 to 11.14)	-2.70 (-7.89 to 1.15)				
Fiji	19 (7 to 34)	7 (4 to 11)	26 (10 to 46)	7 (3 to 12)	45 (17 to 78)	14 (7 to 22)	1.63 (-6.46 to 6.94)	17.76 (13.92 to 23.26)	1.63 (-6.46 to 6.94)	17.76 (13.92 to 23.26)	5.45 (-1.98 to 11.19)	-2.68 (-7.88 to 1.17)				
Kiribati	1 (0 to 2)	0 (0 to 0)	0 (0 to 1)	0 (0 to 0)	1 (0 to 2)	0 (0 to 0)	-7.11 (-14.42 to 6.66)	-4.00 (-7.74 to 1.02)	-7.11 (-14.42 to 6.66)	-4.00 (-7.74 to 1.02)	10.13 (-0.37 to 19.60)	-1.82 (-6.60 to 4.26)				
Marshall Islands	1 (0 to 2)	1 (0 to 1)	1 (0 to 2)	1 (0 to 1)	1 (0 to 4)	1 (1 to 1)	5.87 (-6.26 to 14.52)	25.45 (13.97 to 32.22)	5.87 (-6.26 to 14.52)	25.45 (13.97 to 32.22)	-5.17 (-17.67 to 5.47)	0.67 (-2.56 to 2.76)				
Papua New Guinea	992 (671 to 1404)	1279 (907 to 1761)	419 (280 to 596)	213 (127 to 316)	1411 (973 to 1972)	1493 (1071 to 2046)	15.78 (5.11 to 27.92)	32.78 (27.56 to 38.72)	15.78 (5.11 to 27.92)	32.78 (27.56 to 38.72)	-10.09 (-12.45 to -7.90)	1.09 (-4.12 to 7.19)				
Samoa	2 (0 to 6)	1 (1 to 2)	2 (0 to 8)	1 (1 to 2)	4 (1 to 14)	2 (2 to 3)	2.62 (-17.47 to 13.91)	24.01 (14.89 to 32.03)	2.62 (-17.47 to 13.91)	24.01 (14.89 to 32.03)	-2.37 (-17.51 to 10.40)	-0.76 (-4.60 to 2.35)				
Solomon Islands	5 (1 to 15)	4 (3 to 5)	7 (1 to 22)	5 (3 to 6)	13 (2 to 37)	8 (6 to 11)	6.58 (-4.75 to 15.92)	27.79 (17.67 to 35.23)	6.58 (-4.75 to 15.92)	27.79 (17.67 to 35.23)	-4.58 (-17.19 to 7.03)	-1.12 (-4.26 to 1.73)				
Tonga	1 (0 to 2)	1 (1 to 1)	1 (0 to 3)	1 (1 to 1)	2 (0 to 5)	2 (1 to 2)	6.23 (-2.77 to 14.77)	26.75 (15.90 to 33.45)	6.23 (-2.77 to 14.77)	26.75 (15.90 to 33.45)	-5.28 (-17.56 to 5.29)	0.09 (-2.85 to 2.26)				

	Annualised rate of change (%)														
	All ages incidence and deaths (2013)			Female population			Total			1990–2000			2000–13		
	Incidence	Deaths	Incidence	Deaths	Incidence	Deaths	Incidence	Deaths	Incidence	Deaths	Incidence	Deaths	Incidence	Deaths	
Vanuatu	5 (2 to 10)	2 (1 to 3)	7 (3 to 13)	2 (1 to 3)	13 (5 to 22)	4 (2 to 6)	17.68 (13.81 to 23.22)	5.45 (-1.97 to 11.18)	5.71 (3.57 to 8.17)	1.60 (-6.49 to 6.93)	5.45 (-1.97 to 11.18)	17.68 (13.81 to 23.22)	5.45 (-1.97 to 11.18)	-2.68 (-7.86 to 1.16)	
Central sub-Saharan Africa	40 520 (33 684 to 48 736)	34 484 (29 112 to 40 928)	46 721 (38 841 to 56 310)	33 317 (26 990 to 41 399)	87 241 (73 529 to 104 384)	67 801 (57 201 to 81 462)	87.241 (73.529 to 104.384)	-0.25 (-1.66 to 0.93)	5.71 (3.57 to 8.17)	-0.25 (-1.66 to 0.93)	5.71 (3.57 to 8.17)	17.68 (13.81 to 23.22)	-3.89 (-5.15 to -2.60)	-2.42 (-3.47 to -1.14)	
Angola	15 931 (11 412 to 21 253)	7668 (5298 to 10 586)	18 844 (14 120 to 24 425)	8531 (6012 to 11 969)	34 775 (25 849 to 45 207)	16 199 (11 785 to 22 209)	34 775 (25 849 to 45 207)	4.19 (0.33 to 7.97)	17.14 (13.88 to 21.02)	4.19 (0.33 to 7.97)	17.14 (13.88 to 21.02)	17.14 (13.88 to 21.02)	1.01 (-2.19 to 4.30)	2.30 (-0.13 to 4.95)	
Central African Republic	3030 (2107 to 4276)	3822 (3112 to 4827)	3830 (2639 to 5249)	4199 (3022 to 5765)	6860 (4771 to 9421)	8021 (6348 to 10 313)	6860 (4771 to 9421)	-5.56 (-8.92 to -2.29)	5.10 (0.91 to 9.99)	-5.56 (-8.92 to -2.29)	5.10 (0.91 to 9.99)	5.10 (0.91 to 9.99)	-5.85 (-7.56 to -4.06)	-5.43 (-7.70 to -2.89)	
Congo	2115 (1607 to 2798)	2814 (2208 to 3561)	2450 (1858 to 3280)	2314 (1656 to 3222)	4565 (3534 to 5925)	5127 (4074 to 6664)	4565 (3534 to 5925)	-5.70 (-8.48 to -3.46)	8.21 (5.13 to 11.42)	-5.70 (-8.48 to -3.46)	8.21 (5.13 to 11.42)	8.21 (5.13 to 11.42)	-7.19 (-9.26 to -4.54)	-6.18 (-7.41 to -4.45)	
DR Congo	17 438 (13 583 to 22 693)	17 392 (13 740 to 22 269)	20 175 (15 383 to 26 302)	17 223 (13 018 to 23 364)	37 613 (29 660 to 47 421)	34 615 (27 369 to 44 771)	37 613 (29 660 to 47 421)	0.02 (-2.40 to 1.29)	3.93 (2.46 to 6.28)	0.02 (-2.40 to 1.29)	3.93 (2.46 to 6.28)	3.93 (2.46 to 6.28)	-5.37 (-6.62 to -4.03)	-2.55 (-3.58 to -1.22)	
Equatorial Guinea	838 (453 to 1332)	555 (246 to 945)	905 (499 to 1414)	490 (209 to 744)	1743 (977 to 2789)	1046 (457 to 1689)	1743 (977 to 2789)	11.45 (8.33 to 14.54)	15.68 (10.22 to 34.39)	11.45 (8.33 to 14.54)	15.68 (10.22 to 34.39)	15.68 (10.22 to 34.39)	-1.78 (-5.32 to 2.40)	4.23 (0.35 to 8.07)	
Gabon	1169 (642 to 1872)	2233 (1778 to 2582)	517 (302 to 888)	560 (376 to 748)	1686 (986 to 2716)	2793 (2291 to 3203)	1686 (986 to 2716)	11.49 (8.03 to 14.5)	23.03 (19.71 to 26.02)	11.49 (8.03 to 14.5)	23.03 (19.71 to 26.02)	23.03 (19.71 to 26.02)	-12.91 (-17.46 to -7.35)	1.92 (-0.64 to 4.99)	
Eastern sub-Saharan Africa	259 900 (239 354 to 285 112)	210 586 (198 215 to 224 774)	322 401 (296 688 to 349 447)	205 015 (189 971 to 222 792)	582 301 (537 558 to 630 227)	415 601 (393 233 to 442 517)	582 301 (537 558 to 630 227)	-3.87 (-4.99 to -2.81)	14.50 (12.89 to 16.00)	-3.87 (-4.99 to -2.81)	14.50 (12.89 to 16.00)	14.50 (12.89 to 16.00)	-4.40 (-5.14 to -3.65)	-3.78 (-4.82 to -2.65)	
Burundi	2360 (1033 to 4252)	2997 (2222 to 4069)	3000 (1304 to 5465)	2515 (1648 to 3596)	5360 (2369 to 9678)	5513 (3966 to 7471)	5360 (2369 to 9678)	-16.72 (-26.18 to -9.75)	20.87 (17.06 to 24.49)	-16.72 (-26.18 to -9.75)	20.87 (17.06 to 24.49)	20.87 (17.06 to 24.49)	-2.27 (-9.44 to 6.08)	-9.50 (-12.11 to -4.71)	
Comoros	41 (5 to 183)	25 (4 to 117)	18 (2 to 88)	10 (1 to 48)	59 (8 to 276)	35 (4 to 168)	59 (8 to 276)	33.81 (12.67 to 50.96)	42.10 (23.55 to 57.50)	33.81 (12.67 to 50.96)	42.10 (23.55 to 57.50)	42.10 (23.55 to 57.50)	-1.72 (-12.18 to 10.65)	11.67 (2.98 to 20.10)	
Djibouti	129 (52 to 261)	373 (259 to 492)	152 (60 to 330)	407 (273 to 584)	281 (111 to 571)	780 (516 to 1027)	281 (111 to 571)	22.37 (12.52 to 28.20)	38.98 (33.20 to 47.80)	22.37 (12.52 to 28.20)	38.98 (33.20 to 47.80)	38.98 (33.20 to 47.80)	-18.66 (-25.15 to -12.54)	3.07 (-2.38 to 8.01)	
Eritrea	578 (266 to 964)	1174 (837 to 1687)	676 (302 to 1064)	1200 (861 to 1695)	1254 (569 to 1996)	2374 (1703 to 3356)	1254 (569 to 1996)	-6.64 (-17.29 to 9.76)	20.01 (13.04 to 33.39)	-6.64 (-17.29 to 9.76)	20.01 (13.04 to 33.39)	20.01 (13.04 to 33.39)	-11.86 (-17.58 to -6.58)	-7.36 (-11.05 to -0.91)	

	Annualised rate of change (%)													
	All ages incidence and deaths (2013)						1990–2000						2000–13	
	Male population			Female population			Total			Incidence			Deaths	
	Incidence	Deaths	Incidence	Deaths	Incidence	Deaths	Incidence	Deaths	Incidence	Deaths	Incidence	Deaths	Incidence	Deaths
Ethiopia	15 851 (12 139 to 20 542)	27 417 (22 072 to 33 072)	19 151 (14 9 to 24 731)	24 989 (18 874 to 33 145)	35 002 (27 389 to 44 699)	52 405 (43 394 to 64 763)	-0.16 (-3.45 to 2.72)	19.29 (14.50 to 23.62)	-13.56 (-15.59 to -10.99)	19.29 (14.50 to 23.62)	-13.56 (-15.59 to -10.99)	19.29 (14.50 to 23.62)	-7.16 (-9.66 to -3.28)	
Kenya	38 877 (33 698 to 43 684)	30 059 (25 355 to 34 355)	46 716 (41 140 to 52 977)	26 704 (21 777 to 31 960)	85 593 (78 186 to 93 863)	56 763 (49 968 to 63 388)	-6.21 (-8.43 to -3.27)	29.44 (26.50 to 32.03)	-2.80 (-4.62 to -1.14)	29.44 (26.50 to 32.03)	-2.80 (-4.62 to -1.14)	29.44 (26.50 to 32.03)	-4.48 (-7.33 to -1.48)	
Madagascar	1258 (169 to 5565)	1819 (313 to 8089)	1383 (187 to 5867)	1904 (335 to 8507)	2641 (356 to 11 358)	3722 (653 to 16 368)	-6.62 (-23.17 to 5.79)	27.96 (14.15 to 37.39)	-4.77 (-13.15 to 6.25)	27.96 (14.15 to 37.39)	-4.77 (-13.15 to 6.25)	27.96 (14.15 to 37.39)	-0.41 (-4.72 to 4.04)	
Malawi	25 256 (21 686 to 29 780)	21 829 (19 080 to 24 746)	33 126 (28 119 to 39 534)	20 006 (16 290 to 24 470)	58 382 (51 810 to 67 436)	41 835 (37 165 to 46 538)	-4.27 (-5.74 to -3.02)	12.80 (10.23 to 17.05)	-4.38 (-5.95 to -2.93)	12.80 (10.23 to 17.05)	-4.38 (-5.95 to -2.93)	12.80 (10.23 to 17.05)	-3.63 (-6.36 to -1.44)	
Mauritius	75 (51 to 99)	28 (22 to 37)	19 (12 to 26)	5 (3 to 6)	94 (63 to 124)	32 (26 to 42)	25.10 (18.27 to 31.79)	30.68 (20.31 to 39.63)	-0.82 (-4.50 to 0.37)	30.68 (20.31 to 39.63)	-0.82 (-4.50 to 0.37)	30.68 (20.31 to 39.63)	3.21 (0.35 to 6.23)	
Mozambique	64 009 (50 297 to 78 047)	35 558 (30 206 to 40 857)	73 592 (59 146 to 89 609)	39 419 (34 459 to 44 370)	137 600 (109 740 to 165 615)	74 978 (66 037 to 83 282)	18.97 (16.40 to 21.12)	35.66 (33.58 to 38.21)	-3.88 (-5.13 to -2.54)	35.66 (33.58 to 38.21)	-3.88 (-5.13 to -2.54)	35.66 (33.58 to 38.21)	8.71 (6.97 to 10.42)	
Rwanda	4307 (3471 to 5579)	4419 (3595 to 5205)	5902 (4708 to 7378)	3724 (2919 to 4754)	10 209 (8282 to 13 029)	8143 (6779 to 9513)	-10.69 (-15.45 to -7.39)	9.21 (5.96 to 13.75)	-4.28 (-6.93 to -0.18)	9.21 (5.96 to 13.75)	-4.28 (-6.93 to -0.18)	9.21 (5.96 to 13.75)	-8.40 (-10.82 to -5.09)	
Seychelles	3 (0 to 21)	2 (1 to 2)	2 (0 to 16)	1 (1 to 1)	5 (1 to 36)	3 (2 to 4)	-3.27 (-17.68 to 26.72)	30.37 (22.07 to 54.20)	-1.47 (-10.74 to 21.52)	30.37 (22.07 to 54.20)	-1.47 (-10.74 to 21.52)	30.37 (22.07 to 54.20)	-3.28 (-5.45 to -0.70)	
Somalia	1441 (784 to 2358)	1179 (782 to 1671)	1555 (823 to 2531)	1177 (688 to 1801)	2996 (1629 to 4855)	2356 (1492 to 3432)	9.81 (-8.51 to 34.47)	27.10 (6.39 to 56.79)	-3.01 (-8.99 to 3.03)	27.10 (6.39 to 56.79)	-3.01 (-8.99 to 3.03)	27.10 (6.39 to 56.79)	2.36 (-3.15 to 9.30)	
South Sudan	6555 (2895 to 9574)	5755 (3527 to 7575)	6137 (2979 to 8666)	4848 (3142 to 6518)	12 692 (5963 to 18 663)	10 603 (6648 to 14 068)	18.26 (-11.84 to 53.75)	38.10 (0.83 to 84.78)	-3.84 (-11.36 to 2.50)	38.10 (0.83 to 84.78)	-3.84 (-11.36 to 2.50)	38.10 (0.83 to 84.78)	6.90 (-0.73 to 19.03)	
Tanzania	30 308 (24 975 to 37 174)	35 376 (30 606 to 41 040)	39 352 (31 857 to 48 818)	33 666 (26 958 to 40 319)	69 660 (58 592 to 85 895)	69 041 (61 368 to 78 390)	-7.83 (-10.68 to -5.07)	15.73 (14.13 to 18.32)	-4.64 (-6.22 to -2.58)	15.73 (14.13 to 18.32)	-4.64 (-6.22 to -2.58)	15.73 (14.13 to 18.32)	-3.00 (-5.29 to -0.87)	
Uganda	48 542 (33 485 to 60 232)	26 727 (22 583 to 31 140)	62 057 (45 900 to 75 069)	26 212 (21 621 to 31 785)	110 599 (80 312 to 133 132)	52 939 (45 914 to 60 909)	-16.94 (-20.40 to -13.18)	12.54 (8.09 to 16.61)	3.81 (1.52 to 6.44)	12.54 (8.09 to 16.61)	3.81 (1.52 to 6.44)	12.54 (8.09 to 16.61)	-5.74 (-7.21 to -3.73)	
Zambia	20 161 (16 536 to 24 105)	15 695 (12 805 to 19 018)	29 368 (24 555 to 34 316)	18 086 (14 231 to 21 569)	49 529 (42 630 to 56 376)	33 781 (28 877 to 38 397)	-2.38 (-4.09 to -0.56)	6.08 (3.98 to 9.04)	-4.41 (-5.98 to -2.95)	6.08 (3.98 to 9.04)	-4.41 (-5.98 to -2.95)	6.08 (3.98 to 9.04)	-5.66 (-7.75 to -3.21)	

	Annualised rate of change (%)															
	All ages incidence and deaths (2013)				Female population				Total							
	Male population		Female population		Incidence		Deaths		Incidence		Deaths		Incidence		Deaths	
	Incidence	Deaths	Incidence	Deaths	Incidence	Deaths	Incidence	Deaths	Incidence	Deaths	Incidence	Deaths	Incidence	Deaths	Incidence	Deaths
Southern sub-Saharan Africa	222 423 (198 348 to 248 797)	160 280 (142 399 to 180 385)	280 376 (256 508 to 309 801)	160 992 (133 568 to 185 435)	502 799 (470 822 to 537 266)	321 272 (296 529 to 350 970)	10.60 (9.80 to 11.47)	31.17 (28.62 to 33.63)	502 799 (470 822 to 537 266)	321 272 (296 529 to 350 970)	10.60 (9.80 to 11.47)	31.17 (28.62 to 33.63)	-4.58 (-5.16 to -4.00)	3.41 (1.54 to 4.88)	-4.58 (-5.16 to -4.00)	3.41 (1.54 to 4.88)
Botswana	4457 (3568 to 5441)	2858 (2225 to 3707)	5232 (4268 to 6316)	2730 (2035 to 3583)	9689 (7945 to 11 571)	5588 (4576 to 6765)	3.95 (2.35 to 5.40)	33.85 (31.41 to 36.43)	9689 (7945 to 11 571)	5588 (4576 to 6765)	3.95 (2.35 to 5.40)	33.85 (31.41 to 36.43)	-8.02 (-9.67 to -6.19)	-6.19 (-9.00 to -2.81)	-8.02 (-9.67 to -6.19)	-6.19 (-9.00 to -2.81)
Lesotho	7068 (5955 to 8215)	4479 (3813 to 5359)	8259 (6785 to 9749)	4694 (3910 to 5581)	15 328 (12 983 to 17 837)	9173 (8060 to 10 485)	17.08 (14.96 to 18.84)	48.45 (45.79 to 51.23)	15 328 (12 983 to 17 837)	9173 (8060 to 10 485)	17.08 (14.96 to 18.84)	48.45 (45.79 to 51.23)	-4.27 (-5.72 to -2.82)	4.03 (1.60 to 5.76)	-4.27 (-5.72 to -2.82)	4.03 (1.60 to 5.76)
Namibia	3058 (2256 to 3881)	2393 (1709 to 3089)	3886 (2991 to 4776)	1744 (1354 to 2172)	6944 (5240 to 8424)	4137 (3356 to 5038)	15.63 (14.02 to 17.22)	35.74 (32.74 to 38.70)	6944 (5240 to 8424)	4137 (3356 to 5038)	15.63 (14.02 to 17.22)	35.74 (32.74 to 38.70)	-8.69 (-10.19 to -7.14)	-1.81 (-3.89 to 1.56)	-8.69 (-10.19 to -7.14)	-1.81 (-3.89 to 1.56)
South Africa	175 519 (151 842 to 200 204)	124 429 (107 696 to 143 955)	221 112 (198 114 to 249 156)	127 484 (101 377 to 150 172)	396 631 (369 966 to 432 109)	251 912 (229 223 to 280 072)	27.56 (26.72 to 28.72)	54.64 (51.50 to 57.39)	396 631 (369 966 to 432 109)	251 912 (229 223 to 280 072)	27.56 (26.72 to 28.72)	54.64 (51.50 to 57.39)	-4.68 (-5.32 to -4.06)	7.12 (4.50 to 9.04)	-4.68 (-5.32 to -4.06)	7.12 (4.50 to 9.04)
Swaziland	4882 (3845 to 5942)	2801 (2370 to 3265)	5671 (4582 to 6959)	2465 (2045 to 2957)	10 553 (8530 to 12 964)	5266 (4702 to 5938)	16.56 (14.67 to 18.68)	54.18 (50.68 to 58.14)	10 553 (8530 to 12 964)	5266 (4702 to 5938)	16.56 (14.67 to 18.68)	54.18 (50.68 to 58.14)	-3.55 (-5.40 to -1.84)	2.41 (-0.69 to 4.81)	-3.55 (-5.40 to -1.84)	2.41 (-0.69 to 4.81)
Zimbabwe	27 438 (23 254 to 31 845)	23 321 (19 787 to 27 956)	36 217 (30 580 to 41 205)	21 874 (17 670 to 25 549)	63 655 (55 522 to 71 292)	45 195 (40 323 to 51 392)	-10.26 (-12.34 to -8.24)	24.73 (22.23 to 27.49)	63 655 (55 522 to 71 292)	45 195 (40 323 to 51 392)	-10.26 (-12.34 to -8.24)	24.73 (22.23 to 27.49)	-2.57 (-4.44 to -0.79)	-3.38 (-6.12 to -1.03)	-2.57 (-4.44 to -0.79)	-3.38 (-6.12 to -1.03)
Western sub-Saharan Africa	139 760 (119 664 to 165 598)	147 892 (131 751 to 171 029)	167 215 (140 949 to 192 831)	152 976 (133 303 to 173 924)	306 975 (263 141 to 356 401)	300 868 (270 318 to 337 006)	5.79 (3.88 to 8.08)	18.75 (16.65 to 21.01)	306 975 (263 141 to 356 401)	300 868 (270 318 to 337 006)	5.79 (3.88 to 8.08)	18.75 (16.65 to 21.01)	-7.26 (-8.40 to -6.19)	0.82 (-0.38 to 2.01)	-7.26 (-8.40 to -6.19)	0.82 (-0.38 to 2.01)
Benin	2367 (1718 to 3196)	2050 (1541 to 2757)	2590 (1846 to 3458)	1960 (1356 to 2827)	4957 (3622 to 6595)	4010 (3091 to 5459)	6.90 (2.75 to 10.95)	26.96 (21.60 to 31.83)	4957 (3622 to 6595)	4010 (3091 to 5459)	6.90 (2.75 to 10.95)	26.96 (21.60 to 31.83)	-7.64 (-9.56 to -5.86)	-3.12 (-5.91 to 0.32)	-7.64 (-9.56 to -5.86)	-3.12 (-5.91 to 0.32)
Burkina Faso	2484 (1638 to 3488)	2444 (1808 to 3188)	3618 (2393 to 5149)	2683 (1828 to 3826)	6103 (4070 to 8571)	5127 (3737 to 6724)	-20.54 (-30.80 to -14.01)	9.51 (5.32 to 13.94)	6103 (4070 to 8571)	5127 (3737 to 6724)	-20.54 (-30.80 to -14.01)	9.51 (5.32 to 13.94)	-2.41 (-7.84 to 5.77)	-12.63 (-14.84 to -9.11)	-2.41 (-7.84 to 5.77)	-12.63 (-14.84 to -9.11)
Cameroon	18 364 (14 701 to 22 135)	15 653 (12 216 to 19 636)	22 103 (17 903 to 27 084)	15 669 (12 898 to 18 786)	40 467 (33 508 to 48 609)	31 322 (26 088 to 36 873)	11.89 (9.80 to 14.27)	34.05 (31.97 to 36.27)	40 467 (33 508 to 48 609)	31 322 (26 088 to 36 873)	11.89 (9.80 to 14.27)	34.05 (31.97 to 36.27)	-5.71 (-7.06 to -4.28)	2.42 (0.39 to 5.05)	-5.71 (-7.06 to -4.28)	2.42 (0.39 to 5.05)
Cape Verde	17 (6 to 40)	21 (11 to 35)	9 (3 to 22)	5 (4 to 8)	26 (9 to 63)	26 (15 to 42)	-9.59 (-23.30 to 1.20)	18.26 (11.73 to 26.57)	26 (9 to 63)	26 (15 to 42)	-9.59 (-23.30 to 1.20)	18.26 (11.73 to 26.57)	-11.77 (-18.77 to -1.81)	-13.57 (-20.21 to -6.18)	-11.77 (-18.77 to -1.81)	-13.57 (-20.21 to -6.18)
Chad	4580 (3216 to 6211)	4715 (3913 to 5774)	4904 (3431 to 6421)	4241 (3314 to 5247)	9484 (6804 to 12 391)	8956 (7597 to 10 794)	0.15 (-5.82 to 6.92)	14.54 (11.35 to 18.87)	9484 (6804 to 12 391)	8956 (7597 to 10 794)	0.15 (-5.82 to 6.92)	14.54 (11.35 to 18.87)	-6.62 (-10.35 to -3.55)	-1.05 (-3.90 to 1.46)	-6.62 (-10.35 to -3.55)	-1.05 (-3.90 to 1.46)

	Annualised rate of change (%)													
	All ages incidence and deaths (2013)						1990–2000						2000–13	
	Male population			Female population			Total			Incidence			Deaths	
	Incidence	Deaths	Incidence	Deaths	Incidence	Deaths	Incidence	Deaths	Incidence	Deaths	Incidence	Deaths	Incidence	Deaths
Cote d'Ivoire	11 756 (8303 to 15 969)	14 804 (11 522 to 18 328)	12 913 (9713 to 16 926)	11 511 (8942 to 14 260)	24 670 (18 594 to 32 159)	26 315 (21 554 to 31 624)	1.29 (-3.49 to 5.05)	17.76 (14.34 to 21.24)	-7.91 (-10.88 to -4.88)	-3.15 (-5.63 to -0.34)				
Ghana	4562 (2807 to 6873)	7302 (5449 to 9719)	6214 (3844 to 9119)	7413 (5136 to 10 470)	10 775 (6634 to 15 847)	14 715 (11 072 to 19 639)	2.08 (-2.57 to 6.45)	19.90 (15.13 to 25.45)	-10.73 (-14.08 to -7.89)	-4.28 (-6.87 to -0.80)				
Guinea	5288 (3327 to 7872)	3190 (2051 to 4909)	6118 (3853 to 8838)	3236 (2104 to 4951)	11 406 (7224 to 16 543)	6425 (4343 to 9729)	15.40 (10.07 to 19.71)	22.54 (18.87 to 27.50)	-2.32 (-5.40 to 0.42)	4.03 (1.06 to 7.06)				
Guinea-Bissau	1713 (1074 to 2533)	1200 (845 to 1597)	2052 (1253 to 3137)	1300 (914 to 1797)	3765 (2397 to 5676)	2500 (1713 to 3432)	21.73 (16.50 to 25.97)	32.16 (29.45 to 35.80)	-3.06 (-6.89 to -0.10)	8.85 (5.19 to 12.38)				
Liberia	315 (137 to 553)	1063 (842 to 1343)	366 (155 to 639)	1089 (843 to 1398)	681 (293 to 1186)	2152 (1746 to 2627)	10.04 (5.46 to 14.39)	34.21 (24.64 to 42.30)	-19.21 (-25.38 to -14.51)	-2.69 (-6.83 to 1.78)				
Mali	1976 (847 to 3299)	2616 (1762 to 3605)	2358 (963 to 4093)	2230 (1382 to 3417)	4334 (1866 to 7275)	4846 (3188 to 6966)	0.24 (-8.31 to 8.15)	22.52 (17.20 to 27.07)	-9.26 (-16.68 to -3.40)	-4.37 (-6.98 to -0.98)				
Mauritania	123 (11 to 595)	204 (21 to 1193)	144 (12 to 716)	249 (19 to 1486)	267 (23 to 1293)	453 (40 to 2640)	13.71 (-4.12 to 26.42)	22.05 (10.46 to 32.73)	-14.15 (-24.77 to -2.41)	-1.00 (-8.02 to 5.55)				
Niger	739 (279 to 1477)	2131 (1530 to 2889)	600 (233 to 1234)	1246 (787 to 1776)	1340 (516 to 2678)	3377 (2382 to 4617)	11.14 (4.39 to 16.80)	26.52 (19.89 to 36.62)	-18.89 (-27.70 to -11.84)	-1.62 (-6.29 to 3.50)				
Nigeria	80 309 (61 339 to 100 239)	83 530 (70 612 to 104 376)	97 025 (73 874 to 120 279)	92 271 (74 817 to 111 822)	177 334 (140 750 to 223 268)	175 801 (152 011 to 208 115)	8.76 (5.07 to 13.97)	20.63 (17.02 to 26.66)	-7.03 (-9.22 to -5.28)	4.09 (1.71 to 5.95)				
Sao Tome and Principe	33 (4 to 151)	42 (4 to 230)	19 (2 to 87)	18 (1 to 121)	52 (7 to 235)	59 (5 to 366)	34.76 (8.14 to 55.50)	44.76 (16.38 to 63.23)	-10.01 (-18.48 to 1.68)	7.12 (-0.99 to 15.06)				
Senegal	668 (169 to 1392)	1447 (953 to 2073)	934 (226 to 1967)	2406 (1483 to 3468)	1602 (400 to 3361)	3852 (2494 to 5417)	10.98 (8.36 to 13.64)	16.05 (12.65 to 19.20)	-15.04 (-24.99 to -8.92)	3.50 (1.37 to 5.39)				
Sierra Leone	2058 (759 to 4122)	2050 (1217 to 3303)	2243 (838 to 4491)	2018 (1199 to 3301)	4301 (1616 to 8689)	4069 (2504 to 6569)	20.95 (13.19 to 28.46)	24.42 (14.25 to 32.72)	-5.30 (-11.74 to -0.08)	9.12 (5.02 to 13.17)				
The Gambia	306 (170 to 458)	296 (196 to 411)	392 (223 to 590)	234 (144 to 350)	698 (399 to 1035)	529 (355 to 739)	21.09 (18.06 to 24.27)	21.36 (15.98 to 29.34)	-8.00 (-12.18 to -4.68)	3.62 (0.46 to 7.61)				

	All ages incidence and deaths (2013)						Annualised rate of change (%)					
	Male population			Female population			Total		1990–2000		2000–13	
	Incidence	Deaths		Incidence	Deaths		Incidence	Deaths	Incidence	Deaths	Incidence	Deaths
Togo	2100 (1380 to 2771)	3133 (2563 to 3808)		2611 (1766 to 3610)	3196 (2524 to 3915)		4710 (3259 to 6327)	6329 (5267 to 7440)	8.40 (6.28 to 10.25)	24.73 (19.89 to 31.75)	-11.53 (-14.44 to -9.09)	0.60 (-2.10 to 3.14)

Data in parentheses are 95% uncertainty intervals.

Table 4
Age-standardised tuberculosis without HIV incidence, prevalence, and mortality rates
and annualised rates of change for both sexes for 21 Global Burden of Disease regions

	Age-standardised rates in 2013 (per 100000 population)			Annualised rate of change (%)					
	Incidence	Prevalence	Mortality	1990–2000			2000–2013		
				Incidence	Prevalence	Mortality	Incidence	Prevalence	Mortality
Worldwide	98.65 (96.16 to 101.43)	159.00 (154.14 to 164.10)	19.24 (17.44 to 20.98)	0.03 (-0.17 to 0.25)	0.41 (0.23 to 0.58)	-3.29 (-4.07 to -2.58)	-0.60 (-0.73 to -0.50)	-1.31 (-1.41 to -1.20)	-3.72 (-4.42 to -2.99)
High-income Asia Pacific	34.36 (33.42 to 35.26)	62.80 (59.34 to 66.56)	2.14 (1.91 to 2.59)	-0.04 (-0.27 to 0.20)	-1.64 (-1.99 to -1.30)	-6.22 (-6.85 to -5.42)	0.11 (-0.06 to 0.27)	0.13 (-0.18 to 0.40)	-5.03 (-5.85 to -3.99)
Central Asia	122.11 (118.41 to 125.73)	179.30 (172.60 to 186.59)	11.08 (7.89 to 12.68)	1.03 (0.77 to 1.32)	1.03 (0.82 to 1.26)	5.50 (0.65 to 6.52)	-0.76 (-0.92 to -0.58)	-0.68 (-0.85 to -0.50)	-4.97 (-5.83 to -4.07)
East Asia	74.16 (71.90 to 76.54)	130.70 (125.21 to 136.66)	3.44 (3.00 to 3.99)	0.23 (-0.09 to 0.60)	0.68 (0.34 to 1.00)	-6.70 (-7.93 to -5.73)	-2.08 (-2.36 to -1.85)	-3.16 (-3.44 to -2.86)	-7.54 (-8.53 to -6.63)
South Asia	166.45 (160.83 to 172.18)	265.95 (256.77 to 275.37)	51.54 (43.79 to 59.81)	-0.77 (-1.10 to -0.41)	0.02 (-0.27 to 0.31)	-4.96 (-6.26 to -3.69)	-1.06 (-1.30 to -0.80)	-2.43 (-2.65 to -2.20)	-4.22 (-5.64 to -2.89)
Southeast Asia	145.16 (140.54 to 148.79)	300.95 (289.61 to 311.88)	41.83 (34.22 to 47.27)	1.59 (1.34 to 1.83)	1.42 (1.17 to 1.63)	-4.10 (-4.95 to -3.23)	-0.54 (-0.68 to -0.42)	0.12 (-0.03 to 0.28)	-3.61 (-4.42 to -2.82)
Australasia	6.38 (6.17 to 6.58)	11.11 (10.48 to 11.79)	0.24 (0.20 to 0.27)	-0.23 (-0.61 to 0.16)	-1.00 (-1.37 to -0.60)	-4.13 (-5.09 to -3.21)	-0.22 (-0.41 to -0.03)	-0.36 (-0.66 to -0.08)	-3.63 (-4.62 to -2.62)
Caribbean	55.36 (53.72 to 57.02)	70.84 (68.52 to 73.41)	7.19 (6.17 to 9.38)	1.89 (1.56 to 2.19)	0.87 (0.62 to 1.08)	-6.30 (-7.35 to -4.92)	-0.20 (-0.35 to -0.05)	-1.15 (-1.32 to -0.98)	-3.93 (-4.93 to -2.50)
Central Europe	26.72 (25.97 to 27.46)	41.97 (40.52 to 43.45)	1.69 (1.57 to 1.97)	1.58 (1.40 to 1.75)	0.40 (0.26 to 0.56)	-2.77 (-3.18 to -1.98)	-1.61 (-1.74 to -1.50)	-0.29 (-0.42 to -0.17)	-5.95 (-6.43 to -5.27)
Eastern Europe	79.27 (76.34 to 82.09)	118.55 (113.61 to 123.59)	7.89 (5.14 to 8.64)	1.33 (0.99 to 1.69)	1.73 (1.40 to 2.03)	8.28 (5.46 to 9.09)	-0.58 (-0.80 to -0.39)	-0.75 (-0.97 to -0.53)	-4.80 (-7.62 to -3.91)
Western Europe	10.84 (10.52 to 11.15)	17.25 (16.56 to 17.93)	0.54 (0.50 to 0.64)	-0.23 (-0.39 to -0.03)	-0.72 (-0.88 to -0.56)	-4.22 (-4.67 to -3.81)	-1.18 (-1.28 to -1.08)	-0.64 (-0.78 to -0.52)	-4.88 (-5.53 to -3.78)
Andean Latin America	117.89 (113.83 to 122.14)	161.10 (153.28 to 168.91)	9.37 (8.16 to 11.90)	0.00 (-0.30 to 0.33)	-0.89 (-1.18 to -0.60)	-8.25 (-9.07 to -5.88)	-0.81 (-1.04 to -0.54)	-0.78 (-1.06 to -0.52)	-4.86 (-5.88 to -3.78)
Central Latin America	32.53 (31.73 to 33.35)	49.40 (48.00 to 50.99)	3.38 (3.12 to 4.19)	0.75 (0.52 to 0.93)	-0.39 (-0.61 to -0.19)	-7.53 (-7.85 to -6.72)	-1.69 (-1.83 to -1.55)	-1.51 (-1.67 to -1.35)	-4.21 (-4.74 to -3.03)

	Age-standardised rates in 2013 (per 100000 population)			Annualised rate of change (%)					
				1990–2000			2000–2013		
	Incidence	Prevalence	Mortality	Incidence	Prevalence	Mortality	Incidence	Prevalence	Mortality
Southern Latin America	26.56 (25.80 to 27.32)	38.76 (37.10 to 40.48)	2.05 (1.85 to 2.30)	1.43 (1.06 to 1.78)	-0.06 (-0.35 to 0.23)	-4.77 (-5.78 to -4.23)	-2.56 (-2.75 to -2.39)	-1.56 (-1.78 to -1.32)	-3.35 (-4.03 to -2.70)
Tropical Latin America	52.99 (51.17 to 54.75)	92.22 (86.87 to 97.63)	3.24 (2.40 to 3.64)	0.51 (0.07 to 0.95)	-0.12 (-0.50 to 0.30)	-2.46 (-6.28 to -1.55)	-1.27 (-1.50 to -1.08)	-0.68 (-1.04 to -0.36)	-4.33 (-5.36 to -3.47)
North Africa and Middle East	34.45 (33.65 to 35.29)	48.00 (46.50 to 49.55)	4.56 (4.10 to 5.37)	1.07 (0.85 to 1.30)	-0.32 (-0.50 to -0.12)	-3.72 (-4.35 to -3.07)	-1.10 (-1.18 to -1.03)	-1.26 (-1.35 to -1.16)	-4.58 (-5.34 to -3.89)
High-income North America	5.03 (4.84 to 5.20)	10.05 (9.49 to 10.63)	0.23 (0.19 to 0.38)	-0.75 (-0.99 to -0.52)	-2.29 (-2.60 to -1.99)	-6.84 (-7.96 to -1.42)	-3.32 (-3.55 to -3.10)	-2.28 (-2.57 to -1.97)	-4.14 (-5.14 to -3.10)
Oceania	109.58 (106.38 to 112.83)	174.93 (167.73 to 182.77)	20.21 (12.67 to 40.27)	-0.73 (-1.12 to -0.36)	-0.85 (-1.20 to -0.52)	-6.29 (-8.55 to -2.59)	0.77 (0.60 to 0.98)	0.14 (-0.09 to 0.37)	-2.96 (-4.58 to -0.91)
Central sub-Saharan Africa	285.76 (271.43 to 299.93)	485.43 (453.81 to 520.51)	100.60 (79.63 to 118.71)	0.63 (0.14 to 1.09)	0.31 (-0.12 to 0.74)	-0.12 (-1.35 to 1.27)	0.07 (-0.12 to 0.28)	-0.17 (-0.41 to 0.06)	-3.41 (-4.67 to -1.99)
Eastern sub-Saharan Africa	203.95 (191.93 to 217.39)	311.05 (290.44 to 333.89)	96.61 (82.38 to 104.22)	-0.99 (-1.42 to -0.54)	-1.00 (-1.43 to -0.54)	-0.67 (-1.82 to 0.09)	-0.34 (-0.52 to -0.16)	-0.38 (-0.57 to -0.20)	-3.08 (-4.12 to -2.40)
Southern sub-Saharan Africa	719.33 (642.13 to 823.58)	942.17 (834.80 to 1,079.88)	62.50 (53.16 to 71.44)	-4.74 (-5.78 to -3.50)	-3.70 (-4.66 to -2.54)	1.34 (-0.22 to 2.77)	0.14 (-0.26 to 0.54)	-0.09 (-0.41 to 0.28)	-4.12 (-5.91 to -2.91)
Western sub-Saharan Africa	153.58 (146.18 to 161.45)	262.32 (248.20 to 277.02)	48.48 (41.75 to 55.30)	-0.33 (-0.79 to 0.14)	-0.45 (-0.89 to -0.01)	-0.84 (-1.71 to -0.07)	-0.57 (-0.73 to -0.39)	-0.69 (-0.86 to -0.49)	-3.09 (-3.84 to -2.17)

Data in parentheses are 95% uncertainty intervals.

Table 5
Tuberculosis without HIV incidence and deaths for all ages by sex and annualised rates of change for 21 Global Burden of Disease regions and 188 countries

	All ages incidence and deaths (2013)						Annualised rate of change (%)					
	Male population			Female population			1990–2000			2000–13		
	Incidence	Deaths	Total	Incidence	Deaths	Total	Incidence	Deaths	Total	Incidence	Deaths	Total
Worldwide	4 517 530 (4 398 104 to 4 647 059)	835 602 (739 280 to 958 088)	2 545 138 (2 472 904 to 2 621 788)	454 659 (356 953 to 511 449)	1 290 260 (1 167 284 to 1 406 183)	7 062 668 (6 885 472 to 7 270 226)	0.03 (–0.17 to 0.25)	–329 (–4.07 to –2.58)	–0.60 (–0.73 to –0.50)	–372 (–4.42 to –2.99)		
Developed countries	252 990 (245 783 to 260 127)	28 495 (23 320 to 30 615)	123 333 (120 187 to 125 954)	10 667 (7961 to 12 027)	39 162 (33 106 to 41 646)	376 323 (367 117 to 385 671)	0.55 (0.34 to 0.76)	1.61 (0.82 to 2.05)	–1.18 (–1.30 to –1.07)	–4.94 (–6.29 to –4.37)		
Developing countries	4 264 541 (4 146 317 to 4 392 574)	807 106 (711 182 to 928 549)	2 421 804 (2 351 014 to 2 497 867)	443 992 (349 210 to 500 700)	1 251 098 (1 131 865 to 1 366 785)	6 686 345 (6 511 240 to 6 894 801)	–0.38 (–0.59 to –0.17)	–3.93 (–4.69 to –3.23)	–0.91 (–1.04 to –0.80)	–4.01 (–4.70 to –3.29)		
High-income Asia Pacific	51 867 (50 096 to 53 703)	5443 (4666 to 7069)	29 463 (28 593 to 30 398)	3551 (2701 to 4417)	8994 (7907 to 10 611)	81 331 (78 818 to 83 863)	–0.04 (–0.27 to 0.20)	–6.22 (–6.85 to –5.42)	0.11 (–0.06 to 0.27)	–5.03 (–5.85 to –3.99)		
Brunei	22 (20 to 23)	8 (6 to 10)	15 (14 to 17)	3 (2 to 4)	11 (9 to 13)	37 (34 to 40)	–0.28 (–0.80 to 0.18)	–1.84 (–3.80 to 0.30)	–1.23 (–1.74 to –0.68)	–3.65 (–5.51 to –1.69)		
Japan	17 594 (16 435 to 18 685)	2906 (2327 to 3961)	10 227 (9679 to 10 881)	1915 (1301 to 2618)	4821 (3987 to 5888)	27 820 (26 331 to 29 468)	–0.64 (–1.01 to –0.28)	–386 (–5.02 to –2.79)	–273 (–3.02 to –2.43)	–4.61 (–5.98 to –2.71)		
Singapore	1262 (1195 to 1331)	71 (57 to 96)	569 (542 to 595)	27 (20 to 37)	98 (82 to 124)	1831 (1746 to 1918)	–0.58 (–0.95 to –0.21)	–642 (–776 to –5.23)	–1.24 (–1.54 to –0.93)	–5.48 (–6.99 to –3.82)		
South Korea	32 990 (31 527 to 34 332)	2458 (2089 to 3220)	18 653 (17 970 to 19 309)	1606 (1164 to 2115)	4064 (3512 to 4889)	51 643 (49 712 to 53 364)	–0.32 (–0.62 to 0.06)	–8.27 (–9.24 to –6.67)	0.90 (0.68 to 1.10)	–5.53 (–6.78 to –4.31)		
Central Asia	63 244 (61 027 to 65 347)	6644 (4595 to 7743)	40 455 (39 133 to 41 763)	2138 (1317 to 2568)	8782 (6094 to 10 048)	103 698 (100 303 to 106 922)	1.03 (0.77 to 1.32)	5.50 (0.65 to 6.52)	–0.76 (–0.92 to –0.58)	–4.97 (–5.83 to –4.07)		
Armenia	1353 (1298 to 1402)	118 (73 to 139)	425 (408 to 442)	16 (8 to 20)	134 (83 to 156)	1778 (1713 to 1840)	–1.31 (–1.81 to –0.72)	4.34 (–0.73 to 6.06)	0.98 (0.75 to 1.20)	–2.15 (–4.25 to –0.86)		

	All ages incidence and deaths (2013)						Annualised rate of change (%)					
	Male population			Female population			2000-2000			2000-13		
	Incidence	Deaths	Incidence	Deaths	Incidence	Deaths	Incidence	Deaths	Incidence	Deaths	Incidence	Deaths
Azerbaijan	6617 (6269 to 6969)	595 (418 to 757)	2767 (2622 to 2917)	121 (86 to 160)	9383 (8942 to 9850)	716 (525 to 874)	1.00 (0.57 to 1.43)	3.62 (-1.43 to 5.12)	-1.88 (-2.24 to -1.50)	-7.12 (-8.57 to -5.54)		
Georgia	3740 (3595 to 3887)	163 (132 to 222)	1694 (1634 to 1765)	32 (24 to 39)	5434 (5259 to 5619)	195 (164 to 249)	-0.17 (-0.68 to 0.26)	-1.21 (-2.65 to 0.05)	0.34 (0.07 to 0.62)	-349 (-4.94 to -1.20)		
Kazakhstan	15 156 (14 432 to 15 855)	2009 (1542 to 2570)	10 657 (10 282 to 11 060)	474 (317 to 612)	25 813 (24 838 to 26 776)	2482 (1979 to 3028)	1.32 (0.92 to 1.83)	782 (274 to 940)	-0.72 (-0.95 to -0.44)	-6.38 (-8.04 to -4.45)		
Kyrgyzstan	3958 (3790 to 4131)	495 (292 to 612)	2988 (2873 to 3109)	142 (71 to 180)	6946 (6709 to 7179)	637 (391 to 760)	0.93 (0.44 to 1.35)	7.99 (0.61 to 971)	0.50 (0.26 to 0.74)	-442 (-5.81 to -3.13)		
Mongolia	2456 (2347 to 2564)	364 (265 to 470)	1753 (1688 to 1808)	141 (90 to 183)	4208 (4053 to 4355)	505 (380 to 624)	0.40 (0.03 to 0.83)	0.55 (-0.8 to 2.03)	-0.27 (-0.45 to -0.07)	-336 (-5.16 to -1.66)		
Tajikistan	6765 (6436 to 7088)	420 (239 to 557)	4827 (4570 to 5083)	259 (167 to 351)	11 593 (11 079 to 12 122)	679 (436 to 856)	1.58 (0.89 to 2.17)	7.07 (0.76 to 8.76)	0.27 (-0.04 to 0.55)	-3.95 (-5.58 to -2.32)		
Turkmenistan	2929 (2765 to 3107)	433 (265 to 605)	1675 (1586 to 1759)	132 (84 to 193)	4604 (4391 to 4839)	565 (368 to 746)	-0.44 (-0.84 to -0.05)	389 (1.36 to 553)	-1.68 (-2.04 to -1.32)	-4.99 (-7.19 to -3.02)		
Uzbekistan	20 271 (19 309 to 21 224)	2048 (1002 to 2829)	13 669 (13 054 to 14 289)	821 (420 to 1147)	33 940 (32 505 to 35 238)	2870 (1486 to 3757)	1.62 (1.16 to 2.16)	443 (-1.89 to 5.94)	-1.17 (-1.48 to -0.83)	-3.90 (-6.12 to -1.90)		
East Asia	791 190 (762 944 to 818 962)	35 550 (29 728 to 43 445)	371 698 (358 536 to 386 706)	13 158 (11 150 to 16 040)	1 162 888 (1 126 383 to 1 201 277)	48 708 (42 203 to 56 411)	0.23 (-0.09 to 0.60)	-670 (-7.93 to -5.73)	-2.08 (-2.36 to -1.85)	-7.54 (-8.53 to -6.63)		
China	732 136 (703 787 to 759 995)	33 391 (27 605 to 39 691)	335 017 (322 040 to 350 436)	11 794 (9908 to 14 032)	1 067 153 (1 031 846 to 1 104 841)	45 185 (39 015 to 50 882)	0.17 (-0.16 to 0.56)	-6.85 (-8.22 to -5.83)	-2.32 (-2.62 to -2.07)	-7.77 (-8.79 to -6.88)		
North Korea	50 156 (48 217 to 52 190)	1442 (791 to 3100)	31 827 (30 744 to 32 904)	1117 (625 to 2029)	81 983 (79 533 to 84 781)	2559 (1576 to 5051)	1.49 (0.64 to 2.56)	-1.38 (-3.78 to 0.90)	1.74 (1.42 to 2.07)	-3.11 (-5.25 to -0.71)		
Taiwan (Province of China)	8899 (8465 to 9340)	717 (598 to 899)	4853 (4603 to 5129)	247 (188 to 314)	13 752 (13 142 to 14 394)	964 (836 to 1140)	-0.11 (-0.54 to 0.39)	-6.31 (-8.33 to -4.24)	0.05 (-0.23 to 0.29)	-6.30 (-8.07 to -4.41)		
South Asia	1 633 772 (1 569 448 to 1 702 317)	400 912 (312 339 to 503 463)	804 753 (774 985 to 836 828)	215 086 (166 711 to 264 425)	2 438 524 (2 353 624 to 2 531 209)	615 998 (519 374 to 719 825)	-0.77 (-1.10 to -0.41)	-4.96 (-6.26 to -3.69)	-1.06 (-1.30 to -0.80)	-4.22 (-5.64 to -2.89)		
Afghanistan	7570 (7322 to 7874)	2876 (1666 to 5065)	9127 (8771 to 9459)	6312 (3402 to 10 689)	16 697 (16 178 to 17 247)	9188 (5771 to 14 906)	3.97 (3.43 to 4.51)	-0.65 (-2.98 to 1.86)	0.56 (0.30 to 0.82)	-5.18 (-7.46 to -2.99)		

	All ages incidence and deaths (2013)						Annualised rate of change (%)									
	Male population			Female population			Total			1990-2000			2000-13			
	Incidence	Deaths	Incidence	Deaths	Incidence	Deaths	Incidence	Deaths	Incidence	Deaths	Incidence	Deaths	Incidence	Deaths		
Bangladesh	161 542 (153 701 to 169 490)	12 257 (9086 to 16 868)	102 951 (97 116 to 107 928)	3288 (2214 to 4983)	264 493 (253 273 to 276 373)	15 545 (12 078 to 20 443)	264 493 (253 273 to 276 373)	3288 (2214 to 4983)	102 951 (97 116 to 107 928)	3288 (2214 to 4983)	264 493 (253 273 to 276 373)	15 545 (12 078 to 20 443)	1.36 (0.86 to 1.86)	-5.55 (-8.41 to -3.31)	-0.36 (-0.66 to -0.07)	-6.73 (-8.99 to -3.68)
Bhutan	544 (517 to 574)	68 (31 to 109)	445 (424 to 468)	19 (9 to 33)	990 (948 to 1033)	87 (42 to 139)	990 (948 to 1033)	19 (9 to 33)	445 (424 to 468)	19 (9 to 33)	990 (948 to 1033)	87 (42 to 139)	0.25 (-0.09 to 0.61)	-5.97 (-8.66 to -3.31)	-2.26 (-2.51 to -2.03)	-6.31 (-9.09 to -3.32)
India	1 334 126 (1 276 181 to 1 395 002)	356 940 (271 034 to 454 519)	581 851 (556 873 to 607 765)	188 577 (141 824 to 238 149)	1 915 977 (1 843 861 to 1 993 731)	545 516 (450 129 to 650 735)	1 915 977 (1 843 861 to 1 993 731)	188 577 (141 824 to 238 149)	581 851 (556 873 to 607 765)	188 577 (141 824 to 238 149)	1 915 977 (1 843 861 to 1 993 731)	545 516 (450 129 to 650 735)	-1.10 (-1.50 to -0.67)	-5.21 (-6.68 to -3.77)	-1.13 (-1.42 to -0.82)	-4.01 (-5.56 to -2.53)
Nepal	20 479 (19 384 to 21 535)	5460 (3794 to 7301)	11 092 (10 611 to 11 594)	2702 (1700 to 4062)	31 571 (30 084 to 32 938)	8162 (6007 to 10 639)	31 571 (30 084 to 32 938)	2702 (1700 to 4062)	11 092 (10 611 to 11 594)	2702 (1700 to 4062)	31 571 (30 084 to 32 938)	8162 (6007 to 10 639)	-0.03 (-0.63 to 0.58)	-4.24 (-5.88 to -2.53)	-0.51 (-0.74 to -0.29)	-5.03 (-6.72 to -3.33)
Pakistan	117 080 (111 322 to 122 526)	23 311 (16 082 to 32 229)	108 413 (103 577 to 113 108)	14 188 (8804 to 19 462)	225 493 (216 308 to 234 231)	37 499 (27 926 to 47 069)	225 493 (216 308 to 234 231)	14 188 (8804 to 19 462)	108 413 (103 577 to 113 108)	14 188 (8804 to 19 462)	225 493 (216 308 to 234 231)	37 499 (27 926 to 47 069)	0.27 (-0.12 to 0.65)	-1.27 (-3.28 to 0.78)	-1.31 (-1.55 to -1.07)	-5.31 (-7.55 to -3.08)
Southeast Asia	541 691 (520 045 to 558 187)	130 046 (109 419 to 150 362)	321 035 (311 259 to 330 942)	63 824 (40 144 to 75 348)	862 726 (833 162 to 886 678)	193 870 (158 363 to 219 911)	862 726 (833 162 to 886 678)	63 824 (40 144 to 75 348)	321 035 (311 259 to 330 942)	63 824 (40 144 to 75 348)	862 726 (833 162 to 886 678)	193 870 (158 363 to 219 911)	1.59 (1.34 to 1.83)	-4.10 (-4.95 to -3.23)	-0.54 (-0.68 to -0.42)	-3.61 (-4.42 to -2.82)
Cambodia	16 661 (15 170 to 17 531)	2545 (1709 to 3420)	12 926 (12 358 to 13 427)	1213 (867 to 1704)	29 587 (27 838 to 30 741)	3758 (2878 to 4773)	29 587 (27 838 to 30 741)	1213 (867 to 1704)	12 926 (12 358 to 13 427)	1213 (867 to 1704)	29 587 (27 838 to 30 741)	3758 (2878 to 4773)	1.36 (-0.01 to 1.87)	-3.77 (-5.90 to -1.71)	-1.45 (-1.78 to -0.60)	-5.59 (-7.45 to -3.59)
Indonesia	186 734 (175 949 to 195 308)	71 151 (53 474 to 85 108)	154 066 (147 342 to 160 217)	37 572 (15 822 to 47 009)	340 799 (325 302 to 352 949)	108 723 (73 764 to 127 293)	340 799 (325 302 to 352 949)	37 572 (15 822 to 47 009)	154 066 (147 342 to 160 217)	822 to 47 009	302 to 352 949	108 723 (73 764 to 127 293)	3.13 (2.71 to 3.53)	-3.86 (-5.13 to -2.57)	0.43 (0.11 to 0.71)	-2.62 (-3.94 to -1.47)
Laos	7204 (6684 to 7594)	859 (489 to 1466)	3955 (3715 to 4163)	832 (393 to 1448)	11 160 (10 442 to 11 715)	1691 (987 to 2779)	11 160 (10 442 to 11 715)	832 (393 to 1448)	3955 (3715 to 4163)	832 (393 to 1448)	11 160 (10 442 to 11 715)	1691 (987 to 2779)	3.06 (2.35 to 3.71)	-3.02 (-5.76 to -0.36)	-0.75 (-1.02 to -0.44)	-4.16 (-6.44 to -1.55)
Malaysia	17 498 (16 676 to 18 406)	1334 (1016 to 1599)	9246 (8850 to 9667)	389 (236 to 483)	2 6744 (25 651 to 27 926)	1723 (1311 to 1991)	2 6744 (25 651 to 27 926)	389 (236 to 483)	9246 (8850 to 9667)	389 (236 to 483)	2 6744 (25 651 to 27 926)	1723 (1311 to 1991)	-0.36 (-0.79 to 0.05)	-4.32 (-8.27 to -2.52)	-1.40 (-1.70 to -1.07)	-2.48 (-4.41 to -1.15)
Maldives	85 (82 to 89)	6 (4 to 8)	63 (60 to 65)	2 (1 to 2)	148 (143 to 153)	8 (6 to 9)	148 (143 to 153)	2 (1 to 2)	63 (60 to 65)	2 (1 to 2)	148 (143 to 153)	8 (6 to 9)	-1.83 (-2.21 to -1.43)	-7.65 (-9.08 to -6.02)	-3.25 (-3.56 to -2.98)	-4.85 (-9.44 to -2.97)
Myanmar	59 000 (53 067 to 61 680)	17 233 (9964 to 26 771)	30 437 (29 213 to 31 605)	6523 (3695 to 10 706)	89 437 (83 011 to 92 987)	23 756 (13 957 to 37 308)	89 437 (83 011 to 92 987)	6523 (3695 to 10 706)	30 437 (29 213 to 31 605)	6523 (3695 to 10 706)	89 437 (83 011 to 92 987)	23 756 (13 957 to 37 308)	0.62 (-0.55 to 1.12)	-2.87 (-5.51 to -0.43)	-1.09 (-1.41 to -0.65)	-4.84 (-7.09 to -2.53)
Philippines	114 611 (110 488 to 119 351)	21 116 (16 010 to 28 500)	51 534 (49 589 to 53 349)	8162 (5945 to 10 868)	166 145 (160 384 to 172 007)	29 278 (23 891 to 38 089)	166 145 (160 384 to 172 007)	8162 (5945 to 10 868)	51 534 (49 589 to 53 349)	8162 (5945 to 10 868)	166 145 (160 384 to 172 007)	29 278 (23 891 to 38 089)	0.35 (-0.07 to 0.69)	-1.62 (-2.39 to -0.77)	-0.96 (-1.23 to -0.68)	-3.39 (-4.86 to -1.86)

	All ages incidence and deaths (2013)						Annualised rate of change (%)					
	Male population			Female population			1990-2000			2000-13		
	Incidence	Deaths	Incidence	Deaths	Incidence	Deaths	Incidence	Deaths	Incidence	Deaths	Incidence	Deaths
Sri Lanka	10 106 (9609 to 10 617)	942 (734 to 1334)	5059 (4814 to 5330)	319 (231 to 430)	15 166 (14 454 to 15 881)	1261 (1036 to 1624)	-0.52 (-1.09 to 0.02)	-2.87 (-3.90 to -1.90)	-1.01 (-1.35 to -0.69)	-2.87 (-3.90 to -1.90)	-1.01 (-1.35 to -0.69)	-4.76 (-6.19 to -3.23)
Thailand	46 721 (44 411 to 49 189)	5688 (4374 to 8927)	23 885 (22 833 to 24 943)	3464 (2555 to 4696)	70 607 (67 488 to 73 756)	9152 (7399 to 12 480)	-0.03 (-0.49 to 0.40)	-8.31 (-9.62 to -4.61)	-1.90 (-2.20 to -1.59)	-8.31 (-9.62 to -4.61)	-1.90 (-2.20 to -1.59)	-4.04 (-5.60 to -2.51)
Timor-Leste	942 (902 to 985)	91 (60 to 138)	654 (627 to 678)	58 (35 to 83)	1595 (1534 to 1657)	150 (108 to 209)	1.57 (0.94 to 2.19)	-362 (-5.28 to -1.92)	0.27 (0.01 to 0.50)	-362 (-5.28 to -1.92)	0.27 (0.01 to 0.50)	-4.37 (-6.29 to -2.47)
Vietnam	81 050 (77 670 to 84 298)	8851 (6374 to 12 124)	28 599 (27 468 to 29 768)	5170 (3727 to 6860)	109 649 (105 506 to 113 534)	14 021 (11 297 to 17 789)	252 (2.07 to 3.02)	-6.25 (-8.26 to -4.40)	-11.6 (-1.42 to -0.91)	-6.25 (-8.26 to -4.40)	-11.6 (-1.42 to -0.91)	-6.21 (-8.09 to -4.22)
Australasia	1038 (1000 to 1076)	58 (47 to 71)	834 (807 to 863)	46 (34 to 57)	1873 (1810 to 1929)	103 (88 to 118)	-0.23 (-0.61 to 0.16)	-413 (-5.09 to -3.21)	-0.22 (-0.41 to -0.03)	-413 (-5.09 to -3.21)	-0.22 (-0.41 to -0.03)	-363 (-4.62 to -2.62)
Australia	861 (828 to 896)	48 (37 to 60)	665 (641 to 690)	36 (26 to 47)	1526 (1473 to 1576)	84 (69 to 98)	-0.65 (-1.06 to -0.21)	-349 (-474 to -235)	0.19 (-0.01 to 0.42)	-349 (-474 to -235)	0.19 (-0.01 to 0.42)	-3.05 (-4.21 to -1.86)
New Zealand	177 (170 to 183)	10 (8 to 13)	170 (163 to 176)	9 (7 to 12)	346 (334 to 358)	19 (17 to 23)	1.24 (0.90 to 1.60)	-598 (-7.22 to -4.62)	-1.62 (-1.82 to -1.41)	-598 (-7.22 to -4.62)	-1.62 (-1.82 to -1.41)	-385 (-4.99 to -2.58)
Caribbean	12 755 (12 352 to 13 183)	1948 (1572 to 2687)	8670 (8381 to 8955)	1118 (892 to 1450)	21 425 (20 766 to 22 080)	3067 (2621 to 4000)	1.89 (1.56 to 2.19)	-6.30 (-7.35 to -4.92)	-0.20 (-0.35 to -0.05)	-6.30 (-7.35 to -4.92)	-0.20 (-0.35 to -0.05)	-393 (-4.93 to -2.50)
Antigua and Barbuda	23 (22 to 24)	2 (1 to 2)	16 (16 to 17)	1 (0 to 1)	40 (38 to 41)	2 (2 to 3)	-0.06 (-0.51 to 0.32)	-1.38 (-4.33 to 0.49)	0.41 (0.16 to 0.68)	-1.38 (-4.33 to 0.49)	0.41 (0.16 to 0.68)	-0.50 (-3.19 to 1.75)
Barbados	32 (30 to 33)	6 (4 to 8)	35 (33 to 36)	2 (1 to 3)	66 (64 to 69)	8 (5 to 10)	-0.52 (-0.90 to -0.13)	-147 (-346 to -0.10)	-0.01 (-0.25 to 0.23)	-147 (-346 to -0.10)	-0.01 (-0.25 to 0.23)	-0.51 (-3.35 to 1.44)
Belize	106 (101 to 110)	7 (5 to 10)	60 (58 to 62)	2 (1 to 3)	166 (160 to 171)	10 (6 to 12)	2.05 (1.45 to 2.53)	370 (1.28 to 523)	1.20 (0.97 to 1.47)	370 (1.28 to 523)	1.20 (0.97 to 1.47)	-0.38 (-3.01 to 1.58)
Cuba	1003 (941 to 1063)	32 (26 to 39)	309 (290 to 330)	13 (10 to 17)	1312 (1238 to 1383)	44 (38 to 52)	-0.43 (-0.72 to -0.07)	-2.31 (-3.73 to -1.16)	-4.97 (-5.35 to -4.63)	-2.31 (-3.73 to -1.16)	-4.97 (-5.35 to -4.63)	-5.01 (-6.19 to -3.79)
Dominica	18 (17 to 19)	2 (1 to 2)	12 (11 to 13)	0 (0 to 0)	30 (29 to 31)	2 (1 to 3)	1.02 (0.61 to 1.47)	-140 (-5.37 to 0.39)	-0.87 (-1.22 to -0.55)	-140 (-5.37 to 0.39)	-0.87 (-1.22 to -0.55)	-1.03 (-3.45 to 1.20)
Dominican Republic	3194 (3073 to 3331)	303 (228 to 429)	2117 (2029 to 2196)	148 (109 to 199)	5311 (5129 to 5502)	451 (365 to 591)	0.92 (0.47 to 1.29)	-640 (-7.24 to -4.56)	-1.31 (-1.53 to -1.06)	-640 (-7.24 to -4.56)	-1.31 (-1.53 to -1.06)	-533 (-7.05 to -2.88)
Grenada	25 (24 to 26)	3 (2 to 3)	17 (17 to 18)	0 (0 to 1)	42 (40 to 43)	3 (2 to 4)	1.64 (1.11 to 2.14)	0.17 (-2.84 to 1.57)	-1.54 (-1.80 to -1.29)	0.17 (-2.84 to 1.57)	-1.54 (-1.80 to -1.29)	-1.26 (-3.60 to 0.38)

	All ages incidence and deaths (2013)											
	Male population					Female population					Total	
	Incidence	Deaths	Incidence	Deaths	Incidence	Deaths	Incidence	Deaths	Incidence	Deaths		
Guyana	384 (356 to 406)	29 (19 to 39)	220 (211 to 229)	8 (6 to 12)	604 (568 to 632)	37 (25 to 47)	375 (312 to 436)	1.19 (-3.95 to 2.92)	0.57 (0.35 to 0.84)	-0.72 (-2.93 to 1.20)		
Haiti	5770 (5514 to 6016)	1211 (900 to 1759)	4483 (4273 to 4691)	745 (564 to 1025)	10 253 (9848 to 10 657)	1956 (1598 to 2639)	336 (279 to 390)	-7.06 (-8.45 to -5.27)	0.71 (0.40 to 1.03)	-4.00 (-5.41 to -2.44)		
Jamaica	168 (159 to 175)	24 (17 to 32)	66 (62 to 69)	11 (7 to 15)	233 (223 to 243)	35 (27 to 43)	-2.12 (-2.51 to -1.72)	0.99 (-1.16 to 2.49)	-2.36 (-2.71 to -2.04)	-3.24 (-4.98 to -1.50)		
Saint Lucia	27 (26 to 28)	4 (2 to 5)	23 (22 to 24)	1 (1 to 2)	50 (48 to 52)	5 (3 to 6)	1.06 (0.67 to 1.48)	-0.59 (-3.89 to 0.95)	-2.27 (-2.46 to -2.07)	-2.91 (-4.81 to -1.19)		
Saint Vincent and the Grenadines	23 (21 to 24)	2 (1 to 3)	15 (14 to 15)	0 (0 to 1)	37 (36 to 39)	3 (2 to 3)	1.90 (1.43 to 2.42)	0.06 (-3.46 to 1.73)	-2.60 (-2.92 to -2.28)	-2.93 (-5.67 to -1.13)		
Suriname	154 (145 to 163)	13 (8 to 19)	70 (67 to 74)	4 (3 to 5)	224 (213 to 235)	17 (11 to 23)	1.46 (0.92 to 1.98)	0.49 (-1.83 to 1.91)	-1.31 (-1.68 to -0.96)	-1.25 (-4.23 to 0.96)		
The Bahamas	29 (27 to 30)	9 (6 to 12)	26 (25 to 27)	3 (2 to 4)	55 (52 to 57)	12 (8 to 15)	-0.74 (-1.10 to -0.45)	-1.41 (-3.31 to 0.07)	-4.28 (-4.62 to -3.93)	-2.24 (-4.47 to -0.20)		
Trinidad and Tobago	217 (207 to 227)	29 (17 to 36)	85 (82 to 89)	9 (5 to 12)	303 (291 to 315)	37 (23 to 45)	-0.57 (-0.93 to -0.19)	-0.20 (-3.02 to 0.96)	-1.54 (-1.77 to -1.27)	-2.51 (-5.01 to -1.02)		
Central Europe	25 157 (24 431 to 25 958)	2201 (2014 to 2708)	12 384 (12 026 to 12 741)	646 (566 to 795)	37 541 (36 487 to 38 632)	2846 (2642 to 3395)	1.58 (1.40 to 1.75)	-2.77 (-3.18 to -1.98)	-1.61 (-1.74 to -1.50)	-5.95 (-6.43 to -5.27)		
Albania	374 (358 to 390)	16 (11 to 23)	178 (170 to 184)	9 (6 to 13)	551 (531 to 571)	24 (19 to 33)	-0.46 (-0.84 to -0.11)	-5.23 (-6.94 to 0.46)	-1.70 (-1.92 to -1.50)	-4.63 (-6.73 to -2.40)		
Bosnia and Herzegovina	944 (902 to 984)	134 (73 to 160)	509 (489 to 532)	44 (34 to 56)	1453 (1398 to 1513)	178 (114 to 206)	0.75 (0.47 to 1.07)	-5.94 (-8.01 to -4.44)	-1.84 (-2.07 to -1.60)	-4.75 (-7.31 to -3.34)		
Bulgaria	1805 (1732 to 1878)	113 (98 to 150)	910 (876 to 944)	35 (28 to 47)	2714 (2627 to 2804)	148 (131 to 195)	2.87 (2.39 to 3.40)	1.07 (0.26 to 2.16)	-0.74 (-0.95 to -0.53)	-4.99 (-5.86 to -3.87)		
Croatia	807 (757 to 857)	57 (47 to 95)	420 (396 to 446)	28 (22 to 36)	1227 (1165 to 1296)	85 (73 to 127)	1.05 (0.77 to 1.33)	-8.22 (-9.51 to -3.50)	-4.64 (-5.03 to -4.26)	-6.92 (-8.02 to -4.79)		
Czech Republic	592 (565 to 621)	40 (34 to 66)	269 (257 to 281)	22 (16 to 41)	861 (826 to 897)	62 (52 to 102)	-0.69 (-1.04 to -0.35)	-5.21 (-6.97 to 3.07)	-2.93 (-3.19 to -2.68)	-6.46 (-7.64 to -4.26)		

	All ages incidence and deaths (2013)						Annualised rate of change (%)					
	Male population			Female population			1990-2000			2000-13		
	Incidence	Deaths	Incidence	Deaths	Incidence	Deaths	Incidence	Deaths	Incidence	Deaths	Incidence	Deaths
Hungary	1426 (1375 to 1483)	87 (69 to 196)	726 (697 to 757)	46 (35 to 93)	2152 (2080 to 2228)	134 (108 to 272)	-0.26 (-0.64 to 0.13)	-7.59 (-9.00 to -0.99)	-1.32 (-1.55 to -1.10)	-9.37 (-9.37 to -4.51)	-1.32 (-1.55 to -1.10)	-8.16 (-9.37 to -4.51)
Macedonia	312 (299 to 325)	32 (26 to 47)	177 (171 to 183)	11 (8 to 16)	489 (473 to 506)	42 (36 to 61)	-0.71 (-1.05 to -0.41)	-2.79 (-3.88 to -1.46)	-2.30 (-2.52 to -2.10)	-749 (-8.87 to -416)	-2.30 (-2.52 to -2.10)	-749 (-8.87 to -416)
Montenegro	78 (75 to 81)	2 (1 to 3)	51 (49 to 53)	1 (1 to 1)	129 (125 to 133)	2 (2 to 4)	1.05 (0.65 to 1.44)	0.29 (-2.32 to 4.03)	-0.41 (-0.6 to -0.21)	-8.11 (-10.19 to -3.01)	-0.41 (-0.6 to -0.21)	-8.11 (-10.19 to -3.01)
Poland	6141 (5911 to 6350)	658 (556 to 1110)	2897 (2783 to 3001)	176 (133 to 313)	9038 (8735 to 9314)	834 (714 to 1394)	-0.38 (-0.66 to -0.04)	-6.98 (-8.00 to -2.87)	-1.33 (-1.56 to -1.13)	-535 (-6.26 to -3.86)	-1.33 (-1.56 to -1.13)	-535 (-6.26 to -3.86)
Romania	10 953 (10 478 to 11 423)	919 (571 to 1059)	5250 (5082 to 5445)	202 (92 to 244)	16 203 (15 631 to 16 796)	1121 (692 to 1270)	3.94 (3.65 to 4.29)	3.16 (-1.58 to 4.24)	-1.43 (-1.66 to -1.23)	-6.18 (-7.43 to -5.23)	-1.43 (-1.66 to -1.23)	-6.18 (-7.43 to -5.23)
Serbia	1161 (1110 to 1213)	101 (88 to 132)	703 (681 to 728)	46 (37 to 56)	1864 (1804 to 1930)	148 (132 to 181)	0.40 (0.01 to 0.86)	-0.61 (-3.10 to 2.29)	-0.39 (-0.64 to -0.12)	-588 (-6.81 to -3.99)	-0.39 (-0.64 to -0.12)	-588 (-6.81 to -3.99)
Slovakia	410 (391 to 432)	31 (25 to 37)	203 (195 to 211)	14 (10 to 19)	614 (590 to 639)	45 (38 to 52)	-1.98 (-2.29 to -1.70)	-5.90 (-7.59 to -2.10)	-4.25 (-4.51 to -3.95)	-4.58 (-5.77 to -3.34)	-4.25 (-4.51 to -3.95)	-4.58 (-5.77 to -3.34)
Slovenia	155 (148 to 162)	12 (10 to 15)	91 (87 to 95)	11 (8 to 16)	247 (237 to 256)	23 (18 to 28)	-1.25 (-1.50 to -1.01)	-7.84 (-9.43 to -3.53)	-4.92 (-5.17 to -4.68)	-4.38 (-6.46 to -2.82)	-4.92 (-5.17 to -4.68)	-4.38 (-6.46 to -2.82)
Eastern Europe	133 535 (127 584 to 139 310)	17 428 (11 652 to 19 299)	54 525 (52 459 to 56 300)	3944 (1987 to 4564)	188 061 (181 006 to 194 926)	21 372 (14 337 to 23 390)	1.33 (0.99 to 1.69)	8.28 (5.46 to 9.09)	-0.58 (-0.80 to -0.39)	-4.80 (-7.62 to -3.91)	-0.58 (-0.80 to -0.39)	-4.80 (-7.62 to -3.91)
Belarus	4600 (4412 to 4804)	612 (340 to 743)	1778 (1713 to 1842)	110 (73 to 138)	6378 (6156 to 6624)	722 (427 to 852)	0.64 (0.14 to 1.09)	5.98 (3.66 to 6.97)	0.20 (-0.09 to 0.50)	-1.48 (-5.03 to -0.04)	0.20 (-0.09 to 0.50)	-1.48 (-5.03 to -0.04)
Estonia	314 (301 to 328)	35 (28 to 40)	115 (110 to 120)	8 (6 to 10)	429 (414 to 445)	44 (35 to 49)	0.29 (-0.20 to 0.75)	4.25 (0.02 to 5.59)	-3.42 (-3.70 to -3.14)	-8.24 (-9.26 to -7.23)	-3.42 (-3.70 to -3.14)	-8.24 (-9.26 to -7.23)
Latvia	780 (747 to 816)	60 (50 to 77)	368 (352 to 383)	17 (14 to 21)	1148 (1106 to 1192)	78 (67 to 95)	0.27 (-0.10 to 0.69)	5.20 (2.90 to 6.18)	-2.43 (-2.67 to -2.16)	-8.97 (-10.32 to -6.96)	-2.43 (-2.67 to -2.16)	-8.97 (-10.32 to -6.96)
Lithuania	1457 (1394 to 1523)	176 (137 to 205)	594 (572 to 615)	41 (29 to 52)	2051 (1982 to 2127)	217 (168 to 246)	0.15 (-0.23 to 0.54)	3.17 (0.55 to 4.20)	-0.73 (-0.96 to -0.49)	-4.09 (-5.19 to -3.09)	-0.73 (-0.96 to -0.49)	-4.09 (-5.19 to -3.09)
Moldova	3218 (3092 to 3354)	328 (218 to 369)	1245 (1200 to 1290)	56 (32 to 67)	4463 (4316 to 4623)	384 (258 to 429)	3.21 (2.66 to 3.69)	7.60 (1.92 to 8.92)	1.64 (1.40 to 1.88)	-1.41 (-2.87 to -0.50)	1.64 (1.40 to 1.88)	-1.41 (-2.87 to -0.50)

	All ages incidence and deaths (2013)						Annualised rate of change (%)					
	Male population			Female population			1990-2000			2000-13		
	Incidence	Deaths	Incidence	Deaths	Incidence	Deaths	Incidence	Deaths	Incidence	Deaths	Incidence	Deaths
Russia	99 009 (94 194 to 103 393)	12 075 (8364 to 13 569)	41 613 (39 823 to 43 098)	2754 (1332 to 3200)	140 622 (135 057 to 146 053)	14 829 (10 158 to 16 436)	1.37 (0.95 to 1.82)	8.72 (5.42 to 9.70)	-0.53 (-0.84 to -0.28)	-5.19 (-7.85 to -4.21)		
Ukraine	24 157 (22 734 to 25 531)	4141 (2591 to 4870)	8812 (8381 to 9239)	958 (501 to 1222)	32 969 (31 207 to 34 714)	5099 (3140 to 5841)	1.16 (0.77 to 1.60)	115 (5.80 to 8.66)	-1.18 (-1.51 to -0.84)	-3.34 (-7.29 to -1.87)		
Western Europe	29 517 (28 659 to 30 370)	2660 (2396 to 3516)	19 185 (18 599 to 19 725)	2011 (1640 to 2357)	48 702 (47 293 to 50 021)	4670 (4234 to 5466)	-0.23 (-0.39 to -0.03)	-4.22 (-4.67 to -3.81)	-1.18 (-1.28 to -1.08)	-4.88 (-5.53 to -3.78)		
Andorra	10 (9 to 10)	0 (0 to 0)	8 (7 to 8)	0 (0 to 0)	18 (17 to 18)	0 (0 to 1)	5.20 (4.59 to 5.86)	-4.60 (-7.70 to -1.71)	-2.13 (-2.37 to -1.89)	-3.14 (-5.50 to -0.78)		
Austria	615 (591 to 641)	35 (28 to 62)	342 (329 to 355)	24 (19 to 35)	958 (922 to 992)	60 (49 to 93)	0.31 (-0.05 to 0.72)	-9.56 (-11.01 to -3.71)	-1.57 (-1.83 to -1.35)	-3.97 (-5.15 to -2.71)		
Belgium	737 (706 to 764)	71 (56 to 88)	438 (420 to 455)	48 (34 to 64)	1175 (1133 to 1214)	118 (96 to 141)	-0.85 (-1.16 to -0.58)	-1.72 (-3.80 to -0.52)	-0.61 (-0.82 to -0.41)	-3.70 (-5.02 to -2.34)		
Cyprus	36 (35 to 38)	2 (2 to 3)	40 (38 to 41)	1 (1 to 1)	76 (74 to 79)	3 (2 to 4)	0.23 (-0.12 to 0.58)	-4.05 (-6.10 to -2.04)	0.59 (0.39 to 0.80)	-5.37 (-7.18 to -3.24)		
Denmark	256 (245 to 267)	23 (19 to 29)	185 (177 to 193)	16 (12 to 21)	441 (425 to 456)	39 (34 to 46)	0.57 (0.25 to 0.93)	-2.51 (-3.80 to -1.35)	-1.71 (-1.95 to -1.48)	-3.43 (-4.68 to -2.17)		
Finland	256 (246 to 265)	39 (31 to 59)	149 (144 to 154)	42 (31 to 60)	405 (392 to 417)	81 (66 to 114)	-1.10 (-1.41 to -0.76)	-4.29 (-5.52 to -2.81)	-1.10 (-1.31 to -0.88)	-5.56 (-7.09 to -3.12)		
France	4558 (4354 to 4760)	722 (577 to 977)	3077 (2944 to 3227)	697 (485 to 967)	7635 (7329 to 7949)	1419 (1151 to 1762)	-1.28 (-1.54 to -0.98)	-2.71 (-4.40 to -1.52)	-0.88 (-1.13 to -0.64)	-5.65 (-7.12 to -3.43)		
Germany	4554 (4353 to 4769)	312 (258 to 565)	2754 (2636 to 2874)	196 (152 to 273)	7309 (7018 to 7608)	508 (430 to 808)	-1.13 (-1.39 to -0.88)	-5.97 (-6.86 to -4.32)	-3.39 (-3.63 to -3.14)	-6.22 (-7.41 to -3.22)		
Greece	525 (499 to 548)	124 (89 to 150)	232 (221 to 244)	110 (48 to 152)	757 (725 to 788)	234 (150 to 283)	-1.05 (-1.42 to -0.65)	-8.68 (-9.95 to -4.50)	-2.04 (-2.31 to -1.79)	1.37 (-4.37 to 3.08)		
Iceland	19 (18 to 20)	0 (0 to 1)	20 (19 to 21)	2 (1 to 2)	39 (38 to 41)	2 (1 to 3)	174 (1.29 to 2.20)	-5.07 (-7.26 to -1.85)	-1.18 (-1.45 to -0.91)	-0.74 (-5.01 to 1.85)		

	All ages incidence and deaths (2013)						Annualised rate of change (%)					
	Male population			Female population			2000-2000			2000-13		
	Incidence	Deaths	Incidence	Deaths	Incidence	Deaths	Incidence	Deaths	Incidence	Deaths	Incidence	Deaths
Ireland	307 (293 to 320)	22 (17 to 27)	181 (173 to 189)	16 (12 to 21)	488 (468 to 507)	38 (31 to 45)	-0.88 (-1.27 to -0.49)	-4.71 (-5.90 to -3.54)	0.51 (0.29 to 0.74)	-4.49 (-5.94 to -3.16)		
Israel	352 (339 to 364)	25 (20 to 31)	188 (180 to 195)	14 (10 to 20)	539 (521 to 557)	39 (32 to 48)	-0.04 (-0.48 to 0.42)	-0.11 (-5.05 to 1.53)	-1.46 (-1.65 to -1.26)	-7.11 (-8.72 to -5.50)		
Italy	2868 (2726 to 2999)	295 (238 to 389)	1942 (1858 to 2026)	203 (144 to 271)	4810 (4609 to 4999)	498 (415 to 600)	-0.76 (-1.05 to -0.42)	-5.22 (-6.26 to -4.32)	-1.43 (-1.70 to -1.19)	-4.53 (-5.78 to -3.28)		
Luxembourg	30 (28 to 31)	1 (1 to 1)	21 (20 to 22)	1 (1 to 2)	51 (49 to 53)	2 (2 to 2)	0.97 (0.54 to 1.43)	2.98 (-6.36 to 5.42)	-2.48 (-2.76 to -2.22)	-8.56 (-10.73 to -6.39)		
Malta	29 (28 to 30)	0 (0 to 1)	20 (19 to 21)	0 (0 to 0)	49 (47 to 51)	1 (1 to 1)	3.82 (3.35 to 4.33)	-2.94 (-5.44 to -1.15)	-2.74 (-3.00 to -2.50)	-6.24 (-7.80 to -4.68)		
Netherlands	781 (751 to 812)	65 (53 to 84)	553 (534 to 571)	57 (43 to 78)	1334 (1291 to 1378)	123 (103 to 154)	-1.01 (-1.24 to -0.76)	-2.75 (-4.06 to -1.60)	-1.73 (-1.92 to -1.54)	-4.28 (-5.58 to -2.98)		
Norway	205 (196 to 213)	25 (20 to 31)	196 (189 to 203)	25 (18 to 33)	401 (387 to 414)	50 (41 to 60)	-1.75 (-2.01 to -1.46)	-1.83 (-4.50 to -0.46)	-0.25 (-0.46 to -0.05)	-3.95 (-5.29 to -2.61)		
Portugal	1672 (1603 to 1731)	191 (161 to 223)	889 (860 to 921)	78 (50 to 98)	2561 (2470 to 2639)	269 (223 to 305)	2.38 (2.07 to 2.72)	-3.13 (-5.91 to -2.19)	-2.29 (-2.51 to -2.10)	-5.45 (-6.38 to -4.52)		
Spain	4983 (4804 to 5160)	324 (270 to 475)	2959 (2846 to 3080)	205 (155 to 270)	7942 (7683 to 8198)	529 (451 to 680)	1.09 (0.80 to 1.40)	-6.41 (-7.41 to -3.70)	-1.70 (-1.88 to -1.52)	-4.78 (-5.74 to -3.77)		
Sweden	378 (364 to 392)	53 (41 to 68)	311 (299 to 323)	60 (41 to 83)	689 (666 to 711)	113 (91 to 143)	-0.83 (-1.11 to -0.54)	-1.17 (-3.35 to 0.05)	-0.14 (-0.32 to 0.06)	-3.51 (-5.14 to -1.88)		
Switzerland	515 (493 to 536)	42 (34 to 59)	353 (339 to 368)	25 (18 to 39)	868 (834 to 900)	68 (55 to 95)	0.05 (-0.39 to 0.52)	-2.72 (-4.00 to -1.27)	-0.41 (-0.65 to -0.21)	-4.58 (-6.05 to -3.11)		
UK	5798 (5602 to 5988)	285 (210 to 331)	4306 (4166 to 4446)	186 (142 to 213)	10 104 (9811 to 10 382)	471 (367 to 530)	0.42 (0.08 to 0.81)	-3.57 (-4.51 to -3.16)	1.04 (0.86 to 1.23)	-2.66 (-3.91 to -1.41)		
Andean Latin America	36 216 (34 796 to 37 724)	2556 (2128 to 3594)	26 385 (25 388 to 27 420)	1441 (1197 to 1753)	62 601 (60 306 to 64 967)	3997 (3456 to 5090)	0.00 (-0.30 to 0.33)	-8.25 (-9.07 to -5.88)	-0.81 (-1.04 to -0.54)	-4.86 (-5.88 to -3.78)		

	All ages incidence and deaths (2013)						Annualised rate of change (%)								
	Male population			Female population			Total			1990-2000			2000-13		
	Incidence	Deaths	Incidence	Deaths	Incidence	Deaths	Incidence	Deaths	Incidence	Deaths	Incidence	Deaths	Incidence	Deaths	
Bolivia	7516 (7087 to 7915)	410 (293 to 571)	5200 (4952 to 5409)	316 (223 to 447)	12 716 (12 140 to 13 247)	726 (565 to 923)	1.15 (0.44 to 1.72)	-716 (-913 to -510)	-0.87 (-1.16 to -0.56)	-4.80 (-6.69 to -2.93)					
Ecuador	8555 (8105 to 9016)	711 (562 to 992)	5711 (5444 to 5981)	324 (239 to 416)	14 266 (13 639 to 14 930)	1035 (863 to 1329)	-0.32 (-0.77 to 0.20)	-472 (-559 to -386)	-1.06 (-1.38 to -0.69)	-5.13 (-6.60 to -3.45)					
Peru	20 145 (19 215 to 21 153)	1435 (1100 to 2157)	15 475 (14 761 to 16 181)	801 (619 to 1074)	35 619 (34 227 to 37 172)	2236 (1825 to 3032)	-0.20 (-0.57 to 0.17)	-9.77 (-10.94 to -6.02)	-0.67 (-0.95 to -0.33)	-4.67 (-6.14 to -3.14)					
Central Latin America	43 749 (42 613 to 44 861)	4446 (4041 to 5766)	28 824 (28 022 to 29 525)	1800 (1614 to 2107)	72 573 (70 783 to 74 324)	6245 (5761 to 7658)	0.75 (0.52 to 0.93)	-7.53 (-7.85 to -6.72)	-1.69 (-1.83 to -1.55)	-4.21 (-4.74 to -3.03)					
Colombia	9703 (9371 to 10 025)	1009 (765 to 1259)	6397 (6152 to 6646)	389 (304 to 504)	16 099 (15 579 to 16 618)	1398 (1130 to 1664)	0.62 (0.20 to 1.07)	-4.70 (-5.68 to -3.86)	0.14 (-0.12 to 0.40)	-3.28 (-4.63 to -1.97)					
Costa Rica	581 (556 to 607)	46 (39 to 67)	278 (266 to 291)	20 (16 to 27)	859 (827 to 891)	67 (58 to 91)	272 (2.24 to 3.20)	-4.16 (-5.40 to -1.82)	-4.85 (-5.10 to -4.61)	-5.35 (-6.60 to -3.31)					
El Salvador	1058 (1021 to 1091)	75 (58 to 121)	676 (653 to 700)	35 (26 to 51)	1734 (1682 to 1783)	110 (89 to 166)	3.22 (2.65 to 3.76)	-8.40 (-9.59 to -5.49)	-2.71 (-2.92 to -2.50)	-4.25 (-5.74 to -1.83)					
Guatemala	3210 (3023 to 3404)	281 (231 to 447)	2289 (2138 to 2420)	162 (132 to 220)	5500 (5193 to 5787)	444 (384 to 647)	1.96 (1.60 to 2.33)	-8.36 (-9.30 to -5.06)	-2.93 (-3.28 to -2.46)	-4.87 (-5.90 to -3.15)					
Honduras	1871 (1737 to 1973)	163 (111 to 245)	1202 (1115 to 1267)	71 (45 to 104)	3073 (2868 to 3219)	234 (170 to 317)	2.15 (1.26 to 2.69)	-3.08 (-5.53 to -0.88)	-1.71 (-2.13 to -0.60)	-3.17 (-5.35 to -0.69)					
Mexico	18 799 (18 137 to 19 577)	2067 (1900 to 2795)	12 333 (11 807 to 12 760)	742 (665 to 934)	31 132 (30 075 to 32 230)	2808 (2607 to 3614)	0.21 (-0.19 to 0.49)	-9.45 (-9.77 to -8.61)	-2.54 (-2.76 to -2.33)	-4.83 (-5.38 to -2.74)					
Nicaragua	1308 (1256 to 1356)	131 (110 to 186)	984 (950 to 1023)	64 (53 to 79)	2292 (2216 to 2364)	195 (170 to 252)	1.80 (1.45 to 2.17)	-4.76 (-5.85 to -3.06)	-2.64 (-2.84 to -2.43)	-5.94 (-7.06 to -3.97)					
Panama	1108 (1067 to 1149)	147 (117 to 182)	623 (602 to 645)	74 (52 to 94)	1731 (1681 to 1784)	221 (178 to 257)	0.46 (0.14 to 0.80)	-3.18 (-4.29 to -2.00)	-0.70 (-0.93 to -0.48)	-2.08 (-3.44 to -0.78)					
Venezuela	6112 (5864 to 6352)	527 (440 to 672)	4043 (3900 to 4196)	242 (193 to 301)	10 154 (9802 to 10 512)	769 (671 to 953)	1.30 (0.80 to 1.78)	-4.11 (-5.00 to -3.28)	-0.49 (-0.76 to -0.26)	-3.44 (-4.56 to -2.09)					

	All ages incidence and deaths (2013)						Annualised rate of change (%)					
	Male population			Female population			1990-2000			2000-13		
	Incidence	Deaths	Incidence	Deaths	Incidence	Deaths	Incidence	Deaths	Incidence	Deaths	Incidence	Deaths
Southern Latin America	9688 (9376 to 10 011)	903 (801 to 1083)	7399 (7165 to 7652)	478 (376 to 569)	17 086 (16 596 to 17 583)	1381 (1245 to 1552)	143 (1.06 to 1.78)	-4.77 (-5.78 to -4.23)	-2.56 (-2.75 to -2.39)	-3.35 (-4.03 to -2.70)		
Argentina	7099 (6824 to 7376)	483 (417 to 641)	6036 (5827 to 6272)	243 (203 to 301)	13 135 (12 732 to 13 551)	726 (650 to 901)	2.19 (1.71 to 2.64)	-4.75 (-5.44 to -3.87)	-2.52 (-2.74 to -2.31)	-3.84 (-4.64 to -2.91)		
Chile	2030 (1945 to 2112)	378 (307 to 445)	1087 (1045 to 1128)	214 (125 to 279)	3117 (3000 to 3222)	592 (462 to 682)	-0.95 (-1.24 to -0.66)	-4.67 (-8.82 to -3.54)	-3.04 (-3.30 to -2.80)	-3.09 (-4.21 to -2.00)		
Uruguay	559 (538 to 585)	42 (34 to 53)	275 (265 to 285)	21 (16 to 28)	834 (809 to 864)	63 (54 to 75)	0.24 (-0.09 to 0.54)	-6.04 (-7.31 to -2.82)	-1.64 (-1.82 to -1.44)	-3.69 (-4.84 to -2.50)		
Tropical Latin America	73 306 (70 470 to 76 015)	4403 (3323 to 5088)	38 108 (36 706 to 39 505)	1680 (1019 to 2013)	111 414 (107 496 to 115 183)	6083 (4538 to 6844)	0.51 (0.07 to 0.95)	-2.46 (-6.28 to -1.55)	-1.27 (-1.50 to -1.08)	-4.33 (-5.36 to -3.47)		
Brazil	70 916 (68 130 to 73 599)	4184 (3070 to 4864)	36 902 (35 531 to 38 259)	1604 (954 to 1934)	107 818 (103 978 to 111 454)	5788 (4226 to 6524)	0.51 (0.06 to 0.96)	-2.48 (-6.52 to -1.54)	-1.25 (-1.48 to -1.05)	-4.45 (-5.55 to -3.58)		
Paraguay	2390 (2303 to 2479)	219 (174 to 284)	1206 (1159 to 1255)	75 (57 to 96)	3596 (3475 to 3717)	295 (243 to 359)	0.31 (-0.09 to 0.64)	-1.86 (-3.01 to 0.40)	-1.95 (-2.18 to -1.71)	-1.00 (-2.49 to 0.33)		
North Africa and Middle East	86 141 (83 903 to 88 660)	8299 (7259 to 10 104)	68 242 (66 546 to 69 943)	6920 (5792 to 8585)	154 383 (150 668 to 158 377)	15 219 (13 553 to 18 407)	1.07 (0.85 to 1.30)	-3.72 (-4.35 to -3.07)	-1.10 (-1.18 to -1.03)	-4.58 (-5.34 to -3.89)		
Algeria	11 691 (11 189 to 12 162)	955 (739 to 1181)	8879 (8507 to 9238)	773 (435 to 988)	20 570 (19 806 to 21 341)	1728 (1282 to 2038)	2.37 (1.91 to 2.84)	-4.03 (-6.09 to -2.11)	-0.39 (-0.61 to -0.19)	-4.59 (-6.49 to -2.96)		
Bahrain	213 (203 to 224)	6 (5 to 9)	103 (98 to 107)	3 (2 to 3)	316 (303 to 329)	9 (7 to 11)	3.34 (2.94 to 3.74)	0.16 (-4.67 to 2.36)	-1.11 (-1.33 to -0.88)	-7.09 (-9.11 to -5.05)		
Egypt	9949 (9524 to 10 386)	566 (461 to 812)	6400 (6127 to 6676)	271 (222 to 342)	16 349 (15 790 to 16 971)	837 (715 to 1107)	-0.59 (-0.98 to -0.24)	-6.15 (-7.43 to -4.74)	-1.99 (-2.23 to -1.73)	-5.27 (-6.55 to -3.58)		
Iran	8393 (8006 to 8818)	829 (373 to 1060)	8093 (7739 to 8472)	573 (203 to 757)	16 485 (15 864 to 17 177)	1402 (601 to 1689)	0.38 (-0.05 to 0.80)	-1.99 (-8.10 to 0.16)	-1.58 (-1.83 to -1.32)	-3.67 (-8.62 to -1.85)		
Iraq	6817 (6557 to 7089)	531 (359 to 767)	5875 (5640 to 6102)	518 (344 to 741)	12 693 (12 244 to 13 108)	1050 (791 to 1352)	2.10 (1.61 to 2.66)	-0.06 (-2.54 to 2.43)	0.34 (0.14 to 0.52)	-2.74 (-4.90 to -0.55)		

	All ages incidence and deaths (2013)						Annualised rate of change (%)								
	Male population			Female population			Total			1990-2000			2000-13		
	Incidence	Deaths	Incidence	Deaths	Incidence	Deaths	Incidence	Deaths	Incidence	Deaths	Incidence	Deaths	Incidence	Deaths	
Jordan	233 (223 to 243)	14 (10 to 19)	294 (283 to 306)	9 (7 to 12)	527 (508 to 545)	23 (19 to 27)	-1.51 (-1.82 to -1.19)	-4.05 (-6.24 to -1.60)	-2.61 (-2.85 to -2.38)	-4.05 (-6.24 to -1.60)	-2.61 (-2.85 to -2.38)	-6.29 (-8.15 to -4.24)	-4.05 (-6.24 to -1.60)	-2.61 (-2.85 to -2.38)	
Kuwait	543 (519 to 569)	16 (14 to 20)	399 (383 to 414)	12 (8 to 15)	943 (906 to 980)	28 (24 to 32)	-0.93 (-1.26 to -0.59)	-4.24 (-7.68 to -2.34)	0.02 (-0.16 to 0.19)	-4.24 (-7.68 to -2.34)	0.02 (-0.16 to 0.19)	-4.47 (-6.08 to -2.88)	-4.24 (-7.68 to -2.34)	0.02 (-0.16 to 0.19)	
Lebanon	297 (284 to 308)	27 (18 to 39)	351 (339 to 364)	18 (10 to 31)	647 (627 to 667)	45 (30 to 61)	-2.56 (-2.92 to -2.15)	-6.13 (-8.30 to -3.44)	0.08 (-0.11 to 0.25)	-6.13 (-8.30 to -3.44)	0.08 (-0.11 to 0.25)	-3.76 (-5.73 to -1.72)	-6.13 (-8.30 to -3.44)	0.08 (-0.11 to 0.25)	
Libya	1159 (1107 to 1205)	47 (34 to 62)	773 (738 to 808)	27 (20 to 36)	1932 (1858 to 1999)	74 (59 to 90)	-0.17 (-0.48 to 0.14)	-392 (-6.37 to -1.01)	-0.29 (-0.51 to -0.09)	-392 (-6.37 to -1.01)	-0.29 (-0.51 to -0.09)	-2.09 (-4.07 to -0.11)	-392 (-6.37 to -1.01)	-0.29 (-0.51 to -0.09)	
Morocco	13 415 (13 005 to 13 883)	1945 (1447 to 2587)	10 017 (9667 to 10 323)	1191 (772 to 1555)	23 432 (22 701 to 24 090)	3135 (2448 to 3831)	210 (176 to 245)	-4.26 (-5.86 to -2.60)	-0.35 (-0.56 to -0.18)	-4.26 (-5.86 to -2.60)	-0.35 (-0.56 to -0.18)	-3.98 (-5.54 to -2.43)	-4.26 (-5.86 to -2.60)	-0.35 (-0.56 to -0.18)	
Oman	324 (308 to 341)	21 (15 to 29)	212 (205 to 221)	11 (8 to 15)	537 (517 to 558)	32 (25 to 40)	0.07 (-0.26 to 0.39)	-4.07 (-7.49 to -1.27)	-0.93 (-1.13 to -0.72)	-4.07 (-7.49 to -1.27)	-0.93 (-1.13 to -0.72)	-1.32 (-4.47 to 1.22)	-4.07 (-7.49 to -1.27)	-0.93 (-1.13 to -0.72)	
Palestine	212 (198 to 227)	3 (2 to 6)	101 (93 to 109)	2 (1 to 3)	314 (294 to 334)	4 (3 to 8)	-113 (-1.49 to -0.74)	-9.54 (-11.95 to -6.97)	-0.81 (-1.12 to -0.54)	-9.54 (-11.95 to -6.97)	-0.81 (-1.12 to -0.54)	-6.67 (-9.40 to 0.66)	-9.54 (-11.95 to -6.97)	-0.81 (-1.12 to -0.54)	
Qatar	628 (599 to 655)	4 (3 to 5)	136 (131 to 142)	1 (1 to 1)	764 (730 to 794)	5 (4 to 6)	-1.07 (-1.39 to -0.69)	-10.71 (-13.40 to -1.51)	-0.21 (-0.44 to 0.04)	-10.71 (-13.40 to -1.51)	-0.21 (-0.44 to 0.04)	-6.72 (-8.60 to -4.88)	-10.71 (-13.40 to -1.51)	-0.21 (-0.44 to 0.04)	
Saudi Arabia	3326 (3194 to 3457)	515 (405 to 678)	2121 (2035 to 2200)	378 (287 to 464)	5447 (5253 to 5623)	894 (760 to 1066)	-0.24 (-0.61 to 0.17)	-4.01 (-6.99 to -1.46)	-1.36 (-1.57 to -1.15)	-4.01 (-6.99 to -1.46)	-1.36 (-1.57 to -1.15)	-5.23 (-6.74 to -3.50)	-4.01 (-6.99 to -1.46)	-1.36 (-1.57 to -1.15)	
Sudan	12 035 (11 497 to 12 546)	1041 (619 to 1638)	9052 (8705 to 9391)	1260 (688 to 2041)	21 086 (20 354 to 21 845)	2301 (1596 to 3312)	349 (3.02 to 395)	-1.53 (-3.42 to 0.50)	-1.42 (-1.67 to -1.20)	-1.53 (-3.42 to 0.50)	-1.42 (-1.67 to -1.20)	-4.66 (-6.36 to -3.02)	-1.53 (-3.42 to 0.50)	-1.42 (-1.67 to -1.20)	
Syria	2301 (2203 to 2391)	34 (22 to 76)	2229 (2149 to 2311)	22 (16 to 39)	4530 (4378 to 4678)	56 (42 to 109)	-0.81 (-1.17 to -0.47)	-17.86 (-22.06 to -7.72)	-1.32 (-1.55 to -1.09)	-17.86 (-22.06 to -7.72)	-1.32 (-1.55 to -1.09)	-4.47 (-6.76 to -2.18)	-17.86 (-22.06 to -7.72)	-1.32 (-1.55 to -1.09)	
Tunisia	1962 (1888 to 2037)	108 (69 to 150)	1247 (1201 to 1290)	50 (28 to 75)	3209 (3099 to 3306)	158 (108 to 204)	-0.12 (-0.56 to 0.33)	-6.73 (-8.86 to -4.62)	-0.18 (-0.37 to 0.01)	-6.73 (-8.86 to -4.62)	-0.18 (-0.37 to 0.01)	-3.17 (-5.22 to -1.07)	-6.73 (-8.86 to -4.62)	-0.18 (-0.37 to 0.01)	
Turkey	12 762 (12 296 to 13 256)	769 (600 to 1000)	8146 (7902 to 8442)	310 (199 to 374)	20 908 (20 284 to 21 577)	1079 (894 to 1303)	-0.13 (-0.52 to 0.25)	-7.47 (-8.63 to -6.29)	-0.63 (-0.85 to -0.40)	-7.47 (-8.63 to -6.29)	-0.63 (-0.85 to -0.40)	-6.89 (-8.50 to -5.40)	-7.47 (-8.63 to -6.29)	-0.63 (-0.85 to -0.40)	

	All ages incidence and deaths (2013)						Annualised rate of change (%)					
	Male population			Female population			1990-2000			2000-13		
	Incidence	Deaths	Incidence	Deaths	Incidence	Deaths	Incidence	Deaths	Incidence	Deaths	Incidence	Deaths
United Arab Emirates	182 (160 to 205)	41 (23 to 73)	132 (122 to 144)	11 (6 to 20)	314 (284 to 348)	52 (33 to 88)	-2.06 (-2.49 to -1.61)	-5.67 (-9.36 to -2.35)	-2.43 (-2.70 to -2.14)	-5.91 (-5.91 to -1.39)	-2.43 (-2.70 to -2.14)	-3.48 (-5.91 to -1.39)
Yemen	4060 (3889 to 4231)	818 (454 to 1807)	3532 (3386 to 3664)	1473 (797 to 3012)	7592 (7305 to 7839)	2291 (1316 to 4607)	1.76 (1.44 to 2.11)	-2.58 (-5.41 to 0.43)	-2.88 (-3.15 to -2.65)	-3.23 (-5.60 to -0.46)	-2.88 (-3.15 to -2.65)	-3.23 (-5.60 to -0.46)
High-income North America	11 875 (11 372 to 12 364)	707 (586 to 1241)	6941 (6674 to 7204)	471 (369 to 816)	18 816 (18 130 to 19 491)	1177 (998 to 1966)	-0.75 (-0.99 to -0.52)	-6.84 (-7.96 to -1.42)	-3.32 (-3.55 to -3.10)	-4.14 (-5.14 to -1.90)	-3.32 (-3.55 to -3.10)	-4.14 (-5.14 to -1.90)
Canada	1100 (1058 to 1143)	76 (62 to 95)	825 (793 to 860)	68 (51 to 89)	1925 (1856 to 1997)	144 (121 to 173)	-0.16 (-0.40 to 0.09)	-4.31 (-5.58 to -3.26)	-2.78 (-3.01 to -2.58)	-3.95 (-5.23 to -2.44)	-2.78 (-3.01 to -2.58)	-3.95 (-5.23 to -2.44)
USA	10 773 (10 289 to 11 246)	630 (513 to 1154)	6115 (5872 to 6358)	403 (304 to 747)	16 888 (16 246 to 17 509)	1033 (862 to 1814)	-0.81 (-1.06 to -0.55)	-7.17 (-8.41 to -1.17)	-3.39 (-3.64 to -3.16)	-3.97 (-5.06 to -1.57)	-3.39 (-3.64 to -3.16)	-3.97 (-5.06 to -1.57)
Oceania	4645 (4489 to 4814)	704 (400 to 1623)	4218 (4075 to 4362)	446 (267 to 1000)	8864 (8595 to 9143)	1150 (683 to 2513)	-0.73 (-1.12 to -0.36)	-6.29 (-8.55 to -2.59)	0.77 (0.60 to 0.98)	-2.96 (-4.58 to -0.91)	0.77 (0.60 to 0.98)	-2.96 (-4.58 to -0.91)
Federated States of Micronesia	43 (39 to 48)	7 (4 to 11)	40 (35 to 44)	5 (3 to 9)	83 (75 to 93)	12 (8 to 19)	-0.67 (-1.17 to -0.17)	-3.90 (-6.15 to -1.42)	-0.43 (-0.85 to 0.00)	-4.15 (-6.50 to -1.65)	-0.43 (-0.85 to 0.00)	-4.15 (-6.50 to -1.65)
Fiji	153 (146 to 159)	22 (17 to 33)	122 (117 to 127)	13 (10 to 18)	275 (266 to 284)	36 (29 to 46)	0.06 (-0.27 to 0.40)	-4.59 (-6.81 to -2.51)	-3.38 (-3.61 to -3.14)	-7.39 (-9.55 to -3.01)	-3.38 (-3.61 to -3.14)	-7.39 (-9.55 to -3.01)
Kiribati	142 (137 to 146)	10 (7 to 15)	123 (119 to 127)	8 (5 to 13)	265 (258 to 272)	18 (13 to 25)	344 (2.90 to 398)	-5.99 (-8.49 to -2.65)	177 (149 to 1.96)	-442 (-6.74 to -2.12)	177 (149 to 1.96)	-442 (-6.74 to -2.12)
Marshall Islands	44 (42 to 47)	3 (2 to 4)	45 (42 to 48)	2 (1 to 4)	89 (85 to 94)	5 (4 to 7)	1.13 (0.54 to 1.75)	-0.90 (-3.42 to 1.88)	0.18 (-0.15 to 0.45)	-4.86 (-7.59 to -1.77)	0.18 (-0.15 to 0.45)	-4.86 (-7.59 to -1.77)
Papua New Guinea	3343 (3217 to 3481)	475 (241 to 1242)	3067 (2954 to 3184)	258 (134 to 765)	6409 (6196 to 6628)	733 (387 to 1938)	-1.30 (-1.80 to -0.81)	-7.41 (-10.18 to -2.60)	1.36 (1.14 to 1.64)	-2.15 (-4.02 to 0.10)	1.36 (1.14 to 1.64)	-2.15 (-4.02 to 0.10)
Samoa	38 (37 to 40)	3 (1 to 7)	28 (26 to 29)	6 (1 to 17)	66 (64 to 69)	10 (2 to 20)	0.12 (-0.18 to 0.39)	-5.63 (-8.20 to -3.08)	-0.65 (-0.9 to -0.41)	-372 (-6.24 to -0.78)	-0.65 (-0.9 to -0.41)	-372 (-6.24 to -0.78)
Solomon Islands	285 (274 to 294)	51 (32 to 77)	279 (267 to 289)	64 (31 to 106)	563 (545 to 580)	115 (67 to 176)	0.65 (0.19 to 1.01)	-3.63 (-5.86 to -1.37)	-0.79 (-0.98 to -0.56)	-3.98 (-6.07 to -1.56)	-0.79 (-0.98 to -0.56)	-3.98 (-6.07 to -1.56)
Tonga	20 (19 to 21)	2 (1 to 2)	16 (15 to 17)	2 (1 to 4)	36 (34 to 38)	4 (3 to 5)	-0.44 (-0.75 to -0.14)	-3.64 (-6.23 to -1.28)	-1.91 (-2.21 to -1.64)	-5.15 (-7.36 to -2.38)	-1.91 (-2.21 to -1.64)	-5.15 (-7.36 to -2.38)

	All ages incidence and deaths (2013)						Annualised rate of change (%)					
	Male population			Female population			2000-2000			2000-13		
	Incidence	Deaths	Total	Incidence	Deaths	Total	Incidence	Deaths	Total	Incidence	Deaths	Total
Vanuatu	63 (60 to 65)	19 (12 to 29)	82 (72 to 94)	68 (66 to 71)	23 (11 to 39)	91 (80 to 102)	42 (25 to 66)	-1.10 (-1.41 to -0.79)	-2.90 (-5 to 22 to -0.49)	0.07 (-0.12 to 0.28)	-0.78 (-1.03 to -0.53)	-4.56 (-6.71 to -1.95)
Central sub-Saharan Africa	114 571 (107 911 to 120 891)	33 525 (25 993 to 41 648)	148 096 (133 904 to 163 539)	87 499 (82 703 to 92 494)	17 485 (13 887 to 21 598)	104 984 (98 816 to 111 172)	51 009 (41 734 to 60 076)	0.63 (0.14 to 1.09)	-0.12 (-1.35 to 1.27)	0.07 (-0.12 to 0.28)	-0.78 (-1.03 to -0.53)	-3.41 (-4.67 to -1.99)
Angola	19 588 (18 242 to 20 956)	5969 (3248 to 9477)	25 557 (21 720 to 29 383)	15 174 (14 016 to 16 231)	2863 (1863 to 4366)	18 037 (16 153 to 19 921)	8832 (5359 to 13 612)	-1.42 (-2.07 to -0.79)	-1.98 (-4.23 to 0.51)	-0.13 (-0.46 to 0.17)	-0.13 (-0.46 to 0.17)	-5.32 (-8.13 to -2.53)
Central African Republic	7034 (6346 to 7738)	2236 (1447 to 2967)	9270 (7899 to 10237)	5389 (4875 to 5960)	1637 (1103 to 2296)	7026 (6012 to 8040)	3873 (2704 to 4851)	1.04 (0.02 to 1.95)	0.03 (-1.58 to 1.56)	-0.65 (-1.20 to -0.17)	-0.65 (-1.20 to -0.17)	-1.87 (-3.39 to -0.30)
Congo	4248 (3927 to 4561)	986 (463 to 1355)	5234 (4590 to 5879)	3486 (3234 to 3753)	354 (179 to 488)	3840 (3415 to 4265)	1340 (665 to 1727)	-0.31 (-0.90 to 0.25)	-0.56 (-2.25 to 1.06)	0.32 (-0.11 to 0.78)	0.32 (-0.11 to 0.78)	-3.13 (-4.78 to -1.42)
DR Congo	79 732 (74 757 to 84 369)	23 672 (17 122 to 31 677)	103 404 (91 879 to 115 079)	60 129 (56 560 to 63 798)	12 414 (9525 to 15 979)	72 543 (66 381 to 78 702)	36 085 (28 514 to 45 093)	1.27 (0.71 to 1.77)	0.54 (-1.12 to 2.69)	0.16 (-0.10 to 0.43)	0.16 (-0.10 to 0.43)	-3.04 (-4.69 to -1.29)
Equatorial Guinea	518 (455 to 575)	164 (49 to 278)	682 (504 to 860)	389 (339 to 433)	93 (29 to 178)	482 (368 to 596)	257 (84 to 422)	-0.71 (-1.43 to -0.14)	-3.80 (-7.15 to -1.08)	0.43 (-0.14 to 0.92)	0.43 (-0.14 to 0.92)	-5.54 (-9.39 to -2.50)
Gabon	3450 (3120 to 3833)	497 (218 to 697)	3947 (3398 to 4504)	2932 (2730 to 3148)	125 (62 to 179)	3057 (2667 to 3447)	623 (299 to 826)	-0.69 (-1.63 to 0.31)	1.59 (-0.73 to 3.64)	1.41 (1.01 to 1.84)	1.41 (1.01 to 1.84)	-2.13 (-3.86 to -0.45)
Eastern sub-Saharan Africa	326 105 (307 524 to 347 855)	100 724 (81 254 to 111 357)	426 829 (388 778 to 464 212)	227 786 (214 817 to 242 641)	70 740 (56 858 to 78 604)	298 526 (261 659 to 335 412)	171 464 (145 647 to 185 375)	-0.99 (-1.42 to -0.54)	-0.67 (-1.82 to 0.09)	-0.34 (-0.52 to -0.16)	-0.34 (-0.52 to -0.16)	-3.08 (-4.12 to -2.40)
Burundi	8469 (7891 to 8974)	5140 (3037 to 7242)	13 609 (10 928 to 16 291)	5083 (4729 to 5420)	2432 (1539 to 3512)	7515 (6268 to 8762)	7572 (5442 to 10 002)	-1.75 (-2.51 to -1.01)	0.90 (-0.79 to 2.79)	-0.71 (-1.22 to -0.20)	-0.71 (-1.22 to -0.20)	-3.35 (-5.09 to -1.71)
Comoros	274 (249 to 298)	252 (140 to 388)	526 (389 to 663)	163 (147 to 179)	130 (77 to 212)	293 (216 to 370)	382 (251 to 530)	-1.51 (-1.93 to -1.07)	1.82 (-0.60 to 4.34)	-0.99 (-1.46 to -0.53)	-0.99 (-1.46 to -0.53)	-1.21 (-3.38 to 0.75)
Djibouti	1238 (1160 to 1318)	249 (131 to 455)	1487 (1189 to 1785)	681 (638 to 722)	124 (49 to 246)	805 (689 to 921)	372 (213 to 649)	2.29 (1.36 to 3.33)	4.84 (1.85 to 7.69)	-1.35 (-1.74 to -0.91)	-1.35 (-1.74 to -0.91)	-2.05 (-4.46 to 0.41)
Eritrea	2443 (2265 to 2637)	1862 (1218 to 2781)	4305 (3483 to 5126)	2138 (1986 to 2301)	1275 (768 to 1967)	3413 (2754 to 4072)	3137 (2364 to 4419)	-2.54 (-3.18 to -1.95)	-3.50 (-7.18 to -0.29)	-0.46 (-0.98 to 0.04)	-0.46 (-0.98 to 0.04)	-0.44 (-2.52 to 2.32)
Ethiopia	65 303 (60 948 to 69 848)	29 593 (23 362 to 36 203)	94 896 (84 310 to 105 206)	51 751 (48 490 to 54 753)	20 595 (16 355 to 25 142)	72 346 (64 945 to 79 747)	50 188 (42 276 to 58 367)	-1.43 (-2.14 to -0.80)	-2.97 (-4.42 to -1.56)	-0.34 (-0.78 to 0.13)	-0.34 (-0.78 to 0.13)	-3.43 (-5.14 to -2.08)

	All ages incidence and deaths (2013)						Annualised rate of change (%)								
	Male population			Female population			Total			1990-2000			2000-13		
	Incidence	Deaths	Incidence	Deaths	Incidence	Deaths	Incidence	Deaths	Incidence	Deaths	Incidence	Deaths	Incidence	Deaths	
Kenya	61 605 (56 119 to 67 928)	11 395 (8667 to 14 118)	44 251 (40 340 to 48 438)	6502 (4931 to 8374)	105 856 (96 915 to 115 666)	17 898 (14 693 to 20 861)	17 898 (14 693 to 20 861)	0.11 (-1.61 to 1.83)	-3.01 (-3.82 to -2.14)	0.91 (0.47 to 1.32)	0.11 (-1.61 to 1.83)	-3.18 (-4.75 to -1.69)	0.91 (0.47 to 1.32)	-3.18 (-4.75 to -1.69)	
Madagascar	28 720 (26 533 to 30 590)	2500 (1536 to 3896)	19 627 (18 101 to 20 984)	1208 (722 to 1901)	48 347 (44 889 to 51 382)	3707 (2528 to 5317)	3707 (2528 to 5317)	-1.68 (-3.78 to 0.22)	348 (2.31 to 4.56)	-0.11 (-0.46 to 0.34)	-1.68 (-3.78 to 0.22)	-2.58 (-4.97 to -0.15)	-0.11 (-0.46 to 0.34)	-2.58 (-4.97 to -0.15)	
Malawi	7370 (6519 to 8387)	4849 (3792 to 6091)	6187 (5510 to 7018)	3453 (2663 to 4329)	13 558 (12 132 to 15 242)	8302 (6970 to 9744)	8302 (6970 to 9744)	145 (-0.12 to 2.81)	-114 (-2.02 to -0.53)	-0.56 (-0.93 to -0.19)	145 (-0.12 to 2.81)	-3.87 (-5.49 to -2.42)	-0.56 (-0.93 to -0.19)	-3.87 (-5.49 to -2.42)	
Mauritius	230 (215 to 246)	12 (9 to 15)	100 (94 to 106)	2 (2 to 3)	330 (312 to 349)	14 (12 to 17)	14 (12 to 17)	-7.88 (-9.06 to -6.43)	-0.94 (-1.36 to -0.46)	-4.31 (-4.68 to -3.94)	-7.88 (-9.06 to -6.43)	-3.18 (-4.76 to -1.55)	-4.31 (-4.68 to -3.94)	-3.18 (-4.76 to -1.55)	
Mozambique	29 668 (25 448 to 34 673)	9214 (7203 to 11 545)	16 854 (14 214 to 19 640)	5735 (4380 to 7257)	46 522 (39 804 to 53 743)	14 950 (12 303 to 17 475)	14 950 (12 303 to 17 475)	-0.97 (-2.56 to 0.60)	-3.04 (-3.98 to -1.98)	-1.81 (-2.31 to -1.17)	-0.97 (-2.56 to 0.60)	-1.94 (-3.39 to -0.57)	-1.81 (-2.31 to -1.17)	-1.94 (-3.39 to -0.57)	
Rwanda	6636 (6158 to 7123)	2827 (1698 to 4085)	4032 (3767 to 4311)	1228 (801 to 1779)	10 668 (10 014 to 11 354)	4055 (2621 to 5504)	4055 (2621 to 5504)	0.81 (-2.22 to 2.74)	143 (0.77 to 2.11)	0.22 (-0.19 to 0.59)	0.81 (-2.22 to 2.74)	-6.62 (-8.51 to -5.03)	0.22 (-0.19 to 0.59)	-6.62 (-8.51 to -5.03)	
Seychelles	45 (41 to 48)	1 (1 to 2)	32 (30 to 34)	0 (0 to 0)	77 (72 to 82)	2 (1 to 2)	2 (1 to 2)	8.54 (-5.51 to 11.90)	-0.07 (-0.55 to 0.52)	-2.18 (-2.58 to -1.75)	8.54 (-5.51 to 11.90)	-2.85 (-4.74 to -1.02)	-2.18 (-2.58 to -1.75)	-2.85 (-4.74 to -1.02)	
Somalia	12 912 (12 172 to 13 747)	3702 (2227 to 6112)	7816 (7323 to 8227)	4964 (2942 to 7757)	20 728 (19 605 to 21 824)	8667 (5501 to 13 266)	8667 (5501 to 13 266)	3.50 (0.65 to 6.21)	0.00 (-0.67 to 0.73)	-0.24 (-0.57 to 0.08)	3.50 (0.65 to 6.21)	-0.04 (-2.14 to 2.61)	-0.24 (-0.57 to 0.08)	-0.04 (-2.14 to 2.61)	
South Sudan	10 187 (9231 to 11 115)	5002 (3165 to 6780)	5276 (4768 to 5726)	3376 (2373 to 4474)	15 463 (14 087 to 16 764)	8378 (6420 to 10 484)	8378 (6420 to 10 484)	2.66 (-1.35 to 5.22)	-0.26 (-1.43 to 0.72)	-1.21 (-2.13 to -0.55)	2.66 (-1.35 to 5.22)	-1.72 (-4.17 to 0.41)	-1.21 (-2.13 to -0.55)	-1.72 (-4.17 to 0.41)	
Tanzania	23 582 (21 502 to 25 681)	10 942 (7615 to 14 080)	16 759 (15 183 to 18 327)	9099 (6309 to 11 620)	40 341 (36 939 to 43 710)	20 041 (14 575 to 24 332)	20 041 (14 575 to 24 332)	0.84 (-0.52 to 2.22)	-0.91 (-1.47 to -0.32)	-0.34 (-0.66 to 0.00)	0.84 (-0.52 to 2.22)	-2.57 (-4.76 to -1.04)	-0.34 (-0.66 to 0.00)	-2.57 (-4.76 to -1.04)	
Uganda	28 674 (25 605 to 31 944)	8923 (5823 to 11 569)	18 418 (16 646 to 20 441)	5815 (3394 to 7326)	47 092 (42 791 to 52 231)	14 738 (9637 to 18 062)	14 738 (9637 to 18 062)	0.46 (-1.22 to 2.04)	0.90 (0.16 to 1.58)	-1.26 (-1.61 to -0.94)	0.46 (-1.22 to 2.04)	-3.76 (-5.20 to -2.24)	-1.26 (-1.61 to -0.94)	-3.76 (-5.20 to -2.24)	
Zambia	26 785 (23 118 to 31 050)	4197 (3120 to 5379)	19 554 (17 143 to 22 604)	4760 (3545 to 5975)	46 339 (40 875 to 53 310)	8957 (7242 to 10 668)	8957 (7242 to 10 668)	3.72 (2.18 to 5.32)	0.05 (-0.60 to 0.63)	0.40 (-0.13 to 0.86)	3.72 (2.18 to 5.32)	-2.56 (-4.03 to -0.99)	0.40 (-0.13 to 0.86)	-2.56 (-4.03 to -0.99)	
Southern sub-Saharan Africa	272 261 (241 833 to 311 989)	23 357 (19 033 to 27 878)	237 413 (209 522 to 273 154)	13 252 (10 527 to 16 642)	509 674 (455 681 to 580 571)	36 609 (31 228 to 41 720)	36 609 (31 228 to 41 720)	1.34 (-0.22 to 2.77)	-474 (-578 to -3.50)	0.14 (-0.26 to 0.54)	1.34 (-0.22 to 2.77)	-4.12 (-5.91 to -2.91)	0.14 (-0.26 to 0.54)	-4.12 (-5.91 to -2.91)	

	All ages incidence and deaths (2013)						Annualised rate of change (%)					
	Male population			Female population			1990-2000			2000-13		
	Incidence	Deaths	Incidence	Deaths	Incidence	Deaths	Incidence	Deaths	Incidence	Deaths	Incidence	Deaths
Botswana	4934 (4205 to 5877)	636 (351 to 996)	4455 (3757 to 5248)	319 (167 to 509)	9389 (8127 to 10 938)	956 (588 to 1428)	-4.85 (-5.75 to -3.67)	4.74 (1.54 to 8.02)	-0.50 (-1.00 to 0.08)	4.74 (1.54 to 8.02)	-0.50 (-1.00 to 0.08)	-6.62 (-9.80 to -3.70)
Lesotho	3723 (3283 to 4338)	1887 (1426 to 2373)	2712 (2373 to 3188)	1539 (979 to 2165)	6435 (5692 to 7474)	3425 (2662 to 4196)	-4.01 (-5.27 to -2.51)	5.45 (3.63 to 7.17)	4.05 (3.77 to 4.32)	5.45 (3.63 to 7.17)	4.05 (3.77 to 4.32)	-1.52 (-2.68 to -0.46)
Namibia	5530 (4773 to 6358)	1419 (1050 to 1840)	4716 (4055 to 5397)	771 (580 to 976)	10 246 (8987 to 11 696)	2189 (1775 to 2654)	-2.07 (-3.18 to -0.80)	2.91 (1.43 to 4.46)	0.74 (0.38 to 1.15)	2.91 (1.43 to 4.46)	0.74 (0.38 to 1.15)	-3.39 (-4.78 to -2.01)
South Africa	217 545 (192 039 to 249 900)	13 138 (10 056 to 16 480)	190 831 (166 974 to 221 264)	6779 (4934 to 9016)	408 376 (363 668 to 466 379)	19 918 (16 269 to 23 639)	-5.44 (-6.61 to -4.11)	0.93 (-1.12 to 2.79)	-0.08 (-0.53 to 0.40)	0.93 (-1.12 to 2.79)	-0.08 (-0.53 to 0.40)	-6.08 (-8.53 to -4.44)
Swaziland	3426 (2949 to 4025)	652 (395 to 865)	3086 (2639 to 3705)	563 (304 to 828)	6512 (5645 to 7658)	1215 (752 to 1536)	-4.20 (-5.44 to -2.71)	6.31 (4.21 to 8.34)	3.04 (2.62 to 3.46)	6.31 (4.21 to 8.34)	3.04 (2.62 to 3.46)	-3.49 (-4.98 to -1.90)
Zimbabwe	37 104 (32 309 to 42 857)	5625 (3921 to 8124)	31 613 (27 725 to 36 707)	3280 (2078 to 4815)	68 717 (60 653 to 78 743)	8905 (6790 to 11 779)	-4.38 (-5.13 to -3.64)	173 (-0.26 to 3.54)	2.64 (2.11 to 3.17)	173 (-0.26 to 3.54)	2.64 (2.11 to 3.17)	1.30 (-0.94 to 3.71)
Western sub-Saharan Africa	255 207 (242 139 to 268 854)	53 088 (43 739 to 65 410)	149 320 (141 150 to 157 043)	34 426 (29 093 to 40 604)	404 527 (384 745 to 425 437)	87 515 (77 221 to 101 345)	-0.33 (-0.79 to 0.14)	-0.84 (-1.71 to -0.01)	-0.57 (-0.73 to -0.39)	-0.84 (-1.71 to -0.01)	-0.57 (-0.73 to -0.39)	-3.09 (-3.84 to -2.17)
Benin	6698 (6330 to 7098)	1521 (1102 to 2066)	3663 (3461 to 3858)	661 (455 to 855)	10 361 (9842 to 10 892)	2181 (1687 to 2775)	-0.81 (-1.41 to -0.29)	-0.89 (-2.59 to 0.70)	-0.60 (-0.90 to -0.27)	-0.89 (-2.59 to 0.70)	-0.60 (-0.90 to -0.27)	-1.17 (-2.68 to 0.27)
Burkina Faso	8129 (7660 to 8652)	2690 (1939 to 3409)	4308 (4084 to 4545)	2248 (1603 to 2909)	12 437 (11 811 to 13 118)	4938 (3773 to 5839)	-0.68 (-1.27 to -0.12)	-0.62 (-2.08 to 0.81)	-0.14 (-0.64 to 0.37)	-0.62 (-2.08 to 0.81)	-0.14 (-0.64 to 0.37)	-0.27 (-3.18 to 1.27)
Cameroon	22 407 (20 502 to 24 548)	2837 (2162 to 3887)	14 476 (13 221 to 15 747)	1748 (1132 to 2228)	36 883 (33 889 to 40 082)	4585 (3672 to 5728)	-0.60 (-1.61 to 0.37)	1.33 (-0.23 to 2.86)	-0.58 (-0.85 to -0.34)	1.33 (-0.23 to 2.86)	-0.58 (-0.85 to -0.34)	-2.55 (-3.99 to -0.96)
Cape Verde	534 (498 to 573)	30 (16 to 48)	238 (222 to 255)	12 (4 to 19)	772 (725 to 822)	41 (23 to 63)	-0.19 (-0.72 to 0.42)	-2.22 (-5.07 to 0.79)	-0.61 (-0.95 to -0.25)	-2.22 (-5.07 to 0.79)	-0.61 (-0.95 to -0.25)	-5.03 (-7.79 to -2.43)
Chad	11 187 (10 264 to 12 122)	2390 (1692 to 3397)	6101 (5677 to 6570)	2690 (1739 to 3764)	17 288 (16 059 to 18 602)	5079 (3874 to 6266)	-1.62 (-2.29 to -0.99)	0.88 (-0.73 to 2.45)	0.60 (0.21 to 1.00)	0.88 (-0.73 to 2.45)	0.60 (0.21 to 1.00)	-1.31 (-2.73 to 0.12)
Cote d'Ivoire	17 640 (16 340 to 19 048)	4389 (3289 to 5529)	11 389 (10 512 to 12 294)	2138 (1379 to 2701)	29 029 (27 031 to 31 250)	6526 (4957 to 7802)	-0.47 (-1.24 to 0.28)	0.76 (-1.02 to 2.61)	-0.74 (-1.15 to -0.32)	0.76 (-1.02 to 2.61)	-0.74 (-1.15 to -0.32)	-1.35 (-2.69 to 0.02)

	All ages incidence and deaths (2013)						Annualised rate of change (%)					
	Male population			Female population			2000-2000			2000-13		
	Incidence	Deaths	Incidence	Deaths	Incidence	Deaths	Incidence	Deaths	Incidence	Deaths	Incidence	Deaths
Ghana	12 926 (12 176 to 13 666)	2359 (1804 to 3219)	7499 (7080 to 7894)	1270 (945 to 1681)	20 426 (19 330 to 21 464)	3629 (2962 to 4525)	-0.55 (-1.25 to 0.07)	-566 (-7.58 to -376)	-2.16 (-2.49 to -1.85)	-5.38 (-6.98 to -3.21)		
Guinea	10 887 (10 170 to 11 592)	1874 (1374 to 2509)	5891 (5511 to 6272)	1605 (1072 to 2321)	16 778 (15 772 to 17 779)	3479 (2696 to 4378)	0.73 (0.14 to 1.33)	-0.74 (-2.32 to 1.01)	-1.44 (-1.79 to -1.10)	-0.68 (-2.04 to 0.69)		
Guinea-Bissau	1887 (1707 to 2058)	406 (286 to 591)	1244 (1131 to 1356)	284 (189 to 402)	3131 (2855 to 3399)	690 (497 to 984)	-0.86 (-1.53 to -0.16)	140 (-1.17 to 4.00)	0.15 (-0.41 to 0.69)	-1.20 (-3.81 to 1.42)		
Liberia	5762 (5418 to 6140)	837 (595 to 1212)	4623 (4347 to 4890)	557 (388 to 742)	10 384 (9849 to 10 944)	1394 (1081 to 1843)	-0.29 (-1.17 to 0.61)	0.72 (-1.11 to 2.93)	1.76 (1.38 to 2.16)	-1.69 (-3.23 to -0.22)		
Mali	7940 (7504 to 8410)	2682 (1849 to 3673)	4349 (4132 to 4591)	1368 (972 to 1939)	12 289 (11 653 to 12 912)	4050 (3212 to 5232)	-1.06 (-1.68 to -0.50)	-2.09 (-3.54 to -0.47)	-0.24 (-0.55 to 0.14)	-1.21 (-2.69 to 0.27)		
Mauritania	7172 (6635 to 7684)	503 (329 to 759)	3234 (2976 to 3463)	321 (200 to 483)	10 406 (9667 to 11 067)	824 (589 to 1108)	-0.01 (-0.69 to 0.59)	-2.63 (-5.32 to -0.46)	0.42 (0.08 to 0.75)	-2.27 (-3.86 to -0.95)		
Niger	13 239 (12 554 to 13 971)	3151 (2391 to 4336)	5498 (5251 to 5759)	2218 (1695 to 2844)	18 737 (17 926 to 19 676)	5369 (4389 to 6650)	0.32 (-0.27 to 0.90)	-0.81 (-2.45 to 0.62)	-0.33 (-0.71 to 0.00)	-1.95 (-3.43 to -0.45)		
Nigeria	97 302 (89 158 to 105 772)	22 730 (15 211 to 31 509)	59 901 (54 701 to 65 227)	14 719 (10 135 to 20 468)	157 203 (145 193 to 169 957)	37 449 (28 903 to 48 392)	-0.24 (-0.94 to 0.42)	-0.64 (-2.26 to 0.79)	-0.84 (-1.21 to -0.44)	-4.22 (-5.82 to -2.52)		
Sao Tome and Principe	111 (89 to 120)	9 (5 to 15)	75 (67 to 79)	4 (2 to 6)	186 (157 to 199)	13 (8 to 19)	0.50 (-0.74 to 1.40)	-1.80 (-4.37 to 0.61)	-0.59 (-1.18 to -0.24)	-2.70 (-5.55 to -0.04)		
Senegal	12 866 (12 178 to 13 535)	2252 (1492 to 3041)	6142 (5851 to 6455)	1369 (824 to 1953)	19 008 (18 120 to 19 896)	3621 (2596 to 4579)	-0.07 (-0.50 to 0.33)	-1.79 (-3.53 to -0.06)	-0.81 (-1.10 to -0.48)	-2.28 (-3.62 to -0.86)		
Sierra Leone	13 131 (12 244 to 14 006)	1393 (964 to 1976)	7366 (6836 to 7836)	593 (435 to 778)	20 497 (19 213 to 21 774)	1986 (1522 to 2579)	0.99 (0.35 to 1.62)	1.67 (-0.21 to 3.51)	1.09 (0.69 to 1.48)	-2.20 (-3.70 to -0.55)		
The Gambia	2059 (1941 to 2172)	204 (111 to 334)	1088 (1024 to 1151)	88 (49 to 141)	3147 (2978 to 3308)	292 (161 to 474)	-0.13 (-0.53 to 0.31)	-0.23 (-2.91 to 2.39)	0.32 (0.08 to 0.55)	-2.19 (-4.47 to 0.28)		
Togo	3325 (3074 to 3607)	832 (562 to 1231)	2232 (2060 to 2388)	534 (388 to 718)	5558 (5161 to 5966)	1366 (1038 to 1789)	-1.42 (-2.23 to -0.63)	-0.83 (-2.41 to 0.83)	0.51 (0.22 to 0.81)	-2.43 (-4.10 to -0.63)		

Data in parentheses are 95% uncertainty intervals.

Table 6
Age-standardised malaria incidence and mortality rates and annualised rates of change
for both sexes for 16 Global Burden of Disease regions

	Age-standardised rates in 2003 (per 100 000 population)		Annualised rate of change (%)			
	Incidence	Mortality	1990–2000		2000–13	
			Incidence	Mortality	Incidence	Mortality
Worldwide	2360.42 (1373.81 to 4051.98)	11.78 (9.69 to 14.21)	0.26 (–1.02 to 1.12)	1.96 (0.84 to 3.06)	–3.27 (–4.99 to –1.18)	–3.11 (–4.72 to –1.60)
High-income Asia Pacific	0.40 (0.34 to 0.47)	0.00 (0.00 to 0.00)	–8.48 (–9.93 to –7.09)	–18.55 (–19.35 to –17.73)	–1.67 (–2.28 to –1.18)	–16.79 (–17.75 to –15.86)
Central Asia	0.19 (0.16 to 0.21)	0.02 (0.01 to 0.03)	16.77 (15.48 to 18.21)	–4.84 (–9.03 to –0.29)	–38.41 (–39.92 to –37.09)	–7.32 (–10.76 to –3.15)
East Asia	0.23 (0.20 to 0.25)	0.01 (0.01 to 0.01)	–0.60 (–1.44 to 0.36)	–7.67 (–9.34 to –6.02)	–19.91 (–20.96 to –18.98)	–10.95 (–13.09 to –8.36)
South Asia	4428.64 (1639.86 to 10 388.82)	9.08 (7.00 to 11.73)	–2.00 (–3.78 to –0.81)	–2.65 (–4.27 to –0.91)	–3.33 (–4.67 to –1.81)	–3.39 (–5.45 to –1.31)
Southeast Asia	1231.49 (556.12 to 2635.04)	2.28 (1.68 to 3.15)	–3.89 (–5.56 to –2.16)	–4.54 (–6.53 to –2.65)	–5.88 (–8.59 to –3.01)	–6.89 (–9.01 to –4.25)
Caribbean	245.54 (227.17 to 263.02)	0.91 (0.51 to 1.47)	–3.35 (–3.63 to –3.05)	–4.52 (–6.90 to –1.78)	–4.08 (–4.64 to –3.53)	–7.48 (–11.51 to –3.38)
Andean Latin America	49.36 (42.60 to 55.80)	0.04 (0.03 to 0.05)	–2.53 (–3.04 to –2.04)	–5.70 (–7.28 to –4.09)	–2.79 (–3.64 to –2.05)	–13.80 (–15.92 to –11.45)
Central Latin America	46.12 (40.32 to 51.63)	0.05 (0.04 to 0.07)	–2.29 (–2.75 to –1.85)	–5.58 (–7.13 to –4.18)	–2.10 (–2.76 to –1.51)	–10.06 (–12.13 to –7.34)
Southern Latin America	0.95 (0.81 to 1.08)	0.00 (0.00 to 0.00)	–9.52 (–10.71 to –8.32)	–16.26 (–17.13 to –15.40)	–3.21 (–4.06 to –2.48)	–16.29 (–17.17 to –15.43)
Tropical Latin America	62.80 (53.39 to 71.76)	0.03 (0.02 to 0.05)	–6.49 (–7.87 to –5.20)	–17.58 (–19.80 to –15.41)	–0.11 (–0.50 to 0.21)	–9.20 (–12.22 to –5.86)
North Africa and Middle East	396.71 (122.46 to 1028.80)	1.97 (1.07 to 3.48)	2.14 (1.31 to 3.18)	3.88 (0.73 to 7.01)	–5.74 (–9.08 to –2.40)	–7.07 (–10.62 to –3.04)
Oceania	10 452.65 (3908.47 to 25 253.80)	20.54 (11.95 to 33.16)	–0.02 (–0.25 to 0.19)	–0.30 (–3.70 to 2.75)	–2.14 (–3.14 to –1.05)	–2.61 (–5.49 to 0.65)
Central sub-Saharan Africa	6628.47 (3171.03 to 13 240.91)	43.15 (28.36 to 63.55)	–2.74 (–4.45 to –1.39)	–1.59 (–4.08 to 1.08)	–5.13 (–7.81 to –2.43)	–5.73 (–9.03 to –2.28)
Eastern sub-Saharan Africa	6411.66 (3214.47 to 12 802.02)	39.58 (33.03 to 49.36)	0.41 (–0.29 to 1.52)	0.77 (–0.82 to 2.33)	–6.68 (–8.94 to –3.58)	–6.76 (–8.47 to –4.40)

	<u>Age-standardised rates in 2003 (per 100 000 population)</u>		<u>Annualised rate of change (%)</u>			
	Incidence	Mortality	1990–2000		2000–13	
			Incidence	Mortality	Incidence	Mortality
Southern sub-Saharan Africa	766.01 (315.25 to 1807.70)	4.21 (3.22 to 5.76)	2.84 (1.28 to 4.19)	2.85 (−0.40 to 5.45)	−5.63 (−8.37 to −2.64)	−7.30 (−9.74 to −4.10)
Western sub-Saharan Africa	11 874.88 (6907.10 to 20 684.35)	85.89 (68.14 to 105.95)	0.90 (0.26 to 1.72)	1.45 (−0.24 to 3.18)	−3.79 (−5.33 to −2.00)	−3.40 (−5.15 to −1.56)

Data in parentheses are 95% uncertainty intervals.

Table 7
Malaria incidence and deaths for all ages by sex and annualised rates of change for 16 Global Burden of Disease regions and 105 countries

	All ages incidence and deaths (2013)						Annualised rate of change (%)												
	Male population			Female population			Total			1990-2000			2000-13						
	Incidence	Deaths	Deaths	Incidence	Deaths	Deaths	Incidence	Deaths	Deaths	Incidence	Deaths	Deaths	Incidence	Deaths	Deaths				
Worldwide	80 442 176 (46 672 036 to 138 440 048)	434 792 (337 311 to 564 653)	419 777 (341 821 to 517 091)	84 487 696 (48 637 128 to 145 153 824)	419 777 (341 820 to 517 091)	854 568 (702 884 to 1 032 471)	164 929 872 (95 399 904 to 284 354 624)	164 929 872 (95 399 192 to 284 353 920)	164 929 872 (95 399 192 to 284 353 920)	0 (0 to 2)	0 (0 to 2)	0 (0 to 2)	0.26 (-1.02 to 1.12)	1.96 (0.84 to 3.06)	-3.11 (-4.72 to -1.60)	-2.13 (-1.63 to -2.74)	-3.27 (-4.99 to -1.18)	-3.45 (-1.35 to -5.15)	-3.29 (-1.84 to -4.85)
Developed countries	357 (305 to 405)	0 (0 to 1)	0 (0 to 1)	357 (304 to 407)	0 (0 to 1)	0 (0 to 2)	713 (609 to 812)	713 (609 to 812)	713 (609 to 812)	0 (0 to 2)	0 (0 to 2)	0 (0 to 2)	-8.36 (-9.74 to -7.03)	-17.90 (-18.68 to -17.07)	-16.22 (-15.27 to -17.20)	-2.13 (-1.63 to -2.74)	-2.13 (-1.63 to -2.74)	-2.13 (-1.63 to -2.74)	-16.22 (-15.27 to -17.20)
Developing countries	80 441 816 (46 672 684 to 138 439 696)	434 792 (337 311 to 564 653)	419 776 (341 820 to 517 091)	84 487 336 (48 636 776 to 145 153 472)	419 776 (341 820 to 517 091)	854 568 (702 884 to 1 032 470)	164 929 152 (95 399 192 to 284 353 920)	164 929 152 (95 399 192 to 284 353 920)	164 929 152 (95 399 192 to 284 353 920)	0 (0 to 2)	0 (0 to 2)	0 (0 to 2)	-0.21 (-1.75 to 0.75)	1.49 (0.43 to 2.53)	-3.29 (-1.84 to -4.85)	-3.45 (-1.35 to -5.15)	-3.45 (-1.35 to -5.15)	-3.45 (-1.35 to -5.15)	-3.29 (-1.84 to -4.85)
High-income Asia Pacific	357 (305 to 405)	0 (0 to 1)	0 (0 to 1)	357 (304 to 407)	0 (0 to 1)	0 (0 to 2)	713 (609 to 812)	713 (609 to 812)	713 (609 to 812)	0 (0 to 2)	0 (0 to 2)	0 (0 to 2)	-8.48 (-9.93 to -7.09)	-18.55 (-19.35 to -17.73)	-16.79 (-17.75 to -15.86)	-1.67 (-2.28 to -1.18)	-1.67 (-2.28 to -1.18)	-1.67 (-2.28 to -1.18)	-16.79 (-17.75 to -15.86)
South Korea	357 (305 to 405)	0 (0 to 1)	0 (0 to 1)	357 (304 to 407)	0 (0 to 1)	0 (0 to 2)	713 (609 to 812)	713 (609 to 812)	713 (609 to 812)	0 (0 to 2)	0 (0 to 2)	0 (0 to 2)	-10.95 (-12.29 to -9.59)	-18.68 (-19.49 to -17.87)	-18.02 (-17.09-18.94)	-3.08 (-2.37 to -3.92)	-3.08 (-2.37 to -3.92)	-3.08 (-2.37 to -3.92)	-18.02 (-17.09-18.94)
Central Asia	78 (68 to 87)	8 (4 to 16)	9 (5 to 15)	77 (67 to 87)	9 (5 to 15)	17 (12 to 28)	155 (135 to 174)	155 (135 to 174)	155 (135 to 174)	17 (12 to 28)	17 (12 to 28)	17 (12 to 28)	16.77 (15.48 to 18.21)	-4.84 (-9.03 to -0.29)	-7.32 (-10.76 to -3.15)	-38.41 (-39.92 to -37.09)	-38.41 (-39.92 to -37.09)	-38.41 (-39.92 to -37.09)	-7.32 (-10.76 to -3.15)
Armenia	0 (0 to 0)	0 (0 to 0)	0 (0 to 0)	0 (0 to 0)	0 (0 to 0)	0 (0 to 0)	0 (0 to 0)	0 (0 to 0)	0 (0 to 0)	0 (0 to 0)	0 (0 to 0)	0 (0 to 0)	-9.57 (-10.69 to -8.41)	-15.72 (-16.70 to -14.75)	0.00 (0.00 to 0.00)	0.00 (0.00 to 0.00)	0.00 (0.00 to 0.00)	0.00 (0.00 to 0.00)	0.00 (0.00 to 0.00)
Azerbaijan	69 (59 to 78)	0 (0 to 0)	0 (0 to 0)	68 (58 to 78)	0 (0 to 0)	0 (0 to 0)	137 (117 to 156)	137 (117 to 156)	137 (117 to 156)	0 (0 to 0)	0 (0 to 0)	0 (0 to 0)	-10.20 (-11.30 to -9.07)	-15.90 (-16.85 to -15.01)	-16.58 (-17.75 to -15.39)	-3.97 (-4.94 to -3.13)	-3.97 (-4.94 to -3.13)	-3.97 (-4.94 to -3.13)	-16.58 (-17.75 to -15.39)
Georgia	0 (0 to 0)	0 (0 to 0)	0 (0 to 0)	0 (0 to 0)	0 (0 to 0)	0 (0 to 0)	0 (0 to 0)	0 (0 to 0)	0 (0 to 0)	0 (0 to 0)	0 (0 to 0)	0 (0 to 0)	-9.75 (-10.91 to -8.56)	-16.20 (-17.20 to -15.16)	0.00 (0.00 to 0.00)	0.00 (0.00 to 0.00)	0.00 (0.00 to 0.00)	0.00 (0.00 to 0.00)	0.00 (0.00 to 0.00)
Kyrgyzstan	0 (0 to 0)	0 (0 to 0)	0 (0 to 0)	0 (0 to 0)	0 (0 to 0)	0 (0 to 0)	0 (0 to 0)	0 (0 to 0)	0 (0 to 0)	0 (0 to 0)	0 (0 to 0)	0 (0 to 0)	-41.62 (-42.09 to -41.15)	-14.46 (-15.47 to -13.49)	0.00 (0.00 to 0.00)	0.00 (0.00 to 0.00)	0.00 (0.00 to 0.00)	0.00 (0.00 to 0.00)	0.00 (0.00 to 0.00)
Tajikistan	9 (9 to 9)	8 (4 to 16)	9 (9 to 9)	9 (9 to 9)	9 (9 to 9)	17 (12 to 28)	18 (18 to 18)	18 (18 to 18)	18 (18 to 18)	17 (12 to 28)	17 (12 to 28)	17 (12 to 28)	35.20 (34.62 to 35.73)	-3.24 (-6.10 to -0.23)	-7.05 (-9.62 to -3.93)	-55.80 (-56.25 to -55.19)	-55.80 (-56.25 to -55.19)	-55.80 (-56.25 to -55.19)	-7.05 (-9.62 to -3.93)

	All ages incidence and deaths (2013)																
	Male population				Female population				Total								
	Incidence	Deaths	Incidence	Deaths	Incidence	Deaths	Incidence	Deaths	Incidence	Deaths	Incidence	Deaths					
Turkmenistan	0 (0 to 0)	0 (0 to 0)	0 (0 to 0)	0 (0 to 0)	0 (0 to 0)	0 (0 to 0)	0 (0 to 0)	0 (0 to 0)	0 (0 to 0)	0 (0 to 0)	0 (0 to 0)	0 (0 to 0)	0 (0 to 0)	0 (0 to 0)	0 (0 to 0)	0 (0 to 0)	0 (0 to 0)
Uzbekistan	0 (0 to 0)	0 (0 to 0)	0 (0 to 0)	0 (0 to 0)	0 (0 to 0)	0 (0 to 0)	0 (0 to 0)	0 (0 to 0)	0 (0 to 0)	0 (0 to 0)	0 (0 to 0)	0 (0 to 0)	0 (0 to 0)	0 (0 to 0)	0 (0 to 0)	0 (0 to 0)	0 (0 to 0)
East Asia	1215 (1110 to 1313)	88 (73 to 108)	1283 (1178 to 1379)	56 (45 to 73)	2498 (2299 to 2666)	144 (124 to 168)	0 (0 to 0)	0 (0 to 0)	0 (0 to 0)	0 (0 to 0)	144 (124 to 168)	0 (0 to 0)	0 (0 to 0)	0 (0 to 0)	0 (0 to 0)	0 (0 to 0)	0 (0 to 0)
China	1029 (928 to 1124)	88 (73 to 108)	1091 (987 to 1187)	56 (45 to 72)	2121 (1925 to 2281)	144 (123 to 168)	0 (0 to 0)	0 (0 to 0)	0 (0 to 0)	0 (0 to 0)	144 (123 to 168)	0 (0 to 0)	0 (0 to 0)	0 (0 to 0)	0 (0 to 0)	0 (0 to 0)	0 (0 to 0)
North Korea	185 (161 to 209)	0 (0 to 1)	192 (167 to 217)	0 (0 to 1)	377 (328 to 425)	0 (0 to 1)	0 (0 to 1)	0 (0 to 1)	0 (0 to 1)	0 (0 to 1)	0 (0 to 1)	0 (0 to 1)	0 (0 to 1)	0 (0 to 1)	0 (0 to 1)	0 (0 to 1)	0 (0 to 1)
South Asia	28 475 300 (10 587 800 to 67 635 616)	56 349 (37 151 to 77 226)	33 375 982 (13 386 620 to 76 448 012)	65 428 (48 800 to 88 397)	61 849 284 (24 099 755 to 145 007 704)	121 777 (95 871 to 155 492)	0 (0 to 0)	0 (0 to 0)	0 (0 to 0)	0 (0 to 0)	121 777 (95 871 to 155 492)	0 (0 to 0)	0 (0 to 0)	0 (0 to 0)	0 (0 to 0)	0 (0 to 0)	0 (0 to 0)
Afghanistan	61 979 (52 009 to 72 293)	490 (191 to 1019)	156 053 (129 086 to 184 258)	1292 (436 to 3052)	218 032 (181 117 to 256 551)	1783 (821 to 3659)	0 (0 to 0)	0 (0 to 0)	0 (0 to 0)	0 (0 to 0)	1783 (821 to 3659)	0 (0 to 0)	0 (0 to 0)	0 (0 to 0)	0 (0 to 0)	0 (0 to 0)	0 (0 to 0)
Bangladesh	98 380 (82 421 to 113 840)	19 (10 to 29)	95 500 (79 870 to 110 636)	13 (9 to 19)	193 880 (162 292 to 224 476)	32 (23 to 43)	0 (0 to 0)	0 (0 to 0)	0 (0 to 0)	0 (0 to 0)	32 (23 to 43)	0 (0 to 0)	0 (0 to 0)	0 (0 to 0)	0 (0 to 0)	0 (0 to 0)	0 (0 to 0)
Bhutan	2330 (2095 to 2541)	5 (2 to 12)	1901 (1693 to 2091)	4 (2 to 9)	4231 (3783 to 4628)	9 (4 to 18)	0 (0 to 0)	0 (0 to 0)	0 (0 to 0)	0 (0 to 0)	9 (4 to 18)	0 (0 to 0)	0 (0 to 0)	0 (0 to 0)	0 (0 to 0)	0 (0 to 0)	0 (0 to 0)
India	27 961 284 (10 074 561 to 67 098 740)	54 179 (35 494 to 74 975)	32 739 706 (12 716 841 to 75 811 540)	62 143 (45 048 to 85 171)	60 700 992 (22 931 083 to 143 871 240)	116 322 (90 658 to 149 612)	0 (0 to 0)	0 (0 to 0)	0 (0 to 0)	0 (0 to 0)	116 322 (90 658 to 149 612)	0 (0 to 0)	0 (0 to 0)	0 (0 to 0)	0 (0 to 0)	0 (0 to 0)	0 (0 to 0)
Nepal	29 278 (24 657 to 34 027)	228 (47 to 605)	31 161 (26 244 to 36 214)	243 (48 to 725)	60 439 (50 901 to 70 240)	471 (207 to 983)	0 (0 to 0)	0 (0 to 0)	0 (0 to 0)	0 (0 to 0)	471 (207 to 983)	0 (0 to 0)	0 (0 to 0)	0 (0 to 0)	0 (0 to 0)	0 (0 to 0)	0 (0 to 0)
Pakistan	322 049 (296 287 to 347 753)	1427 (668 to 3316)	349 662 (319 168 to 380 514)	1733 (1023 to 2640)	671 710 (615 243 to 727 902)	3159 (2008 to 5012)	0 (0 to 0)	0 (0 to 0)	0 (0 to 0)	0 (0 to 0)	3159 (2008 to 5012)	0 (0 to 0)	0 (0 to 0)	0 (0 to 0)	0 (0 to 0)	0 (0 to 0)	0 (0 to 0)
Southeast Asia	4 132 009 (1 852 612 to 8 988 789)	7763 (5510 to 10 731)	3 646 243 (1 692 229 to 7 606 561)	6454 (4571 to 9267)	7 778 252 (3 535 079 to 16 619 553)	14 217 (10 315 to 19 781)	0 (0 to 0)	0 (0 to 0)	0 (0 to 0)	0 (0 to 0)	14 217 (10 315 to 19 781)	0 (0 to 0)	0 (0 to 0)	0 (0 to 0)	0 (0 to 0)	0 (0 to 0)	0 (0 to 0)

	All ages incidence and deaths (2013)						Annualised rate of change (%)								
	Male population			Female population			Total			1990-2000			2000-13		
	Incidence	Deaths	Incidence	Deaths	Incidence	Deaths	Incidence	Deaths	Incidence	Deaths	Incidence	Deaths	Incidence	Deaths	
Cambodia	81 263 (68 959 to 93 966)	616 (320 to 1034)	59 358 (50 948 to 67 993)	426 (232 to 731)	140 621 (119 933 to 161 846)	1043 (644 to 1568)	-1.39 (-1.41 to -1.37)	-1.44 (-4.84 to 1.64)	-7.65 (-7.83 to -7.42)	-1.44 (-4.84 to 1.64)	-7.65 (-7.83 to -7.42)	-8.39 (-10.95 to -5.47)			
Indonesia	1 076 361 (191 105 to 3 596 748)	1802 (1320 to 2434)	927 470 (158 478 to 3 289 462)	1341 (1002 to 1749)	2 003 831 (354 339 to 6 883 029)	3143 (2418 to 4019)	-3.60 (-5.19 to -1.74)	-3.37 (-5.99 to -0.89)	-5.34 (-7.67 to -2.76)	-3.37 (-5.99 to -0.89)	-5.34 (-7.67 to -2.76)	-5.19 (-7.51 to -2.46)			
Laos	19 132 (17 423 to 20 734)	50 (16 to 104)	19 817 (18 099 to 21 419)	55 (17 to 148)	38 949 (35 519 to 42 170)	105 (47 to 227)	-3.07 (-3.54 to -2.62)	-5.53 (-10.64 to -1.69)	-1.71 (-1.99 to -1.45)	-5.53 (-10.64 to -1.69)	-1.71 (-1.99 to -1.45)	-3.57 (-8.86 to 0.19)			
Malaysia	63 361 (53 065 to 73 334)	11 (8 to 19)	65 962 (55 033 to 76 567)	3 (3 to 5)	129 323 (108 082 to 149 901)	15 (10 to 23)	-0.16 (-0.36 to 0.01)	-7.42 (-10.01 to -4.96)	-0.01 (-0.11 to 0.07)	-7.42 (-10.01 to -4.96)	-0.01 (-0.11 to 0.07)	-9.15 (-12.65 to -4.74)			
Myanmar	2 459 973 (906 379 to 5 902 743)	4834 (2817 to 7915)	2 156 398 (835 746 to 4 950 837)	4322 (2610 to 7099)	4 616 371 (1 764 904 to 10 796 693)	9155 (5590 to 14 544)	-3.55 (-5.33 to -1.76)	-3.76 (-6.69 to -0.96)	-6.36 (-9.39 to -3.22)	-3.76 (-6.69 to -0.96)	-6.36 (-9.39 to -3.22)	-6.61 (-9.46 to -3.31)			
Philippines	283 519 (241 103 to 323 938)	155 (105 to 233)	273 023 (229 455 to 315 173)	75 (50 to 105)	556 542 (470 324 to 639 165)	230 (166 to 326)	-2.47 (-3.22 to -1.83)	-12.12 (-13.41 to -10.84)	-0.29 (-0.49 to -0.12)	-12.12 (-13.41 to -10.84)	-0.29 (-0.49 to -0.12)	-6.69 (-9.40 to -3.80)			
Sri Lanka	1475 (1246 to 1710)	11 (7 to 21)	1259 (1070 to 1453)	9 (6 to 16)	2734 (2316 to 3165)	21 (14 to 34)	-10.46 (-10.49 to -10.42)	-10.62 (-14.16 to -7.17)	-14.14 (-14.34 to -13.90)	-10.62 (-14.16 to -7.17)	-14.14 (-14.34 to -13.90)	-14.99 (-18.77 to -10.59)			
Thailand	83 572 (72 401 to 94 358)	78 (45 to 136)	82 312 (69 822 to 94 242)	41 (29 to 58)	165 884 (142 197 to 188 453)	118 (78 to 184)	-8.27 (-9.64 to -6.94)	-17.72 (-19.18 to -16.20)	-1.64 (-2.15 to -1.21)	-17.72 (-19.18 to -16.20)	-1.64 (-2.15 to -1.21)	-11.32 (-14.38 to -7.50)			
Timor-Leste	9968 (8560 to 11 314)	7 (0 to 70)	10 356 (9075 to 11 576)	13 (0 to 69)	20 324 (17 664 to 22 892)	21 (3 to 108)	-4.39 (-5.00 to -3.78)	-7.90 (-13.71 to -2.64)	-4.15 (-5.12 to -3.30)	-7.90 (-13.71 to -2.64)	-4.15 (-5.12 to -3.30)	-15.40 (-32.58 to -3.97)			
Vietnam	47 663 (44 070 to 51 177)	187 (119 to 275)	45 016 (41 641 to 48 218)	159 (106 to 237)	92 679 (85 719 to 99 315)	345 (248 to 460)	-4.58 (-4.87 to -4.25)	-5.75 (-8.86 to -2.80)	-5.99 (-6.74 to -5.23)	-5.75 (-8.86 to -2.80)	-5.99 (-6.74 to -5.23)	-10.07 (-12.95 to -6.79)			
Caribbean	50 098 (46 165 to 53 745)	165 (18 to 371)	59 643 (55 171 to 64 155)	239 (67 to 548)	109 741 (101 549 to 117 526)	404 (227 to 643)	-3.35 (-3.63 to -3.05)	-4.52 (-6.90 to -1.78)	-4.08 (-4.64 to -3.53)	-4.52 (-6.90 to -1.78)	-4.08 (-4.64 to -3.53)	-7.48 (-11.51 to -3.38)			
Belize	18 (18 to 19)	1 (1 to 2)	19 (18 to 19)	0 (0 to 1)	37 (37 to 37)	1 (1 to 2)	-9.26 (-9.66 to -8.83)	3.53 (0.26 to 6.57)	-30.58 (-31.09 to -30.08)	-9.26 (-9.66 to -8.83)	-30.58 (-31.09 to -30.08)	-9.26 (-13.68 to -4.65)			
Dominican Republic	5029 (4326 to 5699)	4 (2 to 7)	5075 (4382 to 5736)	4 (3 to 8)	10 104 (8707 to 11 435)	8 (5 to 13)	-1.48 (-1.64 to -1.35)	-4.33 (-7.40 to -1.63)	-1.01 (-1.10 to -0.93)	-4.33 (-7.40 to -1.63)	-1.01 (-1.10 to -0.93)	-3.42 (-7.70 to 0.73)			

	All ages incidence and deaths (2013)											
	Male population				Female population				Total			
	Incidence	Deaths	Incidence	Deaths	Incidence	Deaths	Incidence	Deaths	Incidence	Deaths	Incidence	Deaths
Guyana	2825 (2453 to 3184)	3 (1 to 5)	2559 (2166 to 2934)	1 (1 to 2)	5383 (4619 to 6113)	4 (2 to 7)	-0.09 (-0.11 to -0.07)	-0.28 (-3.14 to 2.67)	-2.56 (-3.25 to -1.98)	-13.19 (-18.97 to -8.69)		
Haiti	36 035 (33 327 to 38 617)	135 (6 to 317)	44 517 (40 927 to 48 139)	203 (52 to 480)	80 552 (74 426 to 86 878)	338 (183 to 551)	-3.92 (-4.15 to -3.66)	-4.91 (-7.20 to -2.41)	-4.78 (-5.24 to -4.30)	-7.39 (-11.97 to -3.59)		
Suriname	348 (312 to 383)	2 (1 to 3)	183 (168 to 197)	1 (0 to 1)	530 (486 to 575)	2 (2 to 4)	-0.78 (-0.92 to -0.66)	-0.24 (-2.89 to 2.65)	-7.55 (-8.08 to -7.00)	-10.29 (-13.99 to -5.90)		
Western Europe	0 (0 to 0)	0 (0 to 0)	0 (0 to 0)	0 (0 to 0)	3 (3 to 3)	0 (0 to 0)	0.00 (0.00 to 0.00)	0.00 (0.00 to 0.00)	0.00 (0.00 to 0.00)	0.00 (0.00 to 0.00)		
Greece	0 (0 to 0)	0 (0 to 0)	0 (0 to 0)	0 (0 to 0)	3 (3 to 3)	0 (0 to 0)	0.00 (0.00 to 0.00)	0.00 (0.00 to 0.00)	0.00 (0.00 to 0.00)	0.00 (0.00 to 0.00)		
Andean Latin America	14 203 (12 281 to 16 046)	13 (10 to 16)	13 873 (11 903 to 15 753)	10 (8 to 14)	28 075 (24 173 to 31 791)	23 (18 to 29)	-2.53 (-3.04 to -2.04)	-5.70 (-7.28 to -4.09)	-2.79 (-3.64 to -2.05)	-13.80 (-15.92 to -11.45)		
Bolivia	756 (665 to 841)	1 (1 to 2)	749 (657 to 835)	1 (1 to 2)	1505 (1323 to 1676)	2 (2 to 3)	-3.23 (-3.91 to -2.58)	-7.80 (-11.61 to -4.50)	-1.48 (-1.97 to -1.06)	-7.30 (-9.75 to -4.81)		
Ecuador	7617 (6556 to 8628)	6 (4 to 9)	7625 (6565 to 8633)	6 (4 to 10)	15 242 (13 121 to 17 261)	12 (9 to 17)	-2.97 (-3.42 to -2.52)	-5.63 (-7.68 to -3.48)	-3.94 (-4.91 to -3.10)	-16.00 (-18.85 to -13.03)		
Peru	5829 (5052 to 6580)	5 (4 to 8)	5499 (4672 to 6288)	3 (2 to 4)	11 328 (9724 to 12 860)	8 (6 to 12)	-1.90 (-2.47 to -1.35)	-5.98 (-8.41 to -3.66)	-1.35 (-2.03 to -0.77)	-11.42 (-14.39 to -8.24)		
Central Latin America	56 110 (49 168 to 62 758)	69 (50 to 98)	55 170 (47 750 to 62 283)	49 (38 to 68)	111 280 (96 932 to 125 061)	118 (93 to 160)	-2.29 (-2.75 to -1.85)	-5.58 (-7.13 to -4.18)	-2.10 (-2.76 to -1.51)	-10.06 (-12.13 to -7.34)		
Colombia	32 242 (28 091 to 36 221)	35 (21 to 60)	31 681 (27 161 to 35 989)	23 (14 to 37)	63 924 (55 318 to 72 202)	58 (38 to 91)	272 (2.19 to 333)	10.32 (8.38 to 12.23)	-1.85 (-2.44 to -1.34)	-10.46 (-14.05 to -6.31)		
Costa Rica	5 (4 to 5)	0 (0 to 0)	4 (4 to 4)	0 (0 to 0)	9 (8 to 9)	0 (0 to 0)	-1.475 (-1.501 to -1.444)	-15.71 (-16.55 to -14.88)	-10.54 (-11.69 to -9.35)	-16.41 (-17.25 to -15.51)		
El Salvador	45 (39 to 51)	0 (0 to 0)	48 (41 to 55)	0 (0 to 0)	92 (79 to 105)	0 (0 to 0)	-10.30 (-11.52 to -9.06)	-17.04 (-17.93 to -16.11)	-3.27 (-4.11 to -2.55)	-15.13 (-16.27 to -13.97)		

	All ages incidence and deaths (2013)											
	Male population				Female population				Total			
	Incidence	Deaths	Incidence	Deaths	Incidence	Deaths	Incidence	Deaths	Incidence	Deaths	Incidence	Deaths
Guatemala	9936 (8732 to 11 057)	14 (10 to 21)	10 220 (8956 to 11 422)	13 (9 to 19)	20 156 (17 688 to 22 495)	27 (20 to 37)	-9.66 (-10.61 to -8.66)	-14.29 (-16.36 to -12.07)	-3.62 (-4.43 to -2.88)	-10.87 (-13.59 to -7.87)		
Honduras	2998 (2669 to 3298)	6 (3 to 11)	3135 (2813 to 3423)	7 (4 to 12)	6133 (5476 to 6718)	12 (7 to 20)	-1.96 (-2.26 to -1.64)	-3.63 (-7.31 to -0.43)	-3.19 (-3.86 to -2.55)	-8.14 (-12.04 to -3.03)		
Mexico	82 (71 to 94)	1 (0 to 2)	65 (57 to 74)	0 (0 to 2)	148 (128 to 167)	1 (0 to 4)	-16.51 (-16.58 to -16.43)	-16.86 (-17.61 to -16.06)	-13.47 (-13.84 to -13.04)	-15.00 (-15.78 to -14.18)		
Nicaragua	2410 (2032 to 2776)	1 (1 to 1)	2463 (2076 to 2836)	1 (1 to 1)	4873 (4108 to 5612)	2 (1 to 2)	-6.78 (-7.71 to -5.87)	-12.23 (-15.27 to -9.58)	-3.91 (-4.87 to -3.10)	-21.04 (-24.04 to -17.96)		
Panama	409 (396 to 421)	0 (0 to 1)	427 (415 to 440)	0 (0 to 0)	836 (836 to 836)	1 (0 to 1)	7.72 (7.08 to 8.30)	-6.42 (-9.63 to -3.40)	-3.16 (-3.90 to -2.59)	-5.84 (-9.33 to -1.91)		
Venezuela	7983 (7025 to 8864)	12 (7 to 17)	7127 (6100 to 8102)	5 (3 to 7)	15 109 (13 168 to 16 970)	17 (12 to 23)	-0.99 (-1.32 to -0.69)	-3.84 (-6.20 to -1.59)	-1.12 (-1.56 to -0.75)	-7.30 (-10.34 to -4.47)		
Southern Latin America	301 (260 to 341)	0 (0 to 1)	308 (264 to 350)	0 (0 to 1)	609 (524 to 691)	0 (0 to 2)	-9.52 (-10.71 to -8.32)	-16.26 (-17.13 to -15.40)	-3.21 (-4.06 to -2.48)	-16.29 (-17.17 to -15.43)		
Argentina	301 (260 to 341)	0 (0 to 1)	308 (264 to 350)	0 (0 to 1)	609 (524 to 691)	0 (0 to 2)	-9.26 (-10.45 to -8.06)	-16.11 (-16.96 to -15.24)	-3.14 (-3.97 to -2.43)	-16.03 (-16.90 to -15.16)		
Tropical Latin America	66 015 (56 554 to 75 020)	46 (30 to 68)	65 424 (55 196 to 75 263)	24 (17 to 35)	131 439 (111 720 to 150 238)	71 (50 to 99)	-6.49 (-7.87 to -5.20)	-17.58 (-19.80 to -15.41)	-0.11 (-0.50 to 0.21)	-9.20 (-12.22 to -5.86)		
Brazil	65 965 (56 511 to 74 963)	46 (30 to 68)	65 376 (55 156 to 75 209)	24 (17 to 35)	131 341 (111 637 to 150 126)	71 (50 to 99)	-6.47 (-7.85 to -5.18)	-17.56 (-19.78 to -15.39)	-0.08 (-0.47 to 0.24)	-9.17 (-12.18 to -5.80)		
Paraguay	50 (43 to 57)	0 (0 to 0)	48 (41 to 55)	0 (0 to 0)	98 (83 to 112)	0 (0 to 0)	-8.20 (-9.31 to -7.08)	-14.75 (-15.77 to -13.77)	-2.98 (-3.76 to -2.31)	-14.55 (-15.76 to -13.32)		
North Africa and Middle East	1 257 700 (382 396 to 243 600)	5900 (2915 to 11 443)	857 057 (252 567 to 2 356 446)	4703 (2009 to 9594)	2 114 756 (638 796 to 569 750)	10 604 (5415 to 19 759)	2.14 (1.31 to 3.48)	3.88 (0.73 to 7.01)	-5.74 (-9.08 to -2.40)	-7.07 (-10.62 to -3.04)		
Algeria	0 (0 to 0)	6 (3 to 9)	0 (0 to 0)	4 (3 to 7)	0 (0 to 0)	10 (7 to 14)	0.00 (0.00 to 0.00)	-2.69 (-5.57 to 0.50)	0.00 (0.00 to 0.00)	-7.46 (-11.11 to -3.07)		

	All ages incidence and deaths (2013)											
	Male population				Female population				Total			
	Incidence	Deaths	Incidence	Deaths	Incidence	Deaths	Incidence	Deaths	Incidence	Deaths	Incidence	Deaths
Iran	385 (372 to 396)	5 (3 to 7)	402 (391 to 415)	6 (3 to 9)	787 (787 to 787)	10 (8 to 14)	-18.17 (-19.47 to -16.77)	0.52 (-2.67 to 3.62)	-22.32 (-23.57 to -21.08)	-7.92 (-10.80 to -4.64)		
Iraq	0 (0 to 0)	0 (0 to 0)	0 (0 to 0)	0 (0 to 0)	0 (0 to 0)	0 (0 to 0)	-9.60 (-10.60 to -8.55)	-14.67 (-16.70 to -12.66)	0.00 (0.00 to 0.00)	0.00 (0.00 to 0.00)		
Morocco	0 (0 to 0)	0 (0 to 0)	0 (0 to 0)	0 (0 to 0)	0 (0 to 0)	0 (0 to 0)	-0.27 (-0.29 to -0.25)	-0.33 (-2.73 to 2.08)	0.00 (0.00 to 0.00)	0.00 (0.00 to 0.00)		
Oman	0 (0 to 0)	0 (0 to 0)	0 (0 to 0)	0 (0 to 0)	0 (0 to 0)	0 (0 to 0)	-2.61 (-2.83 to -2.38)	-3.48 (-7.28 to 0.13)	0.00 (0.00 to 0.00)	0.00 (0.00 to 0.00)		
Saudi Arabia	40 (39 to 41)	11 (7 to 15)	42 (41 to 43)	2 (1 to 3)	82 (82 to 82)	13 (9 to 18)	-13.85 (-14.36 to -13.25)	-3.99 (-9.06 to 1.16)	-33.50 (-34.40 to -32.55)	-9.01 (-12.48 to -5.52)		
Sudan	689 118 (190 185 to 1 833 451)	3160 (1326 to 6839)	366 931 (78 799 to 1 177 901)	2203 (605 to 5384)	1 056 050 (275 911 to 2 940 472)	5363 (2274 to 11 118)	0.34 (-0.31 to 1.15)	1.19 (-2.43 to 4.91)	-7.83 (-11.74 to -3.79)	-8.71 (-12.78 to -4.35)		
Syria	0 (0 to 0)	0 (0 to 0)	0 (0 to 0)	0 (0 to 0)	0 (0 to 0)	0 (0 to 0)	-6.57 (-6.65 to -6.48)	-6.84 (-11.33 to -2.88)	0.00 (0.00 to 0.00)	0.00 (0.00 to 0.00)		
Turkey	534 (456 to 607)	0 (0 to 1)	540 (457 to 618)	0 (0 to 1)	1073 (913 to 1225)	1 (0 to 2)	-10.63 (-11.84 to -9.40)	-17.20 (-18.35 to -16.09)	-3.59 (-4.51 to -2.80)	-17.30 (-18.54 to -16.04)		
Yemen	566 320 (192 251 to 1 374 706)	2713 (1242 to 5640)	488 281 (161 967 to 1 225 111)	2483 (941 to 5133)	1 054 601 (355 535 to 2 646 959)	5196 (2471 to 10 098)	0.14 (-0.78 to 1.12)	1.55 (-2.57 to 5.80)	-3.51 (-5.44 to -1.70)	-4.11 (-7.91 to -0.48)		
Oceania	593 916 (232 012 to 1 391 577)	1104 (485 to 1910)	492 920 (207 650 to 1 088 266)	915 (493 to 1565)	1 086 836 (441 330 to 2 484 740)	2019 (1221 to 3218)	-0.02 (-0.25 to 0.19)	-0.30 (-3.70 to 2.75)	-2.14 (-3.14 to -1.05)	-2.61 (-5.49 to 0.65)		
Papua New Guinea	523 910 (197 634 to 1 243 454)	964 (419 to 1682)	434 724 (177 464 to 965 172)	804 (432 to 1383)	958 634 (376 486 to 2 206 672)	1768 (1075 to 2810)	-0.25 (-0.48 to -0.04)	-0.50 (-3.96 to 2.65)	-2.14 (-3.44 to -1.31)	-2.72 (-5.65 to 0.47)		
Solomon Islands	9577 (8537 to 10 514)	19 (4 to 42)	8847 (7818 to 9787)	14 (5 to 33)	18 424 (16 358 to 20 296)	33 (11 to 66)	-1.17 (-1.39 to -0.96)	-2.90 (-6.90 to 0.69)	-1.83 (-2.26 to -1.45)	-6.15 (-9.61 to -1.88)		
Vanuatu	3289 (2994 to 3565)	9 (2 to 21)	2990 (2687 to 3262)	7 (2 to 19)	6279 (5684 to 6820)	15 (5 to 33)	-0.73 (-0.86 to -0.61)	-1.70 (-5.70 to 2.06)	-2.20 (-2.67 to -1.78)	-6.06 (-10.15 to -1.72)		

	All ages incidence and deaths (2013)						Annualised rate of change (%)								
	Male population			Female population			Total			1990-2000			2000-13		
	Incidence	Deaths	Incidence	Deaths	Incidence	Deaths	Incidence	Deaths	Incidence	Deaths	Incidence	Deaths	Incidence	Deaths	
Central sub-Saharan Africa	3 940 130 (1 939 904 to 688 653)	28 851 (16 111 to 49 729)	4 301 690 (2 303 019 to 982 794)	31 817 (15 802 to 64 045)	8 241 820 (4 297 149 to 640 374)	60 667 (35 115 to 99 000)	-2.74 (-4.45 to -1.39)	-1.59 (-4.08 to 1.08)	-5.13 (-7.81 to -2.43)	-1.59 (-4.08 to 1.08)	-5.13 (-7.81 to -2.43)	-1.59 (-4.08 to 1.08)	-5.13 (-7.81 to -2.43)	-1.59 (-4.08 to 1.08)	
Angola	778 653 (552 510 to 1 612 440)	5421 (2082 to 12 081)	638 443 (292 224 to 1 338 115)	5240 (1083 to 12 889)	1 417 096 (646 248 to 901 702)	10 661 (4178 to 21 870)	-0.62 (-2.10 to 0.86)	1.22 (-3.40 to 5.85)	-5.02 (-7.47 to -2.37)	1.22 (-3.40 to 5.85)	-5.02 (-7.47 to -2.37)	1.22 (-3.40 to 5.85)	-5.31 (-9.46 to -0.84)	1.22 (-3.40 to 5.85)	
Central African Republic	240 694 (129 143 to 433 562)	1611 (876 to 2611)	297 972 (167 115 to 517 369)	1964 (919 to 3569)	538 666 (298 738 to 947 709)	3575 (2032 to 5659)	-1.49 (-2.76 to -0.56)	-0.24 (-4.56 to 3.72)	-2.80 (-4.33 to -1.36)	-0.24 (-4.56 to 3.72)	-2.80 (-4.33 to -1.36)	-0.24 (-4.56 to 3.72)	-3.33 (-7.33 to 0.58)	-0.24 (-4.56 to 3.72)	
Congo	167 366 (72 013 to 344 886)	977 (550 to 1804)	159 795 (72 976 to 323 383)	991 (298 to 2116)	327 162 (147 092 to 665 882)	1968 (1004 to 3472)	-0.01 (-0.62 to 0.96)	0.73 (-2.21 to 3.90)	-4.81 (-7.57 to -2.47)	0.73 (-2.21 to 3.90)	-4.81 (-7.57 to -2.47)	0.73 (-2.21 to 3.90)	-5.96 (-10.89 to -2.09)	0.73 (-2.21 to 3.90)	
DR Congo	2 641 315 (1 317 961 to 1 37 603)	20 087 (9338 to 38 586)	3 087 537 (1 663 453 to 670 932)	22 827 (9178 to 50 451)	5 728 853 (3 000 717 to 790 512)	42 914 (21 336 to 79 936)	-3.50 (-5.45 to -1.84)	-2.41 (-5.40 to 0.76)	-5.42 (-8.43 to -2.51)	-2.41 (-5.40 to 0.76)	-5.42 (-8.43 to -2.51)	-2.41 (-5.40 to 0.76)	-6.12 (-10.11 to -1.77)	-2.41 (-5.40 to 0.76)	
Equatorial Guinea	37 847 (22 135 to 65 711)	298 (75 to 572)	45 073 (26 889 to 76 106)	333 (106 to 625)	82 920 (49 005 to 142 294)	631 (252 to 1064)	0.51 (-0.35 to 2.06)	1.47 (-2.65 to 5.61)	-3.66 (-5.51 to -1.71)	1.47 (-2.65 to 5.61)	-3.66 (-5.51 to -1.71)	1.47 (-2.65 to 5.61)	-3.98 (-7.08 to -0.92)	1.47 (-2.65 to 5.61)	
Gabon	74 255 (35 105 to 144 155)	457 (225 to 817)	72 869 (35 969 to 139 716)	462 (200 to 864)	147 125 (71 124 to 281 843)	919 (531 to 1515)	-1.67 (-2.75 to -0.76)	-1.65 (-4.39 to 1.27)	-5.94 (-8.51 to -2.95)	-1.65 (-4.39 to 1.27)	-5.94 (-8.51 to -2.95)	-1.65 (-4.39 to 1.27)	-6.00 (-9.47 to -2.26)	-1.65 (-4.39 to 1.27)	
Eastern sub-Saharan Africa	12 520 054 (6 544 247 to 990 664)	85 566 (65 168 to 109 586)	13 377 215 (7 291 825 to 578 200)	89 820 (66 224 to 130 417)	25 897 270 (13 782 158 to 48 529 276)	175 387 (140 361 to 221 113)	0.41 (-0.29 to 1.52)	0.77 (-0.82 to 2.33)	-6.68 (-8.94 to -3.58)	0.77 (-0.82 to 2.33)	-6.68 (-8.94 to -3.58)	0.77 (-0.82 to 2.33)	-6.76 (-8.47 to -4.40)	0.77 (-0.82 to 2.33)	
Burundi	603 449 (369 625 to 975 531)	5362 (2862 to 8974)	710 930 (446 217 to 1 124 371)	5920 (3022 to 9518)	1 314 379 (807 412 to 996 773)	11 282 (6353 to 17 300)	0.99 (-0.10 to 2.83)	1.93 (-1.04 to 4.83)	-7.95 (-11.90 to -3.84)	1.93 (-1.04 to 4.83)	-7.95 (-11.90 to -3.84)	1.93 (-1.04 to 4.83)	-8.05 (-11.72 to -4.60)	1.93 (-1.04 to 4.83)	
Comoros	28 650 (26 480 to 30 862)	117 (56 to 222)	26 067 (24 109 to 27 935)	97 (16 to 246)	54 718 (50 588 to 58 781)	215 (98 to 414)	0.05 (0.04 to 0.05)	0.26 (-4.13 to 4.99)	-2.90 (-3.27 to -2.52)	0.26 (-4.13 to 4.99)	-2.90 (-3.27 to -2.52)	0.26 (-4.13 to 4.99)	-5.16 (-10.58 to -1.32)	0.26 (-4.13 to 4.99)	
Djibouti	21 649 (17 792 to 25 716)	184 (68 to 369)	19 021 (15 634 to 22 592)	161 (49 to 297)	40 671 (33 427 to 48 308)	345 (147 to 599)	2.61 (2.61 to 2.61)	2.82 (-1.60 to 7.69)	-4.90 (-4.91 to -4.90)	2.82 (-1.60 to 7.69)	-4.90 (-4.91 to -4.90)	2.82 (-1.60 to 7.69)	-4.96 (-9.86 to -0.39)	2.82 (-1.60 to 7.69)	
Eritrea	106 098 (89 697 to 122 962)	815 (252 to 1836)	106 810 (90 294 to 123 790)	821 (264 to 1770)	212 908 (179 991 to 246 752)	1636 (615 to 3199)	1.01 (0.99 to 1.03)	1.29 (-5.39 to 7.27)	-5.79 (-5.95 to -5.59)	1.29 (-5.39 to 7.27)	-5.79 (-5.95 to -5.59)	1.29 (-5.39 to 7.27)	-6.71 (-12.59 to -1.24)	1.29 (-5.39 to 7.27)	
Ethiopia	1 638 589 (498 186 to 4 270 533)	9877 (5029 to 17 293)	1 182 333 (373 552 to 267 067)	8510 (3506 to 16 787)	2 820 922 (876 846 to 716 426)	18 387 (9037 to 32 209)	-2.03 (-2.86 to -1.05)	-1.98 (-9.18 to 5.43)	-9.03 (-13.49 to -4.40)	-1.98 (-9.18 to 5.43)	-9.03 (-13.49 to -4.40)	-1.98 (-9.18 to 5.43)	-8.99 (-14.92 to -2.87)	-1.98 (-9.18 to 5.43)	

	All ages incidence and deaths (2013)											
	Male population				Female population				Total			
	Incidence	Deaths	Incidence	Deaths	Incidence	Deaths	Incidence	Deaths	Incidence	Deaths	Incidence	Deaths
Kenya	782 119 (236 917 to 2 033 030)	4464 (2618 to 7478)	627 587 (175 809 to 1 772 853)	3896 (1826 to 8102)	1 409 706 (412 893 to 805 649)	8360 (4891 to 14 436)	0.11 (-0.62 to 0.92)	1.07 (-2.51 to 4.74)	-10.47 (-15.44 to -5.08)	10.98 (-15.32 to -6.72)	1990-2000	2000-13
Madagascar	459 299 (131 674 to 1 198 750)	2123 (986 to 4137)	612 453 (212 737 to 1 430 807)	2783 (1420 to 4868)	1 071 751 (352 252 to 626 270)	4906 (2985 to 7867)	-2.01 (-3.47 to -0.96)	-1.42 (-4.41 to 1.43)	-5.02 (-7.63 to -2.26)	-4.54 (-8.19 to -0.46)	1990-2000	2000-13
Malawi	347 806 (116 374 to 858 925)	2147 (1094 to 3889)	402 696 (148 948 to 930 569)	2456 (1061 to 4910)	750 502 (268 060 to 1 769 176)	4603 (2546 to 8195)	-5.03 (-9.46 to -1.71)	-6.52 (-10.60 to -2.72)	-6.86 (-10.48 to -3.26)	-7.02 (-11.10 to -2.31)	1990-2000	2000-13
Mozambique	2 773 504 (1 582 152 to 4 911 657)	19 196 (13 650 to 25 948)	3 244 189 (1 684 669 to 6 325 806)	20 473 (14 753 to 26 654)	6 017 693 (3 266 015 to 11 078 884)	39 669 (31 008 to 49 712)	1.81 (0.66 to 3.21)	2.46 (-0.06 to 5.23)	-4.51 (-6.24 to -2.39)	-4.21 (-6.46 to -1.59)	1990-2000	2000-13
Rwanda	237 157 (89 675 to 564 253)	1806 (811 to 3293)	232 335 (89 900 to 553 411)	1764 (700 to 3613)	469 491 (179 942 to 1 118 489)	3569 (1754 to 6572)	1.80 (0.38 to 4.16)	3.12 (-0.06 to 6.87)	-13.32 (-19.57 to -6.60)	-13.13 (-18.69 to -7.48)	1990-2000	2000-13
Somalia	474 870 (233 983 to 899 300)	3314 (1561 to 6276)	356 615 (172 956 to 709 509)	2806 (1284 to 5202)	831 485 (409 498 to 1 610 977)	6120 (3066 to 10 592)	1.08 (0.14 to 2.50)	2.13 (-2.36 to 6.49)	-3.90 (-6.14 to -1.78)	-4.22 (-8.54 to 0.35)	1990-2000	2000-13
South Sudan	301 308 (112 436 to 702 216)	1703 (841 to 3414)	201 184 (72 449 to 507 884)	1399 (430 to 3252)	502 492 (186 803 to 1 157 572)	3102 (1547 to 5794)	0.48 (-0.36 to 1.49)	1.58 (-2.83 to 6.29)	-8.28 (-12.73 to -3.81)	-8.89 (-13.00 to -3.96)	1990-2000	2000-13
Tanzania	1 873 958 (934 095 to 3 672 184)	13 495 (7362 to 22 215)	2 307 766 (1 239 301 to 4 260 696)	16 242 (7989 to 32 819)	4 181 724 (2 178 550 to 7 920 536)	29 737 (17 572 to 48 950)	0.43 (-0.49 to 1.73)	0.35 (-2.63 to 3.47)	-7.77 (-11.64 to -3.71)	-7.90 (-11.48 to -3.73)	1990-2000	2000-13
Uganda	1 918 386 (1 036 770 to 3 491 911)	14 247 (7967 to 22 532)	2 262 354 (1 245 502 to 4 007 412)	15 298 (8111 to 25 181)	4 180 741 (2 285 851 to 7 474 431)	29 545 (18 946 to 45 298)	1.18 (0.28 to 2.49)	2.41 (-0.76 to 5.53)	-5.93 (-8.61 to -2.92)	-6.12 (-9.34 to -2.49)	1990-2000	2000-13
Zambia	945 622 (525 219 to 1 635 147)	6667 (4445 to 9435)	1 077 049 (585 683 to 1 925 781)	7145 (4894 to 10 132)	2 022 671 (1 112 338 to 551 130)	13 812 (10 076 to 18 903)	1.58 (0.47 to 2.82)	2.33 (-1.34 to 5.52)	-7.24 (-10.69 to -3.45)	-7.00 (-9.68 to -3.94)	1990-2000	2000-13
Southern sub-Saharan Africa	344 868 (147 187 to 780 285)	1896 (1376 to 2580)	275 985 (104 772 to 678 471)	1374 (907 to 2251)	620 853 (252 060 to 1 471 492)	3270 (2462 to 4543)	2.84 (1.28 to 4.19)	2.85 (-0.40 to 5.45)	-5.63 (-8.37 to -2.64)	-7.30 (-9.74 to -4.10)	1990-2000	2000-13
Botswana	18 238 (16 153 to 20 347)	112 (53 to 223)	9133 (8445 to 9797)	35 (10 to 91)	27 371 (24 696 to 30 025)	147 (79 to 264)	2.81 (2.54 to 3.04)	3.53 (-3.49 to 9.77)	-5.03 (-5.44 to -4.60)	-6.75 (-12.19 to 0.42)	1990-2000	2000-13
Namibia	33 857 (31 052 to 36 663)	158 (97 to 267)	25 990 (23 915 to 27 914)	83 (24 to 211)	59 847 (55 363 to 64 383)	241 (142 to 420)	1.76 (1.54 to 1.97)	2.62 (-1.56 to 6.85)	-3.86 (-4.31 to -3.41)	-6.36 (-9.85 to -2.46)	1990-2000	2000-13
South Africa	2755 (2663 to 2834)	245 (105 to 537)	2874 (2795 to 2966)	128 (86 to 249)	5629 (5629 to 5629)	374 (213 to 699)	0.25 (-0.49 to 1.00)	2.53 (-0.30 to 5.59)	0.08 (-0.96 to 0.85)	-13.25 (-17.68 to -7.37)	1990-2000	2000-13

	All ages incidence and deaths (2013)						Annualised rate of change (%)					
	Male population			Female population			1990-2000			2000-13		
	Incidence	Deaths	Incidence	Deaths	Incidence	Deaths	Incidence	Deaths	Incidence	Deaths	Incidence	Deaths
Swaziland	12 878 (10 579 to 15 305)	110 (29 to 241)	6411 (5268 to 7617)	54 (13 to 127)	19 290 (15 847 to 22 922)	164 (68 to 335)	376 (375 to 376)	344 (-265 to 8.27)	-6.68 (-6.68 to -6.68)	344 (-265 to 8.27)	-6.59 (-12.07 to -1.34)	
Zimbabwe	277 139 (78 586 to 717 290)	1272 (858 to 1885)	231 578 (60 882 to 634 297)	1073 (595 to 1857)	508 717 (140 095 to 1 364 465)	2345 (1609 to 3439)	3.02 (1.17 to 4.87)	2.96 (-1.94 to 6.75)	-5.96 (-9.71 to -2.38)	2.96 (-1.94 to 6.75)	-3.40 (-9.25 to -1.72)	
Western sub-Saharan Africa	28 989 748 (18 569 128 to 44 034 576)	246 973 (179 298 to 334 725)	27 966 300 (17 623 922 to 43 268 248)	218 875 (160 016 to 281 613)	56 956 048 (36 282 648 to 86 449 152)	465 848 (356 750 to 590 771)	0.90 (0.26 to 1.72)	145 (-0.24 to 348)	-3.79 (-5.33 to -2.00)	145 (-0.24 to 348)	-3.40 (-5.15 to -1.56)	
Benin	496 703 (272 131 to 893 268)	3604 (1769 to 6020)	589 179 (338 344 to 1 013 545)	4085 (2429 to 5968)	1 085 882 (607 392 to 908 784)	7689 (4649 to 11 064)	0.70 (-0.44 to 1.81)	140 (-1.86 to 4.67)	-5.23 (-7.29 to -2.73)	140 (-1.86 to 4.67)	-5.17 (-8.32 to -1.64)	
Burkina Faso	1 772 734 (1 091 493 to 2 837 545)	12 942 (8142 to 19 266)	2 068 269 (1 260 720 to 3 396 651)	14 319 (9910 to 19 631)	3 841 003 (2 364 116 to 6 158 591)	27 261 (19 599 to 36 230)	1.68 (0.72 to 2.97)	2.68 (0.22 to 5.22)	-3.54 (-5.11 to -1.90)	2.68 (0.22 to 5.22)	-3.85 (-6.24 to -1.62)	
Cameroon	1 141 115 (640 140 to 2 003 619)	8634 (4332 to 14 541)	1 528 984 (911 130 to 2 529 638)	10 703 (6168 to 17 005)	2 670 100 (1 556 196 to 4 539 860)	19 336 (11 574 to 29 258)	2.64 (1.22 to 4.14)	342 (0.49 to 6.56)	-6.47 (-9.47 to -3.19)	342 (0.49 to 6.56)	-6.40 (-9.50 to -2.56)	
Cape Verde	38 (32 to 44)	0 (0 to 1)	28 (24 to 32)	0 (0 to 0)	66 (56 to 77)	1 (0 to 1)	-3.60 (-3.62 to -3.57)	-339 (-8.78 to 0.84)	-9.01 (-9.15 to -8.85)	-339 (-8.78 to 0.84)	-9.55 (-13.74 to -5.02)	
Chad	638 516 (327 314 to 1 182 104)	4372 (2095 to 8178)	745 182 (425 863 to 1 287 409)	5463 (2674 to 9708)	1 383 698 (754 840 to 472 300)	9835 (5004 to 16 673)	2.43 (1.10 to 4.1)	370 (-0.41 to 7.68)	-3.75 (-5.46 to -1.87)	370 (-0.41 to 7.68)	-3.93 (-7.62 to -0.18)	
Côte d'Ivoire	1 116 108 (616 173 to 1 965 682)	7931 (3796 to 14 026)	1 270 614 (746 533 to 2 117 101)	8849 (4705 to 13 599)	2 386 722 (1 373 505 to 4 113 535)	16 780 (9577 to 25 660)	1.71 (0.73 to 2.79)	2.29 (-0.63 to 5.30)	-6.23 (-9.23 to -3.05)	2.29 (-0.63 to 5.30)	-6.04 (-9.41 to -2.47)	
Ghana	1 131 416 (597 366 to 2 063 095)	7843 (4899 to 11 682)	1 274 480 (700 996 to 2 287 354)	8572 (5486 to 12 246)	2 405 896 (1 293 177 to 4 322 408)	16 415 (11 390 to 22 881)	0.84 (0.48 to 1.91)	142 (-1.55 to 385)	-3.36 (-4.97 to -1.62)	142 (-1.55 to 385)	-3.64 (-6.35 to -0.93)	
Guinea	850 008 (528 198 to 1 364 161)	6594 (3882 to 9881)	1 070 541 (666 679 to 1 678 739)	8003 (4779 to 11 599)	1 920 549 (1 202 796 to 3 033 236)	14 597 (9576 to 20 495)	1.25 (0.42 to 2.38)	1.68 (-2.23 to 5.68)	-4.18 (-6.17 to -2.06)	1.68 (-2.23 to 5.68)	-4.40 (-7.17 to -1.23)	
Guinea-Bissau	188 651 (118 426 to 302 109)	1747 (1155 to 2514)	202 199 (125 656 to 321 006)	1796 (1158 to 2502)	390 850 (244 350 to 622 761)	3543 (2481 to 4805)	0.68 (0.07 to 1.55)	1.26 (-1.71 to 4.49)	-2.73 (-3.94 to -1.50)	1.26 (-1.71 to 4.49)	-2.10 (-4.72 to 0.53)	
Liberia	215 778 (119 173 to 385 255)	1467 (765 to 2519)	254 770 (147 560 to 431 784)	1686 (875 to 2731)	470 548 (269 710 to 826 308)	3154 (1799 to 4992)	1.24 (0.14 to 2.72)	2.28 (-2.18 to 6.27)	-4.86 (-7.07 to -2.53)	2.28 (-2.18 to 6.27)	-5.09 (-8.35 to -1.67)	

	All ages incidence and deaths (2013)						Annualised rate of change (%)								
	Male population			Female population			Total			1990-2000			2000-13		
	Incidence	Deaths	Incidence	Deaths	Incidence	Deaths	Incidence	Deaths	Incidence	Deaths	Incidence	Deaths	Incidence	Deaths	
Mali	1 812 025 (1 148 899 to 815 056)	16 526 (9857 to 24 875)	2 412 241 (1 441 912 to 931 845)	19 164 (11 403 to 27 092)	4 224 267 (2 612 582 to 660 447)	35 690 (23 410 to 50 450)	1 92 (0.85 to 323)	2.76 (-0.57 to 6.17)	-2.92 (-4.12 to -1.64)	2.76 (-0.57 to 6.17)	-2.92 (-4.12 to -1.64)	2.76 (-0.57 to 6.17)	-2.92 (-4.12 to -1.64)	2.76 (-0.57 to 6.17)	
Mauritania	164 717 (77 085 to 322 374)	974 (444 to 1838)	105 272 (49 402 to 215 015)	820 (290 to 1460)	269 989 (130 899 to 534 343)	1795 (844 to 3103)	4.56 (2.16 to 7.12)	5.77 (1.59 to 9.62)	-2.34 (-3.70 to -1.16)	5.77 (1.59 to 9.62)	-2.34 (-3.70 to -1.16)	5.77 (1.59 to 9.62)	-2.34 (-3.70 to -1.16)	5.77 (1.59 to 9.62)	
Niger	1 348 843 (837 303 to 127 755)	11 564 (4559 to 20 485)	1 608 928 (1 030 476 to 443 363)	13 869 (6688 to 21 584)	2 957 771 (1 877 757 to 481 069)	25 433 (13 395 to 40 453)	1.60 (0.44 to 322)	3.06 (-1.34 to 727)	-3.31 (-4.83 to -1.71)	3.06 (-1.34 to 727)	-3.31 (-4.83 to -1.71)	3.06 (-1.34 to 727)	-3.31 (-4.83 to -1.71)	3.06 (-1.34 to 727)	
Nigeria	16 635 774 (10 707 174 to 25 163 660)	151 794 (95 928 to 223 806)	13 033 882 (8 224 059 to 909 316)	108 611 (61 160 to 158 184)	29 669 656 (19 004 200 to 45 297 792)	260 405 (171 907 to 361 607)	0.23 (-0.49 to 0.67)	0.63 (-2.57 to 3.99)	-2.93 (-4.21 to -1.58)	0.63 (-2.57 to 3.99)	-2.93 (-4.21 to -1.58)	0.63 (-2.57 to 3.99)	-2.93 (-4.21 to -1.58)	0.63 (-2.57 to 3.99)	
Sao Tome and Principe	5915 (5258 to 6577)	35 (16 to 65)	6027 (5360 to 6701)	36 (17 to 61)	11 942 (10 619 to 13 278)	71 (37 to 119)	-0.48 (-0.50 to -0.44)	-0.49 (-4.15 to 2.96)	-3.41 (-3.69 to -3.11)	-0.49 (-4.15 to 2.96)	-3.41 (-3.69 to -3.11)	-0.49 (-4.15 to 2.96)	-3.41 (-3.69 to -3.11)	-0.49 (-4.15 to 2.96)	
Senegal	429 236 (185 098 to 920 585)	2970 (1400 to 5280)	500 762 (241 439 to 992 049)	3600 (1687 to 5828)	929 998 (430 550 to 1 917 898)	6570 (3511 to 10 420)	-0.43 (-1.31 to 0.31)	0.65 (-1.92 to 3.11)	-9.11 (-13.59 to -4.35)	0.65 (-1.92 to 3.11)	-9.11 (-13.59 to -4.35)	0.65 (-1.92 to 3.11)	-9.11 (-13.59 to -4.35)	0.65 (-1.92 to 3.11)	
Sierra Leone	519 098 (329 919 to 801 942)	4106 (2244 to 6714)	678 273 (416 276 to 1 092 241)	4775 (2912 to 6784)	1 197 371 (749 248 to 1 872 567)	8882 (5691 to 12 669)	0.58 (0.04 to 1.27)	1.10 (-1.78 to 3.98)	-5.95 (-8.84 to -2.89)	1.10 (-1.78 to 3.98)	-5.95 (-8.84 to -2.89)	1.10 (-1.78 to 3.98)	-5.95 (-8.84 to -2.89)	1.10 (-1.78 to 3.98)	
The Gambia	153 051 (92 298 to 251 289)	1056 (648 to 1604)	148 981 (90 176 to 243 097)	1034 (644 to 1510)	302 032 (182 698 to 494 937)	2090 (1405 to 3029)	-1.07 (-1.53 to -0.59)	-0.89 (-3.74 to 1.98)	-3.64 (-5.28 to -1.84)	-0.89 (-3.74 to 1.98)	-3.64 (-5.28 to -1.84)	-0.89 (-3.74 to 1.98)	-3.64 (-5.28 to -1.84)	-0.89 (-3.74 to 1.98)	
Togo	369 830 (214 148 to 641 934)	2811 (1429 to 5062)	467 452 (283 814 to 760 578)	3488 (1900 to 5575)	837 282 (499 488 to 1 395 545)	6299 (3690 to 9808)	-0.48 (-1.12 to -0.01)	0.07 (-2.97 to 3.01)	-3.55 (-5.34 to -1.72)	0.07 (-2.97 to 3.01)	-3.55 (-5.34 to -1.72)	0.07 (-2.97 to 3.01)	-3.55 (-5.34 to -1.72)	0.07 (-2.97 to 3.01)	

Data in parentheses are 95% uncertainty intervals.

Table 8
Comparison between Global Burden of Disease 2013 versus UNAIDS 2013 HIV estimates

GBD 2013	UNAIDS 2013 ^{60,160}
Incidence, prevalence, and mortality	
<p>Key data sources and inputs</p> <ul style="list-style-type: none"> • Vital registration (VR) data • UNAIDS' 1000 Estimation and Projection Package (EPP) incidence and prevalence curves • GBD 2013 HIV-free life tables • UNPOP World Population Prospects (WPP) 2012 population and fertility estimates • Antiretroviral therapy (ART), prevention of mother-to-child transmission (PMTCT), and other intervention coverage data reported to UNAIDS • HIV mortality rates on-ART from systematic literature review (102 studies) • HIV mortality rates off-ART from systematic literature review (13 cohort studies) • UNAIDS assumptions for other spectrum HIV inputs 	<ul style="list-style-type: none"> • Population surveys of HIV prevalence • Antenatal care (ANC) surveillance • Surveillance data for high-risk groups • UNPOP World Population Prospects 2010 population, fertility and HIV-free mortality estimates • ART, PMTCT, and other intervention coverage data reported to UNAIDS by countries; UNAIDS states these are validated by UNAIDS, WHO, and UNICEF but no method for validation is provided • Assumptions on the percent of the population in high-risk groups for each country with a concentrated epidemic; UNAIDS states that estimates are derived empirically, based on regional values or expert consensus but provides no detail by country on the empirical basis for the assumptions • UNAIDS assumptions for other Spectrum HIV inputs based on a range of published studies and unpublished analyses
<p>Key adjustments to data</p> <ul style="list-style-type: none"> • VR data adjusted for completeness • VR data adjusted for garbage coding and misclassification HIV deaths 	<ul style="list-style-type: none"> • None
<p>Modelling strategy</p> <p>All countries:</p> <ul style="list-style-type: none"> • Age-sex-CD4-specific estimates of HIV mortality on-ART and off-ART based on meta-regression of studies from literature reviews • Spectrum recoded in open-source language Python to facilitate uncertainty analysis <p>Generalised epidemics and populations with national surveys:</p> <ul style="list-style-type: none"> • 46 countries • EPP outputs (15-49 years, both sexes) for generalised epidemics used as an input to modified Spectrum • EPP fit to national prevalence data for India, Senegal, and Niger • Spectrum (Python version) run with modified death rates on and off ART, GBD HIV-free mortality, and WPP 2012 population estimates; intervention estimates for ART, PMTCT as reported by UNAIDS • Sampling uncertainty distributions for all input parameters generate 10 000 year-age-sex specific estimates of HIV mortality, incidence, and prevalence 	<p>Generalised epidemics and countries with sufficient HIV prevalence data:</p> <ul style="list-style-type: none"> • 41 countries • EPP (one of three variants) used to generate incidence and prevalence curves for urban and rural or regional breakdowns with survey and ANC surveillance data; aggregation to generate national curves for ages 15-49 years in both sexes combined. Fitting parameters including start year of the epidemic modified to eliminate unrealistic fits from the statistical model. Incidence adjusted downward by 92% for the fraction of people on ART. • EPP outputs with Spectrum inputs and WPP 2010 demographic data to generate year-age-sex specific estimates of HIV mortality, incidence, and prevalence • Selective modification of input parameters including ART survival based on country consultation process <p>Concentrated epidemics in populations greater than 250 000:</p> <ul style="list-style-type: none"> • 114 countries

GBD 2013	UNAIDS 2013 ^{60,160}
<ul style="list-style-type: none"> • Selection of the 1000 epidemic curves that minimize the gap between GBD 2013 all-cause mortality estimates and Spectrum mortality outputs <p>Concentrated epidemics with VR:</p> <ul style="list-style-type: none"> • 125 countries • Space-time Gaussian Process Regression (ST-GPR) on adjusted VR data to produce complete time series of age-sex-specific mortality • EPP outputs (15-49 years, both sexes) with Spectrum inputs, GBD 2013 demographic data, and updated on-ART and off-ART mortality analysis to run Spectrum and generate 1000 year-age-sex specific estimates of HIV mortality, incidence, and prevalence • Adjusted incidence from Spectrum using the ratio of ST-GPR modelled mortality to Spectrum modelled mortality with six different assumptions of the lag from year of infection to year of death (10-15 years). This produced 6000 time series of incidence (15-49 years, both sexes) • Adjusted incidence with GBD HIV-free life tables, WPP 2012 demographic data, and updated on-ART and off-ART mortality analysis to run Spectrum and generate 6000 year-age-sex specific estimates of HIV mortality, incidence, and prevalence • Select 1000 with the smallest root mean squared error between model predictions of mortality and the vital registration data <p>Concentrated without VR:</p> <ul style="list-style-type: none"> • 17 countries • Extrapolation of incidence and prevalence for countries where UNAIDS does not generate estimates by randomly selecting draws from countries in the region with estimates • Regional average of all other Spectrum inputs for countries where UNAIDS does not generate estimates • EPP outputs (15-49 years, both sexes) with Spectrum inputs, GBD 2013 demographic data, and updated on-ART and off-ART mortality analysis to run Spectrum and generate 1000 age-sex specific estimates of HIV mortality, incidence, and prevalence • Random selection of 1000 ratios used in the incidence adjustment process from countries with relatively high prevalence • Use selected ratios to adjust incidence in the absence of ST-GPR results, producing 1000 adjusted incidence curves (15-49 years, both sexes). • Adjusted incidence with Spectrum inputs, GBD 2013 demographic data, and updated on-ART and off-ART mortality analysis to run Spectrum and generate 1000 year-age-sex specific estimates of HIV mortality, incidence, and prevalence 	<ul style="list-style-type: none"> • EPP used to generate incidence and prevalence curves for high-risk groups using surveillance data for these populations • Aggregation to generate national curves (15-49 years, both sexes) based on assumptions about the fraction of the population in each high-risk group • EPP outputs with Spectrum progression parameters, reported ART and PMTCT coverage, and WPP 2010 demographic data to generate year-age-sex specific estimates of HIV mortality, incidence, and prevalence • For some countries with insufficient data on prevalence in high-risk groups, reported HIV diagnoses over time and assumptions about the fraction diagnosed used • Selective modification of assumptions on the percentage of the population in each high-risk group and other Spectrum input assumptions through country consultation process <p>Countries with populations less than 250 000:</p> <ul style="list-style-type: none"> • No estimates constructed

	GBD 2013	UNAIDS 2013 ^{60,160}
Uncertainty	<ul style="list-style-type: none"> • Use the 1000 EPP incidence curves consistent with the available prevalence data • Generated 1000 sets of CD4 progression and CD4 specific mortality on and off ART sampled from the meta-regression of published studies • Sample a uniform distribution of -10% to +10% of the mean value for all other Spectrum parameters including numbers on ART and PMTCT • The sex ratio of incidence was sampled from a uniform distribution of -20% to +20% of mean value • Major limitation is that uncertainty intervals for many parameters are sampled from an arbitrary uncertainty interval 	<ul style="list-style-type: none"> • EPP likelihood estimation of incidence reflects uncertainty in prevalence data • Uncertainty in the percent of the population in high-risk groups or urban and rural breakdown not incorporated • All uncertainty adjustments to non-EPP inputs are arbitrary and small compared with GBD • Uncertainty propagated after point estimates generated—coefficients of variation for parameters arbitrarily selected and only for selected variables (eg, for adults ratio of fertility of HIV-positive to HIV-negative women, ratio of male to female incidence, average number of years in each CD4 category, HIV mortality without ART, HIV mortality with ART) • No uncertainty incorporated for CD4 progression overtime or distribution of CD4 counts at seroconversion
GBD 2013 differences	<ul style="list-style-type: none"> • Recoded Spectrum in the Python programming language to enable the model to run more efficiently and allow for full uncertainty analysis • Expanded uncertainty in Spectrum estimates of mortality, incidence, and prevalence by sampling distributions around most Spectrum inputs • Empirically estimated uncertainty for HIV mortality on-ART and off-ART • Used VR data when available to inform estimates of mortality for concentrated epidemics • Identify epidemic curves and all-cause mortality estimates in countries with large epidemics that are most consistent with each other • Sum of cause-specific mortality estimates for a country-year-age-sex group must equal all-cause mortality estimate at the draw level (CoDCorrect algorithm) 	N/A

Table 9
Comparison between Global Burden of Disease 2013 versus WHO 2013 tuberculosis estimates

	GBD 2013	WHO 2013 ⁸²
Mortality		
Key data sources or inputs	<ul style="list-style-type: none"> Vital registration (VR) data (2731 country-years) Verbal autopsy (VA) data (166 site-years) Covariates 	<ul style="list-style-type: none"> VR data (2087 country-years) WHO 2013 tuberculosis incidence estimates WHO 2012 tuberculosis case fatality rate (CFR) estimates Covariates
Key adjustments to data	<ul style="list-style-type: none"> VR adjusted for estimated completeness in each country-year VR and VA data adjusted based on detailed analysis of garbage coding VR and VA data adjusted for misclassification of tuberculosis-HIV 	<ul style="list-style-type: none"> Excluded VR data for South Africa and Zimbabwe due to misclassification of tuberculosis-HIV VR data adjusted for senile and ill-defined cause of death VR data interpolated for missing data and trailing or leading missing values with exponential smoothing VR data adjusted for estimated completeness in each country year
Modelling strategy	<p>All countries:</p> <ul style="list-style-type: none"> Use the Cause of Death Ensemble Modeling strategy (CODEm) to generate mortality estimates from the VR and VA data for all countries; covariates informed the model; CODEm tests a wide range of models and constructs an ensemble model on the basis of performance of different models judged with data held-out from model -building Model fraction tuberculosis-HIV with the fraction of tuberculosis-HIV in HIV mortality from the VR data - HIV-mortality estimates used to generate TB-HIV deaths 	<p>Countries with VR:</p> <ul style="list-style-type: none"> Tuberculosis mortality directly from VR data: 123 countries (45% estimated global deaths) <p>Countries without VR with ten covariates available:</p> <ul style="list-style-type: none"> Negative binomial model estimated based on the 123 countries in the first group; predictions from the model used for 27 countries <p>Countries without VR without complete covariates:</p> <ul style="list-style-type: none"> Mortality estimated by multiplying estimated incidence multiplied by an estimate of the case-fatality rate for all-ages combined (67 countries) Regional case-fatality rates (CFR; high-income, middle-income, and low-income countries) generated from case notifications by type (notified and non-notified) and VR data (Bayesian linear modelling done separately by region) <p>All countries:</p> <ul style="list-style-type: none"> HIV plus tuberculosis incidence from UNAIDS' Spectrum model and estimated CFR of tuberculosis mortality in HIV-positive people (six CFRs corresponding to six CD4 cell-count groups and one CFR for cases on ART)
Uncertainty	<p>All countries:</p> <ul style="list-style-type: none"> CODEm generates uncertainty intervals for predicted death rates by sampling the posterior distribution of each of the component models in proportion to the 	<p>Countries with VR:</p> <ul style="list-style-type: none"> Uncertainty was computed based on sampling uncertainty <p>Countries without VR with ten covariates available:</p>

	GBD 2013	WHO 2013 ⁸²
	<p>weight of each model in the ensemble; mixed effects component model uncertainty includes uncertainty in the betas and the hierarchical random effects; spatiotemporal Gaussian Process Regression component models include uncertainty from the mean prior and the data variance</p> <ul style="list-style-type: none"> • Uncertainty interval coverage evaluated objectively with out-of-sample predictive validity • Each country-year-age-sex draw adjusted so it is consistent with the sum of all GBD 2013 causes and the all-cause mortality estimate for that country-year-age-sex group • Uncertainty distributions across countries were assumed to be independent 	<ul style="list-style-type: none"> • Uncertainty estimated from the uncertainty in the regression coefficients <p>Countries without VR without complete covariates:</p> <ul style="list-style-type: none"> • Mortality estimate uncertainty computed with posterior distributions of CFR (assumed time independent within respective case categories [notified or not, HIV positive or negative]) and country-year distributions of estimated incidence <p>All countries:</p> <ul style="list-style-type: none"> • Assumed uncertainty distribution correlation across countries unknown
GBD 2013 differences	<ul style="list-style-type: none"> • Tuberculosis mortality in all countries based on models constructed from VR and VA data • VR and VA data corrected for garbage coding and misclassification of HIV deaths as tuberculosis deaths • Fraction tuberculosis-HIV in HIV empirically estimated with VR data • Out-of-sample predictive validity testing used to select the ensemble model for estimating mortality in all countries • The same approach was used for all countries • Sum of cause-specific mortality estimates for a country-year-age-sex group must equal all-cause mortality estimate at the draw level (CoDCorrect algorithm) 	<ul style="list-style-type: none"> • N/A
Incidence and prevalence		
Key data sources and inputs	<ul style="list-style-type: none"> • WHO tuberculosis case notifications (age-sex-country-year specific) • Tuberculosis prevalence surveys (27 national survey-years and 24 subnational survey-years in 24 countries) • Expert opinion and consultation on the case-detection rate as reported by WHO • GBD 2013 tuberculosis mortality estimates • Pre-1994, case notifications for selected countries (Australia, Canada, Germany, UK, and Japan) • GBD 2013 HIV prevalence estimates (CD4 and antiretroviral therapy [ART]-status specific) • Relative risks (RRs) of tuberculosis-HIV compared with tuberculosis-only from literature review (eight studies) 	<ul style="list-style-type: none"> • WHO tuberculosis case notifications (country-year specific) • Prevalence surveys (about 19 national years), adjusted for extra-pulmonary tuberculosis and childhood tuberculosis • Expert opinion and consultation of case detection rate (CDR) • Tuberculosis subnational surveillance data, programmatic data, and inventory studies • Measure of access to health care and performance of health system derived from Demographic and Health Surveys • RRs of tuberculosis-HIV compared with tuberculosis-only (three studies) • Population surveys of prevalence of HIV in patients with tuberculosis, sentinel HIV data, routine HIV testing of reported tuberculosis cases

GBD 2013		WHO 2013 ⁸²
Key adjustments to data	<ul style="list-style-type: none"> • Correction of case notifications for missing age groups, smear-unknown and relapsed cases, and missing diagnostic categories • Case notifications adjusted upwards for underreporting with CDR • Prevalence surveys adjusted for likely proportion extra-pulmonary tuberculosis missing in a survey with case notification data 	<ul style="list-style-type: none"> • UNAIDS estimates of HIV prevalence in children and in adults • Triangulation of expert opinion on under-reporting CDR, subnational administration data, programmatic data, inventory studies, and DHS data • Case notification data reviewed and cleaned for underreporting, misclassification and over-reporting • Prevalence measurements reviewed and adjusted for childhood tuberculosis and extra-pulmonary tuberculosis
Modelling strategy	<p>All countries:</p> <ul style="list-style-type: none"> • Derivation of remission and excess mortality from incidence to prevalence ratio and CFR models with the adjusted and historic case notifications, prevalence data, and VR data • Bayesian internally consistent estimation of incidence, prevalence, excess mortality, remission and mortality estimates in DisMod-MR 2.0 • Estimation of the proportion of total tuberculosis incidence and prevalence that occurs in HIV-positive individuals with GBD 2013 CD4-specific HIV prevalence and CD4-specific RRs from a meta-analysis in a population attributable fraction calculation 	<p>Countries with regional workshops:</p> <ul style="list-style-type: none"> • Extrapolation of CDR estimates for 1997, 2003, and 2008-12 using a beta distribution of plausible CDRs on three data points per country • Estimation of incidence from CDR and case notifications for 96 countries. Trends based on tuberculin surveys (three countries) and mortality estimates (40 countries) <p>Countries with national prevalence surveys:</p> <ul style="list-style-type: none"> • Incidence from empirical measurements of disease prevalence and duration estimates for two countries <p>High-income countries:</p> <ul style="list-style-type: none"> • Incidence from case notifications and expert opinion or capture-recapture modelling <p>All countries:</p> <ul style="list-style-type: none"> • Proportion of tuberculosis incidence that is due to tuberculosis-HIV in UNAIDS' Spectrum model based on population surveys of HIV prevalence among tuberculosis cases, sentinel HIV data, and routine HIV testing of reported tuberculosis cases • Prevalence directly estimated from national surveys adjusted for extra-pulmonary and childhood tuberculosis or indirectly from estimates of tuberculosis incidence and duration
Uncertainty	<ul style="list-style-type: none"> • Uncertainty in case notifications based on expert reported upper and lower bounds of the case-detection rate adjusted so that the minimum interval is plus or minus 20 percentage points • Uncertainty in corrected incidence, remission rates, and excess mortality rates estimated by use of draws from the regression variance-covariance matrix of the betas and draws from the random effects distributions • Prevalence survey uncertainty computed from the sample size and sample design • DisMod-MR generates posterior distributions for incidence, prevalence, 	<ul style="list-style-type: none"> • Uncertainty in incidence based on primarily on uncertainty in expert opinion on the case-detection rate • Prevalence uncertainty based on either sampling uncertainty in surveys and assumptions about extra-pulmonary and childhood tuberculosis (derived from case notification data) or incidence uncertainty and an assumed duration • Assumed uncertainty distribution are uncorrelated • Estimates and their uncertainty are not based on analysis of age-specific rates

	GBD 2013	WHO 2013 ⁸²
GBD 2013 differences	<p>remission, and excess mortality that is a function of data variance and model parameter uncertainty</p> <ul style="list-style-type: none"> • Uncertainty distributions across countries assumed to be uncorrelated • DisMod-MR 2.0 simultaneously synthesizes all available data for incidence, remission, excess mortality and prevalence ensuring internal consistency • Estimation of incidence, prevalence, remission, and excess mortality is age-sex specific • All countries modelled with the same approach 	<ul style="list-style-type: none"> • N/A

Table 10
Comparison between Global Burden of Disease 2013 versus WHO 2013 malaria estimates

	GBD 2013	WHO ^{110,162}
Mortality		
Country groupings	<ol style="list-style-type: none"> 1 High malaria transmission countries in Africa 2 Countries outside of Africa and low malaria transmission African countries 3 Countries with mostly or only <i>Plasmodium vivax</i> malaria 	<ol style="list-style-type: none"> 1 High transmission countries in Africa 2 Countries outside Africa and low malaria transmission African countries
Key data sources	<ul style="list-style-type: none"> • Verbal autopsy (VA) studies and vital registration (VR) data 	<ul style="list-style-type: none"> • For countries outside Africa and low transmission African countries: NMCP reports for case estimates, as described below, as well as clinic records and reported malaria case fatality data • For high malaria transmission countries in Africa: verbal autopsy studies, vital registration data, and clinical malaria mortality data
Key adjustments to data	<ul style="list-style-type: none"> • VR adjusted for completeness • Adjustments for child deaths in VA and VR for garbage coding 	<ul style="list-style-type: none"> • None
Modelling strategy	<ul style="list-style-type: none"> • Separate CODEM models for high malaria transmission countries in Africa and countries outside of Africa and low malaria transmission African countries; separate models for under 5 and 5 years • CODEm covariates: <i>Plasmodium falciparum</i> parasite rate (PPr) from the Malaria Atlas Project (2010), Lysenko endemicity, WHO population-at-risk, prevalence-weighted first-line drug resistance, health-system access, indoor residual spraying (IRS) and insecticide-treated nets (ITN) coverage, rainfall, education, and lagged gross domestic product (GDP). • Deaths for countries with mostly or only <i>P. vivax</i> malaria estimated with a negative binomial model 	<p>For countries outside Africa and low transmission African countries:</p> <ul style="list-style-type: none"> • Deaths estimated by multiplying malaria case estimates by fixed case fatality ratios (0.45% in Africa; 0.3% outside of Africa), based on clinical malaria mortality and reported malaria case fatality data <p>For high-transmission countries in Africa:</p> <ul style="list-style-type: none"> • Child deaths estimated using a verbal autopsy multi-cause model (VAMCM) developed by the WHO Child Health Epidemiology Reference Group (CHERG), 145 adjusted post-hoc for the effect of bednets and use of <i>Haemophilus influenzae</i> type b (Hib) vaccine • Deaths in children aged 5 years or older: “inferred from a relationship between levels of malaria mortality in different age groups and the intensity of malaria transmission”¹¹⁰
Uncertainty analysis	<p>For <i>P. falciparum</i> countries:</p> <ul style="list-style-type: none"> • Uncertainty generated by CODEm • CODEm generates uncertainty intervals for predicted death rates by sampling the posterior distribution of each of the component models in proportion to the weight of each model in the ensemble; mixed effects component model uncertainty includes uncertainty in the betas and the hierarchical random effects; spatiotemporal Gaussian Process Regression component models include uncertainty from the mean prior and the data variance 	<p>For countries outside Africa and low transmission African countries:</p> <ul style="list-style-type: none"> • Uncertainty in the case fatality rates assumed arbitrarily to be a uniform distribution between 0.225% and 0.675% for African countries and between 0.15% and 0.45% for outside of Africa • Incidence rates: see section on morbidity below <p>For high-transmission countries in Africa:</p> <ul style="list-style-type: none"> • For child deaths estimated by CHERG with the VAMCM, “the bootstrap method was employed to estimate uncertainty intervals by re-sampling from the study-level data to

	GBD 2013	WHO ^{110,162}
	<ul style="list-style-type: none"> Uncertainty interval coverage assessed objectively using out-of-sample predictive validity <p>For <i>P vivax</i> countries:</p> <ul style="list-style-type: none"> 1000 draws generated from the variance-covariance matrix of coefficients from negative binomial model Each country-year-age-sex draw adjusted so it is consistent with the sum of all GBD 2013 causes and the all-cause mortality estimate for that country-year-age-sex group Uncertainty distributions across countries were assumed to be independent 	<p>estimate the distribution of the predicted percent of deaths due to each cause¹¹⁰</p> <ul style="list-style-type: none"> For deaths in children aged 5 years or older: unknown
Main GBD 2013 differences	<ul style="list-style-type: none"> Malaria mortality in all countries based on models constructed from VR and VA data VR and VA data corrected for garbage coding in children Models include drug resistance and ITN and IRS coverage Out-of-sample predictive validity testing used to select the ensemble model for estimating mortality in all countries (except those with mostly or all <i>P vivax</i> malaria) Sum of cause-specific mortality estimates for a country-year-age-sex group must equal all-cause mortality estimate at the draw level (CoDCorrect algorithm) 	<ul style="list-style-type: none"> N/A
Morbidity		
Country groupings	<p>As defined by Hay and colleagues¹⁶³</p> <ol style="list-style-type: none"> Countries with reliable surveillance systems (eight countries) Countries with incomplete surveillance systems (55 countries) Countries with unreliable surveillance systems (45 countries) 	<ol style="list-style-type: none"> High-transmission countries in Africa Countries outside Africa and low-malaria-transmission African countries
Key data sources	<ul style="list-style-type: none"> For countries with reliable surveillance systems and incomplete surveillance systems: national malaria control programme (NMCP) reports on the number of cases, supplemented with reported malaria case data at the subnational levels for China and Mexico For countries with unreliable surveillance systems: published epidemiological studies of malaria incidence 	<ul style="list-style-type: none"> For countries outside Africa and for African countries for which the quality of data were considered adequate: NMCP reports on malaria cases and nationally representative household surveys on source of care For countries with unreliable surveillance systems: published epidemiological studies of malaria incidence
Modelling strategy, including adjustments to data	<ul style="list-style-type: none"> For countries with reliable surveillance systems: cases directly from NMCP report data For countries with incomplete surveillance systems: cases from NMCP data, adjusting for completeness of reporting with health system access proxy covariate using a regression model 	<ul style="list-style-type: none"> For countries outside Africa and for African countries for which the quality of data were considered adequate: cases from NMCP report data adjusted for proportion of cases receiving a diagnostic test, completeness of reporting, and health-care seeking with the fraction of fever cases accessing facilities based on Demographic and Health Surveillance Surveys (DHS) and Multiple Indicator Cluster Survey

	GBD 2013	WHO ^{110,162}
	<ul style="list-style-type: none"> For countries with unreliable surveillance systems: cases estimated using the relation between studies of malaria incidence and malaria mortality rates estimated from CODEm with covariates for age group, active versus passive case detection, inside or outside Africa, and the ratio of site-specific to national PfPR from MAP2010 	<p>(MICS), or other nationally representative household surveys</p> <ul style="list-style-type: none"> For high-transmission countries in Africa: populations were classified as living at either high, low, or no risk of malaria and then high, low, or zero case-incidence rates were applied to the populations living in each endemicity class (procedure defined by Snow and colleagues¹⁶⁴). Estimates were adjusted post-hoc for urban and rural differences and bednet and IRS effects For countries with unreliable surveillance systems: high, low, and zero case-incidence rates were applied to populations classified as living at either high, low, or no risk of malaria defined according to climactic suitability (as per the Mapping Malaria Risk in Africa [MARA] project). Estimates were adjusted for urban and rural differences, and the effect of bednets and IRS
Uncertainty analysis	<p>For countries with unreliable surveillance systems (45 countries) and countries with incomplete surveillance systems (55 countries):</p> <ul style="list-style-type: none"> 1000 draws generated from the variance-covariance matrix of coefficients from the incidence regression Age pattern predicted with regression and applied to non-age-specific WHO case report data for countries with reliable surveillance systems (eight countries) 	<p>For countries outside Africa and low-transmission African countries:</p> <ul style="list-style-type: none"> uncertainty in the completeness of reporting assumed to be uniform for reported values between 50% and 80% (low and mid value at 80% and high values at 100%) and triangular distributions for values below 50% (low 0%, mid and high 50%) and above 80% (low and mid 80%, high 100%) Proportion of slide-positive cases assumed to have a normal distribution with SD from a least square regression of SDs on means across countries Uncertainty in the proportion of population with fever using health facilities that are covered by the health-facility reporting system of cases and proportion not seeking treatment: based on survey SDs Final uncertainty based on bootstrap methods assuming no correlation between sources of uncertainty within a country Uncertainty distribution correlation across countries unknown <p>For high-transmission countries in Africa:</p> <ul style="list-style-type: none"> incidence rates by age and category of transmission risk triangular distributions (with low, mid, and high values based on median and interquartile values as reported by Snow and colleagues¹⁶⁴) “truncated so that their lower limit did not fall below 1” Adjustments for rural or urban differences and for coverage of malaria preventive activities (ITNs and IRS): not included in the description of uncertainty methods Uncertainty distribution correlation across countries unknown
GBD 2013 differences	<ul style="list-style-type: none"> Malaria cases were predicted with a mortality-incidence model for countries with unreliable surveillance systems 	<ul style="list-style-type: none"> N/A

GBD 2013	WHO ^{110,162}
<ul style="list-style-type: none">• Predictions are adjusted for detection methods (active vs passive case detection)	

The description of WHO estimation methods was based on the World Malaria Report 2008 and World Malaria Report 2011.