

UC Davis

Dissertations

Title

Commercializing Light-Duty Plug-In/Plug-Out Hydrogen-Fuel-Cell Vehicles: “Mobile Electricity” Technologies, Early California Household Markets, and Innovation Management

Permalink

<https://escholarship.org/uc/item/16k010cq>

Author

Williams, Brett D

Publication Date

2007-02-01

Peer reviewed

Commercializing Light-Duty Plug-In/Plug-Out Hydrogen-Fuel-Cell Vehicles:
“Mobile Electricity” Technologies, Early California Household Markets, and
Innovation Management

by

BRETT DAVID WILLIAMS
B.A. (Pomona College) 1994
M.Phil. (Cambridge University) 1995

DISSERTATION

Submitted in partial satisfaction of the requirements for the degree of

DOCTOR OF PHILOSOPHY

in

Transportation Technology & Policy

in the

OFFICE OF GRADUATE STUDIES

of the

UNIVERSITY OF CALIFORNIA

DAVIS

Approved:

Committee in Charge

2007

Dissertation overview

Starting from the premise that new consumer value must drive hydrogen-fuel-cell-vehicle (H₂FCV) commercialization, a group of opportunities collectively called “Mobile Electricity” is characterized. Mobile Electricity (Me-) redefines H₂FCVs as innovative products able to import and export electricity across the traditional vehicle boundary. Such vehicles could provide home recharging and mobile power, for example for tools, mobile activities, emergencies, and electric-grid-support services. To characterize such opportunities, this study first integrates and extends previous analyses of H₂FCVs, plug-in hybrids, and vehicle-to-grid (V2G) power. It uses a new electric-drive-vehicle and vehicular-distributed-generation model to estimate zero-emission-power vs. zero-emission-driving tradeoffs, costs, and grid-support revenues for various electric-drive vehicle types and levels of infrastructure service.

Next, the initial market potential for Me-enabled vehicles, such as H₂FCVs and plug-in hybrids, is estimated by eliminating unlikely households from consideration for early adoption. 5.2 million of 33.9 million Californians in the 2000 Census live in households pre-adapted to Me-enabled vehicles, 3.9 million if natural gas is required for home refueling. The possible sales base represented by this population is discussed. Several differences in demographic and other characteristics between the target market and the driving-age population are highlighted, and two issues related to the design of H₂FCVs and their supporting infrastructure are discussed: vehicle range and home hydrogen refueling. These findings argue for continued investigation of this and similar target segments—which represent more efficient research populations for subsequent study by

product designers and other decision-makers wishing to understand the early market dynamics facing Me- innovations.

Next, Me-H₂FCV commercialization issues are raised from the perspectives of innovation, product development, and strategic marketing. Starting with today's internal-combustion hybrids, this discussion suggests a way to move beyond the battery vs. fuel-cell zero-sum game and towards the development of integrated plug-in/plug-out hybrid platforms. H₂FCVs are described as one possible extension of this Me- product platform for the supply of clean, high-power, and profitable Me- services as the technologies and markets mature.

Finally, the major findings of this study are summarized and directions for future work discussed. Together, the parts of this Mobile Electricity innovation assessment reveal an initially expensive and limited but compelling (and possibly necessary) set of opportunities to help drive H₂FCV and other electric-drive-vehicle commercialization.

Keywords: Hydrogen-fuel-cell vehicle, Mobile Electricity innovation, Plug-in hybrid, Plug-out hybrid, Vehicle-to-grid power, Vehicular distributed generation, Household market potential, product development, market development

Table of contents

Dissertation overview.....	ii
Table of contents.....	iv
1 Introduction.....	1
1.1 Problem: Commercializing fuel-cell vehicles.....	1
1.2 Approach: “Mobile Energy” innovation.....	1
1.2.1 Focus: “Mobile Electricity” from light-duty vehicles in early households.....	3
1.3 Objectives.....	4
2 Mobile Electricity technologies and opportunities.....	7
2.1 Chapter overview.....	7
2.2 “Plug-in” opportunities.....	8
2.2.1 Battery charging.....	10
2.2.1.1 Costs and benefits.....	10
2.2.2 Battery supplementation, all-electric range (AER), and plug-in hybrid-electric vehicles (PHEVs).....	12
2.2.2.1 PHEV uncertainties: Batteries and charging.....	13
2.2.2.2 What is going on?: Plug-in hybrid status and activities.....	16
2.3 “Plug-out” opportunities: What could be going on?.....	18
2.3.1 Plug out “on the go”: Mobile power.....	18
2.3.1.1 Free your imagination.....	19
2.3.2 Plug out “in need”: Emergency power.....	20
2.3.3 Modeling untethered and emergency Me-.....	21
2.3.4 Plug out “for profit”: Vehicular distributed generation.....	25
2.3.4.1 The Electrical Grid.....	26
2.3.4.2 Kempton and Tomic V2G articles.....	30
2.3.4.3 The Mobile Electricity model, including vehicular distributed generation.....	33
2.3.5 Plug-in/-out hydrogen-fuel-cell vehicles.....	49
2.4 Chapter summary and conclusions.....	49
3 Who might be among the first to benefit from Mobile Energy innovation?: The early California household market.....	54
3.1 Chapter overview.....	54
3.2 Methodology.....	55
3.2.1 Capability-constraints analysis.....	55
3.2.1.1 “Pre-adapted”.....	56
3.2.1.2 “Initial market potential”.....	56
3.2.2 Data: U.S. Census microdata sample.....	57
3.2.3 Theory: Constraints/filtering criteria.....	57
3.2.3.1 Spatially segmented AFV commercialization strategy.....	58
3.2.3.2 Home connection hardware.....	58
3.2.3.3 Lifestyle accommodation.....	59
3.2.3.4 Initial price premium.....	60
3.2.3.5 Summary.....	61
3.2.4 Analysis: Overview.....	62

3.3	Results.....	62
3.3.1	How many?: Initial market potential.....	62
3.3.1.1	Sensitivity Analysis.....	62
3.3.2	Who are they?: Characterizing the target segment.....	64
3.3.2.1	Mean value comparisons.....	64
3.3.2.2	Distribution comparisons.....	64
3.4	Discussion.....	70
3.4.1	Overall impressions.....	70
3.4.2	Vehicle design: Range requirements.....	73
3.4.3	Infrastructure design: Home reformation or electrolysis?.....	75
3.5	Chapter summary and conclusions.....	79
4	How might Mobile Electricity innovation happen?: Product- and market-development considerations.....	81
4.1	Innovation and high-tech marketing theory.....	81
4.1.1	Characterizing innovations.....	82
4.1.2	Commercialization challenges and strategies for discontinuous innovations.....	90
4.1.2.1	Familiarity.....	90
4.1.2.2	Leverage.....	92
4.2	Product development: Competing technologies, getting started, and the Me-product platform.....	93
4.2.1	Getting started: Why start with combustion hybrids?.....	94
4.2.1.1	How innovation works.....	96
	“Recombinant” innovation and robust design.....	96
	Unleashing lead-user, do-it-yourself, and other external innovation.....	98
4.2.1.2	Starting with combustion hybrids: Strategic benefits.....	100
4.2.2	Putting it together: The Me- product platform and development plan.....	102
4.2.2.1	Taking the ICE hybrid to the next level: Initial Mobile Electricity products.....	103
	The pre-Me- Hybrid.....	103
	The Hybrid Me-.....	104
	From Hybrid Me- to Hybrid Me-GO.....	105
	The Me- Interface.....	105
	Me- infomercial.....	106
	Additional product details: Me- SUV?.....	106
4.2.2.2	Product expansion.....	107
4.2.2.3	Unifying Mobile Electricity and hydrogen.....	108
4.2.2.4	Roads not taken.....	110
	Once Me- ICE hybrids, why bother with hydrogen fuel cells?.....	110
	Whither hybridization and the BEV?.....	111
4.3	Market development: The search for value propositions, marketing discontinuous products, and niches.....	115
4.3.1	Section introduction and overview.....	115
4.3.2	Why Me-FCVs again?: Searching for product differentiation.....	116
4.3.3	Marketing discontinuous and unfamiliar products.....	118
4.3.3.1	The technology adoption life cycle.....	119
	The modified technology adoption life cycle.....	120

	Conceptualizing Me- diffusion with technology adoption life cycles	121
4.3.4	Strategic marketing: Niches.....	127
4.3.4.1	Marketing definitions	128
4.3.4.2	Strategic niche marketing and fleets	129
4.4	Illustrative aggregated Me- innovation example: Establishing V2G markets with airport rental-car parking-lot power plants	134
4.4.1.1	Designing a rental-car V2G application	136
4.5	Chapter summary and conclusions	143
5	Overall summary and directions for future work.....	144
6	Acknowledgements	159
7	Appendices.....	160
7.1	Me- technologies and opportunities (further detail)	160
7.1.1	Illustrative PHEV incremental costs	160
7.1.2	Battery leasing	162
7.1.3	PHEV prototypes	162
7.1.4	Vehicle-to-grid calculation detail: A supplement to section 2.3.4.3.....	165
7.1.4.1	Key to color coding	165
7.1.4.2	V2G Equations.....	166
7.1.4.3	Cost per unit energy (cgen) inputs for Table 2-5.....	167
7.2	Me- product and market development (further detail).....	167
7.2.1	The normal distribution.....	167
7.3	Literature review and preliminary theory development.....	168
7.3.1	Section introduction and overview	168
7.3.2	Lessons from previous alternatively-fueled-vehicle research	170
7.3.3	Lessons from technological innovation and marketing theory.....	224
7.3.4	Vehicle-to-grid power	245
7.3.5	Summary of lessons from the literature to be applied in the dissertation research	264
8	References.....	267

1 Introduction

1.1 Problem: Commercializing fuel-cell vehicles

Hydrogen-fuel-cell vehicles (H₂FCV) have been proposed as a potential solution to many transportation, energy, and environmental problems (e.g., [1-6]) and are receiving the attention of all of the world's major automotive and energy companies. Nevertheless, currently expensive, of limited driving range per refueling, and lacking a refueling infrastructure, H₂FCVs face similar challenges faced by past alternative-fuel vehicle (AFV) efforts, whose momentum typically could not be sustained over periods of low oil prices (e.g., [7, 8]). How might H₂FCVs (or any AFV) succeed where past efforts have failed?

1.2 Approach: "Mobile Energy" innovation

Even in the absence of vehicle performance limitations, robust private value propositions for H₂FCVs would be necessary to sustain their successful commercialization and to displace entrenched gasoline and diesel-powered cars and trucks. Because H₂FCVs thus far are not superior to today's vehicles on those dimensions conventionally valued by private consumers, product value must flow from other sources. The premise of this study is that H₂FCVs will not sell simply as clean cars and trucks; they must be marketed as new products that provide innovative value to consumers. Given this premise, the question then becomes "What might help redefine H₂FCVs as new products?"

One group of opportunities for H₂FCV innovation stems from the ability of these vehicles to produce clean, quiet electrical power for purposes other than propulsion. These and related potential innovations, which I collectively call “Mobile Electricity” (Me-) opportunities, are illustrated in Figure 1-1 and described in detail in chapter 2.

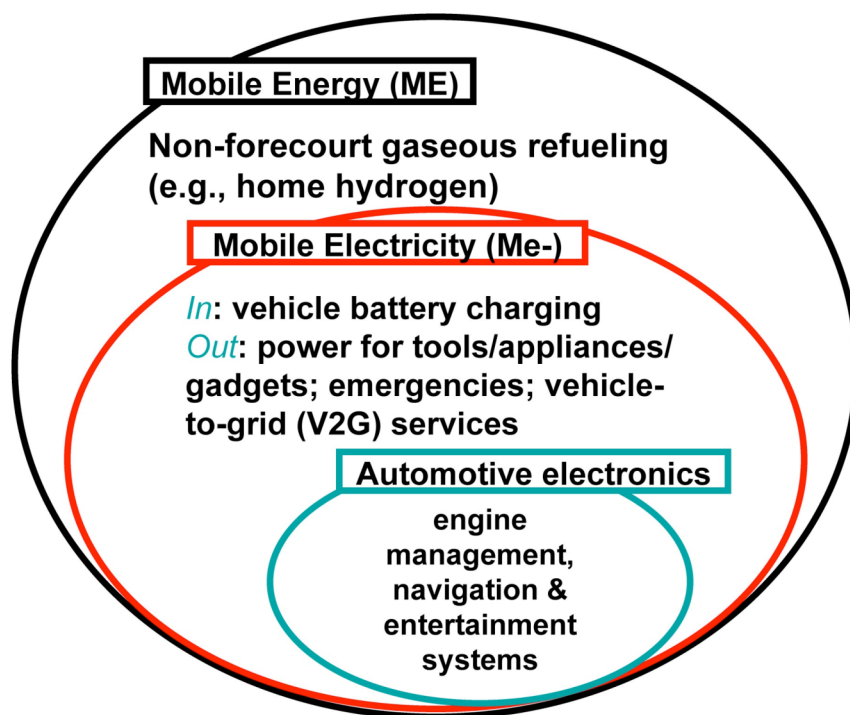

Fig. 1-1. Redefining H₂FCVs as new products: Mobile Energy innovation opportunities

Loosely defined, Mobile Energy (ME) is the interaction between vehicles and other energy systems. The commercialization of electric-drive vehicles (EDVs)¹ creates—or, in some cases, may depend on—opportunities for innovation that arise at the convergence of transportation and other energy systems. Where these innovations generate novel value

or new lifestyle opportunities, they may drive, or help reinforce, the adoption of EDVs by consumers. ME opportunities include both “Mobile Electricity” and non-forecourt refueling (e.g., home refueling for gaseous fuels). Mobile Electricity (Me-) includes both exporting electricity from the vehicle (e.g., to power gadgets/appliances/tools, provide emergency power, or to supply grid-stabilization services to utilities, such as voltage-regulation and spinning reserves [9-12]), as well as importing electricity to the vehicle (e.g., for vehicle battery charging of “plug-in” electric-drive vehicles [13]).

1.2.1 Focus: “Mobile Electricity” from light-duty vehicles in early households

The scope of this analysis is limited in two ways. First, H₂FCV value could arise from other sources, for example, the production and flexibility benefits of H₂FC integration into by-wire platforms or the development of niche-specific H₂FCV products such as forklifts. Those potential sources of value will not be considered here. Second, this research focuses on the first stages of relatively widespread commercialization of light-duty H₂FCVs in households. It does not focus on either the earliest customer placements, e.g., relatively controlled demonstration experiments in fleets, or widespread adoption by the mainstream, by which time commercialization would be foregone and the challenges become “sustaining” (e.g., sales and market share). There is some discussion of fleets as strategic niches and Me- aggregation opportunities (chapter 4).

The author believes ME innovations in general, and Me- innovations specifically, represent some of the most interesting, important, and desirable sets of opportunities,

¹ e.g., hydrogen-fuel-cell (H₂FC) and internal-combustion-engine (ICE) hybrid-electric vehicles (HEVs) and all-battery city electric vehicles (city BEVs)

without which H₂FCV commercialization will be unlikely or problematic in the (relatively) near term.² Further, ME opportunities have additional appeal beyond the scope of H₂FCV commercialization, arguing for their robustness. First, they appear concordant with other societal and technological trends [14]. For example, as cell phones provide wireless communications, so might ME “untether” and otherwise reconfigure our energy systems and lifestyles. Additionally, ME is consistent with the convergence of transportation and other energy systems being ushered in by EDVs, whether battery-electric, gasoline-combustion-hybrid, or fuel-cell. The technological diversity that both supports and would be supported by ME innovation provides not only robustness to the failure of any given technology, but allows the construction of development pathways. For example, one can imagine first developing ME for combustion hybrids as a means to create market demand for services that might, in turn, support H₂FCV commercialization as those technologies mature [11].

1.3 Objectives

The objective of this study is threefold. The objective of chapter 2 (accepted for publication as [15]) is to integrate and supplement related previous work (e.g., on plug-in hybrids, vehicle-to-grid power, and H₂FCVs) into a Mobile Electricity framework.

Chapter 3 (published in preliminary form as [16]) identifies, quantifies, and characterizes

² This may be considered a somewhat controversial and counterintuitive argument: that more “radical” distinguishing product features—which might reasonably be expected to evolve *after* more conventionally defined fuel-cell cars and trucks have been adopted—must be developed *first*. However, recall that this conclusion results from the innovation premises, i.e., H₂FCVs will not be competitive on conventional dimensions for the foreseeable future, and a private value proposition must drive their adoption. Thus, in this framework the “near-term” becomes a relative concept: new features must be developed in order to assure H₂FCV commercialization happens at all.

the most promising early household market segment for light-duty ME H₂FCVs and plug-in hybrids in California. Chapter 4 explores the Me- framework as a driver for electric-drive-vehicle commercialization using an innovation lens, and begins to assemble elements of a possible product- and market-development pathway towards that end goal, starting with today's combustion hybrids. Chapter 5 presents a summary and directions for future work. The appendices include supplemental detail as well as a literature review that provides additional context and the preliminary theory development that guided the research presented in the body of the dissertation. Collectively, the parts of this study are designed to inform public and private decision-makers about Me- opportunities and the early-market dynamics of commercializing H₂FCVs and other EDV technologies.

Although conducted for the purpose of exploring Mobile-Electricity-enabled H₂FCV commercialization, it should be noted that this study frequently uses techniques suitably general for, and derives results suitably applicable to, a wide variety of EDVs. Indeed, the potential innovations discussed are made more robust by their integration into an overall Mobile Energy framework that minimizes possible regrets by considering several potentially profitable pathways should insurmountable roadblocks bar the way to one or another specific aspects of the nominal end goal. For example, if FCVs “don't make it,” vehicle-to-grid (V2G) power sales and home recharging for ICE hybrids might still be attractive. On the other hand, if regulatory considerations make V2G grid-support difficult, the ME framework can still help guide exploration of the commercialization-enabling benefits of, for example, home refueling for H₂FCVs. The conclusions drawn

here should therefore have value for anybody interested in ME innovation, whether for fuel-cell, ICE-hybrid, or even battery-electric vehicles.

Nevertheless, it should be equally noted that this study does not shy away from exploring a particular vision of Me- H₂FCV commercialization. In doing so, unlike many “technology-neutral” assessments, this study uses an end-goal to provide context and facilitate conceptualization of the issues involved. It is hoped that this choice will increase the meaningfulness and relevance of the findings without compromising its analytical integrity. Indeed, it is hoped that a more specific context facilitates more rapid testing and adaptation to falsified hypotheses discovered along the way by the receptive mind. Further, it is hoped this choice will help the study contribute more directly and earlier to the further development of H₂FCVs, which is arguably already justified based on an “option value” rationale: worth the risk despite considerable remaining uncertainty in order to improve our position in the future when such options might be wanted or needed. As the Chinese proverb tells us, the next-best time to plant an already desirable tree is now.

2 Mobile Electricity technologies and opportunities

2.1 Chapter overview

This study (accepted for publication as [15]) integrates related analyses of H₂FCVs, plug-in hybrids (e.g., [13]) and, in some detail, vehicular distributed generation or vehicle-to-grid (V2G) power (e.g., [17]) into a Mobile Electricity (Me-) framework. This framework organizes the examination of seemingly disparate and competing technology developments into a coherent group of commercialization-enabling innovations by emphasizing the convergence of transportation and other energy systems. It describes the potential costs, benefits, performance, and current status of 1) “plug-in” opportunities (including battery charging and all-electric range) and 2) “plug-out” opportunities (including “untethered,” emergency, and vehicle-to-grid power). This study also enhances and extends past analyses with a new spreadsheet model of: Me- vehicle power vs. driving ranges, vehicle and building incremental costs, and illustrative vehicle-to-grid (V2G) net revenues under various assumptions.

Section 2.2 describes “plug-in” Me- opportunities. Significant and increasing activity is underway pertaining to the development of a conceptual subset of plug-in opportunities: plug-in hybrid electric/gasoline-combustion vehicles (PHEVs), which historically have emphasized configurations with big propulsion batteries. However, recent activities (some proprietary) and support has pushed a new generation of PHEVs into the public attention. Section 2.2 includes both a conceptual/analytical review of plug-ins as well as a

brief discussion of “What is going on?” with known plug-in prototypes and advocacy activities.

In contrast to section 2.2, section 2.3’s discussion of “plug-out” opportunities is about “What *could* be going on?” Relatively less developed, plug-out opportunities—such as power for tools/appliances/gadgets, for emergency power, or for grid-support services—are nevertheless increasingly pertinent and topical, and may provide the key to rounding out the product offerings of plug-in hybrids as they evolve conceptually into “Mobile Electricity platforms” (as introduced in section 2.3.5 and discussed in the strategic recommendations in chapter 4).

Sections 2.2 and 2.3 selectively present and integrate past work into the overall Me-framework, emphasizing and contextualizing the enhanced modeling. The modeling, in turn, is primarily used here to illustrate and extend the discussion of “plug-out” Me-opportunities, in particular vehicular distributed generation in section 2.3.4, which incorporates many of the important requirements of Me-.

2.2 “Plug-in” opportunities

“Importing” electricity across the vehicle boundary could be used to charge vehicular energy storage systems (e.g., batteries, ultracapacitors, and/or, in principle, onboard electrolyzers) or to power onboard electrical devices without use of vehicular power systems (e.g., “hotel loads”). Existing examples of the latter service include powering parked RVs or docked boats using “shore lines” and the electrification of truck stops to

avoid engine idling. These existing examples are not addressed in this report, which focuses on new opportunities for light-duty passenger vehicles (LDVs).³

Of particular interest for light- (and medium-) duty vehicles is the opportunity to take the performance of increasingly widespread hybrid-electric vehicles (HEVs) “to the next level” of Me- application by allowing—not requiring—HEV users to charge their vehicles’ batteries from the electrical grid. The arguments in favor of a “plug-in” approach can now be built on the successes of current HEVs (with relatively small, power-assist batteries) and the hope that even deeply discharged PHEV energy batteries may not have to be replaced during 150,000-mile vehicle lifetimes. Bolstered by the belief that PHEVs thus offer a relatively near-term solution to various transportation and energy problems, a broadening base of utility, non-profit, local-government, and academic supporters are taking up the call for PHEVs⁴ and seem to be gaining increasing traction with automakers, who nevertheless remain publicly cautious.⁵ The rest of section 2.2 describes many of these issues, including battery charging and supplementation, remaining uncertainties, and independent and automaker PHEV development activities.

³ One of the exciting aspects of ME innovation is its potential to evolve light-duty vehicles into a base for lifestyles activities previously reserved only for RVs, houses, and other large or stationary locales. As “activity” increasingly becomes decoupled from specific geographies, LDVs may, like PDAs, become the “locale” for “killer apps” previously executed in laptops (RVs?) or desktops (houses?).

⁴ The nomenclature for PHEVs is still growing and changing. They are referred to by various sources as “plug-in,” “gasoline-optional,” “grid-connected,” “gridable,” or “e-” hybrids.

⁵ Further, automakers currently tout *not* plugging in as a virtue of their current HEVs, e.g., “you never have to plug it in.” Thus, plug-in *opportunities* described in this paper may be confusing to consumers worried about plug-in *requirements*. Can the message “You get to plug in PHEVs” be successfully built upon “You never have to plug it in”?

2.2.1 Battery charging

In order to charge batteries onboard a hybrid- or battery-electric vehicle from an external source, additional hardware and software is required to create the connection, to control the rate of charging, and to prevent overcharging. Recognizing that the lack of a charging standard hampered battery-electric-vehicle (BEV) commercialization efforts in the 1990s⁶, the California Air Resources Board is now supporting conductive charging over inductive approaches. Conductive charging offers the possibility of using relatively standard wall sockets and power cords for PHEVs and hybridized H₂FCVs with smaller batteries than BEVs. Because of the potential convenience and familiarity of this incremental approach, conductive recharging is assumed here.

2.2.1.1 Costs and benefits

The Hybrid Electric Vehicle Working Group (HEVWG), led by the Electrical Power Research Institute (EPRI), estimated the price of an on-vehicle charging system at \$690 (2003 dollars, [13], p. A-7). Without overhead or OEM and dealer markups, the cost of the system supplied to the OEM is estimated at \$460 (ibid, p. C-4). For comparison, Delucchi et al. ([18] in [19]) acknowledge a large range about their mean estimate of \$300 for an *off*-board charger, and Kempton & Tomic [17] estimate \$200 to add wires and plug to a FCV for grid connection.

Possibly, particularly if the target market for PHEVs is the particularly motivated subset of knowledgeable existing or potential gasoline HEV buyers.

⁶ Failing to establish common standards is a common trap in high-tech commercialization (e.g., see Shapiro & Varain's "Art of the Standards Wars" in *California Management Review* 41:2, 8–32).

Although the benefits from charging today's, circa-2006/7 hybrids would be relatively inconsequential, several categories of benefit are in principle enabled by the ability to connect to external electrical supply⁷. These benefits increase as the size of the onboard electrical storage and traction motor are increased (see next section), as well as if electrical power, flowing along the same bi-directional connection used for charging, could be exported for uses other than propulsion (see section 2.3).

Among the potential benefits to emerge from enabling traction battery charging by giving hybrids electrical connections to other energy systems—i.e., by making them into Mobile Electricity (Me-) hybrids—might be:

- displacement of gasoline by electricity for vehicle power,
 - with the possibility of “all-electric range” (AER),
 - with potentially more rapid acceleration⁸, and potentially cheaper, cleaner⁹, quieter, and smoother driving, and
 - which may allow vehicle operation in combustion- or noise-restricted areas, and
 - engine-free vehicle features (e.g., higher-power entertainment systems, (pre-) heat/cool, etc.);
- home recharging using off-peak grid electricity,

⁷ Charging today's commercial hybrids would provide little benefit, because these vehicles' relatively small, power-assist traction batteries and control strategies are not meant to provide sustained energy for all-electric driving range, but rather are optimized to buffer the combustion engine from brief power transients, to capture bursts of power usually lost during braking, and to minimize idling by enabling engine shut-off and rapid restarting.

⁸ Unlike combustion engines that need to rev up to high revolutions before offering full torque, electric motors offer full torque at zero speed (i.e., at launch); electric motors could therefore enhance a given vehicle's acceleration, depending on its size relative to the vehicle's total requirements and the amount of electrical energy available for a given acceleration.

⁹ The extent of this depends, of course, on the source of electricity for charging. However, it should also be noted, whereas today's cars generally are dirtier in real use and grow more so with age, grid-mix electricity is expected to become cleaner with time, e.g., as old plants are retired and renewable portfolio standards are implemented.

- with the convenience of avoided trips to the petrol station¹⁰ concordant to the amount of gasoline displaced and
- a full battery each morning to maximize clean and silent operation in the residential neighborhood;
- reduced wear-and-tear on the vehicle's combustion system and certain mechanical systems,
 - with accordingly lower vehicle maintenance costs; and
- the ability to use the vehicle's electrical connection for exporting electrical power to a variety of other new and adapted innovations (see section 2.3).

With electrical energy-storage and drive supplementation (e.g., bigger batteries and motors), consumers that are able to periodically charge their vehicles from the grid could gain significant engine-free driving range and might realize significant levels of the benefits described above. Battery augmentation and all-electric range are discussed next.

2.2.2 *Battery supplementation, all-electric range (AER), and plug-in hybrid-electric vehicles (PHEVs)*

Although new analysis is emerging, until mid-to-late 2006 a series of reports lead by EPRI for the HEVWG remained the definitive publicly available analyses of augmented-battery, grid-rechargeable, plug-in hybrid-electric vehicles (PHEVs). In their accumulative 2004 report [13], the HEVWG analyzed the costs and performance of hybrids with traction batteries and electric motors sized to provide all-electric range of 20

¹⁰The opportunity to free oneself and family from gasoline refueling stations and oil-company profits via home recharging is often seen as attractive and has been the subject of consumer feedback given to GM, EPRI, ITS-Davis, and others.

[13] EPRI, "Advanced Batteries for Electric-Drive Vehicles: a Technology and Cost-Effectiveness Assessment for Battery Electric Vehicles, Power Assist Hybrid Electric Vehicles, and Plug-In Hybrid Electric Vehicles," EPRI, Palo Alto 1009299, May 2004,

[20] L. Burns, "Fuel Cell Vehicles and the Hydrogen Economy," presented at Asilomar IV: The Hydrogen Transition, Pacific Grove CA, 2003,

[21] K. S. Kurani, T. Turrentine, and D. Sperling, "Demand for electric vehicles in hybrid households: an exploratory analysis," *Transport Policy*, vol. 1, pp. 244-256, 1994..

or 60 miles (PHEV20s and PHEV60s). Several vehicle types and configurations were analyzed, requiring the HEVWG's judgment on a variety of cost and design variables.

Assuming, as did the HEVWG, that NiMH batteries now can be reasonably expected to have ten-year, 150,000-mile lifecycle characteristics sufficient for the frequent and relatively deep-discharge requirements of PHEV20s, the report calculates the battery prices necessary for gasoline HEVs and PHEVs to achieve lifecycle cost parity with conventional vehicles. The estimated battery prices are higher than what the HEVWG report's authors believe can be achieved in high-volume manufacture. For example, the 2004 report argues a plug-in, full-sized SUV would need 9.3 to 11 kWh of battery at \$427–\$455 per kWh, but that, at volume production, such batteries might cost \$352/kWh (p. A-7).

These and other calculations in the report are based on gasoline at \$1.75 per gallon; sustained higher gasoline prices imply higher “lifecycle parity costs” for batteries. Further, the study notes but does not include in its pricing: tax breaks, additional CAFE credits, the common automaker practice of subsidizing across products lines (which could be used to lower the incremental price of early plug-ins), adopting a loss-leader strategy, or the possibility of leasing/renting vehicle batteries.

2.2.2.1 PHEV uncertainties: Batteries and charging

Two important aspects of PHEV development and use that are likely to remain contentious for some time and deserve further comment are batteries and charging.

The 2004 HEVWG report is explicit about the challenges facing battery development while arguing that battery technologies might reasonably be expected to be able to meet some PHEV requirements in the near future. It focuses on NiMH batteries for their relative maturity, a conservatism if lithium technologies experience cost, life, and deep-discharge improvements. It uses performance and cycle-life data from battery suppliers, with increased confidence provided by real-world experience with similar technologies in fleet-operated RAV4EVs.¹¹ It further includes “car-company” battery cost estimates, scaled to appropriate energy levels, to validate its own.

Despite these efforts, automakers are likely to remain concerned about the availability and cost of batteries suitable for PHEVs. Achieving 10-year/150,000-mile life under repeated deep discharge conditions with the vehicle’s original battery is of particular importance to the viability of PHEV20s when compared to vehicles with larger batteries. As the report acknowledges (p. 2-3): “...confirmation of extensive deep cycling capabilities must still be sought through testing of batteries in modes representative of anticipated PHEV uses, and more confident cost predictions are needed for mass-produced PHEV-design batteries.”

Similarly, it is likely that automakers as well as policy makers will also continue to be concerned about the extent of the charging infrastructure required and the willingness of consumers to use it on a regular basis. The HEVWG reports highlight these issues, yet

¹¹ The 16 January 2006 edition of *Fleets and Fuels* newsletter notes that all 220 of utility SoCal Edison’s Toyota RAV4-EV battery SUVs are still operating on their original NiMH batteries.

tend to assume full daily charging in their analysis, a factor to which many of their conclusions are undoubtedly sensitive.

Additionally, the reports assume \$0.05/kWh electricity for recharging. A rate this low implies time-of-use (TOU) metering and/or special recharging rates. Although available in many areas, the required additional or modified metering presents an investment and implementation-time hurdle that should be explicitly explored.

Further, the reports claim, “The great majority of prospective owners have access to the standard 120 V electric outlets...” (p. 2-3). Yet it is unclear who “prospective owners” are and how many of them could cheaply and easily use such “existing infrastructure” for recharging PHEVs. For example, chapter 3 finds that only 5 to 10 million of 34 million Californians live in households that appear to be able to easily adopt and benefit from home-recharged EDVs. That relatively small early-market *potential* identified represents something of a hypothetical—if temporary and mutable—maximum from which sales are likely to be drawn. Assuming a modest initial market share on the order of 1%, the 5-million Californian target market segment studied might be expected to initially buy only 50–60,000 plug-in vehicles per year, hardly the sweeping transformation that might be implied if electrical infrastructure requirements are over-simplified or dismissed. Further, even with relatively widespread access to 120V outlets, section 2.3.4 highlights the issue of additional, more expensive levels of infrastructure service.

2.2.2.2 *What is going on?: Plug-in hybrid status and activities*

PHEV prototypes

Several prototypes have demonstrated one or more aspects of plug-in hybrid platform potential. Table 2-1 and appendix 7.1 illustrate the key features of five, including several Prius conversions in various stages of development and commercialization as of fall 2006.

As currently configured for sale, the Prius's power-assist batteries and relatively small¹² electric motor provide a couple miles or less all-electric driving range at speeds less than roughly 34 miles per hour without triggering the combustion engine to provide additional power and/or charge the batteries. Plug-in Prius conversions generally augment or replace the propulsion battery and thus increase the all-electric-range capability of the vehicle, but only within the limits of the original electric motor and overall control strategy. Claimed AER capabilities (at low speeds/power) for such vehicles are typically ~30–35 miles (e.g., [22]). With the higher speed/power requirements of typical daily driving, Prius conversions blend grid electricity as available into their operation as combustion hybrids. From the time the converted vehicle is fully charged from the grid to when its depleted charge requires it to operate as a self-contained gasoline HEV (e.g., ~40–60 PHEV-range miles), the claimed fuel economy for Prius conversions is typically roughly double that of the original Prius per gasoline gallon, not including the required electricity (e.g., [23]).

Table 2-1. Plug-in hybrid prototypes

	Dodge Sprinter plug-in prototype	EDrive Prius conversion	Prius+ NiMH conversion prototype	Hymotion L5 Prius conversion kit	Hybrids-Plus Prius conversion
Primary organizations	Daimler-Chrysler	EDrive (marketing) Energy CS (develop.) Clean-Tech (LA install)	CalCars, Electro Energy (EEEI)	Hymotion	Hybrids-Plus/ Energy Sense
Status	3 prototypes in U.S. as of Oct. '06; 30+ to be tested worldwide (18 in U.S.)	Announced will do commercial conversion beginning 2006	Single prototype conversion	Claim: now for authorized gov't and fleet install; for consumer use in Fall '06. Delivered 1 st conversion to external customer HOURCAR Sep. '06	Doing conversion; delivered one Sep. '06; one conversion will be given V2G capability for study with NREL.
Propulsion battery	Type	Soft Li-Ion	Valence LiIon	EEEI Bipolar NiMH	LiIon Polymer
	Capacity (kWh)	14.4	9	7.3	5
Price		\$12k installed (+Prius)		\$9,500 target (+Prius) for orders >100	\$32,500 (+Prius), \$15k by mid '07

Automaker PHEV activities

At least publicly, many automakers appear to still believe battery development has not progressed far enough to support PHEV commercialization. Nevertheless several automakers have revealed research activities. DaimlerChrysler is building plug-in prototype variants of its Dodge Sprinter Hybrid (see Table 2-1) to be tested in several U.S. cities. In 2005, the “PAPI Dream House” by Tron Architecture conceptually

¹² This is relative to what might be used in a plug-in hybrid or battery vehicle; the Prius's electric motor provides a significantly larger proportion of total power than many other

incorporated facilities for a Prius to both charge and provide emergency power. In April 2006, Toyota acknowledged a plug-in hybrid development program [24], but continues to highlight current battery limitations. Much speculation continues to surround any possible public release, including future generations of the Prius. The next-generation Prius will apparently have a ~9-mi AER (ibid). Meanwhile, GM, Ford and Nissan/Renault have announced various level of interest in, or at least scrutiny of, PHEVs.

Other notable activities (many of which are described in a chronology by calcars.org) include: a 2003–4 demonstration of a plug-in diesel-electric HUMVEE by the Marine Corps, a Mitsubishi concept car, and prototyping and development by Southern California battery-EV developer AC Propulsion.

2.3 “Plug-out” opportunities: What could be going on?

I term the other side of the Mobile Electricity coin “plug-out” hybrids. Plug-out opportunities include exporting vehicle power under various conditions, such as “on the go,” “in need,” and “for profit.”

2.3.1 Plug out “on the go”: Mobile power

The advent of electric-drive vehicles could facilitate the increasing use of mobile power for a wide variety of devices, gadgets, and appliances for work (whether blue-collar tools or white-collar office-on-wheels) or leisure. Much as roads allowed us to wander off the rails and wireless communications increasingly allow us to communicate off the wires,

commercial “mild” hybrid models.

Me- could further facilitate a wide variety of “untethered” activities, thereby decoupling activities from specific geographical locations.

Relatively little activity outside of the recreational vehicle and cigarette-lighter-plug-in-inverter industries has emerged. However, 12V outlets in cars are multiplying and increasing in power into 110V home-style outlets in some vehicle makes and models.

More sophisticated examples of mobile power are also emerging. In February 2005, Toyota reported it would test a Prius capable of producing 3kW at 120V with a rural electrical cooperative in Oklahoma “to identify technical issues and determine if there is a commercial market” [25]. Further, as mentioned in section 2.2.2, the “Toyota Dream House” by TRON Architecture was conceptually designed to be able to use the Prius for power in emergencies. In 2005, Toyota executive Shinichi Abe reportedly told the UK’s Guardian newspaper that future Toyota hybrids will be able to operate as mobile generators [24].

2.3.1.1 Free your imagination

This study will not present a specific “killer app” of untethered mobile power. The wide variety of potential opportunities makes simply cataloguing them difficult. However, before moving on to “tethered” Me- innovation, for which more obvious applications have been identified, it is worth noting that untethered electricity applications may be accordant with recent coverage in the business press about the importance to corporate product and business development of harnessing “do-it-yourself” and “lead-user”

innovation [26]. The question for the user-innovator then becomes, “What will you do when you can do anything, anywhere, anytime?” [14]

2.3.2 *Plug out “in need”: Emergency power*

Enhanced by dissatisfaction with utilities perceived as large, remote, unreliable, and customer-unfriendly, events like the California energy crisis, regional blackouts, and terrorist attacks fuel a desire for the independence and security of emergency power. An untethered example of emergency Me- is the publicized use of GM contractor hybrid pickups to run medical refrigerators in hurricane-damaged Florida. Taking this one step further, swarming multiple Me- EDVs to power an entire hospital or other facility is an example on the more “tethered” end of the emergency-power spectrum.

One of the most straightforward examples of plug-out opportunities to the consumer mind might be the use of a personal EDV to power an individual home in an emergency. Requiring relatively little coordination, using an EDV in this way might be the “simplest” plug-out opportunity. It would, nonetheless, presumably require onboard and off-board hardware. Onboard hardware will be discussed in more detail in section 2.3.4. Off-board hardware—a “Mobile Electricity Interface” (Me-I) that, for example, determines which household loads are priority and safely routes and monitors Me- power—is not treated in detail here, but rather simply highlighted as a possible area of valuable intellectual property development.

2.3.3 *Modeling untethered and emergency Me-*

The next section describes vehicular distributed generation for a profit. Modeling so-called vehicle-to-grid (V2G) power includes a description of most of the requirements for all plug-out opportunities (the most notable exception being the Me-I). However, it is worth introducing that modeling effort first in the somewhat simpler context of mobile power for untethered use and emergencies.

In order to illustrate plug-out Me- opportunities, a simple vehicle model was constructed for various EDVs using published vehicle energy-storage and fuel-economy and/or range ratings (EPA ratings were used where available for consistency). The model follows energy stored in the “tank” (i.e., compressed hydrogen vessel for H₂FCVs or traction battery for plug-ins and battery EVs) through various conversion losses to AC electricity potentially available for other uses, as a function of driving distance required. This allows the trade-offs between zero-tailpipe-emission¹³ driving and zero-emission power to be explored. Figures 2-1 through 2-3 explore such tradeoffs by introducing: the importance of infrastructure level-of-service (2-1), the capabilities of various electric-drive-vehicle types (2-2), and the abilities of these vehicles to provide residential emergency power (2-2 and 2-3).

Figure 2-1 illustrates zero-emission driving vs. power tradeoffs for a vehicle based on the Honda FCX with 2006 refueling software upgrades. The x-intercept in the bottom right hand corner of Figure 2-1 shows the FCX’s EPA-rated range of 210 miles (expected to

increase to 270 with the next generation). Were all of that fuel energy used for Me- rather than driving, a 1.8kW load could be powered for 35 hours (the top left corner of Figure 2-1). Higher-power loads would correspondingly reduce the amount of time a given level of fuel energy could sustain them.

The vertical red line in Figure 2-1 represents a rough threshold for typical driving. As noted by Kempton & Tomic ([17], abbreviated K&T05a in figures), the average daily vehicle miles in the U.S. was 32, according to the 1995 National Personal Transportation Survey. Similarly, the U.S. Department of Transportation Bureau of Transportation Statistics reports the average number of miles driven per day by people older than 15 in 2001 was 29.1 [27]. Adding a buffer of 20 miles for unexpected/unplanned trips [21] to the 32 average daily vehicle miles, 52 miles is used here to calculate the amount of driving energy one might want to reserve on a daily basis to assure use of Me- does not impede the primary (transportation) use of the vehicle.¹⁴ Thus, to reserve energy for average driving needs, only points on, or to the right of, the vertical red line in Figure 2-1 and subsequent figures should be considered.

¹³ or “elsewhere-emission,” henceforth simply “zero-emission”

¹⁴ Note that Kempton & Tomic (2005a) use 36 miles ($=0.5*32+20$) as their daily driving threshold for calculating V2G revenues. Only reserving half of average daily driving, however, has implications for infrastructure and behavior (e.g., it might imply both at-home and at-work charging/refueling) that 1) may not be accounted for in the assumed infrastructure costs, 2) may be a less appropriate paradigm for plug-in hybrids and FCVs than for BEVs, and 3) is not consistent with the 20-mile-range-buffer concept, which was meant as a safety net on top of a full day’s driving. Further, it is noted that the NPTS data is cross-sectional and has a large standard error; longitudinal household data would be more appropriate. Thus, using roughly 50 miles as a notional daily driving threshold is an

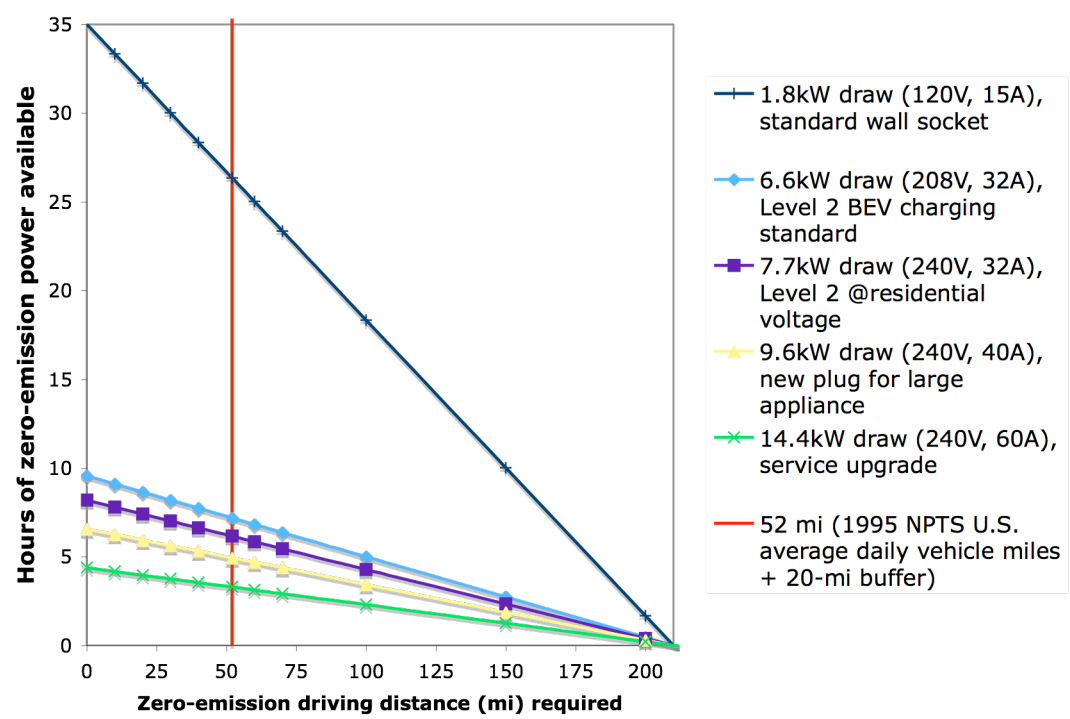

Fig. 2-1. Zero-emission Mobile Electricity vs. zero-emission driving: FCX 2006

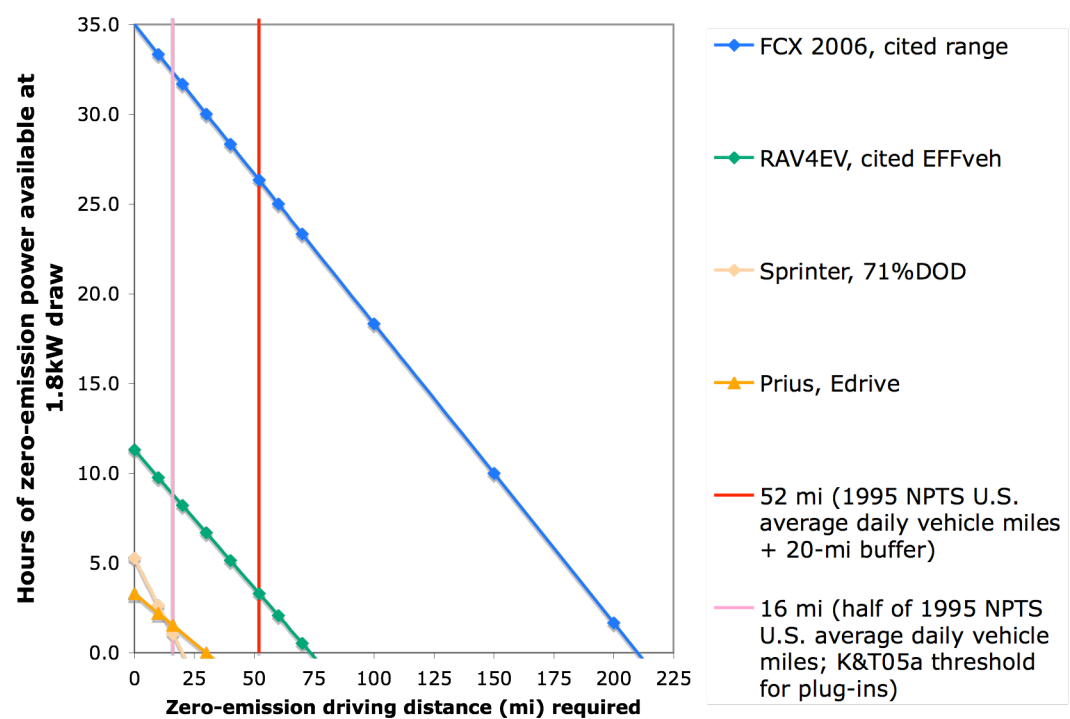

Fig. 2-2. Zero-emission Mobile Electricity vs. zero-emission driving: 1.8kW load

improved, if imperfect, aid for the exploration of driving-distance vs. Me- power tradeoffs.

Rather than showing power versus driving distance for one vehicle at various loads, as in Figure 2-1, Figure 2-2 depicts power versus driving for several vehicles at one load (1.8kW, representative of a standard wall socket and wiring). The FCX line extending from 210 miles to 35 hours can be seen as in Figure 2-1. In this and subsequent graphs, the FCVs are shown in blues. The model representation of the RAV4EV is shown in green, and two representations of plug-in hybrids are shown in oranges, one representing the Sprinter PHEV and one representing the edrive Prius conversion. An additional, pink vertical line represents a driving threshold for plug-in combustion hybrids, which do not have to reserve battery charge for driving but which will probably not have full batteries when called upon for Me-. In this case, following Kempton & Tomic¹⁵, it is assumed that half of average daily driving, or 16 miles, will have been completed in all-electric mode before providing Me-.

The 1.8kW load level is a reasonable proxy for average U.S. household loads, making the results depicted in Figure 2-2 an indication of how long each vehicle type could power a home in a blackout. Actually running an entire home would require matching transient loads higher than the average load, e.g., refrigerator/freezers and HVAC systems cycling off and on. Though these loads are not usually sustained for very long, as a bounding case Figure 2-3 gives a rough indication of how long each vehicle type could power a home at loads closer to U.S.-average peak levels. Because an “average peak” is still not the maximum peak electrical load that a home might present, there is a need to prioritize

electrical loads within the home in the event the vehicle is not capable of providing peak household power, either at all or for long periods.

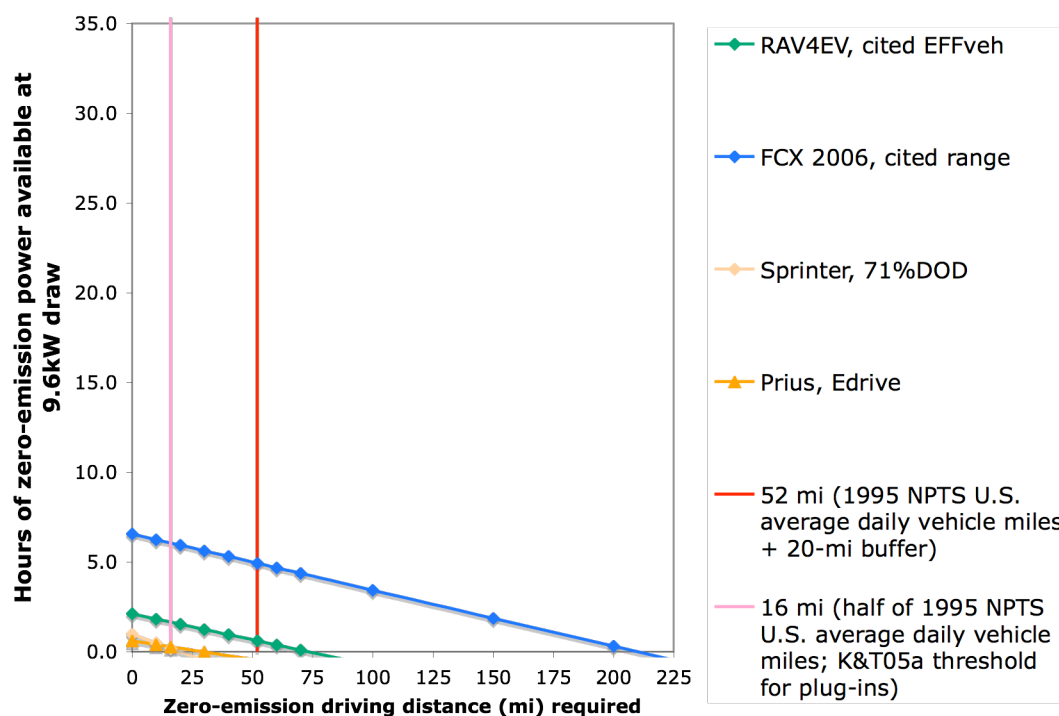

Fig. 2-3. Zero-emission Mobile Electricity vs. zero-emission driving: 9.6kW load

2.3.4 Plug out “for profit”: Vehicular distributed generation

Passenger cars are most households’ second-most expensive assets, after the home itself. By some measures, however, automobiles are extremely idle. Following a previous conceptual exercise [28], consider that we park our vehicles over 95% of the time, usually in habitual places. Further, even when employing the asset to move us from A to B, we typically use a small fraction of its peak power capacity. It takes roughly one-third

¹⁵ Kempton & Tomic use a 36-mile threshold for BEVs and H₂FCVs, significantly lower than the 52 miles assumed here.

of a typical car engine's peak power to cruise at highway speeds. This means households operate motor vehicles at an engine capacity factor of a few percent or less. From an electric utility perspective, this would be an abysmal generator utilization rate and a poor use of a valuable economic asset.¹⁶

Further, consider that the power-generating capability of the cars in the U.S. fleet is roughly 10^{12} hp, or several times the installed generating capacity of the U.S. electrical grid. Were there some profitable way to bring the opportunity of idle car-engine capacity to bear on the chronic under-capacity and power-quality problems of the electric grid, we would have a situation similar to science fiction writer William Gibson's commonly quoted characterization of other opportunities: "The future is already here—it's just unevenly distributed." Indeed, "redistributing" opportunity into a profitable future—employing vehicle engines capable of producing surplus electricity when parked to provide various grid-support services—is no longer a fanciful idea. V2G power is the subject of a growing body of literature (e.g., [10, 17, 19, 29]), initial proof-of-concept demonstrations [30], and continuing conversations between academics, technology providers, and government agencies.

2.3.4.1 The Electrical Grid

Recent major regional power outages in the U.S. and California's power crises demonstrate the complexity of assuring adequate production and delivery of electricity.

¹⁶ Of course households are buying much more than a simple power-plant. Part of what households buy when they buy an automobile is automobility—self-directed mobility available when they want it. Even a parked car is generating value to the household in the

Investment planning for generation capacity sufficient to meet uncertain future demands for electricity is a balancing act between the financial risks of over-construction and the benefits of economies of physical scale. Grid operation is complicated by daily and seasonal demand peaks and the need to precisely maintain power quality in the face of variable loads. Several markets have been created to help grid operators meet these and other challenges, a few of which have been targeted in the literature as promising opportunities for V2G power.

Problem: “Keeping the lights on”

“Keeping the lights on” is a complex and difficult mission. The electrical grid is seemingly easily disrupted by such commonplace occurrences as falling trees—let alone hurricanes or terrorist attacks—and its operation is perhaps poorly appreciated by household consumers expecting electricity with flip-of-the-switch convenience. Businesses, whose profits often critically depend on reliable power at predictable prices, equally depend on the successful operation of the grid. The challenge of successfully matching supply with demand for electrical services is pertinent to this investigation in several ways...

Investment in generation is lumpy.

Conventional power plants require large investments based on uncertain forecasts of electrical demand a decade or so into the future. Further, the consequences of underestimating demand (and therefore having inadequate supply) are too great, requiring

form of potential mobility. In this way, plug-in and some plug-out applications of ME

a construction schedule that assures an electrical surplus. The bigger the plant size used in a practice of over-construction, the lower the overall capacity factor, the more idle capital, and the greater the susceptibility to unexpected softening of demand.

One potential response is the deployment of smaller and flexible units of generation, abandoning the economies of scale of traditional power plants for an improved risk profile. There is evidence that the many, primarily financial, benefits of a more “distributed” power-generation approach have already begun to outweigh the physical economies-of-scale benefits that have historically led to ever-increasing power-plant size [31].

Electricity demand is peaky.

Daily and seasonal peaks in electrical demand must be met, diminishing the capacity factor and hurting the economics of plants that are not used during off-peak hours. Further, some of the largest generation units are the least flexible in this regard—it would not make sense to fire up a spare nuclear plant or two for a couple hours per day or year—and are therefore dispatched with the highest priority to ensure demand for their maximum, constant output. On the other hand, some of the plants used to cover the peaking requirement, e.g., single-cycle combustion turbines, operate at relatively low efficiency and produce relatively high emissions. This difference between the average and the marginal, e.g., peaking, efficiency and emissions resulting from powering the electrical grid is an important feature of discussions of vehicular distributed generation.

and Me- are ways to add to the value being generated by a parked vehicle.

The current response to meet the highly variable electric demand is the establishment of several “behind-the-scenes” markets for peak power and power quality, to be described next.

There’s more to it than generating electricity.

In addition to electricity generation, several issues relating to transmission and distribution are pertinent. Two important types of grid operators are: 1) local utilities, who manage “the wires” and 2) regional system operators (e.g., the California Independent System Operator or Cal ISO). The former faces complex investment decisions about maintaining and upgrading congested power systems. Distributed power, typically small enough and clean enough to be located close to sources of demand, can be utilized in these local distribution decisions as a tool to avoid or defer costly upgrades.

The regional operators, on the other hand, are charged with the larger-scale balance of supply and demand to maintain the quality of the electricity being bought by consumers. In order to precisely control the voltage and frequency of power on the grid, additional “behind-the-scenes” markets have been created for power-quality services, such as “voltage-regulation” and “spinning-reserves.” These markets involve paying a certain amount of reserve generation capacity to run in synchrony with the grid (or to otherwise be prepared to quickly supply grid-synchronized power) in the event that it is needed to maintain power quality, e.g., voltages within a narrow target range. Importantly, capacity employed in this manner gets paid for contracted availability whether or not energy is

actually produced and used. In California, both of these markets are formed on the basis of day-ahead and hour-ahead contracts, generally using a bidding process in which the regional system operator procures capacity until a sufficient amount of power is contracted, thereby setting the price [9].

As should already be clear by even the cursory discussion of the electrical grid presented here, several opportunities exist for suitably rapid-response, available, and/or distributed electrical-power and -service provision. Supplying these services with vehicular generation capacity is described next.

2.3.4.2 Kempton and Tomic V2G articles

Kempton & Tomic [17, 19] have clearly articulated the technical and business fundamentals of using vehicles to supply grid-support services. Their work argues that doing so could:

- earn owners of electric-drive vehicles from zero to thousands of dollars in annual net revenues,
- reduce demand charges for commercial electrical consumers,
- increase the stability and reliability of the grid,
- lower electrical system costs, and, eventually
- act as inexpensive storage for intermittent renewable electricity.

The latter point has caught the attention of the National Renewable Energy Laboratory (NREL), which has analyzed the potential use of PHEVs to buffer intermittent wind power, thereby increasing wind capacity and generation share [32].

Electric markets

Table 2-2 summarizes some of key features of the three markets considered as amenable to V2G power provision.

Table 2-2. Characteristics of electricity markets appropriate for V2G power*

	Response time	Revenue payments	Dispatch call frequency	Generation duration per call	Generation time (h/y)
Peak power	Medium	For <i>energy</i> generated [\$0.50/kWh]	~40–60 calls per year (back calculated from rule of thumb)	3–5h [4h]	Industry rule of thumb for central CA: [200h/y]
Spinning reserves	10min	For <i>energy</i> [\$0.03/kWh] and <i>capacity</i> per kilowatt available for contract period [\$0.007/kW-h]	[20 calls per year]	10min to 2h [1h]	[20h/y]
Regulation reg. up = supply electricity to grid; reg. down = draw from grid	<1min; direct control of independent system operator (ISO)	For <i>energy</i> [\$0.10/kWh] and <i>capacity</i> [reg. up&down: \$0.04/kW-h; reg. up only: \$0.02/kW-h]	Many short calls per day	A few minutes [reg. up&down: 20min; reg. up only: 1.4h]	[1/10 th of time plugged in = 657h/y]

*Kempton & Tomic model values are included in brackets for convenience and subsequent comparison.

Markets for peak power, spinning-reserves, and voltage-regulation require increasingly rapid response. Peak-power markets only pay participants for the energy actually supplied. In contrast, ancillary-service (spinning-reserve and voltage-regulation) markets also pay generation for being on-call and available, based on the power capacity

promised over a given contract period. Actual generation is typically rarely called upon each year in these markets, and even when it is, it is generally required for very short periods of time. Taken together, these features mean that these markets are relatively difficult to serve with large, expensive, power plants, and might be better served by small, agile, mobile generators scurrying about the electrical landscape.

Generation time

The last column in Table 2-2 shows the assumed time per year vehicles will be asked to generate energy (i.e., total call time or dispatch time) for each of the three markets being considered. An important determinant of both costs and revenues is the number of hours it is assumed vehicles will be plugged in and on call each day. Kempton & Tomic (2005a, henceforth abbreviated K&T05a) assume 18h/day (365day/y). Although this may seem high, vehicles tend to be parked for even longer periods, but perhaps not at a single location. To explore results more reflective of a single vehicle-to-grid infrastructure investment per vehicle—e.g., either at home or work, but not both—this analysis assumes vehicles are parked and available to the grid for 12h/day (11mo/year).

V2G Profits

Peak power revenues (and therefore profits) are sensitive to the usual variety of electricity-generation factors, such as “fuel”/input prices. However, because actual energy-production levels tend to be small in voltage-regulation and spinning-reserves markets, their revenues tend not to be very sensitive to the cost of fuel inputs or engine/energy-converter degradation. The profits for these markets are sensitive,

however, to the prices offered to generation capacity for being on call and to the capital costs of the various generation technologies.

2.3.4.3 The Mobile Electricity model, including vehicular distributed generation

Starting from Kempton & Tomic's conceptual description of V2G power [17], this section incorporates the new vehicle model described in section 2.3.3 into a plug-out Mobile Electricity model, including onboard and off-board costs and V2G net revenues. (Appendix 7.1.4 provides additional detail, including: a key summarizing the color-coding used throughout, cost and revenue equations and additional detail on calculation inputs.)

Whereas Figures 2-2 and 2-3 presented the plug-out capabilities of various EDVs at 1.8kW and 9.6kW loads, respectively, Figure 2-4 shows the power capacity those EDVs could sell into V2G markets for a 1-hour contract, as a function of how much energy they need to reserve for driving. Notice the familiar red and pink vertical lines representing the typical driving thresholds discussed in section 2.3.3.

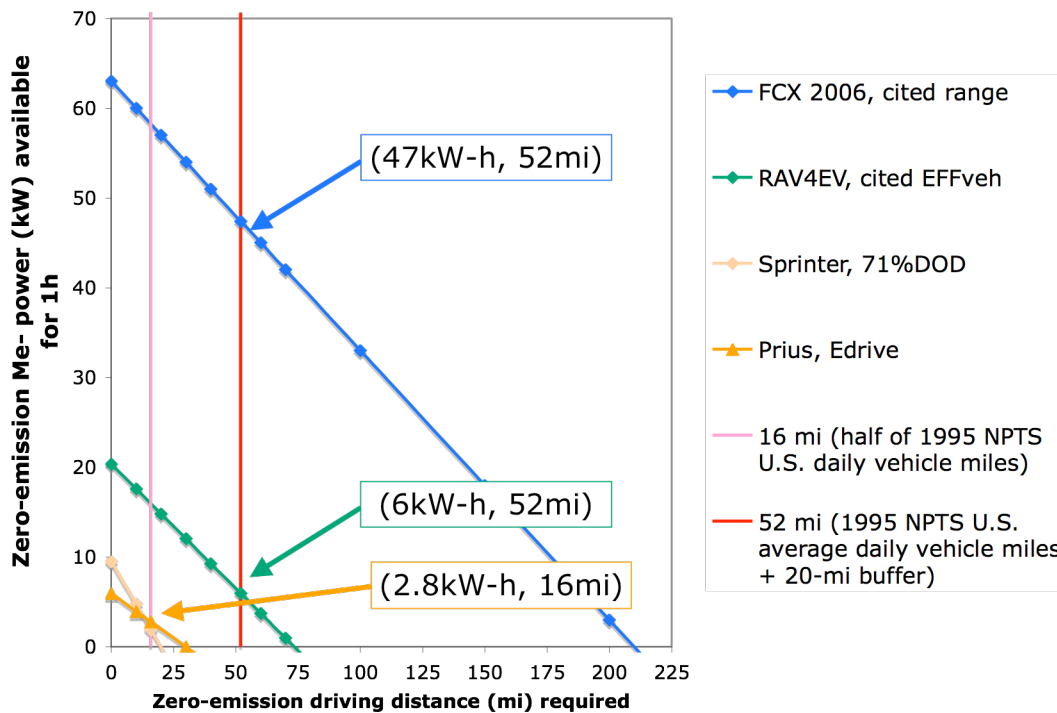

Fig. 2-4. One-hour zero-emission power capacity vs. zero-emission driving distance

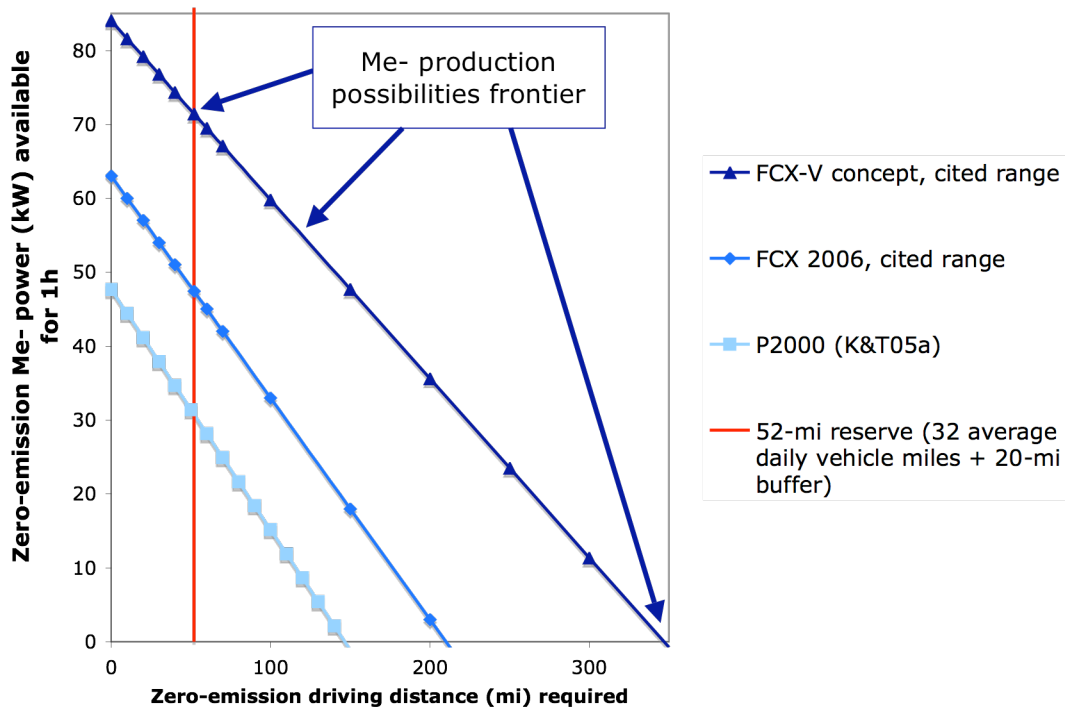

Fig. 2-5. One-hour power capacity vs. driving distance for various FCVs

The intersection of the red and blue lines in Figure 2-4 indicates that the FCX as represented in the model could drive 52 miles and then sell up to 47kW for one hour before depleting its fuel. This “red-line” or “fuel-limited” scenario will be used in subsequent discussion. Similarly, the intersection of the pink and orange-yellow lines shows the edrive Prius as modeled could sell 2.8 kilowatts of capacity for 1 hour (2.8kW-h) and 2.8 kilowatt-hours (2.8kWh) of zero-emission energy after driving 16 miles—i.e., half the average daily vehicle miles—in all-electric mode.

Figure 2-5 presents a similar picture, this time focusing exclusively on FCVs: the P2000 in the Mobile Electricity model using specifications characterized by Kempton and Tomic, the 2006 FCX (demonstrating a significantly improved capability relative to previous V2G analysis), and the FCX-V concept car. The latter has an uncertified range of roughly 350 miles and a correspondingly large Me- production possibilities frontier.

Vehicles modeled

Table 2-3 lists the various vehicle and infrastructure combinations modeled in the present analysis. Whereas [17] examines vehicles at illustrative power levels, (e.g., 15kW), this analysis explores each vehicle type at a variety of levels of infrastructure investment. The vehicles in black font and white (i.e., no) shading represent scenarios limited by infrastructure investment. The red and pink vehicles represent the “red-line” or “fuel-limited” design points discussed previously. The vehicles shaded in yellow with “max” labels represent bounding cases that use all of their fuel for Me- power, reserving none for driving.

Table 2-3. Vehicle and infrastructure combinations modeled

	Pspin (kW)	Preg (kW)	Ppeak (kW)
RAV4EV (K&T05a)	15	15	
RAV4EV	1.8	1.8	
RAV4EVfuellimit	6.0	17.9	1.5
RAV4EV	9.6	9.6	
RAV4EV	14.4	14.4	
RAV4EVmaxkW	20.4	50	
edrive Prius	1.8	1.8	
edrive Priusfuellimit	2.8	8.3	0.7
edrive PriusmaxkW	6.0	17.9	
P2000 (K&T05a) high	15		15
P2000 (K&T05a) low	15		15
FCX	1.8	1.8	
FCX	9.6	9.6	9.6
FCX	24.0		
FCXfuellimit	47.4	33.9	11.9
FCXmaxkW	63.0	45.0	15.8
FCX-Vfuellimit	71.5	51.0	17.9
PFCX	1.8	1.8	
PFCX	9.6	9.6	
PFCX	14.4	14.4	
PFCX	24.0		
PFCXfuellimit	47.4	8.3	11.9
PFCXmaxkW	63.0	17.9	

Incremental costs

Cost inputs

Table 2-4 summarizes the major cost assumptions for both the model presented here and by Kempton & Tomic ([17] or “K&T05a”).

Table 2-4. Cost inputs

	RAVEVs	K&T05a RAV4EV	PHEVs	FCVs	K&T05a FCV
capital recovery factor (CRF)	0.163	0.160	0.163	0.163	0.163
(kWhAC/kWhFUELavail)	0.74	0.73	0.74	0.50	0.41
cost of degrdation (\$/kWh)	\$0.0752	\$0.0752	\$0.1350	\$0.0100	\$0.0025
\$/unit fuel (kWh or kgH2)	\$0.1143	\$0.10	\$0.1143	US\$4	US\$1.7–\$5.6

In both the K&T05a case and this analysis, capital is annualized over 10 years at a discount rate of 10%, resulting in a capital recovery factor of 0.163 (with a minor variation of 0.16 used for the K&T05a RAV4EV case). In this analysis FCVs are charged an additional 33% of their initial engine costs over a 5,000-hour life for use as Me-/V2G generators. At \$100/kW, this amounts to ~1¢/kWh Me- produced, a rate four times greater than assumed in K&T05a and roughly equal to the “high-cost” scenario¹⁷ described in Lipman, Edwards et al. 2002 [10]. In this analysis, \$4/kg hydrogen is converted to AC electricity at ~50% average efficiency. The \$4/kg hydrogen roughly represents an efficiency-adjusted gasoline-cost-competitive level. It is between the K&T05a high (\$5.50) and low (\$1.70) cases, which are included for additional perspective.

Cost per unit energy (\$/kWh)

Based on the cost inputs just described, Table 2-5 presents the cost per kWh produced by various vehicles in the model. (For more information, please see appendix 7.1.4.) FCVs produce energy at roughly \$0.25/kWh (again, between the K&T05a high and low cases). Plug-in hybrids (i.e., the edrive Prius and PFCX when selling regulation) do worse because of high assumed battery degradation costs due to relatively deep discharging.

Indeed, the \$0.29/kWh for PHEVs may be optimistically low, and could be as high as \$0.42/kWh assuming shorter battery life. The model calculates that battery EVs will produce energy less expensively than either FCVs or PHEVs (~\$0.23/kWh calculated here) because of shallow discharges and overall higher vehicle efficiencies.

Table 2-5. Vehicle generation costs per unit energy (\$/kWh)

	cgen (/kWh)
RAV4EV (K&T05a)	\$0.21
RAV4EV	\$0.23
RAV4EVfuellimit	\$0.23
RAV4EV	\$0.23
RAV4EV	\$0.23
RAV4EVmaxkW	\$0.23
edrive Prius	\$0.29*
edrive Priusfuellimit	\$0.29*
edrive PriusmaxkW	\$0.29*
P2000 (K&T05a) high	\$0.42
P2000 (K&T05a) low	\$0.13
FCX	\$0.25
FCX	\$0.25
FCX	\$0.25
FCXfuellimit	\$0.25
FCXmaxkW	\$0.25
FCX-Vfuellimit	\$0.25
PFCX	\$0.25/\$0.29*
PFCX	\$0.25/\$0.29*
PFCX	\$0.25/\$0.29*
PFCX	\$0.25/n.a.
PFCXfuellimit	\$0.25/\$0.29*
PFCXmaxkW	\$0.25/\$0.29*

*May be as high as \$0.42/kWh with shorter battery life assumptions

¹⁷ The three scenarios described are: 25% over 4k h, 33% over 10k h, and 50% over 40k h

Time energy produced

Table 2-6 shows the assumed time per year vehicles will be asked to generate energy (i.e., call time or dispatch time) for each of the three markets being considered (spinning reserves, regulation, and peak power). An important determinant of both costs and revenues is the number of hours it is assumed vehicles will be plugged in and on call each day (tPLUG in Table 2-6). K&T05a assumes 18h/day (365day/y). This may seem high, but vehicles tend to be parked for even longer periods, but perhaps not at a single location. To explore results more reflective of a single vehicle-to-grid infrastructure investment per vehicle—e.g., either at home or work, but not both—this analysis assumes vehicles are parked and available to the grid for 12h/day (and 11mo/year).

Table 2-6. Dispatch time (time energy produced in h/y)*

	Here	K&T05a
tspin (h/y)	3.3	20
tPLUG (h/y)	4020	6570
disntch/contrct	0.1	0.1
treg (h/y)	402	657
tpeak (h/y)	200	200

*Throughout, yellow font indicates uncertain value (caution)

Infrastructure capital costs

Table 2-7 shows the assumed investment required for residential V2G at various levels of power capacity. It is assumed that electrical service upgrades will be required at higher power levels, increasing costs and decreasing market potential (e.g., from 10 to 5 million Californians)—an issue of concern explored in chapter 3 and [16], as described previously.

Table 2-7. Residential infrastructure capital costs

Volts (V)	Amps (A)	Pline (kW)	Comments
120	15	1.8	existing 120 outlet (minimum infrastructure) \$0 for 120V AC outlets, \$50 for 25' of 5–10 AWG (40–15 A) copper wire
Total cost:		\$50	
240	40	9.6	40A plug & wires (Level 2AC=7.7kW) \$80 retail for 125A panel with a 60A GFI, \$25 retail for 14–50R outlet, \$100 retail for 40' of 4AWG gage copper wire (4AWG can handle 60A), \$450 for 5h labor at \$90/hour: based on [17] for a new 50–70A outside plug to a circuit box already having sufficient capacity, 40' away; [18] acknowledges a large range about the mean, but estimates \$700-800 for a plug
Total cost:		\$655*	
240	60 or 24.0	14.4 or 24.0	60A plug & service upgrade to shore up 100A circuits 100A (spinning only subtracting from house load on 100A circuit) Based on [17] for 15kW residential connection retrofit for spinning reserves or regulation and charging. Note: "If a service upgrade (say, from 100 to 200A) is required, the cost could increase by US\$1000 up to as much as US\$5000, mostly for labor, including permitting, shutoff, etc.," (p. 292).
Total cost:		\$1,500	
240	80	19.2	80A plug & service upgrade to shore up 100A circuits [17]: \$1,500 for 15kW residential connection retrofit for spinning reserves or regulation and charging
Total cost:		\$1,800	
240	400	96.0	up to Level 3AC standard appendix "If a service upgrade (say, from 100 to 200A) is required, the cost could increase by US\$1000 up to as much as US\$5000..." ([17], p. 292)
Total cost:		\$5,000	

*Note: As described in chapter 3, ~10M Californians appear pre-adapted (i.e., easily able) to adopt Me- vehicles. However, at power levels greater than standard wall sockets, this drops to ~5M, unless it is assumed either that all residences have sufficient electrical facilities or that they are willing to upgrade (e.g., for \$1–5,000 as illustrated here).

Vehicle incremental capital costs

Table 2-8 shows assumed incremental vehicle capital costs for V2G (i.e., on top of what you pay for to drive the vehicle from A to B). See section 2.2.1.1 for comparison to charging-only costs.

Table 2-8. Vehicle incremental capital costs for V2G

Plugged-in vehicles (BEVs and PHEVs, including PFCVs)	
	Based on [12]: an AC Propulsion purpose-built V2G power electronics with "extensive control and safety to ensure no back feeding of power onto the grid during an outage, added \$400 to the initial cost, assuming moderate production runs," (p. 18). Similarly, [18] acknowledges a large range about the mean, but estimates \$300 for an off-board charger.
	\$400
Fuel-cell vehicles (FCVs)	
	[17], p. 276: \$450 for power electronics to synch to 60Hz and provide protection, \$200 for wires and plug for grid connection
	\$650

Cost summary: red-line vehicles

Table 2-9 summarizes the costs for each of the vehicle types providing V2G at the “red-line” or fuel-limited design point and are characterized as such in red and pink in the table (not to be confused with the accounting convention of using red). Additional detail is available in appendix 7.1.4, including cost and revenue equations.

Costs range from a couple hundred dollars per year for providing low-power spinning reserves (using batteries, the green box) to several thousand dollars per year providing high-power regulation (using FCVs, the blue box). It is also worth noting that peak-power costs are similar in nature and magnitude to those for spinning reserves (the brown boxes).

Table 2-9. Cost summary: “red-line” (fuel-limited) vehicles

	Pspin (kW)	Preg (kW)	cSPIN	cREG	Ppeak (kW)	cPEAK
RAV4EVfuellimit	6.0	17.9	\$176	\$2,004	1.5	\$141
edrive Priusfuellimit	2.8	8.3	\$174	\$1,138*	0.7	\$113
FCXfuellimit	47.4	33.9	\$959	\$4,298	11.9	\$801
FCX-Vfuellimit	71.5	51.0	\$979	\$6,009	17.9	\$1,236
PFCXfuellimit	47.4	8.3	\$918	\$1,138*	11.9	\$760

*Shorter battery life may increase by ~\$450

V2G net revenues

Table 2-10 summarizes revenue inputs and red-line-vehicle net revenue results. Spinning-reserves and regulation revenues are very much a function of the capacity prices offered (the black box), as well as, to a lesser extent, the energy prices offered (the grey box).

Table 2-10. Revenue inputs [17] & the bottom line: V2G net revenues, red-line vehicles

pcapSPIN (/kW-h)=	\$0.007	pcapREGup&down (/kW-h)=	\$0.04	pelSPIN (/kWh)=	\$0.03	pelREG (/kWh)=	\$0.1143
-------------------	---------	-------------------------	--------	-----------------	--------	----------------	----------

	Pspin (kW)	Preg (kW)	NETrevSPIN	NETrevREG	Ppeak (kW)	NETrevPeak
RAV4EVfuellimit	6.0	17.9	-\$8	\$1,696	1.5	\$8
edrive Priusfuellimit	2.8	8.3	-\$96	\$584 *	0.7	-\$44
FCXfuellimit	47.4	33.9	\$381	-\$17	11.9	\$385
FCX-Vfuellimit	71.5	51.0	\$1,039	\$440	17.9	\$550
PFCXfuellimit	47.4	8.3	\$421	\$584 *	11.9	\$426

*May be as low as \$133 with shorter battery life

Using batteries to provide spinning reserves or peak power appears to be of limited interest from a net revenue perspective (the green boxes in the NETrevSPIN and NETrevPeak columns). Net revenues for the edrive Prius and RAV4EV in these markets are negative or small in each case. The best financial play is for battery EVs to sell regulation (the other green box). This is in part because batteries allow the vehicle to sell

both regulation-up (capacity to produce power) and regulation-down (capacity to consume power, which can be used to charge the battery).

The next most promising V2G opportunity is to use a FCV to sell spinning reserves (left blue box), due to its high power capabilities even in fuel-limited conditions. Additionally, it appears a FCV selling peak power might also do well (right blue box). Indeed, it might be profitable to design plug-in FCVs capable of selling regulation (teal box), although that depends on the life of small (and therefore more deeply discharged) batteries and the details how regulation from a PFCV would be provided and managed.

The model indicates it is not worth (from a net revenue perspective) selling regulation-up only using a FCV, unless the vehicle is so high-power capable, like the FCX-V concept, that it can cover the high costs of high-power infrastructure (center blue box).

Table 2-11 shows net-revenue results for the full array of vehicle/infrastructure combinations modeled. Two additional sets of observations are worth noting from the net-revenues perspective.

First, because infrastructure capital costs are lumpy and uncertain but assumed high at high power levels (due primarily to electrical service upgrades which include significant labor costs), the benefits in high-power V2G scenarios tend to be dampened. This disproportionately hurts FCVs. Further, comparing net revenues from the same vehicle but at different levels of infrastructure shows that “bigger isn’t always better,” especially

on a per kW basis. Note how the FCX loses money on regulation at 33.9kW, but nets a profit selling regulation at 9.6kW. Thus red-line power scenarios are not always, as one might initially expect, the optimal revenue point, particularly when they lie at a power level just high enough to require a major infrastructure upgrade to connect the vehicle to the grid.

Table 2-11. Net revenues: The whole gang

	NETrevSPIN	NETrevREG	NETrevPeak
RAV4EV (K&T05a)	\$331	\$2,532	
RAV4EV	-\$24	\$133	
RAV4EVfuellimit	-\$8	\$1,696	\$8
RAV4EV	\$92	\$930	
RAV4EV	\$86	\$1,343	
RAV4EVmaxkW	\$201	\$4,859	
edrive Prius	-\$24	\$90*	
edrive Priusfuellimit	-\$96	\$584*	-\$44
edrive PriusmaxkW	-\$9	\$1,262*	
P2000 (K&T05a) high	\$175		-\$145
P2000 (K&T05a) low	\$261		\$717
FCX	-\$65	-\$66	
FCX	\$51	9.6kW: \$43	\$271
FCX	\$308	33.9kW: -\$17	\$385
FCXfuellimit	\$381		
FCXmaxkW	\$809	\$280	\$444
FCX-Vfuellimit	\$1,039	\$440	\$550
PFCX	-\$24	\$90*	
PFCX	\$91	\$699*	
PFCX	\$86	\$997*	
PFCX	\$349		
PFCXfuellimit	\$421	\$584*	\$426
PFCXmaxkW	\$849	\$1,262*	

*Regulation net revenues for plug-in hybrids (edrive Prius and PFCX) decrease considerably with shorter battery life

A second observation from Table 2-11 is that the most infrastructure-limited vehicles have difficulty making profits (the green, orange, and small blue boxes). Thus the “no new infrastructure” claim for charging PHEVs may not hold for plug-out opportunities—especially for a V2G power, and in particular for the sale of spinning reserves.

Further observations

Sensitivities

The results are sensitive to variation in the number of hours per day the vehicles are plugged-in (tethered) and on-call.¹⁸ This may largely explain why the “maxed out” RAV4EV (reserving *no* fuel for driving) calculated here as a bounding case did not perform as well as the K&T05a RAV4EV illustrative example. The results are not sensitive to even a four-fold increase in FC degradation costs. Nor are they sensitive to a four-fold increase in the price received for spinning reserves energy. (However, spinning-reserves energy price of course becomes more important as the dispatch time per year increases.)

So is V2G an attractive opportunity?

At first glance, some of the annual net revenues offered by selling grid-support services appear modest. It is reasonable to ask if they provide enough motivation to all the players that need to be involved, either in terms of shared margins or embodied in properly accounted-for costs. On the other hand, netting even a few hundred dollars per year with

¹⁸ The results are not particularly sensitive to variation in the number of days the vehicles are available per year, perhaps simply because the variation thought reasonable to explore

a previously idle asset with system-wide benefits for the electrical grid and commercialization benefits for EDVs may seem a “no-brainer” to some. Or, from a more academic point of view, if the assumptions in this analysis are reasonable, with sufficient conservatisms to help balance the effect of simplifications and uncounted or unforeseen additional costs, one might argue that the overall promise of vehicular distributed generation is at least good enough to continue its study. However, assuming for the moment that the generally more conservative set of assumptions¹⁹ used in this study relative to previous work squeezes the margins of V2G profitability somewhat uncomfortably, the question of how to frame the potential benefits becomes more important. One might ask, “What might make the margins look better?” One possible approach is aggregation, introduced here and discussed further in chapter 4.

V2G Aggregation

The residential case is perhaps a relatively simple case in that it would involve individual households having the freedom to make individual decisions about how to use their vehicles and what costs to bear for what level of plug-out services they desire. In most other regards, however, it is likely to be the most difficult to implement and the longest-term of the Me- opportunities. For example, it requires each vehicle to bear the costs of relatively high-power V2G infrastructure and requires tremendous coordination between the grid, the independent system operators, and every household selling V2G services. Although previous research has argued that this may be possible and profitable, this

here (12 months to 11 months) is much smaller on a percentage basis when compared to the number of hours per day (18 hours to 12 hours).

modeling effort views the residential case as a high-cost launching point for these markets, vehicles, and services.

The residential case requires sophisticated aggregation of *transactions*, much as cell-phone and other companies manage for large numbers of customers, sometimes at quite narrow margins. Initially for vehicular distributed generation, however, *spatial* aggregation might be attractive. Whether initially for fleet-owned or privately-owned vehicles, spatial aggregation into “parking-lot power plants” would offer various benefits. These include the ability to spread infrastructure costs, simplify coordination, limit bi-directional power flow centers and the need for time-sensitive price signals, aggregate capacity and energy supply into utility-friendly and distributed-generation-hardware-friendly units (e.g., megawatts), and aggregate V2G benefits. It could also open up additional, related opportunities, such as supplemental refueling, green branding and other product differentiation, reduced commercial demand charges, and strategic load shedding (especially off congested distribution trunks).

A conceptual example of a parking-lot power plant using idle hybrid airport-rental cars to provide local and system-wide electricity services is shown in Figure 2-6 and described in chapter 4. This configuration might smooth the car-rental industry’s seasonal and weekly rental-revenue variability and relax inventory constraints while increasing the public’s exposure to EDVs at reduced rental costs.

¹⁹ The major exception is of course the overall improved capabilities of FCVs resulting

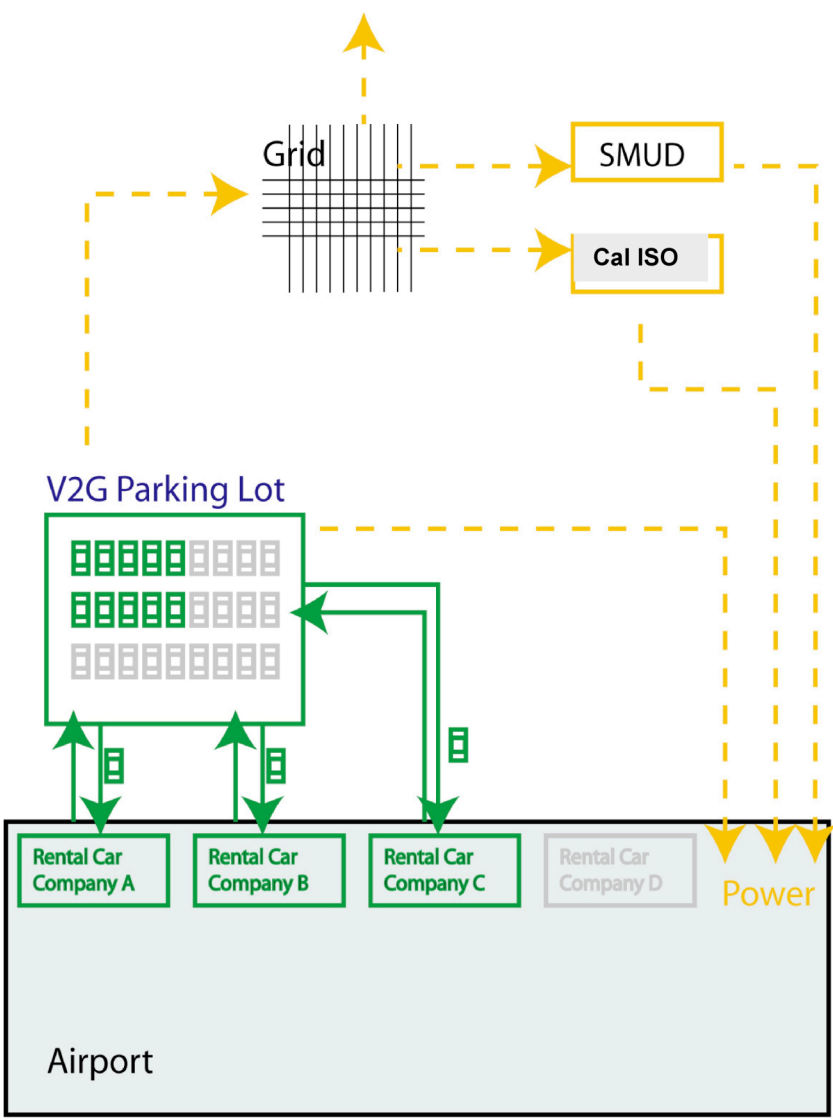

Fig. 2-6. V2G aggregation: airport rental example [11]

The airport-rental-car parking-lot power plant is one example to stimulate thinking about V2G aggregation opportunities and early (pre-household-market) product, market, and business development. It is discussed further in section 4.4. To conclude this discussion of vehicular generation and plug-out opportunities, let us return to the net-revenue results and some comments about technology development.

from the vehicle specifications and model used here relative to previous representations.

2.3.5 Plug-in/-out hydrogen-fuel-cell vehicles

Given 1) that even the best FCX/infrastructure combination modeled here earns modest spinning-reserves net revenues, 2) that even a relatively small plug-in battery doing regulation appears profitable (assuming ongoing improvements in battery life), and, 3) the Me- framework presented here, there is a case to be made for commercializing H₂FCVs as plug-in/-out H₂FCVs, that is Me-FCVs.

The opportunity to develop Me-FCVs opens up new infrastructure questions. Might Me-FCVs be recharged at home (for daily needs) and hydrogen refueled abroad (for longer trips)? Or vice versa? Although the latter option seems less likely due to the costs of stand-alone small-scale hydrogen production, the home energy station being developed by Honda to supply hydrogen to cars and electricity and heat to homes might be even more valuable if it sends the family car with a full tank each day out into a fuel-neutral Me- world to earn some revenues.

Either way, it appears time to move beyond framing batteries and fuel cells in a zero-sum game, and to start thinking of them as complimentary. A “Unified Theory of Mobile Energy” of sorts is discussed in chapter 4’s treatment of Me- technology development.

2.4 Chapter summary and conclusions

This research lays a foundation for subsequent exploration of how to successfully commercialize H₂FCVs, other EDVs, and other Mobile Electricity technologies. Such

research bridges several disciplines and activities to inform effective demonstration projects, scenario formulations, and other technology assessments and marketing studies. Additionally, use of Mobile Electricity (Me-) innovation as the example of an innovative driver of commercialization highlights the important relationship between H₂FCVs, plug-in hybrids, and broader energy systems, such as the electrical grid.

This chapter, a “Mobile Electricity assessment,” integrates previously disparate technology analyses and activities into a Me- framework. It describes both “plug-in” and “plug-out” opportunities. The plug-in discussion presents an overview of analysis and activities and discusses critical issues related to the Me- framework as a whole (e.g., batteries and charging). The discussion of plug-out opportunities is more a discussion and analysis of what *could* be going on in Me- development. To describe exporting electricity off-board the vehicle for non-motive purposes, “on the go,” “in need,” and “for a profit,” it illustrates costs and benefits, power vs. range trade-offs, vehicle and building incremental capital costs, and vehicular distributed generation net revenues under various sets of assumptions for various EDVs. The discussion of vehicular-distributed-generation (the “endgame” of plug-out opportunities?) builds upon, and is indebted to, previous vehicle-to-grid (V2G) power studies, particularly Kempton & Tomic 2005a.

Compared to past work, the electric-drive-vehicle and net-revenue models developed for this Me- study have been adapted to better accommodate H₂FCVs and other “fueled” vehicles and to explore Me- power vs. range tradeoffs, infrastructure level-of-service, and other aspects of the Me- framework. Additionally, the modeling discussed here uses

somewhat more conservative input assumptions (e.g., more energy reserved for daily driving and less vehicle availability for vehicular distributed generation) but up-to-date H₂FCV specifications. The results are largely concordant with previous studies, but highlight the importance of: vehicle recharging infrastructure limitations and uncertain capital costs; battery life; daily plugged-in availability; and aggregation of vehicular distributed generation.

This analysis indicates that Mobile Electricity opportunities appear to be an initially expensive yet promising driver of the commercialization of green vehicle technologies. If their costs appear prohibitive when considered as add-ons to conventional vehicles, they must be weighed against consumer willingness-to-pay for “green cars” and, perhaps more importantly, new products and services. This raises interesting questions about what constitutes optimal vehicle, refueling, and electric infrastructure design and how the benefits of green vehicle technologies can be successfully realized. Chapter 4 begins to pursue the strategic recommendation to explore plug-in/-out H₂FCVs (Me-FCVs) by bringing together battery and fuel-cell development activities into a unified view of Mobile Energy platform development. Doing so would create new consumer-behavior and infrastructure opportunities (e.g., recharge at home, refuel abroad) and reposition H₂FCVs, when they are ready, as one possible gold standard for providing clean, high-power, and potentially higher profit ME services into markets created by early Me-market pioneers. Indeed, as Figure 2-5 illustrates, the Me- production possibilities frontier (i.e., the capability of H₂FCVs to provide zero-emission driving and Me- power) appears to be large and expanding at a relatively rapid rate. Concordant with a desire to

present results for existing, not speculative, vehicles, this study did not explore the capabilities on the relatively near horizon of vehicles such as the FCX-V prototype. However, the improvements embodied in such combustion-free vehicles offer even greater potential Me- benefits, such as V2G profitability (although at diminishing returns in cases where vehicle capability outstrip infrastructure capability/investment). Thus, over time the prospects for Me- from various sources will undoubtedly shift, and might be even brighter overall than those presented here.

Chapter 3 quantifies and characterizes a promising early market segment for plug-in hybrids, H₂FCVs, and other Mobile Energy technologies. Future work further amalgamating that analysis with the analysis described in this chapter would allow a subtler, less averaged exploration of who is Me- capable and how they might benefit. Target market demographics can be used to increase Me- modeling sophistication by helping to determine and characterize important model inputs such as vehicle availability (hours per day and daily driving, which varies significantly by, e.g., employment status, gender, and age), vehicle type (energy storage and conversion), and housing characteristics (likely required infrastructure investments and emergency power needs). Research questions specific to market/case-study selection (introduced in chapter 4) will also help drive the development, as needed, of other model enhancements (e.g., battery cycle life, fuel-cell power production efficiencies, and engine degradation as a function of scenario-specific load and use) as well as further, context-specific sensitivity analyses.

Chapter 4 begins to apply innovation, business-development, technology-management, and strategic-marketing lenses to the problem of commercializing H₂FCVs, other EDVs, and other Mobile Energy technologies. One of the goals of chapter 4 is to take one possible future state (e.g., widespread commercialization of the Me-FCVs characterized in section 2.3.5) and discuss issues related to technology- and market-development for the Me- innovations described here that emphasizes the particular challenges of “getting started.”

Collectively, the portrait of Me- presented here does not point comprehensively or directly to a V2G H₂FCV future. Many unanticipated and unknowable factors will doubtlessly impact progress and change the destination, let alone the signposts along the way. Rather, the discussion tries to encourage the discourse about electric-drive commercialization to focus on the relatively specific details of product design—which is critically important to consumer adoption and the successful formation of a supportive industrial community [33]—and present a plausible development pathway that highlights important considerations and indicates how to proceed, or not, at various decision points along the way.

3 Who might be among the first to benefit from Mobile Energy innovation?: The early California household market

3.1 Chapter overview

This chapter, published in preliminary form as [16], explores the household market for privately owned H₂FCVs and plug-in hybrids. It identifies, estimates, and characterizes the subset of California households most able to adopt Mobile Energy (ME)²⁰ in the relatively near term. Questions addressed by this chapter include: “What is a reasonable maximum initial sales pool for H₂FCVs?”; “Who are the target consumers?”; and “What conditions that limit the market potential today might change over time to expand the potential market?”

Patterned upon previous research at ITS-Davis [34] the following tasks were completed:

1. A segment of California households “pre-adapted” to adopt ME technologies earlier than average is identified and quantified from the 2000 U.S. Census Public Use Microdata Sample (PUMS) data using various combinations of Census-variable proxies for theoretical constraints criteria identified in the literature (e.g., number of vehicles per household; ownership and size of residence, availability of electricity and/or natural gas for home refueling/V2G power, commute time, etc.).
2. The sensitivity of the results to the criteria employed is explored to illustrate the importance of the various assumptions to the results.

²⁰ Although the focus of this chapter, as of the dissertation, is Mobile Electricity (Me-), the methods used in this market analysis are broadly applicable also to home refueling using gaseous fuels. Indeed, some discussed of the markets for home hydrogen is

3. The subset of pre-adapted households is analyzed statistically in SPSS for differences relative to the total household market in their mean values and distributions of other Census variables, such as income and educational attainment.
4. A few of the implications of this analysis for the complex yet critical relationship between ME, home refueling, and H₂FCV design options, such as vehicle range, are highlighted.

3.2 Methodology

3.2.1 Capability-constraints analysis

“There are two sorts of people, those who divide people into two sorts, and the others.”
—statistical maxim.

In order to identify early markets for vehicles fueled at home and/or connected to energy grids other than gasoline, a capability constraints approach is used here. This approach segments the population into two groups on the basis of physical and behavioral constraints deemed desirable, if not necessary, for early ownership of ME-enabled H₂FCVs. The target market segment identified is thus a group of households or individuals “pre-adapted” to use and benefit from ME innovation.

included (section 3.4.3). Thus the more inclusive category, Mobile Energy (ME) is used throughout.

3.2.1.1 “Pre-adapted”

Several aspects of this approach are worth highlighting. First, the identification of the “pre-adapted” target segment for early adoption of H₂FCVs is based solely on measures thought to indicate a consumer’s *ability* to benefit from ME innovations. Thus it does not take into account *beliefs, tastes*, or other important determinants or aspects of *purchase behavior*. It identifies a more narrowly defined research population for subsequent study of these factors.

3.2.1.2 “Initial market potential”

Further, the target segment identified in this study gives an indication of *market potential*, the pool from which initial H₂FCV sales are likely to be drawn. Thus, vehicle *sales*, a given automaker’s or product’s *market share*, and the *buy-down base* over which the incremental costs of the technology can be spread are necessarily (much) smaller numbers. In this sense, the market potential identified here represents a sort of theoretical maximum initial sales pool.

This maximum, however, is not immutable. It is more like a “snapshot,” formed on the basis of historical relationships embodied in the data and a set of assumptions about how consumers might, or might not, be able to benefit from ME as it is now conceived. Not only are the constraints identified in the literature less precise than might be hoped (unnecessarily eliminating certain consumers from consideration while keeping many unlikely to adopt ME), the filtering criteria are also, not surprisingly, blunt proxies for these theoretical constraints. Additionally, the market potential identified is the *initial*

potential. Given time, the consumers eliminated from consideration by this study will overcome one or more of the constraints currently thought to preclude their easy adoption of the technology (an issue at least partially addressed by a sensitivity analysis of the assumptions employed—see section 3.3.1). However, to the extent that the filtering criteria used here *are* precise enough to be thought useful, the constraints they represent are not expected to be overcome without cost (i.e., requiring an additional investment of time, effort, and/or money on the part of the consumer that would reduce the likelihood of adoption), making the analysis sufficiently robust to usefully define the limits of the market potential for ME in the near-to-mid term.

3.2.2 Data: U.S. Census microdata sample

The data used in this study came from the 1% Public Use Microdata Sample (PUMS) of the 2000 U.S. Census. This data set consisted of some 274 variables describing 339 thousand individual cases representing 34 million Californians (choice of California described in section 3.2.3). This data set includes the most detailed Census demographic and household characteristics available to the public, suitably aggregated and otherwise treated so as to not reveal individually identifiable confidential information.

3.2.3 Theory: Constraints/filtering criteria

The filtering criteria employed were derived from demographic, behavioral, and other characteristics gathered in various bodies of the alternative-fuel-vehicle (AFV) literature as indicating the ease with which a household or individual could adopt AFV technology. These characteristics largely speak to the household's/individual's ability to incorporate an AFV into their "household vehicle fleet" and to connect vehicles to other energy

systems, such as refueling/recharging, at home. They have been boiled down to a handful of relatively simple, common-sense criteria.

3.2.3.1 Spatially segmented AFV commercialization strategy

Geographically limited deployment could aid AFV commercialization by: concentrating demand; focusing marketing, distribution, and sales efforts; increasing utilization of infrastructure [35] and other complimentary assets; creating business clusters; simplifying regulatory compliance and the establishment of supportive standards; and consolidating a political-support base. This scope of this study is limited to the state of California for these and other reasons. California is an obvious choice for its long regulatory support of AFV technologies and high consumer demand for green technologies. Less obvious might be its relatively self-contained and somewhat geographically distinct large economy and history of uniquely stringent fuel and conventional vehicle standards. [7]

3.2.3.2 Home connection hardware

In order to enable most ME innovations—in particular home refueling and/or recharging or emergency, back-up, or vehicle-to-grid power provision—some sort of hardware connection between the vehicle and the home will be necessary. The argument here is that consumers will be more likely to go to the effort and/or expense of required installations or modifications if they: own their residence, have parking access close to their homes, and live in a structure otherwise supportive of such a connection. Proxies for these considerations using variables available in the Census data were constructed by, for

example, limiting residence type to exclude vans, boats, and RVs on the one hand, and residences of five or more connected units on the other.

Further, as discussed in chapter 2, many ME innovations might require an electrical connection that exceeds the capabilities of some standard wall sockets. Nesbitt et al. (1992) [34] highlight the importance of compliance with 1974 electrical codes in the context of a similar capability-constraints assessment of the market potential for battery-cars requiring at-home recharging. Although the electrical requirements for other ME technologies, such as H₂FCVs and plug-in ICE hybrids, are likely to be significantly different than those for battery-car recharging, the availability of adequate electrical wiring continues to be pertinent. Even if H₂FCV propulsion batteries are not charged at home, other supporting or related equipment—communications, monitoring, refueling, or emergency-power—may have significant electrical loads. The Census data does not provide an easy way to accommodate this concern. However, building age was explored as a proxy for likely compliance with 1974 electrical codes.

3.2.3.3 Lifestyle accommodation

Kurani et al. (1995) [36] explore in some detail with trials, interviews, and surveys the behavioral aspects of private use of range- and infrastructure-compromised vehicles (emphasizing, in that study, neighborhood-electric vehicles). Kurani et al. found considerable opportunity for adaptive accommodation of AFVs in individual or household lifestyles. Two important constructs related to AFV purchase and use highlighted in that and related work are those of the “household vehicle fleet” and “household activity space.”

The household vehicle fleet construct led to the characterization of “hybrid households” that can easily accommodate an AFV into a household fleet consisting of both alternatively and conventionally fueled vehicles through trip planning, vehicle swapping, and other adaptive behaviors. This construct is captured in this study by targeting individuals living in households with more than one vehicle, allowing the possibility that one could be replaced by an AFV while retaining household access to a conventional vehicle.

Because H₂FCV driving range capabilities are still unknown, household activity space is not used in the data filtering process, but reserved for subsequent discussion.

3.2.3.4 Initial price premium

Initially, ME innovations will carry with them significant price premiums, not the least of which will apply for home-fueled H₂FCVs. However, projected vehicle and related costs (not to mention pricing) both vary widely and are the subject of significant continuing debate. To avoid contentious pricing predictions and allow the reader to explore these issues from a greater variety of perspectives, target consumer income distribution will be presented and discussed rather than overly prescribed. Nevertheless, two loose criteria were applied: target consumers were not allowed from completely unemployed households or households with no income whatsoever. This seemed appropriate to reflect a bare-minimum ability to pay for the expensive new technologies under consideration and to increase the validity of the target market identified.

3.2.3.5 Summary

Table 3-1 summarizes the constraints criteria discussed and the variables used as proxies in the Census data.

Table 3-1. Constraints criteria and Census filter variables

Theory: Constraint criteria	Proxy: Census variable used as filter	Values Included, (Excluded) in Target Market
<i>Spatially segmented AFV commercialization strategy</i>		
Focus on California	State	California
<i>Home connection hardware</i>		
Likelihood of residence modification	Home ownership	(Vacant, general-quarters, and rented residences)
Parking access to connection hardware	Building size: number of connected units	Units with fewer than 5 apartments, (mobile homes, boats, RVs, vans)
Sufficient facilities: Likely compliance with 1974 electrical codes	Building age	Built in 1970s or later
Sufficient facilities: misc.	Complete plumbing facilities	(No)
<i>Lifestyle accommodation</i>		
Household vehicle fleet	Number of vehicles per household	(0, 1)
Ability to drive	Age	>15
<i>Initial price premium</i>		
Ability to pay	Household income, family income	>\$0/year
Ability to pay	Employment	(Everybody unemployed)

3.2.4 *Analysis: Overview*

The analysis consists of two major parts. First, the reductive effect on market potential of various sets of assumptions was assessed. This was carried out by applying over 25 filtering criteria singly and in combination to the PUMS Census data. A multivariate approach and the microdata sample allowed customized assumption combinations to be *simultaneously* applied to the data, providing capabilities beyond the simple, univariate Census data tabulations..

Second, once the target market was identified and the sensitivity of the reductive effect to each of the criteria used assessed, the target segment was then characterized using relevant residential, personal, and household variables in the Census data.

3.3 *Results*

3.3.1 *How many?: Initial market potential*

Simultaneously applying the constraints described in section 3.2.3 produced an initial target segment for ME H₂FCVs consisting of 5.2 million Californians, an 85% reduction from the 33.9 million population-as-a-whole (25.6 million of which were of driving age).

3.3.1.1 *Sensitivity Analysis*

Figure 3-1 illustrates the sensitivity of the initial market potential to various assumptions. The farthest left, red bar in Figure 3-1 shows all 33.9 million Californians represented by

the 1% PUMS of the 2000 U.S. Census. The next, green bar is the initial estimated target segment of 5.2 million. The next eight bars illustrate the market potential resulting from relaxing, one at a time, each of the constraints used to derive the target segment.

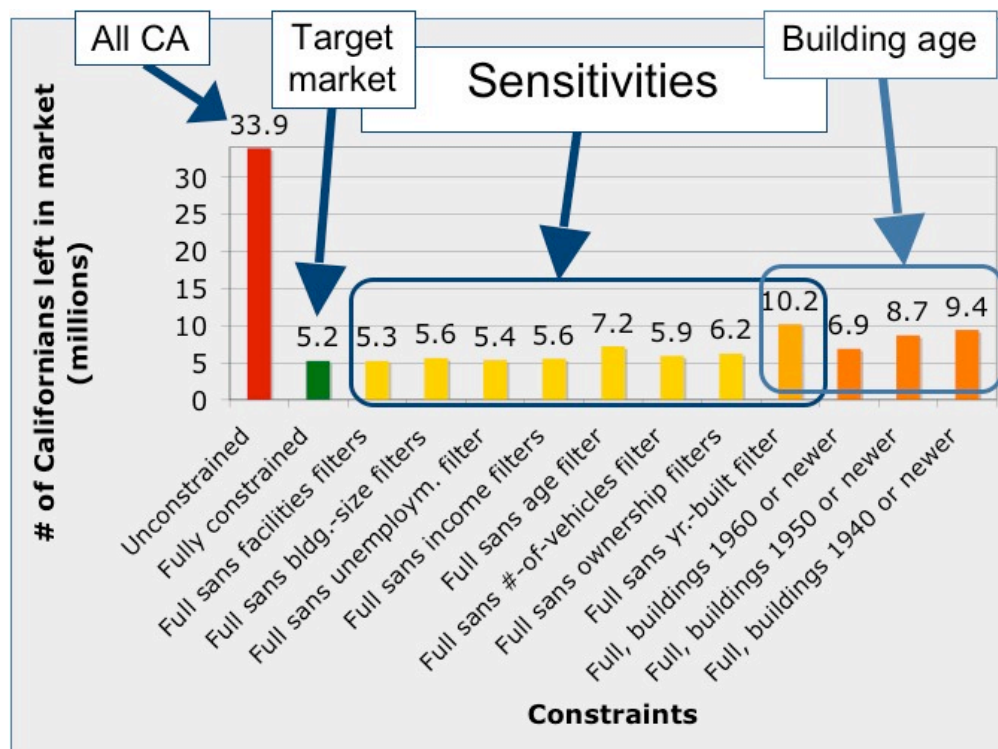

Fig. 3-1. Target segment and sensitivities

The target market potential is most sensitive to the constraint that only residences built after 1969 can easily be ME-enabled. This constraint is a blunt proxy for likely compliance with 1974 electric codes, and thus ability to accommodate ME innovation electrical loads as described in section 3.2.3. Relaxing this constraint—in essence assuming that all Californians who otherwise would be in the initial target segment lived in residences that have sufficient electrical service to support the physical connection between a ME-enabled vehicle and their home—nearly doubles the estimated initial

market potential to 10.2 million Californians. Because this effect was large, the sensitivity of the market potential to building age is subdivided by decade in the four bars furthest to the right in Figure 3-1.

3.3.2 Who are they?: Characterizing the target segment

The target market cannot be directly compared to the California population as whole on a strict apples-to-apples basis. However, when interpreted cautiously, differences between the groups can be illustrative. Selected differences are presented next.

3.3.2.1 Mean value comparisons

Mean values for the initial target market were statistically different than the mean values for the population as a whole for all variables examined, although most target-market mean values were within one standard deviation of the population mean. For example, relative to the population as a whole, target households on average tend to: have longer commutes, be married couples, have more vehicles, have larger families, have more workers, have higher incomes, be older, have higher educational attainment, and pay more for all utilities and their mortgages. Target residences on average are: newer, worth more, cost more, occupied longer, larger, and heated in more cases by utility gas. Note though that the number of household vehicles, personal age, and residence age are directly influenced by application of filtering criteria.

3.3.2.2 Distribution comparisons

Mean values are not always the most meaningful results, and for some variables are essentially meaningless. Therefore, distributions were explored for several variables.

Household income. Figures 3-2 and 3-3 show the household income distribution of the target segment and driving-age population. Household income has been grouped into \$10k bins with midpoints plotted on a percentage basis (Figure 3-2) and on an absolute frequency (i.e., number of individuals) basis (Figure 3-3).

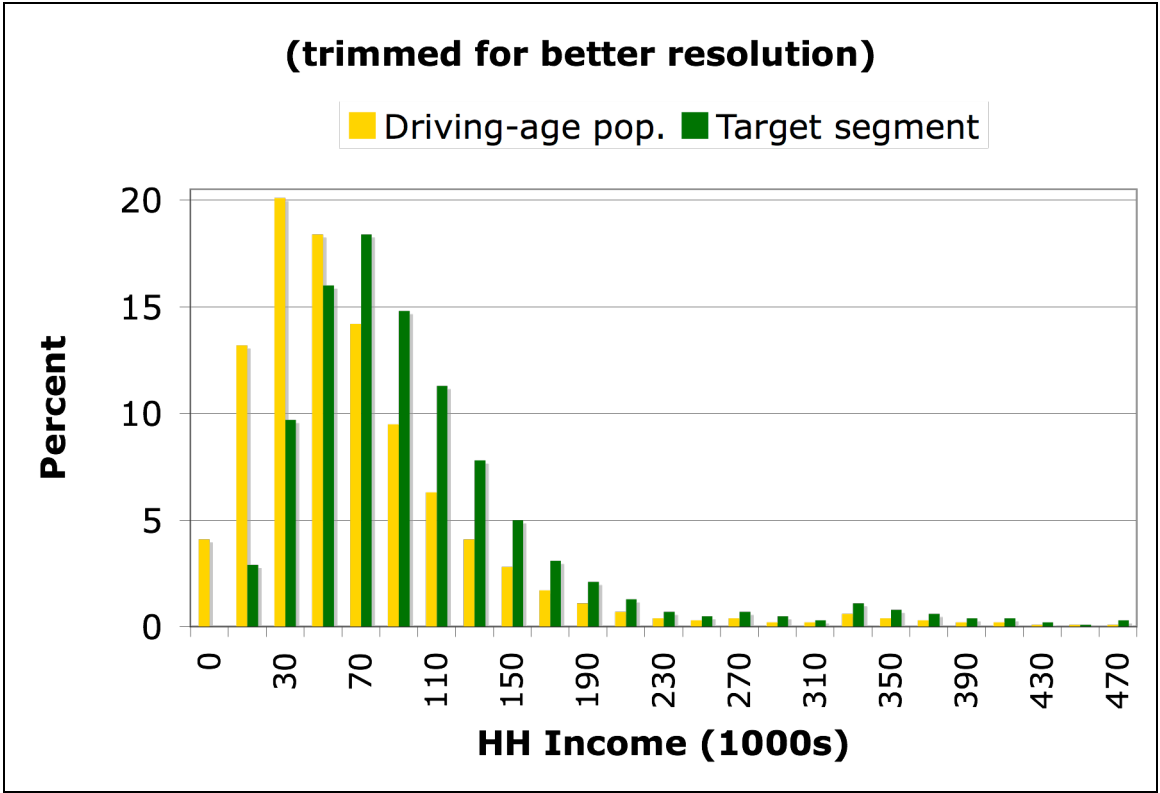

Fig. 3-2. Household income distribution (percentages)

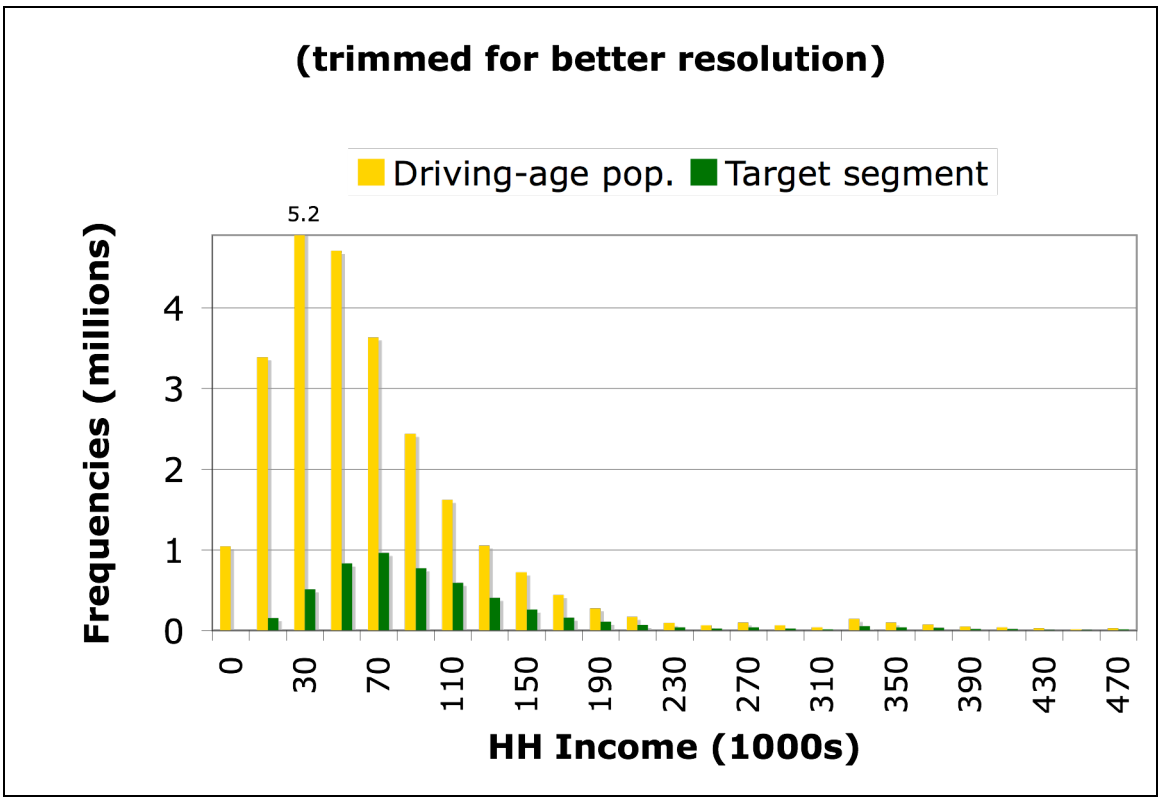

Fig. 3-3. Household income distribution (frequencies)

Figure 3-2 shows that the household income distribution of the target group is shifted toward higher incomes relative to the State driving-age population. Additionally, Figure 3-2 shows that the highest income households are disproportionately represented in the target segment. Figure 3-3 illustrates the overall reductive effect of the constraints employed in the study.

Number of vehicles per household. Keeping in mind that the number of vehicles per household is a filtering criterion, Figure 3-4 gives a sense of the vehicles available to the target segment relative to the driving-age population. It also illustrates that households with a large number of vehicles are disproportionately represented in the target segment.

While the target group is only about one-fifth of the driving-age population, the target group makes up about two-fifths of the driving-age population that own four or more light-duty motor vehicles per household.

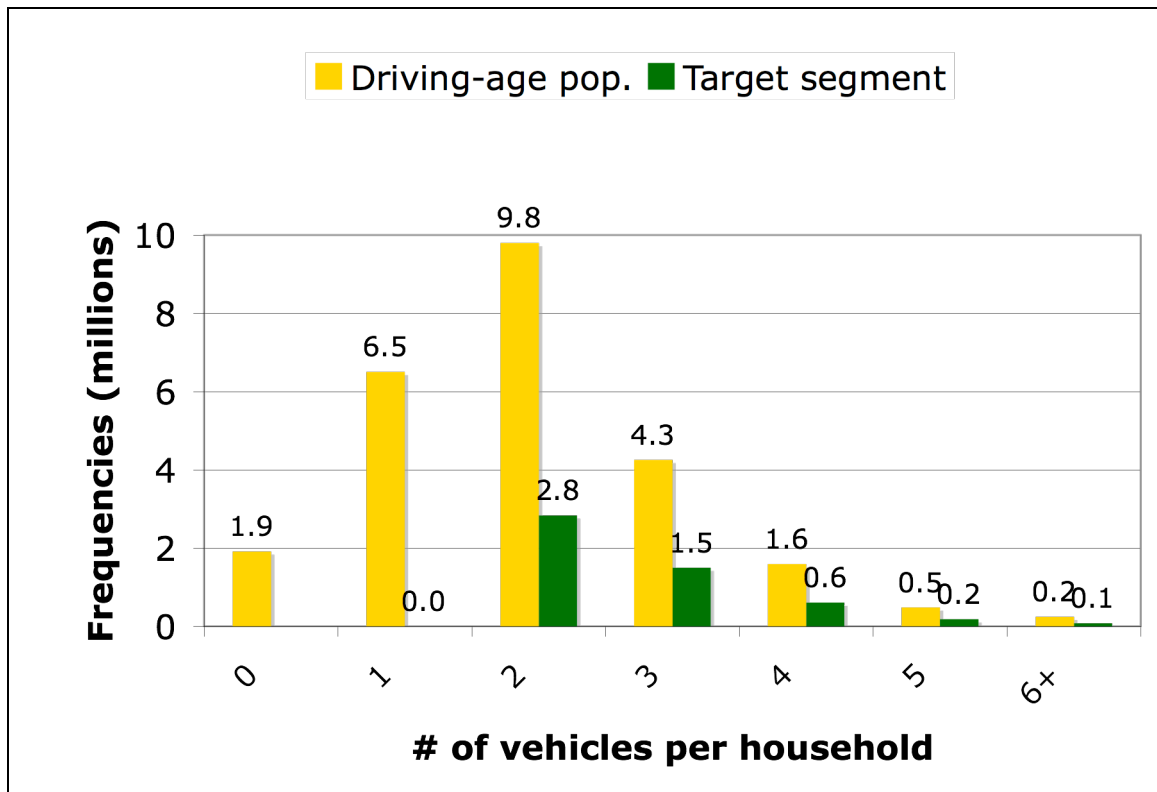

Fig. 3-4. Number of vehicles per household (frequencies)

Personal age. Figure 3-5, which plots age distributions on a percentage basis, indicates the following trends: 20-somethings to mid-30-somethings appear to be underrepresented in the target segment, as are those over 70 years of age. The target group's age distribution appears to be shifted toward the upper-thirties-to-lower-sixties range.

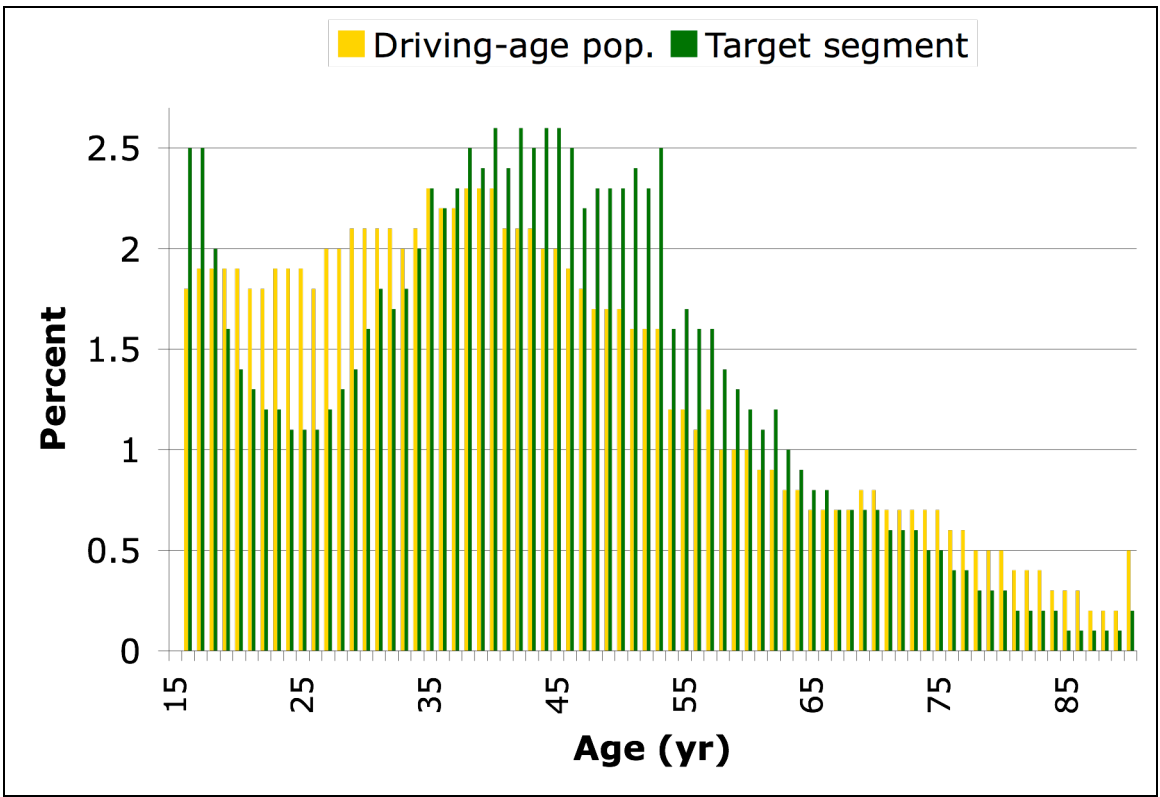

Fig. 3-5. Age distribution (percentages)

Educational attainment. The target group has a higher average level of educational attainment (some college) than the driving-age population (completed high school) and population as a whole (not completed high school). The distributions of educational attainment level for all three groups can be seen in Figure 3-6.

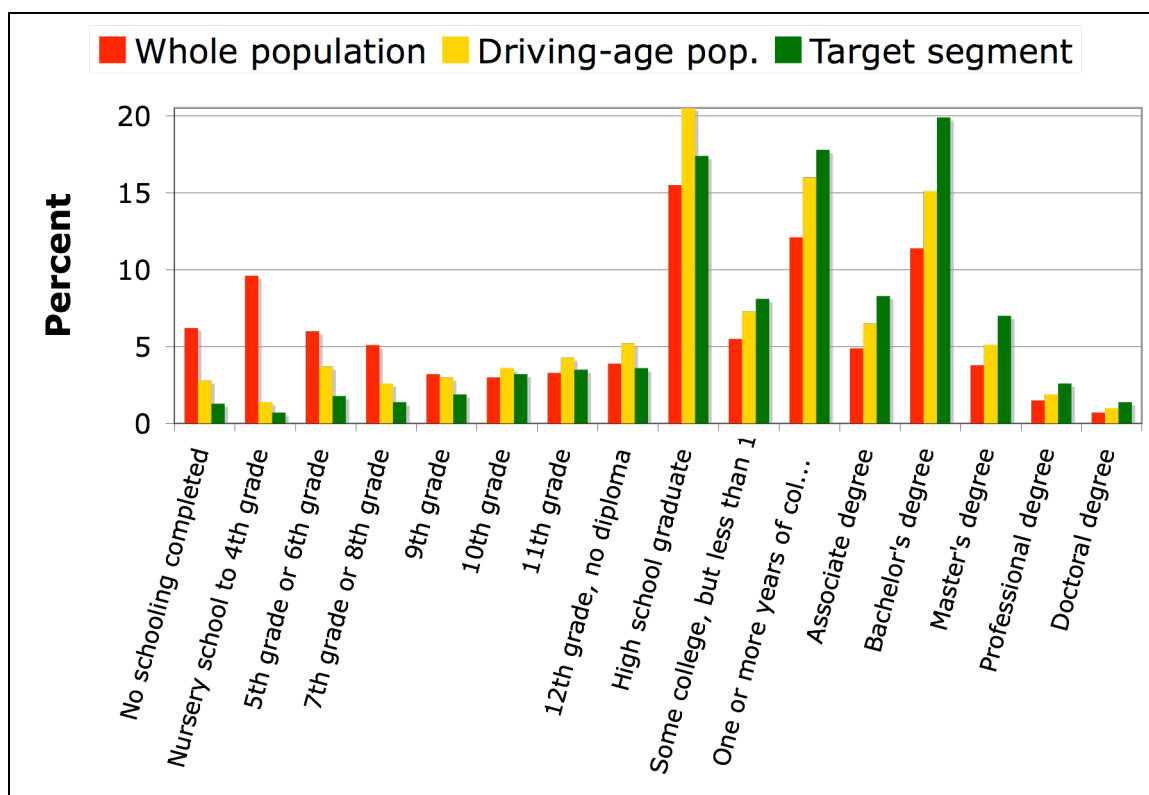

Fig. 3-6. Educational attainment (percentages)

Travel time to work. Table 3-2 shows the travel time to work for the target group and total population on a cumulative percentage basis. For a given cumulative percentage, the target group appears to have a roughly 15-minute longer commute than the population as a whole. For example, 90% of Californians commute for a half-hour or less, whereas a 45-minute commute is required to include 90% of the target group.

Table 3-2. Travel time to work

Travel time to work	Whole CA population	Driving-age	Target market
≤ 30 min	90%	87%	82%
≤ 45 min	95%	93%	91%
≤ 60 min	98%	97%	96%
≤ 75 min	98%	98%	97%

Heating fuel. Figure 3-7 shows the distribution of residential heating fuel type. On a percentage basis, the target group is more likely to heat its residences with natural gas and propane than the driving-age population.

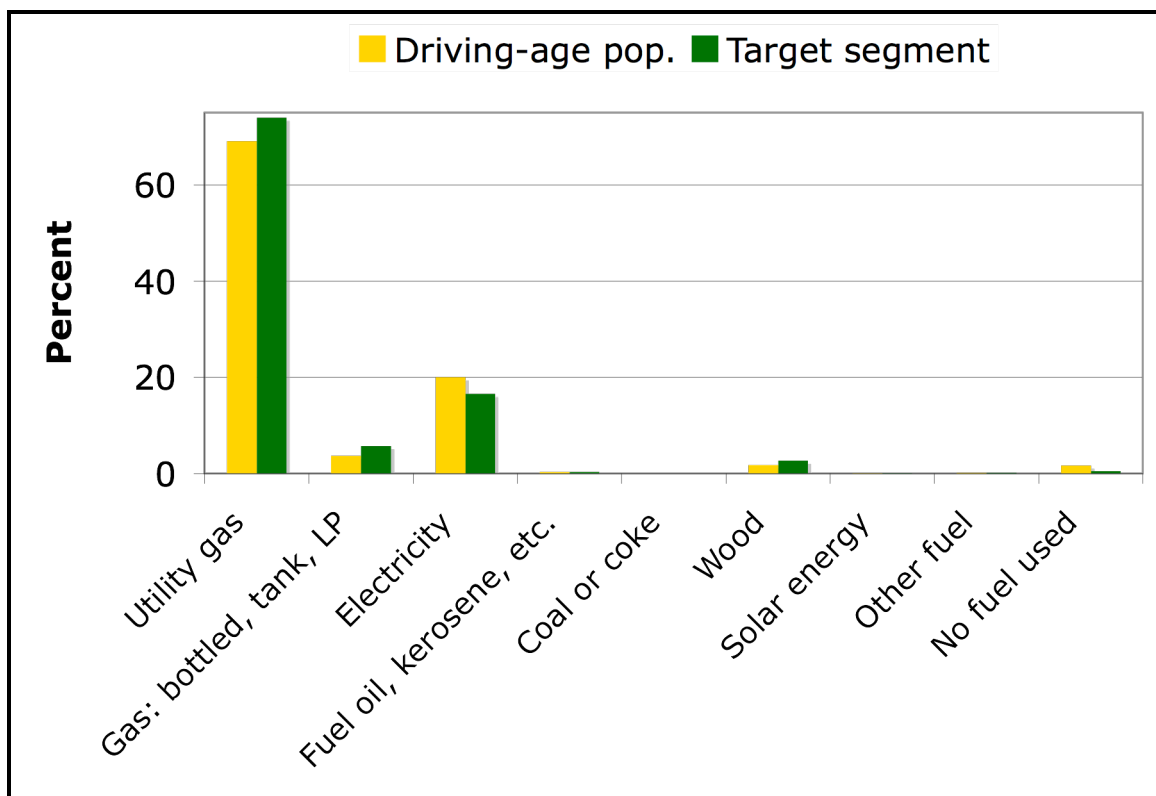

Fig. 3-7. Household heating fuel (percentages)

3.4 Discussion

3.4.1 Overall impressions

A “first order approximation” of the comparison between the target market and the total population can probably be achieved by considering the target market group for ME-

enabled H₂FCVs to be “home owners.” One might be tempted to speculate that 20-somethings are underrepresented in the target segment because they have not yet settled into their own homes, whereas home ownership necessarily requires higher income, and so forth. However, even if this were the case, this is clearly not the whole story. In particular, the reductive impact of the constraints considered here go far beyond home ownership: there are roughly 20 million individuals in California living in residences owned by the household, but the initial market potential of the target segment is only 5 million individuals. (This 85% reduction is greater than the 72% reduction found by a 1992 study [34] for battery cars using a similar approach but using different constraints and data.)

This analysis, therefore, prompts several questions that a consideration of home ownership alone would not. For example, is the fraction of a 5-million-Californian initial market *potential* that can be captured as market share by an individual company, or even the buy-down base for the incremental costs of the entire new technology supply industry, *sufficient*? On the one hand even 50,000 vehicles (1% of 5 million) would appear to be sufficient to maintain interest in ME technologies, particularly given the mutable nature of the *initial* market potential and the possibility of locating additional, similarly appropriate market segments to broaden the buy-down base at small marginal cost.

On the other hand, a 5-million-individual *potential* sales pool—or a 10- or 25-million one for that matter—may provide little comfort in the face of the anticipated costs and

difficulties of the system-wide innovations implied by a transition to H₂FCVs and other ME technologies. This may be of particularly little comfort to an automotive industry used to thinking in high volumes and might argue for the need to find not only other household market segments, but more fundamentally different niches in which to nurture the new technologies and spread buy-down costs (see chapter 4).

So the magnitude of reduction in market potential and its implications are effects not entirely captured by the “home owner” simplification. And there are many other, if sometimes subtle, differences between the target group and the driving-age or whole populations, some of which were presented in section 3.3. Marketing managers, H₂FCV product designers, and ME innovators would do well to note these differences, and to seek others by asking relevant research questions of target groups such as the one identified and characterized here.

In that spirit, this analysis can also contribute to the creation of a dialogue that will be increasingly important as H₂FCVs and plug-in hybrids are brought from vision to commercialization. This dialogue highlights the differences between solutions created by modeling an abstract technical optimum and those acknowledging the need to successfully market products that meet real or anticipated consumer demands. This tension between technical and marketing optima for vehicle and infrastructure design motivates the following brief contributions to ongoing discussions about vehicle range and home refueling.

3.4.2 *Vehicle design: Range requirements*

It is anticipated that further focus on and exploration of target market niches and segments like the one analyzed here will yield important guidance for *design*—the specific details of products with which consumers interact, and which ultimately determine the success or failure of the technologies embodied in them in one specific way [33] (see chapter 4). An important attribute of H₂FCV design is driving range per refueling. This attribute is subject to high levels of uncertainty because of the challenges facing hydrogen storage technologies, refueling infrastructure, and fuel-cell and system efficiencies. What can this analysis say about H₂FCV range requirements?

One first-cut indication is provided by the commute time results presented in Table 3-2 (section 3.3.2). If over 95% of the target segment has a commute time of an hour or less, even a high (and thus conservative) assumed commute speed of 55 mph (the national average speed for commute trips made in privately-occupied vehicles in 2001 was 32.2 mph [37]) translates into a 110-mile daily roundtrip commute requirement. Adding, as discussed in some reports [21], a reserve buffer of 20 miles for unanticipated trips, this supports the weak assertion that the daily range requirements of most Californians who commute by automobile are already more than met by the roughly 200-mile range capabilities of current H₂FCV prototypes.²¹ It can be argued, therefore, that technological

²¹ The natural temptation is to refine this range “calculation” with precise inputs and/or model the phenomena more accurately. This should of course be done, but is not necessary to support the contention here. Further, as described next, daily *requirements* are just one of several design issues relating to ME vehicle range.

“breakthroughs” are not *required* to meet the typical daily driving requirements, as defined, of many members of the target group.²²

However, that argument is only credible with several caveats. First, such a conclusion assumes that consumers could refuel regularly, as often as daily depending on the closeness of the fit between their daily travel requirements and vehicle range capabilities. In the absence of an existing pervasive hydrogen refueling network, a ME opportunity would be to give consumers the capability to at least partially refuel at home (see section 3.4.3, below). Second, range *requirements* are often quite different than *perceived* range requirements, or most importantly, range *wants*. Third, whether truly pertinent or not to consumer behavior, “compromise” is generally detrimental if perceived by the consumer. And fourth, the *increased* range performance of some gasoline-combustion hybrids as compared to today’s conventional gasoline vehicles may make that compromise more readily apparent. This is one of the arguments for the need of further H₂FCV differentiation along different product dimensions discussed in chapters 1 and 4.

Acknowledging the desirability of minimizing real and perceived driving range limits, it is nevertheless valid to question the importance of driving range *per se*. Just as consumers really care about good lighting in their buildings, but, in a lumens-undifferentiated world, have developed the unfortunate habit of judging their bulb purchase options on the basis of wattage—which ironically is a measure of cost not

²² Indeed, battery-car analyses have argued for the sufficiency of far lower range performance. For example, Kurani et al. (1994) found evidence of comfort-thresholds for 100 miles or less in many households, assuming daily home recharging.

benefit—it is valid to ask whether or not driving range is a pertinent attribute from the consumer perspective. Were driving range limits not explicitly raised to the attention of the consumer, would they be (de)valued *per se*? Are there thresholds above which marginal range improvements become relatively less important? Is *sufficient*, *equivalent*, or *optimal* range the most relevant? More importantly, is refueling convenience the more operative concept? Research by UC Davis, GM, and EPRI [13] indicate that avoided trips to the gasoline station are an important source of value to consumers. Just as driving range *requirements* are only one aspect of a complicated picture for the consumer, driving range itself is just one piece in a complicated vehicle purchase decision process.

Returning to the challenges of product design, the uncertainties surrounding hydrogen storage, fuel-cell-system efficiency, and infrastructure availability are made more complicated by these questions relating to vehicle range. And this complicated relationship between range, energy storage, and conventional infrastructure availability is further complicated by ME, which brings with it the prospect of increased use of on-board energy for purposes other than propulsion on the one hand, and the prospect of non-conventional refueling regimes on the other.

3.4.3 Infrastructure design: Home reformation or electrolysis?

Home hydrogen is another example of the potential tension between technical and marketing optima. Although less inherently scale-sensitive than some other fuel production methods, hydrogen production experiences economies of scale, as do hydrogen separation/cleaning, storage, and dispensing. Current indications are that home hydrogen might be an expensive proposition in general, with the heat-management

requirements of natural-gas-to-hydrogen reformation making that option possibly less down-scaleable than water-splitting electrolysis at the one-car level. The latter option, in turn, tends to suffer on electricity-input operating costs (and environmental consequences if that electricity is coal based). However, it is important to ask, “Expensive relative to what?” Relative to initial H₂FCV purchase/lease prices, into whose financing a home hydrogen appliance might be rolled? Relative to a sustainable-community home mortgage? Relative to the budget of a motivated early-adopter with a reasonable income? In short, price, financing, and willingness-to-pay are marketing concepts often neglected by, or difficult to incorporate into, techno-economic cost estimates.

Further, how one defines “the problem” of course has important implications for what solutions are attractive: sluggish or non-existent vehicle sales may doom or prevent H₂FCV commercialization until sufficient conventional infrastructure is somehow justified and put into operation. A home refueling strategy might help technology developers do an end run around the chicken-and-egg problem. That prospect may be motivating a major automaker, which is experimenting with the third generation of its Home Energy Station (HES) research unit for hydrogen refueling [38]. (It has also partnered with an alternative-fuel technology developer, which is offering a garage-mountable natural-gas refueling device to compressed-natural-gas-vehicle consumers.) The HES concept further “redefines the problem” by integrating into one device electricity and heat production for the home as well as hydrogen refueling, allowing costs to be spread over multiple value streams.

What can this analysis of an early market potential contribute to the question of home refueling? Two contributions are readily apparent. The first is that the target market segment pays more for all household utilities on average, implying that they might be receptive to investing in the home energy strategy. The second contribution begins to address the question of “electrolysis or reformation?” Not everybody has access to utility gas, or even propane, eliminating them from the *initial* market for home reformation. How does the target segment compare in this regard? As illustrated by Figure 3-7, on a percentage basis, the target market has greater access to utility gas. Nevertheless, the percentage is not 100%. Figure 3-8 depicts heating fuel on an absolute frequency basis, and indicates the 5.2 million individuals in the target segment have been further reduced to 3.9 million by the utility-gas requirement. Figure 3-9 illustrates this portion of the target market segment relative to the driving age population.

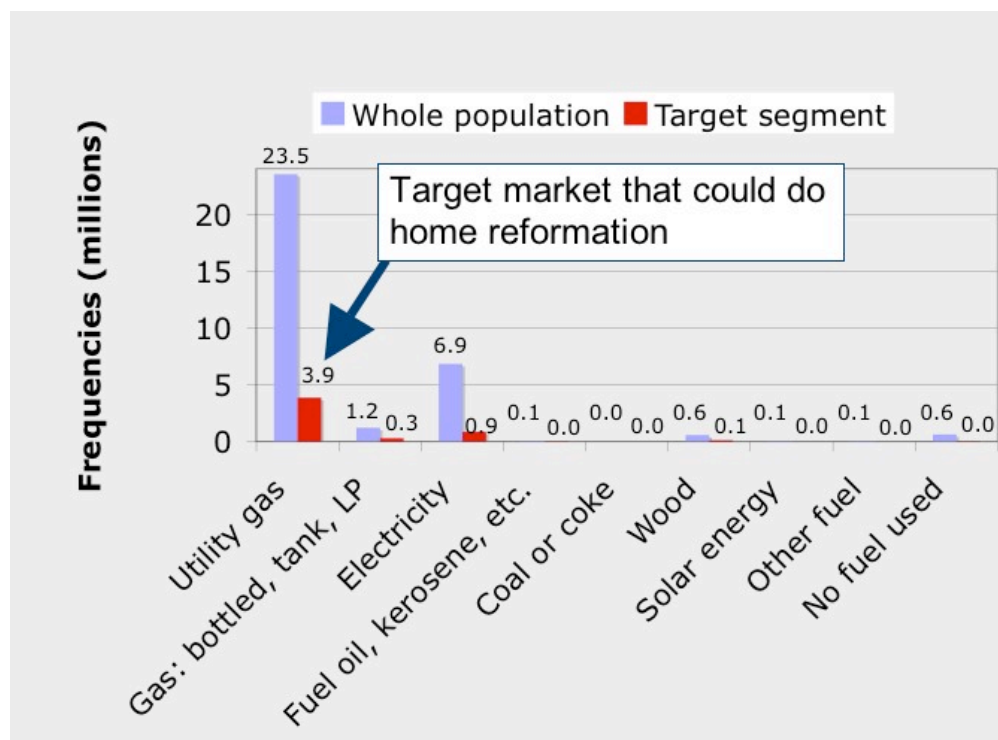

Fig. 3-8. Household heating fuel (frequencies)

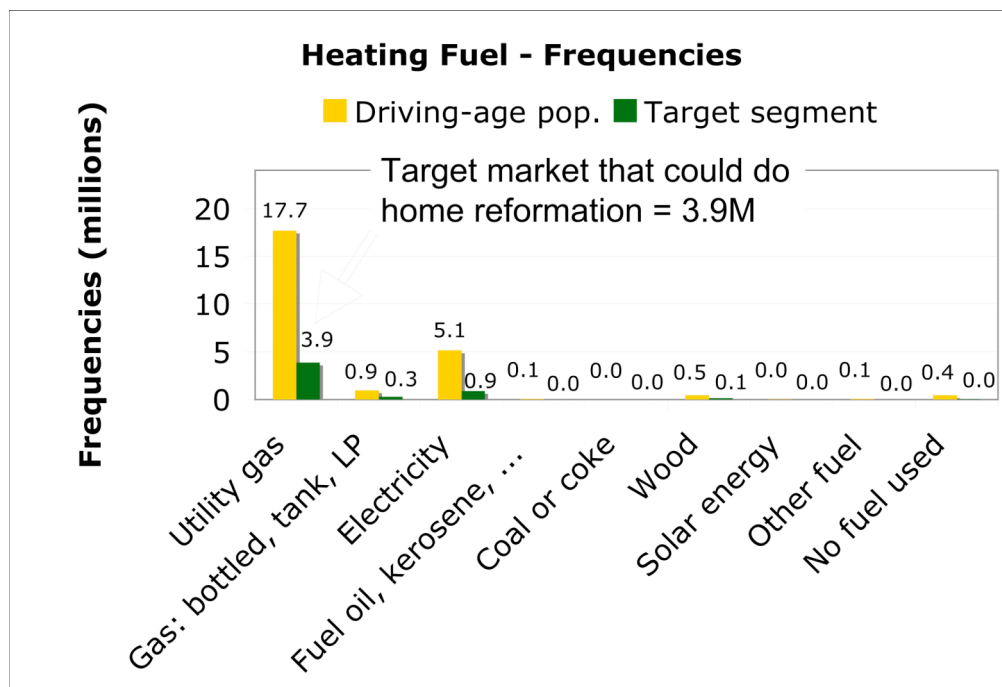

Fig. 3.9. Distribution of household heating fuels and the home hydrogen reformation target market

The roughly 4 million Californians identified here as most capable of adopting natural-gas-based home refueling are, on average, 44 years of age and have some college education and 20-minute commutes. Further, they live in roughly 1.5 million households with average household incomes of \$109,000 per year and 2.5 vehicles. Assuming they keep their vehicles for 8–9 years (the average vehicle age in California in the 2001 National Household Travel Survey was 9.3 years, 7.6 for households with incomes greater than \$100,000 per year), these households represent a roughly 400–500k vehicle per year maximum initial market potential, including conventional vehicle sales and before accounting for consumer tastes. This target segment is presented as a small yet focused research population for subsequent study of early adopters of home fueled H₂FCVs.

3.5 Chapter summary and conclusions

H₂FCVs cannot be sold simply as clean cars and trucks; innovative value must drive their adoption. From this launching point, the early markets for H₂FCVs and plug-in hybrids were explored in the context of a group of promising opportunities collectively called Mobile Energy (ME) innovations. By applying various common-sense constraints that eliminated unlikely households from consideration for early adoption of H₂FCVs and other ME technologies, a dramatic reduction in the “initial market potential” for these technologies was found. Only 5 million out of 34 million Californians (26 million of driving age) remain in the target segment identified. Only 4 million remain if the additional requirement of natural gas use at home is included. This target market represents those individuals that would currently appear *able* to easily adopt, and therefore more readily derive added benefits from, ME-enabled H₂FCVs. It does not take into account tastes or purchase behavior. The magnitude of the target segment thus represents a maximum, though not immutable, *initial market potential*, from which sales will be drawn, forming the buy-down base for the incremental costs of the required innovations. Several differences between the target market and the driving-age/whole populations were found and highlighted, and two issues related to the design of H₂FCVs and their supporting infrastructure were discussed: vehicle range and home refueling options.

The target segment identified, and its differences with the larger populations, are neither trivially small nor overwhelmingly large. These findings would appear to justify both continued investigation of this or similar target segments—which represent more efficient

research populations for subsequent study by marketing managers, product designers, and other decision-makers wishing to understand the early market dynamics facing H₂FCVs—as well as investigation into other market niches that can further nurture and support product development and Mobile Energy innovation.

4 How might Mobile Electricity innovation happen?: Product- and market-development considerations

This chapter considers the problem of commercializing hydrogen-fuel-cell vehicles (H₂FCVs) in the context of opportunities for Mobile Electricity innovation. In the process, it explores the transition to, and development of, various electric-drive-vehicle (EDV) technologies and markets. It builds upon select lessons from the high-tech-marketing and innovation literature (detailed in appendix 7.3). Section 4.1 examines the literature to develop definitions, theoretical characterizations, and strategies to describe to process of innovation and the challenges of commercializing discontinuous technologies. It lays the groundwork for the exploration Me- commercialization. Strategic management issues are discussed for each of two major categories: product and market development (sections 4.2 and 4.3). Finally, an example is used to illustrate “getting started” using combustion hybrids in an aggregated “parking-lot power plant” application (4.4).

4.1 Innovation and high-tech marketing theory

As described in chapter 1 and detailed in appendix 7.3, most past alternative-fuel vehicle (AFV) commercialization efforts have been described as unsuccessful and/or not sustained through periods of low oil prices (e.g., [7, 8]). While the potential of hydrogen-fuel-cell vehicles (H₂FCVs) to provide various environmental, policy, and strategic benefits has been described widely and in detail [1-6, 28, 39, 40], the actual impact of the technology is predicated on it being bought and used widely. So far, this investigation of using Mobile Electricity (Me-) to drive H₂FCV commercialization has explored the question of “What is Me-?” (chapter 2) and “For whom?” (chapter 3). This chapter uses a

business lens to investigate “How?”—beginning in this section with an exploration of the innovation and marketing literature detailed in 7.3.3 along thematic lines: characterizing innovations, commercialization challenges, and strategies for discontinuous technologies.

If conventional automaking and marketing can successfully commercialize H₂FCVs and other electric-drive vehicles (EDVs), with or without Me-, so much the better. However, given the past difficulties of commercializing AFVs as if they were conventional vehicles, the following discussion imports and builds upon popular management theories developed from historical experience and practice in a variety of industries to reach beyond the conventional. Doing so will begin to assemble and highlight the ways Me-vehicles might present different commercialization challenges and describe strategies for addressing those differences, emphasizing dynamics often characterized in the literature as counterintuitive or as “surprises.” The rest of the chapter draws and expands upon this discussion in its exploration of Me- product- and market-development, thereby illustrating what it might take to successfully commercialize H₂FCVs and other Me-technologies.

4.1.1 Characterizing innovations

To understand what kind of commercialization challenges H₂FCVs pose we must first characterize them: What kind of products do they represent? Several related and overlapping dimensions are used (often loosely and confusingly) in the literature to describe technological innovations: incremental vs. radical, evolutionary vs. revolutionary, continuous vs. discontinuous. According to the Oxford American Dictionary, radical and revolutionary refer to fundamental or complete changes, but also

to dramatic or far-reaching changes, and thus will be considered here to refer somewhat interchangeably to large or complete changes, or to characterize technologies that are relatively “distant” by some measure from what exists. *Incremental* and *evolutionary* refer to regular increases and gradual development, respectively. Because of the possible confusion with biological processes (and the debate over how gradual or not those process are), evolutionary will be avoided here (thus minimizing the usefulness of revolutionary). Incremental will be considered here to reflect relatively smaller changes, deviations, or distance from the status quo. *Continuity* refers to an unbroken whole, without interruption, whereas *discontinuity* implies gaps or intervals, and thus will be used here to describe technologies in reference to what has come before. Thus, a radical and continuous innovation as defined here exhibits a large change but along similar dimensions to what has come before (and asymptotically approaches a discontinuous innovation as the degree of radical-ness approaches infinity), whereas radical and incremental grow meaningless (undefined) as the degree of continuity approaches zero (complete discontinuity).

In [33], Hargadon tends to avoid such characterizations, cautioning that such terms often 1) carry misleading positive or negative connotations, and 2) confuse or fail to distinguish between an innovation’s origins (e.g., relating to its development) or impact (e.g., social or economic impact in the market). He also has relatively less use for them, as one of his major theses is that innovations with continuous origins tend to be more successful, and his attention is focused there. Use of the dis/continuity spectrum—with explicit

distinction between origin and impact when necessary or valuable—would appear, however, to minimize those two concerns, and is used here.

Whereas Hargadon's distinction between discontinuity in origin and impact is made within a framework that focuses on which characteristics and methods of supporting innovation are more suitable or likely to advance innovations successfully to widespread social/economic impact, Moore's high-tech marketing guidebook [41] presents a framework focusing on consumer types and marketing dynamics and strategies to show how discontinuous innovations can better achieve mainstream market success.

Correspondingly, Moore describes discontinuous innovations relative to consumers as “products that require us to change our current mode of behavior or to modify other products and services we rely on,” (p. 10)—a discontinuity defined relative to adoption/use. On the other hand, Moore's emphasis on strategies such as partnership building to deliver whole-product solutions—which resonate with Hargadon's strong emphasis on social networks and community building—might therefore suggest an important additional discontinuity, discontinuity in supply (i.e., when the supply chain—either production or distribution channels or both, for the innovation itself or for complimentary products and services—must be considerably changed or even created to accommodate a new product).

Christensen [42] adds another dimension to innovation characterization—sustaining vs. disruptive. These terms, though they descriptively embody his arguments, are a little less straightforward to define. He claims sustaining technologies “can be discontinuous or

radical in character, while others are of an incremental nature,” but all “improve the performance of established products, along the dimensions of performance mainstream customers in major markets have historically valued,” (ibid., p. xv). Disruptive technologies, on the other hand “bring to a market a very different value proposition than had been available previously,” (ibid). Thus, he appears to use *disruptive* to speak to a discontinuity of value proposition rather than as Moore does, of behavior.

Rogers [43], a principal developer of diffusion-of-innovation (DOI) theory, suggests that consumer perception of five attributes of innovations are associated with the rate of adoption: relative advantage, compatibility, complexity, trailability, and observability. *Relative advantage* speaks to the degree, more than the continuity, of the value of the innovation relative to what it is meant to supersede. *Compatibility* and *complexity* are two elements of continuity of origins, from the perspective of the adopter (i.e., in use). *Compatibility* speaks to the consistency of the innovation with what has come before, whereas *complexity* (the only factor of the five associated negatively with adoption) refers to the degree of difficulty of comprehension and use. The spectrums of *compatibility* and *complexity* may, therefore, be treated similarly to radical/incremental and dis/continuous as described above: as *complexity* increases (along similar dimensions to what has come before), the innovation approaches incompatibility. *Trailability* and *observability* refer to the ability of a potential adopter to try out and see the results of an innovation, respectively.

Based on the terminology as described and developed above, H₂FCVs might be considered relatively radical, discontinuous (in origins, impact, use, and production), and disruptive innovations with low compatibility, observability, and private relative advantage. Table 4-1 illustrates that the discontinuities for Me-FCVs tend to be even higher than for H₂FCVs, further highlighting the importance of strategies that address the characteristics of more discontinuous innovations than is typical in today's automaking and marketing.

Table 4-1. H₂FCV and Me-FCV innovation discontinuities

	Origins: development; adoption	Potential impact	Use	Production	Distribution	Value proposition
Discontinuity for H ₂ FCVs	High, decreases if fuel infrastructure increases: new development challenges; easy to understand as cars, but lack of stations requires change	High	High, decreases to low if fueling infrastructure increases	Medium: OEMs have started building programs	Low for vehicles, high for fuel	Low: similar to cars
Discontinuity for Me-FCVs	High: delivering Me-whole-product solutions adds to development and adoption changes	Higher, involves more products, services, industries	High	Medium–high: must produce Me-whole product	Medium: need additional Me-channels; some fuel shifted to existing e-grid	High: new uses, services

How might the characteristics of H₂FCVs as products help or inhibit commercialization?

Hargadon encourages innovation managers to focus on opportunities with continuous origins, whereas Moore accepts discontinuities as commonplace: “Whereas other

industries introduce discontinuous innovations only occasionally and with much trepidation, high-tech enterprises do so routinely and as confidently as a born-again Christian holding four aces,” ([41] p. 11).

Moore’s framework is focused not at avoiding the pitfalls of discontinuous technologies—indeed he claims, “Every truly innovative high-tech product starts out as a fad—something with no known market value or purpose but with ‘great properties...’”—but on transforming discontinuous technologies and early-market enterprises into whole product solutions more palatable to the mainstream market. Similarly, Hargadon’s characterizations of what makes for good innovation²³ can be co-opted from picking and supporting winners and winning processes into informing the transformation of “what you’ve got” (e.g., a desired end goal) into a more palatable, innovation-friendly character. Taking this approach one step further, initial products of a more continuous nature might be designed to stimulate and support innovation for more discontinuous goals. The other sections of this chapter take this approach to inform Me- product and market development, in particular the illustrative example of creating markets for V2G power using combustion hybrids in aggregated applications.

Nevertheless, discontinuities tend to be negatively associated with development and adoption, with two notable exceptions: *discontinuity in market impact* and *discontinuity in value*. Discontinuity in market impact defines a technology as a true innovation—not

²³ e.g., technology-brokering and community-building strategies that transform technologies of continuous origins into innovations with discontinuous market impact—discussed below

just in the descriptive sense of newness but in the active sense of innovation as the process of using a new idea, process, or product to make changes in something established. The promise of discontinuity in market impact can lure investment. On the other hand, although discontinuity in value is not necessary for many (sustaining) innovations, new dimensions of value can also act as a lure—assuming consumers value the new proposition offered by the product. But when is this extra degree of “newness”/discontinuity worth it?

This tension between making something new enough to be exciting but not so new as to retard innovation processes that work more effectively when leveraging what exists is at the heart of the Me- innovation premise. Relative to existing vehicle products, H₂FCVs are costly, immature, and inferior along certain familiar product dimensions, their production and use require considerable change, and their differentiating benefits are largely social and not private. Based on this, it may be difficult to justify the private investment necessary for H₂FCVs to have an impact. In absence of a compelling value proposition, past experience warns us that their successful commercialization is unlikely. For these and other reasons, a major premise of this dissertation has been that H₂FCVs *must* be redefined as innovative products that provide new value. This is discussed further in the context of product differentiation in section 4.3. Table 4-2 examines for H₂FCVs and Me-FCVs the double-edged sword of newness as a source of both innovation-driving value and innovation-retarding discontinuities. It attempts to rate the level of overall positive or negative impact on innovation of the characteristics of each approach in a variety of the contexts discussion above.

Table 4-2. Balancing newness: the impact of H₂FCV and Me-FCV characteristics

	Origins: development; adoption	Potential market impact	Use	Production	Distribution	Value proposition
H ₂ FCVs	- (development); - (adoption easy as cars, but no stations)	++	-- (inferior range, refueling)	- (OEMs building programs)	0 (similar channels)	-- (costly, inferior)
Me- FCVs	-- (Me- development also needed); -/0 (easier for those who can recharge at home)	+++ (more sectors, services)	-/0/+ (inferior range, home recharging)	-- (Me- programs also needed)	- (needs new Me- whole- product channels)	+ (potentially profitable, otherwise useful)

Table 4-2 shows how Me- innovation could potentially improve the prospects of H₂FCV innovation. Chapter 2 began a broad assessment of the various discontinuous value propositions offered by Me-FCVs. This chapter, however, is concerned with realizing that potential. As this discussion has shown (highlighted by Table 4-1), the high degree of discontinuity characterizing Me-FCVs poses challenges to their commercialization—challenges dissimilar to those faced by the development of an automaker’s latest “all-new” Accord, Camry, Silverado, or Explorer. Building upon Table 4-1, Table 4-2 is a notional accounting of these factors, crediting Me-FCVs for their potential new value streams while debiting them for the additional effort required. Though Me- modifications and new accessories pose additional development, production, and distribution challenges, these challenges may be relatively modest and continuous in origin—relative to the development challenges for making FCs themselves—for some Me- services: Me-products could synergistically build upon, e.g., past work on uninterruptible/solar power systems and BEVs to create the necessary add-ons for many Me- services. Further, Me-

innovations may ease adoption by mitigating range concerns and adding lifestyle flexibility in the form of home recharging/-fueling and mobile power.

The frameworks introduced in this section are further explored in the next section for their treatment of discontinuous-innovation commercialization challenges and strategies.

4.1.2 Commercialization challenges and strategies for discontinuous innovations

The previous section described the tension between two issues related to the newness of a technology: the commercialization-driving effects of a clearly differentiated or even discontinuous value proposition and the innovation-hampering lack of leverage and familiarity of a technology with discontinuous origins. Strategies suggested in the innovation literature to address the issues of familiarity and leverage are discussed next.

4.1.2.1 Familiarity

The tension surrounding the newness of an innovation is at the heart of Hargadon's discussion of *robust design* [33], where design is defined broadly as the set of specific details and contexts that define the consumer's interaction with the technology, i.e., its particular embodiment in a given application context. The importance of the specific embodiment of a technology to the success of a technology resonates with the conclusions of [44], which found evidence that consumer evaluations of AFV drivetrain technologies were confounded with preference for vehicle type. For example, "More than any other search attribute, car size immediately affected the response of participants," (p. 25). This presents an interesting dilemma when trying to interpret consumer reactions to a new technology that could be packaged in many different ways.

Familiarity, which eases adoption and reduces discontinuity in use, is also an important aspect of strategies suggested by the frameworks of Rogers and Moore. When discussing the positive association of compatibility with the rate of adoption of an innovation, Rogers suggests, “Naming an innovation and positioning it relative to previous ideas are important means of making an innovation more compatible,” ([43], p. 266). Moore similarly recommends defining a product and its value proposition, and otherwise positioning a product, relative to leading products as a legitimization strategy for making headway with pragmatist mainstream consumers less interested in technologies than market standards [41].

Design robust to the dynamics of innovation thus considers which aspects of an innovation to present as novel and compelling and which to disguise in reassuringly “conventional” interfaces. For example, Hargadon describes how Edison intentionally did not initially use the full luminosity capabilities of his electric lights; rather he fit them into the familiar gas-light paradigm in which they were trying to compete. Often overlooked or underestimated by the original proponents of a new technology—who intimately know and appreciate the full, wide-ranging potential of a concept—the specific embodiment developed for initial commercialization can have as much to do with the success or failure of an innovation. These designs often can only partially embody the full potential, frustrating visionaries with a sense of compromise. This dynamic is echoed in the conversation started in chapter 3 about the tension inherent in designing and developing products for technical vs. marketing optima.

4.1.2.2 Leverage

The tensions between superior and differentiated vs. compromised but commercializable design, and between innovations with discontinuous vs. continuous origins, are rooted, as discussed above, not just in familiarity but in leverage—leverage from existing communities built up around existing technologies that could be used to lower cost, distribution, and other hurdles and otherwise speed commercialization. The importance of successfully leveraging social networks is described as typically underestimated by visionaries and technology-focused executives. [33] emphasizes that innovations usually fail for social not technological reasons. Contrapositively, leveraging social networks presents an opportunity to increase the likelihood of success.

For example, [45] and [33] describe how Ford leveraged knowledge from industrial slaughterhouses (meat “disassembly lines”: cows in, steaks out) into his car assembly lines. Ford drew key figures from that industry into executive positions in his own company. Innovators who recognize solutions in contexts different than their own experience and work to import and exploit them by bridging the two *distant worlds*²⁴ are characterized as *technology brokers* by [33]. Mowery and Rosenberg characterize the process, which they refer to as the intersectorial flow of new technologies, as having been around for centuries, but of central importance to 20th century innovation [45].

²⁴ Separate or distant worlds are defined in a social context by network theory: communities of people who know and interact with each other, but not those in the other “world”/industry/social network, thereby reducing the level of communication and the likelihood of “cross-pollination” of ideas between the groups.

Like Ford's assembly line, innovations that draw upon the knowledge embodied in existing and proven supply chains face fewer development problems, shorter lead times, and are more likely to be implemented successfully. Similarly, in his D-Day analogy, Moore describes assembling an invasion force of partners and allies that will augment the innovation with the variety of services and ancillary products necessary to transform the technology into the type of whole-product solution expected by mainstream markets ([41], p. 108). The complimentary assets [46] provided by partners are not limited to end use, but presumably may include development, production, marketing, distribution, and sales capabilities that innovative ventures typically cannot self-support in their early commercialization.

Thus far, the discussion has focused largely though not exclusively on how technology characteristics and commercialization strategies might affect the facility with which discontinuous technologies will move through the innovation process. They are used to inform the design and development of Me- products, to which the discussion turns next.

4.2 Product development: Competing technologies, getting started, and the Me-product platform

Chapter 2's exploration of Me- technologies and opportunities raises the possibility of commercializing hydrogen-fuel-cell vehicles (H₂FCVs) not simply as clean cars and trucks, but as Mobile Electricity H₂FCVs (Me-FCVs). This section carries forward that discussion of technology development in the context of Me- product development, emphasizing "getting started" and the idea of a Me- product platform. In the process, it begins to assemble the foundation for a "Unified Theory of Mobile Energy" that would

eliminate the artificial and unfortunate division between vehicular fuel-cell and battery development, transforming those efforts from a zero-sum game into the management of a healthy portfolio of complementary technologies over time.

4.2.1 Getting started: Why start with combustion hybrids?

Returning to the nominal basis of this study, H₂FCV commercialization, questions have historically focused on how to make FCVs uncompromised and thus competitive with today's cars and trucks along traditional dimensions, such as driving range and cost. The premise of this study, again, is that H₂FCVs might be better commercialized as new products that provide novel value or services to consumers. Even from this perspective, combustion hybrids can be, and usually have been, seen as direct, often mutually exclusive, competition for FCVs. Indeed, GM, which has had a strong fuel-cell development programs for years, only recently admitted at a high level that a narrow cost-benefit mentality made them doubt the viability of combustion hybrids [47]. This does not diminish the value and importance of their fuel-cell-vehicle leadership, which may yet pay high dividends, but simply to note the following: that having apparently not taken a near-term, or at least more incremental, electric-drive-vehicle opportunity as seriously as what most would (now) agree is a longer-term proposition²⁵, this implies that GM's strategic vision²⁶ either saw the issue as a discrete choice between the two options or at least did not view the development of one as overly supportive of the other.

²⁵ if for no other reason than the time required to build up hydrogen, which, granted, is not GM's core business.

²⁶ This, apparently, has changed, with announcements in late 2006 of both GM's efforts, with partners Daimler and BMW to develop a "dual-mode" hybrid system and to modify that system for use in a plug-in hybrid version of the Saturn Vue SUV [48] "GM, BMW, Daimler to Invest US\$1 Billion in Hybrid Project," in *Reuters News*

By now the reader of this study can guess the emphasis here is not on the differences between electric-drive vehicles, but on their complementarities, particularly in the context of Me-. However, in the context of (increasingly historical?) advanced-vehicle development, it was a very short time ago indeed that the question, “Why start with gasoline-internal-combustion-engine hybrid-electric vehicles?” was much less clear. The question is still pertinent for several reasons. The ultimate viability and full market penetration of combustion hybrids as currently configured is not foregone. The marketability and ultimately realized benefits of combustion hybrids depends on design and perspective (e.g., hybrid technology can be used—as most of the car technology advances of the last few decades—to increase performance, and high-performance hybrids such as the first iteration of the Accord hybrid do not offer the fuel economy benefits the early market has apparently come to expect of hybrids). Further, the importance of zero-tailpipe-emission vehicles, domestic/diverse fuel supply, and low-carbon energy systems remains high. Nevertheless, the most important reason why to start with combustion hybrids is the most obvious one: because they now exist significantly in the marketplace. Once Toyota assured that reality with the introduction of its 2004 Prius, the role of combustion hybrids as competition to FCVs was also ensured. But so was the opportunity to leverage that market presence for Me- innovation.

Service, 10 August ed, 2006.. It will be interesting to see how the dual-mode system, which was criticized by plug-in advocates in advance of GM’s plug-in-hybrid announcements of being less suitable for providing AER and other electric-drive features will perform in the plug-in Vue prototypes.

4.2.1.1 *How innovation works*

As H₂FCVs and other electric-drive vehicles mature technologically, an increasingly important factor to their rapid and successful commercialization is an understanding on the part of their supportive communities of how innovation works. And, to the extent that Me- innovations provide “discontinuous” new services and value—e.g., requiring changes in the way consumers think and behave in relation to the technology (see section 4.1)—it can not be assumed that mainstream operations of automakers and/or other presumably business-savvy actors necessarily embody such an understanding. The following sections highlight a few issues related to the process of innovation worth highlighting in this discussion of Me-FCV commercialization.

“Recombinant” innovation and robust design

In *How Breakthroughs Happen: The Surprising Truth About How Companies Innovate* Hargadon [33] re-examines past technological transitions to emphasize the effectiveness of *recombinant* solutions: he lauds Ford for his abilities as a *technological broker*, bridging distant social worlds to bring and adapt *existing* solutions from other contexts to bear in his own. Similarly, Proctor & Gamble’s successful “Connect + Develop” approach emphasizes both “ready-to-go” technologies and products and the method of scouring the world for them using a technology-brokering open-innovation model [49].

Hargadon also emphasizes the *supportive-community* aspects of successful innovations over their popular mythologies of lone invention: he commends Edison not for his creative genius, but for building a nurturing community of innovators around him, and for artfully packaging his innovations in reassuringly familiar yet compelling designs.

The latter point speaks to the importance also of *robust design*, which encourages the consideration of which aspects of an innovation to present as novel (e.g., to create excitement) and which to disguise in “conventional” interfaces (to ease adoption and increase acceptance). For example, Edison intentionally did not use the full luminosity capabilities of his electric lights in order to fit them into the familiar gas-light paradigm in which they were trying to compete.

Such an example continues the conversation started in chapter 3 about the tension inherent in designing and developing products for what I tend to refer to as technical vs. “marketing” optima. In the case of Me- innovation commercialization, one may be tempted to move aggressively to market initially with the ultimate-eco-car design of an Me-FCV, full-function BEV, or large-battery-dominated plug-in hybrid. But the very clean-sheet, whole-system, technically-optimal design that unlocks truly new and substantial benefits and therefore generates discernable excitement²⁷ in the marketplace can end up hamstringing the innovation if its “newness” is not tempered so as to prevent the creation of cost, distribution, consumer-familiarity, or other hurdles that could slow or halt commercialization. As Hargadon reminds us, even something as technically simple as the zipper experienced 20 years of pre-commercial development after it was invented.

²⁷ Excitement itself is a force to be carefully managed, an often difficult challenge to starving new technology development efforts that must keep themselves in the headlines while not overpromising.

[50] M. Schrage, "Great Expectations," in *Technology Review*, vol. October, 2004, pp. 21.

Unleashing lead-user, do-it-yourself, and other external innovation

On the other hand, there are those outside of a given organization's R&D department, and even in the marketplace, who are not daunted by newness, unrefined products, or unresolved challenges—indeed, they may thrive on it. When such fortitude is found in consumers/adopters they play an important role in early market development as expert references and/or market-enhancing mavens [51]. Their ilk will be discussed more in section 4.3.3 and has long been described in various incarnations using technology diffusion theory (e.g., [41, 43, 52]).

Such qualities also exist in entrepreneurial form, and their potential usefulness as unconventional partners in technology and product development has become popular in the business press. As introduced in chapter 2's discussion of opportunities to “free yourself” with untethered Me-, companies are increasingly encouraged to turn for product-development input to lead users who modify the products and services they receive to a surprising degree [53]. Similarly, as mentioned above, “Connect + Develop” is an externally oriented model of innovation. It may thus be important not only to develop Me- business using sources of innovation external to traditional R&D with the major corporate players, but also to encourage lead-user innovation by designing opportunities into the products and services themselves. Consider that the recent attention given to combustion plug-in hybrids—the concept of which has existed in another, more academic, incarnation for at least a decade—is due in no small part to the presence of the 2004 Toyota Prius (and other hybrids) in the marketplace. Despite relatively widespread OEM resistance at the time, this vehicle (coupled with the promise of advanced batteries)

gave several entrepreneurial lead users both technological and market-reality shoulders to stand on as they undertook their conversion activities (see Table 2-1). Finding ways to actively yet safely *enable* such external innovations through do-it-yourself or external-innovation friendly design may provide even more fuel for Me- innovation as the various technologies described in chapter 2 are developed. Further, it would allow third-party developers to create customized solutions to individual needs (e.g., office-on-wheels, contractor, camping, catering, etc.), adding value in a similar way to the wide assortment of accessories for iPods that extend its functionality and amenity well beyond what it provides out of the box.

In conclusion, a better understanding of the way innovation tends to produce the greatest actual impact helps to inform technology and product development by highlighting the benefits of the strategies discussed above, such as *recombinant technology, technology brokering, supportive communities, robust design, open/external-innovation, and unleashing lead-user innovation*. These strategies and others²⁸ can be mined and applied to a given innovation to help identify product characteristics and other factors that increase the likelihood, speed, and/or overall success of the commercialization of innovations. Collectively, these characteristics form the basis of marketing-optimal technology and product design, to be weighed carefully against technical considerations. More broadly, these themes will be echoed throughout this chapter, pointing to ways that

²⁸ E.g., Rogers has collected various characteristics of innovations thought to be associated with more rapid diffusion in [43] E. M. Rogers, *Diffusion of innovations*, 5th ed. New York: Free Press, 2003..

Me-FCV commercialization as a whole can be conceived of in market-optimal, or at least more efficient and effective, terms.

The next sections briefly return to another aspect of beginning the process of Me-FCV commercialization with combustion hybrid product development (strategic option benefits) before attempting to incorporate the various lessons discussed here into a Me-product-development plan.

4.2.1.2 Starting with combustion hybrids: Strategic benefits

The need to start with what exists (a truism easily and sometimes appropriately forgotten in the creative worlds of research and invention) is at the heart of what have been described in the previous section as opportunities to improve the prospects of Me-FCV commercialization. We tend to know, and sometimes understand, what exists; the trouble with the future is that we can't remember it. A "desired end state" has been declared here to be Me-FCVs to focus our attention and analysis, but it must be acknowledged that most products and services do not simply "diffuse" through the marketplace but change, sometimes dramatically, with unknown and sometimes unknowable developments. However, viewing the two as connected—starting point and goal—allows us to once again view the innovator's bitter reality as opportunity. Given the realities of existing vehicle technologies and products, and given that Me-FCVs cannot be immediately implemented in their entirety, a vision of the goal nevertheless helps to identify what "no regrets" steps can be taken that both advance Me-FCV commercialization and provide more immediate value regardless of the ultimate destination. Further, steps can be identified and taken based on what is necessary to keep the option of Me-FCV

commercialization open (attainable) and progressing (cheaper and easier over time). “Minimum regrets” investments in such “option values” can be made even without expected direct returns based the probabilistic value of keeping doors open and the costs of having them closed.

Thus investments in combustion-hybrid technology- and product-development that support Me-FCV commercialization take on added value and should be identified and incorporated into an overall Me-FCV commercialization plan. This additional value can be more or less direct, more or less tangible. For example, investing in any component that can be used in both platforms would of course present a win-win situation. More realistically, components will be similar but not identical across platforms and products. Although Me-FCVs may ultimately require much larger electric motors than initial combustion plug-ins, investments in electric-motor materials, components, designs, supplier relationships, distribution channels, manufacturing, and/or other capabilities for combustion hybrids and plug-ins would support Me-FCVs relatively directly. Further, the size-vs.-cost tradeoff considerations for electric motors in even initial products might appropriately be biased to some degree in favor of an approach that supports both immediate and longer-term goals, within limits. Whether or not this was an explicit factor in Toyota’s determination to pursue a “full” hybrid approach, relative to Honda’s “mild hybrid” and GM’s starter/alternator, Toyota’s investment in larger/fuller systems (at the cost of higher initial incremental vehicle costs) earned them more design-space elbow room. In the case of the Prius, this elbow room made it easier to design a vehicle with a sufficiently large economy improvement to excite the early market. The investment, now

presumably being amortized as Prius production levels have been ramped up to mainstream-market levels, will presumably also give them better positioning to develop long AER vehicles, plug-ins, and other Me- services.

On the less tangible end of the spectrum, building up organizational experience, competencies, and relationships that support both starting-point and end-goal vehicle designs, either internally or through partnerships, might provide option and other values.

Finally, as will be discussed more in the next section, introducing early products concordant with longer-term goals starts the process of not just of lubricating supply-side channels and operations but markets. It may be of particular importance, given the lessons of innovation described in the previous section, to start creating markets for discontinuous services using relatively more familiar technologies and interfaces, even at compromised performance, in order to pave the way for the adoption of more valuable solutions.

4.2.2 Putting it together: The Me- product platform and development plan

Starting with the here and now, Figure 4-1 illustrates the possible development of today's gasoline hybrids into plug-in/-out hybrids based on a Me- platform²⁹. Specific products are illustrated as manifestations of the platform as it is developed over time, which is in turn built upon component technologies. ("GO" refers to gasoline-optional operation.)

²⁹ The term platform here is used in the sense of a product platform, as used in, e.g., the computer industry. Use in the car industry is similar, but a given platform is sometimes confounded with the specific products that are based on it, giving it more of a sense of a specific set of mass-produced hardware (e.g., chassis, etc.) than a managerial concept.

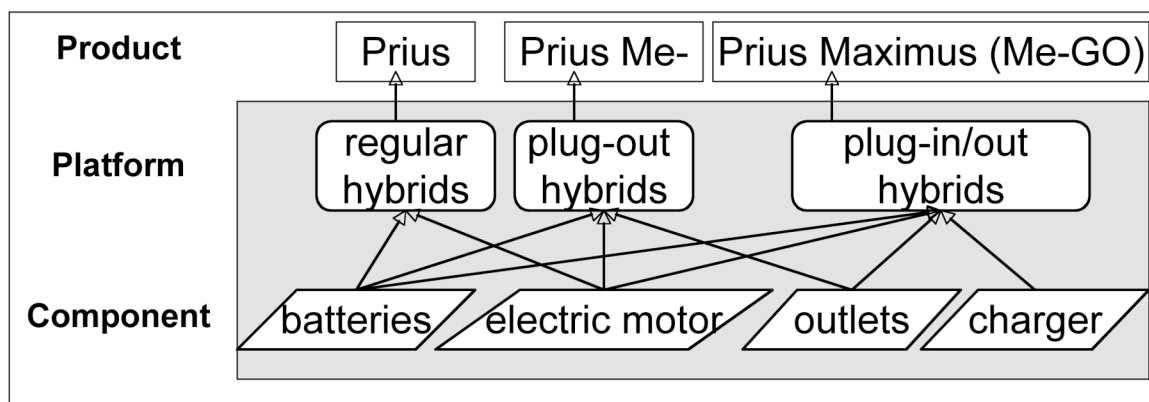

Fig. 4-1. Me- hybrid platform development

4.2.2.1 Taking the ICE hybrid to the next level: Initial Mobile Electricity products

The pre-Me- Hybrid

Following Figure 4-1, the starting point for Me- commercialization could be one of today's commercialized hybrids, such as Toyota's Prius. Although Figure 4-1 uses the Prius example to highlight the conceptual difference between a platform and a product, it is not meant to exclude other automakers efforts or to specify a vehicle type (e.g., sedan vs. SUV). However, it is worth noting that the success of the Prius relative to other hybrids makes it the de facto best example. It is worth speculating a bit about this relative success in so far as it might help inform product development. One hypothesized factor for success has been raised previously: by choosing a "full" hybrid strategy rather than focusing on narrowly defined costs and benefits, Toyota was able to produce a mainstream³⁰ hybrid with a market-leading, and presumably market-significant, fuel-economy-increase increment. Another factor that might be hypothesized for the success if

the Prius is that, in the 2004 version, this tangible improvement in fuel economy was wrapped in a Motor-Trend-Car-of-the-Year-winning package with a hybrid-specific design. The hybrid-specific design was a challenging departure for many, but not as radical, and certainly not as limited functionally, as the two-seater Insight. And it allowed the vehicle to take on greater symbolic meanings [54] for those purchasing the vehicle not due to economic-rational fuel-savings calculations (which do not appear to be the norm for consumers [55]) but as a statement (e.g., “I’m doing the right thing”), particularly for those consumers on the more evangelical end of spectrums such as environmental, energy-security, or anti-oil-company-profits. Although these hypotheses are not definitively tested here, a hybrid-specific, rather than transparent-option, approach to hybrid development might be warranted.

The Hybrid Me-

In any case, a successful hybrid release and its consumer base could be leveraged into an initial Hybrid Me- product line (e.g., the Prius Me-). Following Figure 4-1, these vehicles could initially provide relatively modest Me- capabilities, at relatively modest cost and effort, perhaps in advance of “big battery” maturity, in order to begin stimulating the growth of plug-out capabilities, consciousness, and external innovation relationships. For example, as confidence grows in the expected battery life of even the stock NiMH hybrid batteries, plug out capabilities could be nurtured with simple hardware modifications, starting with convenient high-power outlets. This would increase use of the battery (for non-propulsion purposes), and, interesting to note, decrease overall average driving

³⁰ in contrast to the Insight, which is more of a niche vehicle due to its two-door

efficiency (because the average state-of-charge available for driving would presumably be lower than, although within the same allowable limits of, a non-Me- hybrid). Although modest, as described in chapter 2, consumers and suppliers could power their imaginations as they grow increasing familiar with the opportunity to “take electricity off grid” to run a wide range of lifestyle activities, especially if third-party solution development could be stimulated to search for killer apps.

From Hybrid Me- to Hybrid Me-GO

With increased confidence in batteries, the depth-of-discharge range allowed could be expanded simply with software modifications, perhaps providing a market-significant level of all-electric, or at least engine-free, driving range, and expanding the Me- frontier a bit. Finally, the development of advanced batteries capable of providing market-significant AER could be offered in a Hybrid Me-GO product (e.g., Prius Maximus) with plug-in capabilities and the lure of “gasoline-optional” operation. As noted in chapter 2 and [13], this final transition is perhaps trickier than it might seem, as the desire to keep battery cost, and thus size, down is in conflict with the need for long battery life, and thus shallow allowable depths of discharge.

The Me- Interface

Simultaneously, another opportunity for intellectual property development would emerge for a complementary Me- product platform described in chapter 2: the Me- Interface (Me-I). Initial Me-I products could coordinate power flow and prioritize loads for Me-

configuration and small size

vehicles to provide emergency, backup, and/or high-quality power to buildings such as homes or small businesses. This platform in turn could be developed over time to allow for utility-side-of-the-meter interactions and, ultimately, vehicular distributed generation or V2G grid-support services.

Me- infomercial

Following chapter 2's descriptions of Me- technologies and opportunities, the value propositions for initial Me- products could collectively be summarized with the following tag line:

- Free yourself (with untethered power),
- Fuel yourself (by plugging in at home),
- Secure yourself (with emergency power), and
- Make money (with V2G net revenues)...

Mobile Energy Solutions™ (MES)

Additional product details: Me- SUV?

Although the discussion of products has intentionally not focused on a specific vehicle-type, several arguments might be made for commercializing Me-SUVs.

The first set of arguments has to do with reducing gasoline consumption and emissions.

Although producing a low-guilt SUV will undoubtedly cause some consumers who would not otherwise purchase an SUV to do so, if we assume that most consumers will buy one regardless, consider the following potential reductions. Improving a 20-mpg

vehicle by 5 mpg saves: $(15\text{k mi}/20\text{ mpg}) - (15\text{k mi}/25\text{ mpg}) = 150\text{ gal/y}$, whereas improving a 30-mpg vehicle by 5 mpg saves: $(15\text{k mi}/30\text{ mpg}) - (15\text{k mi}/35\text{ mpg}) = 74\text{ gal/y}$. Thus, improving an SUV's fuel economy can save as much fuel per year as greater absolute improvements made to a sedan. Additionally, according the HEVWG study [13], the cost of reducing emissions with an SUV PHEV20 is $-\$125,000$ per ton which is less than $-\$116\text{k/T}$ for a mid-sized sedan PHEV20.

The next set of arguments for commercializing Me- SUVs has to do with pricing. The greater profit margins on SUVs might allow a less painful loss-leader strategy.

Additionally, the price sensitivity of the SUV market tends to be lower. Further, the necessary price increases may be less "visible." Consider for example $\$6\text{k}$ on top of a $\$38\text{k}$ SUV (16% increase) vs. $\$4\text{k}$ on top of a $\$19\text{k}$ sedan (22% increase).

Finally, several technical arguments can be made in favor of Me- SUV commercialization. Because batteries are manufactured as modular cells that experience volume-production benefits, the cell production volume benefits per vehicle of, say, 9.3-kWh packs for SUVs are greater than 5.88-kWh packs for sedans ($9.3/5.88 = 1.6$). Also, as the lifetime of battery packs decrease with increase in depth of discharge, it may be easier to meet both life and performance goals with larger packs. Consider that 20% SOC * 9.3 kWh for an SUV is greater than 20% * 5.88 kWh for a sedan.

4.2.2.2 *Product expansion*

Regardless of initial product choices, Me- product offerings can be expanded into a wide variety of vehicle types and Me- applications. A wide variety of fuel types could also be

supported in Me- products, just as can be seen by innovative modifications of today's hybrids, such as the ECD hydrogen-combustion Prius, Eco Fuel CNG Hybrid Escape, and Solar Electric Vehicles solar-paneled Prius. And, if the results from chapter 2 and the arguments made next hold, this product expansion and the development of the Me- platform may in time help usher in the age of zero-tailpipe-emission, high-power fuel-cell vehicles with several non-conventional refueling/recharging possibilities.

4.2.2.3 Unifying Mobile Electricity and hydrogen

Combustion vehicles based on the Me- hybrid platform would begin creating markets for Me- services, thereby transforming FCVs from radical and disruptive into sustaining products that emerge as one possible extension of this progression as hydrogen and FCs mature. Developing H₂FCVs in this way—as one possible manifestation or extension of a Me- platform—repositions H₂FCVs as a potentially cleaner, higher power, and more profitable contender in established and valuable Me- markets.

In other words, Me-FCVs would not have to create their own markets (and accomplish all that entails: retraining consumer behavior, setting up distribution channels, etc.) in order to be introduced, but rather would represent one possible extension or upgrade of an existing product line that serves demand for services created by combustion Me- hybrids. And, as the analysis in chapter 2 indicates, Me-FCVs represent a high-power, zero-emission, and high-value source of Me- services (including V2G net revenues) with a large Me- production possibilities frontier. Thus, these vehicles might have the opportunity to supplant combustion hybrids as they mature, rather than create their own completely disruptive markets *in order to* mature. To illustrate such a progression,

Figure 4-2 incorporates hydrogen and fuel cells into a roadmap that incorporates various aspects of the Me- framework discussed in chapter 2.

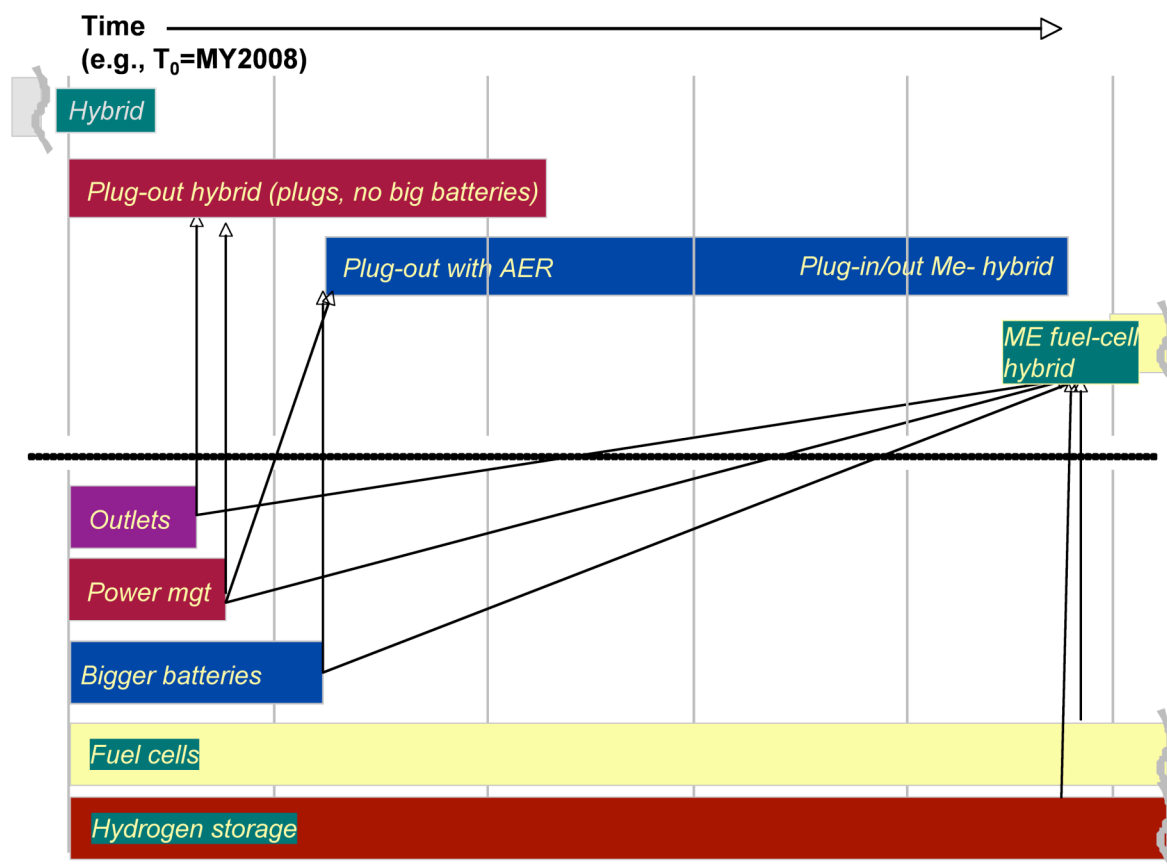

Fig. 4-2. Mobile Electricity hydrogen-fuel-cell vehicle development

The bars in Figure 4-2 represent innovative development efforts for the various technologies (below the horizontal line) and product types (above) that might require more entrepreneurial business models (e.g., external innovation, corporate ventures, relative autonomy given to special project teams/Skunkworks, etc.) Development efforts would of course continue after the colored bars—which are meant to be taken figuratively, not literally—run out, but presumably as more traditional technology- and

product-development efforts. Hydrogen and fuel-cell technologies are assumed to require continuing innovative development beyond their initial introduction, analogous to Honda's plan to "produce" a limited run of FCVs by 2008 based on the FCX-V concept, while at the same time acknowledging the full-scale commercialization timeline is more on the order of 2018 [56]. The plan represented by Figure 4-2 provides a framework for future work exploring business and marketing strategies for commercializing Me-technologies. Market-development topics are introduced in the next major section (4.3).

4.2.2.4 Roads not taken

Before moving on to a discussion of market development, it should again be acknowledged that Me-FCVs are only one possible extension of a Me- platform inaugurated with plug-in/plug-out combustion hybrids. A few speculative musings about roads not explicitly explored by this study follow. However, one important aspect of framing advanced-vehicle development in terms of the Me- platform, as argued below, is that development of the Me- platform does not depend critically on such speculation or on any one technology. Rather it allows some flexibility (within the limits of larger forces such as infrastructure lock-in, etc.) to consider and weigh the various candidate technologies as they develop over time.

Once Me- ICE hybrids, why bother with hydrogen fuel cells?

To take the position of devil's advocate, it is fair to ask why a company would go to all the trouble to develop hydrogen and fuel-cell technologies once Me- combustion hybrids enter the marketplace. I will not attempt to fully recreate here all of the arguments in

favor of hydrogen-fuel-cell technologies—which have attained an unprecedented level of momentum in the previously reluctant oil and auto industries—or of a so-called hydrogen economy that uses complementary and interchangeable electron- and proton-based energy carriers. Rather, at this point I will point the reader to the analysis in the references and to those factors that have been raised throughout this study, e.g., zero-tailpipe-emission, high-efficiency, and high-performance end use based on a low-carbon fuel with a diverse, domestic, and potentially non-fossil/renewable production portfolio, and, in the context of Me- vehicles: rapid and non-conventional refueling options, large Me- production possibilities frontier (long range and/or high power), and, accordingly, potentially high-power and -value Me- services.

Whither hybridization and the BEV?

Now that the basic features of a platform evolution supportive of a H₂FCV future have been outlined, and assuming for the moment that the case can be made for ultimately moving past combustion engines to fuel cells, it may be tempting for some to unconsciously slip back into a fuel-cell vs. battery mindset and ask “whither BEVs?” or even “wither BEVs?” I would caution against that temptation (see below). However, it is conceivable, that, once given a foothold H₂FCVs will blossom, showing their true colors—one of which is that they do not *need* to be hybridized, certainly not for the sake of providing high efficiency over typical driving conditions (see Figure 8 in [28]).

Further, chapter 2’s analysis of Me- opportunities for FCVs is not overly dependent on hybridization, except to the extent it is required to provide 1) the driving performance

required to sell the vehicles in the first place, and 2) relatively modest overall hydrogen-to-AC-electricity conversion efficiencies. In the future, hybridization may not be required to accomplish these requirements. Indeed, even some of the first high-efficiency prototypes, such as Ford's P2000, were not hybridized, thus avoiding the cost and complexity of marrying the two systems. Further, there are indications that even analytically "big-battery" H₂FCVs can experience a slight *decrease* in overall efficiency [57]. In a future where fuel cells have matured enough for marketable light-duty vehicles, improvements in start-up and transient performance, cost reduction, increasingly prevalent infrastructure, and so forth, may actually allow continued product improvements at *decreasing* levels of hybridization.

On the other hand, simpler, more elegant, in many ways more mature, battery vehicles are bound to re-emerge into niches where they arguably should have been marketed in the first place. Tesla's successful pre-sales, AC Propulsion's Scion conversions, and so forth, are reminders that BEVs continue down development paths of their own. This momentum, bolstered by related developments and experience with batteries onboard hybrids, may act as the harbingers of death to "complicated" fuel-cell systems and hydrogen conversion losses.

Nevertheless, BEVs currently still must overcome the same fundamental hurdles preventing them from supplanting "fully functional" vehicles as currently defined. These challenges are perhaps most deeply appreciated by, and still seen on the faces of, the automakers, even as the initial sex-appeal wave of (the longer-term proposition of)

H₂FCVs ebbs as market “success” of hybrids, and the possible near-term promise of PHEVs flows.

The nominal premise of this work is to investigate the commercialization of hydrogen and fuel-cell technologies (for which Mobile Electricity will undoubtedly been seen as a distraction by some), but the author fully acknowledges the possibility Me- ICE hybrids, or, more simply, PHEVs may indeed evolve bigger and bigger batteries, passing a point of battery-assisted ICE platforms to one of ICE-assisted battery dominance, with never a look back at the fuel cell. That this investigation explores how to better achieve the presumed-desirable end-goal of H₂FCV commercialization does not mean it necessarily advocates that end-goal or guarantees it. Indeed, Me- may assure the opposite, by, for example, squeezing the competitive advantage of fuel cells into ever decreasing margins.

Then again, it is possible fuel cells may continue to offer many of the same benefits—particularly at the “fully functional” and “uncompromised” end of an increasingly diverse vehicle spectrum—that garnished the technology unprecedented attention and excitement at the turn of the century. And so the speculation goes, back and forth. The former possibility (that BEVs may re-emerge, for good this time) is beyond the scope of this work. However, examining the latter possibility (that H₂FCs will continue to offer benefits that, e.g., justify hydrogen’s lifecycle conversion losses) in the manner pursued here returns the fuel-cell vs. battery debate to a more productive evaluation of promising advanced-vehicle components. In other words, exploring the possibility that successful Me- platform development may—by helping to overcome (or at least redefine)

infrastructure, fuel-storage, and initial cost barriers—*enable* hydrogen-fuel-cell commercialization using the product-development and technology management process discussed in this chapter *highlights* what will undoubtedly be a series of decision points in the Me- platform development plan. Just as it must be determined when H₂FCs are ready to be included in Me- platforms, so the further growth of the battery contribution to the platform should and undoubtedly will be considered, vis-à-vis fuel cells and other currently unknowable options and configurations, based on the current status of the technologies at the time.

While the future of fuel-cell, battery, or ICE-hybrid dominance remains uncertain—indeed is arguably unknowable—one of the advantages to developing a Mobile Electricity strategy using the methods employed here (vs. say, simply modeling an “optimal” H₂FCV) is robustness. Taken with a bit of technological agnosticism, the Mobile Electricity framework appears to be somewhat robust: if the value proposition for H₂FCVs does not pan out (or is not sufficiently supported by policy), Mobile electricity offers advice about plug-in hybrid development. If the regulatory, coordination, and other hurdles to, for example, V2G power provision remain insurmountable, Me- offers other opportunities for plug-in ICE hybrids and FCVs alike. Even if the Me- bucket of opportunities itself does not prove to contain any babies worth separating from the bath water, it is hoped this study will have provided some insight as to how to think and act on clean-vehicle commercialization opportunities.

4.3 Market development: The search for value propositions, marketing discontinuous products, and niches

4.3.1 Section introduction and overview

This section on market development begins by revisiting the innovation premise introduced in chapter 1 in relation to finding “value propositions” to drive Me-FCV commercialization. Spread throughout this study, the potential benefits of Me- innovation are numerous and arguably compelling, yet remain too diffuse and spread across too many actors to yet be considered a value proposition in the traditional marketing sense of addressing burning consumer needs. In order to strike a marketing bull’s-eye, subsequent study of Me- innovation will need to narrow the shotgun approach taken here to rifle-like precision by increasingly focusing on more specific contexts. Nevertheless, this section argues that Me- presents the opportunity to break consumers and suppliers out of a self-reinforcing singular definition of vehicle products and points the way to more product diversity and differentiation. The introduction of innovative new products and services, however, requires greater attention to the early market dynamics that govern the diffusion of discontinuous technologies into the mainstream. These dynamics are perhaps more familiar to high-tech than to automotive and energy marketers. Further, in the spirit of searching more narrowly defined, specific contexts for Me- value, two additional issues related to “getting started” with Me- innovation are discussed: the consideration of market niches and the potential benefits of aggregated applications. The latter is illustrated using the example of a rental-car parking-lot power plant.

4.3.2 *Why Me-FCVs again?: Searching for product differentiation*

“Killer app,” “competitive advantage,” “value proposition.” Commonly used in technology magazines, start-up business plans, and marketing campaigns for innovative products, these terms get less play in the automotive industry where vehicles have essentially the same set of attributes and provide largely the same set of services, with some variation between vehicle classes and option packages. The homogeneity of conventional fuel products is perhaps even higher, presenting even fewer opportunities [7]. It is not much of a stretch, then, to describe automaking as a cutthroat commodity business constantly in need of product differentiation.

Unlike some other fungible products, however, part of the reason value differentiation might appear to be lacking in the automaking industry is that modern automobiles already uniformly and affordably provide an extremely high level of comfort, convenience, and other qualities at an affordable price and under tight regulation. It is this very standard of “uncompromised mobility” that has plagued efforts to introduce immature and significantly different alternatives, which typically fall short on one or more dimensions. This has produced the precept amongst chastened veteran advanced-technology-vehicle developers that new offerings must be equal to or better than existing cars in every way.

Further, the relative homogeneity of vehicle offerings is a self-reinforcing phenomenon: consumer expectations are ratcheted tightly to a singular definition of the typical passenger vehicle, indirectly making vehicle suppliers reluctant to provide transportation

products that differ dramatically in performance from their core-competency mass-market passenger vehicles, as many alternatively fueled vehicles (AFVs) tend to do³¹.

H₂FCVs must thus fight an uphill battle in order to break into a competitive industry with mature, high-quality products and an uncompromising, self-reinforcing product definition. Even when conceived simply as clean cars and trucks, H₂FCVs promise to be less “compromised” than 1990s-era battery-EVs on several dimensions (e.g., fast refueling and driving range) while providing the same palatable difference that zero-tailpipe-emission electric drive offers over alternative fuels in internal-combustion-engine vehicles [44]. Nonetheless, they remain compromised relative to today’s gasoline vehicle options in many ways (e.g., driving range, refueling opportunity, proven reliability, and, particularly for the foreseeable future, price). Given they have already failed the precept of providing uncompromised personal mobility, H₂FCVs arguably must provide innovative value in order to be successfully adopted.

Me- offers the opportunity to leverage the unique set of H₂FCV attributes and to *clearly* differentiate H₂FCVs and drive their commercialization by creating *new* value propositions for the consumer. Me- not only offers the basis for new value propositions, but also gives automakers the opportunity to fundamentally redefine themselves and the products and services they offer and support, much as “energy companies” formally

³¹ One might speculate that—had ways been found around this self-reinforcing cycle and battery-electric vehicles recognized, designed, and marketed not as compromised mainstream vehicles but as niche or otherwise non-traditional offerings in a diverse personal mobility portfolio—the outcome of those development efforts might have been different.

known as oil companies and soon to be known as diversified energy service suppliers are trying to do now. With these opportunities, however, come the uncertainties that accompany new “game changing” or discontinuous products and services that will have complicated and uncertain implications both for producers and consumer lifestyles. Of particular importance to market development for new products with potentially discontinuous effects on consumer and producer behavior are early market dynamics.

4.3.3 Marketing discontinuous and unfamiliar products

Why might automakers and energy companies, with extensive market-development capabilities and experience and capital-intensive and highly regulated industries want to pay close attention to start-up issues faced by software geeks in the high tech world? Sometimes state-of-the-art business practice isn't good enough. Christensen [42] (reviewed in more in detail in section 4.1 and the appendices) describes the surprise many large successful companies in several industries have faced when disruptive technologies considered unattractive by their current customer base have nevertheless succeeded, having been nurtured through rapid improvements in other markets with different priorities. He advises companies to not be beholden to customer opinions and examine opportunities to invest in seemingly inferior technologies that nevertheless have the potential to disrupt current practice.

Similarly confoundable are efforts to evaluate with consumers the value of substantively different vehicle products, particularly using traditional methods such as econometric modeling based on consumer “rational choice” methods [52]. Turrentine and Sperling [58] (reviewed in more detail in the appendices) also discuss the inadequacies of

evaluating AFV value using “rational choice” methods when faced with preference instability due to the uncertainty and unfamiliarity surrounding AFVs and their attributes, let alone any new services they might provide. Enhancing the description of the AFV purchase decision with concepts from psychology and other social-science fields, they relegate a more limited, mature-market role to the use of “rational” frameworks that rely on consumers making comprehensive and sophisticated compensatory-trade-off and cost-benefit valuations. They argue 1) the greater usefulness of thinking about consumer consideration of AFVs using a staged evaluation process that focuses first on major aspects, such as vehicle size, with subsequent evaluation of a small number of remaining vehicle candidates, and 2) the importance of early-adopter groups (in their case, described as moral/social choosers and experimenters) in their influence on later, more utilitarian consumers. The discussion now turns to the second point.

4.3.3.1 The technology adoption life cycle

As introduced in the discussion of product development, early adopters/lead users play an important role in the commercialization of new technologies and merit close attention. In order to examine the adoption of a new technology over time, diffusion-of-innovation (DOI) theory [43] depicts the diffusion of the product throughout the consumers in a marketplace using a technology-adoption-life-cycle (TALC) framework. Graphically, the technology adoption life cycle idealizes the marginal level of consumer adoption over time as a bell-shaped normal distribution (see also appendix 7.2 and Figures 4-3 through 4-7). Assuming that, on average, consumers would adopt, say, V2G H₂FCVs at time t , as there are in general a large number of factors that could contribute to a given consumer adopting later or earlier than t , the normal distribution is an appropriate descriptive

device. Thus, the bell curve for V2G H₂FCV adoption can be drawn with the number of consumers on the y-axis, time on the x-axis, and centered at a time t when the most consumers simultaneously choose to adopt. Consumers to the left of the mean time t adopt earlier than average, those to the right adopt later. The TALC further assumes the normal distribution can be divided into several groups of consumers. The “majority,” appropriately, includes the bulk of consumers (e.g., those within two standard deviations on either side from the mean value) and is divided by the mean value into the “early majority” and “late majority.” Those outside of the majority, analogous to the statistical notion of outliers, are considered “laggards” if very late adopters or “early adopters” (and “innovators” if extremely early).

Innovators are the critical “importers” of an innovation into a group (Rogers in [36], p. 32). Often, the slowness of getting technology adoption started is further highlighted by the use of a slightly asymmetrical curve, whereby the “innovator” tail builds more slowly (at a shallower angle) over time than the number of laggards declines; the left half of the curve may also be larger (i.e., consisting of more consumers) than the right half.

The modified technology adoption life cycle

As Kurani, Sperling et al. point out (ibid, p. 46) it is technically not possible to identify “early adopters” a priori, because they are defined relative to others only after those others have actually adopted the technology. However, this fact has not deterred quantitative speculation and the, perhaps more interesting, qualitative use of the TALC as a framework for understanding early market dynamics. Notably, Moore [41] (reviewed in

more detail in section 4.1 and the appendices) formulates a strategy for high-tech marketing based on a DOI technology adoption curve divided into more discrete but familiar pieces: early-market consumers, consisting first of innovators and early adopters, and mainstream-market consumers, consisting of the early majority, the late majority, and laggards. These pieces, and the gaps he artfully chops and describes between them, emphasize psychographic³² differences between consumer types that he argues should be explicitly acknowledged and embodied into marketing strategies in order to assure a behavior-changing technology's continued march through the adoption process towards profitability. In particular, he emphasizes the deadly crossing that must be made between early and majority consumers. It is one he describes as requiring the careful planning of a D-Day attack, complete with an invasion force honed to capture critical market beachheads that will give them a foothold in profitable mainstream markets. Several lessons embodied in those analogies are beyond the scope of this study but future work may prove them valuable for the commercialization of discontinuous vehicle technologies such as those that supply Me- services.

Conceptualizing Me- diffusion with technology adoption life cycles

Departing from Moore's focus on consumer psychographics, but building on his modified technology adoption life cycle model in the context Me-, Figure 4-3 illustrates an H₂FCV V2G technology adoption curve distinguishing early from majority consumers, where the red vertical line separating the two represents Moore's chasm. For simplicity, however, the y-axis in Figure 4-3 and all subsequent figures represents the number of vehicles

³² Psychographics are a combined set of demographic and psychological characteristics of

adopted, not number of consumers adopting. The groupings thus represent the cluster of vehicles bought by, say, the early majority. (This convention will help keep things consistent when organizations, which vary widely in the number of vehicles per organization, are introduced below.)

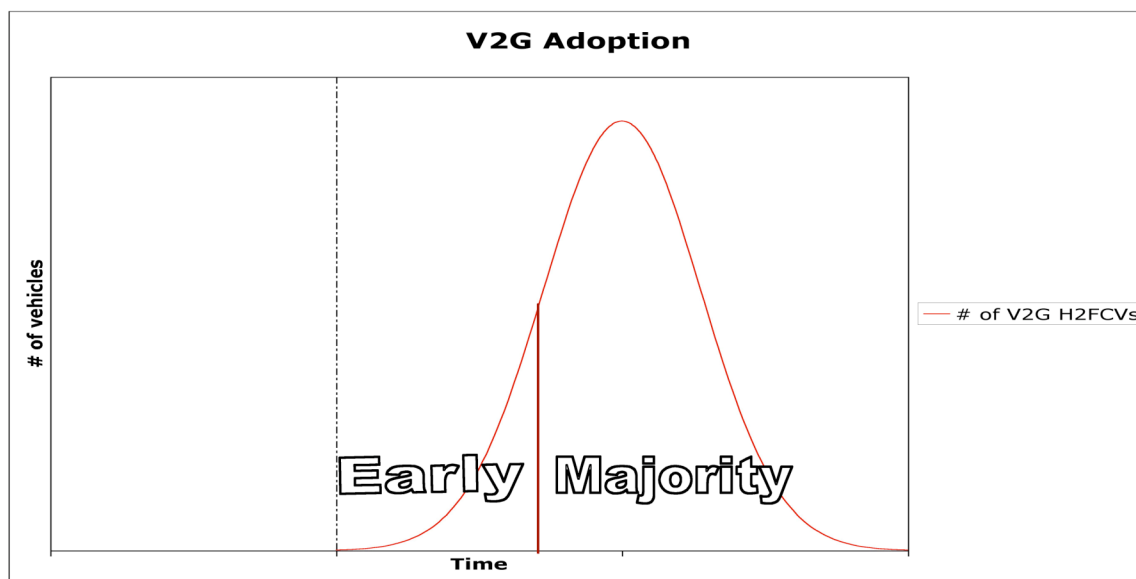

Fig. 4-3. H₂FCV V2G adoption: early vs. majority consumers³³

Figure 4-4 introduces the possibility of commercializing V2G H₂FCVs not only in households (HHs, now in blue), but also in organizational fleets (in pink). Nesbitt [59] argues that fleets cannot be considered a homogenous group, but rather have a wide variety of decision-making styles, priorities, fleet practices, and economic and physical resources. Accordingly, Figure 4-5 illustrates vehicles bought by organizational fleets

consumers.

³³ Note that “early” in DOI terminology can be confusing. It is used in a relative sense; thus there is an “early majority” that are “early” adopters (relative to the rest of the majority, but who are not “early adopters” (the group defined as “early” relative to the group of adopters taken as a whole).

over a wide distribution of adoption time, including some laggards that are as, or more, reluctant than HH laggards. However, fleet adoption is modeled here as having a mean adoption time significantly in advance of the HH mean, due to the advantages described in the discussions about strategic niche marketing (section 4.3.4).

For additional simplification, it is assumed that organizations will be able to provide V2G power using ICE hybrids (vehicles to the left of the grey vertical line marking the time of V2G-capable H₂FCV introduction), whereas HHs will not, perhaps due to future emission regulation.

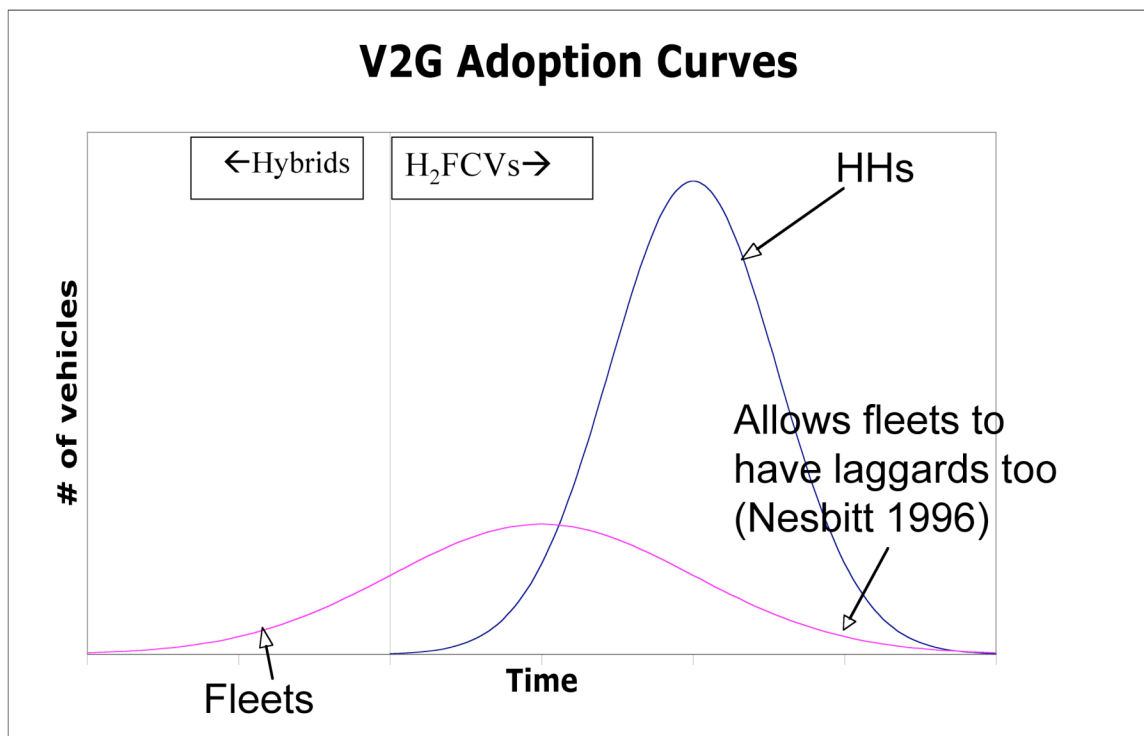

Fig. 4-4. V2G adoption by ownership: household (HH) vs. organizational fleet

Although the preceding figures depart from Moore's emphasis on psychographic differences amongst various market consumers, and although it is difficult to treat organizations and individuals/HHs in the same framework, it is conceivable that a chasm strategically similar to the one Moore describes exists along another dimension between commercialization of AFVs in fleets and commercialization in HHs that has yet to be crossed in a meaningful way.³⁴ This may be due, in part, to the failure of regulatory and other measures to acknowledge the differences between the two consumer bases and plan for the difficult transition, in a manner analogous to Moore's description of high-tech firms that fall into the chasm between early adopters and the early majority. For example, an important feature of Moore's chasm is the lack of informational and influential overlap between the two groups. Each group is a relatively self-contained self-referencing group when it comes to information about the new product. Disconnected from the early adopters in this regard, there is no credible/accessible source of endorsement or other form of "word-of-mouth" buzz for the technology in the early majority. Similarly, fleets are probably not a widely accessible reference base for HH vehicle purchases.

Next, assuming that the HH market for passenger vehicles is relatively psychographically homogenous compared to the heterogeneity defining households pre-adapted to plugging in and refueling V2G-capable H₂FCVs at home (as analyzed in chapter 3), then this largest effective "chasm" in the HH market might then be co-opted to represent these *capability* differences. One can imagine the step most immediately previous to adoption of V2G H₂FCVs by HHs who take advantage of such features at their own home might

³⁴ See the appendices for more discussion on past AFV commercialization efforts.

be for a limited number of HHs to privately own vehicles for which they can only capture the benefits of V2G power and non-conventional recharging/refueling at select away-from-home locations. A logical place to aggregate this limited number of V2G sites is at the workplace, particularly those with at least modestly large parking lots and/or on-site customer-side-of-the-meter needs (such as for peak power or demand-charge reduction). This aggregation feature of “at-work” V2G has several benefits that make it promising in the early stages of V2G commercialization (section 4.4).

Figure 4-5 illustrates this sequence by adding to Figure 4-4 (fleets and HHs) a chasm separating majority HH adopters able to do V2G at home from early HHs only able to do V2G at work.

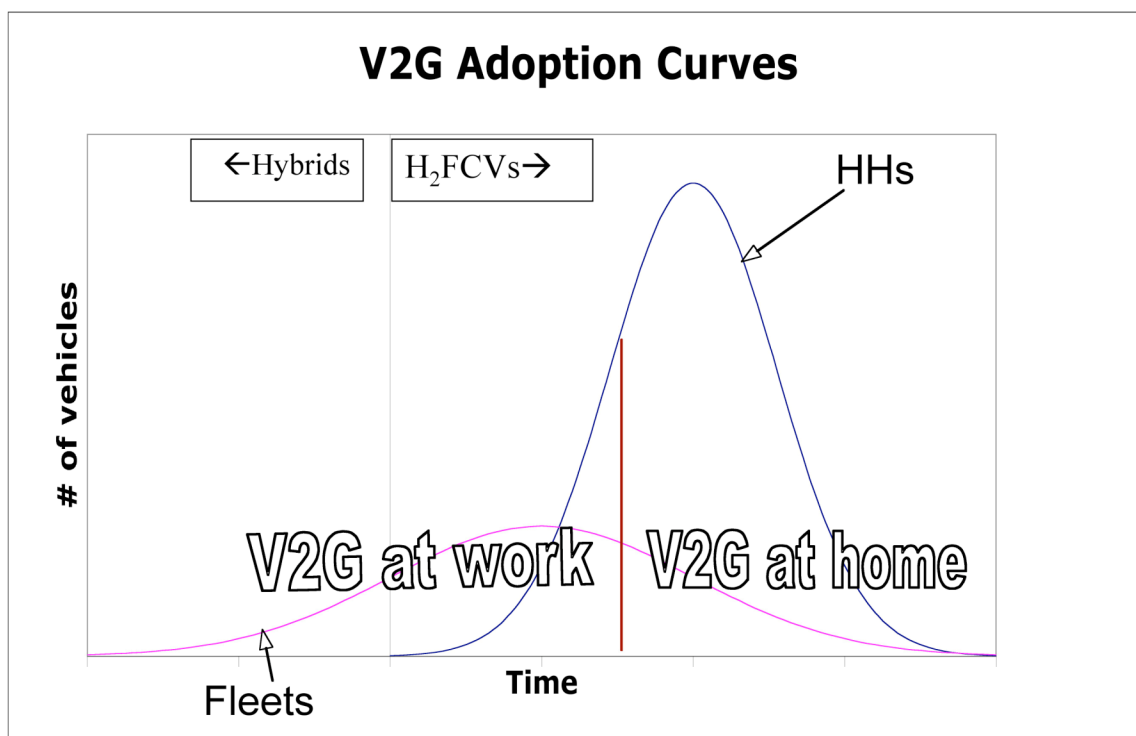

Fig. 4-5. V2G adoption: fleets, HHs able to do V2G only at work (early HH adopters), and HHs able to V2G at home (majority HHs)

Interestingly, this illustrative conceptual strategy resonates with novel ownership arrangements suggested elsewhere for EVs. For example, ([36], p. 117):

“...arrangements in which an employer or other vehicle provider owns the [neighborhood electric vehicles (NEVs)] and rents or leases them to employees are potentially valuable ways to provide consumers with experience with NEVs. Large institutional buyers, who might otherwise be good prospects for NEVs for their own fleet use, could operate NEV demonstration programs for their employees. Potentially, many large industrial, commercial, educational or health-related complexes could use NEVs in their own fleets of vehicles in demonstration projects for their employees.”

Arrangements like this one that would concentrate and aggregate early V2G commercialization to private vehicle owners around a few initial V2G sites could provide synergistic benefits to participants as well as a more cost-effective rollout strategy for the technology. Further, legitimizing AFVs for households through the employer/employee link (see also [5]) by bringing them “outside of the corporation-lot fence” provides one form of connection across the “super-chasm” posed by the difficult transition from organizationally owned to privately owned vehicles.

Figure 4-6 combines all of the other features developed during this initial, goal-retrospective conceptualization V2G-capable H₂FCV adoption, including the at-home/at-work chasm (A) and the fleet/private super-chasm (B). It also illustrates the possibility of a chasm separating early and majority fleet adopters (C), and suggests this division may be based on vehicle type (non-LDVs vs. LDVs).

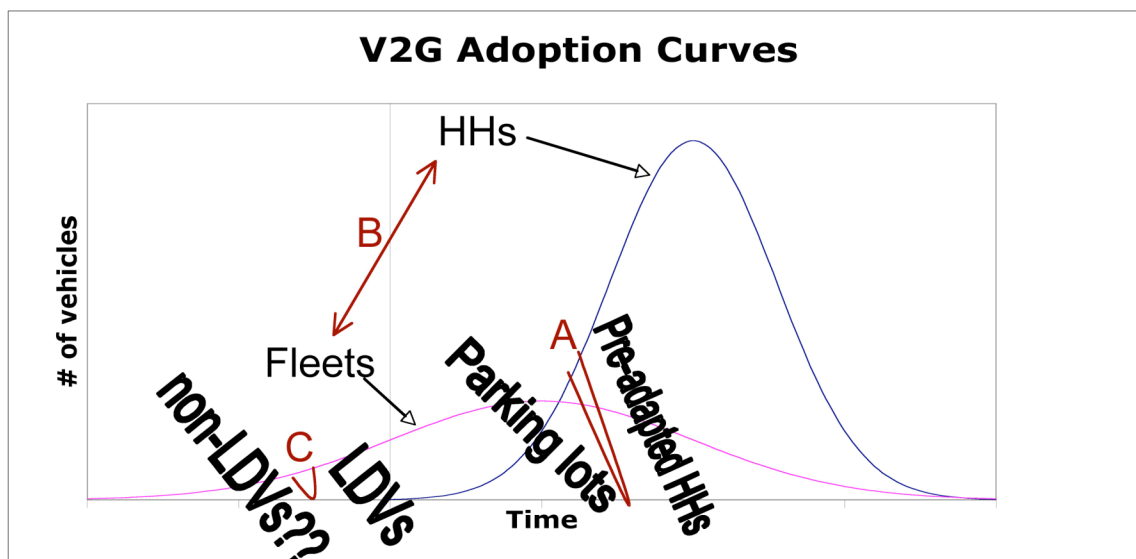

Fig. 4-6. Illustrative comprehensive V2G-capable-H₂FCV adoption model

4.3.4 Strategic marketing: Niches

The previous section stretched Moore's TALC chasm analogy by shifting the focus from consumer psychographics to more functionally defined heterogeneities, such as household pre-adaptedness to Me- innovation. As with chapter 3, this can be justified as a first step, and arguably because such issues are more important, to first order, than are psychographics. In other words, if someone cannot easily or cheaply use and benefit from Me- in the first place, it matters little if they are inclined to do so earlier or later in the adoption cycle. Stretching Moore's framework a bit further, organizational fleets, despite their own heterogeneities and past difficulties of regulating them to adopt AFVs, might nevertheless have characteristics that make them somewhat more tolerant of and able to benefit from—and thus have more reason to buy—V2G-capable-H₂FCVs earlier than households. And, correspondingly—were marketing strategies designed to capitalize on these characteristics and plans laid to explicitly address any fleet-household

commercialization chasm challenges that might arise—fleets might therefore be a good place to “get started” with Me- innovation, despite past failures to launch pervasive AFV markets in fleets. This section explores these issues for fleets in the wider context of market niches.

Christensen’s *Innovator’s Dilemma* legitimizes the process of taking disruptive technologies out of the mainstream to nurture them. In that sense, if innovative value is the driving force for the commercialization of disruptive products, the *Innovator’s Dilemma* helps pick the road to take (hopefully not one congested with forebodingly mature products). But what is meant by “out of the mainstream”? The primary market concepts used here are market segments and market niches.

4.3.4.1 Marketing definitions

The trouble with words like “market niche” is that you don’t know whose mouth they’ve been in.³⁵ For clarity, the following definitions are offered. Adapting [60], a “market” can be defined in terms of product, use, and consumers: $M=f(\text{Prod}, \text{Use}, \text{C})$. Products, in turn, can be thought of in terms of attributes, prices, and market information: $\text{Prod}=f(\text{Attr}, \text{P}, \text{Info})$, and a product’s “attribute vector” (Attr) defines its “product position.” Consumers can be thought of in terms of attitudes, perceptions, psychology, demographics, etc.—i.e., Moore’s psychographics.

³⁵ phrase adapted from a quote by Cambridge academic Susan Owens when discussing the concept of sustainable development in 1994

A “market segment” is meant to refer to relatively homogenous subset of a market (homogeneity makes the segment distinguishable and actionable and therefore managerially relevant). Traditionally, markets are segmented on the basis of, for example, past purchases or consumer preferences derived from surveys using importance ratings or rankings.³⁶

On the other hand, the dictionary definition of “niche” relates to the abilities, merits, or qualities of a thing. Thus a “market niche” is meant here to be a market subset defined primarily by use, e.g., as a function of use given a set of product attributes: $\text{niche} = f(\text{Use}|\text{Att})$. Ideally, market niches are desirous of a product’s attributes and tolerant of its weaknesses—a “safe harbor.” Note, however, that niches do not preclude the heterogeneity of consumer preferences, as market segments are meant to do.

In short, a “segment” is a homogeneous subset (related to consumers), whereas a “niche” is a use/application subset (related to product attributes).

4.3.4.2 *Strategic niche marketing and fleets*

Like biological organisms that find success in environmental niches for which they are best suited, so might new technologies like hydrogen vehicles best compete in market niches that have a relatively high value for hydrogen’s strengths and unique attributes (e.g., zero-tailpipe emissions, electric-drive benefits, potential use to supply Me- services, diverse fuel production portfolio) while being relatively indifferent to its weaknesses

³⁶ At an IQPC conference in Chicago in the 1990s, Jonas Bereisa of GM once rated the three most important attributes of cars as: #1=cost, #2=cost, #3=cupholders.

(e.g., voluminous storage, limited refueling, cost). But, just as the biological organism simultaneously affects and is affected by its environment, competitors, and so forth, so should niche marketing be an active, bi-directional, and strategic endeavor. As Moore reminds us, *marketing* is a active process of creating markets for your products, while simultaneously evolving the product based on an acute attention to the consumer. It should not be conceptually reduced to *sales* into a static market. Further, he argues, market *niches* should be managed strategically, acting as beachheads that are selected for their ability to lead to expanding opportunities and build market relationships, supply chains, and consumer reference bases. These concepts might help illustrate where several previous AFV commercialization efforts went wrong: by recognizing organizational fleets as a potentially attractive niche, but failing to recognize the extent to which these markets need to be actively managed and, critically, strategically expanded.

Hearing the siren's call of volume ramp-up, AFV market development efforts are easily lured towards the supposed harbor of organizational vehicle fleets. The logic for doing so can be compelling: large numbers of vehicles being bought per transaction into relatively controlled environments, often with centralized refueling and maintenance by trained professionals and known, often modest, mission requirements. Further, many organizations might be either highly motivated to adopt clean technologies (e.g., those with a public-service or environmental component to their missions) or highly manipulable (e.g., government officials can lead-by-example by dictating purchasing requirement to "their own" fleets).

However, the reality of AFV commercialization has not yet lived up to its apparent potential. As mentioned, fleet managers themselves are often conservative in their attention to the bottom line and heterogeneous in their behavior [61], reducing their potential as “early adopters” and fragmenting the stocks of fleet vehicles from one promising whole into a shattered array of market subsets, segmented by behavior, psychographics, and their own unique requirements. Further, the greater-than-expected difficulty of commercializing AFVs in organizational fleets either resulted in or was reinforced by diminished enthusiasm and commitment (e.g., as represented by the U.S. government’s abandonment of EPACT requirements).

Further jeopardizing the hopes of AFV commercialization in organizational fleets was the apparent lack of a follow-on plan, particularly one supportive of strategic market expansion and supplier and consumer community building. Hoping fleets would provide the magic elixir of volume sales, little previous attention seems to have been paid to ensuring the continuing success of AFVs in fleet markets (even if EPACT were enforced), let alone to the marketing transition from organizational to household consumers of AFVs. Lacking this drive, it is appropriate to ask not only “Were fleets a bad place to start?” but “Did we start badly with fleets?” [62].

The need to form strategic connections from one niche to another—from early markets to a beachhead in the majority to ever-expanding markets—was an important active-management ingredient missing from previous efforts that we now have at explicitly at our disposal for the commercialization of H₂FCVs and other Me- innovations. Thus, it

might be worth revisiting organizational fleets made up of predominately light-duty vehicles for the potentially beneficial role they might play in pre-household commercialization of Me- technologies. Further, the strategic niche framework should be, and is being, expanded to include a wide array of non-passenger-car transportation modes, and beyond.

For example, in their argument for the consideration of marine and other forms of freight transportation as the early markets for hydrogen, “A strategy for introducing hydrogen into transportation” [63] (reviewed in more detail in the appendices), Farrell, Keith et al. argue this explicitly in a framework emphasizing the importance of niche management. They discuss how such an approach makes the challenges facing hydrogen more manageable by constraining the scope of the infrastructure development and concentrating the hydrogen demand on fewer, larger, more heavily-used vehicles confined in a geographical area along point-to-point routes with professional crews and known mission requirements and which receive high levels of engineering and operational attention. Doing so, the authors claim, will cost-effectively unlock a virtuous cycle of learning-by-doing that is needed for hydrogen technologies to mature.

Indeed, the logic and benefits of introducing hydrogen into an even broader set of transportation niches is evidenced by dozens of recent press releases in the hydrogen and fuel-cell industry press. They include development efforts for forklifts, mining equipment, aircraft tow tractors, scooters, submarines, hummers, heavy-duty trucks, and

motorcycles, as well as fleet applications for medium- and light-duty vehicles such as delivery, construction contracting, and maintenance/repair.

Nevertheless, many questions still remain about a niche approach to hydrogen commercialization. Can you really slide down a production-volume learning curve through a series of niches? For example, to what extent does commercializing hydrogen in a fuel-storage-unconstrained application such as marine freight help its readiness for storage-constrained applications like LDVs? Again, the production-volume-as-panacea approach is unlikely to work in absence of awareness of the dynamic and bi-directional changes that hydrogen technologies will undergo/cause in each niche or application. Further, even with an awareness of the realities of fleet conservatism and heterogeneity, can we really expect to do much better in overall magnitude with H₂FCVs? What expectations might be more reasonable from a fleet-as-early-adopter approach, and how might fleets become one element of an overall approach to buying down the incremental costs of new technologies? Do any of these niches have enough drive to stand on their own? And, even if they might, will they be enough to excite the continued commitment of large industries like automaking (which has heretofore appeared uninterested in marketing vehicles to non-mainstream markets, such as those potentially emerging as suitable applications for city or neighborhood EVs)?

The question of whether or not fleets are a good place to start will not be resolved here, but strategic niche marketing considerations argues for their re-assessment. However, returning to the discussion at the beginning of this market-development section, all will

be for naught unless Me- benefits are refined into robust value propositions that allow H₂FCVs and other Me- technologies to move beyond niches into the profitable mainstream. Working in concert, the market-development strategies and considerations for discontinuous innovations discussed here can be used as tools to aid in the early market development for Me- technologies.

4.4 Illustrative aggregated Me- innovation example: Establishing V2G markets with airport rental-car parking-lot power plants

The following example, based on [11], outlines the use of internal-combustion-engine (ICE) hybrids in airport-rental-car and other aggregated applications to help create markets for H₂FCV V2G power [11]). Somewhat arbitrary and perhaps fanciful in its selection, this illustrative application might ironically provide a “reality check” for technological visionaries hoping to commercialize H₂FCVs by illustrating several of the innovation and product- and market-development considerations discussed in this chapter: It highlights the potential benefits of focusing initial attention not on H₂FCVs but on ICE hybrids, and not on individual households but “aggregated” ME power (i.e., using fleets or centralized into workplace or other “parking-lot power plants”³⁷). Once established, these markets could provide private value that would help drive the adoption of FCVs as they mature. Were such a strategy successful, V2G H₂FCVs might be transformed from radical and disruptive new technologies (presumably with limited commercialization prospects) into “sustaining” technologies in a way slightly different

³⁷ Further, imagining a parking lot as the unit of analysis is interesting in its own right: for example, Crandal estimates that shopping center parking-lots are full only a couple dozen hours per year, and that free parking represents a subsidy of hundreds of billions of dollars per year—roughly equivalent to a few dollars per gallon in costs that are not generally internalized.

than, but similar to the analogous process described for Me- platform development³⁸. As the approach taken in this example is slightly different than that in much of the rest of the dissertation, it is worth setting the stage explicitly:

Research Question: How can V2G markets be established to create innovative value for H₂FCVs?

Hypothesis: Using gasoline internal-combustion hybrids, running in a generation mode analogous to H₂FCV Me- operation (possibly on piped natural gas), in an initial aggregated application presents a compelling opportunity to begin creating V2G markets with expansion opportunities for H₂FCVs in due course.

Approach: This example applies lessons from innovation and marketing theory to address the problem of initiating a transition to a hydrogen economy by examining the creation of a specific innovative value flow for H₂FCVs. It assumes that previous analysis has established the promise of both hydrogen energy systems (including LDV H₂FCVs) as well as V2G support for the electrical system. This work focuses not on “Why?” (e.g., Why hydrogen? or Is hydrogen a good idea?) but “How?” (e.g., How do we get to hydrogen? or What do promising initial steps towards hydrogen look like?). Further, it

³⁸ One of the key differences is that Me- platform development is a technology-oriented approach, whereas the example described here is a market-oriented approach. However, there is no a priori reason to assume, as does this example, that V2G markets will form before H₂FCV or other electric-drive vehicles begin to be commercialized, perhaps with the assistance of other, less ambitious plug-in and plug-out opportunities.

attempts to incorporate lessons from past technological innovation and apply them to the specific case of creating V2G markets for H₂FCVs.

4.4.1.1 Designing a rental-car V2G application

To discuss a specific application for V2G H₂FCVs, this section follows and uses examples from [33], focusing on: technology brokering, robust application design, and community building.

Technology brokering: Using “existing” car technology to meet grid needs. Consider the 2004 Toyota Prius, available for less than \$30k and MotorTrend’s 2004 Car of the Year. It has an electric motor and power electronics that, in principle, could be adapted to provide V2G power with relatively little modification or cost. To provide the vehicle a connection to the grid, the charging hardware from the 1998 Toyota RAV4-EV or a purpose-built unit from AC Propulsion (~\$2,500) could be added to the vehicle. Further, following Kempton et al. [9]³⁹, an on-board, real-time electricity meter (estimated to cost ~\$50/car) could be used. Alternatively, electric power management hardware and metering imported from the distributed power generation industry could be employed for V2G applications where the power from several vehicles would be aggregated. Together, not including communications/operational costs described by Nitta [29], Kempton et al. estimate the total marginal costs for V2G vehicles, annualized with a 10% discount rate over ten years, could be approximately \$600 per vehicle. Further, such vehicles were

estimated to produce power at roughly 20¢/kWh in generation mode, competitive in some of the premium markets described in the discussion on V2G power and grid support.

This, in turn, could earn the vehicle owner anywhere from \$0 to several hundred dollars per car per year, enough promise to merit further investigation.

Application design: Aggregation benefits. Because the focus here is on the initial stages of V2G market formation, consider the potential benefits of aggregating V2G-capable vehicles to a single V2G site relative to the use of dispersed private vehicles. Among the possible benefits an aggregated application are that it could allow:

- centralized vehicle power aggregation, management, metering, and contracting;
- use of hardware adapted from the distributed power industry;
- bulk fuel purchasing contracts, including the possibility of piping clean natural gas to the vehicles when operating in generation mode; and
- spreading capital and operating costs over a large pool of vehicle-generated kWh.

It could also avoid various complications of implementing V2G power, by:

- avoiding tampering with onboard metering;
- preventing black-market energy sales (e.g., selling dirty, or otherwise not-contracted-for, power from hard-to-monitor dispersed individual vehicles);
- reducing communications requirements (e.g., no GPS signal needed);
- improving privacy by handling transactions on a lot basis; and
- avoiding driver-use profile tracking.

Application design: Rental-company beachhead. One potential aggregated, centrally located application for V2G hybrids would be the airport rental-car parking lot. A V2G aggregator could operate a fleet of V2G hybrids (and H₂FCVs and other electric-drive vehicles, as they mature). These vehicles could produce two major revenue streams: one

³⁹ Note: these vehicles, operating in generation mode in this context, have not yet been modeled using the Me- models described in chapter 2, but rather their characteristics are assembled from the sources cited.

from their use as rental vehicles and the other from V2G power provision. The second revenue stream would diversify the first and might include customer-side-of-the-meter benefits such as avoided peak-energy and demand charges and emergency/back-up power for critical loads, as well as grid support services, such as peak power generation, spinning reserves, and (possibly) regulation. Further, use of vehicles onsite at the airport for suitable tasks could contribute to airport “greening” and public relations efforts.

The supplemental revenue from V2G and onsite services could, in turn, lower the costs of making advanced-technology vehicles available for rental at the various rental-company counters. Having these vehicles available at more competitive prices could not only increase product offerings and differentiation, but also relax the variable inventory demands on the rental-car businesses. Further, automakers, including those previously uninterested in the rental business, would have the opportunity to get consumer face-time for their premium, advanced-technology vehicles, perhaps even in advance of showroom release.

The V2G aggregator could also benefit from the use of fleet management tools, databases, and best practices already existing or modified from the rental companies, minimizing from-scratch development.

Community building: Organizational features. One opportunity to foster innovation within a V2G aggregation company could be the formation of individual operations at each new airport location that operate independently, adapting to local conditions, but

share best practices with other operations within the larger organization. This strategy promotes a form of intra-company competition and cross-pollination of ideas, technologies, and practices. Extra-company exchange is also a critical, and provides linkages to the community developing around V2G innovation. Such exchange could be promoted by the careful and active use in the organization of liaisons to industry partners, and by the recruitment and hiring of executives from each of the major related industries (e.g., energy, telecom, rental, airport, etc.). This would provide benefits analogous to those described by Hargadon when Ford hired expertise from the meat packing industry, in effect brokering techniques from animal disassembly lines for use in car assembly.

Community building: Partnerships. Outside experts and industry liaisons could act not only as gatekeepers for innovative solutions, but to strengthen partnerships. Recognizing the importance of a supportive community—unlike Philo Farnsworth, a forgotten early inventor of the television [64]—the development effort would not try to go it alone, play its inventions too close to the vest, or fail to see the importance of partnerships and complementary assets to the innovation process. It would seek relationships, assistance, investment, ideas, understanding, products, etc. from (other): auto manufacturers, fuel providers, rental car companies, grid operators, utilities, metering and connection technology suppliers, etc.

Stable brokerage position vs. building redundant ties. The formation of partnerships would place a V2G aggregation company in a powerful, central position. Perhaps counter-intuitively, however, the importance of this valuable brokerage positioning must

be carefully weighed against the health of the nascent industry. Building redundant ties between the participating industries, for example by encouraging Toyota engineers to talk *directly* to SMUD (not only using the aggregator as a conduit), would produce the dialog necessary for the appropriate design of V2G technologies, improving the value of the solutions provided by all. Further, the presence of competitors acts to legitimize innovations, grow complementary assets, and increase the overall size of the market

This balancing act is the choice between the careful defense of a valuable brokerage position in a small industry (“big fish in a small pond”) or sacrificing that position for lesser control of a larger potential market (“a rising tide lifts all boats”). The risk of not forming redundant ties within the community is great, however: being a big fish in a pond that evaporates is the worst-case scenario (read: Betamax).

But what about the environment? Even if the environmental aspects of this example were not beyond the scope of this investigation as a whole, they would have been intentionally if artificially been de-emphasized to acknowledge the important lesson for reluctant visionaries/founders that the full vision/potential of an innovation often must be initially sacrificed to facilitate the business case, for example using familiar paradigms as Edison did when initially using dimmer electrical lights to match the gas-light paradigm it was trying to replace. Nevertheless, this example of using LDVs as electric power plants can at least pass an environmental laugh test: Brooks and Gage [30] compare the emissions of a pre-2004 Prius on dyno at constant speed with a combined-cycle power plant and find: lower hydrocarbon, and much lower oxides of nitrogen emissions (the major smog

precursors), but higher CO emissions. This illustrates that the scale benefits of central power plants are rivaled by the strictly regulated emissions from mass-produced LDVs.

Expansion: Other vehicle technologies. Other hybrid models—such as the Lexus RX440, Ford Escape, Toyota Camry, Honda Accord, etc.—could be incorporated into the various business models as appropriate. Further, new powertrain technologies, such as H₂FCVs, could be literally and figuratively plugged into the markets as they mature. By creating markets for V2G power services with vehicle technologies already existing in the marketplace, thereby displacing some of the innovation’s discontinuous characteristics to reassuringly familiar technologies with established supply chains, H₂FCV technology might be transformed from a radical and disruptive technology into a sustaining technology within the context of now-profitable V2G markets. H₂FCV technology—having zero-tailpipe emissions, providing greater electrical power more efficiently, and using domestically produced hydrogen fuel—might represent a new “gold standard” for V2G power provision.

Expansion: Other aggregated and dispersed V2G opportunities. Additional aggregated-fleet V2G applications include: other airport sites and utility, government, and corporate-fleet-parking lots. Once one or more niche V2G markets have been established using similar energy-arbitrage and other core capabilities, they could be leveraged as beachheads for private vehicles, for example in work-place parking lots that facilitate carryover of these competencies into future dispersed vehicle markets. Following section

4.3.3.1, Figure 4-7 illustrates this approach, tying together and summarizing the various aspects of the dissertation research illustrated by this example.

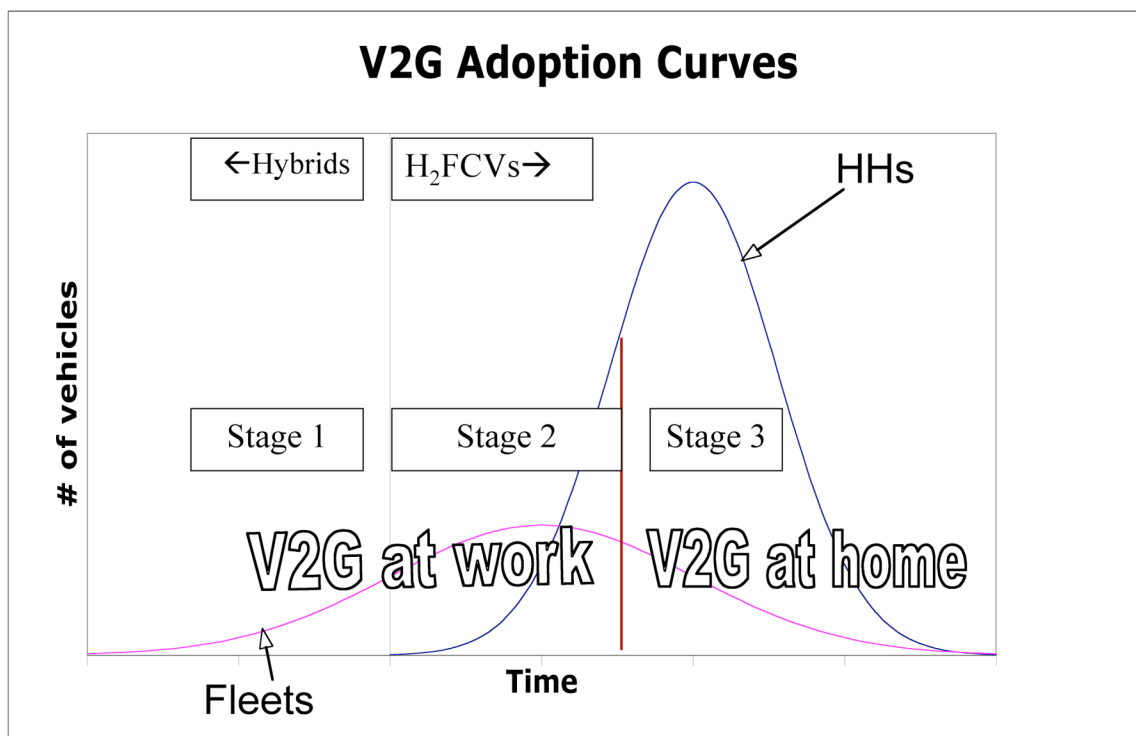

Fig. 4-7. V2G market development and expansion

Stage 1: initiating V2G power markets using ICE hybrid-electric vehicles in an aggregated application, such as airport rental fleets (guided by recombinant-innovation theory)

Stage 2: building on Stage 1, Stage 2 involves: 1) expanding to other organizations and transitioning to V2G-capable H₂FCVs, and 2) marketing to motivated households with privately owned vehicles able to do V2G/refueling at work (guided by technology adoption theory)

Stage 3: marketing to private households for use of Me-FCVs at home (guided by technology adoption theory and market analysis of California households relatively pre-adapted to V2G/home-recharging/refueling adoption as presented in chapter 3)

4.5 Chapter summary and conclusions

Chapter 4 takes one possible future state (e.g., widespread commercialization of the Me-FCVs characterized in chapter 2) and begins assembling elements of a technology- and market-development roadmap for Me- innovations that emphasizes the particular challenges of “getting started.” Section 4.2 describes a product plan that develops today’s combustion hybrids into a Me- product platform, one promising extension of which might be Me-FCVs. Section 4.3 describes Me- market-development, emphasizing product differentiation using discontinuous innovations, early market dynamics, and strategic niches. Several of the issues raised in this chapter are tied together and applied using an illustrative example in section 4.4, which also articulated the potential benefits aggregated, “parking-lot power plant” applications of V2G power (for which little analysis has been done). Even a detailed, comprehensive Me- roadmap may not point directly and comprehensively to a V2G H₂FCV future. Many unanticipated and unknowable factors will doubtlessly impact progress and change the destination, let alone the signposts along the way. Rather, the chapter tries to present a plausible development pathway that highlights important considerations and indicates how to proceed, or not, with Me- technologies at various decision points along the way.

5 Overall summary and directions for future work

Chapter 1 of this dissertation introduces the Me- framework in the context of the difficult problem of commercializing H₂FCVs and other EDVs. Chapter 2 addresses the question “What is Me-?”, chapter 3 “Who might be among the first to use and benefit from Me-?”, and chapter 4 “How might Me- happen?”. Each of the three major parts of this dissertation—the assessment of Me- technologies (particularly for plug-out applications), the analysis of markets pre-adapted to Me-, and the discussion of innovation and Me-product and business development—are pioneering in the sense that much hard work remains to settle the land and make it prosperous. The following overview of what has been accomplished (and therefore what has not yet been attempted) gives some indication of next steps, and is supplemented with additional thoughts about directions for future research.

More broadly, examining Mobile Electricity as one possible innovative driver for hydrogen-fuel-cell vehicle commercialization has highlighted new product and service opportunities and important relationships between H₂FCVs, plug-in hybrids, and broader energy systems, such as the electrical grid. Each of the parts of the dissertation is meant to lay important foundations for subsequent research into the commercialization of H₂FCVs and other Me- technologies, at UC Davis and elsewhere. Further, I also hope to have helped bridge the FCV Marketing Track of the UCD Hydrogen Pathways project with both 1) the technology-innovation and business-development expertise of the UCD Graduate School of Management and 2) other Pathways research, by providing analysis

that can be used to help guide effective demonstration projects, scenario formulations, and other related marketing and technology studies.

Contributions from each part of the research and additional thoughts for future work include the following:

Chapter 2: Me- assessment and V2G net revenue analysis

Chapter 2 integrates previously disparate technology analyses and industrial activities into a Me- framework. It describes opportunities to both “plug-in” (e.g., for home recharging) and “plug-out” (e.g., to supply power for tools/appliances/gadgets, emergencies, or electrical-grid-support services). The plug-in discussion presents an overview of previous analysis and activities and discusses critical issues related to the Me- framework as a whole (e.g., batteries and charging). The discussion of plug-out opportunities is more a discussion and new analysis of what *could* be going on in Me- development. To describe exporting electricity off-board the vehicle for non-motive purposes, “on the go,” “in need,” and “for a profit,” it illustrates Me- costs and benefits, Me- power vs. range trade-offs, vehicle and building incremental costs, and V2G net revenues for various electric-drive vehicles under various sets of assumptions. For example, a vehicle with capabilities similar to the EPA-certified 2006 Honda FCX might be able to provide 5–25 hours of residential emergency power while retaining roughly 50 miles of driving-range energy. Or, it might be able to sell 47kW-h of capacity and 47kWh of energy into spinning reserves markets at a net profit of almost \$400 per year. More capable H₂FCVs, and battery EVs selling regulation services, could earn \$1–2k per year

Compared to previous research (e.g., [17]), the electric-drive-vehicle and net-revenue models developed for chapter 2 have been adapted to better accommodate H₂FCVs and other “fueled” vehicles and to explore Me- power vs. range tradeoffs, infrastructure level-of-service, and other aspects of the Me- framework. The modeling discussed here uses somewhat more conservative input assumptions (e.g., more energy reserved for daily driving and less vehicle availability for vehicular distributed generation) but up-to-date H₂FCV specifications. Based on these specifications, the Me- production possibilities frontier (i.e., the capability of H₂FCVs to provide zero-emission driving and Me- power) appears to be large and expanding at a relatively rapid rate.

This initial analysis indicates that Mobile Electricity opportunities look to be an expensive yet promising factor in the difficult commercialization of clean vehicle technologies. The data and tools created are available for subsequent analyses, and initial findings have been accepted for publication.

The results of chapter 2’s assessment of Me- technologies and opportunities are largely concordant with previous studies, but highlight the particular importance of: vehicle recharging infrastructure limitations and uncertain capital costs; battery life; daily plugged-in availability; and aggregation of vehicular distributed generation.

Concordant with a desire to present results for existing, not speculative, vehicles, this study did not fully explore the capabilities on the relatively near horizon of vehicles such

as the FCX-V prototype, limited production and leasing of which has now been announced for 2008 [56]. The improvements embodied in such combustion-free vehicles offer even greater potential Me- benefits, such as V2G profitability (although at diminishing returns in cases where vehicle capability outstrip infrastructure capability/investment). Over time the prospects for Me- from various sources will undoubtedly shift and should be updated with new developments.

Research questions specific to future market/case-study selections should also play an important role in driving the development of Me- modeling enhancements and context-specific sensitivity analyses. For example, as needed to address specific research objectives, characterizations of battery cycle life, fuel-cell power production efficiencies, cooling requirements, and engine degradation as a function of scenario-specific load and use could be enhanced and their importance explored. In short, specific Me- applications and appropriate Me- system configurations should be characterized for each category of opportunity.

In particular, the costs of Me-, especially infrastructure, should be further studied and refined. Even if they appear prohibitive when considered as add-ons to conventional vehicles, they must also be weighed against a more sophisticated understanding of consumer willingness-to-pay for “green cars” and “new products and services” in the context of Me- innovation. This raises interesting questions about what constitutes technology- vs. market-optimal vehicle, refueling, and electric infrastructure design, and how the benefits of green vehicle technologies can be successfully realized. For example,

I hypothesize that all-electric range is a market-significant benefit, one in tension with plug-in configurations and control strategies using technically optimized “blended” driving modes that reduce the size and cost of the electric-drive components at the expense of reduced all-electric range [32]. This should be tested and market-meaningful thresholds for AER and other Me- benefits should be explored for their existence and magnitude.

Other questions to explore include: How much (what power level of) plug-out Me- is needed/desired/valued by various markets and applications? And thus what hybrid configurations and component sizes are required? Can dual-mode hybridization provide sufficient Me- benefits, or are there large strategic benefits to “fuller” hybridization approaches? On the other hand, what are the costs of large-battery/motor hybrids, and can overzealous efficiency optimization lead to market-unacceptable performance compromises akin to those thought to limit BEV acceptance? What affects the perception of home recharging as “getting to” vs. “having to” plug in? When will consumers not bother plugging in?

Chapter 3: early California household market analysis

Chapter 3 examined the early market potential for Mobile Energy in California households. Using relatively common-sense criteria to eliminate from consideration those households/consumers that would appear unable or otherwise unlikely to adopt and benefit from Mobile Energy innovation without significant effort or investment, filters

were applied to data from the 2000 Census. The remaining consumers, considered “pre-adapted’ to ME use represent a promising market segment. Major findings include:

1. Target segment estimation: Out of 34 millions Californians (26 million of driving age), 5 million appeared most readily able to adopt and benefit from ME innovation.
2. Sensitivity analysis: The results were surprisingly insensitive to any given constraint with a couple of exceptions, the most important of which is the building age of the residence (which was used as a blunt proxy for likely compliance with 1974 electrical codes). Making no restrictions based on residential construction date increased the size of the target segment to roughly 10 million Californians.
3. Statistical differences: Mean values of all Census variables explored for the target segment were found to be statistically significantly different than the whole population, though mean values often fell within one standard deviation of the California population mean. Me-enabled households tended to have higher incomes, longer commutes, and higher education attainment, and the residences they live in tended to be larger, occupied longer, and heated in more cases by utility gas. Both mean-value and distributional differences have been illustrated in chapter 3 as well as in conference presentations and publications.
4. Discussion: Interesting tensions arise between technical and marketing optimal design when considering the complex yet critical relationship between ME power, home refueling, and vehicle design options such as vehicle range. Two issues have been highlighted: 1) vehicle range/hydrogen storage and 2) home refueling. 1: Commute data indicates even current H₂FCV prototypes likely meet the daily needs of most Californians. However, needs are different than perceived needs or wants. 2: When

the additional requirement of natural-gas availability was added, the target market segment consisted of 4 million Californians living in roughly 1.5 million households and representing a theoretical (though not immutable) maximum vehicle sales pool of 400,000 vehicles per year, not accounting for tastes or purchasing behavior. The initial market share of ME vehicles in this pool might be one or two orders of magnitude smaller.

The subset of pre-adapted California households identified in this part of the research represents a more efficient research population for subsequent exploration by marketing researchers (e.g., using interactive stated-preference methods [65, 66] or a more traditional focus-group/survey sequence [67]). The differences characterized between this target market and the household market as a whole—including the overall size of the market potential identified—help inform policymakers and managers wishing to support effective ME technology commercialization.

The constraints applied in chapter 3 to find the market segment pre-adapted to ME innovations were largely common-sensical, and could be relatively easily applied to other regions. However, some theoretical constraints were embodied with blunt proxies in the Census data and could be improved and refined, for example by association with other variables in the data, by coordination with other data sets, with the use of other data sets (e.g., CALTRANS, DMV, NHTS), or by other methods. Specifically, the actual relationship between building age and electrical facilities needs to be explored. More to

the point, the distribution of electrical facilities in the housing stock and the costs of upgrades to various levels of Me- infrastructure should be better understood.

Future work further amalgamating the analysis from chapter 3 with the analysis in chapter 2 would allow a subtler, less averaged exploration of who is Me- capable and how they might specifically benefit. Target market demographics can be used to increase Me- modeling sophistication by helping to determine and characterize important model inputs such as vehicle availability (hours per day and daily driving, which varies significantly by, e.g., employment status, gender, and age), vehicle type (energy storage and conversion), and housing characteristics (likely required infrastructure investments and emergency power needs). This would help guard against designing for a too-broadly-defined representative agent (consider past failures of vehicles designed for global markets that were unable to gain a foothold in any market in particular).

Conversely, further characterizing specific Me- applications, as suggested to extend the assessments in chapter 2, could allow exploration of more narrowly defined target markets and/or niches. This would facilitate, for example, more meaningful exploration of important factors—e.g., household income: What is percentage of the target group that is above the population median?, etc.—and allow the results to be more meaningfully related to important implications—e.g., vehicle sales. Preferably, these applications would also qualify as supportive niches in the sense described in the discussion of market development, allowing more narrowly defined value propositions to be developed and used in strategic disruptive-product marketing campaigns

Chapter 4: Discussion of innovation and Me- product and market development

Chapter 4 applies an innovation lens to the problem of commercializing H₂FCVs, other EDVs, and other Me- technologies. One of the goals of chapter 4 is to take one possible future state (e.g., widespread commercialization of the Me-capable H₂FCVs characterized in chapter 2) and begin assembling elements of a technology- and market-development roadmap for Me- innovations that emphasizes the particular challenges of “getting started.” It discusses the characteristics of innovations that are more likely to have rapid and wide impact, thereby arguing for the important role of combustion hybrids as Me-market creators. It describes the development of today’s combustion hybrids into a Me-platform and repositions H₂FCVs, when they are ready, as one possible gold standard for providing clean, high-power, and potentially higher profit Me- services into markets created by early Me- market pioneers. The chapter also discusses Me- market-development, emphasizing product differentiation using discontinuous innovations, early market dynamics, and strategic niches.

Chapter 4 encourages the discourse about electric-drive commercialization to focus on the details of specific product designs, which are critically important to consumer adoption and the successful formation of a supportive industrial community [33]. An example of an aggregated V2G application (airport rental cars in a parking-lot power plant) is used for illustration. Even its weaknesses—for example, the difficult coordination required between a host of participants—is instructive. Similarly, a Me-roadmap may not point directly and comprehensively to a V2G H₂FCV future. Many

unanticipated and unknowable factors will doubtlessly impact progress and change the destination, let alone the signposts along the way. Rather, the discussion tries to present elements of a plausible development pathway that highlights important considerations and indicates how to proceed, or not, at various decision points along the way.

Chapter 4 discusses several strategic considerations for improving the likelihood, rate and extent of Me- commercialization, but each could be developed much more extensively—preferably in specific Me- design contexts—and others sought using technology-, product, business-, and market-development lenses. For example, the coordination between multiple actors in multiple industries necessary to allow Me- vehicles to supply V2G grid-support systems could be examined in the context of system-wide innovations, or the role of intellectual property, complimentary assets [68], development clusters, or other technology-management factors could be explored in the context of Me-.

Chapter 4's unified view of Mobile Energy platform development creates new consumer-behavior and infrastructure opportunities (e.g., recharge at home, refuel abroad, or vice versa) that could be researched with consumer simulations and demonstrations.

Lastly, a Me-I product platform could be assessed and a product-development plan created. What would be the interface requirements for home vs. aggregated applications? For pre-V2G (customer-side-of-the-meter) vs. V2G-capable (utility-side-of-the-meter) units?

Collectively, the discrete-but-linked parts of the dissertation research explore what Me-innovation is, who might be the first to benefit from it, and how decision-makers might better support Me- development—ideally illustrating how H₂FCVs, plug-in hybrids, and other Me- technologies might succeed where previous AFV efforts failed in this regard.

Epilogue

Many questions remain about Me- technologies and opportunities and their potential to drive the commercialization of H₂FC and other electric-drive vehicles. As the preceding chapter-by-chapter summary and discussion indicates, future work that uses one of the distinct-but-linked areas of the dissertation research to inform the next iteration of another appears particularly fruitful. If the parts of this dissertation individually demonstrate aspects of the promise of Me- technologies, their integration will help characterize the implications of Me- commercialization and test the robustness of Me-value—particularly as increasingly specific context selection allows the strategic concepts discussed here to be adapted and developed into more effective business-development plans and tactics. For example, what if all of the vehicles in the target market segment identified in chapter 3 were Me-FCVs as described in chapter 2? Table 5-1 characterizes such a vehicle population using the 1-hour Me-power characteristics of the FCX2006 model.

Table 5-1. The 1-hour Me-power potential (chp 2) of the Me-enabled population (chp 3)

Population	2000 size (M)*	Portion of 2000 CA total (%)	Estimated number of passenger vehicles (M)**	Total available 1-hour zero-emission power capacity @ 47.4kW/veh (GW-h)***	Total available 1-hour zero-emission power capacity @ 9.6kW/veh (GW-h)***
Home-reformation-enabled	4	12%	4	85	17
Me-enabled	5	15%	5	113	23
Licensed drivers	~21	62%	~19	413	84
Driving-age	26	76%	~19	413	84

*21M CA licenses in 2000 (U.S. Bureau of Transp. Stats); others calculated in chapter 3

**Roughly 1 vehicle per person expected for target segments (chapter 3); fees paid for 19.1M passenger vehicles (private and fleet) registered in CA in 2000 (CA DMV)

***"available" = adjusted to account for average plug-in time of 12h/d 11mo/y; 47.4kW/2006FCX reserves fuel for 52mi of driving per refueling (chapter 2)

At full, red-line capability (47kW/vehicle), the year-2000 Me-enabled population would represent over a hundred available gigawatts of 1-hour, zero-emission Me- power capacity, over twice the peak load in California. At a level more reflective of early “plug-out” infrastructure investment (9.6kW), the population would represent a proportionately lower available 1-hour capacity, or 23GW on average.

Table 5-1’s integration of results from chapters 2 and 3 illustrates that the overall generating capacity of a Me-enabled and –equipped population in California is quite large; it would undoubtedly alter the electrical landscape were it to come to pass.

Working backwards from that ultimate potential into increasingly specific contexts, the next question might be, “How many of those vehicles would be required to meet a given market need?” Table 5-2 explores the needs of four illustrative V2G markets: spinning reserves requirements (which due to their variability are characterized at both typical and

high levels), total California operating reserve requirements, and a portion of total California peak electrical load.

Table 5-2. California V2G market saturation

Market*	# of 47.4kW vehicles needed (k)	Potential net revenues [spin@\$381/veh, peak@\$385/veh] (\$M/y)	# of 9.6kW vehicles needed (k)	Potential net revenues [spin@\$51/veh, peak@\$271/veh] (\$M/y)
700MW "steady" spin. reserves demand	32	\$12	159	\$8
2500MW high spinning reserves demand	115	\$44	568	\$29
CA total operating reserves (~4GW)	184	\$70	909	\$46
1/5th of CA 54GW peak load	497	\$191	2,455	\$665

*Spinning, peak markets characterized in [9]; 4GW = 3GW (2006 CAISO operating reserves requirement) / 75% (the portion of CA in the CAISO area of control)

To meet these market needs, several hundreds of thousands to millions of Me- vehicles would be required. Table 5-2 also uses the relevant net revenues results from chapter 2 to give a rough indication of the annual profits that might accrue at market-saturation levels of Me- vehicle use. However, this assumes the average cost and revenue structures sketched out in chapter 2 are precise and remain constant as V2G supply expands, which is not expected to be the case. Indeed the very structure of the markets themselves might be unrecognizable at such “game changing” levels of Me-/V2G commercialization.

Working backwards from the saturation of a given market, Table 5-3 makes the analytical

context even more specific and commercialization-relevant by beginning to highlight the dynamics of early Me- vehicle sales.

Table 5-3. Me- vehicle sales

Population (2000)	Max vehicle sales pool (k/y)*	1%-of-max sales (k/y)	Total available 1-hour zero-emission power capacity @ 9.6kW /veh (MW-h/y)**	Years before saturation of 700MW market at constant 1%-of-max sales per year	Years before saturation of 700MW market if initial 1%-of-max sales grow by 10% per year
Home-reformation-enabled	450	4.5	20	35	16 (at which time sales = 19k/y or 4% of max/y)
Me-enabled	600	6	26	27	14 (at which time sales = 21k/y or 3% of max/y)
Driving-age	~1,500	15	66	11	8 (at which time sales = 29k/y or 2% of max/y)

*Assumes vehicles kept 8–9 years (expected for target segments, chapter 3), then buy new Me-FCV (i.e., overstated); CA new-car sales (currently?) \approx 1.5M/y (ucsusa.org)

**"available" = adjusted to account for average plug-in time of 12h/d 11mo/y (chapter 2)

As described in chapter 3, the target segments examined are expected to buy on the order of 0.4–0.6 millions vehicles per year. Assuming modest initial Me- market share, sales growth, and plug-out infrastructure investment, it might take a dozen or more years to saturate the “steady” demand for spinning reserves in California.

An increasing understanding of possible market dynamics could, in turn, be compared to and provide context for the development of dynamic Me- models (e.g., using cost as a

function of time/volume), enhancing the analysis from chapter 2. These models could, in turn, could be enhanced by incorporating chapter 4's consideration of innovation and initial steps (e.g., aggregating V2G capacity into utility-friendly MW-scale parking-lot power plants) and used to evaluate various V2G, emergency-power and other business strategies and pathways. And so forth...

Together, tables 5-1 through 5-3 and their discussion illustrate an integrative and iterative trajectory of increasing specificity and near-term pertinence that can be followed in future investigations—pointing the way towards a fuller understanding of the implications of Me- technologies and the robustness of their value.

“I have yet to see any problem, however complicated, which, when you looked at it in the right way, did not become still more complicated.” -- Poul Anderson

6 Acknowledgements

Thanks are due to the University of California Transportation Center and the U.S. DOE GATE program for its support of this work and Toyota Motor Sales, Inc. of North America for its broad support of research activities at the UC Davis Institute of Transportation Studies. Thanks are also due to Professors Joan Ogden, Dan Sperling, and Andy Hargadon and to Dr. Tom Turrentine for their inspiration, education, and advisement. Particular thanks are due to Dr. Kenneth Kurani, my primary source of day-to-day engagement, support, and stimulation; my patient handler through doldrums and flurries alike; and my chief collaborator on much of this dissertation work. His penetrating precision of thought is much appreciated and has improved this dissertation tremendously.

7 Appendices

7.1 *Me- technologies and opportunities (further detail)*

7.1.1 *Illustrative PHEV incremental costs*

Assuming, as argued by the HEVWG [13], that NiMH batteries can now be reasonably expected to have ten-year, 150,000-mile lifecycle characteristics sufficient for the frequent and relatively deep-discharge requirements of PHEV20s⁴⁰, Table 7-1 illustrates the battery prices necessary for SUV hybrids to achieve lifecycle cost parity with conventional SUVs. The battery prices required are significantly above what the authors believe can be achieved in high-volume manufacture.

⁴⁰ The study admits (p. 2-3), “confirmation of extensive deep cycling capabilities must still be sought...”. However, on a related note, the 16 January 2006 edition of *Fleets and Fuels* newsletter notes that all 220 of utility SoCal Edison’s Toyota RAV4-EV battery SUVs are still operating on their original NiMH batteries.

Table 7-1. Incremental costs of PHEV20s (adapted from [13], Table A-7)

	SUV (e.g., 2003 Chevy Suburban 1500LS 4WD with 5.3L V8)	Hybrid-electric SUV	Plug-in hybrid-electric SUV (a)	Plug-in hybrid-electric SUV (b)
Hybrid battery size (kWh)		5.2	9.3	11
Hybrid battery module cost per kWh required for lifecycle cost parity with SUV		\$419	\$427	\$455
Hybrid battery module cost		\$2,180	\$3,970	\$5,000
Total battery system price	\$60	\$4,150	\$6,070	\$7,140
Other incremental vehicle price changes (c)		\$480	\$710	\$710
Total incremental vehicle price	\$60	\$4,630	\$6,780	\$7,850
Fuel expenses @ \$1.75/gal	\$10,950	\$7,220	\$5,610	\$4,980
Maintenance expenses	\$7,110	\$6,370	\$5,800	\$5,370
Battery salvage		-\$100	-\$70	-\$80
“Total” lifecycle costs	\$18,120	\$18,120	\$18,120	\$18,120

(a) = 2000 cycle, 80% depth-of-discharge

(b) = 3000 cycle, 70% depth-of-discharge

Uses cost-based pricing method developed at Argonne National Laboratory to *include* typical electric-drive-supplier, OEM, and dealer markups, etc. in prices (note: some markups are typically large for SUVs; cost increments are correspondingly smaller than the price increments shown here)

(c) net impact relative to conventional SUV of: \$690 on-vehicle charging system (for plug-in hybrid), electric motor (for all hybrids), and trade-offs with engine, exhaust, transmission, and accessory-power requirements

“Total” = NPV(incremental vehicle price + fuel and maintenance expense – battery salvage value) over 10-year/150,000-mile life

The fuel and maintenance savings described in Table 7-1 are derived from calculations that do not include repair costs (for any vehicle type, whether conventional or hybrid) or possible variations in maintenance requirements due to differing vehicle mass (e.g., tire replacement might be expected to vary). The savings calculations are based on the

following important assumptions: gasoline at \$1.75/gallon, \$0.05/kWh offpeak electricity for vehicle charging, and regular night-time charging by the consumer to maximize the use of electric fuel and drive systems.

7.1.2 Battery leasing

The potential benefits of battery leasing deserve further discussion, even beyond that explicitly detailed in the HEVWG described here. As noted by those authors, leasing batteries to electric-drive-vehicle (EDV) owners hides most of the upfront cost differential of plug-in hybrids. Indeed, “[i]n Europe [battery renting] has significantly increased the sales of battery EVs,” (Pifaretti in [13], p. 4-21).

By disguising capital costs as lifecycle costs, battery leasing allows EDVs to compete on a favorable basis, shifting the terms of the business case from upfront to lifecycle costs, where PHEVs are hoped to be competitive (see Table 7-1). But it has additional benefits not explicitly described in the report: it would give battery manufacturers a profit-margin incentive to make longer-lasting, recyclable batteries and drivers an incentive to use the zero-emission all-electric range.

7.1.3 PHEV prototypes

Several prototypes have demonstrated one or more aspects of plug-in hybrid platform potential. Table 7-2 illustrates the key features of six, including several Prius conversions in various stages of commercialization.

Table 7-2. Plug-in-hybrid-prototype specs/claims

	UCD Sequoia FutureTruck prototype	Dodge Sprinter plug-in hybrid prototype	EDrive Prius conversion	Prius+ NiMH conversion prototype ("silver bullet")	Hymotion L5 conversion kit	Hybrids- Plus conversion	
Primary organization(s)	UC Davis	Daimler-Chrysler	EDrive (marketing) Energy CS (development)) Clean-Tech (LA install)	CalCars, Electro Energy (EEEE)	Hymotion	Hybrids-Plus/ Energy Sense	
Status	2000 U.S. DOE FutureTruck student competition entry prototype (1 of 7 PHEV prototypes)	3 prototypes in U.S. as of Oct. '06; 30+ to be tested worldwide (18 in U.S.)	announced will do commercial conversion beginning 2006	single prototype conversion	Claim: now for authorized gov't and fleet install; for consumer use in Fall '06. Delivered 1 st conversion to external customer AR Sep. '06	Doing conversion; delivered one Sep. '06; one conversion will be given V2G capability for study with NREL.	
Vehicle platform	2000 Chevy Suburban	Sprinter 311 CDI automatic	2004+ Prius	2004+ Prius	2004+ Prius	2004+ Prius	
	Occupants/ cargo	8/400L	15	5/14.4ft [^] 3	5/14.4ft [^] 3	5/14.4ft [^] 3	5/14.4ft [^] 3
	ICE vehicle curb mass (kg)	2324 (2000 Suburban)	2000 (Sprinter 311 CDI)	1311 (2006 Prius)	1311 (2006 Prius)	1311 (2006 Prius)	1311 (2006 Prius)
incremental vehicle mass (kg)	463 (2786 - assumed curb mass)	w/NiMH	350	90-180			

					113.4 - original battery, (>68)	75	70	
	w/Li	160						
ICE	type	4-cyl, in-line Saturn	4-cyl diesel	4-cyl DOHC	4-cyl DOHC	4-cyl DOHC	4-cyl DOHC	
	output (kW)	92	80	57@5krpm	57@5krpm	57@5krpm	57@5krpm	
	fuel type	gasoline	diesel	gasoline	gasoline	gasoline	gasoline	
	fuel capacity (gal)	15	26.4	11.9	11.9	11.9	11.9	
electric motor(s)	max output (kW)	75	70	50kW@1200-1540rpm	50kW@1200-1540rpm	50kW@1200-1540rpm	50kW@1200-1540rpm	
	continuous/Me- kW	31	40					
	type	UQM SR218 PM brushless DC		PM synchron AC	PM synchron AC	PM synchron AC	PM synchron AC	
	efficiency	95%	94%					
propulsion battery	type	Ovonic NiMH	Soft Li-Ion	Valence LiIon	EEEE Bipolar NiMH	LiIon Polymer	A123 LiIon, same as DeWalt 36V	
	capacity (kWh)	29.6	14.4	9	7.3	5	~0.5 gal gasoline	
	DOD allowed		~1?	0.71				
	power (kW)	30 (90 A-hr, 336V)			21	21	21	21
	mass (kg)	<463	<350 NiMH, < 160 Li	68	132-191	<72.5	<70	
	life	100,000 mi		5-10+ yr				
packaging				replaces Prius battery, fits under the rear cargo carpet	replaces Prius battery	supplements Prius battery	replaces Prius battery	
	range	all-electric (mi)	70	20	30-35 @<34mph	20-25	30 @<34mph	30 @<34mph
		PHEV range after full recharge (mi)			50	40-50 of mixed driving	50, conservative driving	

	vehicle range/gasoline fill (km)	1600+					
	hwy/city	420/300					
charger	type	Delco/Hughes inductive MagneC charge 5.0 conductive conductive Brusa charger conductive conductive					
	Volts, Amps	120V (can also take 240, but still 1kW) 208-220V 230V (Euro) 120V, 15A 120V/240V, 15A 115V @ 15A					
	kW	6.6 1 1.35					
	time (h) from empty	6 6 9 6 5.5/4 8h, elsewhere: 9h from 80% DOD					
fuel economy	claimed mpg	18.7 Future Truck test, ~25 unqual. up to double 100+ for PHEV range, Prius-like after 90 mpg for PHEV range 100 "city/hwy" for ? mi 100 for PHEV range					
	improvement (based on claims)	1.2-1.7x ~2x ~1.7-2.2x ~1.5-2x ~1.7-2.2x ~1.7-2.2x					
Price	\$9,500 target (+Prius) for orders >100 \$32,500 (+Prius), \$15k by mid '07						

7.1.4 Vehicle-to-grid calculation detail: A supplement to section 2.3.4.3

7.1.4.1 Key to color coding

red font=reserves 52 mi for driving (BEVs and FCVs)

pink font=assumes half of daily driving already done with zero emissions (=reserves 16 mi; PHEVs)

gold font=to check (uncertain or questionable value or assumption)

 = 1h dispatch may limit driving

 = externally constrained (e.g., by size of vehicle's electric motor)

 = spinning reserves results

 = regulation results

 = peak power results

7.1.4.2 V2G Equations

The following equations are adapted from [69] (also referenced as K&T05a).

COSTS (c) in \$ (per year) for Table 2-9

$c = (\text{cost/unit energy}) * (\text{energy dispatched}) + \text{annualized capital cost}$

Cost/unit energy (cgen) in \$/kWh generated

$c_{gen} = (\text{cost of fuel}) / (\text{efficiency of fuel-to-AC-electricity conversion}) + \text{cost of degradation}$
for input values, see section 7.1.4.3

Cost of degradation (cd) in \$/kWh generated

$cd = (\text{cost of engine, } c_{eng}) / (\text{lifetime hours, } L_h)$

Annualized capital costs (cac) in \$/y

$cac = (\text{cost of capital, } cc) * (\text{capital recovery factor, } CRF)$

Capital recovery factor (CRF)

$CRF = d / (1 - (1 + d)^{-n})$, where d = discount rate, n = number of years

Energy dispatched (Edisp) in kWh

see energy sales, below

REVENUES (r) in \$ (per year)

$r = \text{capacity payment} + \text{energy sales}$

Capacity payment (\$) = $pcap * P * tPLUG$

$pcap$ = capacity price (\$/kW-h, Table 2-10), P = power (kW, Table 2-3), $tPLUG$ = time plugged in and available (h, Table 2-6)

Energy sales (\$) = $pel * E_{disp}$

pel = electricity price (\$/kWh, Table 2-10), E_{disp} = energy dispatched (kWh) $\approx P * (\text{dispatch time, } h/y, \text{ Table 2-6})$

NET REVENUES (NETrev) in \$ (per year) for Tables 2-10, 2-11

$NETrev = r - c$

7.1.4.3 Cost per unit energy (cgen) inputs for Table 2-5

Vehicle type	Fuel	\$ / unit	\$/ kWh of Fuel	kWhAC / kWhFUEL	ceng (\$/kW)	Lh	cd (\$/kWh)
<i>Fuel-cell</i>							
P2000 (K&T05a) FCX/FCX-V /PFCX	hydrogen (\$/kg) high	\$5.6	\$0.17	0.41	\$75	30000	\$0.0025
	hydrogen (\$/kg) low	\$1.7	\$0.05	0.41	\$75	30000	\$0.0025
	hydrogen (\$/kg)	\$4	\$0.12	0.50	\$100	10000	\$0.0100
<i>Battery</i>							
edrive/PFCX	electricity (\$/kWh)	\$0.1143	\$0.1143	0.74	\$3,450	25560	\$0.1350
	electricity (\$/kWh)	\$0.1143	\$0.1143	0.74	\$9,890	13152	\$0.0752
RAV4EV	electricity (\$/kWh)	\$0.1	\$0.10	0.73	\$9,890	0	\$0.0752
RAV4EV (K&T05a)	electricity (\$/kWh)	\$0.1	\$0.10	0.73	\$9,890	0	\$0.0752

$$C_{gen} (\$/kWh) = (\$/kWh_{FUEL}) / (kWh_{AC} / kWh_{FUEL}) + cd$$

7.2 Me- product and market development (further detail)

7.2.1 The normal distribution

The following provides more detail on the normal distribution, as introduced in section 4.3.3's discussion of the technology adoption lifecycle.

The normal distribution is a statistical model used to characterize a wide variety of naturally occurring phenomena, and is typically described using two parameters: a mean value and a variance. On average, the expected value of the phenomena being characterized is the mean value. To use a more typically natural-science example, the expected value of the measured height of a certain population of plants may be, say, 1 m. However, various factors—such as differential soil-nutrient and sunlight levels—will

lead to variations in plant height over a population of plants grown under even tightly controlled circumstances. Plotted on a graph with plant height on the x axis and number of plants (out of, say, 100) of that height on the y axis, one would expect most plants to be grouped around the mean value of 1 m in height, with fewer and fewer plants being recorded at heights far from the mean. Assuming there was not systematic reason for these unobserved causes of variation in plant height (e.g., all got slightly more nutrients than the experimenters thought), one would also expect the pattern of decreasing number of plants to be symmetrical around the mean. The resulting graph of number of plants vs. plant height would therefore assume the classic “bell shape.”

The normal distribution has been found to be particularly useful in describing phenomena with a central tendency toward a mean value whose variations from that mean are caused by a large number of unknown factors that contribute in essentially random ways (i.e., differences from the mean of random direction and magnitude). The more unknown factors of this type, the more appropriate the normal distribution is as a descriptive model.

7.3 Literature review and preliminary theory development

7.3.1 Section introduction and overview

As described previously in chapter 1, the literature describes past alternative-fuel vehicle (AFV) commercialization efforts as largely unsuccessful and/or not sustained over periods of low oil prices (e.g., [7, 8]). While the potential of hydrogen-fuel-cell vehicles (H₂FCVs) to provide various benefits (e.g., reduced emissions) has been described widely

and in detail [1-6, 28, 39, 40], it is often considered difficult to justify the private investment necessary to achieve these primarily social benefits. Currently expensive, of limited performance, and lacking a refueling infrastructure, H₂FCVs face similar challenges faced by past AFV efforts. In absence of a compelling value proposition, past experience warns us that their successful commercialization remains in doubt.

This literature review provides context for this dissertation's examination of Mobile Electricity (Me-) as one possible source of commercialization-driving innovative value. It is grouped into three major sections: Lessons from previous alternatively-fueled-vehicle research (section 7.3.2), Lessons from technological innovation and marketing theory (section 7.3.3), and Vehicle-to-grid opportunities (section 7.3.4). Section 7.3.2 describes past AFV efforts and analysis, thereby providing the overall context for the dissertation and laying the theoretical foundations for this analysis of H₂FCV commercialization. For example, many lessons from that section are summarized and applied in chapter 3's investigation of early consumers pre-adapted to H₂FCV and other electric-drive-vehicle use, i.e., of who might be among the first to adopt and benefit from Me-. The literature discussed in section 7.3.3 is used in chapter 4 to enhance the AFV-specific context and theoretical foundations from section 7.3.2 with lessons from innovation and marketing theory. Section 7.3.3 and chapter 4 thus speak to how Me- innovation might best happen. Section 7.3.4 describes the body of literature surrounding a specific subset of Me- technologies and opportunities, so-called vehicle-to-grid (V2G) power. Chapter 2 places vehicular distributed generation into an overall framework that describes what Me- is, and presents the results of this dissertation's efforts to model Me-, including vehicle-to-

grid-power net revenues. A final section, 7.3.5, offers some summarization of the how the main body of dissertation research builds on the literature reviewed here.

7.3.2 *Lessons from previous alternatively-fueled-vehicle research*

Sperling, D. (1988). *New Transportation Fuels: a strategic approach to technological change*. Berkeley, University of California Press. [7]

In addition to an analysis of existing and alternative fuel production, distribution, and end-use issues, *New Transportation Fuels* presents a detailed examination of the major alternative-fuel-vehicle (AFV) efforts worldwide at that time. This examination reveals the difficulties of creating, and the fragility of nurturing, an AFV industry that persist to this day. From relative “failures” (e.g., syn fuels in the U.S.) to relative “successes” (e.g., ethanol in Brazil; natural gas in New Zealand at the time), few of the efforts enjoyed more than modest results—in terms of AFV penetration rates or alternative-fuel use—and all were fragile gains. Even the case with arguably the strongest and most prolonged support (ethanol in the context of a centrally-controlled fuel industry in Brazil) suffered major setbacks from faltering commitment as the bottom dropped out of world oil prices. As Sperling points out, none of the major petroleum price changes (up or down) was widely expected or predicted, but the wilting effect of falling prices was devastating to political commitment.

Imperial College researchers echo this theme in their discussion of renewable energy commercialization, another case of as-yet-unrealized technological promise:

“Expectations as to the continuity or durability of a policy are exceedingly important,”

[8]. The cases in *New Transportation Fuels* illustrate that, in absence of policy perseverance to overcome the high degree of uncertainty associated with AFV commercialization, consumer demand is nothing short of fickle. The importance of overcoming this, according to Sperling, “cannot be overstated,” (Sperling 1988, p. 383).

Another important set of issues described in *New Transportation Fuels* centers around the contextual basis of prices and costs. While prices are important signals in mature, functioning markets, their role as barrier to innovation provides the backdrop for Sperling’s discussion of the social and contextual basis of prices. The book argues that too little attention has been given to the complex relationship between “the deployment of technology and the structure of society” (ibid, p. 473) “The transportation and energy systems we create are artificial systems whose designs respond to their social, political, economic, and physical settings,” (ibid). As we change those settings, and new relationships form, transportation and energy systems that may not have previously been viewed as attractive may become so. Perhaps, however, I might argue that the contextual advantage given to prices related to status quo technologies over new technologies—whose current prices are less representational of true costs in a changed future—is reflective of the difficulties of overcoming past choices.

Nevertheless, as prices are context-specific and socially influenced, analyses based on past choices, and predictions based on current prices, must be considered with caution. Even at a more mundane, less fundamental level, caution is advised by Sperling’s presentation of evidence of a systematic bias in cost estimates that have been observed in

the commercialization process: pre-commercialization costs are generally underestimated (presumably by optimistic advocates of new technologies) and increase with time; post-commercialization costs are generally overestimated (by those faced with the realities of implementation) and decrease with time. With such examples, Sperling enhances the complexity of how we view, and the sophistication with which we interpret (not simply accept), cost and price analyses.

A final theme of *New Transportation Fuels* relates to AFV marketing. Sperling highlights several ways in which the transportation question differs from other industries, with important consequences for the best overall approach to innovation in this industry. For example, confounding the *Soft Energy Paths* approach developed by Amory Lovins for the United States' major energy problems in general and the electricity industry in particular [70], Sperling highlights factors, such as pipeline economies, that act to countervail the forces in favor of modularization and localization in the *Soft Path* approach. Additionally, unlike for many other technological endeavors, the book argues that transportation fuels have less opportunity for differentiation and market segmentation: "The homogeneity of the motor vehicle fuels market discourages and incremental, market niche approach," (Sperling 1988, p. 310). Accordingly, the mass market for privately owned vehicles is the true golden apple: "fleet vehicles represent an important, but not major, early market for alternative fuels" (ibid, p. 290). With less opportunity to segment based on end-use market, Sperling argues that a spatial segmentation approach is the superior strategy for new transportation fuels, citing

California, with its relative geographic isolation, large overall market size, and history of political leadership and support, as a promising example.

Turrentine, T., D. Sperling, et al. (1991). “Market potential of electric and natural gas vehicles” report for year one. Davis, Calif., Institute of Transportation Studies, University of California Davis. [44]

[For a discussion of appendix D of this report, please see the review of that analysis’ subsequent publication in final form as [34], below.]

In June 1991, the Institute of Transportation Studies at the University of California at Davis (ITS-UCDavis) held the first public test drive of AFVs, at the Rose Bowl in Pasadena, California. In this report Turrentine, Sperling, and Kurani describe the reaction of 236 participants who drove a battery EV, a methanol vehicle, and a CNG vehicle. The participants were selected using the constraints criteria developed by Nesbitt, Kurani et al. (1992) to identify likely early buyers of AFVs. The participants completed a three-part questionnaire before, during (in interview format), and after the test drive.

In general, respondents’:

- opinions of AFVs improved after the test drive (e.g., 61% said their opinion of EVs improved, 16% said it worsened);
- opinions of vehicle attributes⁴¹ exceeded expectations;

⁴¹ Specifically, “search attributes,” are those vehicle attributes “which can be readily evaluated by inspecting and driving a vehicle,” in contrast to “experience attributes”

- first choice of vehicle was split between methanol (which tended to be chosen by participants who owned fewer, larger cars, who saw EVs as compromised, and who were older and more economically minded) and the battery EV (chosen by those more likely to be small-car owners, have more vehicles per household, see their choice as a moral issue, and value potential benefits like reduced maintenance); and
- respondents' second choice was predominately the CNG vehicle.

The authors explain the last point as due to participant perception of the CNG vehicle as the next-best choice, either in terms of environmental performance (for the battery EV choosers) or practicality (for the methanol choosers).

It is also worth noting the authors reported the answers given about CNG vehicles were inconsistent: "CNG choosers emerge as more of a mystery," (p. 23). However, this is perhaps not surprising as the authors also noted that markedly fewer drivers were aware of CNG vehicles than either battery-EVs or methanol vehicles before the test. This raises the question of how much participants' evaluations (or those of consumers in general) of less familiar AFVs is a function of, or compromised by, that unfamiliarity. Even in the "more substantive" consumer-educational format argued for and used by the authors (relative to more traditional stated-preference-survey or other econometric techniques), considerable confusion and lack of awareness is evident. See [52] for a detailed exposition of these issues.

Additionally, evidence that choice of drivetrain technology is confounded with preference for vehicle type was strong: "More than any other search attribute, car size immediately affected the response of participants," (p. 25). This presents an interesting

which can only be fully evaluated after the vehicle purchase (Turrentine, Sperling et al.

dilemma when trying to interpret consumer reactions to a new technology that could be packaged in many different ways, but whose initial offerings are limited: "These decision processes produce contrasting results for consumers; the car with the greatest personal utility may not fit their moral choice or the choice they think will be successful," (p. 24). More broadly, an intuitive but important conclusion is that consumers interact with, and make choices based on, the very specific design details into which new technologies are packaged and presented to them. This distinction between the potential of a new technology (which could be quite broad and promising) and its successful implementation via specific designs, is an important part of the "robust design" aspect of the innovation theory [33] discussed chapter 4.

Kurani, K. S. (1992). *Application of a Behavioral Market Segmentation Theory to New Transportation Fuels in New Zealand*. PhD Dissertation in Civil & Environmental Engineering, Davis CA, University of California at Davis: 208. [52]

Kurani's 1992 PhD dissertation provides an historical context of energy and transportation policy in New Zealand in the late 20th century, critiques the applicability of rational-choice frameworks for evaluating new vehicle technologies, extends an alternative, synthetic framework, and discusses data collected about New Zealand's experience with natural-gas vehicles in the context of that alternative framework.

1991, p. 3). For more information, see also the review of (Turrentine and Sperling 1991).

As a starting point for examining New Zealand's use of compressed-natural-gas (CNG) and liquefied-petroleum-gas (LPG), Kurani scrutinizes the traditional tools of consumer-choice theory, such as discrete choice analysis. In a detailed examination of their applicability, however, several shortcomings and violations of the fundamental assumptions of utility theory are described. As mentioned in the review above [44], significant doubt is cast as to what simple stated preference surveys (the tool used to supply data to econometric models like discrete choice when revealed behavior is not available) are measuring: consistent, coherent, and informed consumer preferences or uncertainty, confusion, and/or lack of awareness. A particularly acute problem in situations where consumers are asked to evaluate products that do not exist, with which they have no experience, and for which they therefore have no basis of evaluation, Kurani argues a more detailed, educational, and interactive approach is warranted for discussions of new vehicle technologies. Further, Kurani examines the mathematical basis of discrete-choice model construction, and finds several important assumptions to be violated in the case of AFV choice models, including the irrelevance of independent alternatives (IIA) assumption and the stability, consistency, and transitivity of preferences as required for utility maximization to be meaningful. Rather, it is argued, consumer preferences for new vehicle technologies are far from stable, often inconsistent in early stages of awareness, and dramatically dynamic as more experience and education is gained about the alternatives.

For these reasons, Kurani adopts a more dynamic and synthetic framework described in the next section [58]. Briefly, that framework synthesizes psychological factors into

rational choice, for example by portraying consumer decision making “as a series of steps through which all consumers pass,” not a simultaneous evaluation of the utility-maximizing choice, (Kurani 1992, p. 1). Further, it “segments the market for new fuels into innovators, moral/social choosers, and utility maximizers,” (ibid). The former two groups are posited as early adopters of new vehicle technologies that influence the latter group, which will tend to choose AFVs only once mature markets for AFVs are functioning.

Kurani then tests (post hoc), and finds evidence to support, several specific hypotheses related to this model of consumer choice for the New Zealand case, including:

- “consumers use simple cost measures such as fuel price and payback period instead of more sophisticated "rational" cost measures;
- vehicle maintenance attributes are important determinants of satisfaction with, and commitment to, the new fuel and vehicle; and
- there exists an extended period of trial ownership in which the most important assessments are made regarding the vehicle,” (ibid, bulleting added)

However, the New Zealand survey data did not yield sufficient evidence to support the full segmentation theories described above. This is not conclusive, however, because the theories were applied post hoc to the data after the study period abroad was concluded.

Additional findings of considerable relevance to the discussion of H₂FCV commercialization relate to consumer perceptions of limited refueling infrastructure. Kurani found that, at the roughly 10% level of CNG station penetration in New Zealand at the time, consumers who did choose to convert their vehicles to run on CNG did not anticipate much of a problem with fuel availability, whereas those who did not convert

did anticipate problems. Further, those that did convert found fuel availability to be less of a problem than anticipated, supporting a distinction between vehicle attributes that can be evaluated while searching for a vehicle versus those that must be experienced after purchase. Surprisingly, perceptions of fuel availability did not change, despite increasing number of stations and users. And, finally, Kurani found people's assessment of fuel availability to be “impressionistic,” not really accurate: numbers and location of stations are not tracked carefully by individuals but rather feed a general awareness about refueling availability.

Nesbitt, K. A., K. S. Kurani, et al. (1992). "Home Recharging and Household Electric Vehicle Market: A Near-Term Constraints Analysis." *Transportation Research Record* (1366): 11-19. [34]

To produce a subset of likely buyers in an “initial”⁴² battery-EV market, Nesbitt, Kurani et al. (1992) constrained the 1985 American Housing Survey data with the following assumptions: each household must own a dwelling with a garage or carport, use two or more vehicles, and include at least one person with a commute of length less than 70 miles roundtrip. Nationally, roughly 28% of households met these criteria.

When the authors further constrained the results by income (must be greater than \$50k per year) and to allow only one battery EV per household, the market estimate was reduced to 13%. The likely result of further filtering the 13% subset with user

preferences — such as willingness to accept limited range, high cost, reduced luggage space, etc. — was anticipated to produce the roughly 1% level cited by various studies at the time, such as one made public by Ford. However, Nesbitt, Kurani et al. note that many factors could change user preferences over time, such as increasing knowledge of EV benefits, reduced costs, etc.

Nearly all households were found to have at least one round-trip commute of 50 miles or less, indicating vehicle range is not a significant constraint above this level. On the other hand, incorporating an income requirement would reduce the number of households dramatically. The authors did not do this explicitly, but rather showed the distribution of selected households according to income level. Although they found the income distribution of the potential-EV segment was higher than the average for all households, the dramatic effect of an income constraint led them to conclude that "...reducing EV cost could be more effective at enticing a larger market share than increasing EV driving range," (p. 18). I note that this would of course depend on the consumers' marginal cost of range, willingness of to buy a compromised vehicle even if they could use it, and so forth.

Interestingly, the elderly, often identified as a promising market segment for other reasons, were underrepresented in the subset identified by the constraints analysis. As long as the constraints analyzed are robust, this is one example of why the authors caution that other analyses (such as consumer choice, hedonic, and travel demand) that

⁴² The initial market for battery EVs was defined at the time (1992) to be that through the

do not focus on the identified segment, and thus do not acknowledge the technical constraints used to create it "will most likely provide erroneous results" (p. 18). The identification of a population from which other investigations could sample for analysis is therefore a valuable contribution of this effort.

As to the stability of the results, the report revealed two clues. First, using 1987 AHS data (which was inappropriate for the full analysis because it did not contain commute data), the authors estimated the percentage of battery-EV-capable households appeared to be growing faster than the housing stock (~6% vs. 2%). Second, the authors noted that technological, institutional (e.g., utility-investment), and adaptive-travel-behavior changes could overcome these constraints. However, of relevance to the commercialization of H₂FCVs using innovate value, Nesbitt, Kurani et al. cite two sources that indicate "any solution to the constraint of home recharging should be cognizant of the fact that those who can recharge at home may consider the convenience a significant advantage of battery powered EVs," (p. 18).

Turrentine, T., Lee-Gosselin, et al. (1992). "A Study of Adaptive and Optimizing Behavior for Electric Vehicles Based on Interactive Simulation Games and Revealed Behavior of Electric Vehicle Owners." Presented to the *World Conference on Transport Research*. Lyon, France. [65]

year 2000, assuming compliance with the original ZEV mandate.

“A Study of Adaptive and Optimizing Behavior for Electric Vehicles Based on Interactive Simulation Games” lays the foundation for future investigations into consumer response to advanced vehicle technologies. It implements an interactive technique deemed more appropriate for use than the traditional rational choice survey methods critiqued above [52]. By employing highly interactive “simulation games” based on respondents’ detailed, week-long travel diaries in addition to a standard battery of questions, the authors hope to elicit more informed and meaningful responses grounded in the real-world context of the respondents’ household vehicle fleet and travel behavior. Further, inspired by observational techniques developed in anthropology, the technique hopes to draw out and capture unscripted discussions that illuminate actual consumer behavior and decision-making dynamics free from the confines of experimental design.

In this report, which presents preliminary results from seven out of 40 interviews, the technique is applied to households selected using the filtering criteria discussed in Nesbitt, Kurani et al. 1992. As mentioned, interviewed households were asked to keep week-long travel diaries, which formed the basis of several “games” whereby the authors explored households’ ability to incorporate a battery EV into their fleet by gauging their response to various forms of tradeoffs, such as limited vehicle range and various vehicle novel options packages for their next vehicle purchase.⁴³ In addition to articulating the technique employed, the authors present several interesting preliminary results:

⁴³ Although this technique clearly elicits a more realistic and informed set of responses from consumers, thereby simulating the dynamics that might occur when electric vehicle markets are up-and-running, one possible criticism of the technique is that it goes *too* far, encouraging households to think more about their purchases than they, or their uneducated counterparts in the population, might actually do, particularly in the initial

Vehicle Range. Initially, when asked how long of a vehicle range they require, many consumers fell back on the range of their current vehicles, which represents a significant simplification and overestimation relative to the requirements in their travel diaries. The experimenters then explored range issues with a household in the context of their diary. Another rule-of-thumb emerged: the preference for a vehicle with a twenty-mile range buffer in surplus of actual needed range was common. Interestingly, households supplied this number despite current refueling practices, which indicated a majority of drivers said they refuel when their tank reaches either 1/8 or 1/4 full, thereby maintaining significantly more than a 20-mile buffer in practice.

Commute Distance vs. Routine Activity. When exploring the ability of the household to accommodate a limited-range battery-EV into their fleet, the households revealed more complex requirements than trip distance, such as the length of the daily commute: "...we find that more important than commute distance was the perceived and actual degree of routine in the travel patterns of participants and their households," (p. 8). Thus commute distance was a more accurate indicator of required range for households with regular, predictable travel; variability in routine activities increased this requirement. This observation will hold in subsequent studies [21] and forms the basis of the "routine

stages of market development. This presents an interesting consumer-education "chicken-and-egg" dilemma. The question of which of the following is more pertinent to understanding consumers will be left open: how we react to products we do not yet understand (possibly yielding data that unfairly and unrealistically preempts further discussions of what, in actuality, is a viable product), or how we might react once helped to reflect on those products (which may produce a more informed decision-making

activity space” distinction. Further, the authors related this finding to the results of the Rose Bowl test drive [44]: “those who professed routine [in the 1992 study] were mid-aged. This may account for the finding that the most receptive [group] to EVs in the test drive were in the age category 45–55,” (Turrentine, Lee-Gosselin et al. 1992, p. 8).

Home Recharging. Previously identified as a possible form of added value, the effects of home recharging on vehicle range requirements and willingness to accommodate a battery EV were also explored. Their results echoed the other findings: “For some PIREG [simulation game] participants, home recharging provided for all range needs, especially for vehicles that are used primarily for commuting and not other activities such as weekend excursions,” (ibid). Further, these discussions highlighted another important dynamic, vehicle swapping. “These households share vehicles often and the home is the hub for most activities. When potential range conflicts are encountered, recharging at work places and swapping vehicles with other household members solved the problem with a minimum of disturbance,” (ibid).

Vehicle Swapping. An effective strategy for adapting to range constraints, vehicle swapping was reportedly common practice in many households. However, “...there was resistance among some participants to increased vehicle swapping; the concerned drivers identify strongly with the performance and styling characteristics of their vehicles. Vehicles of teenagers were unavailable for swapping for these reasons” (ibid). This raises several questions not explicitly addressed by the authors. For example, despite the *ability*

process than many consumers will actually use in showrooms during early

of a household driver to swap and/or drive a range-compromised vehicle, what fraction of drivers would want to, and actually implement, these strategies? Might not a different filter than multiple vehicles per household, such as more vehicles than people, better accommodate the most promising EV owners? Finding a way to explore such a dynamic would be consistent with one additional finding of interest: fleet additions.

Fleet Additions. Unexpectedly, some households chose to add, rather than substitute, an EV into their household fleet. Not surprisingly, these households tended to be more affluent. Further, consistent with the Rose Bowl test-drive data, these households were “distinct from other households in that they own more vehicles, including recreational vehicles and pickups,” (p. 10).

Golob, T. F., R. Kitamura, et al. (1993). "Predicting the Market Penetration of Electric and Clean-Fuel Vehicles." *Science of the Total Environment* **134**(1-3): 371-381. [71]

In “Predicting the Market Penetration of Electric and Clean-Fuel Vehicles” Golob, Kitamura et al. (1993⁴⁴) describe preliminary results from a pilot study of consumer choices from hypothetical multi-attribute vehicle options aimed at investigating consumer response to AFVs. The study was part of an extensive AFV market research effort including a three-part survey of South Coast basin consumers who were asked to pick

commercialization).

⁴⁴ Although not published until 1993, text in the report referring to data not being available until “late 1991” dates the work in this preliminary analysis to (earlier in) 1991.

vehicle/fuel options from an attribute-based AFV and fuel-choice stated preference survey. The subsequent parts of the survey were customized somewhat to background information gathered on current vehicle purchase intentions in the first part of the survey. Based on this data, discrete-choice models, including multinomial logit models were estimated.

The attributes investigated included: “limited availability of refueling stations, limited range between refueling or recharging, vehicle prices, fuel operating costs, emissions levels, multiple-fuel capability and performance” (p. 371). In the second part of the survey, consumers were presented with vehicle options defined by these attributes in combinations manipulated by the investigators to assess responses to each attribute. In the third part, choices were made about fuel use in multi-fuel vehicles.

As the study was a preliminary, the authors simply conclude that results from the pilot sample “indicate that the survey responses are plausible and will indeed be useful for forecasting,” (ibid). However, in the context of the criticisms discussed above questioning the appropriateness of discrete-choice-model estimation for AFV attributes [52], it is interesting to note the inconsistencies found by the authors in consumer evaluations of hybrid vehicles, which, in hindsight, were not very well understood at the time. This considerable confusion surrounding a poorly understood vehicle option and the subsequent problems it presents for the data and its analysis reinforce the need for a more interactive/educational approach for, at the minimum, the less familiar attributes of advanced-technology vehicles.

 Kurani, K. S., T. Turrentine, et al. (1994). "Demand for electric vehicles in hybrid households: an exploratory analysis." *Transport Policy* 1(4): 244-256. [21]

In their 1994 *Transport Policy* piece, Kurani, Turrentine, and Sperling describe detailed interactions with 51 potential battery-EV consumer households, extending and formalizing many of the themes discussed above. The authors preface their work with an analogy to microwave oven technology, which did not end up replacing conventional ovens. Similarly, battery EVs should not be viewed as simple one-to-one substitutes for gasoline vehicles. Rather, learning, adaptive behavior, and innovation on the part of both the consumer and industry will be necessary before the real potential of this technology becomes clear. This research, using interactive stated-preference interviews, attempts to simulate that process of learning and adaptive behavior with households that might choose to incorporate battery-EVs along side gasoline vehicles in their household fleets, so called “hybrid households.”⁴⁵

A considerable contribution is made in this work by the discussion about, and implementation of, the authors’ adapted methodology. It begins with a critique of three major types of other methods:

- *Attitudinal surveys.* Trying to find “green” consumers with attitudes that predispose them to being willing to pay more for EVs may not be as appropriate

⁴⁵ As hybrid vehicles combine and manage combustion and electric-drive technologies in one vehicle drivetrain, so would “hybrid households” manage the use of both gasoline and EV technologies at the household level.

as focusing on purchase and use behavior (both broader lifestyle issues) as a primary filter, the authors argue.

- *Travel-behavior/constraints analyses.* This approach does not measure consumer preferences; it focuses on “can” not “want” or “will do.” Further they are based on analyses of vehicle stocks, not new-car sales. Past examples have been criticized as "merely wishful thinking" for their optimistic estimates of market potential, in contrast to the dismal estimates of the rational-choice techniques described next. However, I note, this may be a function more of emphasis (e.g., promising the fulfillment of the market share they identify rather than characterizing it as a reasonable maximum potential market or population to target), rather than a fatal flaw to the approach’s usefulness. Further, the differences between “can” adopt, and “want to adopt” are lessened to the extent the vehicle choices being offered are seen as less compromised.
- *Stated preferences (SP) and rational choice.* This approach does not capture market dynamics or development. The average marginal utility of a vehicle is of less importance for a new technology than the utility of initial market segment (who may derive only slightly negative or even positive utility from the “compromises” presented). Additionally, the Rose Bowl test drive provided evidence of volatility in range preferences. In other words, people’s opinions about vehicle range changed with their experiences during the drive, highlighting the lack of consumer information and experience for differently ranged vehicles. The pronounced learning effects and other sources of preference instability compromise the assumptions necessary for econometric model validity and suggest the need for new approaches. In brief, "Stated preference studies are likely measuring uncertainty and unfamiliarity, not utility," (p. 254).

The new approach suggested by the authors is the interactive stated lifestyle-preference technique: "researcher and participants engage in simulated decision making contexts designed from actual behavior of the household," (p. 247). The Purchase Intentions and Range Estimation Games (PIREG) technique developed for use here with the help of past practitioners of similar techniques (e.g., Lee-Gosselin) employ seven-day travel diaries.⁴⁶ The PIREG approach was used to investigate minimum and comfortable range requirements and behavior adaptation and optimization related to incorporating battery EVs into the household fleet.

⁴⁶ An effort was made to calibrate the data in the travel diaries to overall household behavior.

Key results

Unlike previous work that emphasized the adoption of battery-electric vehicles (BEVs) as “second” cars, in this report, the authors question the validity of the historical-cultural concept of first vs. second cars. Useful in a time when households were acquiring second cars for the first time, when women were entering the work force, etc., the modern notion of car ownership is functionally different.⁴⁷ The authors prefer to characterize the BEV purchase in terms of the choice between a homogenously fueled or hybrid household fleet. Further, the researchers quickly learned that simple vehicle substitution of a battery-electric vehicle (BEV) for a gasoline vehicle is only the “starting point for the household's learning” (p. 249). Among the adaptive strategies described in the report are: work recharging (which many households liked), vehicle swapping and switching, fast recharging (which was not found to be fast enough for most households), carpooling/vanpooling, renting (often described as too expensive/inconvenient), borrowing, bike/walk/transit, chauffeuring (the gasoline driver chauffeured the BEV user), rescheduling trips, and canceling/reducing trips.

Range. As previously described, the homogeneity of vehicle ranges creates initial difficulty for household evaluation of range issues: “When consumers, unfamiliar with a distance budget, are asked to respond to limited ranges, they typically respond with a range they are familiar with -- that of their current gasoline vehicles,” (p. 254). The

⁴⁷ According to FHWA data, the number of licensed vehicles in the U.S. began outnumbering the number of licensed drivers in roughly 1985.

authors refer to this as an anchoring effect and credit it as among the sources of large "apparent disutilities estimated by previous stated preference studies,"⁴⁸ (ibid).

Several findings speak to a more realistic assessment of range requirements;

- The “acceptable” (minimum) range for many of the households was quite small, less than 80 miles for most households; comfortable minimum range was longer—many households preferred up to 100-120 miles. This is consistent with the notion of a range safety buffer, typically of 20 miles. The authors referred to the 100-mile range mark as a “magic number” for the comfortable range of many households.
- "Drivers had more difficulty estimating long travel days, just as they had difficulty with irregular trips," (p. 254). Perhaps surprisingly, households underestimated by a larger amount than they overestimated long travel days. This difficulty is consistent with the distinction between 1) a better-understood routine activity space as an important determinant of vehicle range requirements for those with predictable travel, versus 2) a greater requirement for those with more variable travel.
- As an indication of what perceptions of range requirements are on these hard-to-estimate long days, the authors found that "In only four households does the sum of the longest day and the worst error exceed 150 miles," (p. 254).
- Another important range determinant emerged, even for those with more predictable travel: that of a “critical destination,” the furthest destination the household must be able to reach, whether real (e.g., the hospital in the event of an emergency) or imagined (e.g., a fanciful get-away destination).

Recharging. Range and recharge option packages above a household’s minimum acceptable range were offered to explore trade-offs. In general, range and recharge-rate preferences were very unstable, often changing several times throughout the interview in different contexts. However, there were two important findings.

⁴⁸ Again, although it is important to understand what the SP models are (mis)representing, it is also valid to note that, rightly or wrongly, these misconceptions would act as barriers to early EV purchases in absence of consumer education.

Firstly, households preferred to increase vehicle range rather than reduce by an hour or two recharge times. They often traded up range, down recharge rate to keep vehicle costs roughly the same. This was described earlier by the indication that even “fast” recharge rates for BEVs were not fast enough to make them compelling.

Secondly, households found the possibility of home recharging attractive: "Depending on trip patterns and time demands on drivers, home recharging is a substantial perceived benefit for many households. Many women who are the primary caregivers to the family's children stated they did not like to go to the gas station with the children in the car," (p. 253). Thus home recharging could eliminate the "Short, home-based trips whose sole purpose was to buy gasoline” that were common in the research sample (ibid).

Further, households with small routine activity spaces found home recharging particularly attractive. These findings on the potential positive utility associated with home recharging— a topic not adequately addressed by any previous study, according to the authors (p. 255)—are particularly pertinent to the discussion of potential innovative drivers for H₂FCVs. A similar capability has been recently proposed by, among others, Honda Motor Company.

Conclusions

The households interviewed were divided into three categories: those pre-adapted for BEVs (those for whom very few changes required, although work recharging was considered helpful even for this group; 29 of 51 households), easily adapted (those for whom switching/swapping strategies work and/or are already in the household repertoire,

who have larger activity spaces and critical destinations, and whose comfortable range was typically 80–100 miles; 15 of 51 households), and non-adapted households who would find it difficult or impossible to incorporate a BEV. Based on their findings, the authors concluded "We do find that most of the households in our sample can easily adapt to vehicles of far shorter range than previous research suggests and most PIREG households see a few simple adaptations as a reasonable commitment in the context of an historical shift to clean cars," adding later, "after requisite education and reflection," (ibid). The question not answered by the authors—Who will do the educating?—remains, as automakers have expressed an unwillingness to “tell consumers what they want.”

Irrespective of the question of education, the authors concluded that consumer preferences for BEVs are unformed, unstable, and changing. They conclude the report with the following comments (ibid): "Given all this, market research must focus less on providing questionable market penetration estimates and instead work to identify potential market segments for BEVs and to understand the nature of market barriers." Our societal goals "will be better served by an understanding of market dynamics and information on how to build viable markets for electric transportation options than by contentious estimates of some future end-state."

Kurani, K. S., D. Sperling, et al. (1995). "Household markets for neighborhood electric vehicles in California." Davis CA, University of California at Davis for Calstart. [36]

“Household markets for neighborhood electric vehicles in California” presents a multi-part analysis of a unique class of battery-electric vehicles, the so-called neighborhood electric vehicle (NEV). Although highly constrained in their size, range, and top speed relative to the variety of H₂FCVs being developed by automakers, this analysis of NEV adoption presents many interesting dynamics of interest to H₂FCV commercialization, particularly in its initial stages when vehicle range and refueling availability are analogously constrained. The report includes discussions of “golf cart” communities already adapted to NEV use (only briefly highlighted here), a battery-EV ride-and-drive for EV enthusiast and environmentalists, week-long NEV trials by households in Davis, and a statewide survey of over 400 recruits (69% response rate) from six metropolitan areas in California. Building on several themes from previous battery-EV studies, particularly [21], several important contributions follow.

Theory: Diffusion of innovation and the vehicle purchase decision process (NEV ride-and-drives)

For their NEV ride-and-drive clinics, Kurani, Sperling et al. recruited from two groups frequently proposed as potential early consumers of EVs: EV hobbyists (from the Sacramento Electric Automobile Association) and environmentalists (from the Whole Earth Festival). These choices are consistent with a previous report describing an adapted model of diffusion [58]⁴⁹: “The literature on the diffusion of innovations hypothesizes that the growth of the market for new products can be broken down into the sequential adoption of the innovation by distinct groups of people,” (Kuarni, Sperling et al. 1995, p.

32). At the beginning of that sequence lies the group known as the innovators. Citing *The Diffusion of Innovations* [43], the authors note the important function of this initial group, "...the innovator plays an important role in the diffusion process: that of launching the new idea in the social system by importing the innovation from outside of the system's boundaries," (Kurani, Sperling et al. 1995, p. 32).

In traditional diffusion theory, innovators—the initial importers of a new technology— influence subsequent adoption by the next group, “early adopters,” which in turn adopt before and influence the “early majority,” who are followed by the “late majority” [41]. In Turrentine and Sperling (1991), the model is adopted to distinguish between the potentially simultaneous and distinct influence on the mainstream market of two types of early consumers: innovators (with a slightly more specific connotation as a group inclined to tinker/experiment with the new technology, such as hobbyists) and moral/social choosers (such as environmentalists). As the hobbyists were themselves found to be environmentalists by the definitions used in this report⁵⁰, this distinction becomes confused and the advantages of the adapted model over the traditional sequential model less material in this particular context. Indeed, it could be argued that the authors, rightfully eager to shift emphasis to the more effectively operationalized activity-based approach described next, did not, or could not, fully explore the implications of this overlap and were somewhat overly dismissive of the diffusion approach

⁴⁹ This report is discussed in a subsequent section of the literature review.

⁵⁰ On a related note, the authors point out that “In a 1989 Roper poll, 75 percent of Americans identified themselves as environmentalists. Thus self identification as an environmentalist no longer distinguishes Americans, one from another,” (Kurani, Sperling, et al., p. 44).

in general.⁵¹ Nevertheless, several important points about the diffusion approach, with its attention to early AFV consumers, as well as the vehicle purchase process, are raised.

Innovative value/niche marketing. The allure of the diffusion approach lies in its promise of identifying those most inclined to value the new product: “These early buyers may be motivated by a particular knowledge of, or interest in, the new product. They may be able to derive especially large benefits from the new product,” (Kurani, Sperling et al. 1995, p. 38). Taken further, the early/niche consumer is likely to be more forgiving of the new product’s weaknesses. Indeed, this may manifest itself in subjective as well as objective ways. On the one hand, a niche may have different product requirements than the mainstream.⁵² On the other, as discussed by *New Transportation Fuels*, perceptions about future costs may be optimistic amongst early advocates. In the ride-and-drive clinic, “The only difference in group means occurs on the perception of the cost to run EVs compared to gasoline vehicles,” (p. 38). Hobbyists thought costs would be much lower.

⁵¹ For example, despite concluding “that our sample of EV hobbyists consisted of people who were themselves environmentalists” in the body of the report (p. 44), several comparisons are discussed throughout that do not appear to explicitly acknowledge this realization. This makes it unclear to what extent the preference for the activity-based approach depends on 1) the conclusion that the diffusion model “failed” in the specific but very limited context of the ride-and-drives, 2) because of more fundamental flaws (such as its retrospective nature), or 3) simply because the activity-based approach proved effective in its own right. Nevertheless, the difficulties of using the retrospective diffusion approach to identify early adopters in advance are acknowledged. Further, the usefulness of the activity-based approach—particularly for the highly-activity-constraining NEVs being examined—is clear and informative even for the arguably less constraining H₂FCV case. Both approaches will influence this dissertation research.

⁵² This difference between different markets/applications for a given technology is an important dynamic leading to the dilemma in Christensen’s *Innovator’s Dilemma* (Christensen 2000).

Information sources, the vehicle-purchase decision process, and learning. Of course, other differences besides optimism may account for different perceptions of new technologies like EVs: “information sources used by earliest buyers are likely to be different from those used by later buyers,” (p. 38). In the ride-and-drive clinic, environmentalists tended to get their information about EVs from mass media outlets, whereas hobbyists have their own sources (p. 41): “The EV hobbyists[,] on the other hand, cite sources of specific and detailed information. They have moved beyond awareness and are seeking information that will allow them to act to adopt EVs,” (p. 43). Related to the sources they use, hobbyists are characterized by the authors as being further along in a vehicle purchase decision process. Whereas the environmentalists were still gathering basic information to add to their general awareness (which their information sources reflected), hobbyists were much better prepared to make an actual decision about whether or not to adopt (p. 41). As a consequence, the environmentalist preferences should be less stable and more susceptible to learning. This was indeed the case: “The WEF recruits showed a statistically significant shift toward disagreement with the statement [that EVs are *not* yet practical]” in post vs. pre-ride-and-drive surveys (p. 39), providing evidence for such a learning effect.

Other vehicle-evaluation factors. Other portions of this report contributed additional insights into the vehicle-evaluation process. For one, the authors found evidence that vehicle evaluation is not simply a function of the vehicle being evaluated: “household vehicle purchase decisions are based on the vehicles the household already owns as well as the vehicles they are considering for purchase,” (p. Exec-iv). That households

purchase vehicles in this way points to a dynamic ability not only to incorporate specialty vehicles into the household fleet, but to negotiate use of those vehicles to fit circumstances.

The authors also found evidence for a staged consumer decision-making process that starts with an evaluation of the vehicle's capability to meet various lifestyle needs (e.g., passenger space, body style), then proceeds to amenity and other criteria such as brand, features, etc. (p. 45–6). Further, according to the statewide survey portion of the report, most consumers relegate efficiency and cleanliness to the second stage of this evaluation process: “[These] households reinforce the conclusion that people who chose EVs and NEVs regard them as practical transportation tools first, and as expressions of environmentalism second, if at all,” (p. Exec-iv).

Finally, the authors did find the use of activity-based concepts more useful in determining the likelihood that a prospective buyer would chose to adopt an NEV: “Of the different market segmentation strategies we employed, the most powerful and consistent concept for identifying households amenable to NEV purchases was the *household activity space*,” (pp. Exec-vii – Exec-viii).⁵³ This approach is described next.

⁵³ Relevant to the constraints analysis in chapter 3 of the dissertation research, I note the following about operationalizing the activity concept “One useful way to employ the concept is to describe buyers and users not in terms of their personal characteristics, but in terms of the characteristics of the environments in which the vehicles would be used,” (p. Exec-viii).

Theory: Activity analysis (NEV trials)

This NEV report extends the activity-based behavioral analysis begun in previous reports that identified such concepts as critical destinations and a household's routine activity space. Here a household's activity space is defined as the set of household members' activities, set in time and space, and the linkages between those activities (p. 6). Various constraints are placed on household activities, for example by schedules, commitments, income budgets, and newly brought to the attention of households when considering differently-ranged vehicles, a distance budget. This report theoretically grounds the notion of activity spaces even further in the constraints framework of Hägerstrand, who in 1970 came up with the following typology:

- Capability constraints “arise from biological requirements and the tools available to an individual,” (p. 8).
- Coupling constraints “define where, when, and for how long the individual has to join other individuals, tools, and materials in order to produce, consume and transact,” (Hägerstrand 1970) (p. 9).
- Authority constraints “define domains within the time-space prism to which an individual either controls the access of other individuals or to which his access is controlled by others,” (ibid).

The overarching research questions for the investigation were defined in terms of the subsets of activity spaces accessible by limited-range NEVs: “Will households create *NEV activity sub-spaces*?” and “Is the existence of these *NEV activity sub-spaces* a sufficient condition for households to include NEVs in their choice sets for their next vehicle purchase decisions?” (p. Exec-v). The factors that increase the likelihood of NEV adoption can thus be stated in these terms: “We found that NEV purchase and use is most likely when: the household has few binding authority constraints or binding coupling constraints associated with its routine activities; and the household has a high degree of

flexibility in assigning travel tools to household members,” (p. Exec-vii). For example, retired persons, who “have a great deal more discretion as to the schedules they keep than do households with children and workers” (p. Exec-v) have fewer coupling and authority constraints, giving them the flexibility necessary to incorporate novel “travel tools” like NEVs into their lifestyles. (There may be other reasons, however, like income, conservatism, etc. that may act to discourage the choice of NEV adoption by these otherwise promising groups.) Some of the specific findings, particularly from the weeklong NEV trials by households recruited from UCD employees, related to the formation of appropriate activity subspaces are presented next.

Travel flexibility and predictability. Most travel is constrained: “Two-thirds of all trips were either themselves constrained to the particular time at which they were made, or linked to another trip that was constrained to the time at which it was made,” (p. 55) However, the inflexible travel (principally due to authority or coupling constraints) tends to be routine and/or known several days in advance (p. 67), allowing for adaptation to NEV use (p. 57). For example, travel that serves another passenger in some way (e.g., chauffeuring kids), is both “subject to rigid time constraints” (p. 59) and tends to be “expected well in advance” (p. 60).

Activity space and range. Interestingly, even for NEVs, driving range was often not the binding constraint for routine travel. Usually it was passenger or cargo space, consistent with the priority given to lifestyle elements in the first stage of vehicle evaluation: “Within the spatial boundaries of their routine activity space, almost every household

discovered activities for which some capability constraint other than driving range eliminated some activities from their NEV space. The limiting constraint was almost always the passenger or payload capacity,” (p. 70). However, range limitations did make those with long commutes “non-adapted” for NEV adoption (p. 66). Further, range limitations prevented many of those UCD employees that lived and worked in Sacramento from creating sufficiently large activity sub-spaces to access a meaningful set of activities. Those who could not construct meaningful activity spaces around the NEV saw the vehicle simply as a limited car and were less likely to consider buying one (p. Exec-iii).

Other effects of NEV adoption. As might be expected from a limited-range vehicle, “NEVs replaced a higher proportion of household’s trips than of miles in all but one of our participant households,” (p. Exec-iii).⁵⁴ Notably however, NEVs replace trips that are often very polluting for conventional vehicles. On the other hand, a “guilt-free automobile trip can have the opposite effect: “...in Davis, 48 of the 242 (20%) of the NEV trips replaced bike trips,” (p. 64). Finally, trip chaining (e.g., combining trip purposes and destinations into a single excursion away from home) was reduced: “Several participants noted that during their trial week they tended not to combine trips in the NEVs out of fear of running out of charge,” (p. 66).

⁵⁴ “Approximately half of all trips are less than 5 miles in length,” (citing the EPA in 1992) (p. 2).

Putting it together: Targeting EV adopters under conditions of constrained vehicle performance (statewide survey and report conclusions)

The discussions of the statewide-survey results and the conclusions for the report as a whole provide a veritable laundry list of factors that would seem to be associated with a more likely NEV adoption choice. (Note: AFV options in addition to NEVs were explored in the survey.) Many of those factors considered potentially pertinent to H₂FCV adoption have been culled from those discussions, grouped, and listed here:

Consumer lifecycle and income

- “On the basis of [[44]], we speculated that households in the life cycles containing middle-aged parents with children responded favorably to EVs because they tended to: have higher household incomes; own more vehicles and have more vehicles per driver; have more routine driving patterns; and be more cognizant of fuel savings and life cycle costs. We also surmised they had stronger ties to their communities than households without children. What this reveals is a complex relationship between the market for EVs and life cycle,” (pp. 99–100). However, the authors found that the low cost of NEVs in the survey choice scenarios confounded their ability to discern this relationship (p. Exec-ix–Exec-x).
- There is no orderly relationship between income and vehicle choice (p. 101). However, “Households with the lowest average incomes—retired adults and single parents with older children—disproportionately chose gasoline vehicles.” This result, which runs contrary to relatively constraint-free activity space of retired persons, could be related to, for example, fixed-income risk adversity (ibid).

It is worth noting that the survey sample contained “virtually no households of single adults—with or without children.” (p. 99). Presumably these households were largely eliminated by the requirement, as in other studies, the household have at least two cars to facilitate incorporation of an EV into the overall households fleet, the subject of the next set of factors.

Household fleet composition

An important concept guiding the statewide survey design was the premise that vehicle purchases, whether of AFVs or conventional vehicles, are not evaluated solely on the basis of the vehicle being considered, but in the context of the household's fleet of vehicles (pp. 88–9). This has led to the use of the two-or-more-vehicles-per-household selection criteria in previous studies [21, 34, 44]. In this report, the authors note the likely impact of this requirement: “Almost 40% of households own 2 vehicles and an additional 20% own 3 or more, comprising a total of 54 million households with 2 or more vehicles (U.S. Federal Highway Administration, 1990),” (p. 1). Of direct importance to the adoption of AFVs, the authors believe this requirement dramatically reduces concerns about limited vehicle range: “We have explored this pre-occupation [with the effect of limited range] elsewhere and greatly discounted the impact of a daily range limit on households that own more than one vehicle,” (p. 11).

It would perhaps be useful, however, to explore taking this argument a bit further. Although some households seem willing to, or already implement, negotiating and coordination tactics for the various vehicles in the household fleet, such as vehicle swapping, other consumers are bound to associate more directly on a one-on-one basis with “their” vehicle. Given this, it would be interesting to explore in more detail than in this report (or, more appropriately, the 1992 constraints analysis) a criteria such as one-vehicle-per-licensed-driver should probably be explored. For example, in the ride-and-drive clinics, the authors found “one vehicle per driver in most households in both groups,” (p. 43). Additionally, other ways to reintroduce a certain portion of single-adult

households, such as filtering this group separately for range requirements or appropriate location could be pursued in the context of H₂FCV adoption.

Replacement vs. displacement: adding to the household fleet. Although the authors did not explore constraints on the number of vehicles beyond two-per-household, they did discuss a dynamic other than substituting EVs for conventional vehicles: adding EVs to the fleet: “Across the whole sample, only 13.6 percent (57 of 420) of households indicate that the next new vehicle they purchase will be an additional vehicle,” (p. 102) However, this number was higher, 27%, for households with older children. This modest but important effect may be overstated for H₂FCVs relative to the NEVs in the survey, which were characterized as affordable: NEVs dominated the larger set of choices to add an AFV (p. 103); 42% of those choosing an NEV said it would be an addition (p. 104). Further, most of the rest already had more vehicles than drivers.

Vehicle specialization. Associated with a surplus of vehicles in a household fleet is vehicle specialization. The authors found a high degree of vehicle specialization to be associated with an increased likelihood of EV purchase intention (p. 78). Vehicle specialization using unique travel tools, a dynamic reinforced by NEV offerings (perhaps more than for H₂FCVs), is the self-reinforcing basis of the original premise about the important context of the vehicle purchase: “Some already buy specialized vacation vehicles or commute vehicles. Thus the utility a household gains from, for example a NEV, is not a function solely of the attributes of the NEV. Rather its utility can only be

assessed within the context of all the travel tools available to the household and the activity space of the household,” (p. 87).

Vehicle age/size/style. Going beyond the household-fleet requirements of previous studies, the selection criteria used for the statewide survey were more prescriptive, requiring participants “buy new vehicles; own one 1989 or newer vehicle and one 1986 or newer vehicle; and at least one vehicles [sic] is not a full-sized vehicle,” (p. Exec-vii). The model-year specifications presumably were added to avoid households whose additional vehicles were more in the vein of the historical “second” vehicles: beat-up, high mileage vehicles for which expensive new EVs were an unlikely substitute. The requirement that one vehicle not be full-sized what meant to reflect the fact that EVs were anticipated to be offered only in small body styles. However, despite the sequential vehicle-evaluation model presented earlier whereby body style and other lifestyle considerations are considered of primary importance, “nearly half the people who chose a NEV had previously stated they preferred a full size vehicle. These households provide examples of people willing to construct an entirely different household fleet when offered a NEV than they might otherwise,” (p. 106).

Location, supportive environments

“Within this [activity] framework, we conclude that, unlike gasoline vehicles which can be marketed almost independently of where they are intended to travel, markets for NEVs will be defined primarily by characteristics of the environments in which they are intended to be used, and secondarily, by characteristics of persons,” (p. 111). Although

not likely to be as constrained and specialized as NEVs, H₂FCVs face a similar dependency on the environments in which they will be used, in particular on the morphology of a nascent refueling infrastructure in a given region. In this report, the authors found “NEV purchase and use most likely when” there was a “high density of activities around recharging locations,” (p. 114), highlighting the “interaction between household activity space and physical infrastructure in defining market for NEVs,” (p. 108). Similarly, the effectiveness of an H₂FCV as a transportation tool will depend on what subset of meaningful activities a consumer could access using the tool in the context of that refueling-infrastructure morphology.

The NEV case also highlights the linkage between use environment and vehicle design: “Matching vehicle capabilities to intended use environments will increase the effectiveness of NEV demonstrations” and avoid preemptory rejection of the technology, whereas excess performance will unnecessarily drive up costs (p. 125). For NEVs, the authors argue, there is such a thing as too much range. This counterintuitive result stems from the trade-offs between vehicle cost and performance. But this trade-off can be properly analyzed in the context of intended vehicle use. The NEV trials in Davis, California (a small city buffered from neighboring development by agricultural and natural areas) showed that all activities that a household would want to reach using those small vehicles was within current battery capabilities. The marginal value, therefore, of additional range was small and would not justify current marginal battery costs.

So, too, might there be use environments that do not justify excessive additional hydrogen storage⁵⁵ in H₂FCVs, despite the widespread agony over solving this, the technology's "Achilles heel." But, again, this assessment can only be properly made in the context of a specific refueling-station morphology. In the absence of sufficiently dense and/or high-coverage refueling infrastructure, however, the challenge will undoubtedly remain "more is better" as vehicle developers try to achieve uncompromised vehicle range. However, a strategy aimed at maximizing the effectiveness of H₂FCV demonstrations and roll-out, particularly one informed by a strategic niche marketing approach, would be sensitized to the complex relationship between vehicle design, use, and infrastructure and would opportunistically seek out and exploit the most supportive environments.

Thinking along those lines for NEVs, the authors briefly identify and describe several important niches that might be relative supportive of NEV use, including: resort communities and other facilities in environmentally sensitive areas (with the possible benefits associated with second-home ownership), state parks (that could enact multi-purpose, supportive policy like banning gasoline/diesel use or limiting vehicle entry/egress to AFVs), and industrial parks, (p. 118). Further, the two golf-cart community case studies describe Palm Desert, California and Sun City, Arizona as already having "supportive local institutions, NEV-amenable roadway infrastructure, and activity and lifestyle choices that favor ownership," (p. 112). Similarly or analogously

⁵⁵ And its associated costs in pressure and compression energy, vehicle weight, increased parasitic loads, cold temperatures, or exotic materials.

supportive environments for H₂FCVs could be sought, probably in regions with plans for high densities of early hydrogen refueling.

Innovative value: home recharging and novel ownership arrangements

Finally, indications of two potential forms of innovative value could be found in the report and its conclusions. Firstly, as before, participants found home recharging more than a necessary evil: “Charging the vehicles at home was an easy task and a convenience for most households,” (p. 65).

Secondly, unique vehicle ownership arrangements were discussed, both in the context of the study’s respondents as well as for employers and organizational fleet operators. In a time when leases were much less common, the authors noted the risk-mitigating effects of alternative ownership arrangements. However, their suggestions ranged much farther than leasing to include transit station cars and employer-provided vehicles (p. 117). The latter opportunity, which resonates well with the V2G strategy presented in chapter 4 of this research is described as follows: “...ownership arrangements in which an employer or other vehicle provider owns the NEVs and rents or leases them to employees are potentially valuable ways to provide consumers with experience with NEVs. Large institutional buyers, who might otherwise be good prospects for NEVs for their own fleet use, could operate NEV demonstration programs for their employees. Potentially, many large industrial, commercial, educational or health-related complexes could use NEVs in their own fleets of vehicles in demonstration projects for their employees,” (p. 117).

Turrentine, T. and K. S. Kurani (1995). “The household market for electric vehicles: testing the hybrid household hypothesis -- a reflexively designed survey of new-car-buying, multi-vehicle California households.” Davis CA, University of California at Davis for CARB and CalEPA: 1 v. (various pagings). [72]

In “The household market for electric vehicles...” Turrentine and Kurani discuss in depth the design and results of full statewide survey described in part in the previous review of NEVs. In a major part of the survey, participants were asked to make vehicle choices from two different “choice situations” with different sets of vehicles. The first choice was from various battery-electric and conventional vehicles; the second choice included additional choices: reformulated-gasoline, natural gas (NG) and range-extender hybrid-electric vehicles (p. 3).

The sample for the survey was selected using the following criteria: own two-or-more vehicles, buy new vehicles, own one 1989 or newer and one 1986 or newer, at least one vehicle owned is not a full-sized sedan, van, SUV, or pickup. Further, they authors tried to match the distributions of the respondents to the ages and proportions of consumers of minivans, SUVs, and sedans in the California new-car market. Finally, they sought a 50/50 split of foreign/domestic-vehicle consumers (p. 31).

Although the report cautions that “It is important to understand that the choice experiments are not intended as forecasts or predictions of future vehicle market

scenarios,” (p. 3) the presentation of the results in the abstract and executive summary could be misunderstood as such a prediction. For example, the abstract states “...we find the market potential for EVs to be 13 to 15 percent of the annual, new light-duty vehicle market in California,” (p. VIII). These percentages are further quantified as 186,000–213,000 annually (based on 1.4 million vehicles sold per year). Important qualifications include the assumption that vehicles have 60–150 mile ranges and are comparably priced to gasoline vehicles to yields these “market potential” estimates. Further, this analysis does not include organizational fleets, or households that are not *potential hybrid households*, as defined by the sample selection criteria described above.

The vehicle choice situations include vehicles characterized using “a blend of existing, expected, and experimental” features,” (p. 3). Notably (and unfortunately, for generalizations about NGVs), NG vehicles were intentionally assigned ranges of 80 or 120 miles per tank, below both existing NGVs as well as the speculative ranges assigned in the survey to certain configurations of battery EV. Vehicle prices were not varied by fuel/propulsion technology, but by features: “body styles, trim levels, and optional equipment” (p. 3), including different battery sizes for range trim levels.

The hybrid household hypothesis

The first choice situation was designed to test the authors’ “*hybrid household hypothesis*”:

Hybrid household hypothesis: “A driving range limit on one household vehicle will not be an important barrier to the purchase of an [comparably priced] EV [with a 150-mi range] by a potential hybrid household” (p. 2)

This was operationalized as “ H_0 : at least 38% of our sample will choose an [battery] EV for their next new vehicle,” (p. 4). The 38% figure was derived in the following way (p. 14): Kurani, Turrentine et al. (1994) determined that approximately 8–10% of potential hybrid households were non-adapted, leaving 92% eligible. The average number of cars per household was $n=2.34$. If each household replaced one vehicle with a battery EV, they would choose a battery EV, on average, one out of every 2.34 times, or 41% of the time. 41% of the 92% of eligible potential hybrid households is 38%.

The results of the survey indicate “46% of our sample chose an EV over a gasoline vehicle for their next household vehicle,” (p. 4).⁵⁶ The authors further “estimate that potential hybrid households buy between 35 and 40% of all new vehicles in California every year,” (p. 15), although the basis for this is unclear.

Attitudinal, use-constraints, and econometric approaches

In the executive summary, the authors frame this work as attempting to reconcile the optimistic results of attitudinal and travel-behavior studies and the pessimistic results from econometric models (p. 1). This dichotomy, however, is in some sense an artifact of placing non-equivalent techniques on the same “market prediction” spectrum, the very spectrum the authors try to avoid for their own results. For example, a constraints analysis whittles away at the total market potential for a product to identify a more

⁵⁶ Note: the authors presumably include choosers of hybrid-electric vehicles in this figure, as they do in their definition of hybrid households. Although the range-extender design assumed at the time does involve plugging in, I would argue that, because the vehicle owner does not have to plug in, but can refuel the vehicle on gasoline, these vehicles do not require the behavior modification that defines a hybrid household with a battery EV.

efficiently target-able market potential. With a proper emphasis on the notion “potential,” an accurate description of the approach would not claim ability to describe the purchase intentions that exist in that pool, let alone the actual purchases that might manifest out of it. Stated-preference-informed econometric models, on the other hand, do attempt to model the purchase intention itself, and are therefore necessarily a subset of the market potential identified by the constraints analysis, unless of course inappropriate or excessively limiting constraints have been used. The choice model, however, can be applied to any population, regardless of promise. Thus the two approaches should be complimentary in their contribution to the understanding of emerging markets: constraints analyses can help identify promising populations of potential early adopters, the very population(s) to which the choice models should be applied if they are to model the most relevant consumers. Of course, each approach has its limitations, many of which have been discussed. Attitudinal studies, for their part, look at the “front-end” of the consumer thought processes about a new product, such as a consumer’s environmental values or tendencies, but fail to model the choice itself. Choice models, on the other hand, do this, but are also limited by their “back-end” approach to a superior simulation of past behavior (revealed preferences) relative to consumers faced with the uncertainty and unfamiliarity of innovation.

Additional insight from the report into these approaches include:

Attitude surveys and green markets. Attitudes towards EVs “represent the ideals of consumers and not their full decision process,” (p. 17). There appears to be broad public

support for environmental issues (as previously stated, about three-fourths of Americans self-identify as environmentalists of some type, but there are serious doubts that consumers will shoulder the financial burdens of green products.⁵⁷ In this study, for example, “the buyers we interviewed were already stretching their budgets to buy the cars they wanted,” (p. 9). The disconnect goes beyond purely fiduciary matters: “...many of those with strong environmental convictions have neither appropriate vehicle use nor purchase behavior to consider buying an EV,” (p. 18). Although practical in final decisions, the authors note that it is not simply a matter of all or nothing. An important leverage point still exists in the middle of the purchase-decision process: consumers can be environmental in their information search behavior (p. 9).

Travel-behavior and use-constraints analyses. Use-constraints analyses do not examine consumer purchase preferences, intentions, or behavior. “While measuring a “potential market”, these studies don’t examine attitudes or social processes that will shape consumer lifestyle choices. Additionally, they analyze vehicle stocks, not new car sales,” (p. 19). For battery EVs, these studies typically use travel diaries or nationwide survey data, such as the Nationwide Personal Transportation Survey (NPTS, contains a one day travel diary) or the American Housing Survey (AHS, which asks about typical travel and commute travel) (p. 18). For example, Greene (1985) used “multi-day refueling diaries, and inferred underlying distributions of travel. He concluded that with 95% probability,

⁵⁷ Nevertheless, a small minority of “affluent, environmentally conscious households could afford to pay premium prices to express their environmental proclivities” and are expected to be important and influential in the early years of EV market development, (p. 9).

half of all household vehicles travel less than 105 miles per day on 95% of all days,” (p. 18).

Stated preferences and choice models. Stated preference data allows rational choice models to “assign partial utility values to consumer preferences for vehicle attributes,” (p. 19) These utility values are, in turn, are often used to estimate values, or penalties, for different levels of vehicle attributes, sometimes producing absurd extrapolations:

“...these studies suggest that, on average, consumers would be indifferent to the choice between two cars that were identical, except one was free and had a 50 miles range, and the other, for which they must pay full prices, had a 200 mile range,” (ibid). In addition to revisiting some of the underlying assumptions that are problematic when the models are applied to AFV adoption, the authors note the distinction between mature and developing markets: “the average utility is irrelevant to the dynamics of market development.” Average consumers, they note, “are not, by definition, the first buyers of something new,” (ibid) and therefore should not be the focus of studies of innovation.

An important aspect of innovation is the careful balancing of expectations [50]. Just as unbridled optimism will lead to investor fatigue as promises take longer to materialize and unrealistic expectations from the public, so pessimism can pre-empt innovation. The authors highlight the mechanics of this latter dynamic in the use of vehicle sales projections: “Conservative sales estimates in turn lead to yet higher cost estimates because costs are spread over few vehicles. High cost estimates iteratively reinforce minimal EV market estimates,” (p. 17). Given the risk of falling on one side or the other

of the sales-estimate teeter-totter, it would seem the only recourse to resist as far as possible the temptation to predict “the size of the market at the expense of understanding market dynamics...” (p. 17).

Range and recharging

Respondent range choices. Overall, 293 out of 447 households, or 66% chose vehicles with ranges of 180 miles or less rather than “ranges similar to existing gasoline vehicles”; 42% chose ranges of 130 or less (p. 6). In one exercise, respondents were asked to choose between two type of range packages: type 1 offered either 80 or 100 miles of range, depending on the body style of vehicle being considered; type 2 offered either 100 or 120 miles for \$1,200 more (p. 5). 37%⁵⁸ chose type 1, including a majority of those evaluating small SUVs, small sedans, and, particularly, compact sedans. 63% chose type 2, dominated by those considering mid-sized sedans, with a majority of sports cars, and compact pick-ups.

From their range results, the authors concluded, “...it is more important to provide a less expensive battery capable of providing 60 to 100 miles of range than to develop an expensive battery for vehicles with 200–250 miles of range. The marginal utility for electric vehicles with ranges above approximately 150 miles will rapidly approach zero so long as there are gasoline vehicles on the road which have 300–400 miles of range and can be refueled in less than 5 minutes,” (p. 7). In this case, as with “fast” recharging, it

⁵⁸ I note that this fraction choosing type one (80–100-mile range) is similar to the overall fraction (42%) that chose ranges of 130 miles or less, but cannot account for the inconsistency, if any.

appears that “more” range would only be “better” if it were comparable to conventional vehicles, given the likely cost trade-offs. Although the range-related component cost structure is different for H₂FCVs, likely making the proportionate marginal cost of range is smaller than in battery EVs where power and energy functions are combined into one device, it would be interesting to explore those H₂ storage/pressure/range, etc. trade-offs.

These choices for vehicle range must of course be put in a broader context. As in the previous report, the authors note the complexity of issues surrounding range requirements. “We argue that consumer response to limited range is conditioned by many variables” including travel routines, allocation of driving to various vehicle in the fleet, instrumentation, and the demand for home recharging (p. 45).

Respondent travel. From a travel-behavior perspective, the sample studied in this report had modest range requirements: a median one-way commute of 10 miles, with 90% of one-way commutes falling below 35 miles. Further, 90% of critical destinations were less than 50 miles (p. 5).

Household fleets. Supporting their consistent use of the two-or-more-vehicles-per-household criteria, the authors concluded from this study that they expect “vehicles with ranges of 80 to 100 miles (as offered in Situation One) would suffice for 90–95% of all travel days,” (p. 45). Put simply, “That is to say, rarely do households use all their vehicles simultaneously to accomplish long range travel,” (p. 45).

Vehicle “defining purpose.” Consistent with the sequential model of consumer vehicle evaluation presented earlier where body style was often of primary importance, this report introduces a new concept to help describe that process: “The body style a household chooses is shaped by a *defining purpose* for that vehicle,” (p. 7). This concept further illuminates vehicle choices, some of which may go against other, more attitudinal arguments. For example, certain households with retired members, discussed earlier as promising for their activity flexibility (but perhaps risk-adverse) may not choose AFVs if the defining purpose of their vehicle is for vacation use. On the other hand, the study found that “...young families were very much more likely to choose an EV than any other type of vehicle, if their defining purpose for the vehicle was either to chauffeur children or commute,” (p. 8). As a whole, the single largest choice of vehicle purpose was for EV-amenable commuting: 47%. The purpose getting the second-largest number of choices (23%) was for vacation or weekend travel (ibid).

Instrumentation. Household understanding of vehicle range in the study was not precise: “One-third of our sample reported implausibly low ranges for the vehicles they have been driving for months or years,” (p. 46). Further, even instrumentation does not guarantee consistent answers from consumers of homogenously ranged vehicles. “In addition to the wide range of beliefs about how much range is left on a gasoline vehicle when the low fuel indicator light goes on, these drivers showed a wide range of responses to that information,” (p. 47). For example, despite the 20-mile safety-buffer rule-of-thumb posited in previous reports, the vast majority of respondents in this study stated they refueled with more than 1/8 of a tank (40–80 miles of range left) (p. 48). This behavior

depends on factors like distance to a refueling station, familiarity with the region, and proximity to home (p. 49). Understanding the relationship between vehicle range, instrumentation, and refueling behavior will be critical in the early stages of hydrogen refueling infrastructure development.

Recharging. An innovative addition to the complex refueling relationship described above is the opportunity for home recharging/refueling. In this survey, 54% (246/452) households chose vehicles which could refuel at home (i.e., battery EVs and NGVs with a home refueling appliance option⁵⁹) (p. 5). The large percentage of households that chose vehicles with this novel attribute suggests that it is valued as a way to mitigate range constraints (p. 55), if not for other reasons, some of which have been previously discussed.

Faivre D'Arcier, B., J.-P. Nicolas, et al. (1995). "Impact of a Limited Range on Electric Vehicle Use in France: Results of a Simulation Game Survey." Lyon, France, Institut National de Recherche sur les Transports et leur Sécurité (INRETS): 21. [73]

Similar to Kurani, Turrentine, et al. 1994, this report applied the interactive stated preference technique to a small number of households in Lyon, France. The authors

⁵⁹ "A home refueling appliance was offered that they could either buy for \$2,500 or lease for \$60 per month," (p. 55). 36/452 chose NG with home refueling, 52 chose NGVs without. (NB: The relative, not overall, numbers of NGVs selected are more meaningful, as there were lots of choices being made about multiple attributes simultaneously and NGVs were assigned artificially low NGV ranges.)

found the methodology promising but costly (~\$1,000/household), and had various suggestions for its proper implementation.

Various strategies for adapting travel behavior were discussed with households (including measures not considered as viable in the US: trip cancellation, switching to walk/bike/transit, etc.) Not surprisingly, households often changed the strategies they initially suggested upon further reflection with the realities of their trip diaries. Similar to Kurani, Turrentine et al., this study highlights the importance of the redefined relationship between household and its travel tools. Faivre D'Arcier, Nicolas et al. describe it this way: "...the challenge is not to understand alternative-fuelled vehicle use, but to understand alternative uses of vehicles," (p. 15).

Some of their more unique findings include:

Household fleets. In contrast to the dynamics of large household fleets with specialized vehicles described above [36], the French respondents had difficulty imagining paying more for a secondary car that they would not use as much as their primary one. Similarly, the authors discuss how EVs are perceived to be half-cars (e.g., "voitures," small cars that can be driven in France without a license).

Household location and the environment. Air quality did not have much traction with the households interviewed. Those who lived in the suburbs needed longer driving range and perceived air pollution as a city-center problem (where they rarely go). Those who lived

in city centers (there were not many in the sample) tended to have only one car but have access to good transit. They viewed second-car ownership unfavorably: finding private parking and so forth for two vehicles would be expensive and inconvenient.

Range. In the case of France, the authors concluded that a 100-km range appears to be the minimum necessary to develop the market. In the process of developing this belief, two reasons were discovered for a requested range of 80-100 km by respondents (which exceeded their actual needs): 1) because respondents had difficulty accurately assessing distances and working with their "distance budgets" (versus the more familiar time budget), and 2) they wanted roughly two day's worth of range in case they forgot, or were otherwise unable, to recharge at night.

Flynn, P. C. (2002). "Commercializing an alternate vehicle fuel: lessons learned from natural gas for vehicles." *Energy Policy* **30**(7): 613-619. [35]

In his 2002 piece for *Energy Policy*, Flynn, the former president of Canadian firm CNG Fuel Systems discusses lessons from compressed-natural-gas-vehicle (NGV) commercialization failures during the mid-1980s (1984–1986). At that time natural gas was priced attractively relative to oil, creating interest in vehicle conversions. Gas utilities recognized NGV commercialization as an opportunity to increase the "level load," smoothing seasonal demand from buildings. However, NG vehicle conversions and infrastructure build-up failed to reach a critical mass by the time oil regained its

attractiveness in the 1980s. Common to the many case studies of AFV development throughout the world described in *New Transportation Fuels*, failing oil prices robbed the momentum from NGV adoption. Flynn discusses several factors that he believes retarded vehicle adoption, keeping it at a rate “below a critical level which would enable healthy suppliers to survive in a competitive market,” (p. 613). These factors include infrastructure profitability, fleet sales, OEM vehicle technology, service pricing, and supportive policy measures.

Infrastructure profitability

Once an alternative fuel is available in a commercial setting, infrastructure profitability becomes the primary concern, Flynn argues—more important than vehicle technology. Infrastructure profitability allows the continual expansion of refueling stations that feeds consumer confidence: “The failure to build profitability at existing stations in order to sustain investment in additional refueling facilities was, in hindsight, the most significant factor in limiting the growth of NGVs,” (p. 615). Indeed, other studies (e.g., Kurani 1992) have indicated that a general sense of expansion is as important to consumers as actual numbers or coverage of AFV refueling stations.

Infrastructure profitability, however, is particularly tricky during market development, when sparse vehicle demand does not provide for the economies of scale and sales volumes so desperately needed to lower and spread out the costs of new, low-volume, and therefore expensive, refueling equipment. However, early vehicle adopters, who are often small-scale experimenters, cannot afford their own refueling capital and require

public refueling facilities, exacerbating the problem (Flynn 2002, p. 615). This problematic need for public refueling puts a finer point on Flynn's estimation of the importance of infrastructure profitability in general: "The largest problem the NGV industry faced in Canada was a stalling in investment in public refueling facilities," (ibid).

Indeed, Flynn saw this issue as so critical, that he regrets more drastic measures were not taken to address it—even in the face of scarce marketing resources—including coordination between vehicles sales and infrastructure build-up: "In hindsight, intense [vehicle] selling around every station (including direct telemarketing) to achieve profitability, or moving NGV fueling stations from sites that were not profitable (even if this meant buying back vehicle conversions from those who would have been orphaned) would have been a better strategy, since the loss of fuel retailer interest eventually destroyed the momentum in the business," (p. 616).

Fleet sales

Because infrastructure profitability is so crucial, it is tempting to court high-volume customers, such as large fleets with centralized refueling and maintenance and aggregated vehicle purchasing. Experience showed otherwise for Flynn: "...very large fleets operating from a single location are rare and tend to be conservative buyers..." (p. 615). Heavy-handed in their conservatism, large fleets "would hardly ever commit to a block purchase without an introductory trial," (ibid), a taxing requirement for advanced-technology vehicle providers, which were largely after-market conversion companies at

the time. As a result, Flynn found himself focusing on products that served roughly 30 vehicles despite diseconomies of the scale.

Employing the diffusion of innovation model described previously, Flynn's company did not find most early CNG vehicle consumers in Canada in large fleets: "Leading purchasers of new fuels are by definition innovative purchasers, and CNG-FS found these in very small commercial fleets and single high mileage commuters. Over 90% of conversion sales in Canada were to such customers, who required refueling in public facilities," (ibid).

OEM and aftermarket vehicle

CNG commercialization in the mid-1980s would have benefited from greater original-equipment-manufacturer (OEM, or automaker) participation, according to Flynn:

"Aftermarket products have lower credibility in the eye of the consumer than OEM product," (p. 616) and OEMs can reassure consumers with their service and maintenance suppliers. However, aftermarket upfitters often kick-start markets and provide demand for volume-dependent infrastructure profitability: "Aftermarket product is also needed because OEM sales are too low to build a profitable load on infrastructure, especially refueling," (ibid).

Affordable service

Another key problem identified was unaffordable service, apparently due to expensive part mark-ups. In this analysis, Flynn reveals important service dynamics to the

uninitiated: "On average, typical gasoline vehicle service charges are 50% for labor and 50% parts. The owner of the service facility usually keeps half the labor charge and 20% of the parts charge (equivalent to a 25% parts markup) as contribution to overhead and profit" (ibid). Apparently service managers maintained their mark-up structure, even on expensive AFV parts, making service unaffordable. The alternative Flynn suggests tries to maintain cash flow while keeping service affordable: "For expensive service preserving their "bay day" revenue, rather than their parts percentage markup, would help," (p. 617). Further, he suggests the benefits of revenue diversification argue for a network of multipurpose conversion and service dealers over the use of one dedicated to the alternative fuel (p. 618).

Supportive policies

Finally, Flynn comments on several factors that affect the bigger picture. He notes the "black-eye" feelings of participants who relied on wildly optimistic early assessments; the need for clear, permanent policy signals from utilities, government agencies, and other actors (p. 617–618); and the harm optimism can have on policy formation: "It is particularly important that governments get clear messages about economics, so that stable public policy can be designed," (p. 618). In one specific example of the need for consistent, continuing commitment, Flynn notes the dangerous effect of temporary subsidies, which act like a cliff awaiting technologies that do not achieve profitably in time for their expiration (p. 617).

Kurani, K. S. and T. S. Turrentine (2003). "Household Adaptations to New Personal Transport Options: The Reflexive Organization of Household Activity Spaces." Davis CA, University of California at Davis: 23. [66]

Continuing their exploration of household activity spaces, Kurani and Turrentine's "Household Adaptations to New Personal Transport Options: The Reflexive Organization of Household Activity Spaces" focuses on the dynamics of various adaptive strategies used to accommodate and incorporate AFVs. The premise of this activity-based approach to AFV adoption remains that households maintain fleets of vehicles to access lifestyle activities. Here, the authors supplement Hägerstrand's system of constraints with Giddens' conceptualization of "locales" not as physical places, but as settings for social interaction. Thus the process of using vehicles to access various locales in a household's activity space takes on a more socially meaningful orientation.

When AFV adoption is examined using interactive stated-preference techniques, households tend to segment travel by tool/mode to create activity sub-spaces accessible to each mode, without fundamentally changing their activities (i.e., they will simply use the conventional gasoline vehicle in their fleet to access those activities not accessible to other modes). As a backdrop to this hypothetical segmentation, the authors note a trend already apparent in households toward vehicle diversification and specialization.

Exploring with households the unfamiliar concept of a distance budget gives rise to discussions of various adaptation strategies, including: pre-planning, switching vehicles

during the day, changes in trip linkages, and so forth. As before, the distinction between a routine activity space and a critical destination is important. For example, even range capability of less than 120 miles comfortably serves the routine activities of many households. The comfort-level of households seems, therefore, to extend to ranges far below the minimum range elicited from hypothetical choice models.⁶⁰

Evident in their discussion are several factors that, if present, would appear to increase the likely level of AFV adoption:

In use:

- the presence of more than one vehicle in the household fleet (although not necessary, assumed to allow for household member negotiation, vehicle substitution and specialization, etc.)
- ease of household negotiation over vehicles in the fleet (takes various forms)

During the purchase process:

- consumers wanting to express with their vehicles a wider variety of values and lifestyle goals (e.g., environmentalism);
- AFV offerings with at least “2+2” passenger seating capability;

Innovative value:

- Refueling while parked (at home, at work, at transit station, while shopping, etc.)

7.3.3 *Lessons from technological innovation and marketing theory*

Turrentine, T. and D. Sperling (1991). “The Development of the Alternative Fueled Vehicles Market: Its Impact on Consumer Decision Process.” *Methods for Understanding Travel Behavior in the 1990's*, Chateau Bonne Entente, Quebec, International Association for Travel Behavior. [58]

⁶⁰ One primary reason for this difference, not discussed by the authors, might simply be associated with the difference between focusing on vehicle selection (which may elicit more of a “I want” response) versus vehicle use (which gets respondents to focus more on what they need).

Turrentine and Sperling present a conceptual model to describe the diffusion of AFV adoption through two early consumer types and into the mainstream. Motivated by critical shortcomings of choice modeling when applied to the challenges of AFV purchases, their model takes a less practical, but more theoretically justifiable, approach to describing the consumer decision process. The final result synthesizes theories from several fields, emphasizing the importance of psychological and sociological features in early AFV markets, while allowing the more traditional economic rational choice theories to describe more mature markets, with some modifications. The model is summarized in a Venn diagram.

Overall, the model can be characterized as an innovation diffusion model whereby two sets of innovative consumers adopt AFVs early in their commercialization. Subsequently, these two groups can simultaneously but in different ways influence later, more mainstream and more utility-driven consumers. More specifically, these consumers sets are (p. 220): experimenters (whose behavior is predicted by information search theories), those with social (including moral) preferences (predicted by public choice theories), and those for which AFV attributes are consistent with preferences based on prior purchases (predicted by consumer choice). The following elaboration of their model begins at the end of the diffusion process, with the latter group.⁶¹

⁶¹ The authors might have chosen a more intuitive labeling scheme ;)

Utility-maximizing consumers (mature markets)

Although the authors describe the assumptions underlying economic theories of rational choice as “unsupportable” when applied to early market development for AFVs, as described below, these theories are retained in the model to describe the AFV purchase process by less enthusiastic, more utilitarian consumers in later markets. However, several adaptations to the vehicle-evaluation process, aimed at making the description more realistic, arise from the authors’ criticism of rational choice theory. Rather than accepting that consumers make fully informed, comprehensively analytical “compensatory” evaluations of vehicles—simultaneously comparing all offerings on every dimension and picking the one that maximizes total utility—the authors amend the process in their model in two ways.

Firstly, they limit the number of attributes being considered to a small, manageable set, as proposed by Lancaster, adopted by McFadden, and applied to AFVs by Train, Beggs, Cardell, Green, and others. Secondly, they argue that even a limited compensatory analysis can be too complex to be cognitively realistic for everyday choices by many consumers, noting that psychologists and marketers have “abandoned the concept of compensatory choice in favor of theories with sequential choice processes,” (p. 212). As an example alternative the authors describe Tversky’s elimination-by-aspect (EBA) process whereby consumers sequentially disqualify alternatives based on simple criteria, thereby reducing the options considered. Using such a technique, the process of vehicle evaluation would start with elimination of all vehicles that do not meet a few, key criteria and unfold as follows: “The first attributes in such a sequence will be the most salient in

relation to budget or other primary constraints such as family size. Secondly, further sequential elimination is based upon categorical beliefs, such as brand quality. A final set of compensatory judgments is made based upon other less salient attributes," (p. 213).

Thus, compensatory analysis is relegated to only the latest and most utilitarian of adopters in the most mature markets. Others use sequential hierarchical filters to simplify their evaluation dramatically. Further, following a process of diffusion, these consumers do not operate in isolation; they imitate and are otherwise influenced by the early consumers described next.

Early markets: Experimenters and moral/social choosers

Early AFV consumers face not only heightened choice complexity, but also uncertainty and novelty. Further, their vehicle purchases are motivated in unique ways.

Many AFV attributes are likely to be new and to significantly change with time as the vehicle technology matures. As discussed by previously reviewed reports, this presents many problems for traditional rational choice models. Novel attributes are not represented in market data for conventional vehicles and thus their evaluation requires collection of stated-preference data, with all the hazards associated with collection and analysis of hypothetical responses. Further, the dynamics of developing markets make it less likely that consumers are fully informed, or that their tastes are established and stable. For this reason, the authors call upon Wilde's distinction between attributes that can be evaluated while searching for a vehicle and those that have to be experienced after

the purchase during use. Taken further, even the pre-purchase decision can be described in stages. Information access and sources are an important aspect of diffusion models, and vary through these stages of early consumer evaluation. For example, referring to Kurani [52], the authors note that CNG consumers in New Zealand and Canada were "using distinct sources and types of information, and evaluating different sets of attributes depending upon where in the decision process model they were located," (p. 215).

Further, following diffusion theory, the authors also highlight the importance of evaluation of new technologies by earlier consumers and their influential roles as sources of information and models for imitation.⁶²

Experimenters. This group coincides most closely with the one-dimensional "innovator"/"early adopter" group in diffusion-of-innovation theories. Inclined to experiment in general, or with the product in particular, these consumers tolerate the unrefined nature of the product in its early incarnations. They may share characteristics and motivations with, or be distinct from, the other posited early consumer group: social choosers.

Social choosers. Incorporating consumers that challenge the definition of classical economic actors, the group of social choosers includes environmentalists, public figures,

⁶² although they de-emphasize this role in later AFV markets: "Alternative fueled vehicles are not an entirely new product or superior; they are a mixture of innovative, familiar and even inferior attributes. Also, DOI [diffusion-of-innovation] studies overemphasize the role of imitation for post-innovation segments of the market," (p. 217).

and others with moral, prestige, image, and/or symbolic motivations. Environmentalists, for example, with concerns for market externalities, are often faced with sub-optimal choices, and may, according to Hirschman, “shift from personal utility generated preferences ranking to meta-preferences, or ideal preference rankings if they become sufficiently dissatisfied with private consumption. ... Uusitalo suggests that "green" markets may develop from [these social conditions]," (p. 218). Other examples of social motivations center around prestige: "As scarce, symbolic goods, they are likely to be appropriated by wealthy and public personalities as positional goods," (p. 219). Whatever the motivation, the authors note, “the market for AFVs will not be driven entirely by technology and prior preferences," (p. 219).

Model dynamics

Unlike the simpler approaches, the authors suggest that a comprehensive approach, coordinating consumer choice, diffusion, and social choice, must view the AFV market "as a diversified and dynamic process, so that different approaches apply to distinct choice contexts, consumers and phases..." (p. 219). Using the actors described above, one such dynamic sequence is the following:

- initial experimentation by experimenters and positional consumers with sufficient resources; autonomous decisions made by consumers with preferences shifted by dissatisfaction and social concerns
- followed by intermediate imitation by green consumers with close affiliations
- followed by combined hierarchical-compensatory judgments in the later stages of AFV market development.

Finally, the authors comment on the implications of the synthetic approach taken towards the construction of their AFV adoption model. Although the complexity of the model

precludes forecasting and suggests a more exploratory research approach (in contrast to specific market predictions), the authors argue that it is a good compromise between theoretical clarity and properly embracing the real complexity of AFV markets and consumers.

Moore, G. A. (1999). *Crossing the Chasm: Marketing and Selling High-Tech Products to Mainstream Customers*. New York, HarperBusiness. [41]

Crossing the Chasm, by ex-professor-turned-successful-marketing-executive-and-author Geoffrey Moore, is a guide through the process of marketing innovative high-tech products through the technology adoption life cycle. Developed with experience largely in the computer and software industry, its 223 pages contain many important lessons about technological innovation and strategic marketing—the latter which Moore defines in contrast to sales as the creation and maintenance of markets. Here, the focus will largely be on Moore’s conceptual adaptations of the standard technological diffusion process, with an eye towards integration of the various theories and models in this section of the literature review.

The backbone holding together Moore’s detailed discussions and strategies is a modified version of the diffusion-of-innovation technology lifecycle. By adding “Cracks in the Bell Curve” (p. 17) to the standard progression of innovators, early adopters, early majority, late majority, and laggards, Moore highlights the differences between any two

of these “psychographic”⁶³ groups: “This symbolizes the dissociation between the two groups—that is, the difficulty any group will have in accepting a new product if it is presented in the same way as it was to the group to its immediate left,” (p. 17). The most important crack or discontinuity in Moore’s Revised Technological Adoption Life Cycle curve, however, is the second one: “No, the real news is the deep and dividing *chasm* that separates the early adopters from the early majority. This is by far the most formidable and unforgiving transition in the Technology Adoption Life Cycle, and it is all the more dangerous because it typically goes unrecognized,” (p. 20). Many high-tech innovations and companies have fallen into the chasm, never to make it to the profitable early majority.

The principal reason for Moore’s chasm is the fact that early adopters of a technology are purchasing the technology as a change agent, whereas consumers in the early majority are much more pragmatic and seek productivity improvements (p. 21). This difference in orientation is particularly problematic, Moore tells us, for two important compounding reasons (p. 21): 1) “early adopters do not make good references for the early majority,” and 2) good references are critical to help the early majority overcome their concerns about disrupting their current practices and adopt the new technology. As the title implies, most of the book is organized around recognizing, planning for, and implementing the transition across the chasm between the early adopters and early majority.

⁶³ Psychographics are the combined psychological and demographic characteristics of a

One element of the strategies discussed in the book relevant to discussions of strategic niche marketing is the use of a targeted beachhead market in the early majority. Like a well-managed strategic niche, this beachhead is receptive (perhaps more forgiving) to the innovation, is designed appropriately to properly nurture the innovation with resources, and acts as the first set of pragmatist-credible references for the innovation. As argued in *The Innovator's Dilemma*, next, targeting a beachhead is a process of thinking small—in order to become a big fish in a little pond—just when successes in early markets might tempt companies to think big.

Christensen, C. M. (2000). *The Innovator's Dilemma: The Revolutionary National Bestseller that Changed the Way We Do Business*. New York, HarperBusiness. [42]

Another popular guide to innovation is Harvard professor Clayton Christensen's *The Innovator's Dilemma*. In it, Christensen describes a dynamic whereby the world's best companies, in the process of serving existing customers with skill and following the best of business practices, can nevertheless suffer critical losses when faced with "disruptive" technologies and market-structure changes. Using as a cornerstone of his argument case studies such as the hard disk drive industry, Christensen illustrates how innovative technologies that appear inferior on the dimensions valued by current customers in current markets can, when given a foothold in other markets with different priorities, demonstrate rates of improvement that make them competitive in the market for which

set of consumers.

they had been deemed unsuitable by normal business practices. Further, distracted by listening to their existing customers—normally the key to improving *sustaining* technologies—suppliers of the old dominant technology may not recognize the threat of the *disruptive* technology far enough in advance to react successfully.

Three important elements contribute to this “failure” dynamic facing otherwise successful businesses. The first is this distinction between sustaining and disruptive technologies. Sustaining technologies, as defined by Christensen, “improve the performance of established products, along the dimensions of performance that mainstream customers in major markets have historically valued,” (p. xv). On the other hand, disruptive technologies offer new value propositions that, generally, “a few fringe (and generally new) customers value,” (p. xv). Frequently, Christensen notes, these products “underperform established products in mainstream markets” (p. xv), at least initially.

The second element contributing to the failure dynamic is the pace of technological progress; disruptive technologies, if nurtured in other markets, do improve, often at pace that soon makes them more broadly competitive. Meanwhile, improvements in sustaining technologies can sometimes outstrip market demand, giving continual improvement efforts along those performance dimensions diminishing returns. This relativism of (dynamic) product performance to market value makes for a subtler maxim than “more is (always) better.”

The third element has faint echoes to Sperling's [7] discussion of the contextual importance of prices. Unlike Sperling's attention to the fundamental societal values, structures, and institutions that determine product worth, Christensen's unit of analysis is more modest: the market. Finding value for the disruptive technology takes a suspension of disbelief that leads to seemingly irrational financial decisions: disruptive technologies, according to Christensen, "generally promise lower margins," "are first commercialized in emerging or insignificant markets," and are not wanted, indeed are unusable by "leading firms' most profitable customers," (p. xvii).

The key to avoiding this damaging business dynamic, argues Christensen, is perhaps counterintuitive: "There are times at which it is right *not* to listen to customers, right to invest in developing lower-performance products that promise *lower* margins, and right to aggressively pursue small, rather than substantial, markets," (p. xii). This advice, which partly echoes some of the strategies in *Crossing the Chasm* with certain key differences, presents an interesting backdrop to the discussion of vehicle attributes, such as AFV range. As proposed by Kurani, Sperling et al. [36], the arguments in the *Innovator's Dilemma* make us question if there might be such a thing as too much range, even at less-than-conventional levels, for a given market circumstance facing a nascent disruptive technology. Finding a beachhead or strategic niche market that desires the new value proposition of a disruptive technology (e.g., a H₂FCV with innovative attributes such as V2G power provision), and for which currently affordable AFV range is adequate, would give the technology a foothold, allowing subsequent improvements that could lead to competitiveness back in the large, profitable mainstream markets.

Christensen explicitly discusses battery EVs, but in a different way and does not appear to have “gotten it right.” Indeed, the applicability of such theories to high-barrier-to-entry, capital intensive, and relatively homogenous automotive markets is not straightforward. Nevertheless, several important themes remain that are worth further exploring in the context of H₂FCV commercialization.

Hargadon, A. (2003). *How Breakthroughs Happen: The Surprising Truth About How Companies Innovate*. Boston MA, Harvard Business School Press. [33]

In *How Breakthrough Happen*, Hargadon draws on in-depth examinations of historical examples of technology transitions and other forms of innovation—ranging from famous “inventions” by Ford and Edison to the musical inspirations of Elvis, the distinct styles of Apple and Microsoft, and the development of super-soaker squirt guns—to form the basis of a “recombinant” theory of the innovation process and a set of principles to guide to organizations wishing to foster communities that effectively nurture and implement “new” ideas.

Contrary to popular mythology, which is itself sometimes encouraged by the innovators themselves, much of Hargadon’s effort goes toward convincing the reader that innovations—those that are being implemented successfully and creating change in the world—tend not to be “inventions” or “new” ideas at all. Rather, recombinant innovation theory states, successful innovations tend to be novel solutions imported from other

contexts and artfully adapted and applied to problems in a different context. Recombinant innovation theory thus draws attention to the complex pedigree of previous thought and practice that comes together in the right place and time to successfully provide value.

Using case-study research, *How Breakthroughs Happen* takes aim at two of the most famous “inventors”: Henry Ford and Thomas Edison. Debunking the “lone genius” myth of invention, Hargadon emphasizes the communities these figures built up around them to support their biggest accomplishments. For example, Ford’s implementation of the assembly line drew upon three important elements existing in elsewhere in industry at the time. Perhaps most notably was the inspiration Ford drew from industrial slaughterhouses (meat “disassembly lines”: cows in, steaks out) and his direct importation of key figures from that industry to executive positions in his own. Like Ford’s assembly line, those innovations that draw upon the wealth of knowledge embodied in existing and proven supply chains face few development problems, shorter lead times, and are more likely to be implemented quickly and successfully. In contrast, novel solutions lacking proven application or strong communities can require decades of development or stalled implementation. Something as simple as the zipper, for example, took 20 years after it was invented before it was implemented widely in clothing.

Actors like Ford who recognize solutions in contexts often vastly different than their own experience and work to import and exploit them by bridging the two “distant worlds”⁶⁴

⁶⁴ Separate or distant worlds are defined here in a social context by network theory: communities of people who know and interact with each other, but not those in the other

are characterized as critically important “technology brokers.” *How Breakthroughs Happen* therefore shifts the attention of hopeful R&D managers from supporting free-from invention to the recombination of existing technologies in novel ways for targeted application.

Another important emphasis of the book is placed upon the nature and role of building effective communities around innovations to ensure their successful implementation. A striking example is that of Farnsworth, who is credited with having invented the television but who held his achievements so close to his vest that he failed to gain the support he needed commercialize his ideas, allowing RCA to “eat his lunch.” *How Breakthroughs Happen* thus draws attention to the perils of “going it alone” and attempts to rebalance expectations about the tradeoffs between protecting intellectual property and fostering effective support in the early stages of technological development.

A final theme of the book centers around the concept of robust design, where design is defined broadly as the specific details and contexts that define the consumer’s interaction with the innovation, i.e., its particular embodiment in a given application context. The importance of the specific embodiment of a technology to the success of a technology resonates with the experience of [44]. Often overlooked or underestimated by the original proponents of a new technology—who intimately know and appreciate the full, wide-ranging potential of a concept—the specific, often partial or compromised, design developed for initial commercialization can have as much to do with the success or

“world”/industry/social network, thereby reducing the level of communication and the

failure of an innovation. Of particular importance are choices surrounding which aspects of new technology to emphasize as novel (thus presumably articulating the product's new value proposition), and which aspects to disguise in "conventional" interface to the consumer (to provide reassuring familiarity, thereby increasing the likelihood of acceptance). In one counterintuitive but illustrative example described by Hargadon was Edison's literal and figurative dimming of his electric-light technology and supporting infrastructure to fit them into the familiar gas-light paradigm of the time.

ICCEPT and E4tech Consulting (2003). "The UK Innovation Systems for New and Renewable Energy Technologies" A report to the DTI Renewable Energy Development & Deployment Team. London, Imperial College London Centre for Energy Policy and Technology (ICCEPT) & E4tech Consulting: 128. [8]

In a report on primarily on renewable energy for the United Kingdom's Department of Trade and Industry, researchers at the Imperial College London and E4tech Consulting provide context for their work by summarizing the process of innovation from the international literature, providing a useful summary framework. They define innovation broadly "to include all the stages and activities required to exploit new ideas, develop new and improved products, and deliver them to end users," (iii). This process is broken down into five stages of activities: basic and applied R&D, demonstration, pre-commercial, supported commercial, and commercial. As the network of actors involved

likelihood of "cross-pollination" of ideas between the groups.

in the development of a given innovation move through these stages, funds, knowledge and information flow between them, leading to iterative development “both within and between stages,” (p. iii).

As with Sperling [7], the authors here note that, although the need for governmental support decreases as the innovation is commercialized, getting to that point takes clear, consistent signals: “Innovation succeeds through the ‘perseverance’ of innovators, and perseverance is also required in policy,” (p. v).

Farrell, A. E., D. W. Keith, et al. (2003). "A strategy for introducing hydrogen into transportation." *Energy Policy* **31**(13): 1357-1367. [63]

To conclude this literature review of innovation, I examine one of the few papers that explicitly applies marketing and innovation principles to the introduction of hydrogen vehicle technology, “A strategy for introducing hydrogen into transportation.” Although Farrell, Keith, et al. advocate the use of heavy-duty-freight markets, in particular marine-freight markets, for hydrogen introduction (which cannot be fully addressed in the course of this dissertation work focusing on light-duty passenger vehicles), they articulate several important features of what I’ve referred to as strategic niche marketing. The following is an overview of the first four sections of the authors’ major points (sometimes reworked into terms this author finds more palatable). The fifth section of the paper

essentially “applies” the “theory” of the first four sections to the case of marine/freight and will be given less attention here.

Factors favoring the effective introduction of hydrogen

“Our analysis suggests that cost of introducing hydrogen can be reduced by selecting a mode that uses a small number of relatively large vehicles that are operated by professional crews along a limited number of point-to-point routes or within a small geographic area,” (p. 1—note page numbers here are from the in-press proof). Largely based on assertion, the analysis in this paper nonetheless raises many factors worth considering that challenge the usual assumptions of high-volume light-duty-vehicle manufacturing. By limiting the scope and concentrating the demand placed on vehicles, Farrell, Keith et al. hope to contain the challenges of introducing a new fuel, while aggregating volume and learning onto relatively few vehicles. Later, they also note that heavily utilized vehicles depreciate capital costs more quickly. Further, they make similar arguments for hydrogen infrastructure in hopes of keeping the chicken-and-egg hurdle to a surmountable level. They suggest refueling station cost can be minimized by: making stations larger, close to the point of hydrogen production, intensively utilized, and few in number (by either: covering a small geographic area, placing along well-defined routes, or associating them with commercial fleets with centralized refueling or small systems of “key-lock” stations), (p. 6). The first set of questions raised by these factors has to do with cost functions. There other ways to reduce vehicle and infrastructure costs than “fewer, larger”, such as by spreading cost over volume. Explicitly constructing and

discussing such factors that go into generic cost functions might help illuminate the different opportunities.

The next set of suggestions concern the speed of innovation and environmental impact. The authors suggest that vehicle innovation is maximized “where individual vehicles are produced to order and each receives significant engineering attention (not those manufactured in vast quantities on assembly lines),” (p. 1). Rather than suggesting that automotive components do not receive significant engineering attention before being put on the assembly line, perhaps the authors are highlighting, as they do elsewhere and as does ICCEPT & E4tech [8], the importance of early demonstration, which captures the benefits of learning-by-doing.

As to environmental impact, the authors note the opportunity to use hydrogen in modes that are currently less stringently regulated (and therefore presumably more polluting). This too is an interesting opportunity (but also relative to the extent to which regulation of that mode is missing or overdue and not simply a low priority⁶⁵). The counterargument to the authors’ point here, however, would be that stringent regulation fuels a willingness-to-pay for clean technologies (which provide public goods / positive externalities) that would not otherwise be valued by private parties. As pointed out by the authors elsewhere, identifying lead adopters with relatively high levels of willingness-to-pay is an important aspect of finding suitable niches.

Mode as niche, tolerating hydrogen's weaknesses, and the virtuous cycle of learning-by-doing

The authors' choice of mode-defined niches, however, appears to be driven by cost reduction, not increased willingness-to-pay: "One way to reduce the cost of the introduction of hydrogen is to limit to a single mode," (p. 5). This, they argue, will build momentum behind competitive forces that will reduce costs and improve performance "before risking broader disruptions of the transportation system." As discussed in the review of *The Innovator's Dilemma* and *Crossing the Chasm*, growing a big fish in a small pond is an established marketing strategy. However, two complications arise from the choice of mode as niche. Firstly, it is unclear whether segmentation by mode should be done at the exclusion of other niches, as the authors sometimes appear to be arguing. What, exactly, are the risks of "broader disruption"? One example might be stranded investment, but what else? Arguing for one niche is different than arguing against—i.e., to the exclusion of—others. The paper does a more convincing job of the former than the latter.

Secondly, competitive forces may act within a mode, but to what end? Will subsequent niches necessarily be helped? For example, does combusting hydrogen on boats using conventional storage technology necessarily help LD fuel-cell cars with critical storage issues? Noting the significant storage and other challenges facing hydrogen LDVs, the authors argue for introduction in vehicles that are less volume-constrained, and whose cargo mass eclipses the marginal weight penalties of new hydrogen technologies.

⁶⁵ Similarly, the authors note that most research focuses on LDVs, disproportionately so relative to the LDV share of energy use.

However, this tolerance “cuts both ways...[it] will also reduce the incentive for the development of better storage technologies,” (p. 6). This begs a broader set questions not addressed by the authors: in what ways does improvement in a technology for one application transfer to other applications? In what ways does it not?

Nevertheless, the niche approach, whether defined by mode, function, or other criteria is aimed at unlocking what the authors refer to as the virtuous cycle of learning-by-doing: experience drives down costs, opening up larger markets, encouraging further investment, yielding greater experience. Ideally, this self-reinforcing cycle of learning and market expansion would conveniently connect various modes, allowing, say, fuel-cell costs to slide down an experience curve through the various niches, as simplistically presented for illustration by Williams and Finkelor [11]. However, there are, of course, no guarantees that, for example, fuel cell use in buildings would build volumes and cut costs sufficiently to allow their use in heavy-duty freight, and so on until they were competitive for LDVs.

Strategic Niche Management and Other Policy Considerations

One way to overcome such uncertainties would involve government involvement in the strategic niche marketing process. Referring to Kemp et al. (1998), the authors highlight the opportunity for government to induce the testing and improvement of technologies in a small set of applications before diffusing to larger applications (p. 4). However, they note elsewhere both the difficulty governments often have picking technological winners, as well as their inconsistent policy commitment (e.g., as evidenced by the decision not to

enforce EPA Act). Technology forcing is politically difficult and often inefficient. Further, inducing technological learning in a given niche, thereby requiring it to bear many of the costs of technological development, would likely require compensatory measures such as subsidies.

Another barrier to innovation that could be addressed by policy is the composite-good nature of fuel/vehicle combinations. This characteristic creates “network effects” (e.g., need for coordinated investment), which the authors believe are not adequately addressed by current US research programs.

Despite the discussion of various forms of policy interventions that would help the transition to a new fuel, it is worth noting that the authors are by no means convinced of the merits of supporting hydrogen, particularly relative to other alternative fuels. In a telling footnote, they describe themselves as skeptical, “but not so skeptical as to write off hydrogen fuel research as irrelevant,” (p. 4). Implicit in the authors’ arguments about hydrogen is the notion that investment in, and implementation of, hydrogen technologies in light-duty vehicles (LDVs) run the risk of being too much, too soon. Although irresponsible investment and unrealistic expectations are clearly a concern, the specific nature of these risks not directly elaborated here.⁶⁶ For example, what, specifically,

⁶⁶ One possible exception is the authors’ characterization of energy technology systems as “very long-lived, capital intensive, and hav[ing] enormous economies of scale,” intensifying the importance of early decisions (Antonelli 1997; Gritsevskiy and Nakicenovic 2000), a phenomenon described as “path dependence,” (p. 5).

defines the “too soon” aspects of the authors’ concern about “early introduction” (p. 1) of hydrogen-fueled LDVs?⁶⁷

In closing, the authors present many meaty issues to consider. Further questions undoubtedly need to be answered to make any definitive conclusions. For example, what are the profit margins on ships and freight trucks vs. passenger vehicles? More generally, what will drive investment in hydrogen technologies? Optimum strategies identified by rational techno-economic arguments are sometimes eclipsed by consumer-demand, political-promise, and other factors. For example, why not discuss hydrogen fuel cells in buildings first? In buses? Both of these applications “came first,” and, based on techno-economic arguments, probably should be implemented before many others. Yet they have been eclipsed by the “sexy” application of hydrogen and fuel cells in cars and trucks (and in consumer electronics). Identifying the components of “sex appeal”—to consumers, to producers, to politicians, and to investors—would help supplement compelling arguments for hydrogen use in various contexts, such as those presented by Farrell, Keith, et al., with the knowledge of which of those contexts provide the most traction for hydrogen commercialization.

7.3.4 *Vehicle-to-grid power*

Discussed conceptually last decade for H₂FCVs [28] and developed in considerable detail this decade [9, 10, 30], V2G power is an intriguing opportunity to employ the idle vehicle

⁶⁷ Depending on what the specific issues being considered are, the counterargument might be derived from the Chinese proverb that asks: When is the best time to plant a tree? Answer: 20 years ago. When is the second-best time? Now.

engine capacity of parked cars to support the complex operation of the electrical grid while simultaneously providing supplemental revenue to vehicle owners and fleet operators.

Williams, B. D., T. C. Moore, et al. (1997). "Speeding the Transition: Designing a Fuel-Cell Hypercar." 8th Annual U.S. Hydrogen Meeting, Alexandria VA, National Hydrogen Association. [28]⁶⁸

"Speeding the Transition: Designing a Fuel-Cell Hypercar" describes mobile power conceptually in the context of commercializing hydrogen-fuel-cell vehicles (H₂FCVs) using whole-systems optimization of vehicle design. The paper, primarily a H₂FCV fuel-economy and performance modeling report, describes opportunities to introduce fuel cells into vehicles earlier using efficient and low-tractive-load vehicle platforms incorporating low-drag, advanced-composite autobody design. The process of commercializing fuel cells in various applications, starting with buildings, is described using a fuel-cell experience curve that plots fuel-cell cost in dollars per kilowatt versus doublings in production volume along a 82% progress ratio (i.e., with each doubling of

⁶⁸ Lovins and Williams (1999) present similar arguments with respect to V2G, and will not be treated separately here. One notable development was the further articulation of what became to be known as the energy-station concept: using a single, stationary reformer to produce hydrogen for both a stationary fuel cell and vehicle refueling, thereby increasing the capacity factor of the reformer and diversifying the use of its output to include high-value automotive fuel. These, and other integrative/"whole-systems" opportunities tended to be the aspects of this work covered by others (e.g., *Public Utilities Fortnightly* and [6] J. Rifkin, *The Hydrogen Economy*. New York: Tarcher-Putnam, 2002.)

production, fuel-cell cost is assumed to fall by roughly 20%, typical of many technologies [74].

Although this depiction of fuel-cell commercialization plots two different fuel-cell applications with dramatically different mission requirements, balance-of-plant issues, etc. — and therefore cost structures — on the same curve, it is meant to be illustrative of the commercialization process. Interestingly, and perhaps not coincidentally, this particular representation from “Speeding the Transition” speaks to the blurring of stationary and transportation design requirements for fuel cells that are part and parcel of the V2G power concept. And, as discussed by Lipman, Edwards, et al. (2002), assumptions about, for example, fuel-cell refurbishment costs resulting from use of vehicular fuel cells for V2G power, are a critical sensitivity for the evaluation of the concept’s attractiveness.

“Speeding the Transition,” however, focuses more on the opportunities represented by the fuel-cell V2G approach than the details of implementation, which were being simultaneously examined for battery EVs by others such as Kempton (see below).

Integrative at the time in its coverage of both electrical-grid as well H₂FCV-commercialization issues, the paper explicitly addresses opportunities in both and carries the discussion through to a brief discussion of mobile-power opportunities, starting from the top level. It highlights the magnitude of idle generation capacity embodied in a fleet of 150 million U.S. cars relative to the size of the nation’s utilities; the advantages of largely paying for H₂FCVs for one purpose but using them for another; the potential supplemental revenue streams this might represent, thereby motivating vehicle owners

and entrepreneurs; and it begins to describe the mechanics of how and where such vehicles might be connected to the necessary gas and electric infrastructure. Further, and importantly, it describes this process not simply from a mechanical “how-to” prospective, but—drawing on Lovins’s multi-decade experience working with utilities—begins to frame the opportunity in utility terms typically unfamiliar to vehicle technologists at the time. It thereby begins to bridge and broker technologies between previously “distant” industries in a manner consistent with Hargadon’s theories on innovation, discussed in the previous section. For example, rather than limiting its discussion to simple power pricing, it invokes complex yet important issues associated with distributing electricity and managing the grid, highlighting the importance of so-called “distributed benefits” [[75], and, subsequently, [31]]. Finally, it notes the implications of the V2G approach to utility planning, which, with respect to AFVs, was largely expected to sell, not buy, power from battery EVs.

Kempton, W., J. Tomic, et al. (2001). “Vehicle-to-Grid Power: Battery, Hybrid, and Fuel Cell Vehicles as Resources for Distributed Electric Power in California.” Davis CA, University of California at Davis: 78. [9]⁶⁹

69

[12] S. Letendre and W. Kempton, "The V2G Concept: A New Model For Power?" *Public Utilities Fortnightly*, pp. 26, 2002. is largely a repackaging of Kempton, Tomic, et al. (2001) to make it more accessible for publication and will not be treated separately here.

Building on a heritage of previous investigation into renewable-energy and stationary battery systems that lead to detailed examinations of battery-EV grid power in the 1990s (e.g., [76]), Kempton et al. (2001) expands the scope of those investigations to include a greater emphasis on hybrid- and fuel-cell-vehicle V2G. “Vehicle-to-Grid Power...” makes a compelling if preliminary case for the value and importance of V2G power. In addition to detailed discussions of V2G interfaces and infrastructure, the report estimates the value of V2G power for the three vehicle types using California data for three V2G-power services (peak power supply, spinning reserves, and regulation). It establishes the value of providing these services could be several thousand dollars per year (p. 1), net of many of the costs associated with running and connecting the vehicles in this way. It also highlights the importance of implementing such a strategy by describing the operational challenges of the grid and the “behind-the-scenes” markets that have been set up to address these challenges in which V2G-capable vehicles might compete. Further, it speaks the appropriateness of implementing this complex and often counterintuitive strategy.

Is V2G Power Really Appropriate?

To mix a few metaphors, the more you get to know V2G power, the more you might like it; but it is certainly an acquired taste, not love-at-first-sight for most. Thus, following Kempton et al.’s lead, certain unavoidable questions must be answered, at least in part, before proceeding with the details.

Air quality and efficiency. “Vehicle-to-Grid Power...” describes three reasons why running cars, albeit advanced-technology cars, could actually help, not hurt, air quality under certain circumstances (p. 1):

- 1) Offering prospective AFV owners the potential for revenue generation could drive the adoption of these clean-vehicle technologies.
- 2) The grid services examined for provision by advanced vehicles are not clean or remote baseload power; often peaking or emergency plants are dirty and locating in population centers
- 3) One of the major hurdles to the use of renewable energy is the lack of storage for these intermittent resources. Adding thousands of dispatchable vehicle resources to the grid would help overcome this and lower the cost of using renewable energy.

The air-quality case, strengthened by arguments in the next report discussed (Brooks and Gage 2001), is nonetheless a complex web of variations in the temporal, spatial, and sectoral levels and distributions of emissions from various forms of electrical generation and storage. Similarly, issues of efficiency are equally, if not more, complex, and require additional considerations, such as the location of generation relative to distribution losses, the overall level of end-use services provided, etc.

Vehicle availability and operation. Although it is clear that we only use our vehicles during a small portion of the day, is not the afternoon/evening commute a particularly demanding time on the grid? The authors address this problem using travel data that indicates “Although it may be difficult to imagine when stuck in traffic at 5 pm on a LA freeway, actually no more than 10% of the vehicles are on the road at 5pm,” (p. 7).

Another important issue highlighted in the first section of the literature review was the issue of AFV range. Particularly a problem for battery-EVs, the authors have developed,

again informed by travel data, a strategy for communicating with the grid the timing and maximum-allowable extent of power draw the vehicle owner is willing to provide. Less critical for vehicles like hybrids and fuel-cell vehicles, which can be rapidly refueled, the relationship between vehicle range, refueling, and V2G power provision is perhaps even more interesting, particularly for H₂FCVs. These issues are discussed in further detail in chapters 2 and 3. However, the simple conclusion to draw from this report is that the most likely (and profitable) configuration for V2G-capable H₂FCVs is to run them in a mode analogous to a generator, whereby fuel is available as part of the V2G hook-up and continually feed to the vehicle as needed, thus avoiding the need to draw down the level of the vehicles' fuel tanks.

Grid Operation and “Behind-the-Scenes” Markets

The three electricity markets considered in this report (in contrast to “customer-side-of-the-meter” benefits, which are also discussed) are for peak power and two ancillary grid services, spinning reserves and regulation.

Peak power. Typically needed only several hundred hours per year (p. 4), for example on the hottest afternoons when cooling loads are exceptionally high, peaking power plants are used to meet electrical demand in excess of baseload capacity. Because of this plants technically and economically capable of being turned on and off are employed. Low-capital-cost plants are preferred because peaking plants “have fewer kWhs to amortize the investment over,” (p. 4).

Ancillary services.

In addition to the purchase of kilowatt-hours (kWh) of generated energy, grid operators buy various services to maintain the reliability and quality of grid power. “In California, ancillary services are purchased through a market that is run by the Independent System Operator (ISO)...” (p. 4). In addition to regular contracts, the ISO procures ancillary services in day-ahead and hour-ahead markets. The two services found to be most relevant by Kempton et al. are spinning reserves and regulation.

Spinning reserves. The ISO procures spinning-reserve services to “arrest the decay of system frequency when there is a sudden loss of another resource on the system,” (p. 5).

This additional generating capacity must be available to provide power precisely synchronized with the grid within ten minutes of a dispatch request. “Spinning” thus refers to the generator capacity that is up and running, but not currently supplying power to the grid, such as the excess capacity of a generator regularly operating at part capacity. Spinning reserves earn two forms of revenue. The first is a function of the capacity available multiplied by the time it is hired to be available to provide synchronized power within ten minutes. Secondly, spinning reserves are paid for the actual energy they do end up supplying if and when they are dispatched. Thus, spinning reserves present an interesting opportunity for H₂FCVs to earn revenue without being required to generate electricity for much of the time for which they are contracted to provide this service.

Regulation. “Regulation represents contracts for power generation that are under direct real-time control of the ISO for increasing or decreasing output” in order to maintain the

frequency of the grid at as close to 60 Hz as possible (p. 5). Contracts for increasing power (“regulation up”) and decreasing or drawing power (“regulation down”) are auctioned separately and billed on a per megawatt (MW) rate for each hour of regulation. The authors note that battery EVs “may be extremely well suited to perform in this market because: 1) they can respond very quickly to regulation signals, 2) they can perform both regulation up (V2G) and regulation down (charging), and 3) regulation up and down (combined) causes very little net discharge of batteries,” (p. 5). The authors do not find the potential benefits for H₂FCVs and hybrids to be as large as for battery EVs in their estimation of the revenues from regulation. However, it should be noted that extra-vehicular configurations for regulation-down loads (e.g., electrolysis) were not explored.⁷⁰

Demand charges. In addition to the sale of peak power and ancillary services, V2G power could be used on the customer side of the meter. Among the benefits of doing this is the opportunity for commercial and industrial customers to avoid demand charges. In addition to energy charges for each kWh of energy consumed, commercial and industrial power consumers are required to pay demand charges to compensate “the distribution company for expenses incurred by having to upgrade lines and transformers to handle the maximum, and for adjusting to fluctuation in load,” (p. 18). Demand charges are billed based on the largest power flow (in kW) sustained over a 15-minute period each month.

⁷⁰ Nor do I understand the regulatory guidelines for providing regulation-down services that prevent standard electrical loads from *getting paid* to consume electricity. Presumably this is not a major problem, in part, simply because the loads would have to be under direct control of the ISO (which would not necessarily pose a problem for facilities available for opportunistic electrolysis).

The V2G Interface and Infrastructure

The mechanics of H₂FCV V2G involve three connections: 1) for electrical power flow, 2) for communications (for control and billing by the grid operator, ISO, and/or third-party aggregator, with the possible addition of on-board metering as V2G power becomes more widespread), and 3) for hydrogen fuel.

AC Propulsion has already demonstrated the electrical power connection and control for a battery EV. Indeed, “On-board conductive charging allows V2G flow with little or no modification to the charging station and no modification to the cables or connectors, assuming on-board power electronics designed for that purpose,” (p. 10). Thus, for example, a 16.6kW⁷¹, 100A Level 3 AC charger designed for public battery EV charging could be used, and only the H₂FCV systems would have to be modified, at little incremental cost if designed from the start. The authors estimate the charger would sell for \$1–2k in moderate volumes. In the longer run, higher capacity connections could be made available to take full advantage of H₂FCV output. The authors note that it is probably not practical to run a 16.6kW connector from a residence to street parking: “Thus, we limit our home connection considerations to vehicle owners who either park in a home garage or who park in driveways adjacent to their house,” (p. 11).

⁷¹ In comparison, the authors note that a household range is 40A and 9.6kW.

For billing and communications, the authors discuss on-board metering with telematics, at a capital cost of less than \$50 per vehicle if designed from the start for the meter.⁷²

However, in earlier stages of V2G rollout, I suggest in chapter 4 that aggregating these services to the parking lot level may be beneficial.

For the fuel connector, two important considerations are 1) whether and how vehicle refueling might be accomplished using V2G hardware, and 2) gas venting in enclosed structures such as household garages.

Generating Value: the Potential Benefits of V2G Power

Vehicle costs. Assuming, among other things, vehicle specifications consistent with the Ford Prodigy P2000 fuel-cell vehicle fed hydrogen by a stationary reformer reforming natural gas to produce hydrogen at a cost of roughly \$3/kg, the authors estimate H₂FCVs could produce electricity at roughly 19¢/kWh, including equipment degradation (p. 31).

The annualized capital costs for the hardware necessary to make the vehicle V2G-capable is estimated to be roughly \$800 per year (p. 31)

*Customer side of the meter.*⁷³ For residential customers, H₂FCVs “can generally compete with the residential electricity rates on a cost per kWh basis only with some summer time-of-use rates,” (p. 64). For example, one PG&E, and two SoCalEdison, rate schedules had peak summer rates over 30¢/kWh. For commercial and industrial

⁷² The authors assume that much of the non-metering hardware required for V2G communications and control will be put on vehicles for other reasons.

⁷³ Note that emergency backup opportunities were not examined.

customers, H₂FCVs could provide modest savings of a few hundred dollars per from avoided demand charges, assuming relatively low hydrogen costs. (The costs of dispatching the H₂FCV to avoid demand charges were estimated at between \$700 and \$3k per year.)

Electricity markets. The value of V2G power was estimated for each of the three vehicle types using electricity data from 1998–2000 and utility rules-of-thumb. For the H₂FCV case, the net revenues for peak power ranged up to⁷⁴ roughly \$2k per year. Spinning reserves netted the hypothetical H₂FCV between \$400 and \$4700; regulation netted between a \$700 loss and a \$12k gain.

Brooks, A. and T. Gage (2001). “Integration of Electric Drive Vehicles with the Electric Power Grid -- a New Value Stream.” 18th International Electric Vehicle Symposium (EVS-18), Berlin, World Electric Vehicle Association (WEVA). [30]

AC Propulsion, founded by Alan Cocconi of GM Impact/EV1 fame, is a pioneer in battery-EV technology and, in particular, power electronics. They have designed, built, and demonstrated power electronics allowing battery EVs to provide V2G power. This presentation, to the 2001 International Electric Vehicle Symposium in Berlin, includes data from that system—AC Propulsion's second generation AC150 drivetrain acting in

⁷⁴ The worst case is of course when the vehicle modeled is not awarded any sales of peak power in the hypothetical auctions, which happened for a couple of the study years. In these cases, the net revenues are simply losses equal to the costs of V2G power provision.

simulated V2G mode—as well as a good overview of electrical, grid, and aggregation issues. The presentation raises important points in three areas: V2G services, vehicle considerations, and emissions from hybrid-electric vehicles acting as V2G power providers.

V2G Services

In their discussion of the many services V2G vehicles might provide, Brooks and Gage compile a similar, but slightly more comprehensive, list to the issues selected for evaluation by Kempton et al. in 2001, including: mobile AC power outlets, customer-side-of-meter benefits (including backup power, demand-charge shaving, uninterruptible power, and heat generation), and grid-side benefits (peak power generation and ancillary services: spinning reserves, regulation, reactive power, and transmission stabilization).

Further, the authors discuss two important policy issues. First, they highlight the need for a safety system that would detect the loss of grid power, so that V2G vehicles would not continue to charge lines that utility crews or others might otherwise assume are safe. The authors suggest that use of a frequency monitor, which would also facilitate the provision of regulation services. Second, they note the policy implications of V2G power for utility planning, suggesting an evolution towards an open grid with access points for energy "packet" transactions analogous to the internet.

Vehicle Considerations

The presentation also discusses several positive features of V2G power for vehicle operation and design. For one, they highlight the major premise of V2G power, that most of capital cost of the generation capability is paid for when the vehicle is purchased for transportation purposes, leaving V2G to pay only for the incremental costs of connection, operation, and capital degradation/refurbishment.

They also note two features of V2G operation, of particular interest to battery EVs but with important implication for other technologies as well. They find that the V2G cycle is less demanding on the powertrain than driving cycle (e.g., changes in load occur over minutes not seconds, there is relative shallow battery cycling, etc.). Indeed, they note that batteries suffer from degradation even when left on the shelf, making it better in some ways to use the battery productively through its cycle life before you lose its capabilities to its calendar-life limitations.

They further tie the issues facing V2G-capable battery EVs and H₂FCVs by suggesting the possibility of designing range-extender hybrid H₂FCVs (where the fuel-cell acts to charge a large propulsion battery rather than acting as the primary source of tractive power itself) for use while hydrogen infrastructure is scarce. This would allow H₂FCV owners to “fill up” on electrical charge during the V2G session in a manner similar to pure batter-EVs.

Emissions from a V2G Hybrid

A final, perhaps surprising, finding in the presentation relates to the environmental performance of even relatively “near-term” V2G-capable vehicles. To illustrate the possible emissions benefits of V2G power, Brooks and Gage compare steady-state emission data for a Toyota Prius hybrid-electric vehicle at three power levels (~8, 10, and 14 kW). The resulting bagged emissions were quite low. Non-methane-hydrocarbon (NMHC) and, particularly, oxides-of-nitrogen (NO_x) levels measured were significantly below those reported for combined cycle power plants and the Capstone natural-gas microturbine. On the other hand, carbon monoxide (CO) levels were significantly increased relative to the combined-cycle power plant and increased, but in the same ballpark, compared to the Capstone; turbine. Further, the heat-rate efficiency of all three devices were found to be in the same ballpark.

The emissions results in particular are noteworthy. Although increases in CO relative to the stationary generation were found and could be significant in terms of slowing the reduction of this health-threatening compound, CO emissions have responded well to control efforts over the past few decades, arguably making them a relatively minor concern relative to intractable NO_x and increasingly targeted HC emissions, both of which contribute to smog formation.

Brooks and Gage credit the surprising potential of V2G power to reduce some harmful emissions at the generation site to the stringency of automotive emissions regulations and

the economies of volume in automobile manufacture, which make up for some of the scale advantages of dedicated stationary plants.⁷⁵

Lipman, T. E., J. L. Edwards, et al. (2002). “Economic Implications of Net Metering for Stationary and Motor Vehicle Fuel Cell Systems in California.” Berkeley, Renewable and Appropriate Energy Lab (RAEL), Energy and Resources Group, University of California at Berkeley: 70. [10]

“Economic Implications of Net Metering for Stationary and Motor Vehicle Fuel Cell Systems in California” analyzes the costs of stationary and vehicular fuel-cell electricity production for residential (5kW) and office (250kW) applications, focusing on the customer-side-of-the-meter benefits of distributed and vehicle-to-grid (V2G) generation. Costs are analyzed using a detailed Excel/Matlab/Simulink model, called CETEEM (Clean Energy Technology Economic and Emissions Model), which combines several physical and economic submodels.

The report presents several sets of high, medium, and low assumptions used as inputs for detailed modeling for comparison of these systems. Dominant assumptions include: the cost of natural gas, prevailing electricity energy and demand charges, and fuel-cell durability (and associated need for refurbishment).

⁷⁵ These trade-offs between scale and volume economies, automotive and stationary generation, and centralized/remote and distributed/local sources present several

Using only the benefits of displaced energy (residential) or energy and demand charges (office), the authors find that stationary fuel cells, with co-generation of heat, could reasonably be competitive at costs on the order of

- \$1,200/kW (for 5 kW residential settings), producing, for example, electricity ranging from 9.5–16¢/kWh and annual returns net of saved energy charges ranging from savings of \$370 to a loss of \$350⁷⁶; or
- \$700/kW (for office settings), producing, for example, electricity at 5.8-7.2¢/kWh and annual returns net of energy and demand charges ranging from savings of \$28,000 to losses of \$4,000).

On the other hand, for V2G-capable unhybridized H₂FCVs to be competitive on the basis of avoided energy, or energy and demand, charges (and assuming no capture of waste heat), natural gas is needed in the \$4/MMBtu range and stack life in the 10k-hour range. However, other benefits not examined in this report (e.g., emergency back-up, grid services, etc.) might be valuable.

Residential applications of V2G are difficult to justify on this basis (e.g., medium-cost scenarios produce 20–34¢/kWh electricity and yield losses of between \$1,000 and \$1,300). However, reducing the fuel-cell stack to 20kW and hybridizing the vehicles improved the results somewhat (e.g., 16–21¢/kWh electricity and losses of about \$400 per year). The unhybridized vehicles with 75kW stacks suffered from low average efficiency relative to the hybridized vehicles.

interesting policy implications and suggest, should V2G become adopted, that interesting linkages would form between vehicular and stationary emissions regulations.

⁷⁶ Results presented here are for the medium cost case, where the first number represents a load-following configuration and the second net-metering.

Office settings, on the other hand, employing a group of 10 vehicles could be attractive (e.g., the medium-cost case produces 5.8¢/kWh electricity and yields savings between \$1,600 (load-following) and \$2,200 (net-metered) per year). Savings were particularly attractive (\$146,000 per year) if the office setting was able to take advantage of not only net metering but also time-of-use pricing, which the authors note is currently allowed for PV solar.

In general, the authors found that net metering can actually worsen some scenarios by encouraging fuel-cell use at loads in excess efficient operation, although, again, it should be noted that the benefits to the grid (e.g., avoided peaking plant use) are not counted here.

Additional questions and plans for future research identified in the report include: evaluation of grid-side benefits, the use of pure hydrogen (rather than reformat gas) to increase efficiency, estimation of pollutant and emissions performance, and further assessment of various market niches. The authors also suggested that future efforts focus on removing regulatory impediments to reverse power flow from vehicles and on small, low-cost fuel reformers.

Nitta, C. (2003). "System Control and Communication Requirements of a Vehicle-to-Grid (V2G) Network." 20th International Electric Vehicle Symposium (EVS-20), Long Beach CA, Electric Drive Transportation Association (formerly EVAA). [29]

From the perspective of using plug-in hybrid-electric vehicles (plug-in HEVs), Nitta (2003) "provides an initial look at the communication network requirements necessary to control Mobile Distributed Resources," including both wired and wireless systems and their security issues (p. 1). Among the topics he covers for mobile distributed resources (mobile DR, used interchangeably with V2G resources) are:

- the goals of EPRI's Infrastructure Working Council and its Hybrid Electric Vehicle Working Group (IWC-HEVWG), which is studying mobile DR at the vehicle level;
- the relevant NEC, SAE, and IEEE electrical codes;
- communication requirements (signals and frequency, reliability, quality of service);
- communication infrastructure, both wired and wireless;
- security for both the grid-power and billing information

Nitta notes the susceptibility of the public internet to attack from anywhere in world, as illustrated by recent successful server attacks. He highlights the importance of making mobile DR communications systems, which will be similarly dispersed, robust under similar attacks should they occur.

In his comparison between wired and wireless communications systems for mobile DR, Nitta notes that wired systems, requiring physical connections (including ethernet, adapted-charge-pilot-signal, power-line, and ground-up systems) are reliable but

expensive implement extensively. Further, implementing some wired systems would require breaking backwards compatibility. Wireless systems, on the other hand, (including 802.11 and general packet radio service (GPRS)) are not as reliable or secure but require less hardware modification, etc. Threats to wireless systems include tapping into the system for session-hijacking, denial-of-service, and rogue-access attacks. However, tapping into systems in this manner would require the attacker to be relative near to the wireless system.

Topics for future V2G/mobile-DR research identified in the paper include more sophisticated studies of: vehicle availability, communications systems, the additional costs of control and power delivery, and plug-in-HEV feasibility.

7.3.5 Summary of lessons from the literature to be applied in the dissertation research

The literature reviewed describes a turbulent history of AFV commercialization efforts and the high and sustained level of political commitment required to produce the few arguable successes (e.g., ethanol in Brazil, natural gas in New Zealand to a lesser extent, and, by necessity, coal-based distillates in apartheid South Africa [7]). Faced with these realities, H₂FCV commercialization efforts may require a more strategic approach emphasizing consumer value.

One potential source of new vehicle value described in the literature reviewed here is V2G power provision. The previous analyses of V2G power opportunities described here have contributed primarily to the understanding of the “V2G end game”: widely-adopted,

privately-owned light-duty V2G capable vehicles out in-force on our roads (or, more properly, parked in our lots and garages). This has typically been done in one or both of two ways: by estimating the net revenues from representative vehicles given various assumptions about power demands and vehicle costs and availability [10] and/or by envisioning the mechanisms necessary to use and coordinate many such vehicles for grid support [9].

This dissertation builds upon the growing understanding of V2G opportunities described here in several ways. Chapter 2 builds upon previous V2G studies with a refined V2G net-revenue model and by placing V2G power in a framework of Me- technological innovation, thereby exploring many of the issues raised by the AFV literature—such as the potential attractiveness of home refueling/recharging, and the complex relationship between vehicle range and energy storage and consumer uses of vehicular energy.

Chapter 3 builds upon the techniques described in the AFV literature reviewed here (particularly in [34]) that were applied in the mid-1990s by UC Davis researchers to the case of battery EVs to identify, estimate, and characterize a reasonable “*initial market potential*” for V2G and other Me- power in California households. It does this using various constraints identified throughout this literature review to eliminate from consideration households unlikely to adopt Me- electric-drive vehicles. For example, this work constrains its scope by analyzing only opportunities in California, consistent with a spatially segmented approach to alternative-fuel vehicle commercialization [7] and

California's extensive AFV commercialization efforts, many of which have been described in the studies reviewed here.

Additionally, the innovation literature reviewed here heightens awareness of the importance of transitional strategies. Thus, this research also attempts (in chapter 4) to frame the relationship of early household consumers to other major potential V2G opportunities earlier in the commercialization process, thereby describing them in the context of a V2G transitional market path that points toward household use of V2G-capable H₂FCVs. Further, transition issues are explicitly addressed emphasizing the of particular challenges of "getting started" using lessons from the innovation and niche marketing literature to inform 1) a Me- product-development path leveraging existing combustion hybrid technologies, and 2) the creation of initial V2G markets using primarily hybrid vehicles in fleet and other niche applications.

8 References

- [1] M. A. DeLuchi and J. M. Ogden, *Solar-hydrogen fuel-cell vehicles*. Berkeley: University of California Transportation Center University of California, 1993.
- [2] J. M. Ogden and R. H. Williams, *Solar hydrogen: moving beyond fossil fuels*. Washington, D.C.: World Resources Institute, 1989.
- [3] J. S. Cannon, *Harnessing Hydrogen: The Key to Sustainable Transportation*. New York: INFORM, 1995.
- [4] C. E. Thomas, B. D. James, United States. Dept. of Energy, Directed Technologies Inc, and Argonne National Laboratory. Electrochemical Technology Program, "Technology development goals for automotive fuel cell power systems hydrogen vs. methanol: a comparative assessment for fuel cell electric vehicles." Argonne, Ill.: Argonne National Laboratory, 1995.
- [5] A. B. Lovins and B. D. Williams, "A Strategy for the Hydrogen Transition," presented at 10th Annual U.S. Hydrogen Meeting, Vienna VA, 1999.
- [6] J. Rifkin, *The Hydrogen Economy*. New York: Tarcher-Putnam, 2002.
- [7] D. Sperling, *New transportation fuels: a strategic approach to technological change*. Berkeley: University of California Press, 1988.
- [8] ICCEPT and E4tech, "The UK Innovation Systems for New and Renewable Energy Technologies: A report to the DTI Renewable Energy Development & Deployment Team," Imperial College London Centre for Energy Policy and Technology (ICCEPT) & E4tech Consulting for the DTI Renewable Energy Development & Deployment Team, London June 2003.
- [9] W. Kempton, J. Tomic, S. Letendre, A. Brooks, and T. E. Lipman, "Vehicle-to-Grid Power: Battery, Hybrid, and Fuel Cell Vehicles as Resources for Distributed Electric Power in California," University of California at Davis, Davis CA UCD-ITS-RR-01-03, June 2001.
- [10] T. E. Lipman, J. L. Edwards, and D. M. Kammen, "Economic Implications of Net Metering for Stationary and Motor Vehicle Fuel Cell Systems in California," Renewable and Appropriate Energy Lab (RAEL), Energy and Resources Group, University of California at Berkeley, Berkeley 31 January 2002.
- [11] B. D. Williams and B. Finkelor, "Innovative Drivers for Hydrogen-Fuel-Cell-Vehicle Commercialization: Establishing Vehicle-to-Grid Markets," presented at Hydrogen: A Clean Energy Choice (15th Annual U.S. Hydrogen Meeting), Los Angeles CA, 2004.
- [12] S. Letendre and W. Kempton, "The V2G Concept: A New Model For Power?" *Public Utilities Fortnightly*, pp. 26, 2002.
- [13] EPRI, "Advanced Batteries for Electric-Drive Vehicles: a Technology and Cost-Effectiveness Assessment for Battery Electric Vehicles, Power Assist Hybrid Electric Vehicles, and Plug-In Hybrid Electric Vehicles," EPRI, Palo Alto 1009299, May 2004.
- [14] K. S. Kurani, T. S. Turrentine, R. R. Heffner, and C. Congleton, "Prospecting the Future for Hydrogen Fuel Cell Vehicle Markets," in *The Hydrogen Transition*, D.

- Sperling and J. S. Cannon, Eds. Burlington MA: The Academic Press, 2004, pp. 33–58.
- [15] B. D. Williams and K. S. Kurani, "Commercializing light-duty plug-in/plug-out hydrogen-fuel-cell vehicles: "Mobile Electricity" technologies and opportunities," *Journal of Power Sources*, vol. TBD, pp. TBD, 2007.
- [16] B. D. Williams and K. S. Kurani, "Estimating the early household market for light-duty hydrogen-fuel-cell vehicles and other "Mobile Energy" innovations in California: A constraints analysis," *Journal of Power Sources*, vol. 160, pp. 446–453, 2006.
- [17] W. Kempton and J. Tomic, "Vehicle-to-grid power fundamentals: Calculating capacity and net revenue," *Journal of Power Sources*, vol. 144, pp. 268-279, 2005.
- [18] M. A. Delucchi, T. E. Lipman, A. F. Burke, and M. Miller, "Electric and gasoline vehicle lifecycle cost and energy-use model," Institute of Transportation Studies, University of California at Davis, Davis, CA UCD-ITS-RR-99-4, 1999.
- [19] W. Kempton and J. Tomic, "Vehicle-to-grid power implementation: From stabilizing the grid to supporting large-scale renewable energy," *Journal of Power Sources*, vol. 144, pp. 280-294, 2005.
- [20] L. Burns, "Fuel Cell Vehicles and the Hydrogen Economy," presented at Asilomar IV: The Hydrogen Transition, Pacific Grove CA, 2003.
- [21] K. S. Kurani, T. Turrentine, and D. Sperling, "Demand for electric vehicles in hybrid households: an exploratory analysis," *Transport Policy*, vol. 1, pp. 244-256, 1994.
- [22] A. Wei, "Hymotion Unveils Plug-in Hybrid Kits for Toyota and Ford Hybrids," in *Green Car Congress*, 21 February ed, 2006.
- [23] calcars.org, "FACT SHEET: PHEV Conversions (April 20, 2006)," calcars.org/conversions-factsheet.pdf, 2006.
- [24] J. Rosebro, "Toyota Ratchets Up Plug-In Prius Talk," in *Green Car Congress*, 23 April ed, 2006.
- [25] "Toyota to Unveil Prius with Large Auxiliary Power Capability," in *Daily Updates*, 25 February ed: FuelsAndVehicles.com, 2005.
- [26] E. v. Hippel, *Democratizing innovation*. Cambridge, Mass.: MIT Press, 2005.
- [27] "NHTS 2001 Highlights Report," U.S. Department of Transportation Bureau of Transportation Statistics, Washington DC BTS03-05, 2003.
- [28] B. D. Williams, T. C. Moore, and A. B. Lovins, "Speeding the Transition: Designing a Fuel-Cell Hypercar," presented at 8th Annual U.S. Hydrogen Meeting, Alexandria VA, 1997.
- [29] C. Nitta, "System Control and Communication Requirements of a Vehicle-to-Grid (V2G) Network," presented at 20th International Electric Vehicle Symposium (EVS-20), Long Beach CA, 2003.
- [30] A. Brooks and T. Gage, "Integration of Electric Drive Vehicles with the Electric Power Grid -- a New Value Stream," presented at 18th International Electric Vehicle Symposium (EVS-18), Berlin, 2001.
- [31] A. B. Lovins, K. E. Datta, F. Thomas, K. R. Rabago, J. N. Swisher, A. Lehmann, and K. Wicker, "Small Is Profitable: The Hidden Economic Benefits of Making

- Electrical Resources the Right Size," Rocky Mountain Institute, Snowmass CO 2002.
- [32] W. Short and P. Denholm, "A Preliminary Assessment of Plug-In Hybrid Electric Vehicles on Wind Energy Markets," National Renewable Energy Laboratory (NREL), Golden CO NREL/TP-620-39729, April 2006.
- [33] A. Hargadon, *How Breakthroughs Happen: The Surprising Truth About How Companies Innovate*. Boston MA: Harvard Business School Press, 2003.
- [34] K. A. Nesbitt, K. S. Kurani, and M. A. Delucchi, "Home Recharging and Household Electric Vehicle Market: A Near-Term Constraints Analysis," *Transportation Research Record*, pp. 11-19, 1992.
- [35] P. C. Flynn, "Commercializing an alternate vehicle fuel: lessons learned from natural gas for vehicles," *Energy Policy*, vol. 30, pp. 613-619, 2002.
- [36] K. S. Kurani, D. Sperling, T. E. Lipman, D. Stanger, T. Turrentine, and A. Stein, "Household markets for neighborhood electric vehicles in California," University of California at Davis for Calstart, Davis CA 23 May 1995.
- [37] P. Gordon, B. Lee, and H. W. Richardson, "Travel Trends in U.S. Cities: Explaining the 2000 Census Commuting Results," Lusk Center for Real Estate; University of Southern California, Los Angeles CA 2004.
- [38] GreenCarCongress, "Honda's More Powerful Fuel Cell Concept with Home Hydrogen Refueling," vol. 2005: Green Car Congress, 2005.
- [39] I. Directed Technologies, "Direct-Hydrogen-Fueled Proton-Exchange-Membrane Fuel Cell System for Transportation Applications: Hydrogen Vehicle Safety Report," prepared for Ford Motor Company, Dearborn MI DOE/CE/50389-502, May 1997 1997.
- [40] C. E. S. Thomas, "Hydrogen and Fuel Cells: Pathway to a Sustainable Energy Future," H2Gen Innovations, Inc., Alexandria 20 February 2002 2002.
- [41] G. A. Moore, *Crossing the Chasm: Marketing and Selling High-Tech Products to Mainstream Customers*, revised ed. New York: HarperBusiness, 1999.
- [42] C. M. Christensen, *The Innovator's Dilemma: The Revolutionary National Bestseller that Changed the Way We Do Business*, 1st HarperBusiness ed. New York: HarperBusiness, 2000.
- [43] E. M. Rogers, *Diffusion of innovations*, 5th ed. New York: Free Press, 2003.
- [44] T. Turrentine, D. Sperling, K. Kurani, and University of California Davis. Institute of Transportation Studies, *Market potential of electric and natural gas vehicles: draft report for year one*. Davis, Calif.: Institute of Transportation Studies University of California Davis, 1991.
- [45] D. C. Mowery and N. Rosenberg, *Paths of Innovation: Technological Change in 20th Century America*. Cambridge UK: Cambridge University Press, 1998.
- [46] J. S. Gans and S. Stern, "The product market and the market for "ideas": commercialization strategies for technology entrepreneurs," *Research Policy*, vol. 32, pp. 333-350, 2003.
- [47] L. A. Hammond, "Bob Lutz on the history of hybrid and hydrogen technology at General Motors," carlist.com, 2006.
- [48] "GM, BMW, Daimler to Invest US\$1 Billion in Hybrid Project," in *Reuters News Service*, 10 August ed, 2006.

- [49] L. Huston and N. Sakkab, "Connect and Develop: Inside Procter & Gamble's New Model for Innovation," *Harvard Business Review*, vol. 84, 2006.
- [50] M. Schrage, "Great Expectations," in *Technology Review*, vol. October, 2004, pp. 21.
- [51] M. Gladwell, *The tipping point: how little things can make a big difference*, 1st ed. Boston: Little Brown, 2000.
- [52] K. S. Kurani, "Application of a Behavioral Market Segmentation Theory to New Transportation Fuels in New Zealand," in *Civil & Environmental Engineering*. Davis CA: University of California at Davis, 1992, pp. 208.
- [53] E. v. Hippel, *Democratizing innovation*. Cambridge, Mass.: MIT Press, 2005.
- [54] R. R. Heffner, K. S. Kurani, and T. Turrentine, "Symbolism in Early Markets for Hybrid Electric Vehicles," University of California at Davis, Davis CA, Research Report UCD-ITS-RR-07-01, 2007.
- [55] T. S. Turrentine and K. S. Kurani, "Car buyers and fuel economy?" *Energy Policy*, vol. 35, pp. 1213–1223, 2007.
- [56] GreenCarCongress, "Honda Sees Mass Production of Fuel-Cell Cars Possible by 2018," in *Green Car Congress*, 29 December ed: Green Car Congress, 2006.
- [57] A. Rousseau and P. Sharer, "Comparing Apples to Apples: Well-to-Whell Analysis of Current ICE and Fuel Cell Vehicle Technologies," Argonne National Laboratory 2004-01-1015, 2004.
- [58] T. Turrentine and D. Sperling, "The Development of the Alternative Fueled Vehicles Market: Its Impact on Consumer Decision Process," presented at Methods for Understanding Travel Behavior in the 1990's, Chateau Bonne Entente, Quebec, 1991.
- [59] K. A. Nesbitt, "An organizational approach to understanding the incorporation of innovative technologies into the fleet vehicle market with direct application to alternative fuel vehicles," in *Civil Engineering Department*. Davis CA: University of California at Davis, 1996, pp. 201 leaves.
- [60] D. S. Bunch, "Model of the consumer," in *MGT249: Market analysis lecture notes*, vol. 2002. Davis CA: University of California at Davis, 2002.
- [61] K. Nesbitt and D. Sperling, "Myths regarding alternative fuel vehicle demand by light-duty vehicle fleets," Institute of Transportation Studies, University of California at Davis, Davis CA UCD-ITS-REP-98-09, 1998.
- [62] K. Kurani, B. D. Williams, Ed., 2004, pp. Ken captured and reflected my comments using this useful pair of questions: "'Were fleets a bad place to start?' or 'Did we start badly with fleets?'".
- [63] A. E. Farrell, D. W. Keith, and J. J. Corbett, "A strategy for introducing hydrogen into transportation," *Energy Policy*, vol. 31, pp. 1357-1367, 2003.
- [64] M. Gladwell, "The Televisionary: Big business and the myth of the lone inventor," in *The New Yorker*, 2002, pp. 98–102.
- [65] T. Turrentine, Lee-Gosselin, K. Kurani, and D. Sperling, "A Study of Adaptive and Optimizing Behavior for Electric Vehicles Based on Interactive Simulation Games and Revealed Behavior of Electric Vehicle Owners," University of California Transportation Center, Berkeley, Working Paper UCTC No. 130, 1992 1992.

- [66] K. S. Kurani and T. S. Turrentine, "Household Adaptations to New Personal Transport Options: The Reflexive Organization of Household Activity Spaces," University of California at Davis, Davis CA, draft report 2003.
- [67] D. A. Aaker, V. Kumar, and G. S. Day, *Marketing Research, 7th Edition*. New York: John Wiley & Sons, 2001.
- [68] D. Teece, "The Knowledge Economy and Intellectual Capital Management," in *Managing Intellectual Capital: Organizational, Strategic, and Policy Dimensions*. Oxford: Oxford University Press, 2000, pp. 3–31.
- [69] W. Kempton and T. Kubo, "Electric-drive vehicles for peak power in Japan," *Energy Policy*, vol. 28, pp. 9-18, 2000.
- [70] A. B. Lovins, *Soft energy paths: toward a durable peace*. Harmondsworth; New York etc.: Penguin, 1977.
- [71] T. F. Golob, R. Kitamura, M. Bradley, and D. S. Bunch, "Predicting the Market Penetration of Electric and Clean-Fuel Vehicles," *Science of the Total Environment*, vol. 134, pp. 371-381, 1993.
- [72] T. Turrentine and K. S. Kurani, "The household market for electric vehicles: testing the hybrid household hypothesis -- a reflexively designed survey of new-car-buying, multi-vehicle California households," University of California at Davis for CARB and CalEPA, Davis CA 12 May 1995.
- [73] B. Faivre D'Arcier, J.-P. Nicolas, and M. Lee-Gosselin, "Impact of a Limited Range on Electric Vehicle Use in France: Results of a Simulation Game Survey (Draft)," Institut National de Recherche sur les Transports et leur Sécurité (INRETS), Lyon, France, draft 30 March 1995 draft 1995.
- [74] C. E. Thomas, "Personal communication," B. Williams, Ed., 1997.
- [75] A. B. Lovins and D. Yoon, "Renewables in Integrated Energy Systems," Rocky Mountain Institute, Snowmass CO E94-12, 1993.
- [76] W. Kempton and S. E. Letendre, "Electric Vehicles as a New Power Source for Electric Utilities," *Transportation Research D*, vol. 2, pp. 157–175, 1997.