

UC Office of the President

ITS reports

Title

A Comparison of Zero-Emission Highway Trucking Technologies

Permalink

<https://escholarship.org/uc/item/1584b5z9>

Authors

Zhao, Hengbing, PhD

Wang, Qian

Fulton, Lewis, PhD

et al.

Publication Date

2018-10-18

DOI

10.7922/G2FQ9TS7

A Comparison of Zero-Emission Highway Trucking Technologies

A Research Report from the University of California Institute of Transportation Studies

Hengbing Zhao, Formerly STEPS Program, University of California, Davis

Qian Wang, STEPS Program, University of California, Davis

Lewis Fulton, STEPS Program, University of California, Davis

Miguel Jaller, STEPS Program, University of California, Davis

Andrew Burke, STEPS Program, University of California, Davis

October 2018

TECHNICAL REPORT DOCUMENTATION PAGE

1. Report No. UC-ITS-2017-50	2. Government Accession No. N/A	3. Recipient's Catalog No. N/A	
4. Title and Subtitle A Comparison of Zero-Emission Highway Trucking Technologies		5. Report Date October 2018	
		6. Performing Organization Code ITS-Davis	
7. Author(s) Hengbing Zhao Ph.D., Qian Wang Ph.D., Lewis Fulton Ph.D. https://orcid.org/0000-0001-8292-3420 , Miguel Jaller Ph.D. https://orcid.org/0000-0003-4053-750X , and Andrew Burke Ph.D. https://orcid.org/0000-0002-4245-0056		8. Performing Organization Report No. N/A	
9. Performing Organization Name and Address Institute of Transportation Studies, Davis 1605 Tilia Street Davis, CA 95616		10. Work Unit No. N/A	
		11. Contract or Grant No. UC-ITS-2017-50	
12. Sponsoring Agency Name and Address The University of California Institute of Transportation Studies www.ucits.org		13. Type of Report and Period Covered Final Report (March 2017 – October 2018)	
		14. Sponsoring Agency Code UC ITS	
15. Supplementary Notes DOI:10.7922/G2FQ9TS7			
16. Abstract Zero-emission long-haul trucking technologies are being developed that can play a critical role in achieving California's climate change goals and virtually eliminate air pollution from these vehicles. Hydrogen fuel-cell electric, catenary electric and dynamic inductive charging technologies are being demonstrated in small scale projects worldwide. In this study, these three zero-emission truck technologies were reviewed in detail and vehicle and infrastructure challenges and costs for each of the technologies assessed. In the near- to mid-term, electrifying the entire California state highway system or deploying large hydrogen stations at many statewide truck stops would require very large capital costs, on the order of billions of dollars, even though, at least initially, there will likely be relatively few zero-emission long-haul trucks in use. Considering technology readiness, energy efficiency, and capital cost, the most feasible approach for the zero-emission technologies for long-haul trucks may be to deploy local or regional catenary systems. Dynamic inductive charge systems could be introduced, though with perhaps more disruption as roadways are prepared for this service. Hydrogen fuel cell trucks will benefit from some scalability but will require large hydrogen refueling stations along highways. The initial "up-front" investment in infrastructure for hydrogen trucks appears somewhat lower than for the other two options but the cost of providing hydrogen to vehicles will be high, especially if provided using electrolysis. In the longer-term, all three of the technologies could become economically competitive with diesel trucking, though this depends on many factors and uncertainties.			
17. Keywords Zero-emission vehicle (ZEV), long-haul trucking, CO2 reduction, technology evaluation		18. Distribution Statement No restrictions.	
19. Security Classif. (of this report) Unclassified	20. Security Classif. (of this page) Unclassified	21. No. of Pages 58	22. Price N/A

ABOUT THE UC ITS

The University of California Institute of Transportation Studies (UC ITS) is a network of faculty, research and administrative staff, and students dedicated to advancing the state of the art in transportation engineering, planning, and policy for the people of California. Established by the Legislature in 1947, ITS has branches at UC Berkeley, UC Davis, UC Irvine, and UCLA.

ACKNOWLEDGMENTS

This study was made possible through funding received by the University of California Institute of Transportation Studies from the State of California via the Public Transportation Account and the Road Repair and Accountability Act of 2017 (Senate Bill 1). The authors would like to thank the State of California for its support of university-based research, and especially for the funding received for this project. The authors would also like to thank the Sustainable Transportation Energy Pathways (STEPS) Program at the UC Davis Institute of Transportation Studies for providing funding support for this project.

The authors would also like to thank the following individuals and organizations that provided critical review: Ellen Greenberg (Caltrans), Philip Heirigs (Chevron), Tim Wallington (Ford), Ian Sutherland (General Motors), Fabien Heurtaux (Renault), Serene Johnson and Matthew Tipper (Shell), Patrik Akerman (Siemens), Cheryl Bynum, John Mikulin, Chris Ramig, and Lisa Snapp (US Environmental Protection Agency), Pascal Amar and Sam McLaughlin (Volvo), and Sarah Flick (Westport).

DISCLAIMER

The contents of this report reflect the views of the author(s), who are responsible for the facts and the accuracy of the information presented herein. This document is disseminated under the sponsorship of the State of California in the interest of information exchange. The State of California assumes no liability for the contents or use thereof. Nor does the content necessarily reflect the official views or policies of the State of California. This report does not constitute a standard, specification, or regulation.

A Comparison of Zero-Emission Highway Trucking Technologies

UNIVERSITY OF CALIFORNIA INSTITUTE OF TRANSPORTATION STUDIES

October 2018

Hengbing Zhao, Formerly STEPS Program, University of California, Davis

Qian Wang, STEPS Program, University of California, Davis

Lewis Fulton, STEPS Program, University of California, Davis

Miguel Jaller, STEPS Program, University of California, Davis

Andrew Burke, STEPS Program, University of California, Davis

[page intentionally left blank]

TABLE OF CONTENTS

Executive Summary.....	i
1. Introduction	1
2. Traction Power and Energy Consumption of Long-Haul Trucks	2
3. Inductive Charging Technology.....	5
3.1 Wireless Inductive Charging.....	5
3.2 Stationary Inductive Wireless Charging	6
3.3 Dynamic Inductive Wireless Charging.....	8
3.4 Cost.....	14
3.5 Efficiency	15
3.6 Challenges	15
4. Catenary Electric Trucks.....	16
4.1 Technology	16
4.2 Current Status.....	16
4.3 Cost.....	19
4.4 Challenges	20
5. Hydrogen Fuel Cell Electric Trucks.....	20
5.1 Technology	20
5.2 Current Status.....	21
5.2 Cost.....	24
5.6 Challenges	24
6. Comparison of Three Zero-Emission Highway Trucking Technologies.....	26
6.1 Modeling Concerns and Inputs	26
6.2 Truck Capital Costs and O&M Expenses.....	29
6.3 Infrastructure Capital and O&M Costs	33
6.3.1 Catenary Infrastructure	33
6.3.2 Hydrogen Infrastructure.....	34
6.3.3 Infrastructure summary.....	34
7. Results.....	37
8. Sensitivity Analysis	38
9. Conclusions	41
References	44

Figures

Figure 1. Typical Class 8 Freight Truck	1
Figure 2. Traction power and energy requirement of a typical Class 8 long-haul truck	4
Figure 3. Wireless power transfer technologies: (a) traditional inductive power transfer, (b) coupled magnetic resonance, and (c) strongly coupled magnetic resonance [Source: Qiu]	6
Figure 4. Plugless Charging from Evatran [Source: www.pluglesspower.com]	7
Figure 5. Dynamic wireless charging schematic [Source: Highways England]	9
Figure 6. OLEV five 20-kW pick-up modules [Source: Shin]	10
Figure 7. Construction and operation of dynamic wireless charging [Source: Jang]	12
Figure 8. Bombardier PRIMOVE dynamic inductive charging light rail [Source: http://primove.bombardier.com]	12
Figure 9. Swedish dynamic inductive charging test track system [Source: Sweden Viktoria ICT]	13
Figure 10. Electrified test track with PRIMOVE and Scania Truck [Source: Sweden Viktoria ICT]	14
Figure 11. Sweden's catenary electric truck project [Source: www.scania.com]	17
Figure 12. Southern California eHighway project [Source: www.aqmd.gov]	19
Figure 13. Vision's Tyrano plug-in fuel cell truck [Source: Vision Motor Corp]	22
Figure 14. Nikola One hydrogen fuel cell truck [Source: nikolamotor.com]	22
Figure 15. Nikola One drivetrain arrangement [Source: nikolamotor.com]	23
Figure 16. Scenario layout for partially electrified highway	27
Figure 17. Layout of hydrogen fueling stations	28
Figure 18. Vehicle costs vary with road electrification coverage	30
Figure 19. Infrastructure capital costs vary with road electrification coverage	35
Figure 20. Infrastructure O&M costs vary with road electrification coverage	35
Figure 21. Relative cost per mile of different technologies in the base scenario	38
Figure 22. Sensitivity analysis of cost	39
Figure 23. Sensitivity analysis of daily truck traffic. Daily truck traffic ranges from 1 thousand to 10 thousands	40

Tables

Table 1. Class 8 Truck Inputs (33,000 lbs – 80,000 lbs / 14,970 kg – 36,280 kg)	3
Table 2. Traction Power Request and Energy Consumption from Class 8 Trucks	4
Table 3. Specification and Performance Comparison of Tyrano and Nikola One	23
Table 4. Current Status of Hydrogen Storage Technologies [Source: Stetson]	25
Table 5. Model Assumptions	31
Table 6. Infrastructure Capital Cost for a 500-Mile Zero-Emission Highway Section	36

Executive Summary

Zero-emission long-haul trucking technologies are being developed that can play a critical role in achieving California's climate change goals and virtually eliminate air pollution from these vehicles. Hydrogen fuel-cell electric, catenary electric and dynamic inductive charging technologies are being demonstrated in small scale projects worldwide. In this study, these three zero-emission truck technologies were reviewed in detail, and vehicle and infrastructure challenges and costs for each of the technologies assessed, as summarized in Table ES-I. Vehicle configurations for long-haul applications with a daily mileage of up to 500 miles and annual mileage of 104,000 miles were analyzed to estimate vehicle capital and O&M costs. The results of the study provide insights for both the near and longer term, though the cost estimates are focused on longer-term possibilities, with estimates based on large scale deployment of vehicles and energy infrastructure.

In the near- to mid-term, electrifying the entire California state highway system or deploying large hydrogen stations at many statewide truck stops would require very large capital costs, on the order of billions of dollars, even though, at least initially, there will likely be relatively few zero-emission long-haul trucks in use. Low utilization will make it difficult to justify the high investment costs. Considering technology readiness, energy efficiency, and capital cost, the most feasible approach for the zero-emission technologies for trucks may be to deploy local or regional catenary systems to be used by local/regional electric trucks that are equipped to interface with overhead electric catenary lines, and with some driving range available outside of this system. Dynamic inductive charge systems could be introduced, though with perhaps more disruption as roadways are prepared for this service. There appear to be more technical challenges for this technology than for catenaries, and more demonstration projects may be needed to address these issues. Hydrogen fuel cell trucks and associated hydrogen infrastructure will benefit from some scalability, but will require large hydrogen refueling stations along highways, which may or may not be compatible with infrastructure for light-duty fuel cell vehicles. The initial "up-front" investment in infrastructure for hydrogen trucks appears somewhat lower than for the other two options but the cost of providing hydrogen to vehicles will be high, especially if provided using electrolysis as considered in this study (to ensure all technologies can eventually run on near-zero-emission electricity).

In the longer-term, all three of the technologies could become economically competitive with diesel trucking, though this depends on many factors and uncertainties. Electrifying highways becomes less economic, the higher the percentage of roads that are converted, so the economics depends to some degree on the "autonomy" of trucks, i.e. their available driving range off the system. Hydrogen fuel-cell vehicles will have the advantage of flexibility of driving range in any direction once refueled. But their economics are highly dependent on lowering the cost of fuel cell systems and hydrogen storage onboard the vehicle, and provision of cost-

competitive, probably liquefied hydrogen on-board the vehicles. All of these costs are likely to be closely tied to scale and learning, and will take time to reach targets envisioned for them.

Table ES-1: Summary of Challenges and Costs of Three Zero-Emission Long-Haul Trucking Technologies

Zero-Emission Long-Haul Technology	Hydrogen Fuel Cell	Catenary System	Dynamic Inductive Charging
Vehicle Technical Challenges	<ul style="list-style-type: none"> The durability status of current automotive fuel cells is approximately 10,000 hrs. at this level, fuel cell stacks in long haul trucks would need to be replaced every 3-6 years. Current compressed H₂ storage has low volumetric and gravimetric energy densities and high cost. Cryogenic, liquid hydrogen storage is likely to be a better option for long-haul and is assumed in this study. However, producing, shipping and storing LH₂ faces challenges. PEMFC technologies appear close to satisfying heavy-duty durability requirements in the long-haul truck application, but may still face some challenges. 	<ul style="list-style-type: none"> Catenary technology is relatively mature. Detecting and connecting/disconnecting overhead catenary wires at varying high speeds is being verified. Catenaries are likely to be used only for large trucks with minimum height and proximity to the lines. Catenaries are likely to be placed in limited locations and trucks may need significant “autonomous” battery driving range for off-system driving. 	<ul style="list-style-type: none"> This technology is in an early stage of development and long term prospects and costs are uncertain, but appear to similar to catenary systems. With partially electrified highways, higher power, higher efficiency pick-up receivers may be required than have been tested to date. Inductive charging could be used for both cars and trucks in the same roadways. Like catenaries, it may have limited application so autonomous driving range may be needed.
Infrastructure Challenges	<ul style="list-style-type: none"> Construction of large volume hydrogen stations at highway stops (at least 10 times or greater in volume than current urban stations for H₂ LDVs). Will be expensive and require considerable space and dispensing facilities. Storage of large amounts of hydrogen at truck stops could be a problem for both compressed and liquefied hydrogen because of the volumes required. 	<ul style="list-style-type: none"> Catenary systems would require greater height clearance at bridges and in tunnels, but this can be avoided by using partial electrification sections. Cost savings are possible by using fewer electrified sections and increasing the battery-based range autonomy on trucks, but this trades off catenary cost with battery cost and needed range, so is an uncertain aspect. 	<ul style="list-style-type: none"> The integration of the primary coils and fragile ferrite cores into the road surface layers will be challenging. The top 8 inches of road surface need to be removed for installing the primary coils and ferrite cores. Road mechanical integrity problems and thermal expansion discontinuities need further study and testing. Acceptable power levels depend on vehicle type, making power management challenging.
Vehicle Capital and O&M Costs	<ul style="list-style-type: none"> We estimate fuel cell tractor-trailer vehicle cost at approximately \$180K for year 2030, which is about 25% higher than diesel trucks. On a “5 year ownership cost” basis, the difference rises to 37%. Annual O&M costs appear to be about \$78K, which is somewhat higher than for diesel trucks. 	<ul style="list-style-type: none"> Vehicle cost with pantograph is approximately \$140K, about 10-15% higher than diesel. Annual O&M costs may be about \$48K, about 80% of diesel trucks. 	<ul style="list-style-type: none"> Vehicle cost with induction system is approximately \$140K, very close to catenary trucks. Annual O&M costs are estimated to be similar to catenary trucks.
Infrastructure Cost & O&M Cost	<ul style="list-style-type: none"> The iH₂ station cost with all electrolysis, liquefaction, storage and dispensing equipment is 	<ul style="list-style-type: none"> The infrastructure cost for 500 miles in two 	<ul style="list-style-type: none"> The infrastructure cost for 500 miles in two directions is

(for a highway section of 500 miles)	<p>estimated to be around \$75 million. With 10 stations over 500 miles, this amounts to \$750M.</p> <ul style="list-style-type: none"> • Annual (non-energy) O&M costs are about \$7.5M. Energy costs would be high, on the order of \$0.60 per mile for H2 from electrolysis). 	<p>directions is estimated to be about \$1,200M.</p> <ul style="list-style-type: none"> • Assumes 50% electrified coverage. • Annual O&M (non-energy) costs are about \$11.5M. Energy costs would be on the order of \$0.40 per mile. 	<p>estimated to be about \$1,600M.</p> <ul style="list-style-type: none"> • Assumes 50% electrified coverage. • Annual (non-energy) O&M costs are about \$16M. Energy costs, taking into account losses from induction are about \$0.50 per mile.
CO2 impacts	<p>Fuel cell trucks using H2 from natural gas will incur CO2 emissions, perhaps 40-50% less per mile than diesel trucks. CO2 from H2 from electricity (as used in this study) will depend on electricity carbon intensity and will be higher per mile than catenary trucks given the lower net efficiency of delivering electricity to trucks via H2 as an intermediate energy carrier.</p>	<p>CO2 emissions will be dependent on electricity carbon intensity; these will always have lower CO2 than fuel cell or inductive charging from same electricity since it is the most efficient of the three systems. May not be an important advantage if very clean electricity.</p>	<p>Somewhat less efficient than catenaries so slightly higher CO2 per mile, not important if very clean electricity.</p>

Our long-term, base case estimates for vehicle, infrastructure, and energy costs by technology are shown in Figure ES-1 on a per-mile basis, using the 500 mile road-stretch approach. The infrastructure costs per vehicle mile will vary with system size and the number of vehicles using the system. We assume high utilization of this infrastructure (and refueling infrastructure for diesel and hydrogen). In our base scenario, the average cost per mile of the catenary truck systems is relatively close to those for conventional diesel trucks, with inductive charge systems somewhat higher and fuel cell trucks higher still. However all are between 70 and 100 cents per mile. The cost for fuel cells running on hydrogen from electrolysis reflects somewhat higher cost for the fuel cell trucks, but mostly the high cost of electrolysis (even if this cost is assumed to decline in the future). The high infrastructure costs for catenary and dynamic charging systems are mostly offset by lower energy costs from the direct, efficient use of electricity.

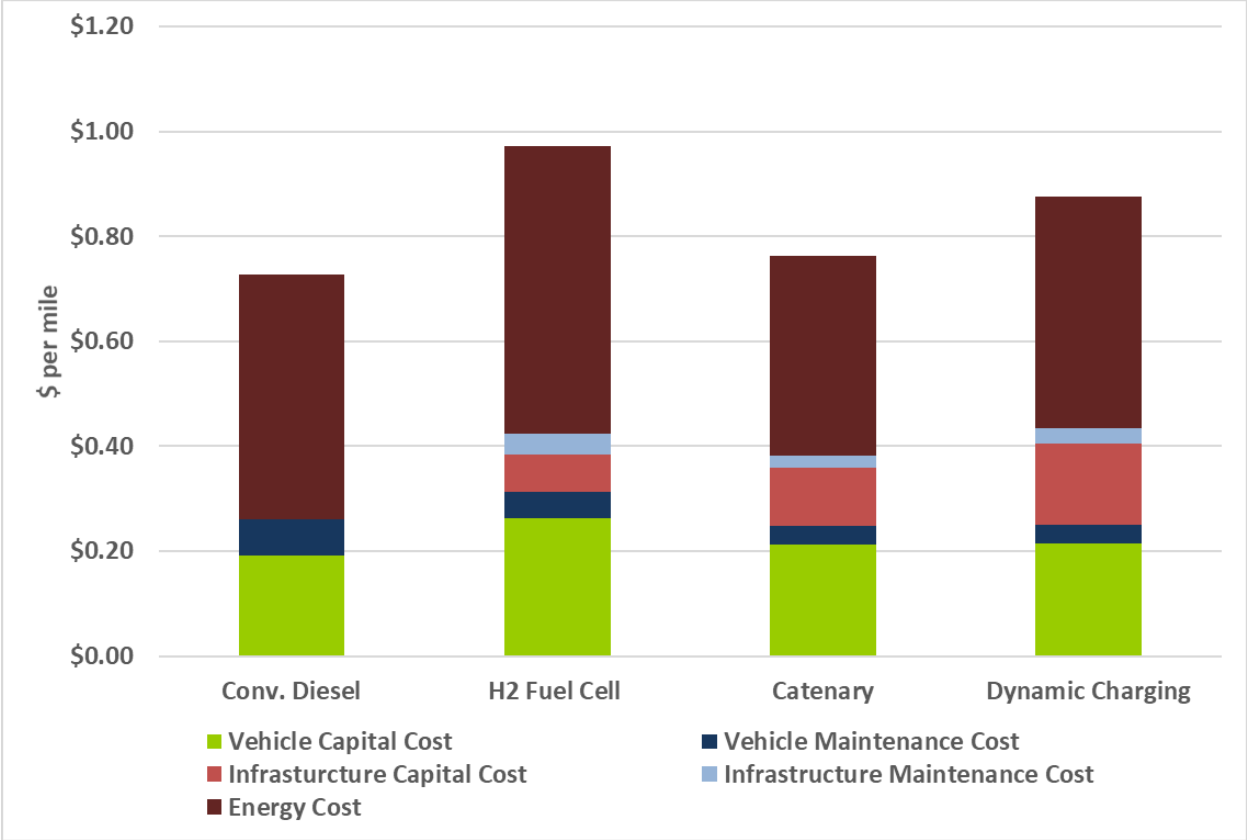

Figure ES-1: Base case cost per mile of different technologies considered in this analysis

These base numbers are highly uncertain and small changes in assumptions can change this picture. To explore this, a sensitivity analysis was conducted off these base results, varying a range of variables. We created “tornado” diagrams comparing two technologies at a time. Here we compare H2 fuel cells with diesel trucks (Figure ES-2). This figure shows that varying each of a number of assumption by plus or minus 20% compared to the reference case value can have very different impacts on the relative cost of the two technologies. In particular, fuel cost changes have big impacts whereas infrastructure and vehicle cost variations do not have particularly big impacts. This reflects the importance of fuel costs and how big a role they play in the overall cost of operating a long-haul truck. Figure ES-2 suggests that in a case where H2 cost is low, diesel cost is high, and annual mileage is low, could bring the cost of H2 fuel cell trucks much closer to the cost of diesel trucks, compared to the base case. Twenty percent changes in other variables (even a number of these together) would not be enough to bring H2 fuel cell truck costs close to diesel truck costs. Similar tornado figures for other technologies are shown in the body of the report.

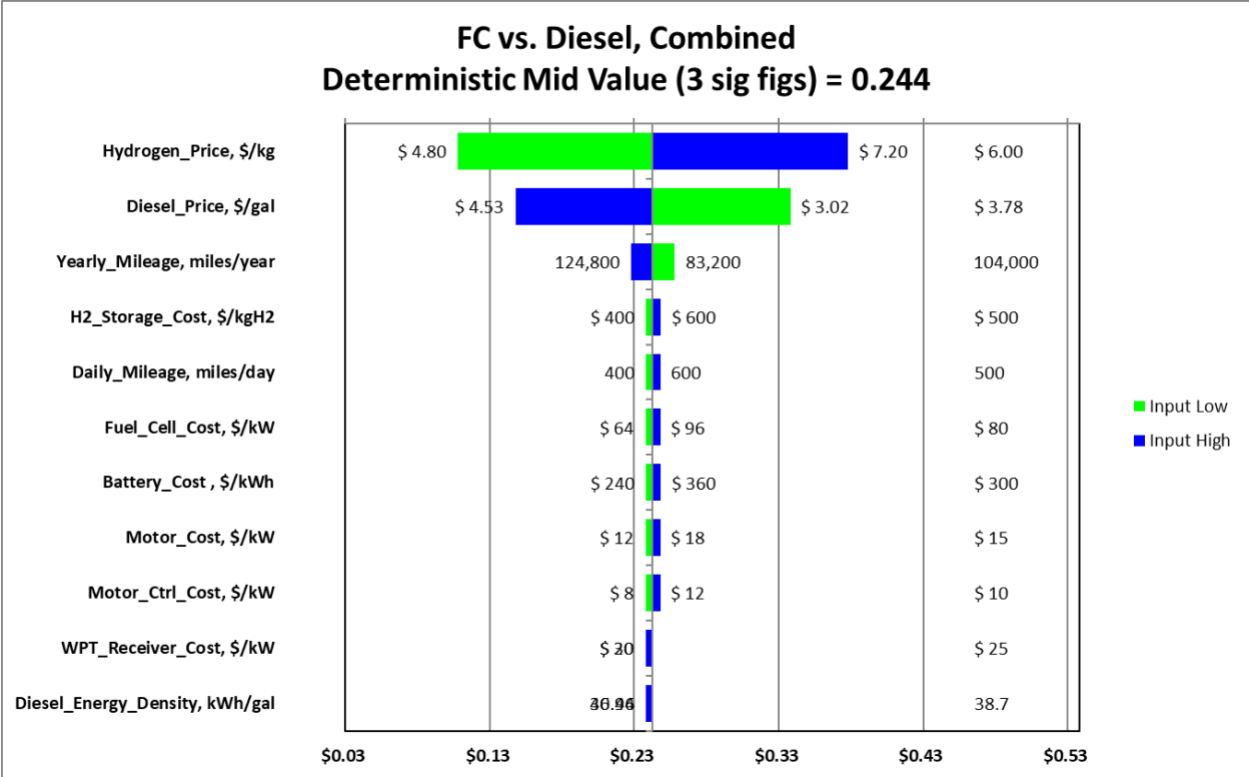

Figure ES-2: H2 fuel cell vs diesel truck: changes in relative cost per mile as a function of changing input assumptions

Overall, it appears too early to make a determination regarding which of these technology options is the most likely to win the cost-competitiveness sweepstakes, and more research and demonstration projects are needed. A critical factor will be the high up-front capital costs for all three, which may have to occur before many trucks are running that can utilize the systems. This creates potentially very challenging chicken-or-egg problems. Similarly, all three options benefit from large scale application and will be much more expensive than shown here for small scale applications, and/or cases where few trucks use the system. Perhaps hydrogen has the best chance of overcoming these, given its better “scalability”; a lower cost of building incremental refueling infrastructure as well as flexibility of this infrastructure in terms of location and the radial range of the trucks that refuel at these stations. The already begun efforts to develop H2 infrastructure for light-duty vehicles (at least in California) give this technology a “leg up”.

Ultimately policies to promote both the provision of infrastructure and the uptake of the relevant vehicle technologies will be needed, though the question remains which pathway(s) to prioritize. Truck OEMs and fleets should be heavily involved in such on-going efforts and discussions, as these two stakeholder groups will need to adapt and likely share much of the cost burden, and will have a major impact on success or failure of any of these options.

1. Introduction

Transitioning to a zero or near-zero emission freight transportation system is a necessary step in meeting the long-term air pollution and greenhouse gas (GHG) emission reduction goals of California. Trucking dominates our nation’s freight transportation system. According to the American Trucking Association, over 70% of all the freight tonnage in the U.S. is moved by trucks and over 3.4 million heavy-duty Class 8 trucks consume over 38 billion gallons of diesel fuel annually. As a significant component of the freight transportation system and a primary source of emissions, long-haul freight truck transportation must be involved in the transition to zero or near-zero emission technologies. This report compares the several approaches available for zero-emission trucking.

Class 8 freight trucks are defined as trucks with gross vehicle weight between 33,000 – 80,000 lbs (14,969 – 36,287 kg). Tractor-trailer combinations with 5 or more axles, shown in Figure 1 are typical Class 8 Trucks. Diesel trucks with 13- and 15-liter diesel engines which deliver a power of 400 – 600 horsepower (300 – 450 kW) dominate U.S. long-haul truck freight transport. Class 8 long-haul trucks usually carry two 125-gallon tanks of diesel fuel and operate 8-9 hours with daily mileage of 450-550 miles and average a yearly mileage of 90,000 miles. They are the largest greenhouse gas and pollutant emitters and fuel users. Therefore, significant emission reductions in long-haul freight trucks are needed to meet California’s pollutant emission and climate goals. Some studies show that biofuels have the potential to provide deep cuts to GHG emissions for the long-haul freight truck sector. However, biofuels do not eliminate pollutant emissions and there are uncertainties regarding their sustainability and their impact on water and land-use change.

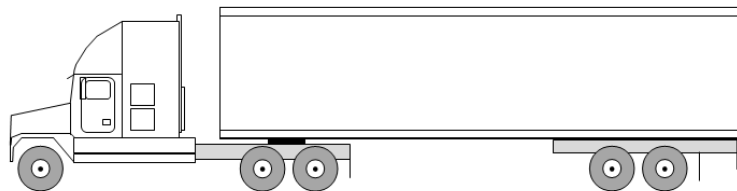

Figure 1. Typical Class 8 Freight Truck

All electric trucks are a promising alternative to conventional diesel engine/transmission trucks due to their high efficiency and zero tail-pipe emissions. The electrical energy to power them can be provided by external power sources, such as in-road dynamic inductive charging or overhead catenary lines, or can be generated on-board by a hydrogen polymer electrolyte membrane fuel cell (PEMFC). External electricity powered drivetrains tend to be about twice as efficient as conventional diesel engine/transmission powertrains. PEMFCs can have greater energy efficiency than diesel engines, up to about a third. Hence it is of interest to compare these zero-emission technology alternatives for long-haul truck applications.

The objectives of this study are to review advanced zero-emission trucking technologies and to compare them in terms of technical requirements, current status, operational, maintenance, and infrastructure considerations. Three zero-emission long-haul trucking technologies are analyzed in this study:

- In-road dynamic inductive charging technology
- Catenary electric trucks
- Hydrogen fuel cell electric trucks

In this study, these three truck technologies are assessed to determine their potential as alternatives to conventional diesel truck technology. The study does not consider some nearer term technologies such as natural gas or biogas fueled diesel trucks, or advanced hybrid trucks (though a very efficient ICE diesel truck is used in the comparisons). The study focuses on a future date (2030) when the technologies are assumed to have matured and are available at scale with associated cost reductions. Many more assumptions are described below, and a number of sensitivity cases are presented to test the importance of various assumptions.

The study includes the following sections. Section 2 looks at the traction power requirement and energy consumption of typical Class 8 long-haul freight trucks (Table 1). Sections 3 through 5 provide technical reviews of dynamic inductive charging, catenary electric, and hydrogen fuel cell trucks from the viewpoints of their current status, cost, and operational and maintenance (O&M) considerations. In Section 6, the three zero-emission long-haul trucking technologies are compared with conventional diesel trucks in terms of vehicle capital and O&M costs and infrastructure costs. Section 7 provides the main results, while Section 8 provides a sensitivity analysis. Section 9 summarizes the conclusions of this study and suggests pathways for demonstrations of zero-emission long-haul truck technologies.

2. Traction Power and Energy Consumption of Long-Haul Trucks

Dynamic inductive charge trucks, catenary electric trucks, and hydrogen fuel cell trucks all use electric traction motors to power the vehicles. To assess the impact of electrified trucks on the load profile of the electric distribution network and estimate the requirement for hydrogen refueling infrastructure, it is essential to determine the dynamic power consumption of the long-haul trucks. The gross average traction power and energy requirements of a typical Class 8 long-haul truck can be calculated from the vehicle's specifications and velocity profile. Table 1 lists the vehicle inputs.

Table 1. Class 8 Truck Inputs (33,000 lbs – 80,000 lbs / 14,970 kg – 36,280 kg)

Component	Model Characteristics
Aero Drag Coefficient (Cd)	0.6
Frontal Area (A: m2)	10
Tire Rolling Resistance (eta)	0.0065
Curb Weight Including Empty Trailer (kg)	15,700
Gross Vehicle Weight Rating (kg)	25,400 kg *
Transmission 10 Speed efficiency	98%
Axle Efficiency	98%
Electrical Accessories	4 kW
Motor Efficiency	94%
Inverter Efficiency	99%
Average mileages	Up to 500 miles/day (284 average over 365 day year), 104,000 miles/year

*70% of the rated load of 36,280 kg

Electrification of long-haul freight trucks can significantly modify the load profile of the electric distribution network. The power and energy demands to the grid depend on the truck power requirement, daily peak truck flow rate, and traffic conditions. The power requirement of a typical Class 8 long-haul truck is calculated based on its aerodynamic drag P_{aero} , tire rolling resistance $P_{rolling}$, drivetrain power loss $P_{drivetrainloss}$, and accessory and hotel power P_{access} . If we assume the road is on level terrain and there is no headwind, the power demand of a specific truck as a function of speed is given by equations (1)-(3). The energy consumption per mile can be calculated in terms of kWh/mile.

Aerodynamic drag power (kW)

$$P_{aero} = \frac{1}{2} \rho v^3 C_d A \quad (1)$$

Tire rolling resistance power (kW)

$$P_{tire} = \eta \cdot m g \cdot v \quad (2)$$

Traction power demand (kW)

$$P(v) = P_{aero} + P_{rolling} + P_{drivetrainloss} + P_{access} \quad (3)$$

Table 2. Traction Power Request and Energy Consumption from Class 8 Trucks

Speed (mph)	Aero Drag (kW)	Rolling Resistance (kW)	Axle Loss (kW)	Trans. Loss (kW)	Elec. Access. (kW)	Motor loss (kW)	Traction Power (kW)	Traction Energy (kWh/mile)
20	2.6	14.5	0.4	0.4	4.0	1.9	24	1.2
40	21.0	28.9	1.0	1.0	4.0	4.9	61	1.5
50	41.0	36.2	1.6	1.6	4.0	7.3	92	1.8
60	70.9	43.4	2.3	2.4	4.0	10.7	134	2.2
65	90.1	47.0	2.8	2.9	4.0	12.8	160	2.5
70	112.5	50.6	3.3	3.4	4.0	15.1	189	2.7

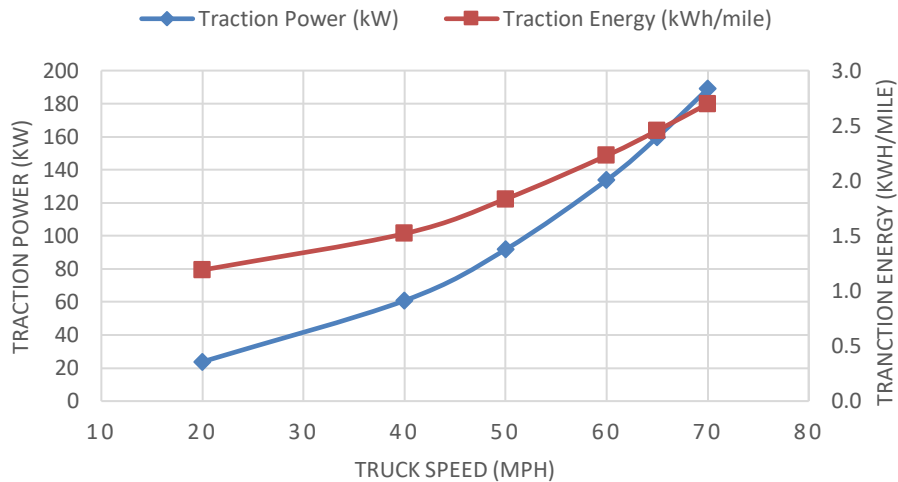

Figure 2. Traction power and energy requirement of a typical Class 8 long-haul truck

The traction power and energy consumption for a typical Class 8 truck over a wide range of speed are given in Table 2. The values given represent the average power and electricity required to power the vehicle at constant speeds; actual power can vary significantly with route speed and grade profiles. For diesel trucks, the engine power needed to propel the truck is 160 kW at 65 mph. With an average diesel engine efficiency of 49% in 2030, the estimated fuel economy of conventional diesel trucks at 65 mph is approximate 8.1 mpg. PEMFC's can have greater energy efficiency than diesel engines, up to 65%. In that case, the fuel economy of hydrogen fuel cell trucks at 65 mph would be 9.58 mile/kg H₂.

Current battery technology restricts its application on long-haul freight trucks. Since a typical Class 8 truck consumes energy of 2.7 kWh per mile at 70 mph, a battery pack of 1.7 MWh (80% usable) would be needed for an electric truck to have a range of 500 miles on a single charge. Considering the most promising battery chemistries (such as Li-titanate) have a gravimetric energy density of 200 Wh/kg and volumetric energy density of 400 Wh/L, a 1.7 MWh battery

pack would weigh 8.4 tons and occupy 4,218 liters (150 cubic feet) space. Hence, current battery technology is not expected to provide sufficient range for long-haul trucks for reasonable weight, volume, and cost. However, smaller batteries onboard electric trucks could be feasible when combined with roadside stationary charging, in-road dynamic inductive charging, or overhead catenary system infrastructure. For a long-haul truck transport, frequent roadside stationary charging is time consuming and would result in significant delays that could reduce freight truck competitiveness and cause a mode shift to rail. In contrast to stationary charging, in-road dynamic inductive charging and overhead catenary wires are more attractive for long-distance travel, since they enable power exchange between the vehicle and the power supply system while the vehicle is moving.

3. Inductive Charging Technology

Various wireless inductive power transfer methods for charging electric vehicles have been developed. Dynamic inductive charging technology has been successfully tested in small-scale demonstration projects around the world. However, dynamic inductive charging requires the road to be electrified to provide partial to full power for freight trucks and thus has a number of challenges. These challenges must be addressed before in-road dynamic inductive charging can be adopted in California's highway system. The following subsections provide a status review of inductive power transfer technology and challenging operational and infrastructure considerations. Since both stationary inductive charging and dynamic inductive charging use the same wireless power transfer technologies, the review of the stationary inductive charging technology is also included.

3.1 Wireless Inductive Charging

Wireless inductive charging devices can be installed beneath parking areas, city roads or highways for electric vehicle charging. Wireless inductive charging usually has at least one primary coil (source transmitter) embedded in the pavement. The primary coil generates a varying magnetic field which induces a current in the secondary coil (load receiver) mounted under the vehicle. There are two applications of wireless inductive charging technologies: stationary charging and dynamic charging. In the stationary wireless inductive charging application, typically the vehicle is parked for a long duration of time (garage, parking spot, bus terminal, etc.) or the vehicle is en route and stops for a short period of time (car waiting at the traffic light, bus at a stop, etc.). For dynamic charging, the vehicle may travel at constant or variable speed typically in a dedicated special lane that hosts the charging infrastructure.

Several wireless charging technologies have been developed for electric vehicle charging applications [Brecher, Miller, Lu, Qiu, Song, and Shin]. Traditional inductive power transfer is based on magnetic field induction that delivers electric energy from a primary source coil to a receiver (load) coil, as shown in Figure 3. The operating frequency and power of traditional inductive power transfer are typically in the range of kHz and up to high kilowatt levels. The

effective charging distance is generally less than 20 cm due to low quality factor [Qiu]. The latest wireless charging technology - magnetic resonance charging offers increased efficiency and the requirement for less precise position alignment of the charging transmitter and the vehicle receiver compared to traditional inductive power transfer technology. Magnetic resonance coupling is enhanced by using two or more pairs of RLC resonators to generate oscillating magnetic fields (Figure 3). Two or more coils, operating at the same resonant frequency, are strongly coupled to extend operating range and increase power transfer efficiency. The operating frequency of current magnetic resonance charging for electric vehicles ranges from 20 kHz to 140 kHz. Compared to conventional inductive power transfer, coupled magnetic resonance technology could transfer power over larger gaps with high efficiency of over 90%. Therefore, it is widely adopted to stationary and dynamic inductive charging applications.

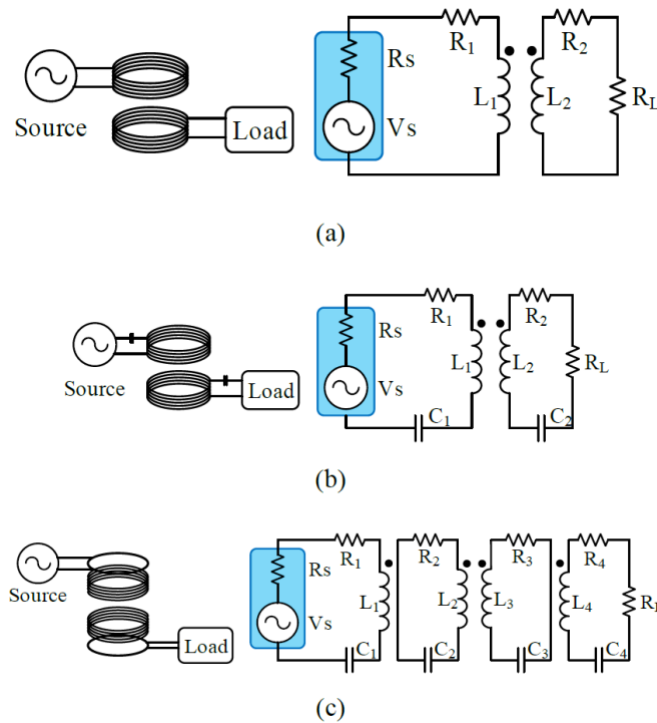

Figure 3. Wireless power transfer technologies: (a) traditional inductive power transfer, (b) coupled magnetic resonance, and (c) strongly coupled magnetic resonance [Source: Qiu]

3.2 Stationary Inductive Wireless Charging

Current status

Stationary charging technology can be considered mature. Currently, the commercial focus of wireless charging is on stationary use cases. Most stationary wireless inductive charging systems on the market today are for passenger cars and offer power transfer rates of between

3 kW and 7 kW, which are still being treated as aftermarket add-ons. Wireless inductive charging hasn't been able to match the high-power transfer rates offered by DC fast charging.

The only wireless charger on the market today is Plugless by Evatran. Since the receivers have to be custom-made for different vehicles, Evatran developed Plugless 3.3 kW models for the Nissan Leaf, Chevrolet Volt, and Cadillac ELR, and a 7.2 kW model for the Tesla Model S (Figure 4). Evatran has stated that the Plugless is about 12% less efficient than a conventional Level 2, 7.2 kW 240V charging system. Bosch, partnered with Evatran, is offering a wireless system with 6.6 kW. WiTricity is working with several major automakers and OEM part suppliers to demonstrate their wireless charging technology in the Toyota PHEV Prius, Honda Fit EV, Mitsubishi i-MiEV, and Audi A3 e-tron. Currently, Qualcomm is working with Ricardo to commercialize their Qualcomm Halo wireless EV charging technology in Europe. The Halo wireless charger can transfer up to 3.5 kW at greater than 90% efficiency. According to the Audi Media Center, Audi will launch Audi Wireless Charging system in 2017, offering a charging power of 3.6 kW in the first generation and possibly a higher power of 11 kW in the next version. Prior to charging, the embedded power transmitter will be raised to minimize the air gap between the primary coil and the secondary coil for achieving higher power transfer efficiency. Oak Ridge National Laboratory has demonstrated a 20 kW inductive charging system at 90% efficiency and plans to build a prototype 50 kW system capable of transferring the same kind of energy through inductive charging as a typical DC fast charging station.



Figure 4. Plugless Charging from Evatran [Source: www.pluglesspower.com]

Despite the advancement of wireless charging technology, the floor charging pad still needs to raise the primary coil to improve the efficiency by shortening the distance mechanically. The efficiency of wireless charging also highly relies on the alignment of the charging pad and the receiver. Guided positioning through sensors is needed for making alignment to achieve tight coupling. Normally, wireless charging incurs higher cost compared to conductive charging. Plugless has wireless charging station priced at \$1,260 for a 3.6 kW system, \$3,000 for a 6.6 kW system, and \$3,420 for a 7.2 kW system. Average cost of stationary wireless charging is between \$350/kW - \$475/kW.

Stationary inductive wireless charging technologies are also being widely demonstrated in electric buses. The U.S. Federal Transit Administration (FTA) GIGGER program and the Clean Fuels Grant program awarded several wireless charging electric bus demonstration projects between 2011 and 2013. The Chattanooga Area Regional Transportation Authority demonstrated three electric shuttle buses equipped with a 60 kW wireless charging system. The onboard battery could receive fast charging for three minutes at stops. One Utah Transit Authority's electric bus demonstrated a 50kW WAVE wireless charging system developed by the University of Utah. In 2016, the California State Transportation Agency (CalSTA) funded Antelope Valley Transit Authority (AVTA) to purchase 29 BYD electric buses, which can be recharged through wireless inductive charging. AVTA has set a goal to purchase up to 85 new all-electric buses over the next three years and install 15 wireless charging stations over the next two years. Wireless charging enables rapidly recharging electric bus batteries in stations or at stops along a bus route to extend the driving range of electric buses without interrupting operation. Transportation agencies are showing high interest in wireless charging for electric buses on heavily traveled routes that would justify capital investment.

3.3 Dynamic Inductive Wireless Charging

Technology

The dynamic inductive power supply system contains transmission substations, road-side traction substations and distributed high frequency power inverters, and embedded power transfer coils. The power transfer primary coils are embedded in the road pavement and divided into several segments. The road-side inverter provides high frequency (20 kHz - 140 kHz) alternative current power to several in-road primary coil segments. Dynamic inductive charging vehicles communicate with road-side inverters and the inverter excites only the segment on which a vehicle is located. The primary coil segments must be sequentially turned on in synchronism with the passage of the vehicle pick-up secondary coil. This power management reduces power losses and avoids regular vehicles and human exposure to high frequency time-varying electromagnetic fields [Qiu, Shin, and Miller]. Figure 5 below depicts a section of the electrified roadway with dynamic inductive charging.

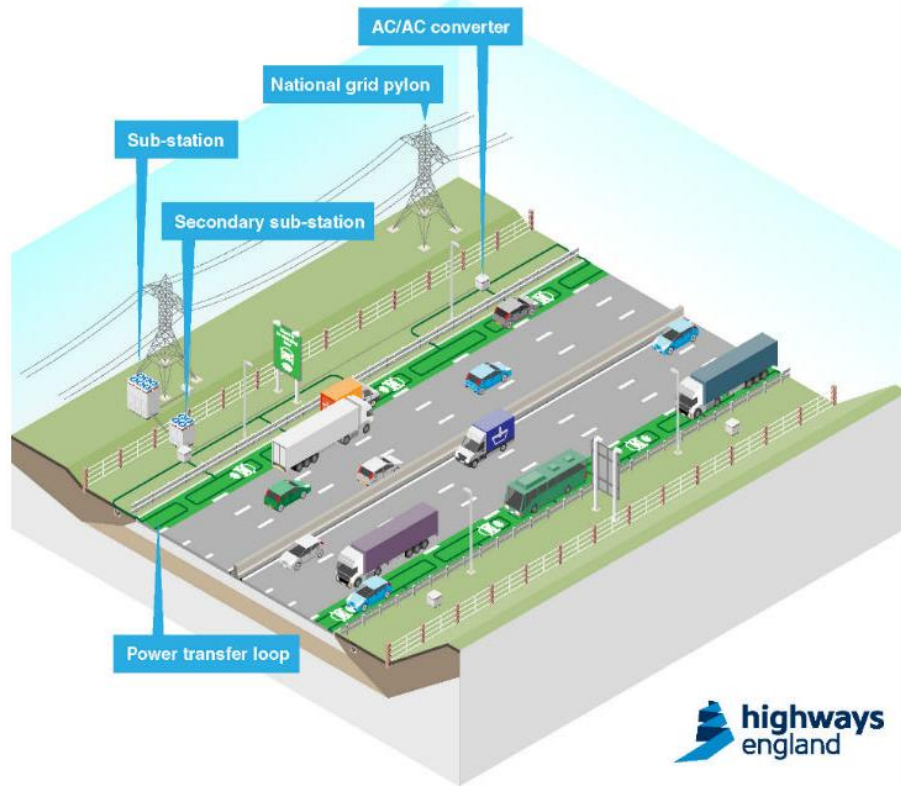

Figure 5. Dynamic wireless charging schematic [Source: Highways England]

When the vehicle pick-up secondary coil passes over the excited primary coil, both primary and secondary coils are tuned to resonance at the excitation frequency. Thus, high frequency power is transferred from the primary coil to the secondary coil. The received AC power is further rectified and regulated for powering the traction motor and/or charging the onboard battery. Figure 5 shows five pick-up coils are used to achieve 100-kW power transfer capacity in a large truck or bus [Shin]. Unlike the stationary inductive charging, relative motion between the primary coil and secondary coil has significant impact on power transfer of dynamic charging. 100% power transfer could be achieved when the primary coil and the secondary coil are fully aligned, and 50% of full power can be transferred when the secondary coil is midway between the two primary coils. This power variability happens during vehicle passage over embedded coils and would have impact on grid stability. Ultracapacitors near inverters may be needed to smooth the pulsating power demand. A short overlapped primary coils configuration could reduce power variability but at higher costs [Miller].

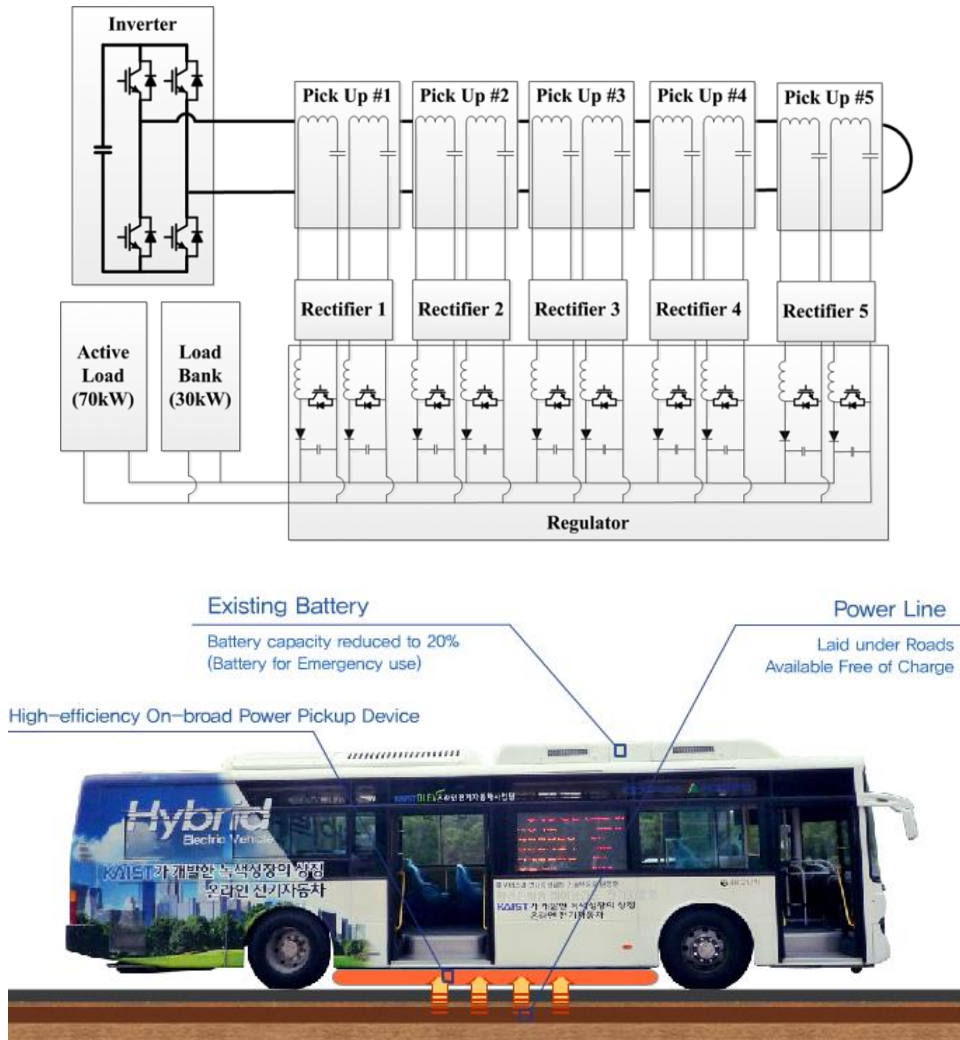

Figure 6. OLEV five 20-kW pick-up modules [Source: Shin]

Current Status

Dynamic inductive charging, also known as in-road wireless charging while driving, provides an opportunity for electric vehicles to have unlimited range. Dynamic inductive charging technology can help reduce the battery size and eliminate recharge-related waiting time. Most of the stationary wireless inductive charging systems could be used for transferring power while driving. However, transitioning from stationary to dynamic inductive charging faces more technology challenges such as charging power fluctuation and management, vehicle sensing and alignment, vehicle to infrastructure communication and implementation challenges in terms of infrastructure construction [Brecher, Deflorio, Miller, Navidi, Qiu, Song, and Swedish Viktoria].

Dynamic inductive charging for transit bus applications is becoming a fascinating research area. Many companies are studying and developing this technology. In South Korea, Online Electric Vehicles (OLEV) dynamic inductive charging technology has been developed by the Korea Advanced Institute of Science and Technology (KAIST) in 2009. A 2.2 km tram loop was installed

with a 62 kW wireless powered tram in Seoul Zoo and Grand Park in 2010. Two OLEV electric buses have been demonstrated on a bus route through the city of Gumi since 2012. Canadian Bombardier developed the PRIMOVE wireless power transfer solution for all types of electric vehicles – from light rail and bus networks to commercial vehicles, truck and electric cars. It demonstrated its 200 kW PRIMOVE inductive power transfer systems during an e-bus pilot project and light rail project using both stationary and dynamic inductive charging in Germany in 2012. Utah State University began construction of the Electric Vehicle and Roadway (EVR) research facility in Park City Utah in 2014. The EVR complex includes a quarter-mile dynamic inductive charging test track and a trial transit bus to verify system efficiency, reliability and safety. The European Union (EU) has an ongoing FABRIC project, which runs from 2014 through 2017 implemented by 25 partner organizations from 9 European countries. Its objective is to assess the feasibility of dynamic charging and define the required adaptations of the existing infrastructure and the investments needed to develop such charging systems at a large scale.

Dynamic wireless charging is technologically feasible and has been successfully demonstrated in research prototypes of transit buses and light rail projects. With respect to commercialization, dynamic charging is still in the early stages and faces many new challenges compared to stationary wireless charging. Substantial validation work has to be done for this technology – in particular with respect to higher infrastructure costs and power transfer levels.

In recently years, several research institutes and companies including KAIST, Bombardier, Oak Ridge National Laboratory, the University of Auckland, etc. have demonstrated their dynamic inductive charging technologies. KAIST's OLEV and Bombardier PRIMOVE technologies are well known and widely demonstrated in real world conditions.

KAIST the Online Electric Vehicle (OLEV)

In the KAIST's OLEV project, two OLEV wirelessly recharged buses have been demonstrated on a 15-mile line through the city of Gumi, South Korea in 2012. The OLEVs run ten times per day through the city. 10-15% of the bus route is electrified and covered with wireless recharging pads. The OLEV buses have a small battery and receive 20 kHz and 100 kW at maximum power transmission efficiency of 85%, while maintaining a 17 cm air gap between the underbody of the vehicle and the road surface. Five 20-kW pick-up coils were mounted under the underbody of the OLEV bus to obtain 100-kW power transfer capacity. Figure 7 shows that the primary coils have been installed under the road surface of a bus route. Ferrite cores (not shown in the photo) were used in the center of the primary coils to shape the magnetic fields to maximize magnetic coupling. The electrified road sections can distinguish OLEV buses from regular cars; the high frequency power supply is only switched on when OLEV buses pass, but is switched off for other vehicles to prevent high frequency magnetic field exposure and standby power consumption. Since a few sections of the road (10%-15% of the entire road) are required to be rebuilt with the embedded coil segments, road modification expenses are expected to be costly and time consuming.

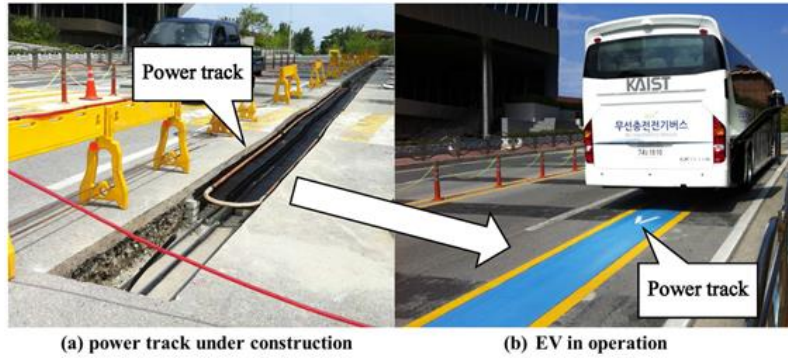

Figure 7. Construction and operation of dynamic wireless charging [Source: Jang]

Bombardier PRIMOVE

In 2012, Bombardier demonstrated in Germany its 200 kW PRIMOVE inductive power transfer systems during an e-bus pilot project and light rail project using both stationary and dynamic inductive charging. Charging pads were installed at stops along a bus route in Mannheim to charge electric buses without interrupting operation. Two electric buses converted for inductive charging have been demonstrated for one year. Bombardier's PRIMOVE system has also been demonstrated in operation on a light rail line in Augsburg, Germany. One bidirectional Bombardier low-floor tram has been equipped with PRIMOVE power receivers to capture the inductive power from the primary coils embedded under the track. 8-m long coil segments laid between the rails and beneath the ground are powered by the track wayside inverters, as shown in Figure 8.



Figure 8. Bombardier PRIMOVE dynamic inductive charging light rail [Source: <http://primove.bombardier.com>]

Bombardier’s PRIMOVE technology was also adopted in Belgium Flanders’ DRIVE research project. A test track of 600 meters was developed, including two inductive sections with one section having a cement concrete pavement and the other section testing an asphalt concrete pavement. A Van Hool bus fitted with a 160-kW inductive power transfer system was demonstrated while being parked and while moving in the first phase. An electric Volvo C30 car equipped with a 22-kW system was tested in the second phase. An electric bus with a 200-kW system was demonstrated later in Bruges Belgium. The Belgian Road Research Centre’s (BRRC) study showed that it is possible to integrate inductive power transfer systems into the conventional pavement [Chen].

In 2013, Scania and Bombardier together demonstrated the dynamic inductive charging technology in the Slide-in Electric Road System-Inductive project, which was partially funded by the Swedish Energy Agency [Sweden Viktoria ICT]. The test track system, as shown in Figure 9, has been developed to test the functionality of dynamic inductive power transfer for long-distance heavy-duty vehicles and to justify the infrastructure costs. A 300-meter test track of with four 20-meter highway segments has been built. A Scania diesel hybrid long-haul truck equipped with a Bombardier inductive power transfer system was demonstrated on the test track (shown in Figure 10). The hybrid truck has a 120-kW electric motor and a 100 kWh battery pack. The dynamic inductive charging system is capable of delivering 200 kW onboard over 85 mm or 100 mm air gap with efficiency up to 90%.

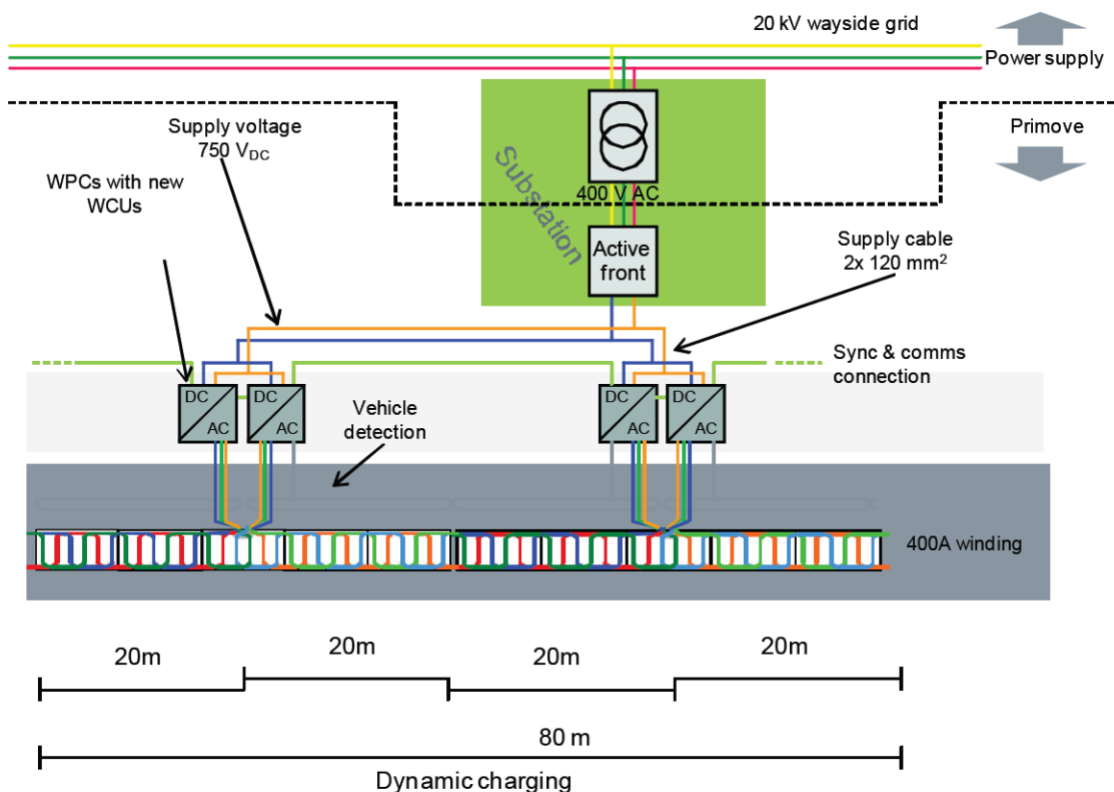

Figure 9. Swedish dynamic inductive charging test track system [Source: Sweden Viktoria ICT]



Figure 10. Electrified test track with PRIMOVE and Scania Truck [Source: Sweden Viktoria ICT]

3.4 Cost

The estimated dynamic inductive charging infrastructure cost varies between a few hundred thousand dollars per mile to tens of million dollars per mile [APPM, Brecher, Deflorio, Highways England, Fuller, Jang, Lu, Navidi, Qiu, Shekhar, Shin, and Swedish Viktoria]. The Highways England's feasibility study showed that under different traffic conditions and an assumed scenario for vehicle and technology penetration, average power demand from dynamic inductive charging systems can be as high as 0.5MVA per mile with maximum daily power requirements being approximately 4-4.5 MVA/mile. Based on the assumed infrastructure scenario, the estimated cost for dynamic inductive charging infrastructure could vary between £350,000 and £425,000 per km (\$0.9-1.1M/mile at 1£=\$1.5). Research at The Delft University of Technology (TU Delft) study shows that passenger vehicles can charge up to a maximum of 30 kW. For heavy-duty vehicles, capacity begins at 50 kW and runs up to 200 kW and the cost of dynamic inductive charging infrastructure is roughly €300,000–€500,000 per linear kilometer (\$0.6-1M/mile at €1 = \$1.2), not including the system's installation in the vehicle and any associated conversion required. Shin's study shows that the estimated mass production costs are \$235,790/km for the OLEV infrastructure and approximate \$89/kW for the power receiver unit. This estimated infrastructure cost is very low mainly due to the relatively low power requirement and no new power supply substation needed. Fuller reported that existing cost estimates of dynamic inductive charging infrastructure is between \$2.3 M and \$3.2 M per lane mile, and presented an original cost estimation of \$3.4 M per lane mile. In his 2016 Transportation Research paper, a conservative estimate of \$4 M per lane mile was used in his cost optimization approach.

Swedish Viktoria ICT's study broke down the system cost into power supply infrastructure cost and road power transfer installation cost. The estimated average load for the electrified highway near Jonkoping is about 0.96-1.4 MW/km based on maximum hourly traffic flow multiplied by a safety factor of 2. The power supply infrastructure cost for transforming the 130 kV AC to the 750 V DC is 20.7 MSEK/km (\$4.2M/mile @ 1SEK=\$0.128 in 2014) for maximum load case and 7.2 MSEK/km (\$1.5M/mile) for the average load case. For road installation of the

Bombardier dynamic inductive power transfer system, both full inductive charging – 100% of roadway covered with inductive charging and opportunity inductive charging – 35% of roadway electrified with inductive charging were analyzed. The cost of road installation for full inductive charging is approximately 56MSEK/km (\$11.5M/mile for both directions). Thus, the total system infrastructure cost including 130 kV power transmission substations, road side substations, and road installation is 77 MSEK/km (\$15.8M/mile route) for maximum load case and 63 MSEK/km (\$12.9M/mile) for average load case, which do not include the costs of control systems and payment solutions. The cost for the average load case could be reduced from 63 MSEK/km (\$12.9M/mile) to 39 MSEK/km (\$6.1/mile) taking the volume effect into account. For opportunity inductive charging, road installation cost could be reduced from 56MSEK/km (\$11.5M/mile) to 36 MSEK/km (\$7.4M/mile).

The costs of dynamic charging infrastructure vary with peak traffic flow, vehicle types, charging demands, and road electrification coverage. Peak power demands for the electrified highway determine the cost of power supply installation. Road installation cost heavily depends on power demands and road electrification coverage. Road installation dominates the total infrastructure cost.

3.5 Efficiency

Power transfer efficiency of dynamic charging infrastructure affects the maximum power requirement from utility grids. It is related to the air gap between the receiver mounting on the underbody of the vehicle and the power transmitter embedded in the road. The OLEV 100 kW dynamic inductive charging system achieved 85% maximum power transmission efficiency while maintaining a gap of 17 cm, and only 80% at a distance of 26 cm. The Delft University of Technology (TU Delft) study shows that it is possible for stationary wireless charging to achieve an efficiency of greater than 90% at a coil distance of 20 centimeters. The TU Delft system achieved roughly 85% efficiency in a dynamic inductive charging test set. Germany's Fraunhofer Society has even managed to achieve 93% efficiency. Bombardier's PRIMOVE system demonstrated 183 kW power transfer over 85-100 mm air gap with efficiency about 80-90% without system optimization. The Swedish Viktoria ICT study estimated that the total traction efficiency of the dynamic inductive charging is 68.8 to 77.4% from the 130kV grid to the truck wheel based on calculated PRIMOVE efficiency of 78.6 to 88.4%.

3.6 Challenges

Dynamic inductive charging uses the same basic technology as used for the stationary inductive charging. Thus, it faces some common challenges with stationary wireless charging plus specific challenges from in-road dynamic charging, including:

- Acceptable power levels depending on vehicle types and classes
- Power flow management depending on traffic flow and vehicle types
- Pulsating charging power caused by frequent switching on and off of the wireless power supply

- Power fluctuations introduced by traffic flow and their impacts on grid stability
- Harmonics generated by the wireless inductive power supply systems
- Infrastructure integration and its impacts on highway maintenance [Qiu, Miller]

These challenges must be carefully addressed before in-road dynamic inductive charging can be deployed. Given the state of testing and demonstration projects, it could be many years before inductive charging systems are ready for large scale roll-outs.

4. Catenary Electric Trucks

4.1 Technology

Overhead catenary wire systems have been widely used for trolley buses, light rail transit trains, and high speed trains for many decades due to their high efficiency. Truck trolley systems are often seen in mining facilities for off-road mining trucks to haul materials such as coal and ore. Overhead catenary power supply systems can use either DC or AC. 25 kV AC catenary wires are commonly used in high speed railway electrification systems for high efficiency over a long distance. A stepdown transformer and AC/DC converter are required onboard the train. Most modern light rail transit trains and trolley buses use DC currents, but require closely spaced DC converter stations for reducing catenary wire resistive losses. Several voltage levels have been utilized for catenary electric systems depending on power levels and power substation spacing. Typically, 750 V DC overhead catenary wires are widely used in modern electric trolley buses and light rail transit trains in urban areas where power distribution systems exist. Catenary electric systems feature higher power transfer rates with higher efficiency compared to other electricity transfer approaches.

Catenary electric technology for long-haul freight truck applications is similar to that of bus trolley lines and light rail transit catenary systems. The catenary power supply is made up of high voltage transmission substations with spacing of up to 40 miles and low voltage roadside traction substations at a distance interval of about 1 mile. The traction substation consists of a stepping down transformer, a rectifier and some protection equipment, which converts high AC transmission voltage into low DC voltage, typically 750 V for modern catenary systems. The catenary wires that are connected to the traction substation provide DC power to the truck's pantograph. For a long-distance catenary system, several power distribution substations may be needed to increase system stability and reduce transmission loss.

4.2 Current Status

Overhead catenary technology is mature and well developed. Combining efficient catenary power supply technology with the flexibility of highway transport could make electric truck freight transport more efficient. However, the feasibility of long-haul trucks interfacing with catenary wires is not clear. In 2012, Siemens presented an eHighway concept including trucks and electric infrastructure. The eHighway solution uses overhead catenary wires with 750 V DC,

widely adopted for trolley buses and light rail transit systems. Electric trucks connect to the overhead catenary wires by a type of active pantograph, which can detect catenary wires and connect/disconnect vehicles at high speed. Siemens’s eHighway technology was tested in two catenary electric truck demonstration projects, Sweden’s eHighway and California’s eHighway. Various powertrain architectures, including diesel hybrid, natural gas hybrid, and battery electric trucks, have been demonstrated in real-world operations.

Sweden's eHighway

In 2016, Sweden tested the world’s first catenary system for heavy-duty trucks on a public road. A 1.25-mile stretch of the right lane of the E16 highway near the city of Gavle, north of Stockholm was electrified, featuring a 750 V DC overhead catenary system provided by Siemens. Two diesel-hybrid trucks were adapted to operate under the catenary system in real-world conditions. There is no separation between the electrified lane and other lanes for conventional cars and trucks, as shown in Figure 11. This two-year demonstration project includes two Scania G360 trucks. The trucks were modified to pull power from the overhead wires with active pantographs from Siemens, which can connect and disconnect at speeds up to 90km/h. The Scania G360 trucks are hybrids, with 9.0-liter diesel engines configured to run on biofuel as well as electric motors. The hybrid powertrains will allow the trucks to operate in all-electric mode while connected to the catenary wires, and in hybrid electric mode while running on non-electrified lanes as well.



Truck model:	Scania G 360 4x2, weight 9.0 ton
Powertrain:	Parallell hybrid, integrated in the gearbox (GRS895)
Engine:	9-litre, 360 hp (runs on biofuel)
Electric motor:	130kW, 1050Nm
Battery:	Li-Ion 5 kWh (gives a driving range up to 3 km when not running on the e-way)
System	700V

Figure 11. Sweden’s catenary electric truck project [Source: www.scania.com]

California eHighway

In 2015, a similar catenary system spanning the ports of Los Angeles and Long Beach was developed in Carson, CA to demonstrate zero-emission truck movement between the ports and near-dock rails facilities on a regional level. According to the South Coast Air Quality Management District, the near-term project goal is to deploy catenary systems along CA-47/103 freeways to reduce pollutant emissions around the dock rail yards. The long-term goal is to develop a zero-emission truck corridor along the I-710 and CA-60 freeways from the ports to East Los Angeles, as shown in Figure 12. The trial catenary system is one-mile long in both directions along Alameda Street in Carson. The system uses 750 V DC power and is powered by a DC power substation with a capacity of 1.5 MVA. Four trucks are being modified to equip pantographs and will be demonstrated soon:

- Volvo Mack Class 8 diesel parallel hybrid
- BAE/Kenworth Class 8 CNG parallel hybrid
- TransPower CNG series hybrid (ElecTruck truck with a CNG engine/generator range extender)
- Transpower battery electric (Class 8 ElecTruck with reduced battery)

All these trucks have the ability of operating on electricity from the overhead catenary system and can also be driven on conventional roads using internal combustion engines or onboard batteries.

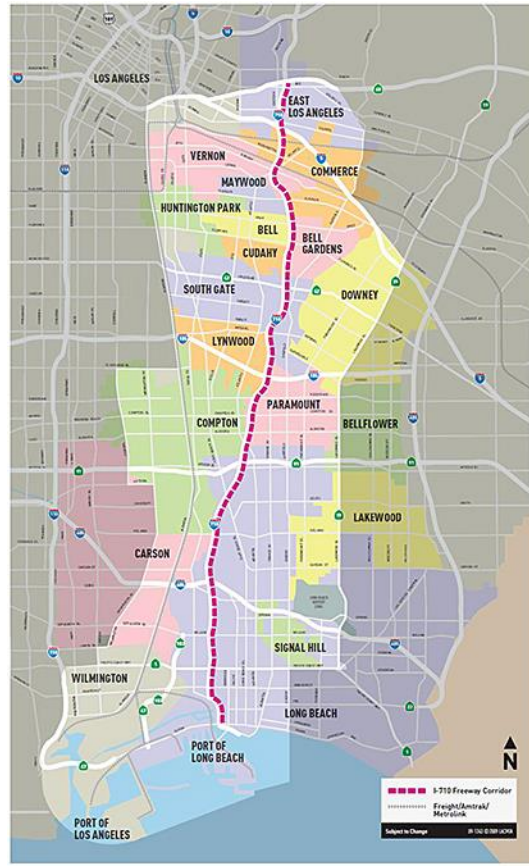
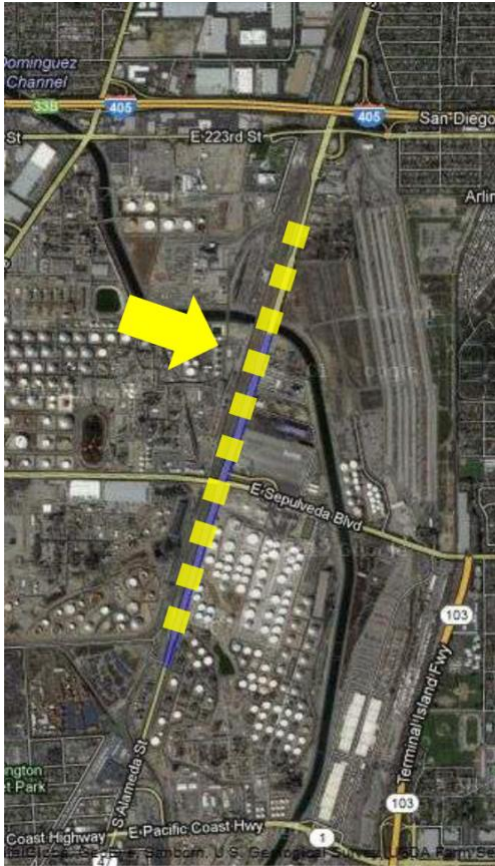

Near-term demonstration project in Carson Future demonstration from LB port to East LA

Figure 12. Southern California eHighway project [Source: www.aqmd.gov]

4.3 Cost

Like the dynamic inductive charging system, the infrastructure cost for the catenary power supply system can also be broken down into two parts: power supply infrastructure cost and roadside installation cost.

Building railway overhead catenary systems can be very costly. SYSTRA/COWI'S study estimated that the costs of the catenary system varies between €0.8-1M/km (\$1.6-2.1M/mile at €1 = \$1.35 in 2014), depending on its construction (single or double copper wire) and pole location (Axial or lateral). The estimated cost from trains.com is about \$1 million per mile, assuming that there are no significant distribution substations to be built and no tunnel or bridge clearance work involved. Boer's study (2012) estimated that the catenary electric system costs in the range of 2-3 million euro per highway km (\$4-6M/mile at €1 = \$1.27) for two highway lanes. Isaac's study indicated that the railway catenary costs vary between \$1.25M/mile and \$8.8M/mile and two significant contributors to the high costs of electrifying railway infrastructure are right-of-way worker protection insurance and the need to work around existing, operating trains, which leads to low levels of productivity during daytime.

Highway systems are different than railway systems in terms of utilization and construction. Road traffic flow is more unpredictable than rail traffic. Truck traffic flow in major California freight corridors varies between several thousand trucks and several ten thousand trucks with 5+ axles per day [Caltrans]. High capacity catenary infrastructure with new power plants is needed to satisfy peak traffic demand of electric trucks. Further, catenary systems for double-track railways that have one track in each direction with two tracks positioned closely require only one set of catenary support systems. Electrified opposing truck lanes on divided highway are usually separated by wide median strips or central reservation and require separate catenary support systems. Therefore, weighing all these factors, catenary system construction costs for highway freight transport may be double the construction cost of electrifying railways. According to Swedish Viktoria ICT's study, the power supply infrastructure cost for transforming the 130 kV AC to the 750 V DC is \$4.2M/mile for maximum load case of 2.2MW/mile and \$1.5M/mile for average load case of 1.5MW/mile. The road installation cost for building the roadside overhead catenary system depends on percentage of roadway electrification coverage. There is no robust road installation cost data available. Overall, we assume a cost of about \$1.2 trillion to cover 500 miles of roadway at 50% coverage in both directions.

4.4 Challenges

Overhead catenary wires along highway systems for long-haul truck applications are rare due to several challenges. The trucks equipped with active pantographs must have the ability of detecting and connecting and disconnecting overhead catenary wires at varying high speeds. The power demands from road loads heavily depend on traffic flow. Therefore, catenary wires need to meet extreme traffic conditions and might require new power plants built close to avoid high power losses on power transmission lines. Building overhead catenary systems for long-haul trucks along highway systems may require higher height clearance at bridges or in tunnels, which may incur costly remedial work. All these will increase capital expenditure of electrifying current highway systems. As roll-out occurs, costs will come down, but the chicken-or-egg nature of developing wide-spread catenary systems and trucks that can run on them may make this a slow process.

5. Hydrogen Fuel Cell Electric Trucks

5.1 Technology

A variety of fuel cell technologies has been commercially developed. Two fuel cell technology options are considered for transport applications: polymer electrolyte membrane fuel cells (PEMFC) and solid oxide fuel cell (SOFC). They are defined largely by their operating temperature. PEMFC operates in the temperature range of 60 to 120 °C, which means that the warm up time of fuel cells is very short. However, low temperature operation of a PEMFC requires pure hydrogen as the fuel. SOFC has operating temperatures of 650 to 1,000 °C, which means that it takes a long time to bring the system up to operating temperature. Due to the

high temperature, SOFC can use a variety of fuels such as hydrogen, methane, and other light hydrocarbon fuels that can be internally reformed. Currently, the SOFC is only considered for long-time high power applications such as locomotives. In most cases, PEMFC is usually paired with a battery to form the PEMFC/battery hybrid system used in passenger cars. Thus, the fuel cell power can be sized based on the average power, which is less than the conventional diesel engine power level. A battery is used to initiate fuel cell start-up and supplement the power generated by a fuel cell.

There are two types of fuel cell battery hybrid configurations [CARB 2015]. One configuration is the battery dominant configuration, in which a small fuel cell acts as a range extender to charge the battery when the battery is depleted below a set level. In this case, the battery is mainly charged from the external power grid. The vehicle operates as a series hybrid with most of the electricity coming from the battery. This configuration is usually used for short haul applications such as drayage trucks. The other configuration is fuel cell dominant, in which a full-size fuel cell is used as primary electricity source and the battery is used to provide peak power and recouping energy from regenerative braking. Both the fuel cell and the battery are used in parallel to provide electricity to the motor to drive the vehicle. The fuel cell dominant configuration is most suitable for long-haul freight trucks using hydrogen as the sole energy source. Currently there are relatively few demonstrations of hydrogen fuel cells in trucks, but a greater number in transit buses.

5.2 Current Status

In 2009, Vision Motor Corporation developed the first hydrogen fuel cell powered Class 8 truck - Tyrano. The Tyrano truck, shown in Figure 13, is a plug-in hybrid fuel cell electric truck demonstrated for drayage operation in the Port of Long Beach. The Tyrano could reach 65 mph using a 65 kW fuel cell and a 200-mile range with a standard 350-bar tank (5000 psi) carrying 20 kg hydrogen. It also had a 130 kWh battery pack with a level 2 charger. In 2011, a national trucking company - Total Transportation Services Inc. tested the Tyrano fuel cell trucks in the ports of Los Angeles and Long Beach in California. Unfortunately, Vision Motor filed for bankruptcy in 2014 primarily due to its inability to make a profit. However, the demonstration of Vision's Tyrano trucks showed the feasibility of hydrogen PEMFCs for short and medium range hauling in heavy-duty truck applications between port terminals and distribution facilities. Thus hydrogen fuel cell powered trucks are an impressive option for reducing both GHG and polluting emissions from heavy-duty trucks.

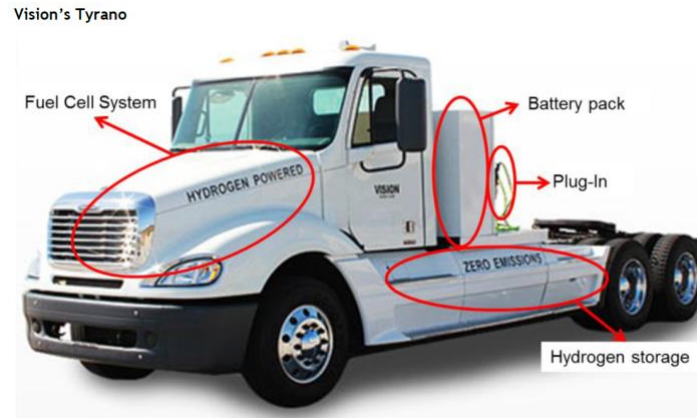

Source: Vision Motor Corp., 2012.

Figure 13. Vision's Tyrano plug-in fuel cell truck [Source: Vision Motor Corp]

Using improved technology for the batteries and fuel cell, a complete new design of a fuel/battery hybrid Class 8 semi-tractor - Nikola One - was built by the Nikola Motor Company in 2016. The Nikola One and its drivetrain arrangement are shown in Figure 14 and Figure 15, respectively. The truck is powered by a 300 kW electric motor with electricity provided by a 320 kWh battery and a 300 kW fuel cell. It is equipped with a DC fast charging port to charge the battery if a charging facility is available. The Nikola truck claims a range of 800-1,200 miles depending on terrain and load, including 100-200 miles on the battery alone. The capacity of the hydrogen tank is not stated in the description of the vehicle, but a tank carrying at least 100 kg hydrogen would be needed for range of 1,000-mile if the onboard battery is not charged through external power sources.



Figure 14. Nikola One hydrogen fuel cell truck [Source: nikolamotor.com]

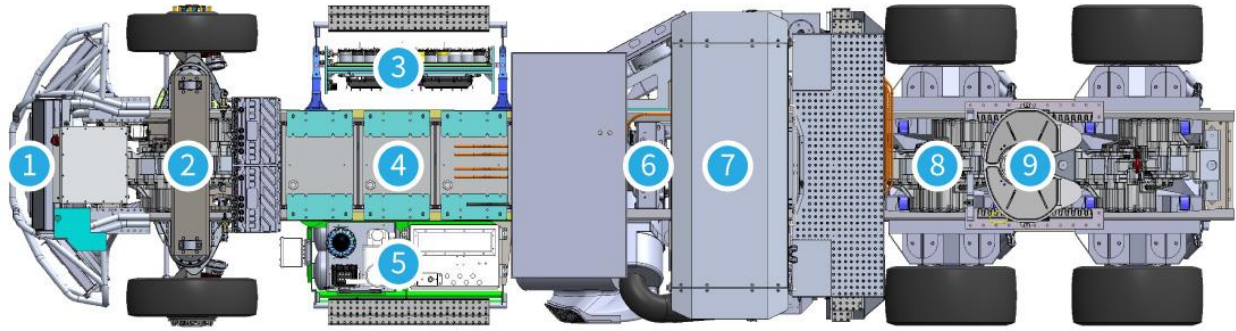

Figure 15. Nikola One drivetrain arrangement [Source: nikolamotor.com]

① front radiator assembly; ② front motor gearbox; ③ power electronics; ④ battery storage system; ⑤ chiller and air tanks; ⑥ fuel cell; ⑦ hydrogen fuel system; ⑧ rear motor gearbox; ⑨ 5th wheel

The two Class 8 fuel cell truck prototypes are compared in terms of specifications and performance in Table 3. The Vision Tyrano truck used relatively small fuel and was a battery dominate design. The Nikola One truck has a full-size fuel cell and is a fuel cell dominate design, which can be operated in the battery only mode for up to 200 miles. It was built from the ground up and can outperform conventional long-haul diesel class 8 truck on the market today. Nikola Motor has partnered with Ryder System to sell and service its fuel cell trucks at Ryder’s nationwide locations.

Table 3. Specification and Performance Comparison of Tyrano and Nikola One

Fuel Cell Trucks	Tyrano	Nikola One
Motor	320 kW	2 motors with power up to 750 kW
Fuel Cell	65 kW	300 kW
Battery	130 kWh	320 kWh
Hydrogen Fuel	20 kg compressed hydrogen at 350 bar	Not available (estimated 100 kg) in compressed or liquid hydrogen form
Refuel Time	10-15 minutes at 430 bar	15 minutes (Nikola Stations)
Charging Port	Level 2	DC Fast
Range	200 miles	800 - 1,200 miles
Weight	Not available	2,000 lbs lighter than a diesel truck
Application	Class 8 short-haul semi day cab	Class 8 long-haul semi sleeper cab

5.2 Cost

Despite important improvements in fuel cell technologies over the past decade, automotive fuel cell systems still face challenges. Several factors may limit the potential application of fuel cell technologies in the near term for heavy-duty vehicles. Cost, durability, energy density of hydrogen storage, and a large vehicle assessable hydrogen refueling network are major concerns for long-haul fuel cell electric truck applications. For hydrogen fuel cell electric trucks to be competitive with conventional diesel trucks, costs must be reduced for all system components, especially the fuel cell, onboard hydrogen storage, and the hydrogen fueling stations.

According to DOE's FY 2016 Annual Progress Report on hydrogen and fuel cells, the expected cost of the automotive (i.e., cars, not trucks) PEMFC system is approximately \$230/kW in 2016 based on current technology when manufactured at a volume of 1,000 units per year. DOE projects that the present fuel cell system cost could be reduced to \$53/kW for high volume manufacturing at 500,000 units per year. The target cost for high volume manufacturing in 2020 is \$40/kW. This cost is for automotive fuel cell systems, not heavy-duty units to be used in trucks.

5.6 Challenges

To enable commercialization of heavy-duty fuel cell trucks, fuel cell systems must nearly meet the durability of the stationary systems, which currently last at least 10,000 hours. For long-haul Class 8 trucks with annual miles of 104,000 miles, with an average on-and-off highway speed of 65 miles per hour, the annual operation would be 1600 hours and thus the fuel cell would need at least a 8000 hours durability threshold to avoid replacement before 5 years. There is also some question regarding the differences in the durability in trucks and passenger cars. Based on recent tests, it appears likely that PEMFC technologies will be ready to satisfy the durability needed to power long-haul Class 8 trucks.

Several approaches for storing hydrogen onboard the truck have been developed, including high pressure, low temperature cryogenics, metal hydrides, absorbent carbons, etc. Compressed hydrogen (5000-10000 psi) in carbon fiber re-enforced composite tanks and hydrogen as a cryogenic liquid at 20 deg K in insulated tanks are the established technologies and thus have been the main hydrogen storage technologies used onboard vehicles. Current efforts focus on reducing the cost of the carbon fiber composite, which is approximately 75% of the cost of the compressed hydrogen storage tank. Cryogenic hydrogen storage may be the best approach for heavy truck applications because of its relatively high volumetric energy density, but it requires further development in thermal insulation and engineering work on the various system tradeoffs including energy for liquefaction and boil-off effects [DOE, Melaina, Stetson]. Table 4 lists the DOE targets and current status of various hydrogen storage technologies.

Table 4. Current Status of Hydrogen Storage Technologies [Source: Stetson]

Storage Targets	Gravimetric kWh/kg (kg H ₂ /kg system)	Volumetric kWh/L (kg H ₂ /L system)	Costs \$/kWh (\$/kg H ₂)
2020	1.8 (0.055)	1.3 (0.040)	\$10 (\$333)
Ultimate	2.5 (0.075)	2.3 (0.070)	\$8 (\$266)

Projected H ₂ Storage System Performance (5.6 kg H ₂ usable)	Gravimetric kWh/kg (kg H ₂ /kg system)	Volumetric kWh/L (kg H ₂ /L system)	Costs* \$/kWh (\$/kg H ₂)
700 bar compressed (Type IV, Single Tank)	1.4 (0.044)	0.8 (0.024)	\$15 (\$500)
Metal Hydride (NaAlH ₄ /Ti)	0.4 (0.012)	0.4 (0.012)	\$43 (\$1,432)
Sorbent (MOF-5, 100 bar, MATI, LN2 cooling)	1.3 (0.04)	0.7 (0.020)	\$16 (\$533)
Chemical Hydrogen Storage (AB-50 wt.%)	1.4 (0.043)	1.3 (0.040)	\$17 (\$566)

* projected at 500,000 units per year (light-duty vehicles)

The 2020 energy density and cost targets for automotive onboard hydrogen storage systems is 1.8 kWh/kg system (5.5 wt%), 1.3 kWh/L system (0.04 kg H₂/L), and \$10/kWh (\$333/kg stored hydrogen capacity) respectively. A long-haul fuel cell truck would need to carry at least 70 kg hydrogen (95% usable) for an maximum daily range of 500 miles. The hydrogen storage unit would be large (1600 kg, 3000 L) and cost about \$35,000 based on the values given in Table 4 for the 10000 psi hydrogen storage tank. The size and cost of hydrogen storage is a major problem for fuel cells in long-haul trucks. Little information is available on the characteristics of hydrogen storage tanks developed for the truck applications.

California has most of the nation’s existing hydrogen fuel facilities. These hydrogen stations typically dispense hydrogen at 1-2 kg per minute, primarily designed for fueling light-duty passenger cars. There are no hydrogen stations for heavy-duty truck applications at highway truck stops. Currently there are three ongoing fuel cell electric bus demonstration projects in California [Eudy]: Alameda-Contra Costa Transit (13 buses), SunLine Transit (4 buses), and University of California Irvine (1 bus). Only AC Transit’s stations can fill hydrogen at rates up to 5 kg per minute. Hydrogen fueling stations could be scaled up for trucking applications including fueling stations at highway truck stops and in commercial trucking fleet depots. However, deployment of hydrogen stations for trucking applications would take time to construct and require large investment. A light-duty vehicle hydrogen station with a fueling capacity of 180 kg of hydrogen per day presently costs about \$2 million, which is about \$11,000 per kg hydrogen

per day. This per-capacity capital cost could be reduced to \$7,000 per kg per day for larger stations due to the economies of scale for larger stations.

6. Comparison of Three Zero-Emission Highway Trucking Technologies

6.1 Modeling Concerns and Inputs

Zero-emission long-haul trucks that employ dynamic inductive and catenary electric charging and hydrogen fuel cell technologies have many similarities. All three technologies use electric traction to propel trucks and require a battery buffer system. However, the concepts differ in the use of the energy carrier and the power sources. The fuel cell trucks carry hydrogen onboard and employ the fuel cell to convert hydrogen into electricity; the catenary electric trucks and dynamic charging electric trucks are powered by external power sources. In order to compare these technologies, a study was performed to estimate the truck capital cost and the operations and maintenance (O&M) and related infrastructure costs for each of the technologies. An Excel based cost spreadsheet was developed for calculating major component costs and O&M costs of the zero-emission trucking technologies and assessing the capital and O&M costs of the related infrastructure.

Fully electrified highway systems could provide continuous energy transfer to the trucks. Electrifying highways for long-haul freight trucks requires large investments in stringing overhead catenary power lines for catenary electric trucks and embedding wireless power transfer strips underground on major highways. Considering multiple pathways toward zero-emission freight transport and possible low infrastructure utilization, partial electrification of highways could reduce the investment costs significantly. Electrification is often constrained by specific requirements. For example, catenary electric trucks and high voltage catenary power supply systems may create clearance issues, especially under bridges and tunnels. Some highway segments may not be suitable for installing source coils in the road for wireless inductive charging. These special needs would significantly increase the cost of electrifying highways. Partially electrifying highways may avoid some infrastructure limitations.

Figure 16 illustrates the concept of a partially electrified highway. The electrified highway consists of electrified zones and non-electrified zones with fixed lengths. Each electrified zone requires a power distribution substation, which steps down the high transmission voltage of 115 kV to a 60 kV line and provides power up to 80 MVA. The electrified zone is further broken down into smaller traction segments which are about one mile long. A traction substation rated for 1 MW, consisting of a transformer and several rectifiers or inverters, is placed to serve in each traction segment to convert high voltage AC power to 750 V DC power for the catenary power wires or roadside wireless power transfer transmitters. The ideal length of electrified zones is between 15 and 40 miles, depending on traffic flow. In the electrified zone, electric

trucks operate in driving-while-charging mode, and the onboard batteries are fully charged and the truck is powered by external power sources via overhead catenary lines or wireless inductive power systems embedded in the road. In the non-electrification zone, the electric truck runs on the onboard batteries. The onboard battery allows the truck to smoothly move from one electrified zone of a highway to another over a long journey.

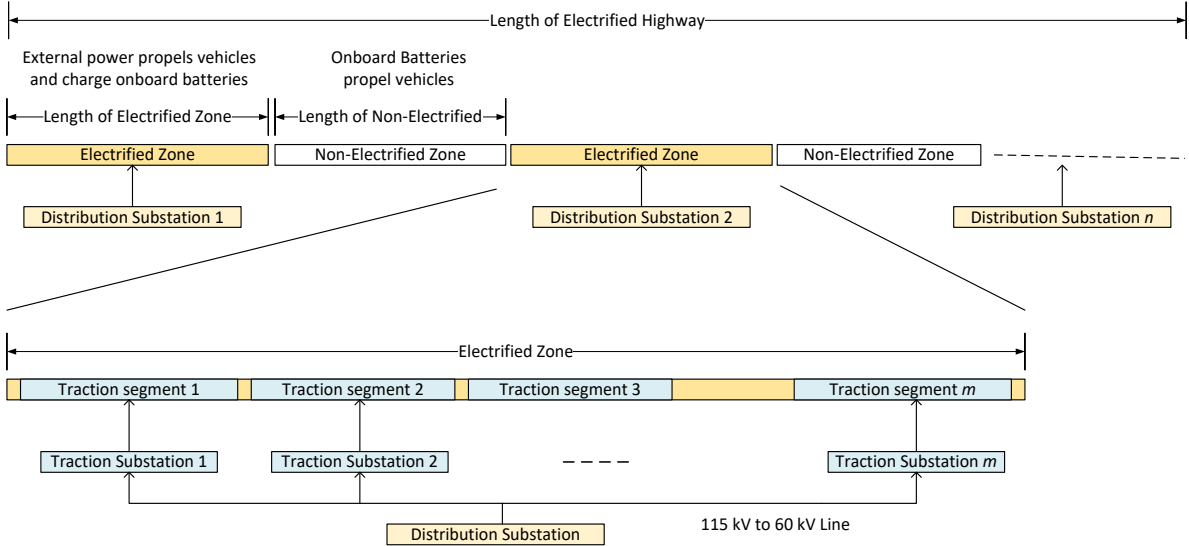

Figure 16. Scenario layout for partially electrified highway

Roadway electrification coverage is defined as

$$= \frac{\text{electrification coverage}}{\text{length of electrified zone} + \text{length of non electrified zone}}$$

Since deploying catenary lines and embedding wireless inductive source coils dominate the capital cost of catenary and dynamic charging systems, the roadway electrification coverage affects the capital cost of the catenary and dynamic charging infrastructure. The lower the electrification coverage, the lower the infrastructure capital cost. However, lower electrification coverage requires larger onboard battery storage (kWh) and higher battery charging power (kW). The higher charging power may be several times of average truck traction power, which requires larger space for mounting receiver pads for dynamic charging.

Hydrogen storage is a crucial barrier for adopting hydrogen fuel cell freight trucks. Current hydrogen storage systems are short of meeting DOE 2020 target cost of \$10/kWh and target performance of 1.3 kWh/L system (0.04 kg H₂/L) and 1.8 kWh/kg system (5.5 wt.% hydrogen). Due to limited onboard space and cost considerations, hydrogen fuel cell trucks will likely carry enough hydrogen only for 500 miles or less. Therefore, development of hydrogen fuel station infrastructure along major highways would be necessary to support hydrogen fuel cell freight trucks. The layout of hydrogen fueling stations along highways is shown in Figure 17.

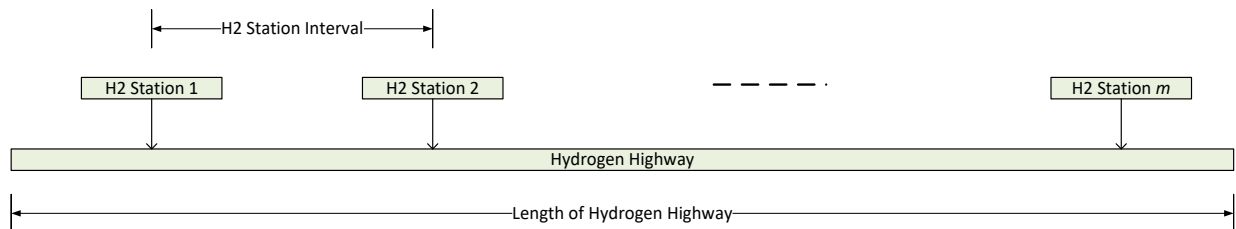

Figure 17. Layout of hydrogen fueling stations

According to Caltrans 2015 annual average daily truck traffic data, the major freight corridors in California carry several thousand trucks with 5+ axles per day. A daily traffic flow of 5,000 Class 8 freight trucks with an average speed of 65 mph is considered in analyzing average infrastructure power demand and daily energy consumption. Table 5 shows major parameters and key characteristics of three types of zero-emission long-haul trucks and their related infrastructure. It also shows the configuration and power and energy consumption of the three types of zero-emission trucks. A conventional diesel truck with a fuel economy of 8.1 mpg was also included for comparison. The energy consumption of the fuel cell electric long-haul truck is higher due to the lower fuel cell efficiency of 65% in comparison to the catenary electric and

dynamic charging electric truck. The electricity consumption of the dynamic charging electric long-haul truck is 2.9 kWh/mile, higher than that of the catenary electric truck, 2.55 kWh/mile because of lower dynamic charging efficiency of 85% for a 17-cm air gap. These energy demands cover nearly all energy uses of the trucks, although heating/cooling is neglected as it is generally a very small share of truck energy use.

6.2 Truck Capital Costs and O&M Expenses

The truck capital costs depend to a large degree on the costs of the truck glider and the main components of the powertrain. A simplified cost breakdown analysis was used to calculate the costs of zero-emission trucks and diesel trucks for year 2030, as shown in Table 5. For the hydrogen fuel cell technology, the power sources are the fuel cell and the buffer battery. The fuel cell provides average continuous power and the battery supplies high peak power demand. Long-haul fuel cell trucks need a 300 kW fuel cell and carry 72 kg hydrogen for covering a range of 500 miles at 65 mph. A 50 kWh battery is chosen for buffering peak power demand in an optimized efficiency system. Our truck cost analysis shows that a hydrogen fuel cell truck in 2030 would cost \$176K compared to a conventional diesel truck, \$142K.

For catenary electric trucks and dynamic charging electric trucks, the onboard battery is charged on the electrified zones and depleted during operation on the non-electrified zones. Hence, the battery is sized according to the length of the electrified zones, roadway electrification coverage, and traction power demand. Based on 2.5 kWh/mi truck electricity consumption and 20-mile charging/non-charging segments, a 50 kWh battery should be sufficient for the vehicles to travel on pure battery power when not operating on grid power. In addition, another 50 kWh is included for the truck to travel to its terminal and other locations off the electrified highway. Thus a 100 kWh battery pack is assumed.

For a partially electrified highway with the electrified zone of 20 miles and the electrification coverage of 50%, the costs of a catenary truck and a dynamic charging truck are \$143K and \$144K, respectively, which are competitive with the price of a conventional diesel truck. In the cost analysis, the cost of heavy-duty fuel cell is taken as \$80/kW which is two times the DOE estimate of the cost of fuel cells for passenger cars in 2030 and the cost of the hydrogen storage is taken as \$500/kg H₂ as shown in Table 4 for high pressure hydrogen tanks in volume production. The cost of the batteries was taken as \$300/kWh which is about a factor of two higher than is presently projected for batteries in passenger car EVs.

Annual fuel expenses and maintenance costs of freight trucks depend on fuel economy, duty cycles, fuel types, and powertrain configurations. The annual O&M costs of long-haul trucks with annual mileage of 104,000 miles are considered and compared in Table 5.

The cost of hydrogen depends on how hydrogen is produced. Production of hydrogen from water electrolysis using renewable power is the preferred long-run approach since this

hydrogen could be very low carbon if the electricity from which it is produced is very low carbon. However, H2 production costs from electrolysis could be considerably higher than from natural gas reforming. In the near term even hydrogen from reforming may cost \$10/kg or more depending on fuel source, scale and other factors. Electrolysis could be \$20/kg or more. However with increased scale, experience and learning factors, costs are likely to drop. Ogden (2018) estimates a long-run “built-out” range of \$5-8/kg for hydrogen from electrolysis, including the price of electricity and all costs associated with producing, shipping, storing, and delivering this H2 to vehicles as liquefied H2. A 2030 dispensed hydrogen cost from electrolysis of \$7/kg in 2030 is adopted as a base case estimate for this study.

The yearly O&M expenses of hydrogen fuel cell trucks are about \$82K, approximately 36% higher in comparison to the diesel truck due to high fuel cell efficiency and low maintenance cost. The annual costs to operate a Class 8 long-haul catenary electric truck and dynamic charging electric truck are taken to be approximately \$48k - \$54K, about 10%-21% lower compared to the diesel truck because of low electricity price and low maintenance cost. We also define a 5-year truck cost to incorporate the resale value of trucks after 5 years. A 2% monthly depreciation rate is assumed. The resale value of H2 fuel cell, catenary electric, and dynamic charging electric trucks are further scaled down to 75% to reflect the uncertainty of their resale values due to new technology. We use 5-year truck costs as truck capital costs.

Since electrified zones and roadway electrification coverage affects battery size, reducing the length of the electrified zones and increasing electrification coverage would reduce the costs of catenary electric trucks and dynamic charging electric trucks. In this analysis, the electrified zone with fixed length of 20 miles is used. Figure 18 shows that the electric truck cost varies with the percentage of roadway electrification coverage. Catenary electric trucks and dynamic inductive charging electric trucks can be owned for about the cost of conventional diesel trucks if the roadway electrification coverage reaches 98% and 87%, respectively.

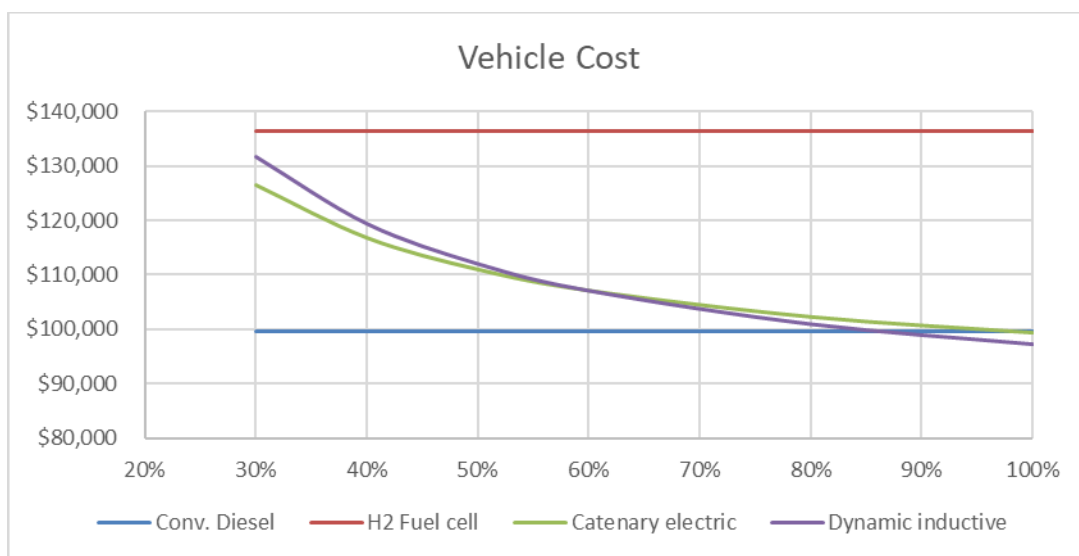

Figure 18. Vehicle costs vary with road electrification coverage

Table 5. Model Assumptions

Long-Haul Truck Configuration and Power Demand and Energy Consumption				
Long-Haul Truck Technology	Conventional Diesel	H2 Fuel Cell	Catenary electric	Dynamic Charging
Engine	300-450 kW (400-600 hp)	-----	-----	-----
Fuel Tank	125 gal. (125-300 gal)	-----	-----	-----
Aftertreatment	SCR + DOC + DPF	-----	-----	-----
Transmission	10 speed	2 speed	2 speed	2 speed
Fuel Cell (kW)	-----	300	-----	-----
Hydrogen Storage (kg H2)	-----	72	-----	-----
Battery (kWh)	-----	50	100	100
Motor & Controller (kW)	-----	350	350	350
WPT Receiver Capacity (kW)	-----	-----	-----	320
Active Pantograph Capacity (kW)	-----	-----	320	-----
Range (miles)	500	500	500	500
Average traction power (kW)	160	160	160	160
Power demand from grid (kW)	-----	-----	327	376
Truck efficiency @ 65mph (mile/gal or equivalent)	8.1	10.6	16.2	16.2
H2 truck efficiency (kgH2/mile)	-----	0.11	-----	-----
Catenary/WPT truck efficiency (kWh/mi)	-----	-----	2.5	2.5
Energy demand from grid (kWh/mi)	-----	-----	2.6	2.9
VEHICLE COMPONENT COST				
Fuel_Cell_Cost (\$/kW)		80		
H2_Storage_Cost (\$/kgH2)	-----	500	-----	-----
Battery_Cost (\$/kWh)	-----	300	300	300
Motor_Cost (\$/kW)	-----	15	15	15
Motor_Ctrl_Cost (\$/kW)	-----	10	10	10
WPT_Receiver_Cost (\$/kW)	-----	25	25	25
FUEL ENERGY DENSITY				
Diesel_Energy_Density	38.7 (kWh/gal diesel)	33.3 (kWh/kg Hydrogen)		
VEHICLE & COMPONENT PERFORMANCE SPECIFICATIONS				
FE_Diesel	8.1	-----	-----	-----
Fuel_Cell_Efficiency	-----	65%	-----	-----

WPT_Efficiency	----	----	----	85%
Catenary_Recifier_Efficiency	----	----	98%	----
Battery_kWh	----	50	100	100
INFRASTRUCTURE & TRAFFIC FLOW				
Roadway_Catenary_Coverage	----	----	50%	----
Roadway_WPT_Coverage	----	----	----	50%
Daily_Truck_Traffic (Truck/day)	5000	5000	5000	5000
Truck_Flow_Rate (truck/mile)	3.2	3.2	3.2	3.2
Daily_VMT (mile)	500	500	500	500
Fuel_Station_Intervals (mile)	50	50	----	----
Catenary_Power_Substation_No	----	----	13	----
WPT_Power_Substation_No	----	----	----	13
Power_Transformer_Unit_Cost (\$/MVA)	----	----	14,000	14,000
Power_Substation_Cost_Factor	----	----	4	4
Catenary_System/WPT Unit_Cost (\$/lane mile)	----	----	2,300,000	----
Catenary_Converter_Unit_Cost (\$/kW)	----	----	10	----
Catenary_Pantograph_Cost (per unit)	----	----	3,500	----
WPT_Zone_Length (mile)	----	----	----	20
Catenary_Zone_Length (mile)	----	----	20	----
WPT_Receiver_kW_Max (kW)	----	----	----	500
FUEL PRICES				
Diesel_Price (\$/gal)	3.776	----	----	----
Hydrogen_Price (\$/kg)	----	6	----	----
Electricity_Price (\$/kWh)	----	----	0.15	0.15
Truck Mileage (Long-Haul)				
Yearly_Mileage (mi/year)	104,000	104,000	104,000	104,000
Daily_Mileage (mi/day)	500	500	500	500
Truck_Speed (mph)	65	65	65	65
Truck Capital Cost (year 2030)				
Glider	\$95,539	\$95,539	\$95,539	\$95,539
Engine	\$21,881	----	----	----
Aftertreatment	\$15,750	----	----	----
Transmission	\$8,549	\$2,000	\$2,000	\$2,000
Fuel cell	----	\$24,000	----	----
Hydrogen storage	----	\$30,395	----	----
Battery	----	\$15,000	\$30,000	\$30,000
Active pantograph & converter	----	----	\$6,500	----
wireless charge receiver	----	----	----	\$8,000

Motor and controller	----	\$8,750	\$8,750	\$8,750
Truck Cost	\$141,719	\$175,684	\$142,789	\$144,289
5-year truck cost	\$99,550	\$136,477	\$110,924	\$112,089
Truck Yearly O&M Expenses				
Hydrogen (\$/kg)	----	6	----	----
Electricity Prices (\$/kWh)	----	----	0.15	0.15
Fuel Prices (\$/DGE)	3.78	6.97	5.81	5.81
Fuel cost per mile (\$/mile)	0.47	\$0.55	0.38	0.44
Yearly fuel cost (\$)	\$48,538	\$57,200	\$39,796	\$45,882
Truck Maintenance Cost (\$/mile)	\$0.07	0.05	0.035	0.035
Truck tires (\$/miles)	\$0.04	\$0.04	\$0.04	\$0.04
Yearly Maintenance cost (\$/year)	\$11,856	\$9,776	\$8,216	\$8,216
Yearly Truck O&M cost	\$60,394	\$66,976	\$48,012	\$54,098
Truck Costs per mile				
Capital Cost per mile	\$0.191	\$0.263	\$0.213	\$0.216
Energy Cost per mile (does not include infrastructure cost)	\$0.467	\$0.548	\$0.383	\$0.441
Maintenance Cost per mile	\$0.070	\$0.050	\$0.035	\$0.035
Total Costs per mile	\$0.728	\$0.861	\$0.631	\$0.692

Notes: Costs do not include infrastructure cost (shown in Figures 1 and 21) or any applicable tax. The analysis is done without taxes.

6.3 Infrastructure Capital and O&M Costs

The economic feasibility of zero-emission long-haul trucking technologies for large-scale applications depends on not only the vehicle cost but also on the cost of the required infrastructure. Since catenary electric freight trucks and dynamic inductive charging freight trucks are only being demonstrated for short distances, it is difficult and uncertain to assess the required adaptations of the existing infrastructure and the cost/investments needed to electrify highways at a large scale. Hydrogen infrastructure for passenger cars and for transit buses has been constructed, but hydrogen refueling infrastructure along highways for heavy-duty trucks has not been demonstrated yet. Therefore, robust cost figures for developing and maintaining these infrastructures for electrified heavy-duty trucks are not available.

6.3.1 Catenary Infrastructure

Since catenary electric trucks could use similar power supply systems for electric trolley buses and light rail transits, the past unit price for similar light rail catenary systems was adjusted for time and power capacity and used for approximately estimating the infrastructure cost of the catenary system for long-haul trucks. Light rail catenary systems cost approximately \$2.3M per route mile for double tracks with one set of catenary supports. \$4.6M per route mile (one electrified lane on each direction) is simply employed for estimating the cost of catenary

electric truck power supply systems in the analysis. The dynamic charging infrastructure could cost up to \$12.9M per mile for a fully electrified highway with an average load of 1.5 MW/mile. Considering partially electrification and mass production, the cost of inductive charging could be reduced to \$6.1M-\$7.4M per mile. A moderate cost estimate of \$6.4 million/route mile is used for the dynamic charging system. Maintenance costs of overhead catenary systems and in-road dynamic charging systems are estimated to be about 1% of the initial investment costs.

6.3.2 Hydrogen Infrastructure

Regarding hydrogen infrastructure there are many pathways to develop hydrogen fueling stations, hydrogen infrastructure costs for refueling heavy-duty trucks are difficult to estimate. Some studies estimate the costs of the hydrogen infrastructure based on the number of fuel cell vehicles that are to be served. For example, the hydrogen infrastructure cost is about \$5,000,000 for serving 40 fuel cell buses and its O&M cost is approximate \$5,000/bus/year. But hydrogen infrastructure to serve freight trucks will be large stations with fueling capacity of several thousand kg hydrogen per day. Their costs are highly dependent on scale and fueling capacity. In this study, the DOE H2A model was used to estimate the cost of a compressed hydrogen station with fueling capacity of 3,000 kg, which is approximately \$20M. The costs for a station that produces and stores liquid H₂ from electrolysis would be somewhat higher. The projected construction cost for each truck fuel station was scaled up to reach the needed capacity to serve 5000 trucks daily over 500 miles. Spacing the stations 50 miles apart, 10 stations would be needed. These are roughly estimated to cost \$75,000,000 each, including all aspects of converting electricity to hydrogen, liquefying and storing that hydrogen, and dispensing to the vehicles. Operational and maintenance costs of hydrogen infrastructure are related to the hydrogen delivered. A fixed O&M cost of \$0.27/kg is applied to hydrogen infrastructure.

6.3.3 Infrastructure summary

A 500-mile highway section with 50% electrification coverage and traffic flow of 5,000 Class 8 truck per day was analyzed for each zero-emission trucking technology. The estimated infrastructure costs and O&M costs are shown in Table 6. If all trucks were fuel cell running on hydrogen generated on site by electrolysis, the 10 needed stations would cost a combined \$750M. Yearly O&M costs would be \$25M. If all trucks are catenary vehicles on a highway with 50% electrification scenario of one lane in each direction, the catenary system cost and the O&M expenses will be \$1,150M and \$11.5M, respectively. The infrastructure cost of equipping two highway lanes with 50% electrification coverage in-road dynamic charging is estimated to be \$1,600M with annual O&M cost of \$16M. As shown at the bottom of the table, the net effects are on the order of \$0.11 per mile for hydrogen, \$0.13 for catenaries, and \$0.16 for dynamic charging.

Since the roadside installation costs of catenary systems and dynamic inductive charging systems dominate the total infrastructure cost, the capital cost of building partially electrified highway is approximately proportional to the total length of electrified zones, although savings

would accrue if more difficult-to-electrify sections (such as in tunnels) could be avoided. Here we assume linear scaling; Figure 19 and Figure 20 show the capital and O&M costs of electrified highways varying with roadway electrification coverage. Partial roadway electrification could significantly reduce the capital cost of electrifying highways. With more robust data available from demonstrations, a nonlinear cost model could be developed to obtain more accurate road installation costs for various road electrification coverages.

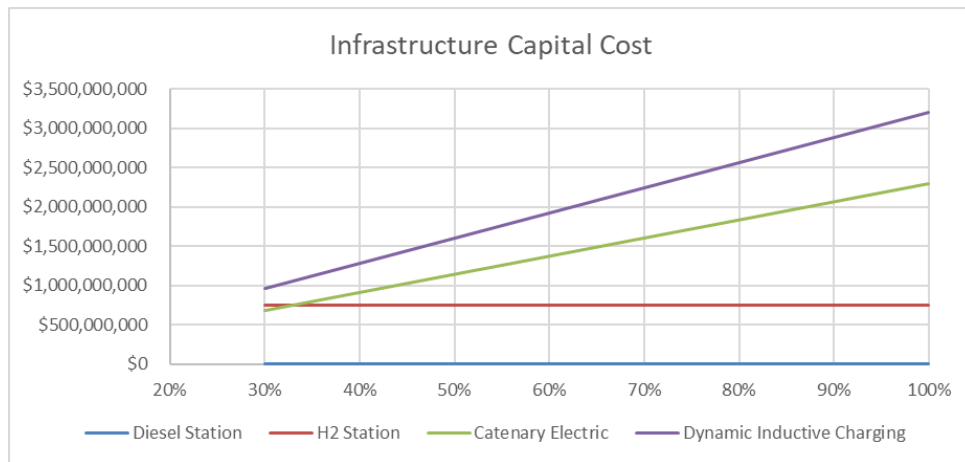

Figure 19. Infrastructure capital costs vary with road electrification coverage

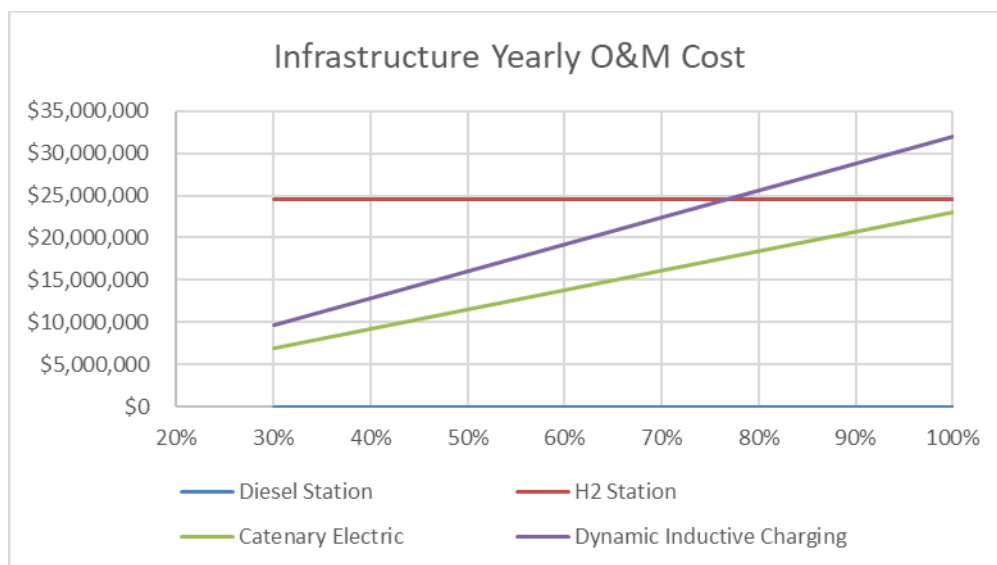

Figure 20. Infrastructure O&M costs vary with road electrification coverage

Table 6. Infrastructure Capital Cost for a 500-Mile Zero-Emission Highway Section

Infrastructure Cost (year 2030)				
	<i>Conv. Diesel Truck</i>	<i>H2 Fuel cell electric</i>	<i>Catenary electric</i>	<i>Dynamic inductive charge</i>
Infrastrucutre Cost				
Useful Life (years)	20	20	20	20
Diesel station capital cost (\$)	0	-----	-----	-----
Hydrogen station capital cost (\$)	-----	75,000,000		-----
Traction power supply system				
Traction power distribution system				
Catenary system (\$/route mile)	-----	-----	4,600,000	-----
Dynamic wireless charger (\$/route mile)	-----	-----	-----	6,400,000
Daily fuel/electricity demand (DGE)	308,642	236,628	164,795	189,998
Daily h2 demand (kg)		275,000		
Daily electricity demand (kWh)			6,377,551	7,352,941
Total Electric power demand (kW)			261,643	301,659
Substation power rating (kW)			20,931	24,133
Power supply cost (\$)			\$14,652,015	\$16,892,911
Catenary Power distribution cost(\$)			\$320,000,000	
Embedded WPT cost (\$)				
No. of Fuel Stations/Electrified road Zones	10	10	13	13
Daily Station Diesel Supply (gallon/station)	30,864			
Daily Station H2 Supply (kg/station)		27,500		
Electric Power Demand (kW/Zone)			20,931	24,133
Infrastructure Capital Cost (500 miles Double Lane)	\$0	\$750,000,000	\$1,150,000,000	\$1,600,000,000
Infrastructure O&M Expenses				
O&M costs (\$/dge)	0.02	0.27		
Annual O&M costs (\$/route mile)			\$46,000	\$64,000
Infrastructure Maintenance Cost (\$/year)	\$2,253,086	\$24,485,664	\$11,500,000	\$16,000,000
Infrastructure Costs per Mile				
Capital cost per mile	\$0.000	\$0.072	\$0.111	\$0.154
O&M cost per mile	\$0.004	\$0.040	\$0.022	\$0.031

7. Results

The final stage of the analysis is to pull together the full range of costs – vehicle capital costs, operating and fuel costs, along with the infrastructure capital costs and operating costs. This continues to be done on the basis of our sample 500 mile stretch of road, with 5,000 trucks per day traveling the stretch.

The relative vehicle, O&M, and energy costs are shown in Figure 21 on a per-mile basis, reflecting all the calculations in the preceding sections. The relative costs would vary with system size and the number of vehicles using the system, as well as with any of the other cost assumptions used in the analysis. In addition, the analysis is done not including any tax on vehicles or fuels, so should be considered a “resource cost” comparison. Taxes, such as CO₂ based taxes, could affect the relative attractiveness of the options.

In our base scenario, the average cost per mile of the catenary and inductive charge technologies is relatively close to those for conventional diesel trucks, with all between 70 and 100 cents per mile. Hydrogen fuel cells are somewhat more expensive, due mostly to the high cost of electrolysis (with overall about a \$0.06/kg cost of producing and delivering the fuel to vehicles, including energy and refueling station costs). The high energy infrastructure costs for catenary and dynamic charging systems are fully offset by lower energy costs from the use of electricity rather than hydrogen (reflecting the efficiency advantages of electricity). The relatively high vehicle capital cost (purchase price) of fuel cell trucks also contributes to their higher overall cost, but much less than the fuel cost.

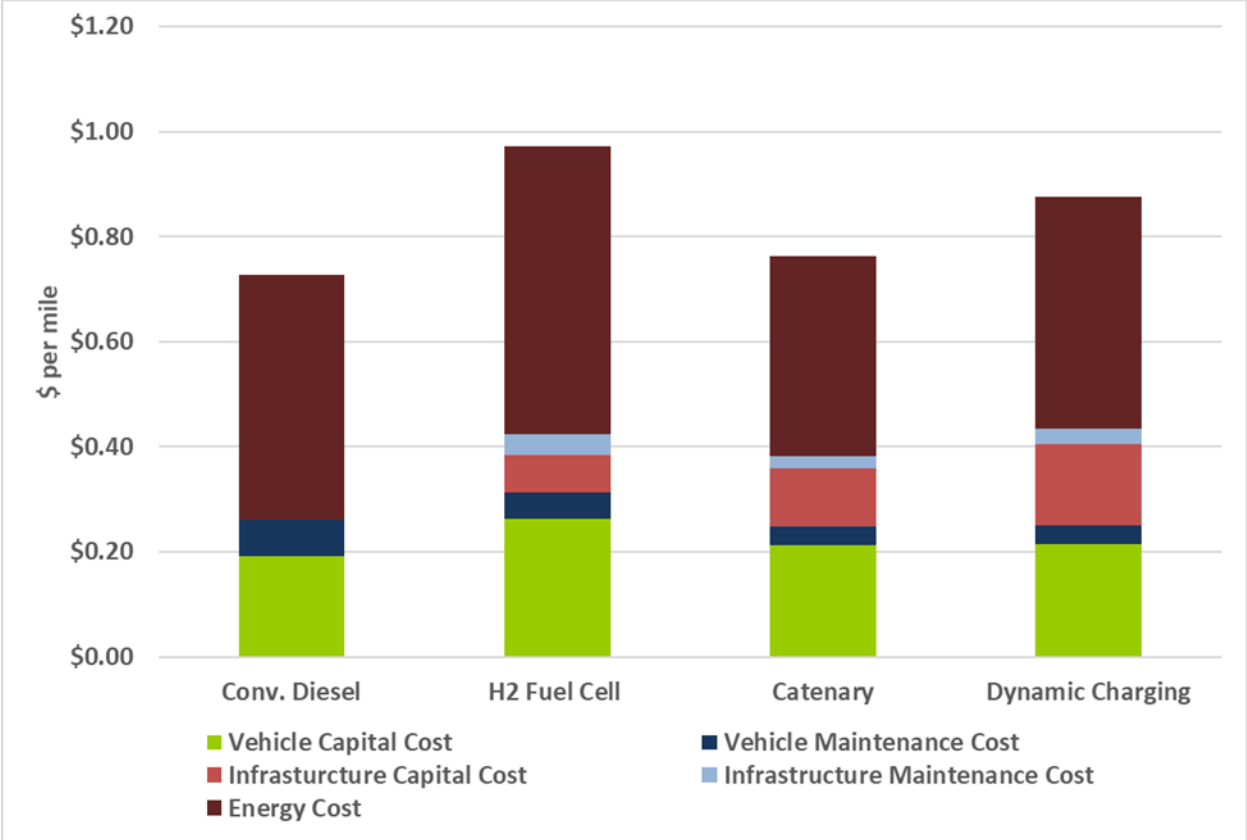

Figure 21. Relative cost per mile of different technologies in the base scenario

8. Sensitivity Analysis

One of the major uncertainties in the analysis is the cost and price of fuel, including diesel (indeed something that varies almost daily in the real world), hydrogen, which will depend on many factors, including the size and maturity of the system, and electricity, which is uncertain in the future due to introduction of new types of generation capacity and the possibility of inelastic demand. To examine how the uncertainty of these three fuel costs impacts the overall relative costs of the different technology options, a sensitivity analysis was conducted, as shown in Figure 22. All prices in the analysis have excluded taxes.

As shown, varying each of the fuel types up or down within a reasonable range creates the possibility that any of them could become quite competitive, or not. The base diesel fuel price of \$3.78/DGE in 2030 was varied based on U.S. Energy Information Administration (EIA) cases. Besides their base case, EIA has two scenarios of transportation diesel price in 2030 for the Pacific region in 2030: low oil price (\$2.36/DGE) and high oil price (\$6.09/DGE). Per mile costs of conventional diesel truck with the diesel fuel price assumptions of \$2.36/DGE, \$3.78/DGE, and \$6.09/DGE are shown in Figure 22.

Diesel price has a major influence on per mile cost of conventional diesel trucks. With the low price assumption, the cost of conventional diesel trucks is \$0.56/mi, the lowest among the four technologies. However, if \$6.09/DGE is assumed, the cost of conventional diesel trucks is \$1.01/mi, the highest among the four technologies (using base prices for H2 and electricity).

The base, dispensed hydrogen cost of \$6/kg in 2030 was also adjusted using a lower and higher assumption, \$4/kg and \$8/kg. The higher price (or even higher) may be more common before large scale mature hydrogen refueling infrastructures are in place. Clearly, hydrogen price has a considerable influence on per-mile cost of H2 fuel cell trucks. With the \$4/kg assumption, the cost of H2 fuel cell trucks is \$0.75/mi. However, if \$8/kg is assumed, the cost of H2 fuel cell trucks is \$1.19/mi, 59% higher.

Finally, we consider variants on the base price of electricity in 2030, which is taken as \$0.15/kWh. We examined a case where the price is \$0.10/kWh and one where it is \$0.20/kWh. Per mile costs of catenary truck and inductive charging truck with the electricity price assumptions of \$0.10/kWh, \$0.15/kWh, and \$0.20/kWh are shown in Figure 22.

Electricity price has a moderate influence on per-mile costs of catenary truck and inductive charging truck. From the lowest assumption, \$0.10/kWh, to the highest assumption, \$0.20/kWh, the per-mile costs of catenary truck and inductive charging truck increase 40.1% (from \$0.64/mi to \$0.89/mi) and 40.3% (from \$0.73/mi to \$1.02/mi), respectively.

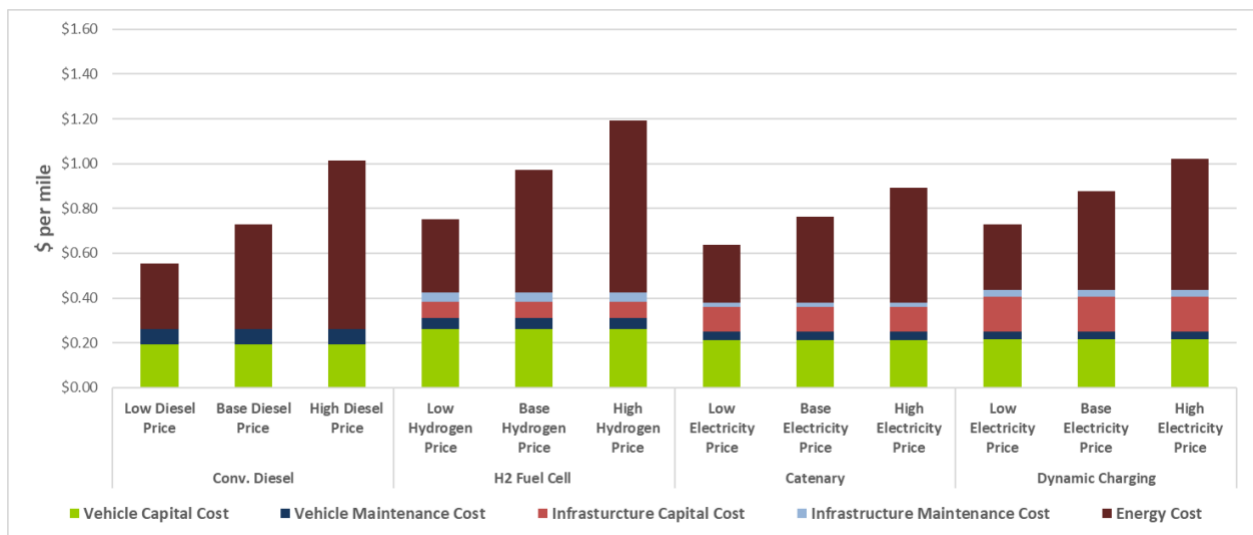

Figure 22. Sensitivity analysis of cost

Three diesel prices (low: \$2.356/DGE, medium: \$3.776/DGE, high \$6.086/DGE), three hydrogen prices (low: \$4/kg, medium: \$6/kg, high: \$8/kg) and three electricity prices (low: \$0.1/kWh, medium: \$0.15/kWh, high: \$0.2/kWh)

Another major uncertainty in the study is daily truck traffic. Depending on the location of highways, daily truck traffic can be as low as several hundreds and as high as almost ten

thousands. To see how this uncertainty affects the per-mile costs of each technology, a sensitivity analysis was performed for daily truck traffic (using base energy prices). The per-mile costs for each technology when daily truck traffic varies from 1 thousand to 10 thousand are shown in Figure 23.

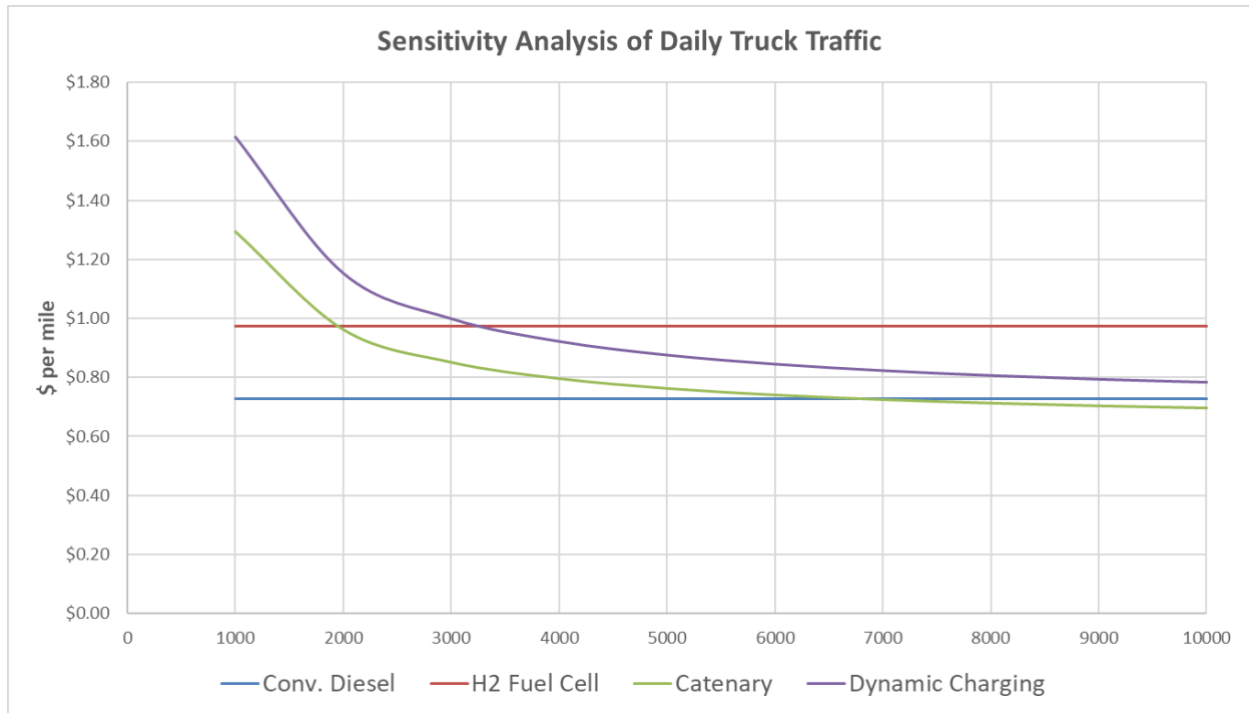

Figure 23. Sensitivity analysis of daily truck traffic. Daily truck traffic ranges from 1 thousand to 10 thousands

The per-mile costs for diesel and H2 fuel cell trucks are independent of daily truck traffic, since the hydrogen refueling station costs are fully scalable (each additional station can be added as needed). However, the per-mile costs for catenary and dynamic charging trucks start very high since the system must be built even for the first truck. These costs decrease with daily truck traffic: with high enough daily truck traffic, their costs per mile drop to around the same level as diesel trucks.

As another form of sensitivity analysis, we created “tornado” diagrams comparing two technologies at a time as shown in Figure 24. These figures show that varying each of a number of assumption be plus or minus 20% compared to the reference case value can have very different impacts on the relative cost of the two technologies.

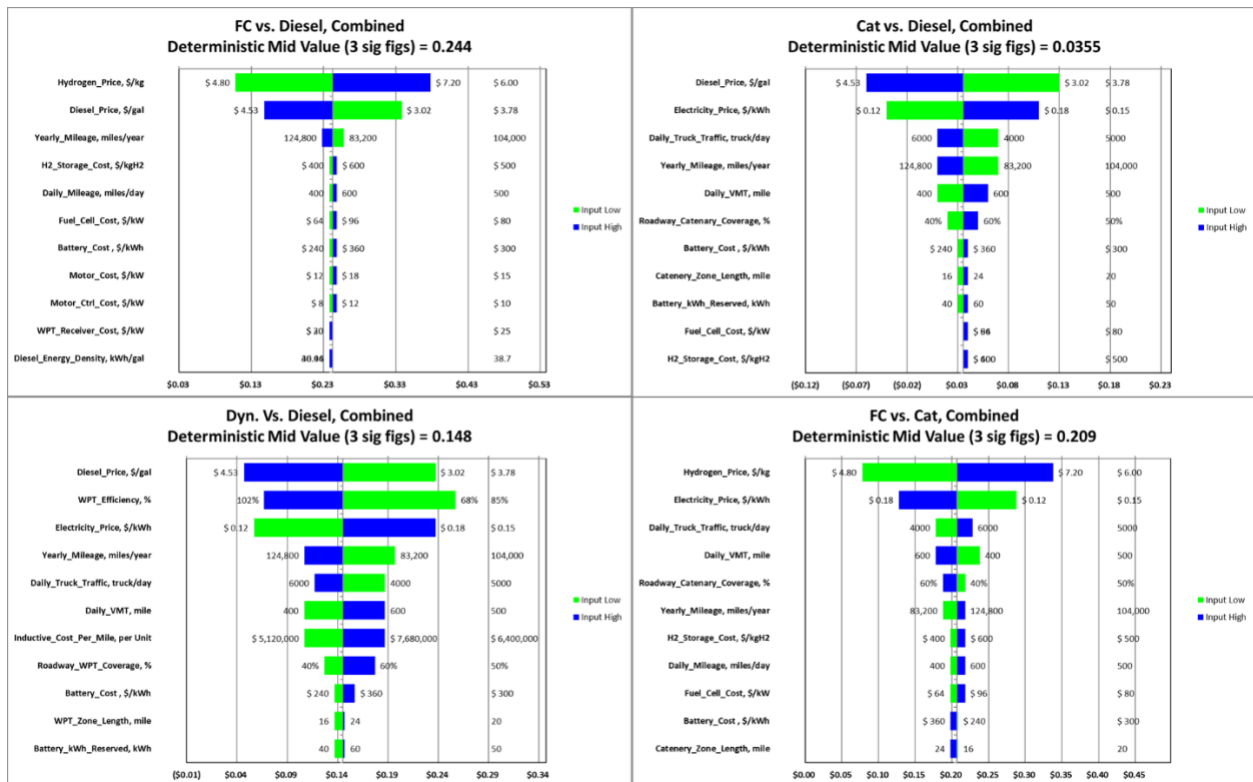

Figure 24. Changes in cost per mile as a function of changing input assumptions. Comparisons of H2 fuel cell vs diesel, catenary vs diesel, dynamic charging vs diesel, and H2 fuel cell vs catenary

It is clear that energy price have big impacts on the relative cost per mile as expected. Individual truck VMT is also an important factor as the more trucks travel the less infrastructure contributes to cost per mile. Daily truck traffic also has a considerable impact. More trucks operating on the stretch leads to higher total VMT and thus has a similar effect with individual truck VMT. Maybe quite surprisingly, vehicle cost variations do not have particularly big impacts, due to the large total VMT that vehicle cost is divided by to obtain cost per mile. These graphs suggest that the variations of one or more input factors could drastically change the relative cost per mile between two technologies.

9. Conclusions

Zero-emission long-haul trucking technologies are being developed that can play a critical role in achieving California’s climate change goals and virtually eliminating air pollution from freight vehicles. Hydrogen fuel cell, catenary electric and dynamic inductive charging technologies are being demonstrated in small scale projects worldwide. The zero-emission truck technologies were reviewed in detail in this study and vehicle and infrastructure costs for each of the technologies assessed. Vehicle configurations for long-haul applications with a daily mileage of 500 miles and annual mileage of 104,000 miles were analyzed to determine vehicle capital and O&M costs. A 500-mile section of major freight corridors with daily truck flow of 5,000 Class 8

trucks was analyzed to estimate the infrastructure and O&M costs. The cost inputs and results are relevant for 2030.

The following conclusions follow from the results given in the overall analysis and sensitivity analysis.

- There are significant technical and infrastructure challenges associated with all three technologies, though hydrogen fuel cell and catenary systems have been proven in a range of applications, well beyond the level of dynamic inductive charging systems. Whether fuel cells in a heavy duty, long haul application can achieve the needed durability is not a fully resolved question.
- The capital costs of the vehicles relative to diesel trucks, with 500 miles range, are lowest for catenary electric and dynamic inductive charged trucks and highest for fuel cell trucks, though the differences are not critical in the overall cost comparison.
- When operating on highways 50% electrified with 20-mile electrified zones. The costs of catenary and inductive charge trucks are no more than 20% more expensive than the conventional diesel fueled truck.
- The hydrogen fuel cell trucks have the highest fuel costs of the technologies studied, due mainly to the use of electrolytic hydrogen for a very low carbon scenario. This system is significantly less efficient than a catenary system or even than an inductive charging system, so significantly more electricity is needed to power the same number of trucks and distance.
- The fuel cost of the dynamic inductive charging truck is 15% higher in comparison to the catenary electric trucks. This relates mainly to the higher losses of wireless power transfer.

Building truck accessible hydrogen stations and highway electric charging infrastructure requires massive investments. At this time, it is difficult to fully assess the cost of fueling and charging infrastructure for the zero-emission long-haul trucking technologies. Better estimates of the cost of the infrastructure and how this scales will be possible after more and larger demonstrations of the technologies are completed.

Our preliminary calculations show that catenary infrastructure requires the lowest capital costs but it is only suitable for heavy-duty trucks and excludes passenger cars due to unrealistic long pantographs. The in-road dynamic inductive charging electrification cost is approximately 40% higher than the catenary system. In-road dynamic inductive charging infrastructure could theoretically be accessible to all vehicle types. Hydrogen infrastructure is even more flexible, allowing vehicles to travel in a full radius “off highway” around the stations, with much more range “autonomy” than the electric trucks considered in this analysis.

Chicken-or-egg issues are very important in determining the viability of these technologies. In the near- to mid-term, electrifying an entire state or regional highway system or deploying large hydrogen stations at many truck stops would require very large investments even though there

could initially be few zero-emission long-haul trucks in use. Low utilization would make it very difficult to justify the high investment costs.

In the longer-term, electrifying highways in the major freight corridors could become economically attractive if the costs of providing the needed infrastructure and, in the case of hydrogen, the cost of electrolysis, prove to be lower than currently estimated. The study indicates that hydrogen fuel cell vehicles could be the most attractive zero-emission technology for general long-haul freight, but the economics of that technology depends on lowering the cost of fuel cell systems, hydrogen storage onboard the vehicle, and especially achieving relatively low cost hydrogen for consumers (\$4/kg or lower), along with demonstrating the required durability of heavy-duty fuel cells. The economics of fuel cells and cost of the hydrogen fuel will be closely connected to the mass marketing of light-duty fuel cell vehicles.

Overall, the analysis here indicates that the various technology option all have the possibility to be cost-effective under certain conditions and assumptions. An important next step would be to expand the analysis to a full regional study to better estimate a full system set of costs, with data on how scale up may provide some non-linear cost reductions. Additional testing and demonstration projects with the individual technologies and systems, to improve the cost estimates, is also needed.

References

Akerman, P., Birkner, M., Lehmann, M., Demonstrating a System for Efficient and Sustainable Road Freight Based on Dynamic Power Supply, 6th European Transport Research Conference, Warsaw, Poland, 18-21, April 2016

American Trucking Associations, <http://www.trucking.org/>

APPM Management Consultants, The Inductive Charging Quick Scan - An exploratory study of inductive charging opportunities and potential in the Netherlands, 2014

Boer, E.D., Aarnink, S., Kleiner, F., Pagenkopf, J., Zero emissions trucks - An overview of state-of-the-art technologies and their potential, Delft Report. July 2013

Berger, R., Fuel Cell Electric Buses – Potential for Sustainable Public Transport in Europe. September 2015

Brecher, A. and Arthur, D., Review and Evaluation of Wireless Power Transfer (WPT) for Electric Transit Applications, FTA Report No. 0060. AUGUST 2014

Caltrans, 2015 Annual Average Daily Truck Traffic on the California State Highway System, 2015

CARB, Cost Model Discussion with ACT Cost Subgroup, August 23, 2016

CARB report, 2016 Annual Evaluation of Hydrogen Fuel Cell Electric Vehicle Deployment and Hydrogen Fuel Station Network Development. July 2016

CARB, Technology Assessment: Medium- and Heavy-Duty Fuel Cell Electric Vehicles, November 2015

Chen, F., Taylor, N., Kringos, N., Electrification of roads: Opportunities and challenges, Applied Energy 150, 109-119, 2015

Chopra, S. and Bauer, P., Driving Range Extension of EV With On-Road Contactless Power Transfer—A Case Study, IEEE Transactions on Industrial Electronics, 60(1), 329-338. January 2013

Deflorio, F.P., Castello, L., Pinna, I. et al. “Charge while driving” for electric vehicles: road traffic modeling and energy assessment. J. Mod. Power Syst. Clean Energy (2015) 3: 277. doi:10.1007/s40565-015-0109-z

Deflorio F., Guglielmi, P., Pinna, I., Castello, L., Marfull, S., Modeling and analysis of wireless “Charge While Driving” operations for fully electric vehicles, Transportation Research Procedia 5 (2015) 161 – 174

DOE Fuel Cell Technologies Office Multi-Year Research, Development, and Demonstration Plan, Section 3.3 Hydrogen Storage, 2015

DOE Hydrogen Storage Cost Analysis, DOE Hydrogen and Fuel Cells Program FY2016 Annual Progress Report. 2016

DOE Hydrogen and Fuel Cells Program Overview. FY 2016 Annual Progress Report, 2016

England Highways Agency, Preparing the strategic road network for electric vehicles, 2015

Eudy, L., Post, M., and Jeffers, M. Fuel Cell Buses in U.S. Transit Fleets: Current Status 2016. Technical Report: NREL/TP-5400-67097. November 2016

Fuller, J., Wireless charging in California: Range, recharge, and vehicle electrification, Transportation Research Part C 67 (2016) 343–356

Gladstein, Neandross & Associates, Zero-Emission Catenary Hybrid Truck Market Study, March 8, 2012

Highways England, Feasibility study: Powering electric vehicles on England’s major roads, 28/07/2015

Impullitti, J., Zero Emission Heavy-Duty Truck Technology: Fuel Cell & Wayside Power, September 1, 2016

Impullitti, J., SCAQMD Catenary Truck Project Presentation, CEC Merit Review, Fuels and Transportation Merit Review. Dec. 2, 2015

Isaac, R., Fulton, L., Propulsion Systems for 21st Century Rail, Transportation Research Procedia, 2017

Jang, Y.J., Jeong, S., and Lee, M.S., Initial Energy Logistics Cost Analysis for Stationary, Quasi-Dynamic, and Dynamic Wireless Charging Public Transportation Systems, Energies 2016, 9, 4823

Jeong, S., Jang, Y.J. and Kum, D., Economic Analysis of the Dynamic Charging Electric Vehicle, IEEE Transactions on Power Electronics, 20(11), 6368 - 6377, 2015

Lu, X., Wang, P., Niyato, D., Kim, D.L. and Han, Z., Wireless Charging Technologies: Fundamentals, Standards, and Network Applications, IEEE Communications Surveys & Tutorials, 18(2), 1413 - 1452, 2016

Lykogianni, G.M., Österlind, M., An Electrified Road Future - A feasibility study of Electric Road Systems (ERS) for the logistic sector in Sweden, 2014

Melaina, M. and Penev, M., Hydrogen Station Cost Estimates - Comparing Hydrogen Station Cost Calculator Results with other Recent Estimates, Technical Report: NREL/TP-5400-56412. September 2013

Miller, J.M., Jones, P.T., Li, J.M., and Onar, O.C., ORNL Experience and Challenges Facing Dynamic Wireless Power Charging of EV’s. IEEE circuits and systems magazine, 40-53, 21 May 2015

Miller, J.M., Onar, O.C., and Chinthavali, M., Primary-Side Power Flow Control of Wireless Power Transfer for Electric Vehicle Charging, IEEE Journal of Emerging and Selected Topics in Power Electronics, 3(1), 2015

Navidi, T., Analysis of Wireless and Catenary Power Transfer Systems for Electric Vehicle Range Extension on Rural Highways, May 2016

Nelson\Nygaard Consulting Associates Inc., Seattle Route 48 Electrification Study Business Case, August 2014

Ogden, Joan, 2018, Prospects for Hydrogen in the Future Energy System, ITS Research Report – UCD-ITS-RR-18-07

Qiu, C. Chau, K.T., Liu, C., Chan, C.C., Overview of wireless power transfer for electric vehicle charging, 2013 World Electric Vehicle Symposium and Exhibition (EVS27), 17-20 Nov. 2013

Ríos, M.A. and Ramos, G., Power System Modelling for Urban Massive Transportation Systems, DOI: 10.5772/35191, 2012

Scania, www.scania.com

Shekhar, A.; Prasanth, V.; Bauer, P.; Bolech, M. Economic Viability Study of an On-Road Wireless Charging System with a Generic Driving Range Estimation Method. Energies 2016, 9, 76.

Shin, J., Shin, S., Kim, Y., Ahn, S., Lee, S., Jung, G., Jeon, S.J. and Cho, D.H., Design and Implementation of Shaped Magnetic-Resonance-Based Wireless Power Transfer System for Roadway-Powered Moving Electric Vehicles, IEEE Transactions on Industrial Electronics, 61(3), March 2014

Song, K., Koh, K.E., Zhu, C., Jiang, J., Wang, C., and Huang, X. A Review of Dynamic Wireless Power Transfer for In-Motion Electric Vehicles, DOI: 10.5772/64331, 2016

Stetson, N.T. 2016 Annual Merit Review and Peer Evaluation Meeting, Hydrogen Storage Program Area, Plenary Presentation, June 6-10, 2016

Swedish Viktoria ICT, Slide-in Electric Road System – Inductive Project Report, Phase 1, 2014-05016

Systra COWI, Overhead Catenary Preliminary Description of the Overhead Catenary System for LRT. Technical Note, May 2014