

Lawrence Berkeley National Laboratory

LBL Publications

Title

Development and Verification of Control Sequences for Single- Zone Variable Air Volume System Based on ASHRAE Guideline 36

Permalink

<https://escholarship.org/uc/item/1466k89d>

Authors

Zhang, Kun
Blum, David H
Grahovac, Milica
et al.

Publication Date

2020-11-03

DOI

10.3384/ecp2016981

Peer reviewed

Development and Verification of Control Sequences for Single-Zone Variable Air Volume System Based on ASHRAE Guideline 36

Kun Zhang, David H. Blum, Milica Grahovac, Jianjun Hu, Jessica Granderson, Michael Wetter

Building Technology and Urban Systems Division
Lawrence Berkeley National Laboratory
Berkeley, CA, USA

{kunzhang, dhblum, mgrahovac, jianjunhu, jgranderson, mwetter}@lbl.gov

Abstract

This paper presents work on the development and verification of ASHRAE Guideline 36-2018 control sequences for single-zone variable air volume air-handling unit (AHU) systems. The Control Description Language, a subset of the Modelica Language, is used to implement those advanced control sequences. The sequences address control for components such as the economizer, supply air temperature setpoint reset, fan speed control, and zone heating/cooling states determination. Each component sequence is validated in open-loop tests and then used to compose a single comprehensive controller. This controller is also first validated in open loop and then tested in closed loop with an AHU system and building envelope model constructed using the Modelica Buildings library. The Guideline 36 controller is compared with a conventional control strategy applied to the same AHU and building model. Annual simulations show that the Guideline 36 control sequences yield 17.3 % of annual HVAC energy savings against the conventional control strategy in this case study.

Keywords: Control, VAV, ASHRAE Guideline 36, Buildings, HVAC

1 Introduction

The Heating, Ventilation and Air Conditioning (HVAC) control industry has not yet had a standard for expressing control sequences of HVAC systems (Pang et al, 2017). The controllers in the market can be generally divided into two types: configurable and programmable. The first type of controller is pre-programmed; it is therefore easy to install and commission. However, the embedded control logic is often overly simplistic, resulting in a compromise of thermal comfort and energy efficiency required by evolving energy standards and building codes. The second type is fully programmable (Hydeman, Taylor, & Eubanks, 2015). Yet, due to a lack of standard high-efficiency sequences, the implemented control scheme

of the HVAC system is often project-specific. Therefore, significant resources are required to engineer, specify, program and commission each project. It is also common that the implemented control sequences are sub-optimal and error-prone, which leads to varied building operational efficiency and performance (Hydeman et al, 2015).

The American Society of Heating, Refrigerating, and Air-Conditioning Engineers (ASHRAE) has initiated projects related to high-performance control sequences for HVAC systems through its Research Projects 1455 (Taylor Engineering, 2014) and 1711. A first version of ASHRAE Guideline 36-2018 (G36) (ASHRAE, 2018) was published upon completion of the Project 1455. The control sequences included in the G36 are based on the best-in-class industry practices. The guideline aims at reducing energy consumption and improving thermal comfort and indoor air quality of buildings. It also provides potential to reduce the time of the engineering, specification, programming and commissioning process (ASHRAE, 2018).

Implementing the advanced control scheme as described in the Guideline 36 does present its own challenges, due to the complexity of the sequences. The English language description can be ambiguous, and its interpretation to implement the sequences in a programming language is not straight-forward.

The G36 2018 version includes control sequences for the air distribution for single-zone and multi-zone variable air volume systems. The multi-zone system has been implemented in the Control Description Language (CDL) and reported in (Wetter et al, 2018). This paper focuses on the implementation of the G36 control sequences for Single Zone Variable Air Volume (SZVAV) systems using CDL (Wetter et al, 2018a). CDL is a subset of Modelica with its own set of data types and elementary blocks. It intends to allow for implementation of control sequences in computer code that can be used in real buildings, assessed through explicit simulation, and reused for verification tests during the commissioning process. CDL was developed

under the OpenBuildingControl (OBC) project (Wetter et al, 2018b). Both CDL and the implemented sequences for OBC are incorporated in the master branch of the Modelica Buildings library version 7.0.0 (Wetter et al, 2014). Another closely-related project called “Spawn of EnergyPlus” (Wetter et al, 2015) aims at enhancing the EnergyPlus simulation engine (EnergyPlus Development Team, 2019) by integrating the Modelica Buildings library so it can simulate these sequences using EnergyPlus envelope models and Modelica HVAC and control models.

Related work has indicated the potential of control strategies of HVAC systems to impact their energy consumption. For example, Pang et al. (2017) found that energy consumption can vary up to 66% from various control strategies for multi-zone VAV systems, while Fernandez et al. (2017) found that this variation could be up to 60% for various HVAC control and commissioning cases. For the multi-zone G36 sequence, Wetter et al. (2018a) found potential energy savings of up to 30%.

As of writing this paper, the authors are unaware of publications related to implementing the G36 SZVAV control sequences in a programming language and evaluating the performance of those advanced sequences in a simulation environment. Therefore, the objective of this paper is to describe the process of implementing and verifying the control sequences using CDL, as well as the performance evaluation of the sequences compared with a conventional controller. Then, the sequences will be available for further performance evaluation and eventual real building implementation through the process developed in the OBC project.

Section 2 gives an overview of the control sequences and their implementation with the main components of the sequences described in the subsections separately. Section 3 presents the case study, where a baseline controller is also developed to help evaluate the performance of the G36 control sequences and emphasize key advantages over those found in practice. Section 4 presents the comparison results with analysis. The paper closes with discussion and conclusion.

2 Guideline 36 control sequences of single-zone VAV system

A SZVAV air handling unit (AHU) system is often applied to medium to large single-floor spaces such as small retail stores, classrooms, and auditoriums. It is usually composed of a variable-speed supply fan (additionally with or without an exhaust fan), a cooling coil, a heating coil and a mixing box for controlling the ratio of recirculated zone return air and outside air (see Figure 1). The delivery of additional outside air when conditions are appropriate is called economizer operation. Control sequences of the SZVAV system in the G36 specification include supply fan speed control,

supply air temperature control, minimum outdoor air control, economizer control, zone state, freeze protection and alarms.

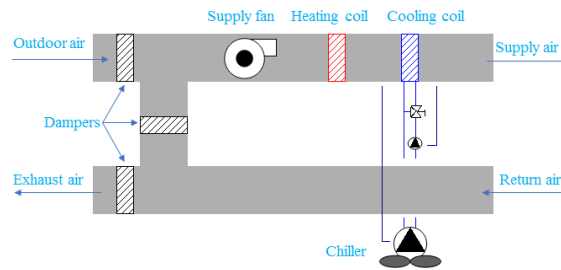

Figure 1. Single-zone VAV air handling unit system.

The goal of the G36 control strategy is to maximize free cooling and to avoid excess energy consumption to run fans and provide mechanical heating and cooling. The essential ideas of the strategy are to vary the fan speed, reset the supply air temperature setpoints (both heating and cooling) in different conditions, and adjust the outdoor air damper position according to the supply fan speed.

Elementary CDL blocks were used to implement composite blocks representing subsets of the control sequences. These composite blocks were then integrated into a single controller block. Figure 2 shows the tree view of the single-zone VAV control sequences package in the Modelica Buildings library version 7.0.0.

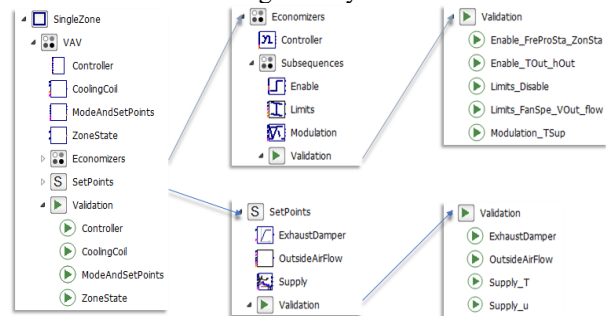

Figure 2. Structure of the single zone VAV package in the Modelica Buildings library 7.0.0.

The implementation of the sequences is modular. It allows users to customize the sequences for their needs primarily by simple parameter selection, such as whether there exists an enthalpy sensor to direct economizer operation, but also through easy access to certain parts of the control sequences. The CDL implementation also provides information on the control objective and functionality of each control block in the form of html info sections.

The implementation also considered numerical integration error and/or sensor noise which may cause chattering of the control, though this is beyond the scope of the G36 itself. CDL blocks for hysteresis or timers were therefore added for the part of the control sequences that use continuous-time semantics.

Each composite block in the package is validated in open-loop simulations. As can be seen from Figure 2, each sub-package includes a Validation package. The validation models are not only to verify whether the control sequences satisfy the control intent under a wide range of preset input conditions, but also intended to provide utilization examples for the library users.

The following sections explain the key components of the control sequences and how they were implemented and validated in the Buildings library.

2.1 Setpoints for supply air temperatures and fan speed

There are two separate supply air temperature (SAT) setpoints in the G36 sequences: 1) SAT for heating, which is used to control the heating coil and economizer dampers, and 2) SAT for cooling, which is used to control the cooling coil. The two temperature setpoints are reset at different rates but controlled using the same temperature sensor. The supply fan speed is also reset using the same control loops as the SAT for heating and cooling. These two control loops correct for the error between measured zone air temperature and the heating and cooling temperature setpoints respectively.

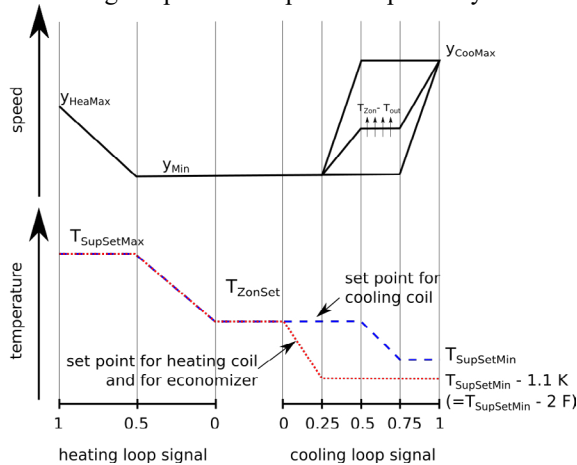

Figure 3. Control diagram for single zone VAV control logic: fan speed and supply air temperature setpoints as a function of control loop signals.

Figure 3 shows the G36 control diagram of the heating and cooling SAT setpoints and fan speed trajectories under heating and cooling control loop signals. The control logic requires that the heating SAT setpoint T_{SupSet} increases linearly when the heating coil valve control signal, i.e. the heating loop signal, increases from 0 to 0.5; and stays at the maximum heating SAT $T_{SupSetMax}$ when the heating signal is within 0.5 and 1 (see the red dotted curve). When the system is in the deadband (neither heating nor cooling state), the heating SAT is the same as the zone temperature setpoint T_{ZonSet} and the fan speed remains at the minimum y_{min} . The fan speed stays at y_{min} when the heating loop signal is within 0 and 0.5; and it

increases linearly to the maximum fan speed y_{HeaMax} when the heating loop signal is within 0.5 and 1 (see the solid black curve in the left part of the upper plot).

In cooling mode, the SAT setpoint (see the blue dotted curve) is reset in a similar linear modulation logic as the heating SAT setpoint. The fan speed is varied continuously based on the difference between inside and outside air temperatures and cooling loop signal, as shown in the upper right portion of Figure 3.

2.1.1 Implementation in CDL

The block Buildings.Controls.OBC.ASHRAE.G36_PR1.AHUs.SingleZone.VAV.SetPoints.Supply implements the functionalities of the SAT reset and supply fan speed control as indicated in the G36. The block allows users to set the maximum SAT setpoint for heating and the minimum SAT setpoint for cooling. For the fan speed control, the parameters that can be changed are the maximum fan speed for heating, and the minimum and maximum fan speeds for cooling.

2.1.2 Open-loop verification

Figure 4 presents the fan speed control validation results as a function of the cooling control loop signal from the validation simulation of the VAV controller. In the validation model, instances of the controller are configured identically, but the input signal for zone temperature differs in order to validate that the fan speed is increased correctly. It can be seen that Figure 4 is a representation of the upper right part of Figure 3 as required in the G36.

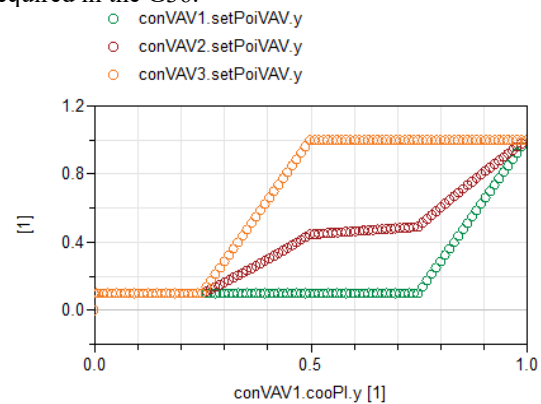

Figure 4. Fan speed control as a function of the cooling control loop signal.

Similarly, Figure 5 presents the lower right part of Figure 3. It shows how the SAT setpoint for heating and economizer, and the SAT setpoint for cooling are modulated in different cooling control signals. Validation models such as these confirm that our controller implementation behaves according to the prescribed control sequences of the G36.

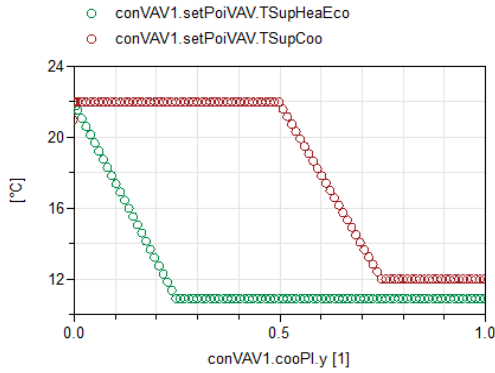

Figure 5. Heating and cooling supply air temperature as a function of the cooling control loop signal.

2.2 Economizer

The single-zone AHU economizer control according to the G36 comprises the SAT, outdoor air (OA) damper and economizer lockout control.

The economizer SAT control loop has an intent to maintain the SAT at its heating setpoint by modulating the heating coil and both OA and return air (RA) damper positions. The dampers are complementary, meaning that a single actuator controls both dampers.

The logic assumes a single OA damper for both the economizer and the minimum OA functionality. The minimum OA damper position, which aims at satisfying the outdoor airflow requirement, is reset based on both current outdoor airflow requirement and fan speed.

The economizer is locked out (CDL implementation uses the term disabled) as the outdoor air condition, i.e., dry bulb temperature and/or enthalpy depending on the sensors installed, exceeds the climate and energy code specific setpoints.

2.2.1 Implementation in CDL

The package Buildings.Controls.OBC.ASHRAE.G36_PRI.AHUs.SingleZone.VAV.Economizers, as illustrated in the upper middle part of Figure 2, provides a CDL implementation of the SZ G36 economizer. It comprises a main economizer Controller block, a package with three subsequences: Limits, Enable and Modulation, and the corresponding validation models for both the Controller block and the subsequences. The Limits sequence implements the minimum OA damper position reset. The Enable sequence resets the OA and RA damper position limits based on the economizer lockout conditions, for example outdoor air temperature, and equipment and building status, such as fan enable status and whether the zone requires any heating or cooling. The Modulation sequence implements the SAT control. When the economizer is disabled, the modulation sequence keeps evaluating the SAT control loop, but the RA damper position is fixed to a fully open position and the OA damper is fixed to

the minimum open position to meet outdoor airflow, as specified by the outputs of the Enable sequence.

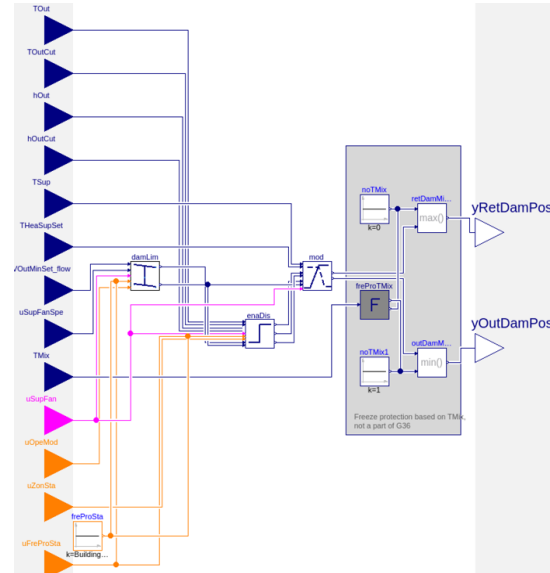

Figure 6. Block diagram of the CDL implementation of the Economizer controller in the Buildings library. It comprises four subsequences: Enable, Limits, Modulation and Freeze Protection.

The economizer Controller block is illustrated in Figure 6. The block takes as inputs the setpoints, such as the SAT and its heating setpoint, minimum outdoor airflow setpoint, measured quantities such as outdoor air temperature and/or enthalpy, supply air fan speed, mixed air temperature, status variables such as the supply fan on/off status, operating mode, zone state and freeze protection status. The block outputs the OA and RA damper positions to be sent to actuators. In addition to the G36 definition the controller implements a custom freeze protection block based on the mixed air temperature tracking for reasons elaborated in (Wetter et al, 2018).

2.2.2 Open-loop verification

All control blocks contained in the Economizer package, including the top-level Controller block and the subsequences, have at least one corresponding validation model. Here we present a validation model of the Modulation block.

Figure 7 shows the validation results of the Modulation block performance. The plot (b) shows the PI controller output signal over time when the SAT rises from below to above its setpoint, as shown in plot (a). With these inputs the control signal drops monotonically from 1 to 0. Plot (c) illustrates how the OA and RA damper and cooling valve positions behave as a function of the SAT control loop signal. The heating coil signal, which rises from 0 to 1 at the far-right side of plot (c), is mapped to the SAT control signal such that only the upper portion of the signal, starting at a value at which

the OA damper is fully closed and the RA damper is fully open, is used for the heating valve control.

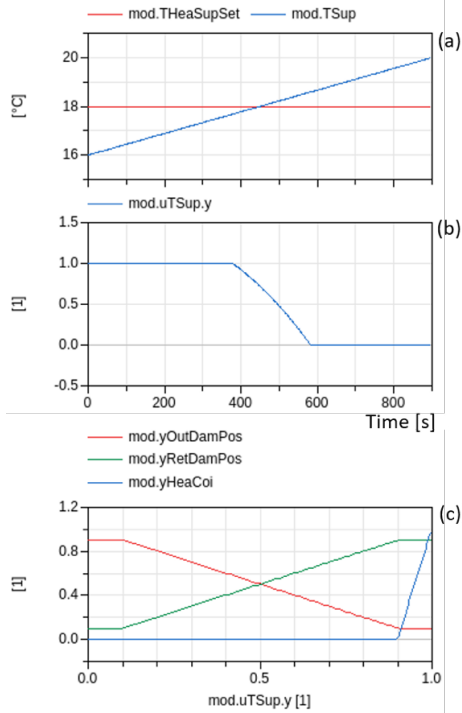

Figure 7. Modulation block validation results for a simulation duration of 15 minutes show the time series of (a) test values of SAT (in blue) and SAT setpoint (in red) that yield the (b) PI controller signal as a response. (c) Control diagram with OA (in red), RA damper (in green) and cooling coil valve (in blue) positions as a function of the SAT control signal.

2.3 Outdoor air flow control

The control of minimum outdoor airflow rate setpoint complies with the ventilation rate procedure of ASHRAE 62.1 (ASHRAE, 2016). It adjusts the setpoint according to the zone operation mode, zone status (heating, cooling or standby), and window status if it has any operable window.

2.3.1 Implementation in CDL

The block Buildings.Controls.OBC.ASHRAE.G36_PR1.AHUs.SingleZone.VAV.SetPoints.OutsideAirFlow outputs the minimum outdoor airflow rate setpoint as specified in the G36. Figure 8 shows the implementation of the block in the Buildings library.

There are three steps to specify the setpoint. First, it finds the minimum breathing zone outdoor airflow rate, which is the sum of the rate specified according to area and the rate specified according to occupant population. The number of occupants could be retrieved directly from an occupancy sensor, if present. Otherwise, the default occupant density is used to calculate the outdoor air requirement according to (ASHRAE, 2016). Second, the sequence selects warm-air or cool-air distribution effectiveness depending on the zone heating or cooling

status, as specified in ASHRAE 62.1. Finally, it sets the minimum outdoor airflow setpoint for the zone when it is in occupied mode with the window (if there is one) being closed. When the zone is not in occupied modes or the window is open, the setpoint becomes zero.

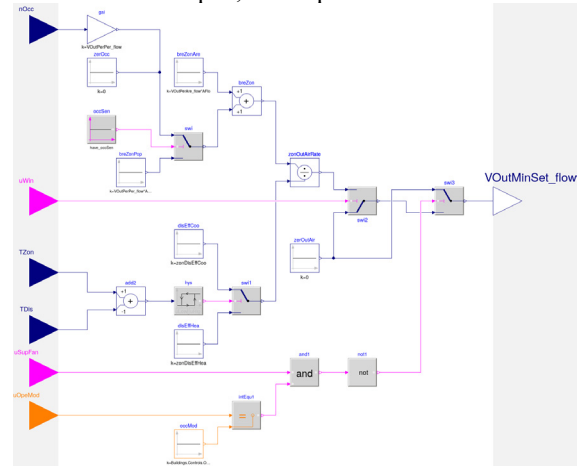

Figure 8. Block diagram of the CDL implementation of specifying minimum outdoor airflow setpoint.

2.3.2 Open-loop verification

Figure 9 shows the results of validating the sequence by giving the inputs of increasing occupancy and the change of zone state from heating to cooling. It illustrates that the minimum output airflow setpoint increases when there are more occupants in the zone. Also, the sequence can choose different air distribution effectiveness depending on the zone state. The zone state is decided based on the temperature difference between the zone and the supply air, with a hysteresis being applied to avoid chattering.

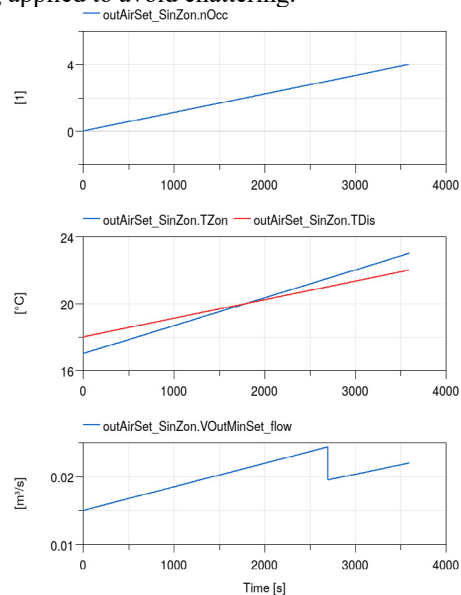

Figure 9. Validation results for block of specifying the minimum outdoor airflow rate setpoint show that the setpoint changes along with the changes of occupancy and

zone state (at the time 2700s the zone state is changed from heating to cooling).

3 Case study

To test the controller in a closed-loop scenario, a model is created to integrate the controller with a SZVAV AHU system and a single-zone building envelope model. Measurements of the building air temperature, supply air temperature, return air temperature, and mixed air temperature are fed back to the controller to close the control loop (see Figure 10). Other important parts of the model include the weather data and occupancy schedules.

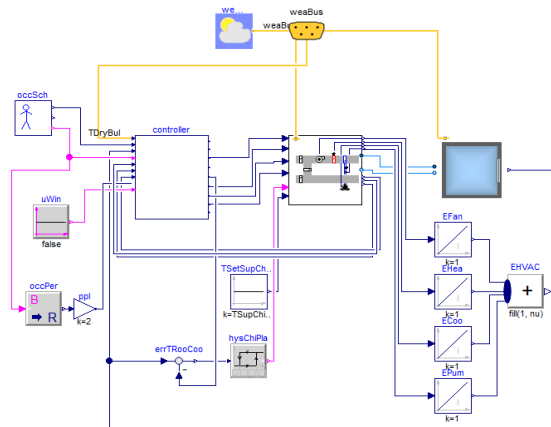

Figure 10. Closed-loop control model with the building, AHU and G36 controller.

The details of the building and AHU model are illustrated in the subsections below, and the performance of the G36 controller is compared with a conventional Baseline controller in Section 4.

3.1 Building envelope model

The building envelope model used for this case study is from the model `Buildings.Air.Systems.SingleZone.VAV.Example.BaseClasses.Room`. It uses an instance of `Buildings.ThermalZones.Detailed.MixedAir` to model the transient heat conduction within the building constructions and longwave radiation heat exchange between the surfaces (walls, roof and windows etc.). The heat convection and radiation between the ambient (indoor and outdoor air) and the envelope is also modeled at each time step.

The information of the envelope such as geometry and materials are from the BESTEST case 600, and derived from the EnergyPlus validation project (Henninger & Witte, 2004).

The weather data used in the case study is the DRYCOLD weather data included in the Buildings library, which is the weather used for the BESTEST case studies. It is from the weather station of Denver-Stapleton in Colorado, USA. The occupancy schedule for the building is assumed to be from 8am to 6pm daily, which means that the system is operated based on this

schedule. The internal heat gains are modelled as constant gains when the zone is occupied.

3.2 Air handling unit system model

The air handling unit system model from the class `Buildings.Air.Systems.SingleZone.VAV.ChillerDXHeatingEconomizer` contains a variable-speed supply fan, a heating coil, a water-based cooling coil, and an economizer. The cooling coil is assumed to be served by an air-cooled chiller. The model assumes that pressure drops through the system are lumped into a single component and the cooling coil is a dry coil. The mass flow of chilled water through the cooling coil is controlled by a three-way valve to maintain the cooling supply air temperature setpoint. The cooling coil mixing valve and the economizer dampers are modeled as ideal, i.e., they exactly control a specified ratio of fluid flow through contributing branches.

The fan and pump models are idealized to exactly track the set point for the mass flow rate, and they are from the model `Buildings.Fluid.Movers.FlowControlled_m_flow`. The details about the fan/pump model are described in (Wetter, 2013).

The design airflow rate for the AHU system is $0.625 \text{ m}^3/\text{s}$. The minimum outdoor airflow rate is $0.0144 \text{ m}^3/\text{s}$ and the design outdoor airflow rate is $0.025 \text{ m}^3/\text{s}$. The calculation of the ventilation requirement for the building model is based on ASHRAE Standard 62.1 (ASHRAE, 2016) for an office with reference occupancy density. Note that the G36 controller is capable to adjust the outdoor airflow rate between the minimum and design outdoor airflow based on whether there are occupants in the zone; while the Baseline controller is configured to provide the design outdoor airflow.

The chiller model is `Buildings.Fluid.Chillers.ElectricEIR`. It is a model of an electric chiller, based on the DOE-2.1 chiller model and the EnergyPlus chiller model `Chiller:Electric:EIR` (Hydeman et al, 2002). Its nominal Coefficient of Performance (COP) is 5.5. The heating plant is not modelled and we assume it is a geothermal heat pump with a constant COP of 4.0.

3.3 Baseline controller model

The Baseline controller is based on the commonly used single-maximum VAV control with dry-bulb economizer control. During cooling, the fan speed is controlled to maintain the room temperature at the cooling setpoint temperature using a P controller, between a minimum and maximum fan speed. Flow through the cooling coil is controlled to maintain a constant supply air temperature setpoint. During heating, the fan speed is constant at the minimum speed while the heating coil is controlled to maintain the room temperature at the heating setpoint using a P controller. The minimum position of the outdoor air damper ensures enough ventilation flow to meet ASHRAE 62.1

at minimum fan speed. If the outside air dry-bulb temperature is lower than the return air dry-bulb temperature, the economizer opens the damper further to provide cooling of the mixed air to the supply air temperature setpoint as much as possible. During unoccupied times, the zone heating and cooling setpoints are set back and the minimum outdoor air damper position is set to zero.

4 Results comparison

The performance of these G36 and base controllers was compared using identical models for the building envelope, AHU system and weather. Overall, the G36 controller saves 17.3 % HVAC electric energy compared with the Baseline case. The heating energy use for both controllers is nearly equal, with most of the energy savings of the G36 controller associated with the cooling energy. The pump electricity use is minimal for both cases and the G36 controller uses slightly more electricity for the supply fan. Figure 11 shows the breakdown of the monthly energy use for the two controllers with left bars indicating the Baseline controller and right bars indicating the G36 controller. It can be clearly seen that G36 requires less energy use for cooling throughout all the months. In the winter months (December, January and February) G36 consumes 2.6% more heating energy than the Baseline. This small increase could be due to two factors. The first is when near the end of an occupancy period the internal loads are decreasing and the zone switches from cooling mode to deadband. This mode switch increases the SAT setpoint according to Figure 3. For the remaining time the fan is supplying outside air, and the temperature is low outside, heating is briefly used to heat the supply air to the setpoint. This is shown in Figure 14. The second factor is the small amount of increased outside air the G36 control sequence provides during morning heat up, as shown in the upper plot of Figure 13, which adds a small amount of heating load to the coil.

Figure 12 shows the zone temperature profiles during a winter and a summer week along with the zone heating and cooling setpoint. We can see that the zone temperatures are maintained within the heating and cooling setpoint bands by both controllers during these two extreme weeks. In addition, we can see that the zone

temperatures are very close to each other in both cases. We actually find that both controllers deliver very similar zone temperatures all year around, with temperature difference within 0.5 K, the same magnitude as the temperature hysteresis settings in the controllers. Using the zone temperature as the thermal comfort indicator, we can conclude that both controllers maintain the thermal comfort in the zone equally close. This means that the G36 controller does not compromise thermal comfort while yielding energy savings.

Figure 13 shows the outdoor airflow during the same two weeks. We can see that the outdoor airflow profiles of the two cases are very similar to each other in winter. During this winter week, the outdoor air temperature is very low as shown by the lime curve in Figure 12, so the controllers restrict the outdoor air fraction to the minimum required for ventilation during heating, as seen in the mornings of each day and use the economizer if any cooling is needed, as seen during the other afternoons in the week. In the summer week, the G36 is capable of lowering the outdoor airflow rate by adjusting the minimum outdoor air damper position based on the fan speed. This reduces excess load on the cooling coil when the outdoor air temperature is higher than the zone temperature. As the Baseline controller assumes no active reset on the minimum outdoor air damper position, excess outdoor air is brought in when the fan speed increases for space cooling.

In Figure 13 we also find that there are sudden jumps in the outdoor airflow profiles, for example, on the afternoon of August 1st (more significant airflow increases for the G36 controller). During that period, the outdoor air temperature becomes lower than the zone temperature setpoint (see the lower plot of Figure 12); both controllers therefore increase the OA damper opening to use more outdoor air to cool down the building. However, the G36 controller simultaneously resets the cooling SAT setpoint up (see the green curve in Figure 15). This results in an increase of the supply airflow rate in order to meet the zone cooling load; however, the G36 controller does so by use of more outside air and without use of any mechanical cooling. On the other hand, the Baseline controller maintains a constant SAT for cooling (see the blue curve in Figure 15), so mechanical cooling is still required to reach the

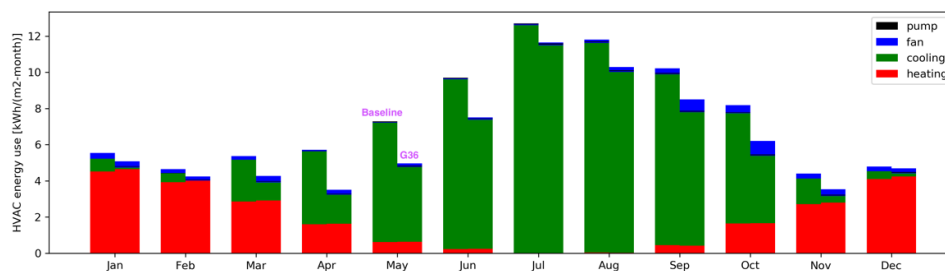

Figure 11. Site HVAC electricity use for each month (Left bars: Baseline; Right bars: G36).

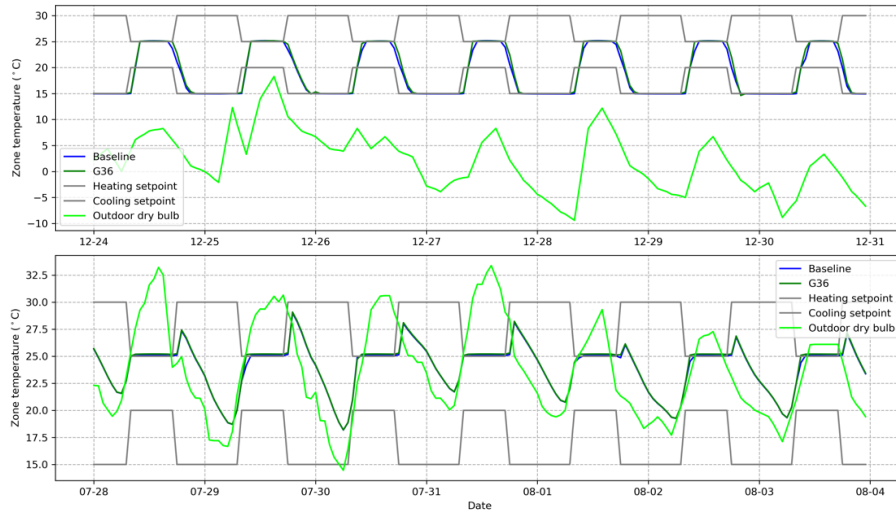

Figure 12. Zone temperature profiles during a winter (top) and a summer (bottom) week

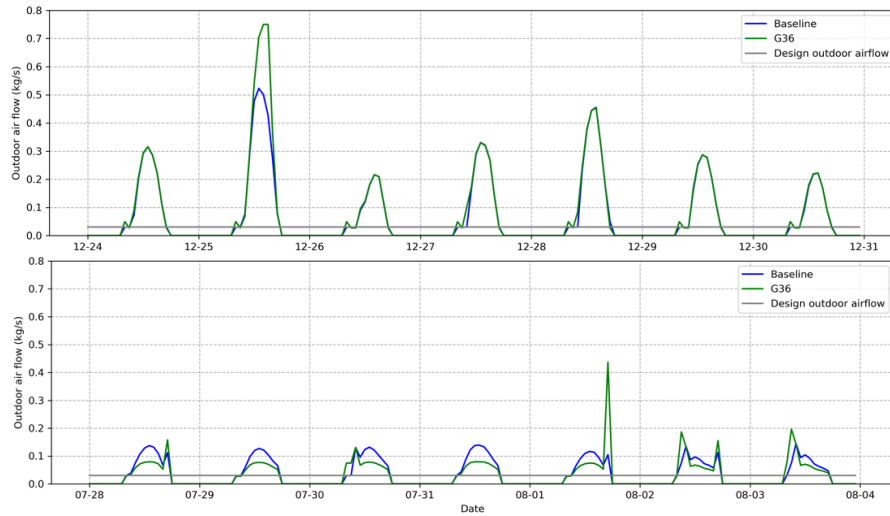

Figure 13. Outdoor airflow rate during a winter (top) and a summer (bottom) week.

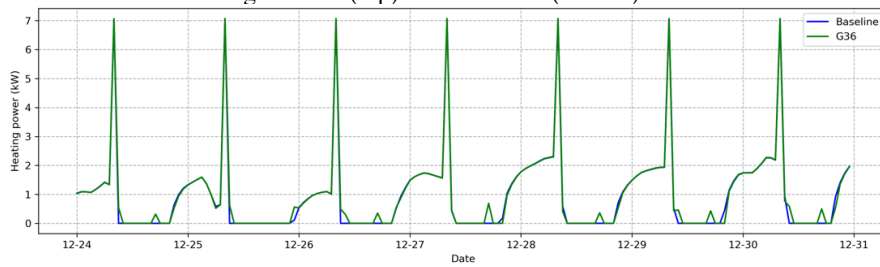

Figure 14. Heating power demand during a winter week.

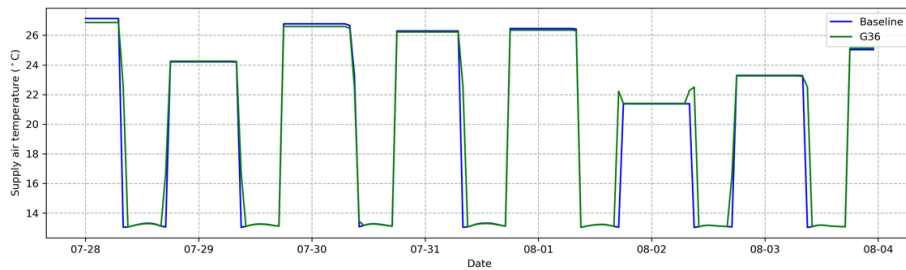

Figure 15. Supply air temperature for cooling in a summer week.

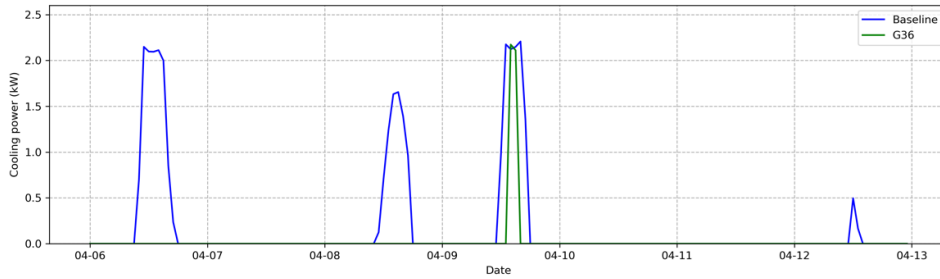

Figure 16. Cooling power demand in a week of shoulder season.

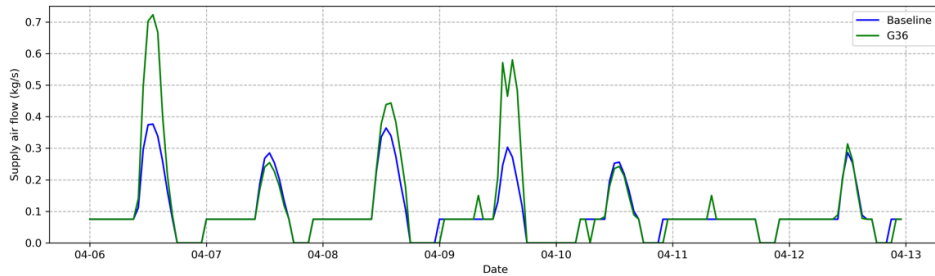

Figure 17. Supply airflow rate in a week of shoulder season.

lower cooling SAT setpoint, even though the economizer is enabled. This shows how the advanced control sequences of the G36 take even more advantage of available free cooling by coordinating the SAT setpoints reset and the economizer operation. This strategy of coordinating the SAT setpoint reset and the economizer operation is the main reason why the G36 controller consumes less cooling energy than the Baseline. The strategy is particularly useful during shoulder seasons. Figure 16 shows the cooling power demand in a week of the shoulder season. We can see that the G36 uses much less cooling energy than the Baseline for this week. Figure 17 shows the supply airflow rate in the same week of the shoulder season as in Figure 16. We can see that the G36 controller has higher supply airflow than the Baseline for the whole week. This is because the G36 controller engages the economizer more often to increase the outdoor airflow to utilize free cooling than the Baseline. This explains why the G36 does not save fan energy as shown in Figure 11.

Finally, it should be noted that the simulation time for each controller was similar, with the Baseline controller at 507 seconds and the G36 at 526 seconds. The simulations were run on a Linux operating system with a 16-core processor (Intel Xeon® CPU X5650 @2.67GHz) and a 32GB memory. In general, the simulation time with different control strategies can be largely dependent on the number of events generated through mode or on/off switching.

5 Discussions and conclusions

This paper presented the work on implementation, validation and application of ASHRAE Guideline 36-2018 control sequences for single-zone variable air

volume air-handling unit systems. Those advanced control sequences address control for AHU system components such as the economizer, supply air temperature setpoints reset, fan speed control, and zone heating and cooling states.

The control sequences were implemented using the Control Description Language in a modularized approach, which therefore allows the users to customize the sequences for their needs. Each component sequence was validated in open-loop tests and then used to compose a single comprehensive controller. This controller was firstly validated in open loop and then tested in closed loop with an AHU system and building envelope model constructed using the Modelica Buildings library.

The Guideline 36 control sequences were compared with the conventional control strategy based on single-maximum VAV control. Both controllers were applied to the same AHU and building system in a case study.

Annual simulations show that the Guideline 36 control sequences yield 17.3 % of annual HVAC energy savings against the conventional control strategy. The G36 control scheme can take advantage of free cooling by adjusting the economizer dampers and resetting supply air temperature setpoints; the G36 controller therefore has reduced energy consumption due to cooling. Verification of annual zone temperatures show that both controllers maintain the zone temperature very closely to each other within thermal comfort bands. This shows that the energy savings of the G36 control sequences do not compromise thermal comfort while delivering the energy savings.

It should be noted that the percentage of energy savings shown by the G36 controller in this paper is specific to the selected case study. The energy savings potential is subject to variables such as climate zones,

internal heat gains assumption and the baseline control sequences. Future work of this study includes investigating the impact of those variables on the G36 control sequences performance. Validation of the control sequences with measurement data is also important to further verify the implementation of the sequences.

Data availability

All the models and components used in this paper are open-source and can be downloaded from the Github repository <https://github.com/lbl-srg/modelica-buildings>. The Modelica Buildings branch for the models used in this study is issue1608_compareSZVAV

(commit 7c939c0). Table 1 lists the Modelica path of the two closed-loop system models in the case study and the SZVAV package in the Buildings library.

Acknowledgements

This research was supported by the Assistant Secretary for Energy Efficiency and Renewable Energy, Building Technologies Office, of the U.S. Department of Energy, under Contract No. DE-AC02-05CH11231, and the California Energy Commission's Electric Program Investment Charge (EPIC) Program. We thank Taylor Engineering for their funding of this work through the California Energy Commission's (CEC) Electric Program Investment Charge (EPIC) Program.

Table 1. Models and package used in the paper from the open-source Modelica Buildings library

Name	Modelica Path
Baseline system model	Buildings.Air.Systems.SingleZone.VAV.Examples.ChillerDXHeatingEconomizer.mo
G36 system model	Buildings.Air.Systems.SingleZone.VAV.Examples.Guideline36.mo
SZVAV package	Buildings.Controls.OBC.ASHRAE.G36_PR1.AHUs.SingleZone.VAV

References

ASHRAE. (2016). *Ventilation for acceptable indoor air quality. ASHRAE Standard*. Atlanta, GA: American Society of Heating Refrigeration and Air-Conditioning Engineers, Inc.

ASHRAE. (2018). *ASHRAE Guideline 36-2018 High-Performance Sequences of Operation for HVAC Systems* (Vol. 8400). Atlanta, GA: American Society of Heating Refrigeration and Air-Conditioning Engineers, Inc.

EnergyPlus Development Team. (2019). *EnergyPlus engineering reference: The reference to EnergyPlus calculations*. EnergyPlus Version 9.2. US Department of Energy.

Fernandez, N., Xie, Y., Katipamula, S., Zhao, M., Wang, W., & Corbin, C. (2017). *Impacts of Commercial Building Controls on Energy Savings and Peak Load Reduction*. Richland, WA: Pacific Northwest National Laboratory Technical Report 25985.

Henninger, R. H., & Witte, M. J. (2004). *EnergyPlus testing with ANSI/ASHRAE standard 140-2001 (BESTEST)*. Washington, D.C.: U.S. Department of Energy.

Hydeman, M., Gillespie, K. L., & Dexter, A. L. (2002). Tools and techniques to calibrate electric chiller component models. *ASHRAE Transactions*, 108 PART 1, 733–741.

Hydeman, M., Taylor, S. T., & Eubanks, B. (2015). Control sequences & controller programming. *ASHRAE Journal*, 57(3), 58–62.

Pang, X., Piette, M. A., & Zhou, N. (2017). Characterizing variations in variable air volume system controls. *Energy and Buildings*, 135, 166–175.

<https://doi.org/10.1016/j.enbuild.2016.11.031>

Taylor Engineering. (2014). *ASHRAE RP-1455: Advanced Control Sequences for HVAC Systems Phase I*. Alameda, CA: Taylor Engineering.

Wetter, M. (2013). Fan and pump model that has a unique solution for any pressure boundary condition and control signal. In *Proceedings of BS 2013: 13th Conference of the International Building Performance Simulation Association, Chambéry, France, August 26-28* (pp. 3505–3512).

Wetter, M., Grahovac, M., & Hu, J. (2018a). Control Description Language. *Proceedings of The American Modelica Conference 2018, October 9-10, Somberg Conference Center, Cambridge MA, USA, 154*, 17–26. <https://doi.org/10.3384/ecp1815417>

Wetter, M., Hu, J., Grahovac, M., Eubanks, B., & Haves, P. (2018b). OpenBuildingControl: Modelling Feedback Control as a Step Towards Formal Design, Specification, Deployment and Verification of Building Control Sequences. In *2018 Building Performance Modeling Conference and SimBuild, Chicago, IL, September 26-18, 2018* (pp. 775–782).

Wetter, M., Nouidui, T. S., Lorenzetti, D., Lee, E. A., & Roth, A. (2015). Prototyping the next generation energyplus simulation engine. *Proceedings of Building Simulation 2015:14th Conference of International Building Performance Simulation Association, Hyderabad, India, December 7-9*, 403–410.

Wetter, M., Zuo, W., Nouidui, T. S., & Pang, X. (2014). Modelica Buildings library. *Journal of Building Performance Simulation*, 102(1), 253–270. <https://doi.org/10.1080/19401493.2013.765506>