

UC Berkeley

Green Manufacturing and Sustainable Manufacturing Partnership

Title

Burrs-Analysis, control and removal

Permalink

<https://escholarship.org/uc/item/0zz4s5qb>

Journal

CIRP Annals - Manufacturing Technology, 58(2)

Authors

Aurich, J. C.
Dornfeld, D.
Arrazola, P. J.
et al.

Publication Date

2009-10-14

Peer reviewed

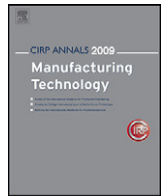

Burrs—Analysis, control and removal

J.C. Aurich (1)^{a,*}, D. Dornfeld (1)^b, P.J. Arrazola (3)^c, V. Franke^a, L. Leitz^a, S. Min (2)^b

^aInstitute for Manufacturing Technology and Production Systems, University of Kaiserslautern, Germany

^bLaboratory for Manufacturing and Sustainability, University of California, Berkeley, USA

^cManufacturing Department, Faculty of Engineering, Mondragon University, Mondragón, Spain

ARTICLE INFO

Keywords:
Machining
Burr
Burr control

ABSTRACT

Increasing demands on function and performance call for burr-free workpiece edges after machining. Since deburring is a costly and non-value-added operation, the understanding and control of burr formation is a research topic with high relevance to industrial applications. Following a review of burr classifications along with the corresponding measurement technologies, burr formation mechanisms in machining are described. Deburring and burr control are two possible ways to deal with burrs. For both, an insight into current research results are presented. Finally, a number of case studies on burr formation, control and deburring along with their economic implications are presented.

© 2009 CIRP.

1. Motivation and introduction to issues regarding burrs

The demands placed by designers on workpiece performance and functionality are increasing rapidly. Important aspects of manufacturing's contribution to the fulfillment of these demands are the conditions at the workpiece edges. While the geometries generated by designers in a CAD system or a technical drawing generally are clean and straight, the real geometry of the workpiece edges is to a large extent determined by the formation of burrs in the final manufacturing process. In many cases, time-consuming and expensive deburring processes have to be applied in order to ensure the desired part functionality.

Recent studies have shown a large economical impact of burrs and their effects. Not only is deburring a non-value-added process, but in many cases increasing burr formation is a key factor of cutting tool wear and leads to replacement of tools which are otherwise still operating without problems.

If burrs do not have to be removed from a workpiece for functional reasons, there are still two dangers remaining. Firstly, burrs are often quite sharp and can lead to small finger injuries for assembly workers. Secondly, burrs which initially stick to a part can become loose during operation of a product and cause damage later on (see for example Fig. 1). A well-known example for this are burrs caused by drilling operations in engine cylinder heads, where the burr is located in channels of the cooling system, comes loose during operation of the engine, is then carried by the cooling fluid on to different locations of the engine where it can potentially cause a complete engine failure.

A study carried out in the German automotive and machine tool industries showed costs associated with burr minimization, deburring and part cleaning. To evaluate the economic impact of expenses caused by burrs the participants of the survey were

asked to name the manufacturing share related to burrs for a specific workpiece. The expenses are caused by an increase of about 15% in man power and cycle times. In addition, a 2% share in the reject rate and a 4% share in machine breakdown times due to burrs were reported (see Fig. 2). Averaging the presented distribution without any weight factors the share accounts of up to 9% of total manufacturing cost [11].

An economic evaluation of the impact of burrs, chips and part cleaning related production cost has been provided by Aurich [11]. The costs are estimated as up to 500 million Euro expense per year only in Germany.

Other important issues are supplier–customer relations in which there is a clear need for a standardized description and measurement methods for burrs. However, there is still no widely applicable and accepted international standard available, even though in many contracts formulations such as “free of burrs” are used. Control and removal of burrs are one of the economically most important issues in many machining operations and have been in the focus of research in cutting operations for the last 50 years.

Earliest reported works describe burrs in punching. The first considerations of burr formation in metal cutting came along with investigations of chip formation. Both are closely interlinked with each other. Pekelharing [121] described investigations on chip formation in cutting and thereby presented the first research results on burr formation mechanisms.

The first fundamental work dedicated to burr formation mechanisms was published by Gillespie [48]. Gillespie presents an analytical model which illustrates burr formation mechanisms and which predicts burr properties. The results of this model are compared to experimental observations. After a basic understanding of the mechanisms underlying burr formation had been reached, the focus of research turned to deburring. Deburring is a very time-consuming and costly operation. In many cases deburring is a tedious manual task.

There are a large number of deburring procedures, tools and machines available today, often based on the fundamental work on

* Corresponding author.

E-mail address: aurich@cck.uni-kl.de (J.C. Aurich).

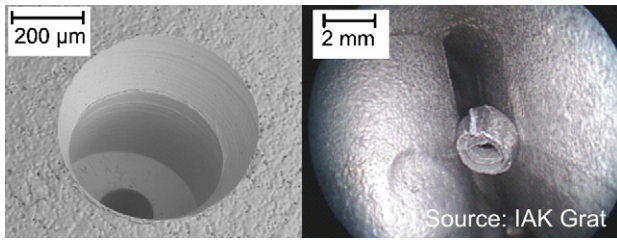

Fig. 1. Burr in an injection hole of a fuel system (left) chip in a fluid loop (right).

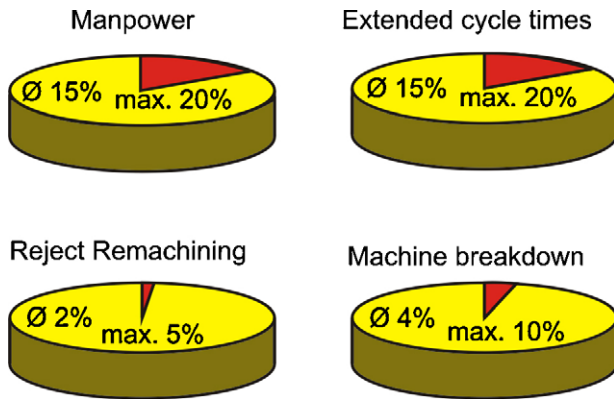

Fig. 2. Share of manufacturing effort caused by burrs [11].

deburring carried out by Schäfer [133] and Gillespie [48]. Yet, in industrial practice many deburring operations are still carried out manually.

This paper presents a comprehensive overview on the topic of burrs formed in machining operations. Several CIRP colleagues have provided significant insight on burr formation mechanisms and deburring.

2. Burr descriptions and classification

Presently, there are various international and national standards as well as proprietary standards for describing burrs and evaluating the quality of component edges.

For thousands of years there was no word for a “burr” formed by machining, but Erasmus Darwin, grandfather of Charles Darwin, a naturalist and poet, appears to be the first person to mention “burr” in writing (1784).

In the Oxford English Dictionary a burr is described as a rough ridge or edge left on metal or other substance after cutting, punching, etc.; e.g. the roughness produced on a copper-plate by the graver; the rough neck left on a bullet in casting; the ridge left on paper, etc., by puncture.

In most cases, burrs are defined as undesirable or unwanted projections of the material formed as the result of the plastic flow from cutting and shearing operations.

The CIRP dictionary does not yet provide a definition of the term burr.

2.1. Burr definitions

In technical drawings or geometric workpiece models, the ideal geometric shape is represented without any deviation and, in general, without consideration of the edge conditions. Sometimes, a chamfer is indicated as workpiece condition. But then, the chamfer is assumed to exhibit ideal geometry (which cannot or only with large expenses be realized). However, for many purposes, i.e. the functioning of a part or for safety considerations, particular states need to be indicated [67]. Such states include those of external edges free from burr, sharp edges or those with a burr. The ISO 13715 [67] defines the edge of a workpiece as burred if it has an overhang greater than zero (Fig. 3).

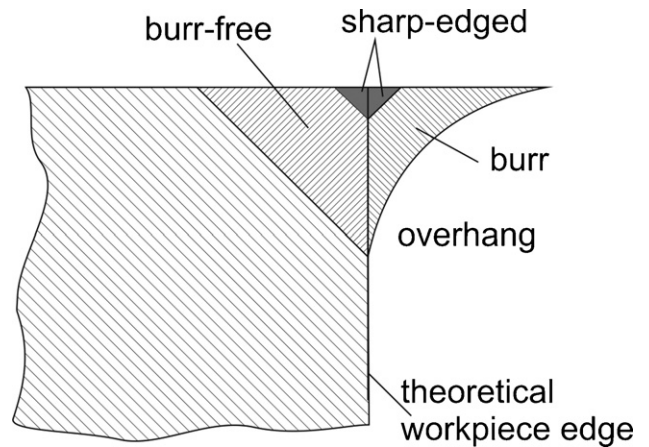

Fig. 3. Definition of burrs according to ISO 13715 [67].

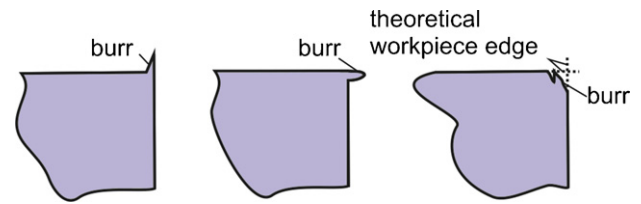

Fig. 4. Examples of burr definition according to [47].

Schäfer [133] gives one of the earliest technical descriptions of a burr. He describes a burr as the part of a workpiece which is produced through manufacturing processes on an edge or a surface and which lies outside the desired geometry. Ko [81] bases his work on this definition and defines a burr as an “undesirable projection of material formed as the result of plastic flow from a cutting or shearing operation”.

A comprehensive definition can be found in [19]. A burr is a body created on a workpiece surface during the manufacturing of a workpiece, which extends over the intended and actual workpiece surface and has a slight volume in comparison with the workpiece, undesired, but to some extent, unavoidable.

Gillespie’s definition of the burr is limited to cutting and shearing processes. A burr produced by those operations includes “all the material extending past the theoretical intersection of two surfaces, which surround the burr”. The reference in that case is the theoretical intersection of the two surfaces and not the desired surface. In addition, Gillespie’s definition includes burrs that lie inside the theoretical intersection as shown in Fig. 4 [47].

2.2. Burr geometry

Schäfer [133] uses a random cross-section for describing basic burr parameters. He states that each burr can be characterized by its longitudinal and cross-sectional profile and defines the following burr descriptions and measurement categories.

- The burr root thickness b_f is the thickness of the burr root area measured in the cross-section.
- The burr height h_0 is defined by the distance between the ideal edge of the workpiece and the highest point in the cross-sectional area.
- The burr root radius r_f as shown in Fig. 5 is determined by positioning a circle to the burr root.
- The burr thickness b_g describes the thickness parallel to the burr root area at a distance of r_f , as measured in the cross-section [133].

The longitudinal profile of a burr is not very informative in most cases, and therefore, it is rarely used to describe burrs. The length of the burr is of interest because it describes how much of the total

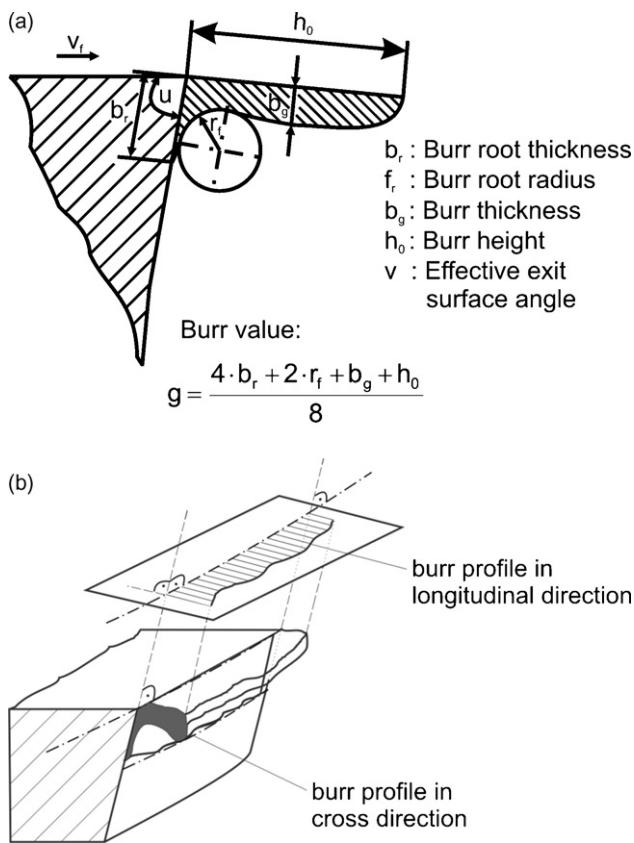

Fig. 5. Measurement values of a burr [133].

edge length exhibits a burr. This in turn is directly related to the time necessary for deburring of a workpiece.

For a detailed description of burrs the so-called burr value has been defined (Fig. 5). The burr value g consists of the four geometric parameters burr root thickness b_r , burr root radius r_f , burr thickness b_g , and burr height h_0 . The different weighting factors result from the impact of the individual burr parameters on the deburring process [101].

The ISO 13715 [67] standard uses only one value to define the deviation from the ideal geometrical outline of the edge, see Fig. 6. The size of the edge area is termed “edge measure a ”. This value is measured from the burr tip perpendicular to the surface from which the burr is protruding.

2.3. Standards for burr classification

There are still no universally accepted definitions for “burr”. Many companies and quality departments define an edge as “burr-free” if no loose material can be detected. To others it means that there is no material, forming a burr, visible to the naked eye. To some it means an edge condition that will not cause any functional problem in the next assembly, even though a supplier often does not know the exact requirements for the next assembly. Some researchers also call edge breakout (missing material) a burr. In some cases, EDM resolidified material is seen as a burr, sometimes flash is regarded as a burr, and sometimes plating build up at edges is considered a burr. A hump of rounded metal at an edge is a burr to some and not to others [49].

There are various general standards for evaluating the quality of component edges and for classification of burrs build by a material removal process. Below, already existing international proposals for classifying component edges will be presented.

The first standard for burr classification introduces seven quality steps which are followed by a verbal description of the target state of the component edge for each quality step. Further, a description of the verification process is given for some instances [50].

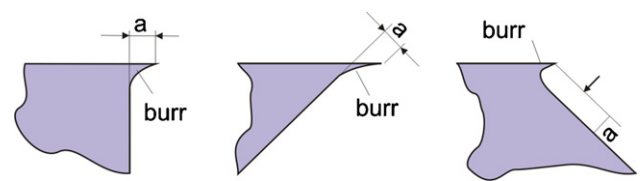

Fig. 6. Burr geometry as indicated in ISO 13715 [67].

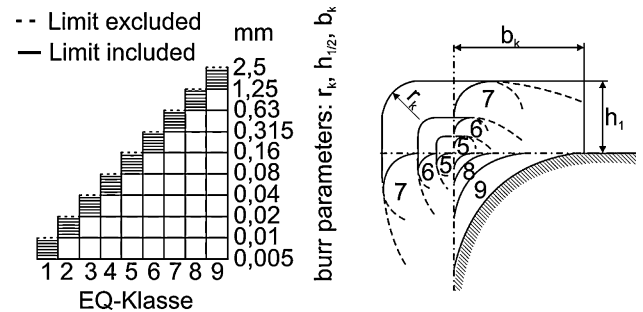

Fig. 7. Edge quality classes [133].

Schäfer's [133] classification provides nine classes of deburring quality. The class limit is determined quantitatively by using series of preferred numbers in order to achieve homogeneous spacing and to keep the number of classes small. This ensures that the classification is applicable in practice. Furthermore, the measuring parameters for deburring quality are entered into four quadrants of a coordinate system (Fig. 7).

A proposal for evaluating edge quality created from a quality assurance engineer's point of view is given in [115]. This proposal for standardization is based on case studies. By using code tables and work instructions, acceptable burr heights and burr states are defined.

An additional standard for classification of deburring quality is given by Kato [71]. It describes edge states uniformly through many important functions fulfilled by component edges. He introduces tables describing quality steps of machined component edges which are divided into edges with critical and non-critical functions. Further, the system subdivides critical edges into five quality steps and non-critical edges into three quality steps. The edge dimensions are stated quantitatively, and a tolerance range is defined.

Another system uses symbols for component areas or edges which contain all relevant data required for machining and evaluation. It covers mostly the various applications of the automotive industry and its suppliers. The quality necessary for a function such as geometric parameters, acceptable tolerances and evaluation methods can be defined using this standardization [23].

Finally, in this context it should be mentioned that the an industry survey, carried out in the so-called (in German) “SpanSauber” project, showed that due to the lack of an overall accepted burr classification approximately 45% of interviewed companies use an in-house classification [11].

2.4. Types of burrs in material removal

Today, there exist numerous different burr descriptions depending on application, manufacturing process, shape, formation mechanism and material properties.

Gillespie [48] is among the first to describe different types of burrs. Four types of machining burrs were detected: Poisson burr, rollover burr, tear burr and cut-off burr, see Fig. 8. The Poisson burr is a result of the material's tendency to bulge to the sides when it is compressed until permanent plastic deformation occurs [46]. Narayanaswami calls this a side burr because the “Poisson” effect as known from Engineering Mechanics is only applicable in the

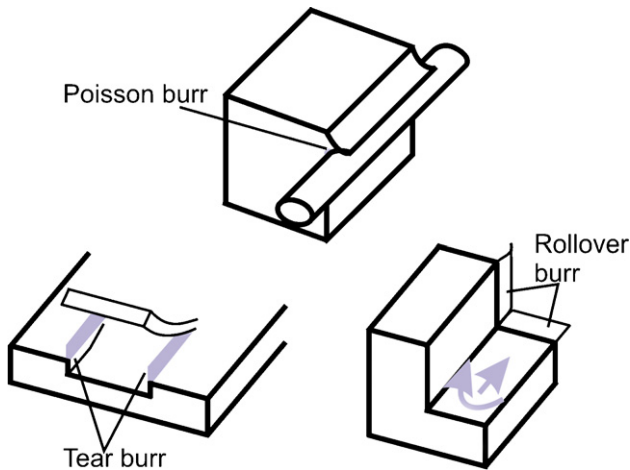

Fig. 8. Schematic of Poisson, tear and rollover burr [48].

elastic range [112]. The rollover burr is essentially a chip which is bent rather than sheared resulting in a comparatively large burr. This type of burr is also known as an exit burr because it is usually formed at the end of a cut. The tear burr is the result of material tearing loose from the workpiece rather than shearing clearly. It is similar to the burr formed in punching operations. The cut-off burr is the result of workpiece separation from the raw material before the separation cut is finished [48].

From the point of view of cutting technology, machining burrs are more appropriately described by the cutting edge which is directly related to burr formation and also by the mode and direction of the burr formation. The sideward burr in orthogonal cutting was firstly studied because it is one of the most basic types of burr [111]. Nakayama [111] studies burr formation and in particular, side burrs through experimental investigations. He describes machining burrs formed in various cutting operations by the combination of two systems of classification: (1) by cutting edge directly concerned and (2) by the mode and direction of burr formation. Fig. 9 shows the various types of machining burrs.

Kishimoto [78] finds in his tests two types of burr, primary and secondary burr. He claims that through proper selection of cutting conditions and tool geometry, the rollover burr will be separated at its thinnest portion and only a small burr will remain on the edge of the machined part. The former normal burr is named a primary burr and the latter one a secondary burr which is the material remaining after the breakage of the primary burr. Beier on the other hand describes a secondary burr as material which remains on the edge of a part after a deburring process [19].

2.4.1. Burrs from turning operations

Typically burrs occurring in turning operations are Poisson burrs (Fig. 10). They form when the cutting edge of a tool extends past the workpiece edge. Yet, if the cutting tool passes over a groove or cutting is interrupted due to other geometric features of the workpiece, a rollover burr forms. In turning operations, most burrs are created as a rollover burr at the side of the workpiece when the tool exits from cutting [50].

2.4.2. Burrs from milling operations

Chern [29] finds in his tests that the type of burr in milling is highly dependent on the in-plane exit angle. He observes five types of burrs illustrated in Fig. 11: (1) the knife-type burr; (2) the wave-type burr; (3) the curl-type burr; (4) the edge breakout; and (5) the secondary burr.

Hashimura [56] classifies burrs in face milling according to burr locations, burr shapes and burr formation mechanisms. The burr attached to the surface machined by the minor edge of the tool is name exit burr. A side burr is defined as a burr attached to the transition surface machined by the major edge and a top burr is

(1) Cutting edge directly concerned	
Major cutting edge	M
Corner or minor cutting edge	C
(2) Mode and direction of formation	
Backward flow	B (Backward or entrance flow)
Sideward flow	S (Sideward burr)
Forward flow	F (Forward or exit burr)
Leaning to feed direction	L (Leaned burr)

(a)

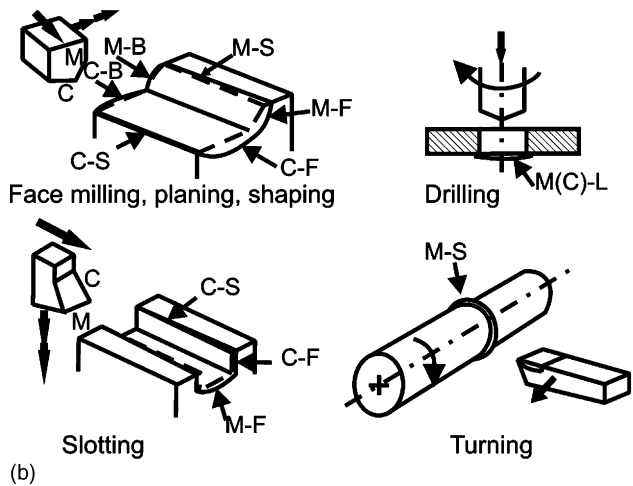

Fig. 9. Types of machining burrs [111].

defined as a burr attached to the top surface of the workpiece. The different types of milling burrs are illustrated in Fig. 12.

2.4.3. Burrs from drilling operations

In drilling, the burr that forms at the entrance of the hole can be a result of tearing, a bending action followed by clean shearing, or lateral extrusion. The burr that is formed when a sharp drill exits the workpiece is a Poisson burr resulting from rubbing at the margins of the drill. When a normal or worn out drill exits the uncut chip rolls, resulting in a rollover burr [50].

Kim [76] categorizes drilling burrs as uniform burr with or without a drill cap, crown burr or petal burr according to their

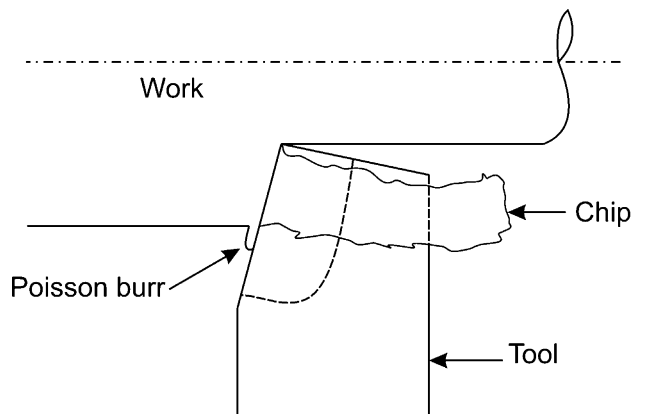

Fig. 10. Poisson burr formed when cutting edge of tool extends past edge of workpiece [50].

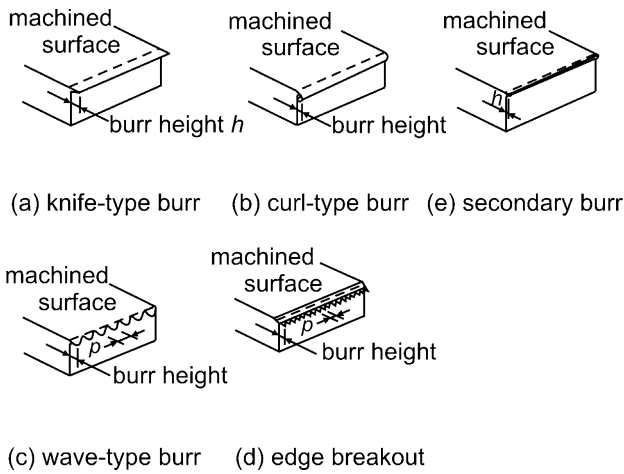

Fig. 11. Five types of burrs observed in face milling [29].

shapes and formation mechanism. Two types of burrs, uniform burr (type I: small uniform burr, type II: large uniform burr) and crown burr, for stainless steel and three types of burrs, uniform burr (type I: small uniform burr, type II: large uniform burr), transient burr, and crown burr, for low alloyed steel were found (Fig. 13).

2.4.4. Burrs from grinding operations

Burrs produced by surface grinding are located at the edges of the workpiece and can be classified into entrance burrs, side burrs and exit burrs (see Fig. 14). These burrs can vary largely in size and shape and are created through different formation mechanisms. In flat surface grinding the exit burr is the most dominant burr type and therefore has been investigated most closely.

In grinding, under common operating conditions burrs are comparatively small and can often be found only at microscopic level. Yet, depending on the field of application, even these microscopic burrs can affect the functionality of a workpiece to a large extent [17,8,156].

3. Burr formation mechanisms

3.1. Mechanics of burr formation/analytical models

Numerous authors have published models on burr formation in different machining processes. The work of Pekelharing and Gillespie lays the foundation in this field. The focus of Pekelharing's

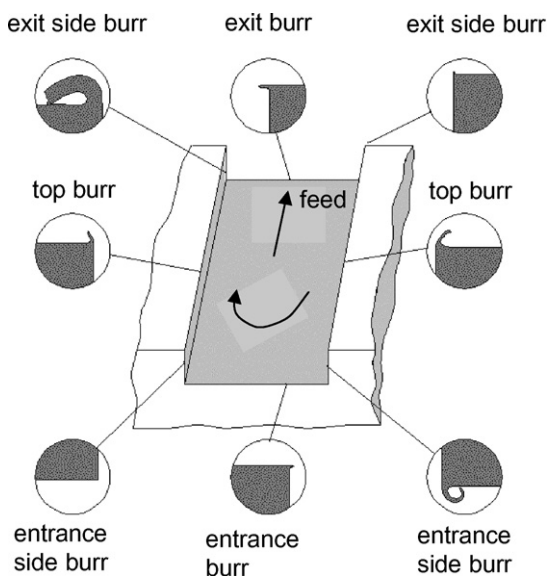

Fig. 12. Types of milling burrs [56].

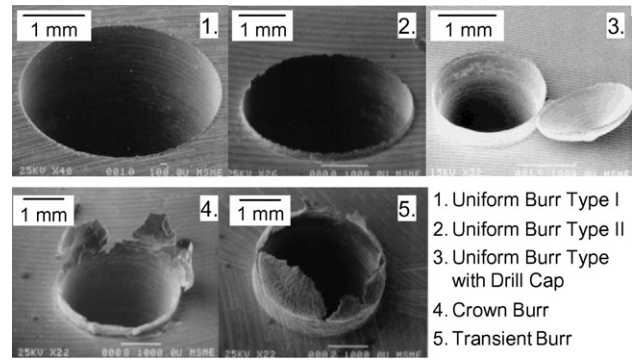

Fig. 13. Typical drilling burr types according to CODEF [76].

burr shapes on the workpiece in surface grinding

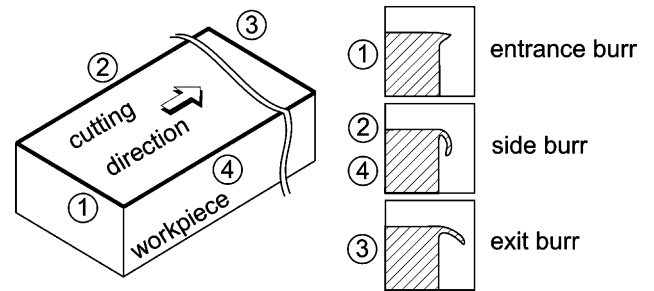

Fig. 14. Burr shapes on the workpiece in surface grinding [17].

research work is chip formation rather than burr formation in particular. Due to the fact that burr formation very much depends on chip formation mechanisms, Pekelharing is the first to describe burr formation in metal cutting. In [122] the research shows that negative shear is responsible for exit failure of cutting tools and foot type burr formation in milling (see Fig. 15).

Schäfer [133] differentiates between two kinds of burr formation:

1. Displacement of material in burr forming force direction.
2. Displacement of material normal to burr forming force.

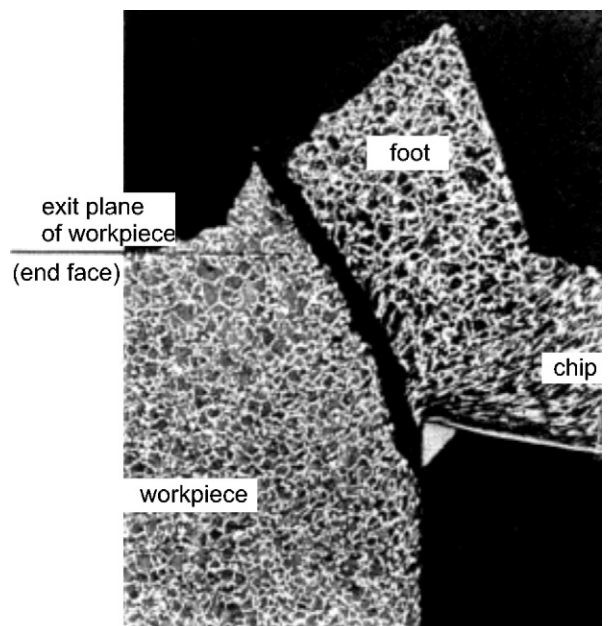

Fig. 15. Micrograph of the chip root showing the exit failure, negative shear, and foot formation [122].

Schäfer [133], Beier [19] and Thilow [146] observe that in machining processes a burr forms always if the material escapes the cutting process and occurs at tool entry and exit. This finding leads to the following conclusions:

- Material tends to form larger and more burrs with increasing ductility.
- Burr formation is lower if the material is restricted to deform in force direction due to workpiece geometry and machining conditions.

Following, a model for burr formation in cutting processes developed by Beier [19] is described. If one body (cutting edge) penetrates into another body, a three-dimensional compression (stress) cone forms. If the range of elastic deformation is exceeded, lasting deformations in all three spatial directions even at the cutting edge occur. These permanent plastic deformations form preferably in the direction of lowest resistance. This leads to enduring material formation at the machined workpiece, at the face where no material has been removed by the tool. The burr forms beyond the contact area of tool and workpiece.

Gillespie undertakes intensive research in burr formation mechanisms. He states six physical processes which form burrs [50].

1. Lateral flow of material. It occurs whenever a solid is compressed.
2. Bending of material (such as chip rollover).
3. Tearing of chip from workpiece.
4. Redeposition of material.
5. Incomplete cut-off.
6. Flow of material into cracks.

The processes one to three involve plastic deformation of the workpiece material. The redeposition of material, as in recasting processes for example, forms a burr like projection due to solidification of material on the working edges. The sixth process regards burrs produced by molding or primary shaping.

Hashimura [56] considers the burr formation mechanism to be affected not only by cutting conditions including the geometry of the workpiece and tool, but also by the mechanical properties of the workpiece.

Fig. 16 shows schematic views of burr formation mechanisms as described by Hashimura. He classifies eight stages in the burr formation process. From a certain stage of burr formation on, the process has to be considered separately for ductile and brittle materials. This is necessary as crack propagation and the deformation before crack propagation are important for the final burr shape and are different when machining ductile or brittle

Schematic of Burr Formation

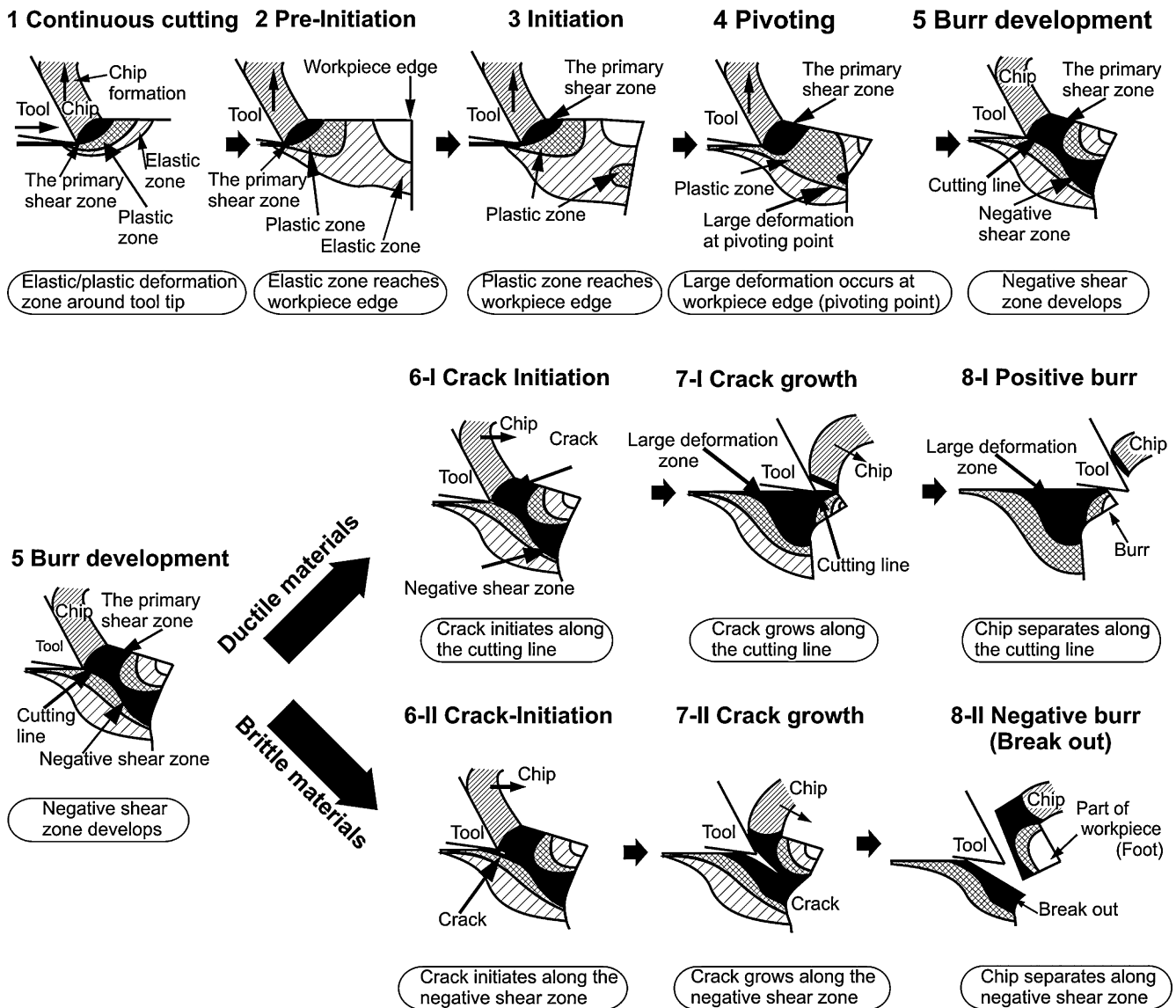

Fig. 16. Schematic of burr formation [56].

materials. Stage 1 describes continuous cutting with flow type chip for ductile materials and either shear or crack type chip for brittle materials. In stage 2, called pre-initiation, the deformation and stress distribution are affected by the workpiece edge. The elastic deformation zone intersects the workpiece edge or appears at the workpiece edge as elastic bending. The plastic deformation zone around the primary shear zone is also considered to be extended toward the edge. Burr initiation is starting in step 3. The plastic deformation occurs at the workpiece edge as plastic bending. The plastic deformation zone around the primary shear zone and the primary shear zone are also considered to be extended. Step 4 describes pivoting. A large catastrophic deformation occurs at the workpiece edge. A pivoting point where the large deformation is visually apparent can be observed. A negative shear zone develops in stage 5. The burr develops and the large deformation at the pivoting point expands to connect with the deformation in the primary shear zone. The large deformation zone below the cutting line is called the negative shear zone. As the tool moves toward the workpiece edge, the workpiece corner continues to pivot with the chip and the burr size increases.

Stages 1–5 are explaining burr development without crack formation. Stages 6–8 are describing chip separation by crack propagation for ductile and brittle materials. Stage 6-I describes crack initiation for ductile materials. The crack initiates at the tool tip in the primary shear zone in a direction along the cutting line. This occurs because ductile materials have a large critical fracture strain. The crack grows along the primary shear zone (stage 7-I). Moving along the cutting line, the tool not only leads to a growing crack but also deforms the workpiece. As a result, the crack appears to grow along the cutting line. Stage 8-I indicates the end of burr formation. The crack causes separation of the chip along the cutting line and a positive burr remains on the corner of the workpiece. For brittle materials the crack initiates at the tool tip in the negative shear zone and its propagation direction is toward the pivoting point (stage 6-II).

The chip is separated from the workpiece by the crack in the secondary shear zone. In stage 7-II the crack grows along the negative shear zone. Moving along the cutting line, the tool induces crack growth and the crack mode may change from shearing mode to opening mode. The workpiece edge also deforms slightly due to crack propagation. Stage 8-II again indicates the end of burr formation. The crack separates the chip along with the part of the workpiece above the negative shear line. As a result, an area consisting of the fractured surface and a small amount of deformed material remains on the workpiece edge. In this case, the burr breaks out and is called a negative burr.

The mechanics of burr formation are similar for all cutting processes. Nevertheless, there are small differences which will be further described in the following passages.

Ko introduces a model to predict burr formation in orthogonal machining of ductile materials, such as copper, which do not exhibit fracture along the negative shear plane. The initial burr formation is characterized by the initial negative shear angle and the initial tool distance from the end of the workpiece. In his studies, burr size depends on the initial negative shear angle and the initial tool distance from the end of the workpiece at which the transition to burr formation occurs. Increasing thickness of the undeformed chip and decreasing tool rake angle lead to increasing burr size. Material properties are an important factor in predicting

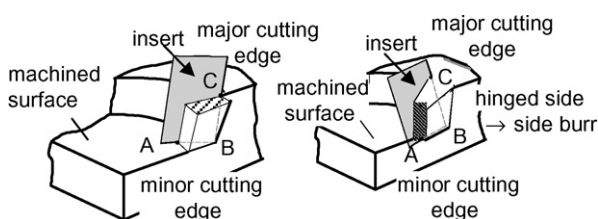

Fig. 17. Influence of exit order on burr formation according to [56].

the burr formation mechanism. The burr size reduces as cutting speed increases during orthogonal cutting of ductile material [81]. Using the burr formation and fracture model for orthogonal cutting suggested in previous work, a modified burr formation model including the fracture phenomenon in oblique cutting is proposed in [82]. It is based on the rollover burr being formed in the cutting direction and the oblique cutting being an accumulation of segmented orthogonal cutting. Chern [31] states – similar to Ko's findings – plastic bending and shearing of the negative deformation plane as the dominant mechanisms in burr formation in orthogonal cutting whereas crack propagation along the plane causes the edge breakout. Furthermore, he observed two modes of breakout formation. Fracture mechanisms involved during the cut were identified by examining the fracture surfaces obtained from impact machining tests.

A description and classification of burr formation in face milling is given in [56]. The exit order of the cutting tool has important effects on burr formation and influences burr position and burr dimensions (see Fig. 17).

Material above the cutting line is pushed down and remains as burr material on the workpiece after the tool leaves the workpiece. In face milling, two types of burrs are formed [154]. One type forms in feed direction, the other on in cutting direction. Burrs in cutting direction can be differentiated into three kinds according to their thickness and height.

For burr formation in drilling operations Stein [144] reveals in her investigations that the constant ratio between burr height and undeformed chip thickness may be a fundamental property of work material for a particular tool geometry. This occurs in regions of undeformed chip thickness, where the tool performs a cutting rather than a plowing action. Min develops a burr formation model specific to drilling of intersecting holes. An interaction angle that defines the interaction between the cutting edge and the exit surface was proposed under the assumption that the exit surface geometry does not change. It includes dynamic motion of the cutting edge induced by feed and speed. When the interaction angle is positive, the cutting edge exits from the workpiece and vice versa. The model can predict the likely burr formation area that can be represented as the positive interaction angle. The area increases as feed increases, speed decreases, and the exit surface angle decreases. An effective exit surface angle was proposed in order to incorporate the change of the exit surface geometry during drilling. Due to the plastic deformation at the end of a cutting process, the exit surface geometry changes. Depending on the angular position of the exit surface, the effective exit surface angle changes. A small negative exit surface angle leads to early initiation of the bending mechanism and results in a large burr. Hence, thinner parts of a workpiece may have a larger burr. The interaction angle dictates exiting and entering of the cutting edge. It thereby predicts the likely burr formation area. The effective exit surface angle defines the size of burr and shifts the likely burr formation area calculated through the interaction angle in the

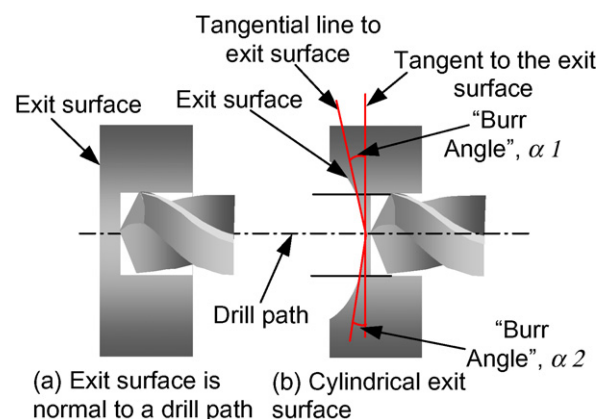

Fig. 18. Burr formation when drilling intersecting holes according to Min [105].

rotational direction of the drill [107] (see Fig. 18). Leitz develops two kinematical process models describing tool exit and entry conditions, as well as the calculation of remaining material when drilling intersecting holes. The combination of these process models and experimental results enables well funded declarations on burr position and shape depending on intersection geometry [96].

Kawamura [72] investigates burr formation in grinding. The following three types of burrs occurred: entrance, exit and side burr. The exit burr in most cases is the largest burr. The entrance burr has the smallest size, and the side burr is 70–80% of the size of the exit burr. Close to the workpiece end, the plastic flow zone extends and forms the burr root thickness. However, the extension of the plastic zone may be prevented by an increased edge angle. Barth [17] extends and refines Kawamuras model. Burr formation is significantly influenced by process forces and the change in workpiece material behavior during cutting due to temperature effects and the geometry on the edge of the workpiece. Barth's investigations prove the significance of a burr-orientated design of workpiece edges.

Aurich [8] states that similar to burr formation processes with a defined cutting edge, the formation of burrs in grinding operations can be divided into five steps which are continuous grinding, pre-initiation, burr initiation, burr development and final burr formation. During the continuous grinding phase, no macroscopic deformation occurs at the workpiece. A concentration of heat at the exit edge of the workpiece is observed. Spiral burrs were identified in high performance grinding and the formation mechanism can be explained by a plastic flow zone.

The introduced analytic models serve as the basis of finite element analysis of burr formation.

3.2. FEM analysis and burr formation simulation

Finite element method analysis can be used as a tool to understand and predict burr formation. The current state of research and future trends of burr formation simulation and modeling are outlined in [99].

Hashimura [54] develops a basic model of burr formation. It includes the influence of material properties in orthogonal cutting. The FE-simulation confirmed experimental results using an elastic–plastic model with plain strain condition for the analysis. The first five stages of burr formation introduced by Hashimura, already discussed in Section 3.1, could be verified using the finite element method. Different burr formation behavior of brittle materials in comparison to ductile materials, particularly with respect to crack propagation, could be visualized. Burr formation in orthogonal cutting is as well modeled by Park [118] and Leopold [97] (Fig. 19). This model investigates the burr formation process as well as burr or edge breakout in 304L stainless steel. Based on this analytic model Park [119] examines the influence of exit angles of the workpiece edge, tool rake angles, and backup materials on the

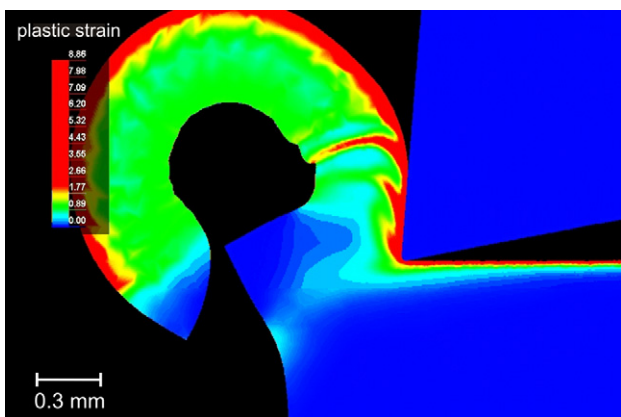

Fig. 19. FEM simulation of burr formation in orthogonal cutting [97].

burr formation processes in orthogonal cutting. Klocke [79] models burr formation in orthogonal cutting of medium carbon steel AISi1045 in a two dimensional FE-simulation. The model is based on an implicit Langrangian code. It is shown that the modeling of burr formation using FE analysis leads to good results and detailed information about the distribution of stress, strain, strain rate and temperature. However, some results of the simulation do not correspond to the experimental ones. The values of burr thickness and length differ from the measured ones. This is due to modeled and real chip formation. Burr formation in feed direction during turning is modeled in [148]. The model is able to predict height and thickness of the burr, and describes burr development from its initiation until the moment when the burr is fully formed. The model considers two cases: continuous burr development, when the burr has grown uninterruptedly and discontinuous burr generation, when the burr that is being formed is cut off and is renewed with each revolution of the workpiece. The proposed model can be used to predict burr appearance on the edges of machined parts as well as to visualize burr formation. It can also be applied in independent burr expert systems so as to predict the burr dimensions or to minimize burr formation by choosing optimal cutting conditions [148]. Stoll [145] develops finite element models for conventional and ultrasonically assisted cutting. Fewer burrs are formed when applying ultrasonically assisted cutting. The finite element simulation of burrs is only possible to the point of separation of chip from the workpiece. The final burr shapes obtained in simulations and experimental results are still not identical. In earlier work Hashimura [55] applies FE analysis to explain the basic phenomena in burr formation in milling. Chu [38] predicts and simulates milling burr formation implementing a burr control chart (burr prediction system).

Several investigations have been carried out in order to simulate drilling burrs. A three-dimensional finite element model is developed by Guo [51,52] to investigate the mechanisms of drilling burr formation with a backup material (Fig. 20). This model also predicts cutting forces in drilling, and explains the correlation of thrust force and burr size. Simulation results show that negative shear situation near the edge of the hole and gap formation are the primary mechanisms in drilling burr formation with backup

Burr formation mechnism	Proposed burr formation mechnism	FEM simulation	High-speed camera image
(a) Steady-state			
(b) Initiation			
(c) Development			
(d) Initial fracture			
(e) Final burr			

Fig. 20. FEM simulation of burr formation in drilling.

material. The use of a bushing having zero clearance will result in significantly shorter and thinner exit burrs than typical for conventional drilling. The use of a solid backup material was less effective in minimizing burr size above an unsupported exit surface. Later on, Min [105,106] develops a nonlinear elastic–plastic 3D finite element model for burr formation in drilling 304L stainless steel. Thereby, he could predict characteristic geometries of drilling burrs. He divides the burr formation process into four characteristic stages. These are initiation, development, pivoting point and formation stages. Min [108] calculates the trust force at the burr initiation point when drilling using a FE model (AISI 304L). Kim [73] investigates thrust force in drilling processes as well. He develops a formula to predict thrust force in drilling processes. He introduces an analytic model to predict final drilling burr size. The model contains effects of material properties, drill geometry and process conditions. An experimental validation of the model has been undertaken. Choi [34] simulates burr formation when drilling multilayered material. He observes interlayer burr formation and entrance burr formation. Furthermore, it is possible to estimate burr height and burr thickness quantitatively. Yamakawa [160] investigates grinding burr formation with the means of finite element analysis. In his calculations, grinding temperature and cutting force for a cutting point are considered. It is possible to derive thermal and mechanical stress distributions and the plastic deformation at the workpiece edge from the simulation. Aurich [9] develops a burr formation model in grinding to simulate burr formation at the exit edge with FEA. The model allows predicting heat development in the tool contact zone. In addition, the formation of spiral burrs in high performance grinding is simulated.

3.3. Parameters with influence on burr formation

It is necessary to differentiate investigations which cover burr form and others that cover the topic of minimizing burrs.

Gillespie [48] already observes that burrs cannot be prevented by changes in feed, speed, or tool geometry alone. Still, the size of burrs produced can be minimized significantly by choosing

appropriate machining parameters. To minimize and prevent burrs it is necessary to examine the entire cutting process. It is not sufficient to change only one process parameter as there are many influences between the parameters. Burr formation is affected by various parameters. Major effects are workpiece material, tool geometry, tool wear, tool path and machining parameters. In most cases a change of workpiece material is not possible. As to an improved tool path, this approach is also limited, as complex geometries would require burr optimized tool paths that prolong cycle time as negative effect.

Link [101] points out that burr formation parameters cannot reliably be separated into direct and indirect factors due to the complex connections and relations between the numerous influencing variables (Fig. 21). Wang [155] investigates cutting burrs. The main factors of cutting direction burr formation are cutting parameters, the shape of the workpiece end, cutting tool geometry and workpiece material. The burr height in cutting direction is reduced with the increase in the depth of cut, feed, cutting edge angle and back rake angle. An increase of corner radius leads to increasing burr height. In his early work Schäfer [134] investigated face milling. He reveals that low feed leads to small burrs and burr root thickness. An increase of workpiece edge angle causes smaller burrs. Chern [32] studies micromilling. Burr height and breakout length increase proportionally with the depth of cut. The fracture strain of the workpiece determines at what exit angle breakout instead of burr formation will occur. Olvera [117] finds little difference in size of burrs in face milling produced by coated and uncoated inserts. An insert with a nose radius rather than a wiper blade produced larger burrs. Changing from up-milling to down-milling leads to a reduction and often elimination of sideward burrs. Jones [70] investigates the effect of cutting speed, feed, material hardness, tool wear state and cutting tool exit angle in face milling of aluminum in regard to their influence on burr formation. Regardless of tool wear state, exit angles between 76° and 118° produce the smallest burrs. Furthermore, high feed, low speed, new tools and harder material have a positive effect on burr minimization. Bansal [16] reveals that milling inserts with positive axial rake and negative radial rake angles result in a good

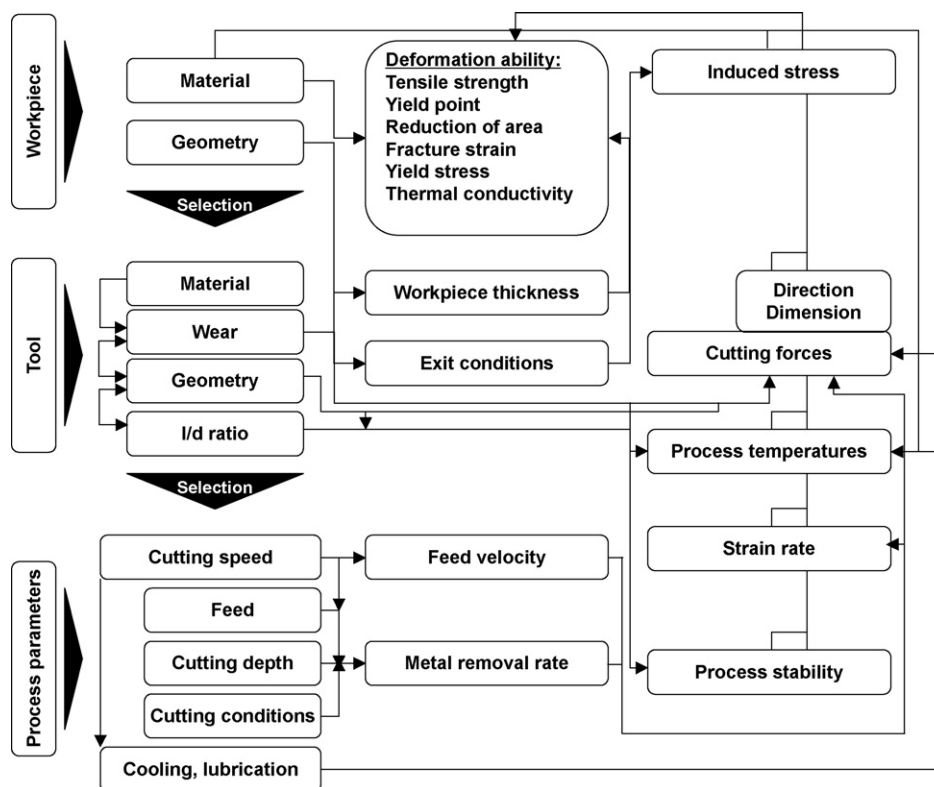

Fig. 21. Interdependencies of burr formation parameters according to [101].

trade-off between small burr size and good surface quality. Machining aluminum at high cutting speeds leads to good surface quality and small burrs. Low cutting speeds are suggested for good surface quality and small burrs when face milling magnesium. Microburr formation in stainless steel cutting is investigated under various feed per tooth and cutting speed values by Lee [90]. The burrs in hole manufacturing are relatively larger than in conventional milling. Burr height is linearly proportional to feed per tooth and related to tool wear. Burr size and tool life can be predicted and controlled through the control charts developed.

Balduhn [14] develops a database to collect data on burr formation in face milling. It enables the identification of most suitable insert materials that generate the smallest burrs. De Souza [41] investigates milling burr formation at the exit region of a workpiece. Increasing tool wear as well as increasing feed rate lead to increasing burr length. Wang [154] confirms that the main factors for burr formation in face milling are workpiece material, cutter geometry, cutting parameters and the shape of the workpiece end. Avila carries out additional research in the field of face milling.

He investigates the effect of depth of cut, insert nose sharpness, lead angle and axial rake angle on burr formation. The formation of primary burrs at high radial tool engagements can be reduced by increasing the depth of cut. The depth of cut is limited by the requirements of surface roughness, depending on the workpiece application. An increase of axial rake angle and small lead angles results in smaller burrs. Increasing nose radii lead to increasing burrs. Studies on the effect of increasing cutting speed revealed a burr reduction [13]. Different aluminum alloys are tested by Chern [30]. The in-plane exit angle has a major effect on burr formation. A machining guideline in face milling is proposed. In-plane exit angle should be about 150° . Furthermore, the depth of cut should be set at a larger value than the corresponding critical depth of cut, in order to reduce burr size effectively through the formation of secondary burrs, as defined in [78]. Increasing feed rate helps as well to reduce burr size, as secondary burrs are produced.

The following passage identifies parameters influencing burr formation in drilling. Ogawa [114] investigates the influence of tool geometry on chip and burr formation. Nicks are applied at high-speed steel twist drills to split the chip into narrow chips. Nicks on the outer side of the cutting edge reduce burrs significantly. Lower drilling torque and longer tool life are achieved.

In [143] drilling of intersecting holes is investigated. The workpiece exit angle in drilling is an important factor in determining burr size and shape. The shape of burrs around on-axis holes is more uniform than the shape for off-axis holes, and this difference is probably determined by the variation in exit angles between the two configurations. The feed and the feed/cutting speed interaction, in addition to the exit angle, are also influential factors for the burr size in both on-axis and off-axis intersecting hole drilling. Beier [19] as well reveals several parameters to reduce burr formation when drilling intersecting holes. Factors which influence microburr size and shape are investigated in [144]. Increasing levels of feed rate, spindle speed and tool wear change the shape of the burr and increase burr size.

Heisel [58,59] investigates burr formation in deep hole and short hole drilling. In short hole drilling a reduction of burr height when increasing feed is achieved. An increase of speed does not increase burrs. Trigon shaped inserts reduce burrs about 50% in comparison to quadratic inserts. Workpiece material has a major effect on burr formation as well. In deep hole drilling, low cutting velocity and high feed lead to smaller burr profiles. Different drilling burrs form depending on whether cooling lubrication is applied or not. The geometry of the drill greatly affects the burr formation. Lager helix angle and increasing point angle reduce burr height and thickness [42]. An approach to predict burr formation implementing artificial neuronal networks is presented in [43]. Basavarajappa [18] finds out that increasing graphite reinforcement in metal matrix composites reduces burr height. Feed rate

has more influence on burr height than cutting speed and drilling with multifacet drills reduces burr height.

In [72] burr formation at the edges of ground workpieces is investigated. The burr height increases with the number of grinding passes. Burr root thickness is greatly affected by work material hardness. Hofman [66] displays that increasing depth of cut and work speed leads to an increase of burr height and thickness. The micro-hardness in the burr root is higher than in the base material. In [17] similar investigations are presented. The examination of burr formation in grinding with conventional and superabrasive wheels reveals a significant influence of process forces, the change in workpiece material behavior during cutting due to temperature and the geometry on the edge of the workpiece. An increase in depth of cut leads to an increase in burr height and burr thickness. A comparison between conventional and superabrasive grinding wheels reveals that for conventional wheel burrs tend to be of a long and thin shape whereas burrs generated with superabrasive wheels tend to be relatively small and thick. In [8] burr formation in conventional grinding as well as under high performance grinding conditions is investigated. The size and shape of the burrs vary widely. Small burrs are generated under conventional cutting conditions where as big spiral burrs are generated under high performance cutting conditions.

3.4. Experimental results

Ko [80] analyzes burr formation conducting orthogonal slow speed machining tests with ductile and brittle material using a SEM.

For an aluminum alloy burr formation in orthogonal cutting is investigated in [55]. As feed increases, the tool position corresponding to the appearance of the pivot point increases. The pivot point appears on the exit surface earlier in the tool motion and further below the machined surface. The depth from the pivoting point with the round edge tool is larger than that with the sharp edge tool. All of the burrs in this study are breakout (negative burrs). As feed increases, the burr thickness increases. The burr thickness with the rounded tool is larger than that with the sharp tool and a correlation between burr thickness and depth of the pivot point is recognized. The influence of back cutting on burr formation is examined in [129]. Large entrance burrs produced with worn tools are primarily due to different kinematic engagement rather than back cutting. Biermann [24] investigated the principle coherences between burr formation and notch wear separated into three steps. The individual process steps are illustrated in Fig. 22 during the turning of a stainless steel with austenitic–ferritic microstructure.

Kishimoto [78] studies burr formation in face milling of steel. Primary and secondary burr formation in connection with cutting conditions and tool geometry are the focus of his work. The

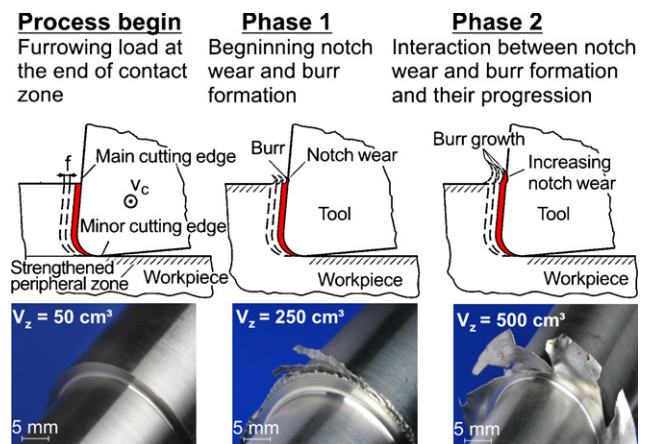

Fig. 22. Burr formation in orthogonal cutting [24].

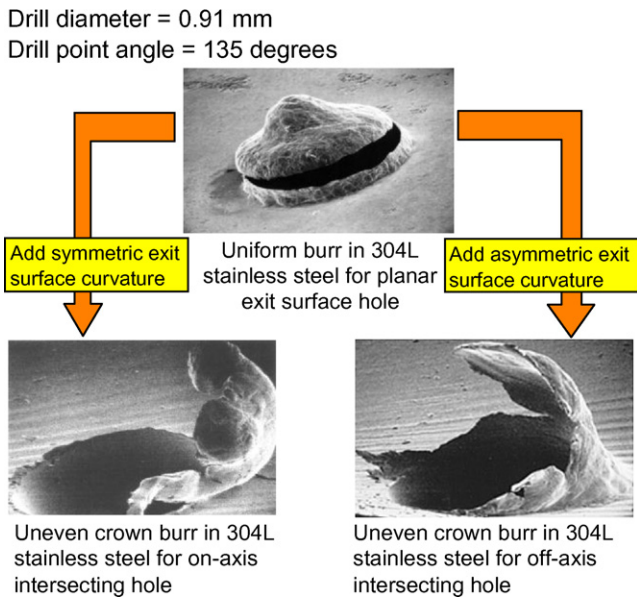

Fig. 23. Burrs from on- and off-axis intersecting holes [143].

experiments are conducted without cutting fluid. The influence of tool geometry, various workpiece materials, cutting parameters and tool path are studied in [86].

In [100] results of face milling of stainless steel using a fly milling cutter are presented. Shefelbine [138,139] investigates the influence of tool wear conditions and coolant on burr size when face milling cast iron and aluminum alloys. Different tool materials and tool wear conditions are observed in [39] when face milling grey cast iron.

In the early works of Köhler [84] the relation between tool wear and burr formation when drilling is studied applying twist drills. The influence of drill geometry and coating as well as drilling parameters on burr formation are investigated in [85]. In [74] the effects of drill type, geometry of intersection and process conditions on the drilling burr formation are examined. The burr formation in drilling intersecting holes is studied as well in [60,95], and in [143] (Fig. 23). Drill geometry and drill diameter are varied. Min [107] examines the interaction between the cutting edge of the drill and the exit surface in terms of cutting parameters, drill geometries and workpiece geometries. Heisel investigates the influence of MQL on burr formation in short hole drilling [61].

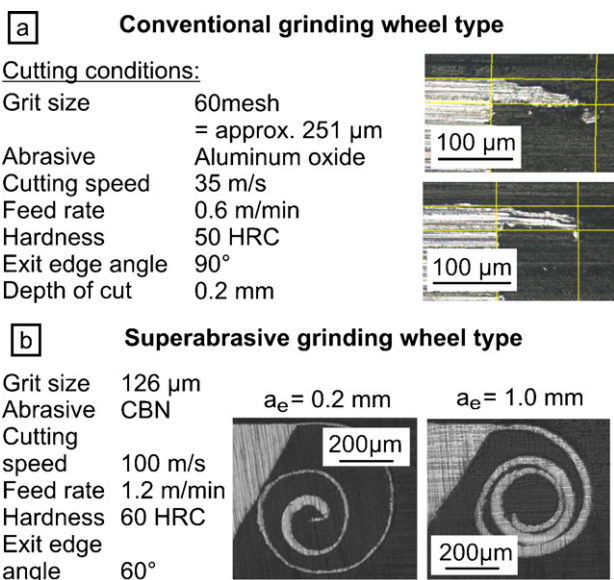

Fig. 24. Metallographic sections of spiral grinding burrs (often called a “Karpu-Burr”) [8].

Weinert [158] investigates burr formation when grinding NiTi shape memory alloys. Aurich [8] observes burr formation in flat surface grinding of tempered steel (see Fig. 24). Similar burrs are found by Denkena [40] in grinding of riblet structures.

In micromachining, burr height and breakout length increase proportionally with the depth of cut. The fracture strain of the workpiece determines at what exit angle breakout will occur instead of burr formation [32]. Burr formation in micromilling is as well investigated in [137] (Fig. 25).

4. Burr measurement

Secure detection of remaining burrs in parts is an essential goal of production engineering investigations. Furthermore, measuring of burr geometry is necessary for any research with the aim to minimize or avoid burr formation, as well as in many industrial applications. Currently, there is a large number of burr measuring and detecting methods available. The choice of an appropriate system depends on application conditions, requested measuring accuracy and burr values to be measured like burr height, burr thickness, burr volume or burr hardness, though burr height and thickness are the most frequently and easily measured burr values [98]. However, over 71% of the companies interviewed in the survey study SpanSauber still use – among other measuring methods – the fingernail test for burr detection [11]. For industrial use it is often more important to know which burr parameter is of particular relevance to assess its harmfulness under production and service conditions than to describe the burr geometry meticulously.

4.1. Classification of burr measuring methods

The large number of detection and measuring methods can be structured according to various criteria:

- one-, two- or three-dimensional,
- destructive or non-destructive,
- with or without contact [98].

Furthermore, Leopold [98] divides measuring methods in two groups: in-process and out of process (Fig. 27).

4.2. Destructive methods

To analyze a burr accurately, it is necessary to prepare a metallographic cross-section of the burr. Using metallographic cross-sections allows measuring overall burr values as defined by

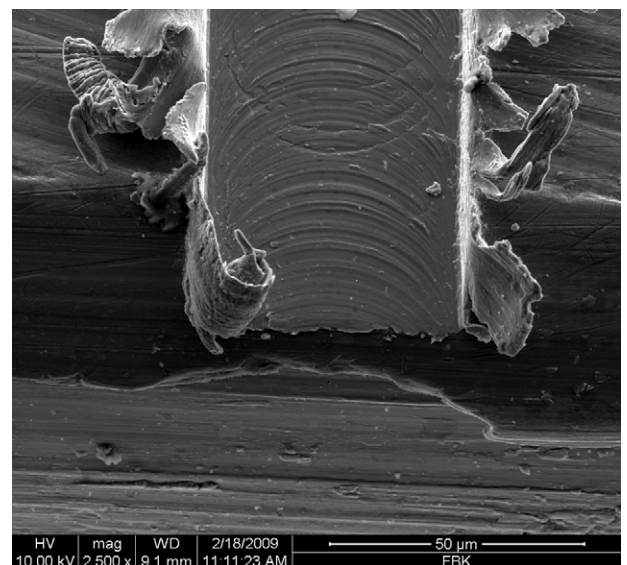

Fig. 25. Exit burr by milling of Ti-6Al-7Nb axial depth of cut 20 µm [137].

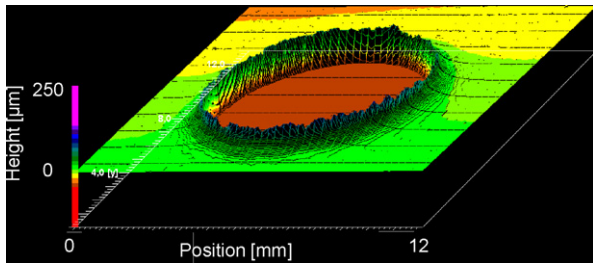

Fig. 26. 3D diagram of a burr measured with stylus method.

Schäfer [133]. In the cross-sections burr hardness and structural changes in the material which result from the cutting process can be measured as well. Furthermore, it is the only method to measure burr length and burr thickness for rolled back and spiral burrs. On the down side, the preparation of metallographic cross-sections is very time-consuming and allows only the measurement at one specific workpiece position.

4.3. Mechanical systems

Stylus methods are suitable to measure burr heights only. The real profile of the burr will be falsified because of the conical shape of the tracer point. To avoid this effect advanced calculation are necessary. Furthermore, to characterize non-uniform burrs a single measurement is not enough. The sampling of many closely spaced traces using a stylus method is very time-consuming [98]. Fig. 26 illustrates a 3D diagram of a drilling burr measured with the stylus method. However, this method gives an excellent reference to evaluate the performance of other techniques. Measurement methods with workpiece contact are always limited in their application range due to the workpiece stiffness. Burrs can be destroyed or pushed down because of the contact forces.

4.4. Optical systems

Various optical systems to detect or measure burrs are available. Camera systems, microscopes, laser and interferometer are among the most important optical systems.

Toshihiro [149] presents a basic analysis of a sensing system for deburring robots. A photo sensor which is attached to a linear pulse

motor can be reciprocated over the burr, nearly perpendicular to the longitudinal direction of the burr. Lee [88] describes a passive vision system using a 2D image to detect burrs. In this case, burr detection is primarily based on a burr contour-tracking method by using a burr model derived from a simple deburring force model. The system is suitable for online burr detection and control. A Laser displacement sensor is used to measure burr height in order to assist efficient robotic deburring in [140]. The burr height is measured as the distance between the edge of the burr and the desired workpiece surface location.

Tsai [150] develops a machine vision system for automatic detection of burrs and peripheral defects of casting parts. This non-contact detection result can be applied to automatic deburring systems and used for automatic inspection of peripheral breakdown. To detect burrs, Tsai compares an ideal surface geometry with the actual surface structure. The variances serve as information to detect burrs and peripheral defects. A laser triangulation system for burr detection is introduced in [10] (Fig. 28).

Ko [83] analyzes the triangulation method, conoscopic holography method and interferometric method for the measurement of microburr geometry formed while microdrilling. The characteristics of the laser sensor in the conoscopic holography method are evaluated by comparing this method with the other methods. The former method proves to be most effective in measuring the geometry of sharp burr edges. Ko develops an automatic burr measurement system to analyze burr geometry. Nakao [110] develops a system for measuring height and thickness profiles of drilling burrs using image-processing techniques automatically. A unique feature of this method is a charge-coupled device (CCD) camera, vertically mounted above the burr specimen which can capture the entire side surfaces of the drilling burr. Burr size is measured through image-processing software by calculating the number of black pixels in the captured image in [33]. This shading-area method can be employed as a simple and feasible approach for the analysis of burrs in intersecting holes, for example in valve manufacturing. Wulf [159] uses a thermographic system which ensures residual burr detection after the steel slab cutting process. High temperature thermographic cameras detect the contrasts between the slab and the burrs based on the generated temperature differences and visualize them as thermographs (false-color imagery). Toropov [147] develops a burr measurement system based on a conoscopic holography sensor to measure microburrs automatically and analyze burr geometry.

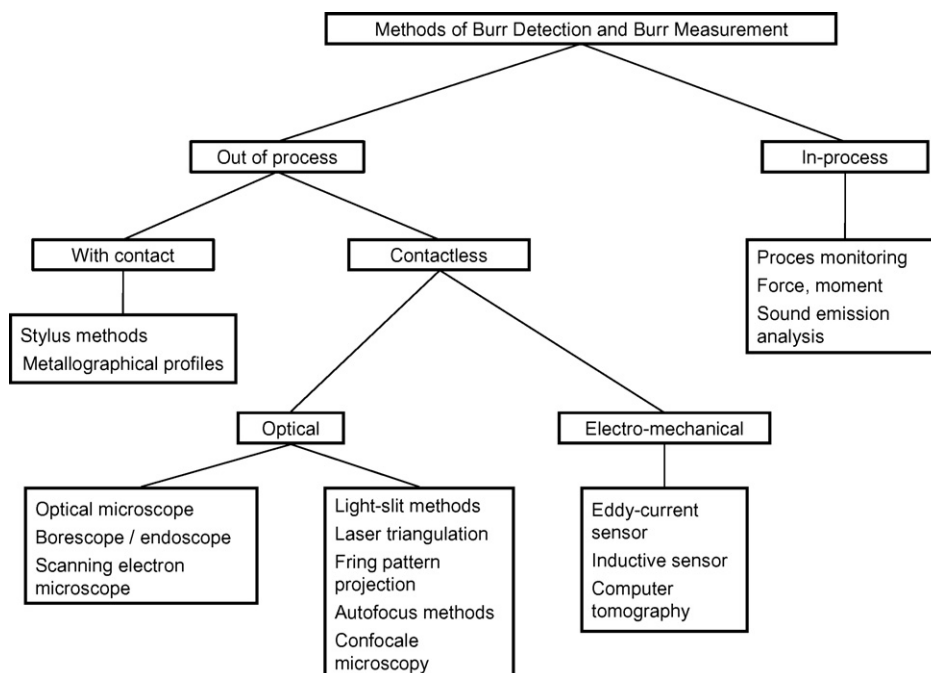

Fig. 27. Methods of burr detection and measuring [98].

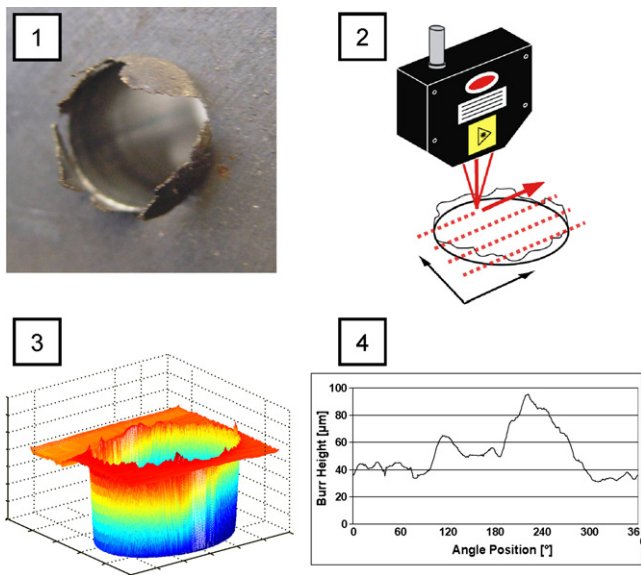

Fig. 28. Non-contact measurement of burrs with means of a laser triangulation system [10].

4.5. Electrical measuring methods

Lee [93] introduces an online burr measurement system using a capacitive sensor. A non-contact capacitance gauging sensor is attached to an ultra precision milling machine which is used as a positioning system. The setup is used to measure burr profiles along machined workpiece edges. This method is also used by [70] for quantitative burr characterization. Jagiella [69] develops an inductive sensor system for evaluation of burrs and edges of metal workpieces. This non-contact inductive burr sensor system can be used to integrate automatic burr detection within a production process. The system allows non-destructive part inspection at tough industrial conditions like residues of oil, lubricants and other contaminants.

4.6. Various other measurement systems

Kishimoto [78] applies a silicon Caoutchouc method for producing cross-section profiles of burrs which are measured by a universal projector. The width of the burr foot is considered to be in a direct context with the plastic deformation zone immediately before the tool cutting edge exits. Beier [20] measures the drilling force components at the tool exit into a transversal hole to gain information about burrs. Measuring the machining forces gives information about burr formation. Lee [91] implements an acoustic emission (AE) system, which is developed as a feedback sensing technique in a precision laser deburring process. AE signals are sampled during laser machining/deburring under various experimental conditions and analyzed using several signal processing methods including AE rms and spectral analysis. Benati [22] presents a hand-held burr measurement system. This measuring method is based on a cantilever beam sensing burr height.

4.7. Comparison of measuring methods

In [83], Ko applies and analyzes several measurement methods for microburrs with a burr height less than 10 μm . He uses a form coder and a surface roughness tester as methods with surface contact. As non-contact method, the laser confocal method and SEM are used. The laser confocal method can be successfully used for the measurement of microburrs. However, the measurement by contact method shows reduced burr heights compared to that by the laser method due to burr deformation during measurement. The different measurement methods can be categorized according to their application area (Fig. 29). A round robin on burr

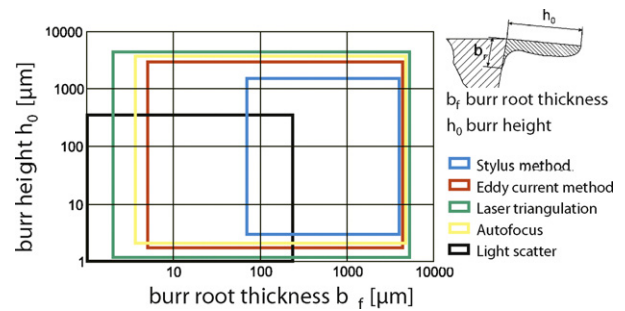

Fig. 29. Categorization of measuring methods according to application area.

measurement systems has been conducted within the CIRP working group on burrs. The results of burr measurements applying different systems are compared by Franke in [44].

5. Deburring

Deburring includes all operations which are used to remove burrs starting from simple hand deburring up to elaborated surface finishing by NC controlled robots. Gillespie [50] proposes the following four main categories in order to group the numerous deburring operations. According to [50] the numerous deburring operations can be grouped into the following four main categories:

- mechanical deburring operations,
- thermal deburring operations,
- chemical deburring operations,
- electrical deburring operations.

Unfortunately, no single deburring operation can accomplish all required edge conditions on every edge for every burr without side effects [50]. Most of the deburring processes and tools are developed for specific workpiece geometries and cannot be used for a wide range of workpiece geometries and materials.

5.1. Selection of deburring process

A first approach for selection of deburring processes was proposed by Schäfer [133]. Thereby, a decision strategy based on decision charts is developed. Ioi [68] implements a software tool for deburring method selection. For this purpose, data relevant for deburring such as workpiece material, machining method before deburring, shape of burrs, weight and volume of workpieces, surface roughness, important positions for deburring, burr classification and the objectives of deburring are considered. The output data includes a list of possible deburring methods sorted according to process costs and deburring conditions. Przyklenk [123] compares processes for burr removal in intersecting holes. A consolidated view indicates that deburring of intersecting holes with diameters less than 2 mm is possible by using ECM, abrasive flow machining (AFM) or high pressure water jet. In [124] he describes available deburring operations for burr removal in aluminum workpieces. In [112] main factors influencing deburring complexity are identified to be burr location, length of edges to be deburred, number of edges to be deburred and burr size. A destructive solid geometry (DSG) approach is used to investigate the potential for burr formation on edges of the part. Difficult to deburr features are defined in terms of an attributed adjacency graph (AAG). The effect of the choice and sequence of machining volumes on the number of edges on which burrs are formed is also demonstrated. Gillespie describes in his handbook in detail approximately 100 mechanical, thermal, chemical, electrical, and manual deburring processes. Like machining processes, deburring and edge finishing processes can be improved by parameter variation. A crucial factor in selecting a deburring process is knowledge on how the deburring process itself affects

dimensions, finish, cleanliness, flatness, plating, soldering, welding, residual stress, surface imperfections, corrosion rates, luster and color [50]. Thilow [146] introduces an industrial applicable system for the selection of deburring processes.

5.2. Mechanical deburring

In mechanical deburring operations the burrs are reduced or removed by mechanical abrasion.

The influence of burr thickness and length on vibratory deburring time is analyzed in [45]. Dimensional and weight changes are recorded as are surface finish and edge radii. Quantitative approaches for defining the deburring capabilities of this process are suggested. Borchers [26] investigates various methods of deburring cylinders used for making chain saws. Problems relating to the removal of sharp burrs and the formation of specified radii are solved. This needed to be accomplished within a minimum change in cylinder geometry. The abrasive flow deburring system proves to be the best suited solution. Blotter [25] studies the major variables in the Centrifugal Barrel Finishing process which are volume ratio of abrasive to workpiece, volume of the mixture in the tub, water level, and compound concentration. Aoki [4] develops a deburring method using a vibratory conveyer. This is based on the idea that the product on the conveying trough can be ground by abrasive paper previously attached on the surface through the conveying operation. The finishing process of dry blasting and its application for automatic deburring is examined in [102]. Several common methods of finishing are compared to the dry blast process. It is explained how the dry blast process works, the varying effect of different types of blast media on a burr are revealed, available machine concepts are listed and an explanation how several finishing needs can be combined with dry blasting to further streamline production processes is given. Spencer [142] reports that the barrel tumbling process is suitable for finishing resin components produced by stereolithography with improvements in surface roughness values of 70–80% although the process time is relatively long.

Anzai [3] introduces an approach to deburr milled surfaces using a rotating tool. An inductor producing a co-current magnetic field is adapted to the milling spindle. A ferromagnetic abrasive reduces the burrs. Chen [28] presents a dynamic model for removal of edge burrs with a compliant brushing tool. Special consideration is given to examining the dynamic force response and material removal characteristics for filamentary brush/workpiece interaction during orthogonal machining of the edge burr. Based upon the dynamic model for material removal, a control strategy for automatic deburring is presented for burr configurations having constant height as well as variable height. Results are reported which identify important relationships among brush feed rate, brush penetration depth and brush rotational speed. Lee [94] investigates ultrasonic deburring. When ultrasonic vibration propagates in a liquid medium, a large number of bubbles are formed. These bubbles generate an extremely strong force, which in turn removes burrs. Lee analyzes the effects of ultrasonic cavitation and the difference between ductile and brittle materials in the deburring process. The experimental parameters to verify the deburring effects of ultrasonic cavitations are distance of the transducer from the workpiece and ultrasonic power.

Several investigations on deburring of cross-drilled holes have been conducted as deburring is a challenge in this case. Kim [77] develops a drill capable of deburring. This tool incorporates a deburring cutter which is mounted on a cantilever located within a cavity in the shank of the drill.

Systems for the deburring of workpieces with inner edges often have cutting edges supported by springs or spring-like components. Beier [21] develops a deburring tool system. The forces at the cutting edges are controlled by the pressure of a liquid or gaseous medium – in most cases the cooling media – instead of spring forces. Thus, rotation speed and feed can be increased considerably, and high-speed deburring (HSD) is possible. Avila [12] describes a mechanized

cutting deburring tool which was designed to selectively create a chamfer on the edge of cross-drilled hole intersections, and removes the burrs from therein, while causing virtually no damage to the surfaces of the hole. For deburring operations after drilling several tools are available like the deburring fork [109] or a deburring tool with cutting blade [62].

5.3. Chemical/thermal deburring

Merritt [104] and Schein [135] study the application of electromechanical deburring operation processes. In further work Schein [136] enhances advantages of electrochemical deburring (ECD) by employing a system of automatic loading and unloading parts to be deburred. Risko [131] studies the factors that influence the process including the electrochemical properties of both the workpiece material and electrolyte along with aspects such as component geometry, process parameters, tooling and machine characteristics.

The purpose of the research of Lee [92] is to develop an effective way of automated deburring of precision components. A high power laser is proposed as a deburring tool for complex workpiece edges and burrs. Experimental results for carbon steel and stainless steel are obtained.

5.4. General cleaning technologies

Warnecke [157] investigates the basic principles and the limitations of the use of high pressure water jet machining. The interdependencies between burr values, process parameters and the effect of nozzle arrangement are studied. Alwerfalli [2] presents a mathematical model developed for the abrasive jet deburring process. Developed by utilizing the incomplete block design technique, the model provides the relationship between the burr removal rate and seven input variables, including pneumatic, cutting, abrasive, and material variables.

Haller [53] develops a high pressure water jet deburring machine. The positions of the water jet nozzles are numerically controlled. This enables deburring of complex workpieces.

5.5. Deburring using industrial robots

Manual deburring is a tedious and exhausting operation. To reduce the work load and to guarantee a constant workpiece quality robots are applied. Abele [1] studies the application of

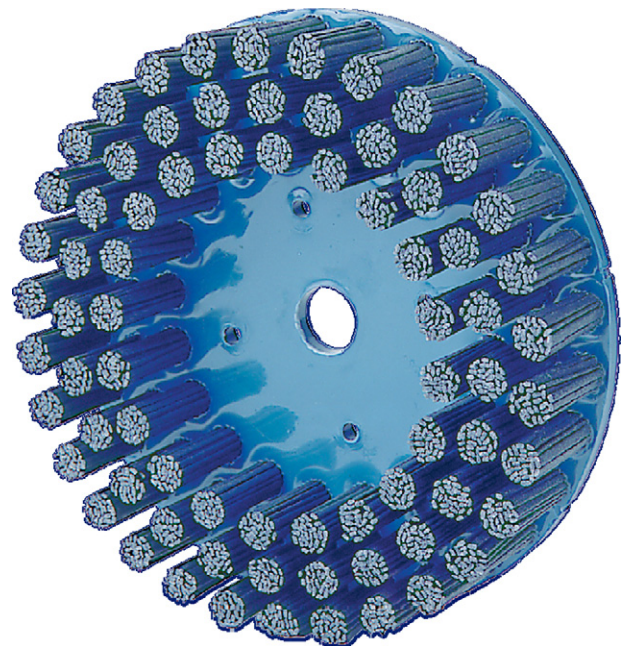

Fig. 30. Deburring brush.

robots for deburring operations. Means [103] gives an overview on all deburring tools applicable in combination with a robot such as cutters and brushes (Fig. 30).

Hickman [63] presents a system including an end effector, incorporating programmable force and damping, which is coupled to a microprocessor-controlled, single axis manipulator. The bandwidth of the system is set so that the end effector ignores burrs while reacting to changes in part contour. Force control is used to ensure constant burr removal regardless of inaccuracies in fixturing or part size. In addition, strategies for deburring of various types of part features are presented. Hirabayashi [64] presents deburring robots equipped with force sensors, which feature two innovations. Firstly, a highly rigid robot structure adopts the Cartesian coordinate mechanism which from the viewpoint of cutting, is suitable for deburring using a grinder with a high torque. Secondly, a force control method, Virtual Compliance Control, can specify spring constants and dashpot constants of robots using software parameters. This method is useful for following and adjusting the different heights of burrs. Automatic deburring of elevator guide rails was achieved by utilizing these robots. In [132] an adaptive control system is proposed as well. Asokan [7] investigates the interaction impedance using an electro hydraulic servo system for robotic deburring. Simulation results as well as experimental results demonstrate that due to a lack of applied control, contact forces (measured by strain-gauge type of force sensor) increased when the cutter encounters the burr and the manipulator moves with the commanded velocity. Activating an impedance control loop it is observed that contact forces remain almost constant at the set value and the velocity at which the cutter moves is reduced.

Lee [89] studies the application of robots for deburring processes as well. The hybrid position/force control law, the impedance control law, and the method of adaptive control are integrated to develop an AHIC (Adaptive Hybrid Impedance Control law) in order to reduce the unmodeled uncertainty, highly nonlinear and time-varying coupled characteristics of a robot system, the incomplete compensation of the nonlinear terms of the system dynamics, and variations of the control parameters and the environment during machining. Asakawa [6] studies automatic chamfering of a hole on a free-curved surface on the basis of CAD data, using an industrial robot. Olivera [116] proposes a framework for the implementation of robotic deburring solutions based on typical industrial situations. Different deburring techniques are applied with robots with different levels of complexity for each deburring case. A path or feed control system based on the FAP parameter can be implemented with success, when needed, with low cost.

6. Burr control strategies

An understanding of the fundamentals of burr formation leads us to procedures for preventing or, at least, minimizing, burr formation. This depends on analytical models of burr formation, studies of tool/workpiece interaction for understanding the creation of burrs and, specially, the material influence, data bases describing cutting conditions for optimal edge quality, and design rules for burr prevention as well as standard terminology for describing edge features and burrs. Ultimately, engineering software tools must be available so that design and manufacturing engineers can use this knowledge interactively in their tasks to yield a mechanical part the design and production of which is optimized for burr prevention along with the other critical specifications.

Efforts to avoid, prevent, and minimize burr formation have been made for machining with respect to:

- *Tool and tooling*: tool geometry alteration, proper tool material selection corresponding to the work material, coating technology, tool size.
- *Coolant*: application method, coolant media, application location.

- *Process parameters*: proper combination of cutting speed, feed, etc.
- *Work material*: replace work material for less burr or preferable burr type.
- *Work geometry*: design change (e.g. chamfer).
- *Process sequencing*: order of processes.
- Tool path planning.

In particular, tool path planning in milling with the proper selection of most of the above mentioned elements has been very successful to prevent or minimize burr formation. This section illustrates various strategies to deal with milling and drilling burr problems and burr minimization. Many of these strategies are applicable to other machining created burrs if properly modified. If these strategies are implemented they should avoid any reduction of productivity or quality, or increase of cost.

6.1. Burr prediction

The need for a prediction system arises from the fact that information regarding precise location and size of burrs is necessary for product designers in order to modify the design to avoid burrs at the machining stage. The prediction system can also serve as a process planning tool to help process engineers select an optimal process configuration set to achieve precise edges without the deburring step [15]. Different process plans can be compared in terms of burr sizes, locations, shapes and profile. The burr profile information can further be used in deburring planning. Burr size and its location lead to deburring process selection, while burr size violation can warn deburring planners of problematic areas where drastic change in cross-sectional area will take place [57].

Sokolowski [141] uses neural networks and fuzzy logic for burr prediction in face milling based on a large data base of experimental measurements. The generalization ability of both techniques allows a reduction of the data set necessary to build a relationship between exit angle, cutting parameters and burr height.

Park [120] develops a burr control chart that combines experimental data and a probability model to predict the burr type. This analytical model incorporates feed per tooth, depth of cut, in-plane exit angle and its gradient into the prediction of burr type. The burr control chart proposed contains a 2D space constructed by the undeformed chip ratio $C_{r,u}$ and undeformed chip area $C_{a,u}$. Two transition curves divide the 2D space into three regions that correspond to, respectively, a primary burr, a wavy burr and a secondary burr formation region. A typical burr control chart is shown in Fig. 31. Based on the experimental data the location of the transition curves are mathematically determined.

Chu [36] develops a burr prediction and simulation system, in which, given workpiece geometry, cutting parameters, and tool path, the system first classifies the workpiece edges according to different burr formation mechanisms obtained in experimental studies. For each edge type, it computes the tool engagement conditions for inquiry to a database in which the burr type is predicted with different criteria.

The burr formation condition is closely related to the chip flow angle in cutting. Unfortunately, precise estimation of the instant chip flow angle is extremely difficult, particularly in the milling operation. However, it can be approximated to a large degree by the insert orientation with respect to the workpiece edge, which corresponds to the tool exit order sequence (or EOS) [55,56]. An important aspect of the three-dimensional effect is the exit order of the principal tool edges (major cutting edge C, minor cutting edge A and intersection of two edges B). The exit order of the tool depends on the tool geometry: a (axial rake angle), b (radial rake angle), g (lead angle), f (in-plane exit angle), and cutting conditions: d (depth of cut), w (undeformed chip thickness at tool exit: depends on feed rate), and w (spindle rotation speed).

For a fixed radial rake angle, as the in-plane exit angle increases, the exit order changes from ABC to BAC and then to BCA, in that order. The critical in-plane exit angle which causes the transition

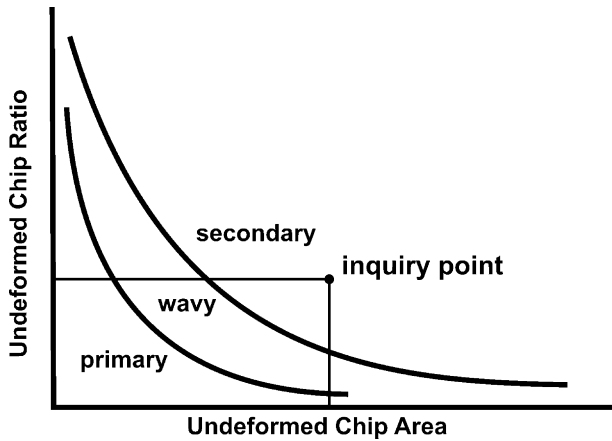

Fig. 31. Burr control chart [120].

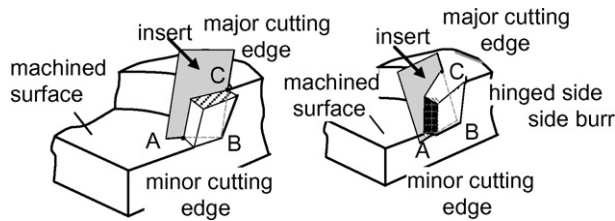

Fig. 32. Tool exit order sequence affects the burr formation condition [56].

from ABC to BAC and from BAC to BCA increases as the radial rake angle decreases (Fig. 32). The burr remains near the final exit position of the tool along the workpiece edge. Thus, if only the exit order is considered, exit order ABC results in a smaller burr on the sheared side (and larger burr on the transition surface). If the exit order of the tool edges is CBA then the exit burr on the machined surface edge is expected to be large, because the exit burr is on the hinged side.

EOS can be used very effectively to predict milling burrs. In the sequences ABC, BAC, ACB, BCA, CAB, CBA going from left to right, deformation of material tends to shift from the transitory unmachined surface to machined exit surface. In other words, there is increased burr size on the machined surface as one moves from left to right because the burr initiation stage keeps shifting away from the machined exit edge and the effect of the rollover process gets reduced. It is observed that though actual burr size varies with different material, the trend of burr size remains the same with different EOS [87].

The implementation of EOS is accomplished by tessellating the curved edges into small straight edges. With this approach the algorithm is applicable to any given part geometry and to any given tool path for that part geometry. A fully interactive graphical user interface (GUI), with a solid geometric viewer, has been implemented. A burr size database has also been developed, which quantifies and displays the burr size based on the EOS [15].

Apart from these theories, numerous burr expert systems have been developed which are based on the experimental studies and are basically database prediction systems. These studies generally involve conducting comprehensive experiments by varying various parameters involved and then finding burr formation patterns based on the results, to construct the burr expert systems. These prediction systems have been useful in some instances, especially if the study involved varying only a few parameters as in the case of drilling. However, for face milling, to fill a database for all the parameters involved is a task of astronomical size, which is very time-consuming and costly [15].

6.2. Tool path planning

Tool engagement, to a large extent, determines machining burr formation. Therefore, burr minimization can be achieved by

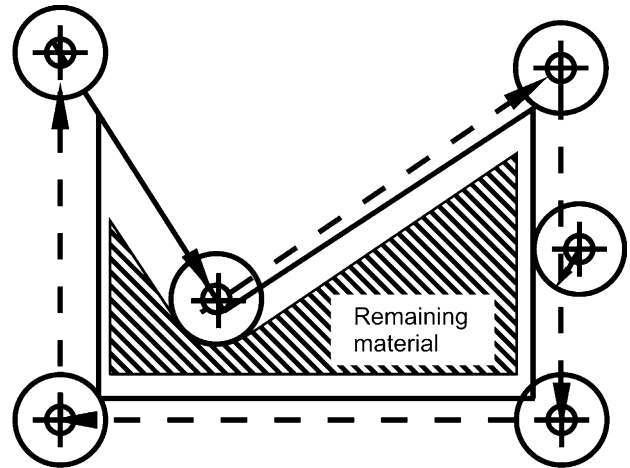

Fig. 33. Window framing [57].

controlling tool engagement conditions following some of the ideas presented above. Three main factors affecting how a tool cutting edge leaves the workpiece are: workpiece geometry, tool geometry and tool path. Usually the workpiece design and tool geometry are fixed, so only the tool path can be used for reducing burr formation by avoiding tool exits or limiting the in-plane exit angle below a predetermined threshold.

6.2.1. Window framing approach

The first geometric scheme developed for burr minimization was based on a representation in a CAD framework to parameterize the edges of a 2D polygonal contour into primary and secondary burr zones [113]. The algorithm adjusts the workpiece orientation to minimize the primary burrs along the edges of the part, using a variety of objective functions reflective of deburring complexity, such as the primary burr length or the number of edges on which the burr is formed. The primary burr is assumed to be formed when for a given depth of cut the exit angle is greater than a threshold value (here the exit angle is the supplement of the definition given earlier). The exit angle is computed as a function of cutter radius, the angle of approach of the cutter, cutter centre position and the part edge geometry. This approach assumes that only exit burrs are primary. It considers only those parts which are smaller than tool diameter.

Window framing or contour parallel milling (Fig. 33) which avoids exit burr formation, is suggested as a solution to burr minimization [57]. This scheme is not generally preferred as it causes deterioration of the surface finish due to unbalanced forces on the tool, and also increases the tool path length considerably.

Chu [36] extends the applicability of Narayanswami's approach to multiple tool paths as well as work parts with curved edges and inner profiles. His algorithm discretizes curved edges, generates zigzag tool-paths and estimates the total length of primary burrs formed for each tool path based on the burr formation criteria. Exit burr minimization is achieved by selecting tool feed directions and simulation of primary burr locations.

6.2.2. Exit free tool path

Burr minimal tool path generation is a more direct approach than testing various tool paths for relative burr length. Chu [37] develops two distinct approaches for tool path planning of 2D polygons. The first approach generates exit free tool paths by offsetting the workpiece edges with appropriate width of cut. The second one locally adjusts tool positions on given tool paths, to avoid tool exits occurring around the workpiece vertices.

Exit free tool paths have been generated in a global manner by offsetting the workpiece edges by Rangarajan [128]. He develops a set of geometric algorithms that avoid tool exits in planar milling of 2D polygonal and curved contours. Tool paths are generated by offsetting the workpiece edges with appropriate widths of cut,

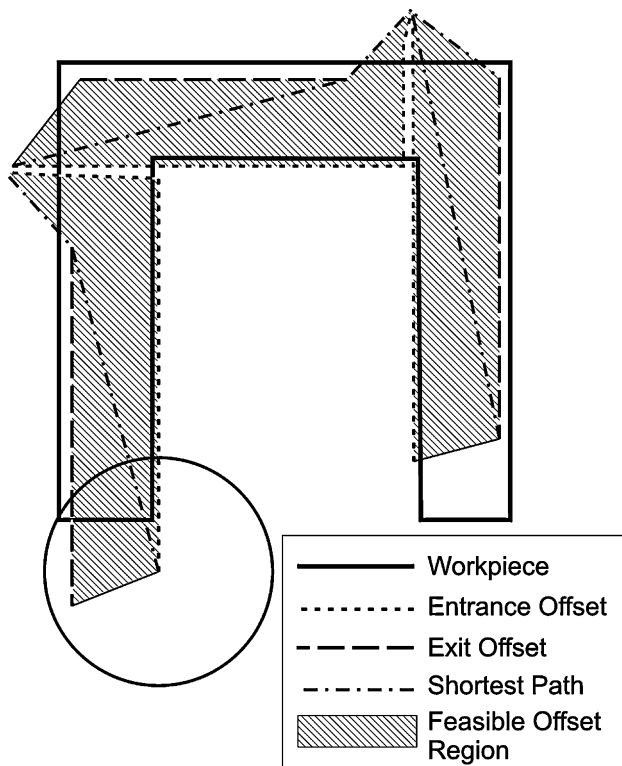

Fig. 34. Burr minimization using the feasible region approach on a sample part.

depending on the edge types (straight or circular), thus allowing the tool to always enter the part. However, the total machining time is increased, since a conventional zigzag tool path has to be applied to remove the remaining material.

6.2.3. Feature priority

Not all edges of a part are critical with respect to burr problems. Utilizing this fact, Rangarajan [127] develops a practical tool path planning scheme for exit burr minimization, based on assigning priorities to various features that require sharp edges. A detailed algorithm was developed to identify and eliminate burr formation in the most critical edges of the given part.

6.2.4. Feasible region approach

All the above geometric approaches for burr minimization tend to increase the tool path length and thus the machining time significantly. From a feasible set of burr minimal tool paths the shortest path can be chosen using a modified convex hull [126].

Due to the tight cycle time constraints, large milling cutters are sometimes used to complete the milling operation in a single pass. As this class of single pass operations offers very little maneuverability, completely avoiding exits is not possible. Ramachandran [125] implements a tool path planning scheme developed by Rangarajan [126] to handle this case.

Fig. 34 shows a sample part, the tool and the tool path generated using the feasible region algorithm. The approach uses offset calculations [128], local adjustments around corners [37] and shortest path generation through the feasible region [126].

The 'feasible region' approach attempts to avoid primary burrs on all workpiece edges (based on the exit/entrance angle burr formation criteria), thus leading to significant increase in tool path length in many cases. Many of the tool paths thus generated exceed the cycle time required, and hence cannot be used in the production line.

The feasible region approach works fine for thin parts machinable in a single pass, like those shown in Fig. 35. It cannot handle parts which are defined by multiple loops. It assumes that there are no internal loops in the part and if there are it ignores them as small pockets.

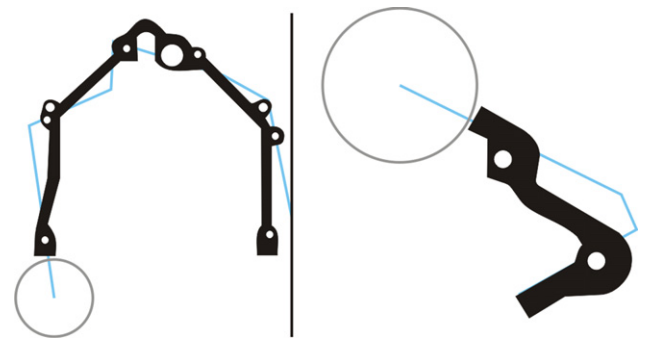

Fig. 35. Thin parts suitable for machining with a single pass.

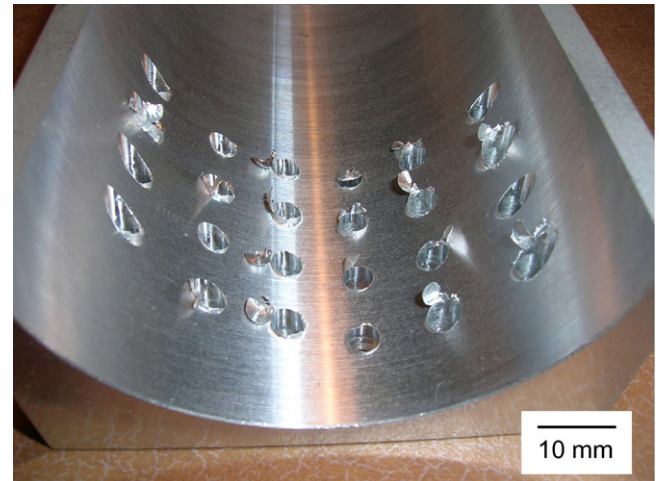

Fig. 36. Various drilling burr shapes on a curved exit surface.

6.2.5. Continuity in tool paths

Machining time depends not only on the tool path length but also on the continuity of the tool path. As the burr minimal tool path is more discontinuous the increase in cycle time is large than the proportional increase in the tool path length. The tool paths that are generated for burr minimization tend to have a lot of small tool path segments. These segments cause a significant feed loss as the tool needs to come to a halt before it can start machining again. To prevent the tool from stopping at the corners of tool path segments, continuous arcs joining the two segments can be used. Also, arcs can be used to combine few segments of tool paths into one thus reducing the total number of segments.

6.3. Drilling burr minimization

Burr formation in drilling is primarily dependent upon the tool geometry and tool/work orientation (that is, whether the hole axis is orthogonal or not to the plane of the exit surface of the hole), Fig. 36. Since the exit angle of the drill varies around the circumference of the hole intersection, the potential for burr formation will vary. This means that the intersection geometry as well as tool geometries optimized to minimize adverse burr formation conditions can be effective in minimizing burr formation. Burr formation in intersecting holes shows a high dependence on angular position under the same cutting conditions. Large exit angles yield small burrs. There is also a strong dependence on exit surface angle (that is the degree of inclination of the intersecting hole from perpendicular) [107]. Research shows that an exit surface angle of 45° reduces burr formation [120].

Further, holes in multilayer materials offer additional challenges. This is especially true in aerospace applications where structures are often composed of sandwich configurations of metal, composite and sealant. Burr formation here is challenging as

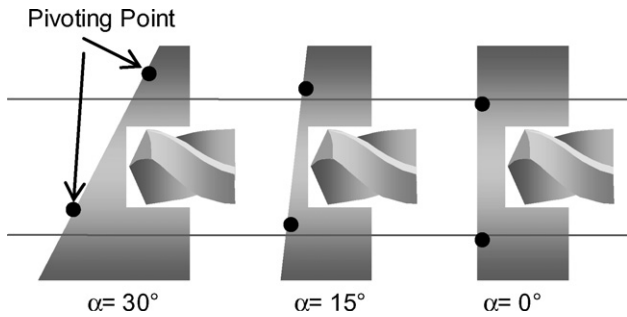

Fig. 37. Variation of the pivoting point [107].

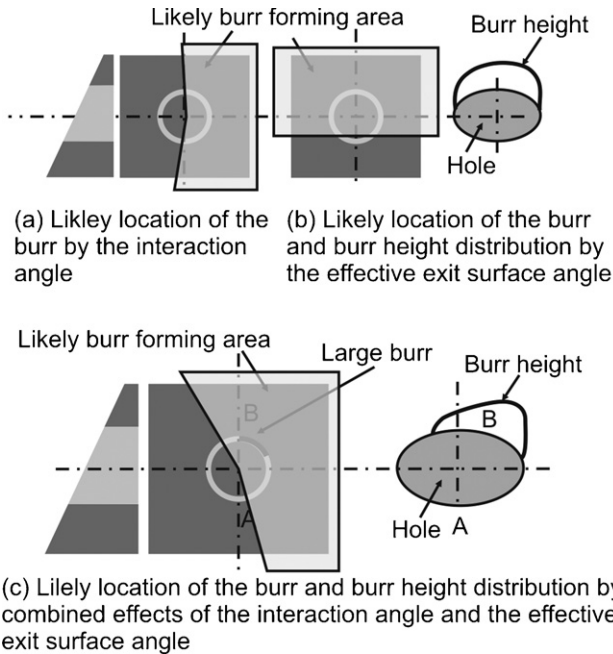

Fig. 38. Likely burr forming area [107].

interlayer burrs often need to be removed before final assembly. Finite element analysis of these types of specific situations often offers increased understanding of the problems. When drilling multilayer material structures, the fixturing often plays an important role in determining the size and location of burrs. The gap provides space for burr formation at the interface of the two material sheets [35].

6.3.1. Degree of plastic deformation

Park [120] investigates the influence of the exit surface angle and found that burr formation decreases as the exit surface angle increases. The pivoting point that initiates plastic bending leading to large burr formation appears very close to the machined surface when the exit surface angle is 30° . As the exit surface angle decreases, the pivoting point moves farther from the machined workpiece and causes a larger burr.

The same theory can be applied to the cross-sectional diagram of drilling on an angled exit surface at any moment. In the bottom part of the workpiece where the exit surface angle is 30° in Fig. 37, the pivoting point appears very close to the machined surface, which results in no burr or a very small burr. As the exit surface angle decreases, the pivoting point moves farther from the machined surface. This can be explained by changes in the stiffness of the workpiece material. As the cutting edge approaches the exit surface, material is being cut until the pivoting point appears at the exit surface. Once the pivoting point appears, transition from cutting to bending occurs. When the exit surface angle is large, the bottom part of the workpiece is stiffer than that

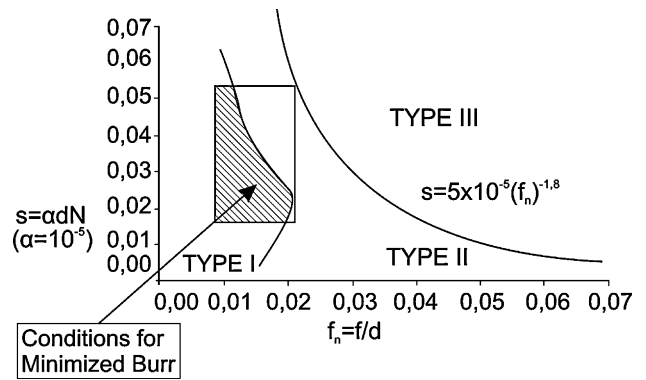

Fig. 39. Drilling burr control chart for 304L stainless steel material showing normalized speed, s (vertical axis) vs. normalized feed, f (horizontal axis), d is drill diameter. Minimized burr conditions indicated [108].

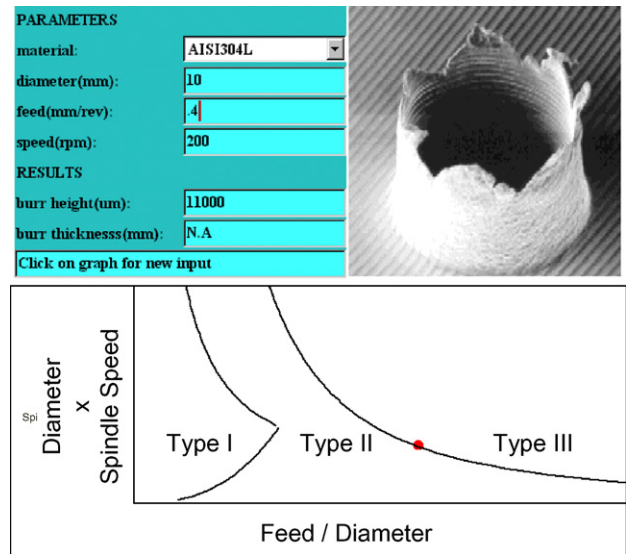

Fig. 40. Web-based drilling burr control chart/burr expert for predicting likely burr formation [105].

of smaller exit surface angle. Hence, thicker a workpiece sustains the thrust force and delays formation of the pivoting point and thus transition to bending. The upper part of the workpiece contains thinner material that enables early formation of the pivoting point far from the machined surface and early transition to bending from cutting.

6.3.2. Likely burr forming area (burr prediction)

The interaction angle defines where the burr may form but the angle does not consider deformation of the exit surface. Considering both, the likely burr forming area is almost the entire right half of the hole with a slight shift by feed and the exit surface angle (Fig. 38a). The effective exit surface angle describes the degree of plastic deformation and, thus, burr size distribution (Fig. 38b). By combining these two factors, the likely burr forming area can be represented as in Fig. 38c.

Using this idea, it may be possible to alter the feed motion of the drill to reduce the likely burr formation region [151].

6.3.3. Burr control chart and expert system

Burr minimization and prevention in drilling is strongly related to process conditions (feed rate and speed, for example) and drill geometry. It is possible to represent the reasonable ranges of operating conditions for drilling and burr formation potential by use of a "burr control chart" derived from experimental data on burr formation for varying speeds and feeds. This is similar to that seen in Fig. 36 but based on a data fit. This can be normalized to cover a range of drill diameters and, importantly, can be used across similar

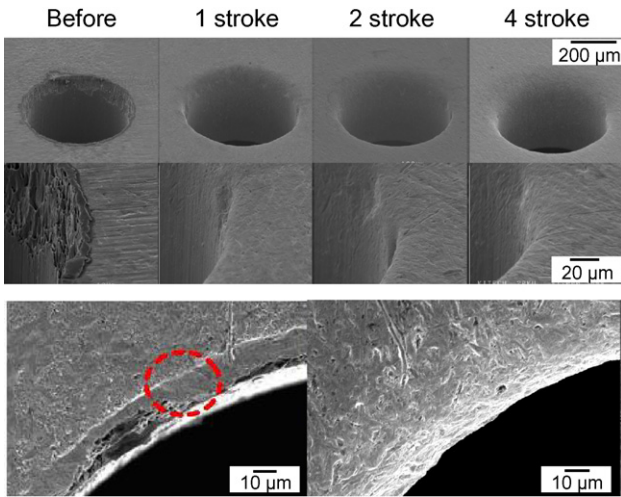

Fig. 41. Results of deburring of microburrs using an electric inductor (Source: Ko, WG on Burrs [83]).

materials (carbon steels, for example). Data shows the likelihood of creating one of three standard burrs, namely, small uniform (type I), large uniform (type II) and crown burr (type III) [76,75]. Fig. 39 below shows a typical burr control chart for 304L stainless steel. Continuous lines delineate different burr types. Type I is smallest and preferred. Burr height scales with distance from the origin. This burr control chart can be integrated with an expert system allowing queries of likelihood of burr formation to be shown on the control chart when information on drill diameter, speed, feed, etc., are input, red dot (For interpretation of the references to colour in the text, the reader is referred to the web version of the article.) in Fig. 40. Typical burr sizes expected are shown.

6.4. Integrated process planning and burr minimization

It is not sufficient to simply try to adjust process parameters for burr minimization or prevention alone. One should also consider other important constraints in machining, e.g. surface finish and dimensional tolerances. Process considerations for insuring optimum performance in face milling start from the so-called macroplanning at a higher level to detailed microplanning selecting machining conditions. The constraints include cycle time, flatness and surface roughness, burr height, surface integrity, etc. [130]. This enhanced process planning can be integrated with the basic design process to ensure compliance with design criteria and manufacturing process optimization.

7. Case studies

Several case studies from different manufacturing sectors were presented as technical contributions during the meetings of the CIRP working group on burrs. A number of these case studies provide an excellent insight into the relevance of burr issues for industrial practice. Therefore, they are included in this paper.

7.1. Microburrs

Ko [83] investigates deburring of microburrs using an electric inductor (Fig. 41). The electric inductor creates a magnetic field. Within this field ferromagnetic powders are used as an abrasive for deburring. The example presented here is a part of an electron gun (Fig. 42). Several variations of the deburring conditions were carried out. Ko investigates two different powder volumes, two different values for rotational speed and the influence of coolant.

7.2. Aerospace

In the aerospace industry, riveting and bolting are very common joining operations. Therefore, drilling is one of the predominant

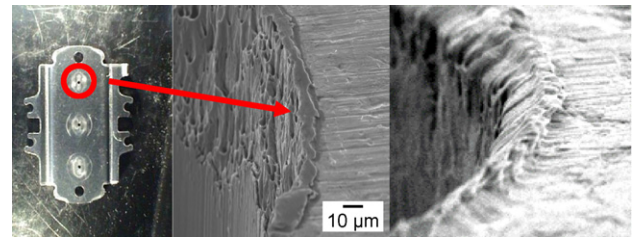

Fig. 42. Microburrs electron gun [83].

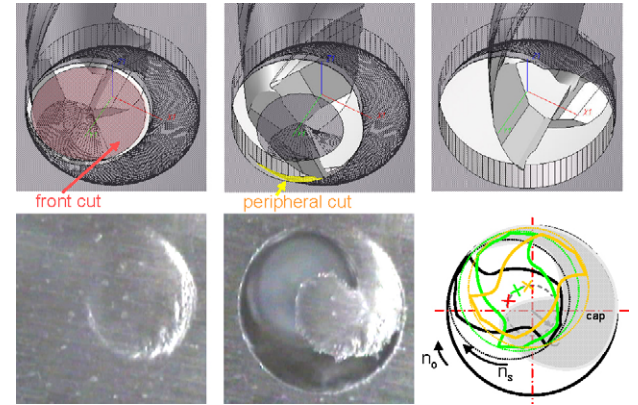

Fig. 43. Burr cap formation at tool exit (orbital drilling) [27].

machining operations. To reduce weight, light weight materials are widely applied in airplanes. This includes mainly aluminum and titanium alloys and fiber reinforced plastics (FRP). Fig. 43 illustrates investigations of Brinksmeier [27] on orbital drilling of aluminum alloys. Burr formation is reduced applying orbital instead of conventional drilling.

Additionally, sandwich structures out of titanium and carbon fiber reinforced plastic stacks are becoming more and more common. Burr formation is a very important issue when machining FRP or sandwich material as it influences the sandwich structure and burrs form very irregularly. This increases the difficulty in removing them. Particularly in aerospace industries burrs and caps are not tolerated. Workpieces have to be free of any edge defects. Fig. 44 illustrates the dimension of edge defects when drilling carbon fiber reinforced laminates [152]. Edge defects occurring when machining FRPs include delamination as well as burr formation. Research is also done in the field of automotive FRPs. Fig. 45 illustrates burr and cap formation when drilling glass mat reinforced thermoplastics.

Vijayaraghavan [153] investigates the challenges in modeling machining of multilayer materials, looking at metal–metal and metal–composite stackups. Fig. 46 shows developmental work for a current jet liner on interlayer burr formation. Burrs in critical

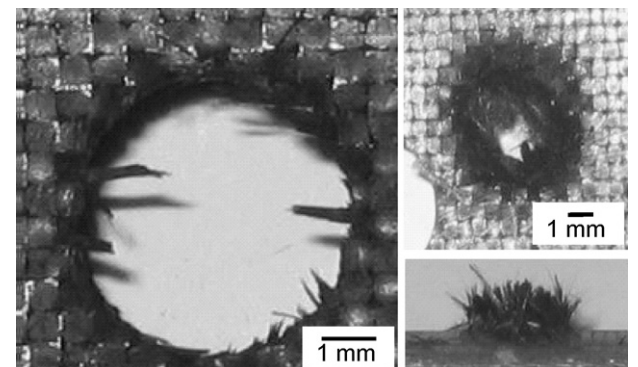

Fig. 44. Burr formation when drilling carbon fiber reinforced laminates [152].

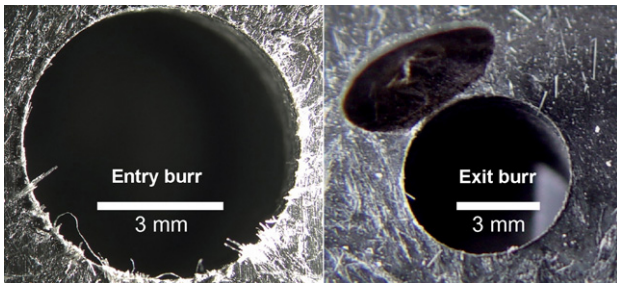

Fig. 45. Burr and cap formation drilling glass mat reinforced thermoplastic (Source: Aurich, WG on Burrs).

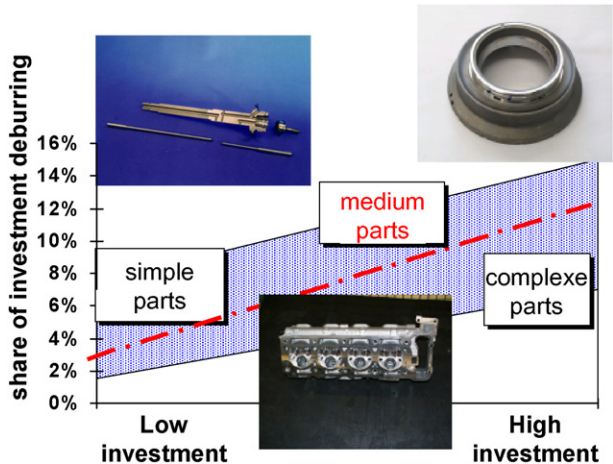
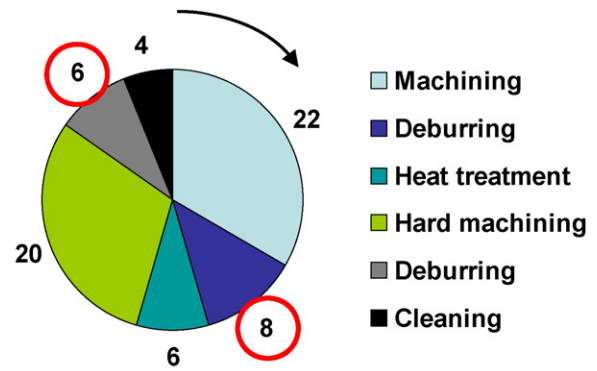

Fig. 48. Breakdown of manufacturing expenses after Bosch [65].

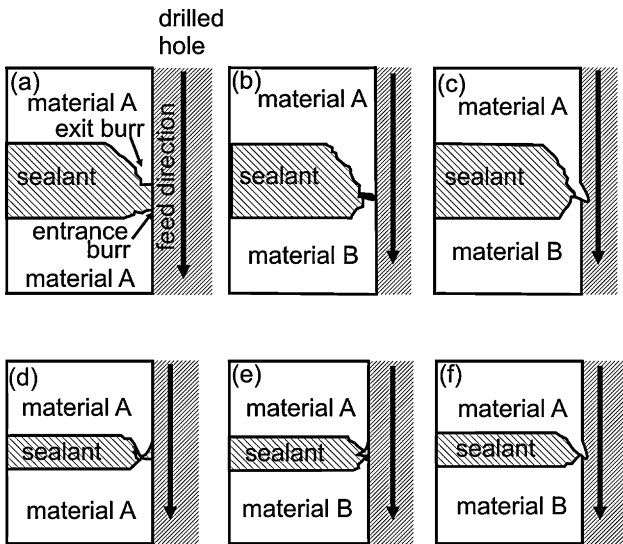

Fig. 46. Interlayer burr formation when drilling sandwich material [153].

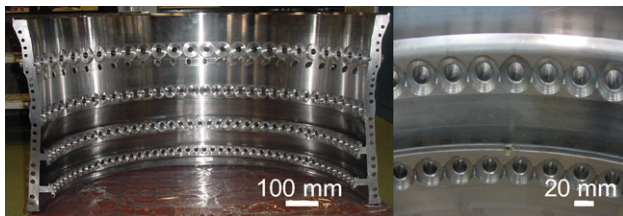

Fig. 47. Compressor casing (burrs from drilling and milling) [5].

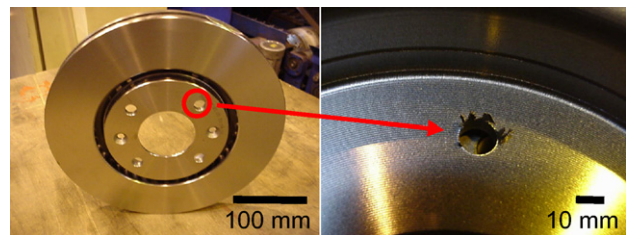

Fig. 49. Disc brakes [5].

aerospace parts (see Fig. 47) represent an important issue. These burrs can significantly affect the workpiece's life span. Associated deburring costs can represent 9–10% of the total part manufacturing cost breakdown.

7.3. Automotive suppliers

Suppliers for the automotive industry often consider deburring which is a non-value-adding operation as an unimportant or secondary operation. Precise figures on the cost of deburring are therefore not easily available. However, some numbers have been presented and published in the last years. Deburring costs in automotive manufacturing can contribute significantly to the overall manufacturing cost. The exact percentage depends to a large extent on the specific part and its manufacturing sequence. The numbers mentioned here are always related to direct manufacturing cost without material cost. Deburring costs can vary from 2% to 3% for mass production of simple parts in the automotive sector up to 9–10% for complex parts. According to information from a large German automotive supplier, in some

cases, deburring cost is as high as 14% of the manufacturing expenses (see Fig. 48). This figure can even be higher in other sectors like medical applications or precision machining.

In these industrial applications, various methods are described for deburring: manual (hand filing, sand papering, hand-stones, pneumatic or electrical motorized tools with mounted stones, cuts, abrasive filament brushes), machining, EDM, ECM. As negative effects of burrs, malfunctions, reduced part life or even small injuries of assembly workers are reported.

Fig. 49 shows burrs found at disc brakes. Drilling is the main cause of burrs in these parts. The deburring operation is carried out by countersinking and milling. The total cost is close to 2–3% compared with the total manufacturing cost [5]. In some cases high investments, as for example robots are required in order to reduce secondary machining cost and to keep part costs low.

7.4. Heavy transport and oil piping

Fig. 50 presents applications in the oil piping and heavy transport sector. In the case of the heavy transport sector and due to the complex part geometry and the rather low production volume, manual deburring is the applied method (Fig. 50b). Deburring of the flange for oil piping is carried out mainly to avoid the risk of injuries to workers that will manipulate the workpiece

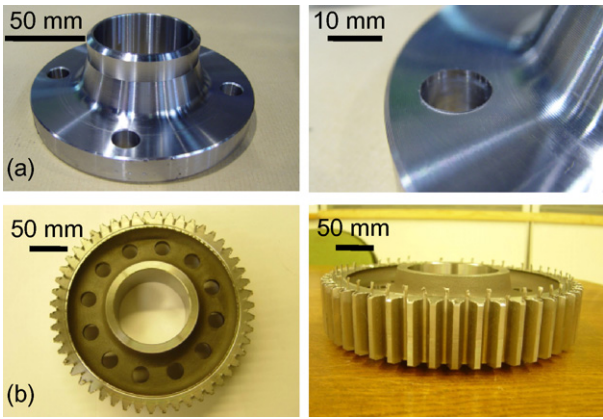

Fig. 50. (a) Flange for oil pipes; (b) Gear [5].

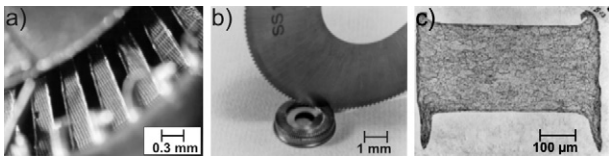

Fig. 51. (a) Shaving head, (b) sawing process, (c) burr formed (Source: Altena, H.; Philips Netherlands, 2008).

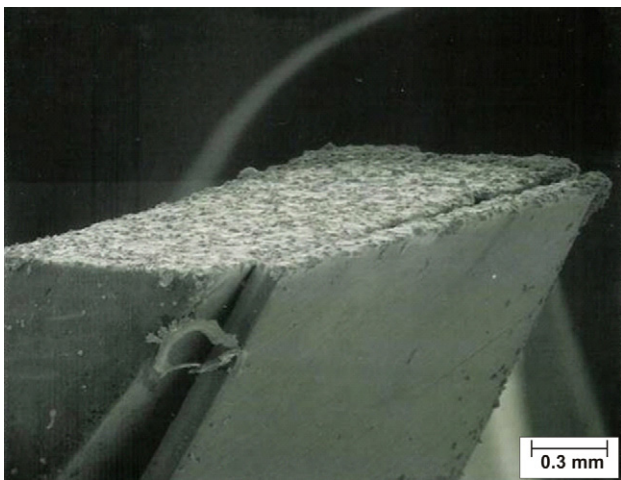

Fig. 52. Shaving head tooth produced by EDM (Source: Altena, H., Philips Netherlands, 2008).

afterwards. Burrs are produced in the drilling operation (Fig. 50a) Deburring costs can vary from 2% to 3% (oil piping) up to 7% (heavy transport).

7.5. General industry

Fig. 51 shows burr formation when producing shaving heads. The slots in the shaving heads were made by sawing and a lot of burrs were formed. Three extra processing steps were needed to get rid of the burrs. These extra steps are very costly and time-consuming. To avoid burr formation and to decrease the process forces the slots were made by wire EDM instead of sawing (Fig. 52). Only small burrs are formed due to the high production speed. To be able to further increase the product shape flexibility ECM is used as production process nowadays. This process is completely burr-free.

7.6. Automotive industry

A survey study carried out in the German automotive industry [11] revealed that burrs cause 2–8% of the direct

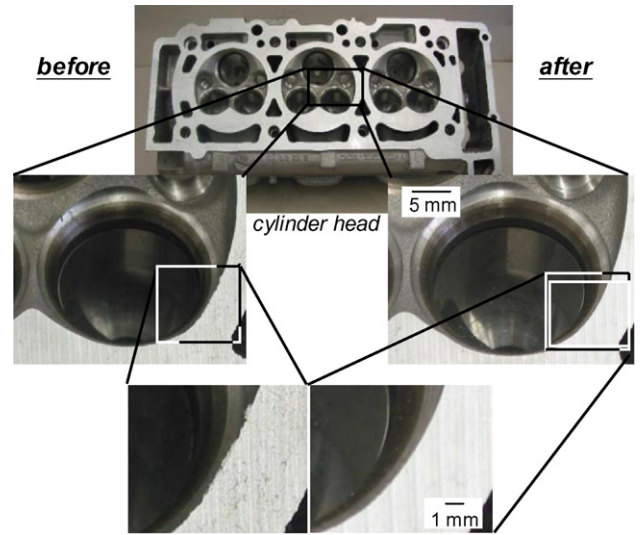

Fig. 53. High pressure water jet deburring of cylinder heads (Source: Berger, K.; WG on Burrs 2006, Kobe).

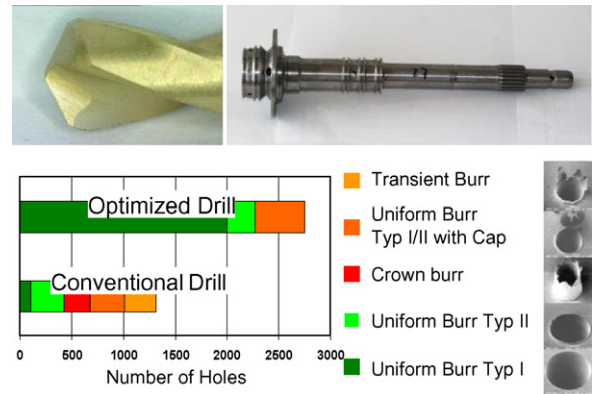

Fig. 54. Tool optimization (Source: Berger, K. Daimler AG).

manufacturing costs. Detached burrs and chips are a major cause of malfunctions in engines. Furthermore, sharp edges and burrs are reported as reasons for small injuries during product handling. This results in the necessity to apply costly and technologically demanding deburring and cleaning technologies. Cleaning and deburring of complex automotive parts was reported with a contribution between 8% and 20% of the total manufacturing costs.

Loosening of burrs during service, i.e. in a cylinder head can lead to severe damage or increased wear when particles (loose burrs) are transported into critical areas of the engine. Fig. 53 shows the result of high pressure water jet deburring of cylinder heads.

A large German automotive manufacturer reported investigations on tool optimization with respect to burr minimization and tool wear reduction (see Fig. 54).

8. Conclusions and outlook

As a result of increased demands on part quality and functional performance, edge conditions after machining have become an issue of particular importance for many industries. Even small burrs on edges cannot be allowed in many cases. This requirement leads to deburring and cleaning operations which make up for a considerable portion of manufacturing costs.

Therefore, and also evidently from the referenced papers, in the past years there has been a great deal of research activity in this field. The results of this research add considerably to the

knowledge on the mechanisms of burr formation and deburring which has been generated already in a “first wave” of burr research between 1965 and 1980. Burr formation is understood to a good extent, and recent research has concentrated more on the application of the theoretical understanding in order to improve edge quality in machining.

Current trends include support systems in computer-aided design and process planning as well as tools designed to minimize burr formation.

An important result of recent research into burrs is that burr control rather than burr avoidance is a promising approach. A controlled burr may be either acceptable due to its small size and reproducible nature or it may be a burr which can be safely deburred with a standardized automated procedure.

The future development for comprehensive and integrated strategies for burr minimization and prevention will depend on:

- the continued development of predictive models with powerful databases, including “expert data bases” for process specification,
- simulation models of burr formation capable of indicating the interaction and dependencies of key process parameters for burrs at all scales,
- strategies for burr reduction linked to computer-aided design and process planning systems (and close coordination with CAD/CAM resource suppliers),
- inspection strategies for burr detection and characterization including specialized burr sensors,
- development of specifications and standards for burr description and measurement.

Recent experience indicates that such a process optimization may also yield increases in throughput due to decreases in cycle time gained by optimum part orientation on the machine during machining [129].

Finally, it may be concluded that in the area of analysis, control and removal of burrs the research of the last decades has now created a solid base for many industrial applications. There are however, several directions for research which are promising to follow in the future. Firstly, the existing knowledge on burrs has not yet been applied to many industries and workpiece classes. This forms a promising field for applied research with quick effects on industry. Secondly, the broader issue of edge and part conditions and cleanliness is coming more and more into focus, mechatronic products, micro-products and products with very high performance demands all need to be technically clean and without edge disturbances. Development and application of the technologies necessary for clean mechanical machining have just started.

Acknowledgements

The authors sincerely thank the following persons for their valuable contributions to the preparation of this manuscript: H. Altena, T. Altan, K. Berger, D. Biermann, E. Brinksmeier, F. Fang, M. Hammer, U. Heisel, W. Hockauf, S. L. Ko, P. Koshy, E. Uhlmann, J. Webster, K. Weinert.

References

- [1] Abele E (1979) Entgraten von Werkstuecken mit Industrie-Robotern. *TÜ Technische Überwachung Düsseldorf* 20(11):413–418.
- [2] Alwerfalli DR, Taraman KS, Chadda YS (1989) *Burr Removal Rate Model for an Abrasive Jet Deburring Process*. Technical Paper. Society of Manufacturing Engineers, May 1–14. Paper-Nr. 89-441.
- [3] Anzai M, Otaki H, Kawashima E, Nakagawa T (1993) Application for Deburring of Mechanical Parts Using Magnetic Abrasive Finishing. *International Journal of the Japan Society for Precision Engineering* 27(3):223–224.
- [4] Aoki I, Lida K (1985) New Deburring Method of Blanked Products (2nd Report)—Application of Abrasive Web and Loose Abrasives. *Bulletin of the Japan Society of Precision Engineering* 19(3):175–180.
- [5] Arrazola PJ (2009) Assessment of Deburring Costs in Industrial Case Studies, in: *Proceedings of the CIRP Sponsored International Conference on Burrs: Analysis, Control & Removal*, Kaiserslautern, Germany, 245–251.
- [6] Asakawa N, Toda K, Takeuchi Y (2002) Automation of Chamfering by an Industrial Robot; for the Case of Hole on Free-Curved Surface. *Robotics and Computer-Integrated Manufacturing* 18(5–6):379–385.
- [7] Asokan T, Singaperumal M (1997) Control of Interaction Impedance Using an Electrohydraulic Servosystem: An Application to Robotic Deburring. *Journal of Materials Processing Technology* 65(1–3):172–178.
- [8] Aurich JC, Sudermann H, Bil H (2005) Characterisation of Burr Formation in Grinding and Prospects for Modelling. *CIRP Annals* 54(1):313–316.
- [9] Aurich JC, Sudermann H, Bil H (2006) 3D Finite Element Modeling of Burr Formation in Grinding. *Proceedings of the 9th CIRP International Workshop on Modeling of Machining Operations*, Bled, Slovenia, 47–50.
- [10] Aurich JC, Wiese M, Tries T, Gsänger D (2004) Gratbildung und Grattmessung beim Bohren. *WB Werkstatt und Betrieb* 137(12):44–47.
- [11] Aurich JC, SpanSauber (2006) Untersuchung zur Beherrschung der Sauberkeit von zerspanend hergestellten Bauteilen, Ergebnisworkshop, Lehrstuhl für Fertigungstechnik und Betriebsorganisation, Technische Universität Kaiserslautern.
- [12] Avila MC, Choi, J, Dornfeld DA, Kapgan M, Kosarchuk R (2004) *Deburring of Cross-Drilled Hole Intersections by Mechanized Cutting*, LMA. Annual Reports 2003–2004, UC Berkeley: 10–20.
- [13] Avila M, Dornfeld D (2004) On The Face Milling Burr Formation Mechanisms and Minimization Strategies at High Tool Engagement. *Proceedings of the 7th International Conference on Deburring and Edge Finishing*, Berkeley, 191–200.
- [14] Balduhn A (2003) *Model of a Burr Expert System LMA Reports*. University of California, Berkeley, pp. 30–35.
- [15] Bansal AK (2002) *Burr Prediction System for Face Milling Operation Masters Report*. University of California at Berkeley, CA.
- [16] Bansal A (2001) *Comprehensive approach to Burr Prediction*, LMA. Annual Reports 2001–2002, UC Berkeley: 18–24.
- [17] Barth C, Dollmeier R, Warnecke G (2001) *Burr Formation in Grinding of Hardened Steel with Conventional and Superabrasive Wheels*. Technical Papers of the North American Manufacturing Research Institution of SME, MR01-270, 1–6.
- [18] Basavarajappa S, Chandramohan G, Ashwin M, Prabu M, Mukund K (2006) Analysis of Burr Formation During Drilling of Hybrid Metal Matrix Composites Using Design of Experiments, Flexible Manufacture of Lightweight Frame Structures. *Advanced Materials Research* 10:53–64.
- [19] Beier HM (1999) *Handbuch Entgrattechnik: Wegweiser zur Gratminimierung und Grattbeseitigung für Konstruktion und Fertigung*. Hanser Verlag.
- [20] Beier HM (2001) Gratentstehung—ein umformtechnischer Ansatz, *wt Werkstattstechnik online*, 91(12):765–772.
- [21] Beier HM, Nothnagel R (2004) Development of a High-Speed-Deburring Tool. *Proceedings of the 7th International Conference on Deburring and Surface Finishing*, 271–279.
- [22] Benati F, Sacerdotti F, Kang H, Gatti S (2000) Development of a Hand-Held Burr Measurement System for Statistical Process Control of the Trimming Process. *Proceedings of the 17th IEEE*, 1420–1423.
- [23] Berger K (2004) Proposal for a Standard for the Description of Edges in Automotive Engineering. *Proceedings of the 7th International Conference on Deburring and Surface Finishing*, 67–79.
- [24] Biermann D, Heilmann M (2009) Burr Minimization Strategies in Machining Operations. *Proceedings of the CIRP sponsored International Conference on Burrs: Analysis, Control & Removal*, Kaiserslautern, Germany, 13–20.
- [25] Blotter PT, Punamia M (1982) *Metal Removal Rate by Centrifugal Barrel Finishing*. Technical Paper. Society of Manufacturing Engineers, 1–6. Paper-Nr. 82-267.
- [26] Borchers J (1980) *Why? Abrasive Flow Deburring*. Technical Paper. Society of Manufacturing Engineers, 1–21, Paper-Nr. 80-101.
- [27] Brinksmeier E, Fangmann S (2009) Burr and Cap Formation by Orbital Drilling of Aluminium. *Proceedings of the CIRP sponsored International Conference on Burrs: Analysis, Control & Removal*, Kaiserslautern, Germany, 31–45.
- [28] Chen L, Stango RJ, Cariapa V (1991) Automated Prototype Deburring with Compliant Brushing Tool. *ASME/PED* 50:147–162.
- [29] Chern GL (1993) *Analysis of Burr Formation and Breakout in Metal Cutting*, Ph.D. Thesis, University of California at Berkeley, Berkeley, CA, 1993.
- [30] Chern GL (2006) Experimental Observation and Analysis of Burr Formation Mechanism in Face Milling of Aluminium Alloys. *International Journal of Machine Tools and Manufacture* 46(12–13):1517–1525.
- [31] Chern GL (2006) Study on Mechanisms of Burr Formation and Edge Breakout Near the Exit of Orthogonal Cutting. *Journal of Materials Processing Technology* 176:152–157.
- [32] Chern GL, Dornfeld D (1996) Burr/Breakout Model Development and Experimental Verification. *Journal of Engineering Materials and Technology* 118(2): 201–207.
- [33] Chern GL, Liang JM (2007) Study on Boring and Drilling with Vibration Cutting. *International Journal of Machine Tools and Manufacture* 47(1):133–140.
- [34] Choi J, Min S, Dornfeld DA (2004) Finite Element Modeling of Burr Formation in Drilling of a Multi-Layered Material. *Proceedings of the 7th International Conference on Deburring and Surface Finishing*, Berkeley, CA, USA, 103–108.
- [35] Choi J, Min S, Dornfeld DA, Alam M, Tzong T (2003) Modeling of Inter-layer Gap Formation in Drilling of a Multi-layered Material. *Proceedings of the 6th CIRP International Workshop on Modeling of Machining Operations*, 113–118.
- [36] Chu CH, Dornfeld DA (2000) Tool path planning for avoiding exit burrs. *Journal of Manufacturing Processes* 2(2):116–123.
- [37] Chu CH, Dornfeld DA (2005) Geometric Approaches for Reducing Burr Formation in Planar Milling by Avoiding Tool Exits. *Journal of Manufacturing Processes* 7(2):182–195.

- [38] Chu C-H, Dornfeld D, Brennum C (1999) Prediction and Simulation of Milling Burr Formation for Edge-Precision Process Planning. *Proceedings of the 3rd International Conference on Integrated Design and Manufacturing in Mechanical Engineering*, 237–246.
- [39] da Silva LC, de Melo ACA, Machado AR, da Silva MB, Souza Junior AM. (2006) Application of Factorial Design for Studying the Burr Behaviour during Face Milling of Motor Engine Blocks. *Journal of Materials Processing Technology* 179(1–3):154–160.
- [40] Denkena B, de Leon L, Kästner J (2000) Burr Formation in Microstructuring Processes. *Proceedings of the CIRP sponsored International Conference on Burrs: Analysis, Control & Removal*, Kaiserslautern, Germany, 55–62.
- [41] De Souza Junior A, Sales W, Ezugwu E, Bonney J, Machado A (2003) Burr Formation in Face Milling of Cast Iron with Different Milling Cutter Systems. *Proceedings of the Institution of Mechanical Engineers Part B Journal of Engineering Manufacture* 217(11):1589–1596.
- [42] Dornfeld D, Kim J, Dechow H, Hewson J, Chen L (1999) Drilling Burr Formation in Titanium Alloy, Ti–6Al–4V. *CIRP Annals* 48(1):73–76.
- [43] Foroulis S, Wiese M, Tries T, Benardos P, Aurich JC, Vosniakos GC (2005) Burr Formation Modelling with Artificial Neural Networks. *Proceedings of the ICMEN, International Conference on Manufacturing Engineering and EUREKA Brokerage Event*, 73–81.
- [44] Franke V, Leitz L, Aurich J (2009) Burr Measurement: A Round Robin Test Comparing Different Methods. *Proceedings of the CIRP sponsored International Conference on Burrs: Analysis, Control & Removal*, Kaiserslautern, Germany, 167–178.
- [45] Gillespie LK (1975) *Quantitative Approach to Vibratory Deburring Effectiveness*, SME Technical Paper, MRR75-11.
- [46] Gillespie LK (1976) *Deburring, an Annotated Bibliography*, Volume III. Technical Paper. Society of Manufacturing Engineers, MRR76-07: 1–59.
- [47] Gillespie LK (1996) The Battle of the Burr: New Strategies and New Tricks. *Manufacturing Engineering* 116(2):69–78.
- [48] Gillespie LK, Blotter PT (1976) The Formation and Properties of Machining Burrs. *Transactions of ASME Journal of Engineers for Industry* 98:66–74.
- [49] Gillespie LK (1995) Why We Need Standards for Burrs. *Manufacturing Engineering*.
- [50] Gillespie LK (1999) *Deburring and Edge Finishing Handbook*. Society of Manufacturing Engineers.
- [51] Guo Y, Dornfeld D (2000) Finite Element Modeling of Burr Formation Process in Drilling 304 Stainless Steel. *Journal of Manufacturing Science and Engineering* 122(4):612–620.
- [52] Guo Y, Dornfeld D (1998) Finite Element Analysis of Drilling Burr Minimization with a Backup Material. *Transactions of NAMRI/SME* 207(26):207–211.
- [53] Haller H (2004) Wer Entgraten sagt, sollte auch Wasser sagen!. *ZWF Zeitschrift für Wirtschaftlichen Fabrikbetrieb* 99(4):184–186.
- [54] Hashimura M, Chang YP, Dornfeld D (1999) Analysis of Burr Formation Mechanism in Orthogonal Cutting. *Transactions of the ASME Journal of Manufacturing Science and Engineering* 121(1):1–7.
- [55] Hashimura M, Dornfeld DA (1995) *Analysis of Burr Formation Mechanism in Machining Process*. Technical Paper. Society of Manufacturing Engineers, MR98-178, 1–14.
- [56] Hashimura M, Hassamont J, Dornfeld DA (1999) Effect of In-plane Exit Angle and Rake Angles on Burr Height and Thickness in Face Milling Operation. *Transactions of the ASME Journal of Manufacturing Science and Engineering* 121(1):13–19.
- [57] Hassamont J, Blondaz L, Dornfeld DA (1998) Avoiding Exit Burrs in CNC End Milling by an Adapted Tool-Path. *Proceedings of the ASME IMECE Anaheim*, 497–501.
- [58] Heisel U, Eggert U, Luik M (1998) Kurzlochbohren ohne Grate? *Die Maschine-dima* 52(3):54–58.
- [59] Heisel U, Rothmund J, Stortchak M, Eissler R (1999) Gratbildung beim Tiefbohren. *ZWF Zeitschrift für wirtschaftlichen Fabrikbetrieb* 94(6):337–340.
- [60] Heisel U, Schaal M (2008) Burr Formation in Intersecting Holes. *Production Engineering—Research and Development* 2(1):55–62.
- [61] Heisel U, Schaal M (2009) Burr Formation in Drilling with Minimum Quantity Lubrication. *Production Engineering—Research and Development* 3(2):157–163.
- [62] Heule U (1998) *Deburring Tool for Deburring the Edge of Boreholes*. US Patent 5803679.
- [63] Hickman PK, Judd RP (1987) *Robotic Deburring Using an Actively Controlled End Effector*. Technical Paper. Society of Manufacturing Engineers, 87-155, 1–15.
- [64] Hirabayashi H, Ohwada S, Yoshida I, Miiki M (1987) *Force-Control Deburring Robots*. Technical Paper. Society of Manufacturing Engineers, 87-313, 1–12.
- [65] Hockauf W (2002) *Burr Reduction Investment—Production Costs—Burr Reduction—Prediction of Burrs*. CIRP HPC Workshop, Paris.
- [66] Hofman P, Kvasnicka I (1999) A Study of Grinding Burrs Formation. *Abrasives Magazine* 29–33, Oct/Nov.
- [67] International Standard ISO 13715:2000, Technical drawings – Edges of undefined shape – Vocabulary and indications.
- [68] Ioi T, Kobayashi H, Matsunaga M (1981) *Computer Aided Selection of Deburring Methods*. Technical Paper. Society of Manufacturing Engineers, 1–11.
- [69] Jagiella M, Fericean S (2004) Inductive Sensor Systems for the Evaluation of Burrs and Edges in Industrial Applications. *Proceedings of the 7th International Conference on Deburring and Surface Finishing*, 89–101.
- [70] Jones S, Furness R (1997) An Experimental Study of Burr Formation for Face Milling 356 Aluminium. *Transactions of NAMRI/SME* 25:183–188.
- [71] Kato Y, Ohmri K, Hatano E, Takazawa K (2007) The Standardized Classification for Edge Quality of the Precise Machining Products. *Advanced Materials Research* 24–25:83–90.
- [72] Kawamura S, Yamakawa J (1989) Formation and Growing up Process of Grinding Burrs. *Bulletin of the Japan Society of Precision Engineering* 23(3):194–199.
- [73] Kim J, Dornfeld DA (2002) Development of an Analytical Model for Drilling Burr Formation in Ductile Materials. *Journal of Engineering Materials and Technology* 124(2):192–199.
- [74] Kim J, Dornfeld DA, Furness R (1999) *Experimental Study of Burr Formation in Drilling of Intersecting Holes with Gun and Twist Drills*, Technical Papers, NAMRI/SME, 39–44.
- [75] Kim J, Dornfeld D (2001) Cost Minimization of Drilling Operation by a Drilling Burr Control Chart and Bayesian Statistics. *SME Journal of Manufacturing Systems* 20(2):89–97.
- [76] Kim J, Min S, Dornfeld D (2001) Optimization and Control of Drilling Burr Formation of AISI 304L and AISI 4118 Based on Drilling Burr Control Charts. *International Journal of Machine Tools & Manufacture* 41(7):923–936.
- [77] Kim KH, Cho CH, Jeon SY, Lee K, Dornfeld DA (2003) Drilling and Deburring in a Single Process. *Proceedings of the Institution of Mechanical Engineers Part B Journal of Engineering Manufacture* 217(9):1327–1331.
- [78] Kishimoto W, Miyake T, Yamamoto A, Yamanaka K, Takano K (1981) Study of Burr Formation in Face Milling. *Bulletin Japan Society of Precision Engineering* 15(1):51–53.
- [79] Klocke F, Frank P, Risse K, Hoppe S (2005) FE-Analysis of Burr Formation and Edge Break out in Cutting. *Proceedings of the 8th International Workshop on Modeling of Machining Operation*, 621–631.
- [80] Ko SL, Dornfeld DA (1989) Analysis and Modelling of Burr Formation and Breakout in Metal Mechanics of Deburring and Surface Finishing Processes. *Proceedings of the Winter Annual Meeting of the ASME, PED-38*, December, 79–91.
- [81] Ko SL, Dornfeld DA (1991) A study on burr formation mechanism. *Transactions of the ASME Journal of Engineering Materials and Technology* 113(1):75–87.
- [82] Ko SL, Dornfeld DA (1996) Burr Formation and Fracture in Oblique Cutting. *Journal of Materials Processing Technology* 62(1–3):24–36.
- [83] Ko SL, Kim WS (2006) Development of Effective Measurement Method for Burr Geometry. *Proceedings of the I MECH E Part B Journal of Engineering Manufacture* 220(4):507–512.
- [84] Köhler G, Willems P (1980) Gratentstehung beim Bohren in Abhängigkeit vom Bohrerverschleiß. *Industrie Anzeiger* 107(14):34–35.
- [85] König W, Hoff M (1985) Qualitätsverbesserungen sind möglich—Den An- und Ausbohrvorgang optimieren. *Industrie Anzeiger* 107(1–2):20–24.
- [86] König W, Severt W (1995) Grate vermeiden bei der Bohr- und Fräsbearbeitung von Guß- und Stahlwerkstoffen. *Ölhydraulik und Pneumatik* 39(5):405–409.
- [87] Kumar S (2001) *Basic Model for Burr Prediction System Master's Report*. University of California, Berkeley, CA.
- [88] Lee KC, Huang HP, Lu S-S (1993) Burr Detection by Using Vision Image. *International Journal of Advanced Manufacturing Technology* 8(5):275–284.
- [89] Lee KC, Huang HP, Lu SS (2001) Adaptive Hybrid Impedance Force Control of Robotic Deburring Processes. *Proceedings of the 32nd International Symposium on Robotics, TC5-3*, 1–6.
- [90] Lee K (2003) Micro-Burr Formation and Minimization Through Process Control. *Precision Engineering* 29(2):246–252.
- [91] Lee SH, Dornfeld DA (2001) Precision Laser Deburring and Acoustic Emission Feedback. *Journal of Manufacturing Science and Engineering* – May 123(2): 356–364.
- [92] Lee SH, Dornfeld DA (2001) Precision Laser Deburring. *ASME Transactions Journal of Manufacturing Science and Engineering* 123(4):601–608.
- [93] Lee SH, Park DS, Dornfeld DA (1996) Burr Size Measurement Using a Capacitance Sensor. *Proceedings of the Second S. M. Wu Symposium on Manufacturing Science*, 31–36.
- [94] Lee SW, Choi HZ, Choi YJ, Kim GH, Ko SL (2004) Micro Deburring Technology Using Ultrasonic Vibration with Abrasive. *Proceedings of the ISAAT, International Symposium on Advances in Abrasive Technology, 7, Design and Production of Dies and Molds, vol. 3*, 477–482.
- [95] Leis K (2000) Burr Formation in Drilling Intersecting Holes. *Proceedings of the NAMRC North American Manufacturing Research Conference* 24:39–44.
- [96] Leitz L, Franke V, Aurich J (2009) Burr Formation in Drilling Intersecting Holes. *Proceedings of the CIRP Sponsored International Conference on Burrs: Analysis, Control & Removal*, Kaiserslautern, Germany, 99–105.
- [97] Leopold J, Neugebauer R, Löffler M, Schwenck M, Hänle P (2006) Influence of Coating-Substrate Systems on Chip and Burr Formation in Precision Manufacturing. *Proceedings of the Institution of Mechanical Engineers Part B Journal of Engineering Manufacture* 220(4):499–506.
- [98] Leopold J, Schmidt G (2004) Methods of Burr Measurement and Burr Detection. *VDI-Berichte* 1860:223–229.
- [99] Leopold J, Schmidt G, Hoyer K, Freitag A (2005) Modeling and Simulation of Burr Formation—State-of-the-Art and Future Trends. *Proceedings of the 8th International Workshop on Modeling of Machining Operations* 73–83.
- [100] Lin TR (1999) Experimental Study of Burr Formation and Tool Chipping in the face Milling of Stainless Steel. *Journal of Materials Processing Technology* 108(1):12–20.
- [101] Link R (1992) *Gratbildung und Strategien zur Gratreduzierung*, Dissertation. RWTH Aachen.
- [102] Mchugh B (1988) *Flexible Finishing with Dry Blast Deburring*. Technical Paper. Society of Manufacturing Engineers, 88-517, 1–24.
- [103] Means M (1986) *Deburring—Part 2. Tooling and Production* 51(10):47–51.
- [104] Merritt B (1976) *European Approach to Electrochemical Deburring*. Technical Paper. Society of Manufacturing Engineers, 1–19.
- [105] Min S (2001) *Modeling of Drilling Burr Formation and Development of Expert System*, PhD Thesis, University of California, Berkeley.
- [106] Min S, Dornfeld DA, Kim J, Shyu B (2001) Finite Element Modeling of Burr Formation in Metal Cutting. *International Journal of Machining Science and Technology* 5(3):307–322.

- [107] Min S, Dornfeld DA, Nakao Y (2003) Influence of Exit Surface Angle on Drilling Burr Formation. *Transactions of the ASME Journal of Manufacturing Science and Engineering* 125(4):637–644.
- [108] Min S, Kim J, Dornfeld DA (2001) Development of a Drilling Burr Control Chart for Alloy Steel AISI 4118. *Journal of Materials Processing Technology* 113(1–3):4–9.
- [109] NN (2004) www.guehring.de, Albstadt.
- [110] Nakao Y, Watanabe Y (2006) Measurements and Evaluations of Drilling Burr Profile. *Proceedings of the Institution of Mechanical Engineers Part B Journal of Engineering Manufacture* 220(4):513–523.
- [111] Nakayama K, Arai M (1987) Burr Formation in Metal Cutting. *CIRP Annals* 36(1):33–36.
- [112] Narayanaswami R, Dornfeld DA (1994) Design and Process Planning Strategies for Burr Minimization and Deburring. *NAMRC. North American Manufacturing Research Conference* 22:313–322.
- [113] Narayanaswami R, Dornfeld DA (1997) Burr Minimization in Face Milling: A Geometric Approach. *ASME Journal of Manufacturing Science and Engineering* 119:170–177.
- [114] Ogawa M, Nakayama K (1985) Effects of Chip Splitting Nicks in Drilling. *CIRP Annals* 34(1):101–104.
- [115] Ohmori K (1998) The movements of ISO 13715 as the only one international standard for edge quality (EQ). *Proceedings of the 5th International Conference on Deburring and Surface Finishing*, 146–157.
- [116] Oliveira JFG, Valente CMO (2004) Monitoring and Control in Abrasive Robotic Deburring Operations. *AC. International Conference on Monitoring and Automatic Supervision in Manufacturing* 7:1–8.
- [117] Olvera O, Barrow G (1996) An Experimental Study of Burr Formation in Square Shoulder Face Milling. *International Journal of Machine Tools and Manufacture* 36(9):1005–1020.
- [118] Park IW, Dornfeld DA (2000) A Study of Burr Formation Processes Using the Finite Elements Method. Part I. *Journal of Engineering Materials and Technology* 122(2):221–229.
- [119] Park IW, Dornfeld DA (2000) A Study of Burr Formation Processes Using the Finite Elements Method. Part II. The Influences of Exit Angle, Rake Angle, and Backup Material on Burr Formation Processes. *Journal of Engineering Materials and Technology* 122(2):229–238.
- [120] Park I (1996) *Modeling of Burr Formation Process in Metal Cutting*, PhD Thesis, University of California at Berkeley, Berkeley, CA.
- [121] Pikelharing AJ (1964) Why and How Does the Chip Curl and Break. *CIRP Annals* 12(3):144–147.
- [122] Pikelharing AJ (1978) The Exit Failure in Interrupted Cutting. *CIRP Annals* 27(1):5–10.
- [123] Przyklenk K, Schlatter M (1985) Vergleich und Einsatzbedingungen von Entgratverfahren. *Industrie Anzeiger* 107(14):36–37.
- [124] Przyklenk K, Schlatter M (1987) *Entgraten von Werkstücken aus Aluminium*. Aluminium-Verl, Düsseldorf.
- [125] Ramachandran P (2003) *Tool Path Planning for Face Milling Masters Report*. University of California, Berkeley, CA.
- [126] Rangarajan A (2001) *Optimization of the Face Milling Process: Tool Path and Tool Design Issues. Part 1. Algorithm and Tool Path Design LMA Research Reports*. University of California, Berkeley, CA. pp. 1–8.
- [127] Rangarajan A (2001) *Priority Based Tool Path Planning For Face Milling, Masters Report Laboratory for Manufacturing and Sustainability*. University of California Berkeley, CA.
- [128] Rangarajan A, Chu CH, Dornfeld DA (2000) Avoiding Tool Exit in Planar Milling by Adjusting Width of Cut. *Proceedings of the ASME Manufacturing in Engineering Division* 11:1017–1025.
- [129] Rangarajan A, Dornfeld D (2004) Back Cutting and Tool Wear Influence on Burrs in Face Milling—Analysis and Solutions. *Proceedings of the 7th International Conference on Deburring and Edge Finishing*, Berkeley, 333–340.
- [130] Rangarajan A, Dornfeld D, Wright P (2003) Probabilistic Precision Process Planning—P4. *Transactions of NAMRC/SME* 31:539–546.
- [131] Risiko DG (1993) *Electrolytic Deburring: Deburring and Re-radiusing in Seconds. Technical Paper*. Society of Manufacturing Engineers, 93–131, 1–21.
- [132] Rodic AD, Vukobratovic MK (1995) Contribution to the Controller Design in Tasks of Robot Deburring. *Mechanism and Machine Theory* 30(3):363–382.
- [133] Schäfer F (1975) *Entgraten*, Krausskopfverlag, Mainz.
- [134] Schäfer F (1978) Gratbildung und Entgraten beim Umfangsstirnfräsen. *VDI-Zeitschrift* 120(1–2):47–55.
- [135] Schein H (1977) *Electrochemical Deburring, Technical Paper*. Society of Manufacturing Engineers, 1–7, Paper-Nr. MR 77-451.
- [136] Schein H (1987) *Automatic Electrochemical Deburring. Technical Paper*. Society of Manufacturing Engineers, 87–154, 1–11.
- [137] Schüller GM, Engmann J, Marx T, Haberland R, Aurich JC (2009) Burr Formation and Surface Characteristics in Micro-End Milling of Titanium Alloys. *Proceedings of the CIRP sponsored International Conference on Burrs: Analysis, Control & Removal*, Kaiserslautern, Germany, 129–138.
- [138] Shefelbine W (2004) Influences on Burr Size during Face-Milling of Aluminum Alloys and Cast Iron. *Laboratory for Manufacturing and Sustainability. Consortium on Deburring and Edge Finishing*.
- [139] Shefelbine W, Dornfeld DA (2004) The Effect of Dry Machining on Burr Size. *LMA. Annual Reports 2003–2004. UC Berkeley* 71–75.
- [140] Shimokura K, Liu S (1994) Programming Deburring Robots Based on Human Demonstration with Direct Burr Size Measurement. *Proceedings of the IEEE International Conference on Robotics and Automation*, 572–577.
- [141] Sokolowski A, Narayanaswami R, Dornfeld DA (1994) Prediction of Burr Size using Neural Networks and Fuzzy Logic. *Proceedings of the Japan-USA Symposium on Flexible Automation, ISCFE*, Kobe, Japan, 889–896.
- [142] Spencer JD, Cobb RC, Dickens PM (1993) *Surface Finishing Techniques for Rapid Prototyping*. *SME Technical Paper PE*, 1–20.
- [143] Stein J, Dornfeld DA (1996) Influence of Workpiece Exit Angle on Burr Formation in Drilling Intersecting Holes. *Trans. North American Manufacturing Research Institute. SME* 24:39–43.
- [144] Stein J, Dornfeld DA (1997) Burr Formation in Drilling Miniature Holes. *CIRP Annals* 46:63–66.
- [145] Stoll A, Ahmed N, Mitrofanov AV, Silberschmidt V, Leopold J (2006) Influence of Ultrasonically Assisted Cutting on Burr Formation. *Proceedings of the 9th CIRP International Workshop on Modeling of Machining Operations*, Bled, Slowenien, 457–466.
- [146] Thilow A, Berger K, Prüller H, Maier R, Przyklenk K, Schäfer F, Pießlinger-Schweiger S (2005) *Entgrat-Technik. Entwicklungsstand und Problemlösungen expert Verlag*.
- [147] Toropov A (2007) An Effective Visualization and Analysis Method for Edge Measurement. *Computational Science and Its Applications—ICCSA 2007(4706)*: 941–950.
- [148] Toropov A, Ko SL (2006) A Model of Burr Formation in the Feed Direction in Turning. *International Journal of Machine Tools and Manufacture* 46(15):1913–1920.
- [149] Toshihiro J, Tomoaki O, Masahisa M, Hidetoshi K (1989) *On the Sensing System for Burr of Castings. Technical Paper*. Society of Manufacturing Engineers, 89–238, 1–14.
- [150] Tsai DM, Lu WJ (1996) Detecting and Locating Burrs of Industrial Parts. *International Journal of Production Research* 34(1):3187–3205.
- [151] Valente CMO, Min S (2002) *Drilling Burr Minimization Based on the Analysis of the Interaction Angle*, LMA Research Report, LMA. University of California, Berkeley CA.
- [152] Vijayaraghavan A, Dharan CKH, Dornfeld DA (2006) Quantifying Edge Defects in Drilled FRP Composites. *Transactions of North American Manufacturing Research Institute* 34:221–228.
- [153] Vijayaraghavan A, Dornfeld D (2005) Challenges in modeling machining in multi-layer materials. *Proceedings of the 8th CIRP Workshop on Modeling of Machining*, Chemnitz University, Chemnitz, Germany, 17–24.
- [154] Wang GC, Zhang CY (2004) Mechanism of Burr Formation in Milling. *Key Engineering Materials* 259–260:278–281.
- [155] Wang GC, Zhang CY (2004) Study on the Forming Mechanism of the Cutting-Direction Burr in Metal Cutting. *Key Engineering Materials* 259–260:868–871.
- [156] Warnecke G, Dollmeier R, Barth C (2002) Gratbildung beim Schleifen von gehärtetem Stahl mit konventionellen und hochharten Schleifscheiben. *Industrie Diamanten Rundschau* 36/3(202–204):206–208.
- [157] Warnecke HJ, Przyklenk K, Schlatter M (1985) Entgraten durch Hochdruckwasserstrahlen. *Werkstattstechnik wt—Zeitschrift für Industrielle Fertigung* 75(7):425–429.
- [158] Weinert K, Kempmann C, Kötter D (2002) Schleifen von Formgedächtnislegierungen. Einfluss des Schneidstoffs auf die Schleifbearbeitung von NiTi. *VDI-Z Integrierte Produktion Special II* 61–65.
- [159] Wulf C, Hayk M (2007) Automatic Residual Burr Detection on Steel Slabs by a Thermographic System. *MPT International—Metallurgical Plant and Technology* 30(2):36–37.
- [160] Yamakawa J, Kawamura S, Okuyama S (1989) Effect of Plastic Zone near Workpiece Ends on Grinding Burrs. *Bulletin of the Japan Society of Precision Engineering* 23(3):224–229.