

# UC Berkeley

## Earlier Faculty Research

### **Title**

Tilting Trains: The Italian ETR and the Swedish X-2000

### **Permalink**

<https://escholarship.org/uc/item/0w2896wt>

### **Author**

Barnett, Roger

### **Publication Date**

1992-07-01

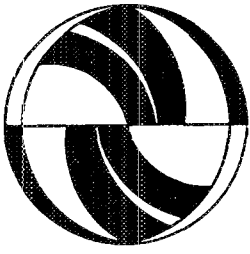

**CalSpeed**

*California High Speed Rail Series*

**Tilting Trains:  
The Italian ETR and the Swedish X-2000**

Roger Barnett

July 1992

Working Paper, No. 113

**The University of California  
Transportation Center**

University of California  
Berkeley, CA 94720

**The University of California  
Transportation Center**

The University of California Transportation Center (UCTC) is one of ten regional units mandated by Congress and established in Fall 1988 to support research, education, and training in surface transportation. The UC Center serves federal Region IX and is supported by matching grants from the U.S. Department of Transportation, the California Department of Transportation (Caltrans), and the University.

Based on the Berkeley Campus, UCTC draws upon existing capabilities and resources of the Institutes of Transportation Studies at Berkeley, Davis, Irvine, and Los Angeles; the Institute of Urban and Regional Development at Berkeley; and several academic departments at the Berkeley, Davis, Irvine, and Los Angeles campuses. Faculty and students on other University of California campuses may participate in

Center activities. Researchers at other universities within the region also have opportunities to collaborate with UC faculty on selected studies.

UCTC's educational and research programs are focused on strategic planning for improving metropolitan accessibility, with emphasis on the special conditions in Region IX. Particular attention is directed to strategies for using transportation as an instrument of economic development, while also accommodating to the region's persistent expansion and while maintaining and enhancing the quality of life there.

The Center distributes reports on its research in working papers, monographs, and in reprints of published articles. It also publishes *Access*, a magazine presenting summaries of selected studies. For a list of publications in print, write to the address below.



**University of California  
Transportation Center**

108 Naval Architecture Building  
Berkeley, California 94720  
Tel: 510/643-7378  
FAX: 510/643-5456

The contents of this report reflect the views of the author who is responsible for the facts and accuracy of the data presented herein. The contents do not necessarily reflect the official views or policies of the State of California or the U.S. Department of Transportation. This report does not constitute a standard, specification, or regulation.

# **Tilting Trains: The Italian ETR and the Swedish X-2000**

Roger Barnett

Institute of Urban and Regional Development  
University of California at Berkeley

CALIFORNIA HIGH SPEED RAIL SERIES

Working Paper, No. 113

The University of California Transportation Center  
University of California at Berkeley

*This paper was produced with support provided by the U.S.  
Department of Transportation and the California State  
Department of Transportation (CALTRANS) through the  
University of California Transportation Center.*

## TABLE OF CONTENTS

|                                      |    |
|--------------------------------------|----|
| LIST OF FIGURES                      | ii |
| PREFACE                              | iv |
| INTRODUCTION: A BRIEF HISTORY        | 1  |
| 1. SERVICE LEVEL                     | 7  |
| Network                              | 7  |
| Trains and Passengers/Direction/Hour | 16 |
| Ticket Distribution                  | 19 |
| 2. ENGINEERING                       | 20 |
| Motor and Power Supply               | 20 |
| Rolling Stock (Wagons)               | 23 |
| Control Systems                      | 35 |
| 3. PERFORMANCE                       | 43 |
| Vehicle (Train)                      | 43 |
| Passengers                           | 47 |
| Reliability                          | 50 |
| 4. ENVIRONMENTAL IMPACTS             | 52 |
| Land Use                             | 52 |
| Pollution                            | 52 |
| 5. REVENUE (vs. Competing Mode)      | 53 |
| Ticket per Passenger/Kilometer       | 53 |
| 6. COSTS                             | 55 |
| Infrastructure                       | 55 |
| Vehicles                             | 60 |
| Personnel                            | 60 |
| 7. SYSTEM STATUS                     | 62 |
| Research and Development             | 62 |
| APPENDIX                             | 67 |
| REFERENCES                           | 71 |

|            |   |    |
|------------|---|----|
| Figure 10  | Simple diagram of the "radial" bogie<br>( <i>Rail International, May 1991, p. 41</i> )  | 32 |
| Figure 11a | Simple diagram of the outward tilt of a car body created by centrifugal force   | 33 |
| 11b        | Diagram of a passive tilt mechanism: car body swings out from a high suspension point and automatically tilts to a correct angle  | 33 |
| 11c        | Diagram showing outward tilt of bogie bolster as a result of centrifugal force. This tilt is a function of suspension of bolster on bogie frame (on SJ cars it is a maximum of 1 percent outwards)  | 33 |
| 11d        | This diagram shows combined forces acting upon a tilting car in X-2000 train. The tilting mechanism tilts car in up to 8° into the curve. Note that bolster is allowed a 1° outward tilt, and car body riding on air cushions (see Fig. 9) is allowed a further 0.5° outward tilt resulting from centrifugal force. Thus net tilt of car is 6.5° into curve. This diagram also shows car on a superelevated curve   | 33 |
| Figure 12a | A clear demonstration of the impact of running through a reverse curve showing the information received, filtered, corrected, and finally sent to tilting jacks. Horizontal axis shows elapsed time in seconds in transiting a reverse curve. The top four vertical axes show lateral force in meters/per sec./per sec.; the bottom vertical axis converts this force into degree of body tilt.<br><i>Top graph:</i> lateral accelerations from normal sway (yaw). <i>Second graph:</i> lateral acceleration felt by bogie as it passes through the curves = sway from yaw plus impact of taking a curve.<br><i>Third Graph:</i> filter removes minor and constant acceleration derived from swaying to produce a smooth curve of lateral acceleration force. <i>Fourth graph:</i> Gyroscope corrects for absence of measurable acceleration on transition curves. The impact of gyroscope shows clearly for a second or two as the train enters or leaves a curve. <i>Fifth graph:</i> the values in graphs three and four are combined and converted to a degree of tilt from a measurement of meters per second/per second. It is easily seen from this graph that without the gyroscope reading, the body tilt would have come 1-2 seconds too late at the following moments: at 1-2 secs into the first curve, at 7 secs, at 11-12 secs, and at 17 secs. However, there is no gyroscope input at 4-6 secs into the curve, even though car is tilting at 5 degrees, nor is there any at 20-22 secs, even though by now car is tilting at 7.5 degrees in the opposite direction.<br>( <i>IRJ, December 1987, p. 26</i> ) | 37 |
| 12b        | Shows a more complex version of same relationships illustrated in Fig. 4a, in this case proceeding from bottom up, to illustrate factors in Fig. 4a. However, reading down, the four graphs show: superelevation of track; gyroscope's reading of induced tilt; corrected gyroscope reading, showing rapid response to entry onto superelevated track; "proceed" signal given by gyroscope to tilting jacks; and resultant body tilt signal, which combines with information coming from below (i.e. from accelerometer)<br>( <i>IRJ, December 1987, p. 26</i> )  | 37 |
| 12c        | Shows combined effect of radius of curve (horizontal axis) on permissible maximum speed (vertical axis) for a non-tilting and for a tilting train with up to 10° tilt, combining effects of radius and superelevation (latter shown on lower right of graph, with values in mm. given on right side vertical axis)<br>( <i>IRJ, December 1987, p. 26</i> )  | 37 |

## PREFACE

This is one of a series of reports now being published as the first output of IURD's study of the potential for a high-speed passenger train service in California. Each report deals with a specific high-speed train technology; it attempts an evaluation, standardized as far as available data permit, of its technical and economic viability.

Specifically, each report assesses the particular high-speed technology on a number of criteria:

1. *Technical performance*: configuration of roadbed in terms of gradients, curvature, and construction cost; power sources; capacity and speed; capacity to integrate with existing transportation facilities.
2. *Economic performance*: traffic levels; revenues; financial appraisal and overall cost-benefit analysis; level of public subsidy required, if any.
3. *Resource consumption and environmental performance*: type and amount of energy required; impact on non-renewable resources; environmental impact, including emissions, noise, visual intrusion and effect on local communities.

The present series includes seven studies. This is the sixth of seven studies, five of which have already been published. A companion study, on British Rail's Inter-City 125 and 225 services, will follow shortly. At that time, a systematic comparative analysis will be published.

The CalSpeed study will continue with preliminary route alignments, also to be published shortly, followed by market assessments, to be published in Fall 1992. These will bring to a close the present phase of work, which will be the subject of an overall report also to be published in Fall 1992.

We gratefully acknowledge the support provided by the United States Department of Transportation and the California Department of Transportation [CALTRANS] through the University of California Transportation Center. Of course, any errors of fact or interpretation should be assigned to us and not to our sponsors.

**PETER HALL**  
Director and Principal Investigator



# TILTING TRAINS: THE ITALIAN ETR 450 AND THE SWEDISH X-2000

Roger Barnett

## INTRODUCTION: A BRIEF HISTORY

### The Traditional Railroad and High Speed

Among the high speed passenger rail services developed over the past 30 years, the two most successful and widely known are the pioneering Shinkansen lines in Japan, launched in the 1960s, and the French TGV, which celebrated its 10th anniversary a few months ago. The very success of these two systems suggests that their particular characteristics are the hallmark of a modern high speed rail system. Both the Shinkansen and the TGV dealt with the problems of safe and reliable high speed by building dedicated brand-new lines with state of the art technology rather than retro-fitting or upgrading existing track.

In both the technical and the financial areas they are remarkable achievements, but they both required a substantial investment in brand-new permanent way and rolling stock. The two major problems which limit high speed running on older rail systems— short radius and reverse curves, and steep and irregular gradient profiles — are simply set to one side by building new lines with carefully calculated long radius curves and grade profiles.

Where traffic potential justified the enormous fixed capital investment (as we may assume it did in Japan and France), and where the amount of investment capital could be raised, the Shinkansen or TGV approach clearly is appropriate. But what of poorer regions, with less capital, smaller traffic volumes, and an existing rail network? Are there possibilities for upgrading speeds using the existing trackage to a major extent?

The simple answer to this problem is to switch emphasis from the permanent way to the rolling stock. Rail lines without excessively irregular grade profiles, but with tight radius curves, can indeed be adapted for higher passenger train speeds. A vehicle travelling through a curve is subjected to centrifugal force, a linear acceleration which may destabilize and derail it at excessive speed. The passengers are equally subjected to the same forces, and the ride will become uncomfortable and ultimately intolerable at higher speeds. For over 100 years, increased speed through curves has been possible by building curved track on a cant. The vehicle leans into the curve, tilting toward the center of the arc of the curved track section, and thus partially compensates for the centrifugal force and linear acceleration.

During the past century, civil engineers have extracted all possible benefits from maximizing cant angles and using transition curves that lead from straight to minimum radius sections. The line must also meet norms of operating safety and comfort when trains pass at low speeds or are brought to a stand on curved sections, which thus limits the maximum cant angle. Maximum operating speed of the trains is a function of the minimum radius of the curve and maximum possible cant. On existing lines the civil engineers reached the limits for these functions many decades ago, leaving major rebuilding with greater radius curves and flatter gradient profiles as the only possible source of greater speed for trains of formed of traditional rolling stock.

### The Origins of Tilting Trains

The limits of classic railroad engineering could only be overcome by adapting the vehicles to higher speeds. Lowering the center of gravity, and tilting the railroad cars themselves in tight radius curves, could add substantially to maximum speeds through curves on these older lines. The oldest surviving contemporary efforts to do this date from the same years in which the Shinkansen was built. Most earlier attempts to improve speed and stability through tight curves, using monorails and gyroscopes, remained strictly experimental, and today appear both impractical and even bizarre.

Spain, beset with a broad-gauge network of mediocre construction standards and many tight curves, introduced the unique *Tren Articulado Ligero GO* (TALGO) trains in the 1960s. The Talgo trains consisted of passenger cars with very short bodies, each unit having two single floating half axles, and the whole linked together in a single articulated train that has flexibility, ground-hugging qualities, and even the reticulation of a snake. The Talgo system provided the *Red Nacional de los Ferrocarriles Espanoles* (RENFE), the Spanish State Railway network, with what appeared to be a perfect solution for the quantum leap in speed and comfort in their services in the 1960s. Although not adopted elsewhere, Talgo trains are still operated in Spain. New ones have been added recently for both domestic and international traffic— the Talgo also offers one of the easiest methods of adjusting the wheel set at the frontier when switching from broad to standard gauge.

In the 1970s the RENFE tried to build upon the qualities of the Talgo train by introducing the "*Talgo Pendular*," a train set with a passive tilting mechanism. Using a suspension mechanism the train could move faster through curves, maintaining both its stability and degree of passenger comfort— the degree of tilt being a function of the speed.

At the same time the *Ferrovie dello Stato* (FS), the Italian State Railway, introduced the first "*Pendolino*" train set. The prototype vehicle, a single text car designated Y.0160, was devel-

oped by Fiat and tested thoroughly in the period 1971-73 on FS tracks, before FS ordered a prototype four-car train which was to be delivered in the Spring of 1974. This train had a maximum potential speed of 250 km/h on straight track, a requirement specified "to take advantage of the new *direttissima* now being built or planned in Italy" (RGI, Mar. 74: 102). Shortly after, and in conjunction with a Spanish engineering company, a similar train was ordered by RENFE for delivery in 1975.

The prototype Pendolino four-car train was placed in service in June 1976 between Roma and Ancona on the Adriatic coast. For the first 70 km, between Roma (Settebagni) and Orte, the train used the southernmost part of the newly opened first portion of the Roma-Firenze Direttissima. In spite of the design specification of 250 km/h maximum, the new direttissima line had an operating speed limit of 200 km/h (most likely due to signalling limitations). The remaining 230 km crossed the Appenino mountains on a sinuous track, with a minimum radius of 350 meters. The train ran at lower than permissible speeds in the mountain section because of heavy rail wear on the tight curves. The total saving in time over the 300 km was expected to be 20 minutes rather than the 40 minutes possible with the tilting mechanism.

In the Cook Continental Timetable of June 1976, the train operated on Fridays and Sundays only, one round trip leaving Rome in mid-afternoon, returning from Ancona in late evening, and taking 2 hours 50 minutes for 295 km (183 mi). The other two Rapido trains using this route took 3 hours 30 minutes with one more stop shown in an abridged timetable. The 40 minutes expected savings seem to have been achieved.

In the December 1978 Cook Timetable, the train ran three/four times weekly (there is one unbalanced working), with no service on Sun-Mon-Tuesdays. It left Ancona in the early morning (6.15 am), returning from Roma in mid-afternoon (15.15 pm), and now required 2 hours 50 minutes, with one less stop. By July 1980, the train operated on weekdays only on almost the same schedule, but the journey time lengthened to 3 hours exactly. In 1982 and 1984 the journey time appears to have lengthened to 3 hours 20 minutes (still weekdays only on the same schedule), but the train is also noted as running through to Rimini. The train numbers remain the same from 1976 to 1984 but the equipment used may have changed by 1982; there is no positive indication in the timetable other than a designation of a first-class only, reservations required, railcar set for the entire period 1976-1984.

Although the timetable record over these eight years suggests less than an ongoing success, the Pendolino significantly raised speeds on lines with tight curves and less than first-class maintenance, and did it with rolling stock of both structural form and dimensions similar to that

of classic vehicles (4-wheel trucks, standard loading gauge profile, and close to standard length). Certainly FS believed that the Pendolino successfully demonstrated the viability of high speed trains using an active tilting mechanism (IRJ, June 79: 80-1). With the launching of a major series of major investment plans beginning in the early 1980s (see below), FS felt that the Pendolino had both proved itself and would have a part to play in the modernized railway of the future.

The same era, the 1970s, also saw the development of the Advanced Passenger Train (APT) by British Rail (BR). More ambitious than either the Talgo Pendular or the Pendolino, the APT was envisaged as a fleet development to provide a frequent-interval service on a heavily used line, a line in principle suitable either for duplicating by a TGV or Shinkansen or massive upgrading, though in practice neither option was viable. The APT was a total failure and it demonstrated a major pitfall of tilting trains: when the tilting mechanism fails the ride becomes intolerably uncomfortable for the passengers even if the safety of the train is not compromised. The APT trains were withdrawn on the eve of introduction of revenue service in 1982, and British Rail has made no further attempt to re-introduce them.

The successful tilting trains of today belong to FS, and to Statens Jernvägar (SJ), the Swedish State Railway. The contemporary Italian trains began operational trials in late 1988, and revenue service in the summer of 1989. The new trains of Sweden began trial service in early 1990, and revenue service in December 1990.

### **Contemporary Tilting Trains of FS**

The new Italian train sets have been developed by an industrial consortium led by Fiat, drawing upon their considerable experience with the earlier Pendolino sets. These latter were withdrawn sometime prior to the introduction of the new tilting sets: 5- or 11-car electrical multiple units designated ETR 450. The new ETR 450 sets use virtually identical tilting mechanisms to the predecessor Pendolino train; much more important changes have been made to the electric traction systems as a result of significant gains in motor design and control which emerged in the 1970s and which continue to evolve (IRJ, Dec. 86: 26).

The investment plans (Integrated Plan for FS, and the State Master Plan for Transportation) developed in the early 1980s provided the means to order a fleet of ETR 450 sets in early 1985 (RGI, Dec. 85: 933-5). The order consisted of ten 11-car sets and four 5-car sets, the former destined for the Roma-Milano-Torino arterial service, and the latter for services south from Roma to Reggio in Calabria and Bari. The first 11-car set was delivered at the end of 1987 for trials and entered revenue service in June 1988 between Roma and Milano, non-stop. This new timetable

also contained a much improved (both faster and much more frequent) schedule of classic trains on this route, itself the product of the early 1980s investment programs (see Figure 1c).

The whole fleet of tilting trains (ten 11-car and four 5-car sets), although expected to be actually deployed by Fall 1989, entered service in the summer of 1990. The service pattern previewed in the mid-1980s has, in fact, been adopted. The July 1990 Cook Continental timetable shows all but the Roma-Reggio/Calabria train in operation (it is, however, shown in the 1991 summer timetable). There is a full range of inbound trains from the north to Roma in the morning, and northward return service in the evening, plus one midday additional service to Venezia. Napoli, Reggio/Calabria, and Bari also have daily ETR 450 service from Roma.

### **Contemporary Tilting Trains of SJ**

The Swedish sets have been developed by ASEA Brown Boveri (ABB), a major European multi-national heavy electrical engineering firm, formed in 1988 by the merger of the Swedish General Electric Company (ASEA) and the Swiss electrical engineering firm of Brown-Boveri. The work on the tilting train originally was pioneered by ASEA, beginning in the early 1970s, following basic specifications developed by SJ for a future high speed train. Over the next 15 years ASEA worked on a prototype X-15 train using these guidelines, until SJ placed an order for 20 trainsets (then designated X-2) in the summer of 1986. The first production trainset was delivered in early 1990 for trials over the following nine months before the second set was delivered in late 1990. Thereafter a set has been or will be delivered every two months with final delivery in early 1994 (IRJ, Apr. 1990: 37-40). The working version of these tilting trains has been designated by SJ as the X-2000.

Both the Italian and Swedish trains use active tilting mechanisms, controlled by an on-board computer system. Both have been introduced using a carefully phased program, and have thus so far avoided the catastrophe of the British APT. Both owe their technical success to the research programs and engineering resources of a major outside contractor, who is also itself interested in building high speed rail equipment for a future international market. The operating railroads, SJ and FS, have however played a critical secondary role as developer by setting the basic specifications for higher speed trains, by investing in a required minimum amount of permanent way improvement, by providing test tracks for prototypes, and by offering a showcase for the production equipment in daily service.

FIGURES 1a, 1b, and 1c

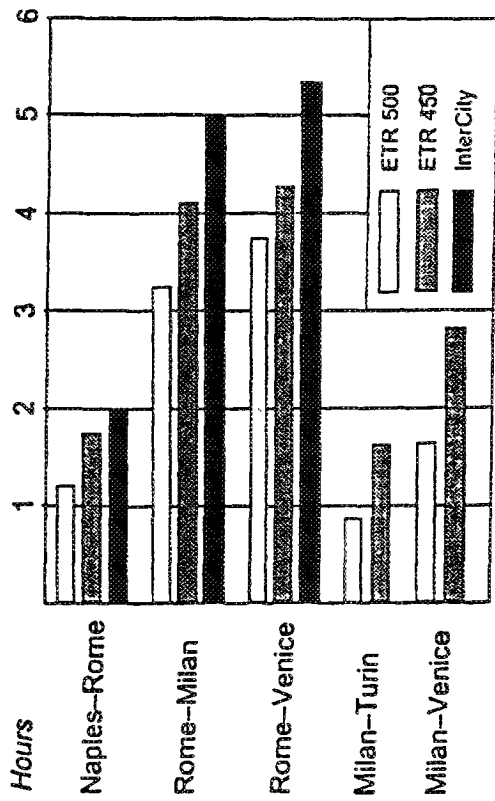
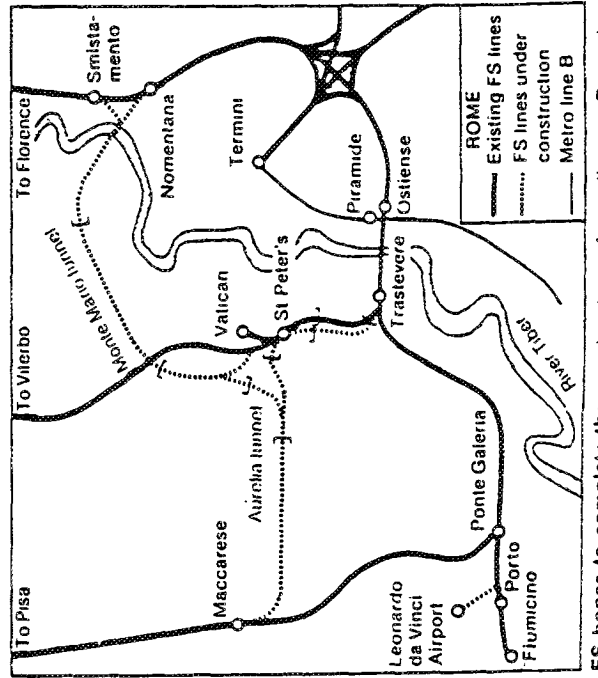

Fig. 1a



FS hopes to complete the construction of new lines in Rome by 1998

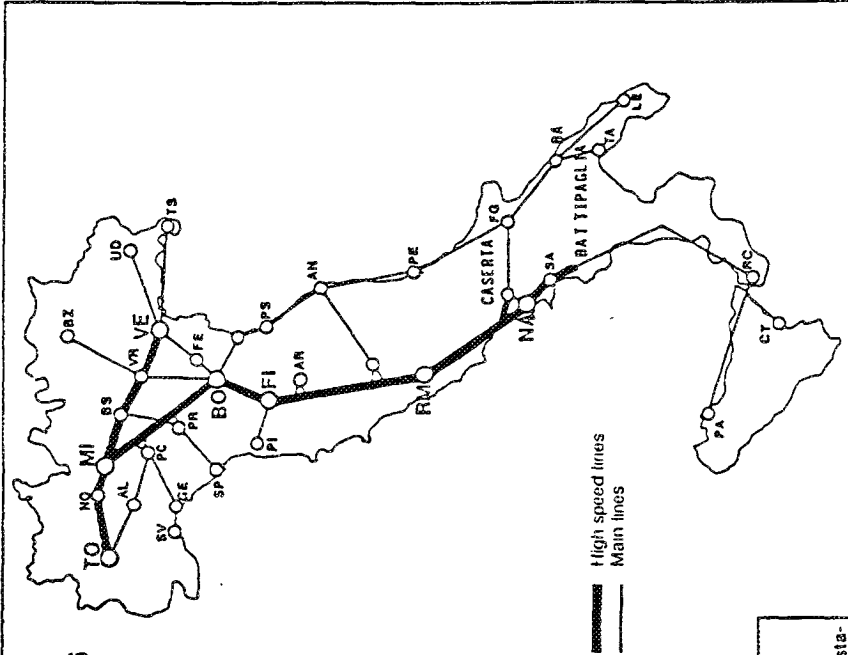

Fig. 1c

## 1. SERVICE LEVEL

### NETWORK

#### Density

The national territory of both Italy and Sweden is much greater in length from south to north than in width from east to west. In this respect both countries resemble Japan. The existing rail network is characterized by long axial lines on a general N-S trend. All three states (Sweden, Italy, and Japan) extend over 11° of latitude, and the maximum through rail journey from one end of the country to the other is between 1,500 and 2,000 km. (950-1250 mi.). On the traditional railroad, through journeys by train from one end of the country to the other in all three countries have taken at least 24 hours.

A network of this geographical form contrasts strongly with that of France, whose rail network is primarily radial from the central node of Paris within a much compact territory. Japan, which pioneered the dedicated high speed passenger rail system, provides a potential model for future Italian development. But whereas Italy and Japan are relatively densely populated, Sweden is not. It is thus worthwhile to examine Italy in the context of the Japanese approach to high speed rail development. By contrast, Sweden is in a stand-alone situation.

#### *Italy and Japan*

Japan and Italy share similar patterns of population. Both national capital cities, each a principal focus within the national rail network, are located in a central position in this elongated territory. However, Japan, on a national territory 20 percent larger (370,000 sq.km. vs. 310,000 sq.km.), has almost exactly twice the population of Italy (120 mn vs. 58 mn inhabitants). These differences in numbers explain in part the difference between the Japanese and Italian approaches to high speed rail development. However, the size and density of the Italian population do suggest that the Japanese approach to high speed rail—dedicated new lines—might not be inappropriate for Italy. This point is discussed below.

While Roma and Tokyo, as capital cities, are today of highest importance in the national transportation network, both Italy to the north of Roma and Japan to the south and west of Tokyo are populous and prosperous regions, the location of linear sets of major urban centers (Nagoya, Osaka, Hiroshima, Fukuoka; Milano, Torino, Venezia, Firenze) which can support a high level of modern passenger transportation service. Italy and Japan both have a high proportion of rugged

mountain terrain, and as a consequence both countries initially built a network of sinuous low speed rail lines. Japan adopted a narrow gauge of 3'6" to accommodate this terrain; Italy built standard-gauge lines but many of them were winding single track routes.

Thus, the principal features of the Italian and Japanese networks are:

- a. *a linear axis carrying the highest passenger loads* from the capital to the string of most important provincial cities:
  - Tokyo-Nagoya-Osaka-Hiroshima-Fukuoka, 1000 km./620 mi.
  - Napoli, Roma, Firenze, Bologna, Milano, Torino, 850 km./530 mi.
- b. *extension(s) of the linear axis* in an opposite direction to poorer and less well-populated regions:
  - Tokyo-Morioka-Aomori, then across water to Sapporo
  - Napoli-Reggio, then across water to Palermo
- c. *parallel or lateral axes of secondary importance*, but tied into the central axis at one point:
  - Tokyo-Niigata and beyond
  - Milano-Verona-Venezia-Trieste, or Bologna-Ancona-Bari-Lecce
- d. *minor lines across rugged terrain or in isolated areas and islands*:
  - Sea of Japan coastal lines, local networks on Kyushu or Hokkaido
  - Other Italian coastal lines, local networks on Sicilia or Sardinia

These similarities between Italy and Japan raise the interesting question: why has Italy not adopted the Japanese solution of new construction of dedicated high speed lines? A major answer clearly lies in the difference in population numbers, which assured the Japanese of the volumes of traffic to justify the very high capital investment in the original Shinkansen line.

But many other differences also contribute: the relative wealth and availability of capital in each country, the difficulty or impossibility of upgrading the existing network, competition of other modes of transportation, and the relative efficiency of central planning and management. In each case at a critical time the sum of these factors led the Japanese to the Shinkansen solution, treating the existing rail network as beyond adaptation, but it allowed the Italians to consider a variety of less costly alternatives; significantly among them was the development of the original Pendolino tilting train in the 1970s.

The value of massive capital intensive in the building of new lines has been important in the Italian perception of railroad development for a long time. It was important when the fascist government built the new trans-Appenine "direttissima" line (Firenze-Bologna) in the 1930s.



Following the same principle, FS has built the new Roma-Firenze "Direttissima" line (parallel to but significantly faster than the original 19th century line) between the mid-1970s and 1991.

Thus, although much work has gone into developing a reliable tilting train (the ETR 450), the long-term Italian plan is to build a core network of heavily engineered high speed lines using non-tilting equipment (the ETR 500 train sets). The ETR 500 prototypes are already operating; production-line manufacturing of the ETR 500 will soon get underway. The first of these new "direttissima" lines will be the busiest axis, Napoli-Roma-Firenze-Bologna-Milano-Torino, extending northward the existing Roma-Firenze section. Roma-Napoli-Battipaglia is under construction. The relatively easy upgrades of the axial lines of the Northern Italian lowlands (Torino-Milano-Bologna, and Milano-Venezia) will follow in the 1990s as capital becomes available (IRJ, Dec. 87: 22-26). The ETR 500 trains will produce further time savings as compared with the ETR 450 series (see Figures 1a, 1b, and 1c).

Therefore, over the longer term, the ETR 450 and its successor tilting trains (if any) will be more and more limited to the secondary lines of the national network. Their role will diminish in importance. The Fiat consortium as builders of the ETR 450 has every interest in its present success in Italy and future adoption elsewhere, but an expanded industrial consortium (with Fiat still a major partner) has also been entrusted with building the ETR 500. FS's interest in the ETR 450 as a major capital investment for high speed rail may decline as its interest turns toward the Direttissima lines and the ETR 500 trains. Eventually this latter equipment will be FS flagship rolling stock running over its finest routes.

### *Sweden*

Sweden has 50 percent greater area than Italy (450,000 sq. km.), but has less than 15 percent of the Italian population (8 mn inhabitants). Unlike Italy, there is extensive rail mileage running through very sparsely populated areas, including almost the entire northern half of the country (north of Stockholm). Even the more densely settled southern half of Sweden still has significant areas of low population density. The Swedish network, therefore, while bearing a superficial resemblance to that of Italy or Japan, has only a fraction of the traffic potential of these other two countries.

The two main axial trunk lines of SJ link Stockholm (1 mn inhabitants) with Göteborg (450 km. to the south-west) and with Malmö (600 km. to the south). These two lines share a short common trunk for the last 35 km. from Stockholm to Södertälje. Both Göteborg and Malmö have a population below 500,000 and are thus considerably smaller than either the second- or third-ranking cities of Japan or Italy (see Figure 2).

FIGURE 2

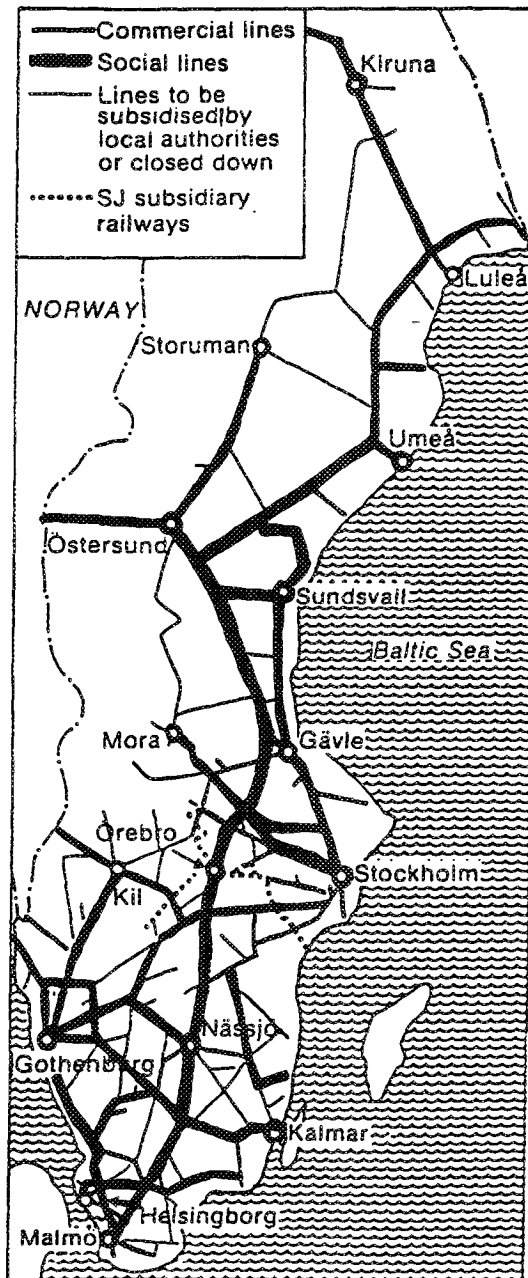

IN 1983-84, the size of SJ's social network was increased to 63% of the railway.

The remainder of the Swedish network consists of relatively lightly used main lines west and north from Stockholm— to Oslo and to the far north; the latter extends over 1000 km. from Stockholm at its furthest point— and of equally lightly used secondary and cross-country routes, of which the west coast line (Malmö, Göteborg, Oslo) is the busiest.

This low potential for traffic development makes any kind of massive new investment, following the TGV or Shinkansen model, out of the question in Sweden. Continued use of the existing network, with a modest investment in permanent way upgrade, is a *sine qua non* of any plans for future high speed service. Thus Sweden, unlike Italy, has been inexorably forced into consideration of the only possible alternative form of high speed rail passenger service: to run faster trains on the present track. Only tilting trains offer this opportunity. Given the wealth and the technical skills available, Sweden is well equipped among countries to pursue this high speed rail strategy.

Indeed, for long-distance passenger service to survive competitively in Sweden it is probably essential to have faster trains which can compete with air travel. If not, the alternative might well be the relegation of passenger rail travel to a struggling relict status, following in the past of passenger service in many similar parts of the world: Canada, Australia, or the interior and western United States. A decline of passenger rail service to this extent was never even contemplated in Italy, whatever the management and organizational problems which FS faced at times in the 1980s. The X-2000 tilting train is central to the planning of future passenger service on SJ— the ETR-450 is a partial and transitional element in the much more broadly based high speed rail program of FS. Nevertheless, in December 1991, FS sent Fiat a letter of intent to purchase ten more 9-car ETR 450 train sets, to feature: upgraded design features, wider bodies with 4-to-a-side seating, improved electrical motors and ancillary equipment, and dual-voltage operating capacity for working into Switzerland. In an extended article on the role of new investment funds to create a new 300km/h FS high speed network which the government allocated in the summer of 1987, the IRJ noted in December 1987: "Meanwhile, the first of a fleet of tilting high speed trains enters service next year to bridge the gap until the new lines are completed."

### **Integrated or Dedicated Systems**

Because the X-2000 of SJ is intended for use on existing lines, the Swedish high speed system is fully integrated into the existing rail network. All of the permanent way upgrading to be discussed below is equally fully integrated into the network and will be used by all trains.

The FS approach, by combining elements of both tilting technology and the building of the Direttissima lines, has effectively created a new integrated high speed system but with its own

special features. If the Roma-Firenze Direttissima line is the model for future developments, then FS has created what may be described as a dedicated line with a very high level of connectivity to the existing network. The Direttissima parallels the original line, rarely out of its sight. Cross links between the old and new lines are provided at all important stations (at least seven in the 300 km. between Roma and Firenze), permitting trains to leave and return to the Direttissima to serve the intermediate station.

The FS, however, does not view the Direttissima as a dedicated line; on the contrary, it prefers to designate the entire project as one of quadrupling tracks between Roma and Firenze. FS will also designate future direttissima lines from Firenze to Bologna and Milano as quadrupling. In using this designation, FS insists upon the multi-purpose role of the new lines, in particular for high speed freight trains at night. FS's share of national freight traffic is low and has been falling—the National Transport plan envisaged much more rapid growth in the freight sector, both freight traffic to adjoining states of the European Community and longer-haul domestic freight (IRJ, Dec 89: 29-30).

Thus the line can be operated over its entire length as though it were dedicated; that is, with no station calls between Roma and Firenze. The high level of connectivity permits, additionally, a varied pattern and level of passenger service to intermediate stations and allows the use of the line for freight trains in non-peak passenger hours. In the first mode (equivalent to a dedicated line), the ETR 450 trains offer a modest advantage in speed at present over older passenger rolling stock, but will offer none at all over the new ETR-500 equipment. The tilting capability will be redundant on this section, but it will remain of value on extension and branches beyond the direttissima lines. The present Roma-Firenze line is currently being used in this way by trains travelling to distant northern destinations.

To provide both a dedicated high speed line and to use tilting equipment between any two points is clearly a waste of investment; to use tilting equipment on dedicated lines and then have trains continue their journeys on unimproved integrated lines provides an optimum level of high speed service. It is a level of high speed service which exceeds that of contemporary TGV trains, which leave a dedicated new line to continue to distant destinations on older traditional track. However, the higher cost of an individual tilting train compared to non-tilting equipment may not be justified by the marginal gains in speed over the older traditional track. FS may find it cost-effective ultimately to phase out the ETR 450 as its high speed network, using the ETR 500, becomes complete. If so, the FS will have transformed its high speed system into a facsimile of that of Japan or France (see Figure 3).

FIGURE 3

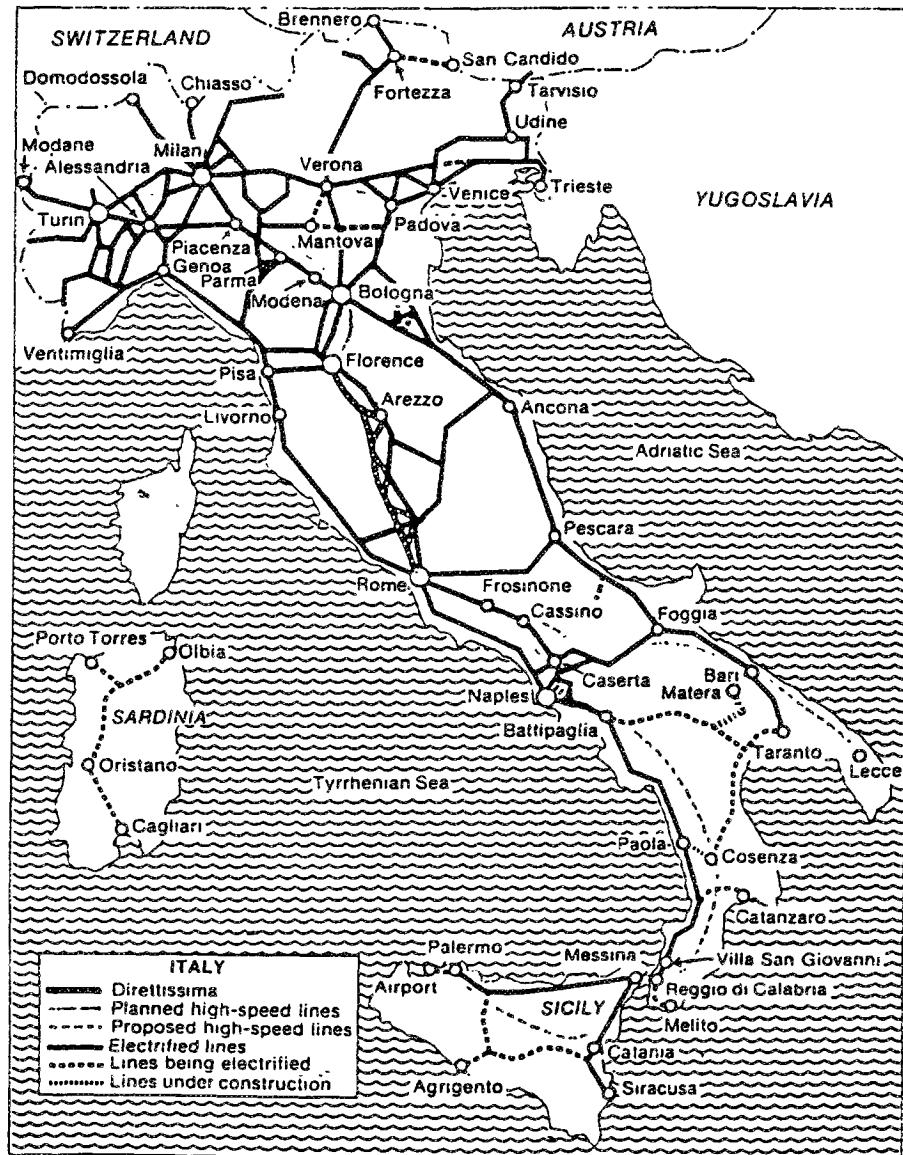

### **Station Spacing and Number of Stations**

As both the ETR 450 and X-2000 trains are designed to operate over existing lines, the spacing and number of stations on those lines is essentially inherited from the pre-existing pattern. The introduction of the new trains does, however, create the possibility that the railway operating agency may decide to change its station pattern, closing minor stations and building new ones suitable for the evolving pattern of passenger service.

#### *Sweden*

The introduction of the X-2000 train on the SJ trunk lines has had little impact on the spacing and number of stations. Given the low population densities, stations were widely spaced in Sweden in comparison with Italy or most other European countries. The benefits of the X-2000's high speed are fully obtained by eliminating virtually all station stops on the only route (Stockholm-Göteborg) yet in service. The number of intermediate calls by the X-2000 Stockholm-Göteborg trains, once numbering five to seven, is now one or two. One of these stops is the new outlying station at Stockholm Syd, a suburban transportation node 15 km. southwest of central Stockholm, with good access to the western and southern outer suburbs of the metropolitan area (Cook European Timetable, October 1991).

The other intermediate stop of the X-2000 trains is Skövde, a provincial city 150 km. from Göteborg and 300 km. from Stockholm. Skövde will now have a much higher level of fast service to Stockholm and Göteborg than any other locality on the line. Previously, it enjoyed similar service patterns to at least five other comparable intermediate locations on this route. The stop at Skövde is ostensibly a political and/or commercial decision by SJ (or other authorities), since it has required no special or new construction. Equal service could have been offered to other cities on the line, with one stop per through trip, without any loss of overall speed.

Safety considerations when high speed trains are operating may eventually lead SJ to close intermediate stations. Grade crossings, which have been reduced in number but not eliminated, are frequently found at intermediate stations. It may be more efficient to eliminate both the grade crossing and station simultaneously, for reasons of both safety and economy. Abolition of intermediate stations with modest traffic potential is a frequent feature of modernization programs that envisage raising line speeds.

## *Italy*

The high degree of inter-connectivity between the Direttissima and the original Roma-Firenze line has created an unusual pattern of intermediate stations. The Direttissima, if used for through trains, has no intermediate stations. If used in conjunction with the connections to the original line it has as many intermediate stations as desired. Trains stopping at all the principal stations with a connecting link can use the Direttissima effectively, though perhaps at some risk of reducing the headway for non-stop through services as they accelerate and decelerate on entering and leaving the Direttissima. These same trains, however, gain enormously from the reduced risk of being slowed by local low-speed passenger and freight traffic on the original line. FS has created the optimum pattern of station spacing by using this parallel routing of the old and the new lines.

Elsewhere on the traditional lines, where stations are often closely spaced, increased train speed raises safety concerns and may increase the potential for accidents leading to train derailments. The use of tilting trains on traditional tracks may therefore ultimately require the closure of many minor intermediate stations on Italian trunk lines, thus making station spacing in Italy more closely resemble that of Sweden. An alternative is to invest in upgrading track alignments or rebuilding stations so that high speed trains are kept clear of station activity as they transit these areas.

### **Through-Running, Connections with Other Systems**

Through-running to the remainder of the national network is no problem for either the X-2000 or the ETR-450. Vehicles of both trains operate on standard-gauge track within the European loading gauge. Sweden currently has so few cross-border connections that through-running is a minor issue. The only land connections to Norway pose no problems; in the long-term future, a tunnel connection with Denmark will not pose any either. SJ has viewed the X-2000 as a internal rail service thus far (IRJ, Feb. 87: 16-18).

Italy has many more through trains from its northern cities into France, Switzerland, Germany, and Austria. The development of high speed trains in Italy therefore certainly envisages through-running in the long term to France and Germany. Track gauge and loading gauge will present no problem. The through-running of fixed train sets will be more difficult because of national variation in the voltage and phasing of the electrical supply. The vast majority of international trains today are locomotive-hauled and the locomotive is changed at a frontier station. Italian high speed train sets will have to be equipped with multi-voltage capability, but this is not difficult to do. A low-level trans-Alpine tunnel between France and Italy will link the TGV and ETR-500 networks, making possible comfortable daytime journeys between Paris and SE France

and any northern Italian city. The TGV already works in Switzerland; it is quite feasible for both Italian and French high speed trains to work into each other's territory. The ETR-450 may not play a part in this future high speed cross-border service.

#### TRAINS AND PASSENGERS/DIRECTION/HOUR

Both Sweden and Italy have launched their new tilting train services between the national capital and the second largest city. Service in Sweden is still confined to the this single axial route. Service in Italy is found primarily on the Milano-Roma route, but other lines have been given a taste of new technology. The overall pattern of service in each case shows a primary interest in the business passenger; these are not close-interval early-morning to late-at-night services such as those found on the TGV-SE or the Tokyo-Fukuoka line.

##### *Sweden*

The Swedish service pattern is very simple. Phased introduction beginning in early 1991 (one new train set every two months approximately) has brought five sets into operation in the October 1991 timetable. There are five trips daily in each direction, but the pattern shows a weighting in favor morning travel to Stockholm (three trains at 06.05, 06.25, and 08.00 am). The reverse pattern service is balanced (two morning, one midday, and two evening trains from Stockholm). One train each way, the 06.05 ex-Göteborg, and the return 16.00 from Stockholm, are the fastest, and have no stops other than Stockholm Syd, and are followed in each direction by a train which also calls at Alingsås (70 km. from Göteborg). The trains take 3 hours 25-30 minutes for the journey; the presence or absence of one stop is not significant in the overall journey time (Cook European Timetable, October 1991).

This high speed service is complemented by a strong, surviving, and slower locomotive-hauled service between the two cities, a regular interval service of trains departing at two-hour intervals from each terminus and taking about 1 hour 10 minutes longer overall with typically ten intermediate stops. In October 1991 one non-stop locomotive-hauled train taking 4 hours still remained in service (07.00 from Göteborg, 16.35 from Stockholm), but we can assume it will be replaced by the X-2000 set in the near future. This surviving non-stop traditional train adds further emphasis on the traffic flow into Stockholm in the morning and back in the evening.

The emphasis on business travel of the X-2000 schedule is further confirmed by the six-day-a-week operating pattern. Most strikingly, *only one* train operates on Saturday— a morning Göteborg-Stockholm trip— and four of the five operate from Stockholm to Göteborg on Sundays,



with only two in the opposite direction. The timetable may have an error, or the working imbalance may be covered by non-revenue movement. At a meeting in Stockholm in September 1991, Mr. Bjorn Hamilton, the director of the X-2000 project for SJ, confirmed the marketing thrust towards the business traveller.

### *Italy*

The Italian service pattern began in the same simple way as that of Sweden. The July 1989 timetable shows the original ETR 450 in service between Roma and Milano, non-stop to Roma in the morning and returning in the evening. The train could only be identified by a reference to special fares and reservation costs which include meals.

One year later, in the summer of 1990, the original service had expanded to morning and evening service Roma-Milano and vice-versa, with an extension to Torino, plus both Genova and Venezia-to-Roma trains in the morning, returning in the evening. One curiosity is a non-stop Milano-Roma train in each direction in the evening, suggesting equal weight to the importance of each city. The only daytime round trip left Roma for Venezia in mid-morning, returning in the early afternoon to Roma.

There were two trains a day to Napoli and back, a morning and evening departure from Napoli, but two afternoon departures from Roma. Finally, there was a morning train from Bari, returning in the evening.

The October 1991 Cook timetable shows only a modest addition to the scheduling pattern of 1990. On the northern axial line, there are four arrivals in Roma between 10.15 and 11.45, one each from Venezia, Genova, Milano, and Torino. All four of these call at Firenze, and three of them at Bologna, giving both of those cities an impressive mid-morning service to the capital city. By contrast, Milano has lost service, quantity, and quality, because the Torino departure now bypasses Milano (using the direct line Piacenza-Alessandria), and there is no longer a non-stop train. These four morning arrivals are balanced by four return departures, all leaving between 19.00 and 20.00. It is noteworthy that in order to give a reasonable working day in Roma, all of the departures from the northern cities are between 06.00 and 06.55, and three of the four return trains arrive after midnight at their northern terminus. However, only Milano enjoys an early morning train from Roma, with a corresponding evening return.

The only other addition to the service has been the introduction of an ETR-450 train to Reggio in Calabria, departing at 05.20 and returning from Roma 17.15. This service completed the total pattern of services planned by the original ETR 450 order placed in 1985.

Most of the ETR 450 trains operate seven days a week in spite of the obvious business thrust of the service pattern. We may assume sufficient weekend traffic in either direction which makes it impossible for train-positioning reasons not to offer the complete service.

As is the case in Sweden, the ETR 450 operations are supplemented by a considerable service offered in locomotive-hauled trains. Though the Italian timetable lacks the regularity of the Swedish one, there are trains from Milano to Roma through the day at roughly two-hour intervals and taking five hours with the same two stops (Bologna and Firenze) as the morning and evening ETR 450 trains, which manage the trip in one hour less. Similar patterns exist on other lines served by the ETR 450, though frequency may be less. These locomotive-hauled services also provide through trains over axial links not served by ETR 450 units, notably Milano-Napoli and Torino-Genova-Napoli.

Finally, it should be noted that both SJ and FS charge high supplements for riding these trains. Emphasizing the domestic business marketing of these trains, Eurail pass holders are required to pay these supplements, whereas elsewhere in Europe they are exempt from any supplements other than basic seat reservation fees on those trains where seat reservation is obligatory. The FS trains are also first-class only, a revival of a once-common Italian practice which had been disappearing as the European Community rail systems standardized their accommodation patterns on trains. The supplement in the ETR 450 includes the cost of meal(s) served from airline-type galleys and gangway trolleys (examples in September 1991: SEK 100 (\$18) in first-class one-way Göteborg-Stockholm, on a Sunday; and 35,000 lire (\$32) for a one-way supplement, Roma-Padova, including a light lunch on the morning departure from Roma to Venezia).

Both Sweden and Italy look to domestic air travel as the principal competitor for their high speed trains, and FS has responded by using a rather surprising imitation of airline style in the physical form and services of the ETR 450. The X-2000 is more clearly a passenger train in style and design, but Mr. Bjorn Hamilton, the project director, made it very clear in his presentation that the train would succeed by drawing passengers from the domestic airline routes.

## **TICKET DISTRIBUTION**

Tickets and seat reservations, which are required on all tilting trains in both Italy and Sweden, are bought in the normal way at ticket windows in any station. Both the Swedish and Italian systems have fully computerized ticketing, and outside agents have access to this network also. Neither Sweden or Italy have introduced the self-service ticketing and seat reservation terminals which SNCF has installed at stations served by the TGV.

The supplements charged are high, the ETR 450 is first-class only, the trains are relatively few, and thus neither system needs to deal with the huge number of passengers which pushed SNCF into using a multi-modal system originally for seat reservations, and later for travel ticket purchase. In late September 1991 it was possible to purchase the supplement on board a lightly loaded X-2000 train at Göteborg.

## 2. ENGINEERING

### MOTOR AND POWER SUPPLY

Both the ETR 450 and the X-2000 are electrically powered trains. Electricity is supplied by overhead catenary in both countries as follows:

- On the SJ network the supply is 15kV ac, 16 2/3 Hz single-phase
- On the FS network the supply is 3kV, dc

The Italian power supply is now outmoded, and consideration is being given to raising the voltage to 12kV dc. The electrification of the self-contained FS network on the island of Sardinia is being undertaken at 25kV ac, which is the standard for high speed lines in the core areas of the European Community. Since diversity in voltage still exists among the EC core networks, dual or triple voltage-power vehicles are well developed (in cross-border working between France, Belgium, Germany, the Netherlands, and Switzerland).

The lower bridge and tunnel clearances required for low-voltage dc wiring do make later conversion to high voltage ac wiring relatively costly, the amount of clearance of the overhead loading gauge required being a function of the voltage. This fact may explain the unusual choice of 12kV dc as the future voltage if the electrical system is upgraded. Lower-voltage dc power supply tends to require heavier traction motors for a given tractive effort (drawbar power), or a greater number of axle-driven motors in a multiple unit electric train, which imposes some design constraints as will be noted below.

The Swedish supply at 15kV ac can be handled easily by dual/triple voltage power cars should the X-2000 work across the border in the future, onto the lines of neighboring states (directly into Norway, or later via a bridge/tunnel link to Denmark, and then on to Germany). For now this is not a problem; nor should it be in the foreseeable future.

### Motor Type

The motor layout in each train is fundamentally different. The X-2000 is a fixed-formation train, capable of being lengthened or changed, but in which all motive power is located in the single power car at one end. The ETR 450 is a fixed-formation multiple-unit train whose cars are joined into operating pairs, with each bogie (truck) powered on each car in the pair, effectively two motors per car whatever the length of the train.

The power car of the X-2000 contains four tri-phase asynchronous (see Streeter 1991) motors each rated continuously at 815kW, for a total power output of 3260 kW for the normal train formation of five cars plus the power car (six cars in total). The continuous rating of the two motors per car on the ETR 450 is 675kW. In the five-car version of the ETR 450 the total output is 2700kW, whereas in the 11-car version, the output is 6750kW— in each set, there is one unmotored catering vehicle in the center of the formation. If the five-car ETR had an extra powered vehicle its total rating, at 3325kW, would be virtually identical to that of the X-2000. The 1992 planned order for ten more ETR 450 trains will specify more powerful asynchronous motors to replace the present design (see Figure 4a).

### Motor Layout and Specifications

The power car in the X-2000 has four traction motors, one to each axle. The current is collected from one of two single-arm (Faiveley type) pantographs mounted facing into each other on the power car roof. Power is fed to two identical parallel supply circuits, one to each bogie, and thence to the two traction motors (see Figures 4b and 4c). The parallel paired supply permits the train to continue in the event of failure in one of the circuits.

The power car does *not* tilt. Neither the pantographs nor the motors require any special or unusual methods of installation to compensate for a tilting position. The electrical current collection is faced only with the normal problems of wire/pantograph contact and is essentially a function of the quality of the catenary. Equally the drive shaft connections from motor to axle are standard.

The multiple unit formation of the ETR 450, and the fact that *all cars tilt*, requires special treatment of two problems:

- (a) *pantographs* mounted on tilting cars must always remain in a perpendicular plane over the track center. They cannot be allowed to tilt with the car on which they are installed. The pantograph has to be supported, on both sides of the car, on a flexible triangular frame anchored to car body floor; see the diagram showing the tilting cross-section of the car. This frame must always completely eliminate the tilt created by the tilting mechanism. There is no indication in the literature that they have failed to work completely reliably.

One pantograph is required for each two-car set, power being then distributed by bus line to each motored axle. In theory there are two pantographs in the five-car formation, and five in the 11-car formation— in practice FS seems to have created a non-standard 11-car formation with four pantographs distributed along the center part of the train in adjacent pairs of traction units— see diagram. The pantographs are of the older style diamond frame bi-directional model.

FIGURES 4a, 4b, and 4c

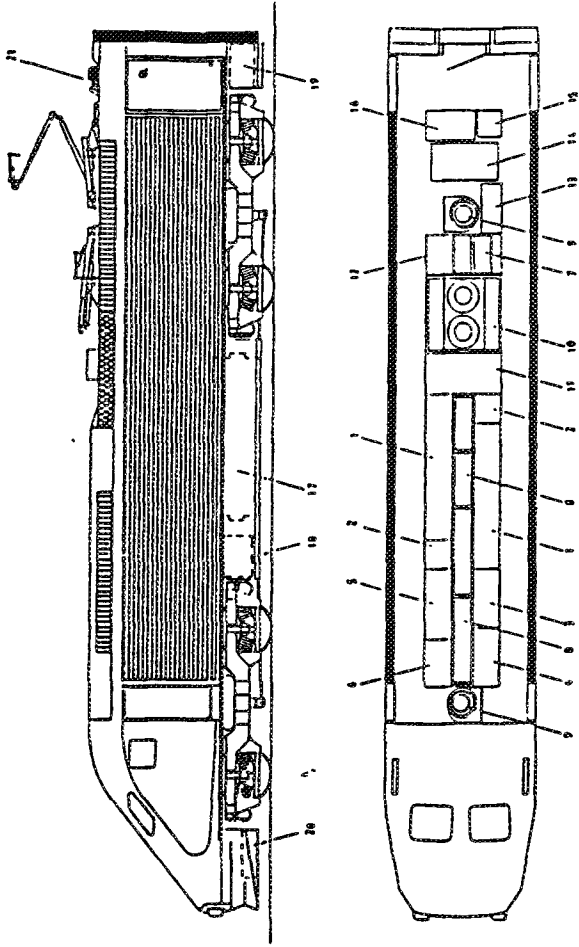
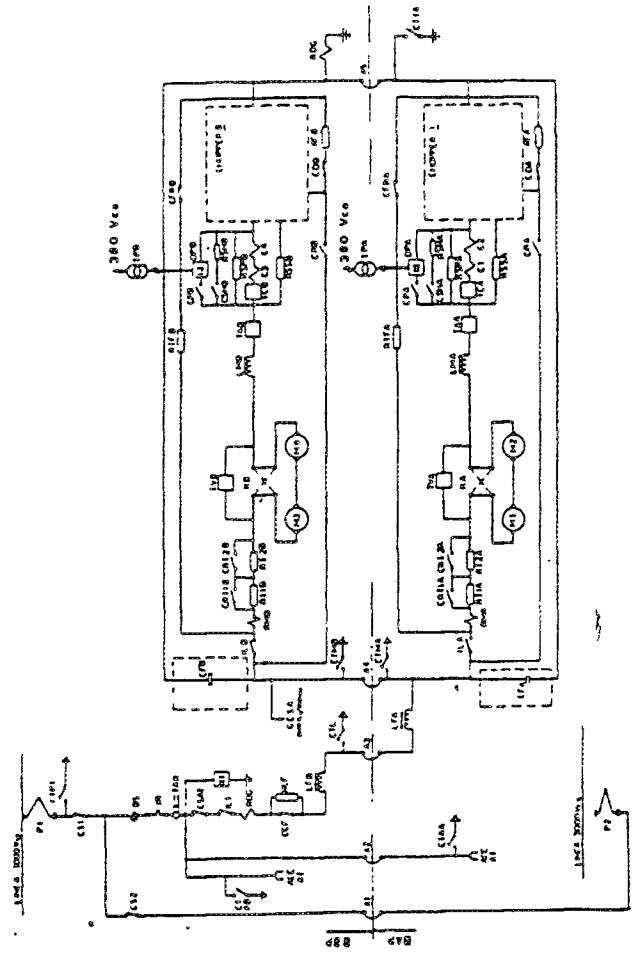
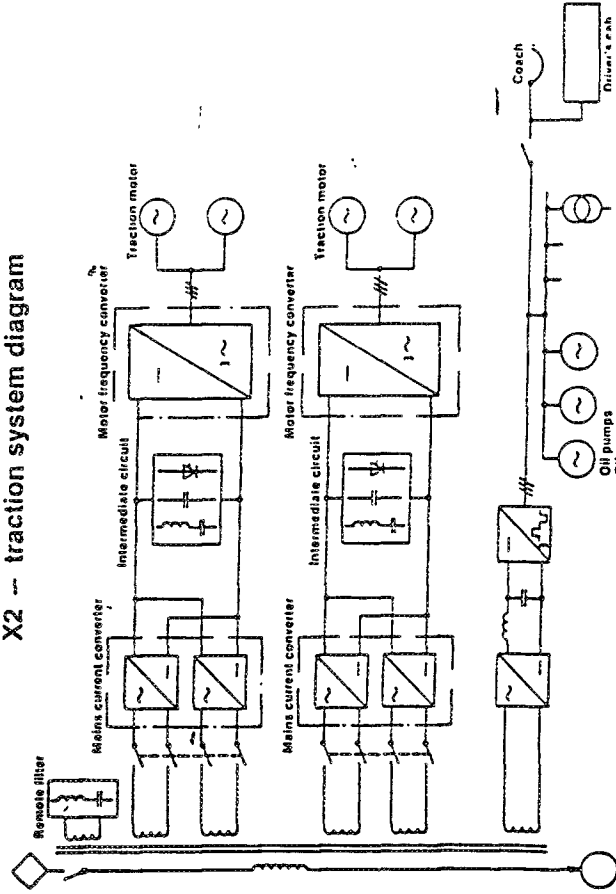

Fig. 4a

- 1. Traction module
- 2. Circuit breaker
- 3. Auxiliary converter
- 4. 380 V equipment housing
- 5. Microprocessor housing
- 6. Auxiliary transformer
- 7. 33 Hz filter
- 8. Intermediate circuit
- 9. Traction motor ventilation
- 10. Oil cooling equipment
- 11. Oil pumps
- 12. Tool case
- 13. Ventilation equipment housing
- 14. Compressor
- 15. Air drier
- 16. Express parcels cabinet
- 17. Main transformer
- 18. Minus filter
- 19. Battery
- 20. ATC antenna
- 21. 15 kV equipment

X2 -- traction system diagram



ETR 450: electric circuit diagram of the traction unit (two power cars)

Fig. 4c

Power is presumably distributed from each or any pantograph through bus lines to all motors. Thus, any one pantograph will probably suffice for current collection — the literature is silent on this point.

- (b) *motors* for each powered axle cannot be mounted on the frame of the bogie but must be mounted on the underside of each carbody. There has to be a flexible drive shaft from the motor to the axle, but since this is required in any fixed motor mounting, the problems are essentially a matter of degree rather than of kind. There is nothing in the literature to suggest that the drive shafts have failed to work reliably. The motors mounted above each bogie are of new electrical design, noted as being a significant improvement over the original Pendolino motors.

Two powered cars, each with one powered axle on each bogie, form a single traction unit. In the event of a failure one power car can be switched out, leaving the other fully operational (see Figures 4a, 4b, and 4c).

## ROLLING STOCK (WAGONS)

The SJ and FS networks are both standard rail gauge (1.435m.) and conform to the UIC standards for European loading gauges. The distinctive external feature of the rolling stock is the slant side to the car bodies, needed to accommodate the loading gauge when the vehicles are tilting. This inward slant is more pronounced on the ETR 450, capable of a 10° tilt, and less marked on the X-2000 cars, which have a 6.5° maximum tilt. Because of this design feature, the cars easily meet the loading gauge standards when operated in normal non-tilt mode.

### Wagon Layout and Specifications

The original Pendolino train was a short-formation unit (see Figures 5a and 5b). The Pendolino's short form reflected in part its origin from the single experimental tilting car, and a past preference of FS in the 1960s and 1970s for shorter lightweight units to be used on premium (usually first-class only) services. Four of the fourteen new ETR 450 sets retain this short form as five-car sets. Both the long and short ETR 450 train sets remain first-class only. These may be the last all-first trains on FS — the high speed ETR 500 trains are being designed for two-class accommodation.

The X-2000 is also a short-formation five-car train set, but with both first- and second-class seating. The train seating capacity was spelled out by SJ in the 1976 specifications for a future high speed train, and they have seen no reason to change this feature of the design since. The train can however be lengthened by running two sets in tandem (as is done by SNCF with TGV sets), or by adding additional vehicles (see Figures 6a and 6b). One extra car is within the

FIGURES 5a, 5b, 6a, and 6b

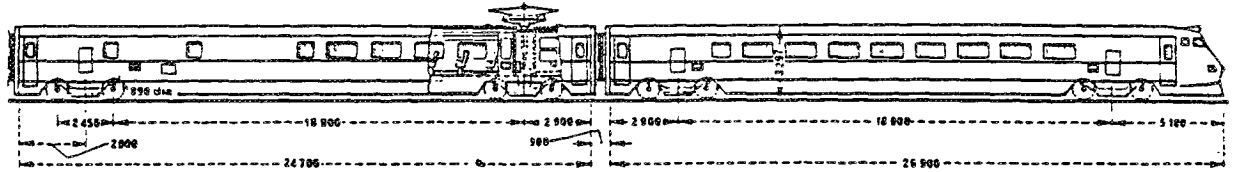

Fig. 5a

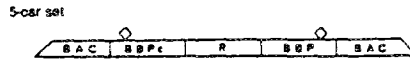
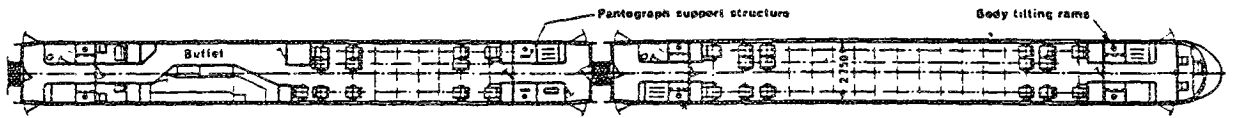
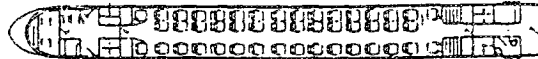

Fig. 5b



BAC type power car  
46 seats



BB, BBP, BA, BAP type power car  
46 seats



BBPc, BBc type power car  
40 seats



R type coach  
23 seats

Fig. 6a

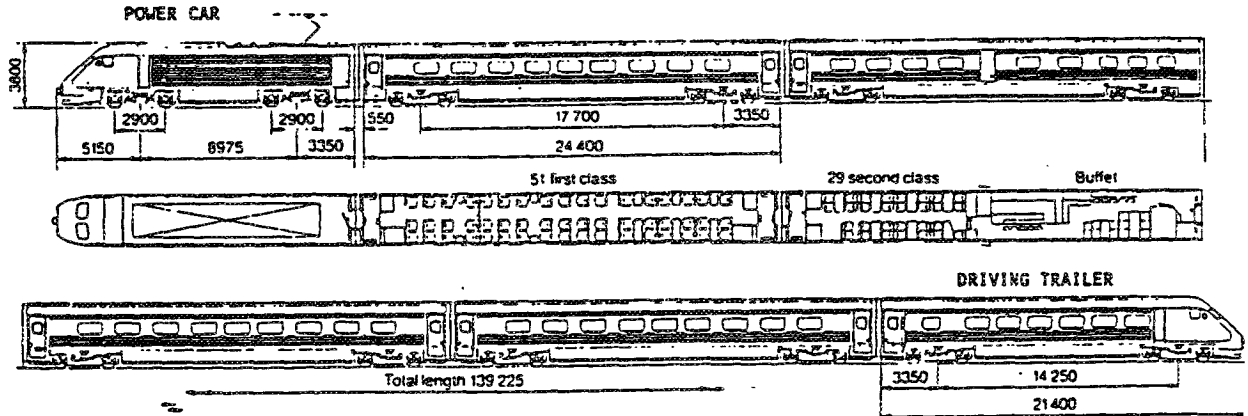
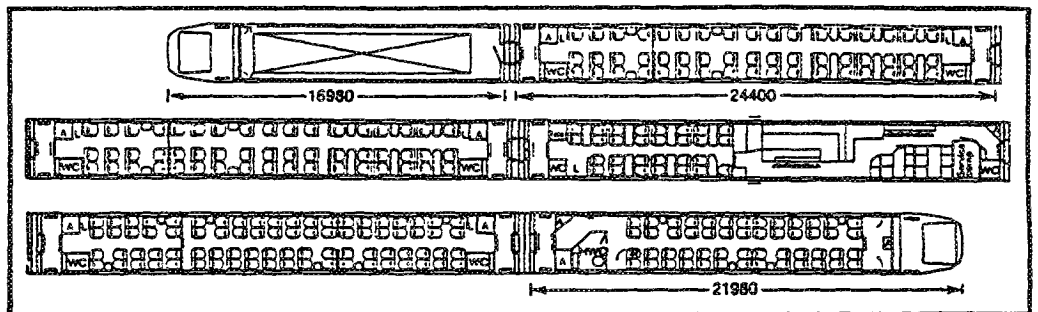

Fig. 6b





capabilities of a single power car; more than one extra car requires a new formation with a second power car at the other end of the train. The X-2000 has been designed to permit either of these possibilities.

### **Weight and Passenger Space**

The passenger cars on both the FS and SJ trains are relatively lightweight vehicles. While they closely resemble classical passenger cars, there are advantages to a lower cross-section profile and a lower center of gravity. The sloping sides needed to conform to the loading gauge means that the cars are widest at waist level — the lower window sill. The car bodies need to be stiffer than normal so that they do not twist longitudinally during tilting. Integral or unit body construction plus stiffening beams or frames are a necessary feature of the car body design.

The lower profile of the ETR 450 cars and the narrower body, plus the use of airline-type cabin luggage racks, gives an aircraft-like tubular interior to the cars. The hydraulic jacks take floor-to-ceiling space at each car end on either side — the resultant corridor access to the car seating area from the vestibule is determined by the space required by the jacks. The higher profile and greater width of the X-2000 cars give a much more spacious, traditional railroad car feel to the interior. The tilting mechanism is underfloor, thus no machinery limits the interior layout of the car.

### *Pendolino and ETR 450 Cars*

The ETR 450 cars have changed little from the original Pendolino ones. The original trailer car bodies are 24.7 m (81 ft) long, with 18.9 m (62 ft) between bogie centers. The loading gauge conforms to the UIC Std. 505; the body height is 3.26 m (11.9 ft), but the specially designed bogies permit a car floor at 1 m (3.3 ft) above rail height, which is at least 30 cm (1 ft) below the normal height.

The weight of the original four-car train was about 156 tonnes empty; given the multiple unit formation and every bogie powered, each car weighed approximately 39 tonnes empty, giving a tare axle load of 10 tonnes. The gross weight and axle load of each car was 42 and 11 tonnes respectively. All subsequent literature indicates that these figures have not changed. Within the 2.75 m (9 ft) interior body width, at the waist level of the lower window edge, the car provided 2+1 first-class seating. There are only 49 seats per standard car. The new ETR 450 cars show a similar restriction in space availability. The standard cars now have 46 seats; one row of three seats has been sacrificed to luggage storage space (see Figure 7c).

FIGURES 7a, 7b, and 7c

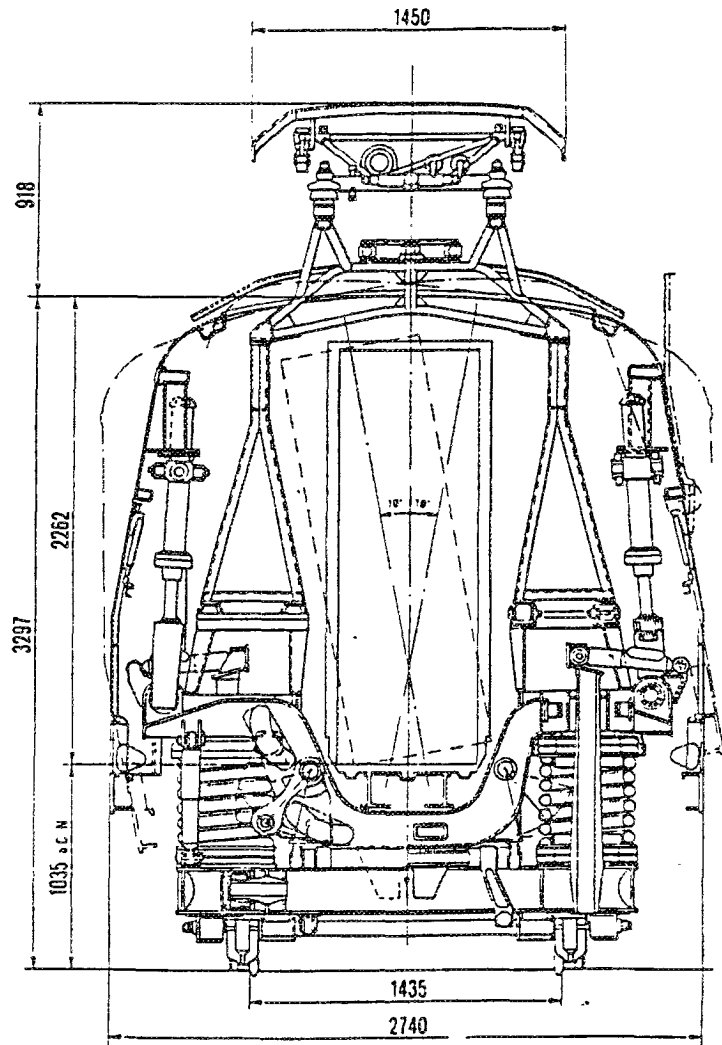
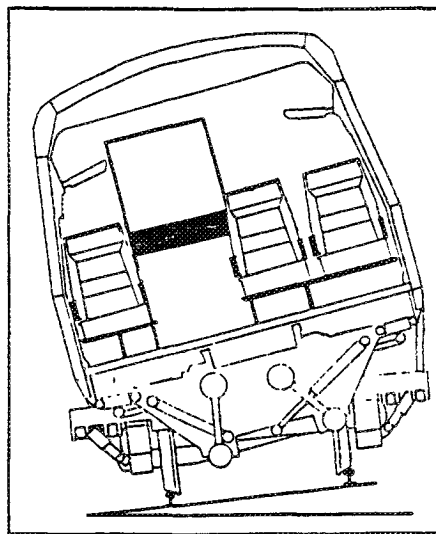

Fig. 7a

CURRENT collector is supported by a structure tied to the swing bolster, avoiding the secondary suspension. Rotation of the body is achieved by a special actuator. The tilting equipment has proved safe and effective.



THE ACTIVE hydraulic tilting system is controlled by accelerometers.

Fig. 7b

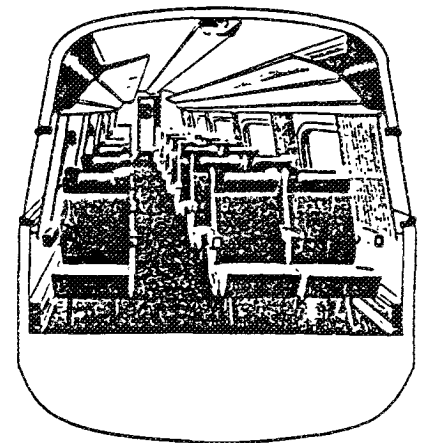

Fig. 7c

This is a relatively low seating capacity for the car lengths, but the hydraulic tilting mechanism centered over the bogies takes up potential seating space. It requires a centered corridor over each bogie which then leads into an off-center central aisle in the open saloon. The space occupied by the tilting mechanism removes a minimum of 12 seats from each car, possibly 16 or 17 with a re-configuration — it is difficult to measure accurately the small-scale diagrams available.

The bodies are integral self-supporting structures in lightweight alloy to which the motors are attached at each end. The ends of the car bodies over the bogies are reinforced with frame rings to withstand the strains imposed by the tilting motion. Within these frame rings are further strengthening frame members to hold the tilting jacks and anchor the car to the bolster (cross beam) across the center of the bogie. Door openings, which would weaken the structural integrity, are placed at the extreme ends of the cars. Window openings are small, double-glazed, and fixed. Each body shell is identical, and the streamlined ends of the driving cars add 1.3 meters to the overall length of a standard car.

The tilting mechanism is illustrated in cross section in the accompanying diagram (see Figure 7a). The specially designed bogie has a lightweight frame with a bolster (U-shaped cross beam) between the axles and resting on two huge coil springs. The low center of the bolster allows the car body to have both a lower than normal floor and a lower overall height. The car body is linked to the bolster by the pair of hydraulic jacks anchored to the top of the bolster and attached to the upper inside of the car body in the area where frame rings reinforce it. The linking system between car body and bolster is designed so that the body center remains over the track center when tilted, and will return by gravity to a centered position in the event of failure of the tilting device (see Figures 7b and 7c).

The large coil springs are coupled with shock absorber dampers to cushion the ride adequately while permitting a linkage which allows the car to tilt up to 10° from the vertical (see Figures 8a, 8b, and 8c). The maximum tilt is limited by stops on the bogie. This 10° is the effective tilt of the car body in contrast to the X-2000 cars, where the effective tilt is less (see next section). The bogies lack the "soft" suspension and self-steering property of the X-2000 car bogies (see next section), although their suspension is "softer" than normal bogie suspension on multiple-unit vehicles. (A new order of ten trains to be placed in 1992 will specify additional pneumatic suspension for the bogie — as a result the suspension may resemble more closely that of the X-2000.)

FIGURES 8a, 8b, and 8c

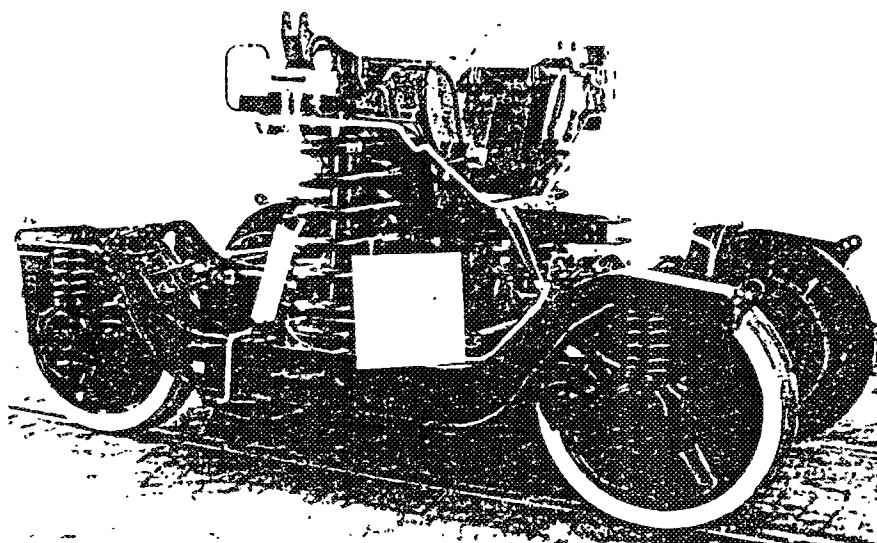

FIAT bogie type Y 0160 was designed for use with the Pendolino trainset.

Fig. 8a

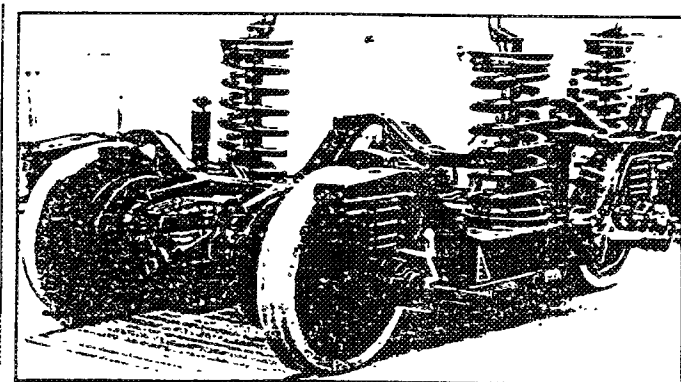

THE bogie for ETR 450 features a bolster beam (right) mounted on two coil springs and connected to the frame through shock absorbers.

Fig. 8b

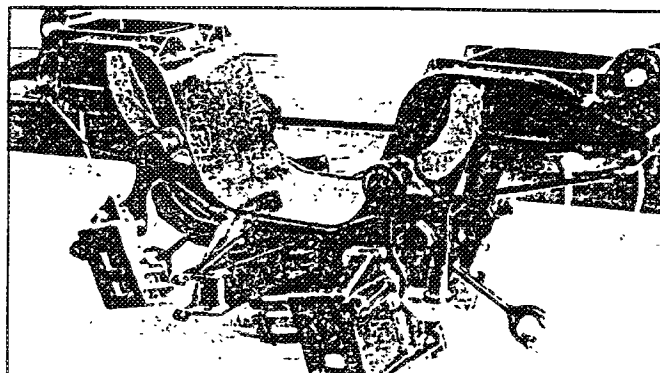

Fig. 8c

### *The X-2000 Passenger Cars*

The standard formation of the X-2000 is six vehicles. The power car has no seating; the other end of the train has a streamlined driving cab terminating a short-length passenger car. In between are three standard trailing cars and a catering car. The end cars are specialized and non-standard in length: the power car is only 16.9 m (55 ft) long and 9.5 m (31 ft) between bogie centers; the driving trailer is 21.9 m (72 ft) long and 14.5 m (48 ft) over bogie centers. The remaining trailing cars are 24.4 m (80 ft) long and 17.7 m (58 ft) over bogie centers. The total train weight is 330 tonnes tare and 340 tonnes gross. No details are available for the distribution of weight by car, but the trailers must weigh less and have a lower axle load than the power car. The maximum axle load is 17.5 tonnes, almost certainly in the power car; there is no specific information on axle loading of the passenger cars (see Figures 6a and 6b).

A simple analysis of the train weight and maximum axle loads suggests that the power car probably weighs close to 70 tonnes, and the remaining five cars roughly 50-55 tonnes apiece, giving an average axle load of 13-14 tonnes. These passenger cars, without motors, are heavier than the ETR vehicles, which reflects in combination their greater size and the use of steel rather than alloy in their construction.

The car bodies are built on stainless steel frames with stainless steel panels, to which extra steel beams are welded for stiffness. The external dimensions conform to loading gauge in UIC leaflet no. 566. The cars are 3.8 m (12.5 ft) high and 3.08 m (10.1 ft) wide at the waist height (lower window sill). The floor level is 1.3m (4.3 ft) above rail level. All window openings are 60 cm (2 ft) high and 1.3m (4.5 ft) long, higher and wider than the ETR 450, and are standardized throughout the passenger cars. The first-class seating is organized in the same way, with 2+1 seating in open saloons, and 51 seats per car. The second-class seating in separate vehicles is 2+2 in open saloons, with 76 seats per car.

The bogies are as new and distinctive as those used on the ETR 450. Two sets of bolsters are linked to provide the tilting mechanism; the top bolster sits across the bogie in the normal way, the lower bolster is linked to the upper by four pendulum links and to the car by hydraulic jacks (see Figure 9). Tilting is effected by hydraulic jacks, with the four links designed to ensure the correct tilted position. The maximum tilt created by the hydraulic jacks is 8°, but the centrifugal forces acting upon the bogie cause it to tilt 1° outwards from the center of the curve, and the same force acting upon the car body adds 1/2° more. Thus the effective maximum tilt is 6.5°. (The absence of a pendulum link mechanism on the ETR 450 cars, and the heavy coil springs supporting the bolster, mean that the tilt created by the jacks is equal to the effective tilt of the car body.)

FIGURE 9

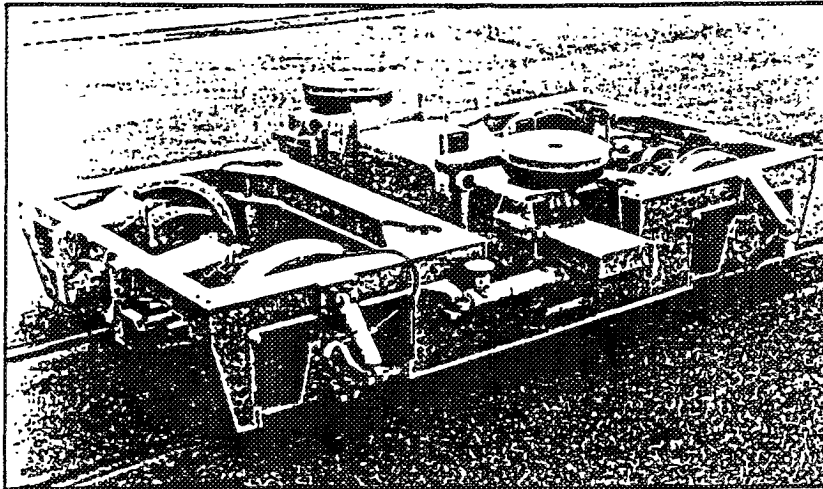

**RADIAL-STEERING** of the bogies is achieved by utilising the interaction between the conicity of the wheels and longitudinal creep forces. On the trailer bogie (left) two bolster beams are fired to allow tilting.

The bogies have a new, distinctive and important design feature: "soft" longitudinal rubber suspensions, which permit the axles to be "self-steering" in curves so that the axle aligns itself with the radius of the curve (see Figure 10). This feature is shown in exaggerated form in the accompanying diagrams (see Figures 11a, 11b, 11c, and 11d). This feature reduces wheel and rail wear significantly. The primary rubber suspension is supplemented by pneumatic air suspension (this will be used on the next order of ETR 450 trains).\*\*

As with the Pendolino, the car center must remain over the track center and return to a vertical position when tilting is inactive. Other than the stiffening mentioned above, the cars do not have the ring frames required at each end of the ETR 450 cars because the tilting mechanism is located entirely below-floor. Thus no space is lost to tilting equipment and there are no constraints on the positioning or size of the access doors or internal corridors.<sup>1</sup>

## TRACKS

Both the FS and SJ operate on the standard gauge, 1.435 m (4'8-1/2"), and conform to the European (UIC) standard loading gauge. FS interconnects on this gauge at its borders with the French, Swiss, Austrian, and Slovenian railways— SJ currently has cross-border same-gauge links with the Norwegian railways, and a break of gauge with the 1.52m (5 ft) gauge railways of Finland. Before the end of the century, SJ may be linked with Denmark and Germany via proposed bridge-tunnels across the øresund and the Great Belt (IRJ, Feb. 87: 16-18).

The rail types, layout, and specifications are not specific to the tilting trains, which are designed to operate over normal tracks. FS has begun to install "slab track" on major new sections of lines where improvements deviate markedly from the original alignment. Instead of traditional ballasting, slabs of interlocking prefabricated concrete panels are laid on the earth foundation and cement-asphalt injected beneath the slabs to provide elasticity. The technology comes from Japan; it costs three times as much to install initially, but lasts longer, lowers maintenance costs, and prolongs track bed life. Slab track lowers track height by 30 cm (1 ft) in tunnels and thus permits electrification without major civil engineering work (IRJ, Dec. 87: 32).

### Upgraded and New Track, Switches

The purpose in adopting tilting technology is to avoid building new lines and to minimize the costs of upgrading. Some upgrading can hardly be avoided if the tilting trains are to be exploited

---

<sup>1</sup>Most of the technical material in this section is taken from: Cardini, E., et al., 1988; Alexandersson, Jan, 1991; Dover, Robert, et al., 1990.

FIGURE 10

X2 – microprocessor structure

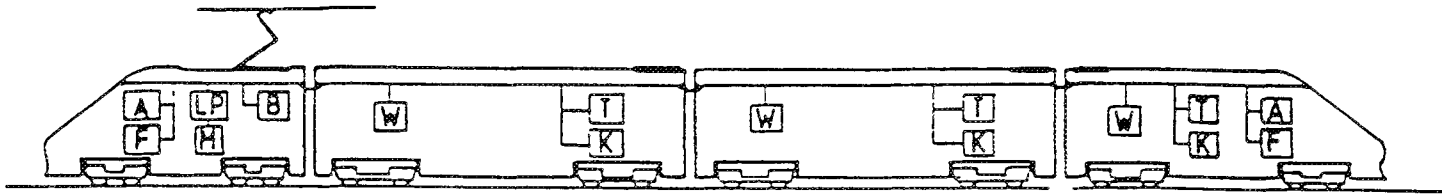

- |   |  |                                       |
|---|--|---------------------------------------|
| LP = master processor                   | B = brake/air supply control processor | K = air-conditioning system processor |
| M = modulator/power converter processor | W = coach processor                    | A = display screen                    |
| F = driver's cab processor              | T = door control processor             |                                       |

X2 – vehicle body tilt control system

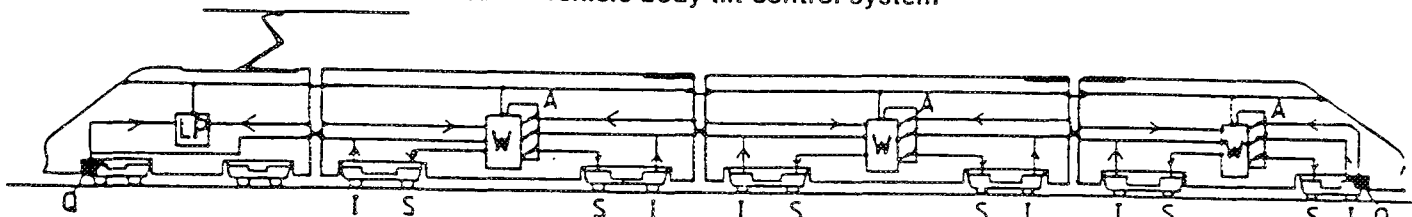

- |   |                           |
|---|---------------------------|
| Q = accelerometer (transverse acceleration) | A = analog control system |
| LP = master processor                       | S = theoretical value     |
| W = coach processor                         | I = actual value          |

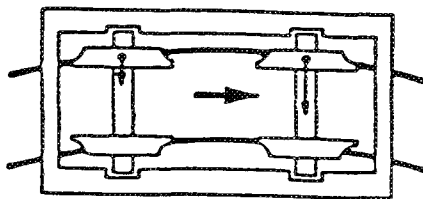

Rigid wheelset steering  
("Rigid" bogie)

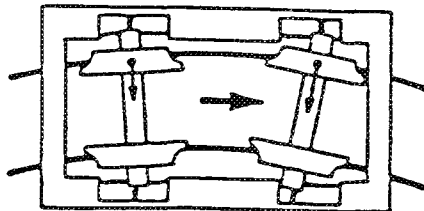

Soft wheelset steering  
("Soft" bogie)

Principles of "rigid" and "soft" bogies

X2 – intermediate trailer car vehicle body

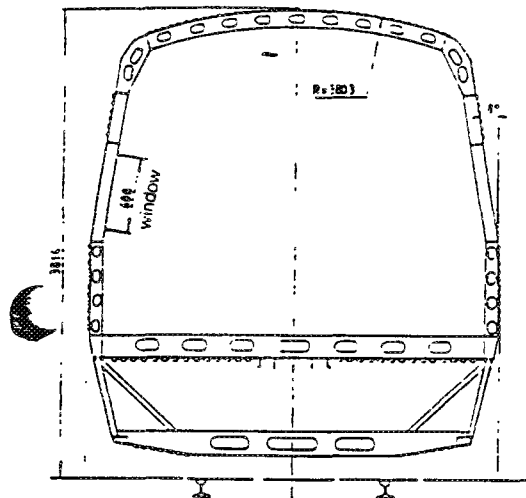



FIGURES 11a, 11b, and 11c

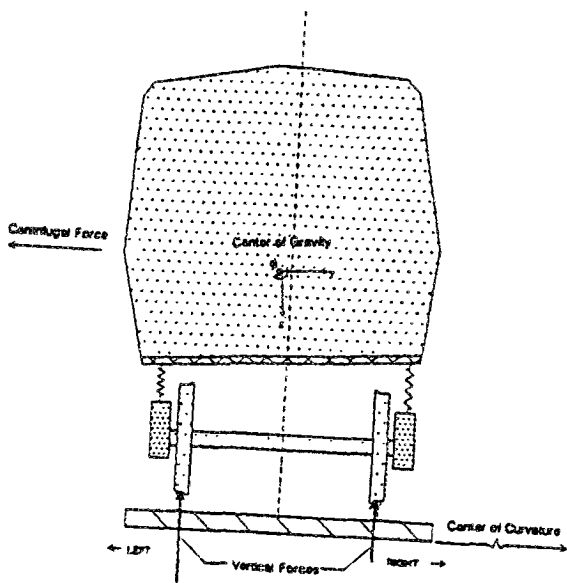

Fig. 11a

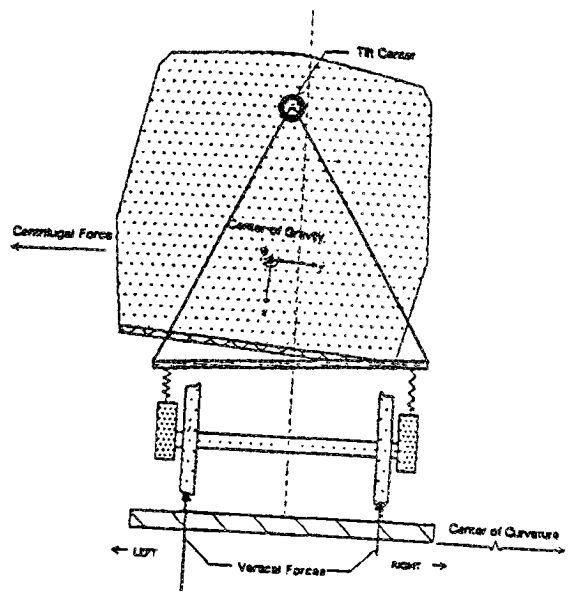

Fig. 11b

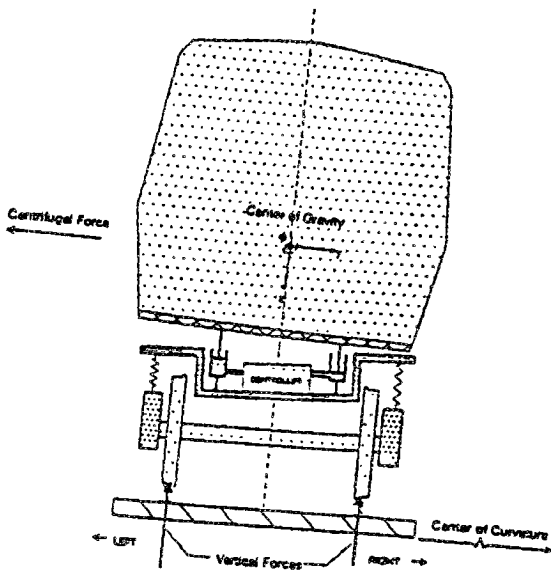

Fig. 11c

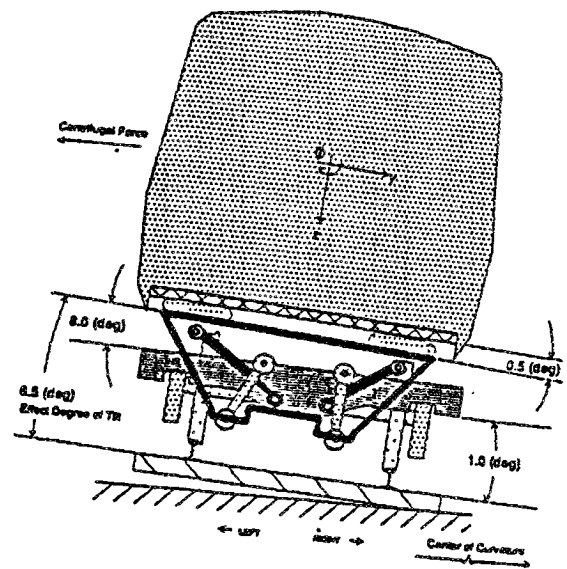

Fig. 11d

to their full potential. The upgrading includes both track work and ancillary improvements primarily in signalling, train control, and elimination of grade crossings.

In Italy many of the principal routes had long single-track sections until very recently. Where full double-track routes existed throughout, as from Milano to Roma, the lines were often slow and difficult to work and had reached capacity. Track investment in Italy has essentially been directed to upgrading line capacity: the building of the Direttissima has always been identified as quadrupling a saturated double-track route even if the new line has vastly different characteristics than the old.

Even more important, because it is so basic to improving speed and capacity, is the doubling of single track. An amazing amount of single track on heavily used lines remained in Italy into the 1980s: examples include the east and west coast mainlines, particularly in the south, plus important cross links like some trans-Appennine routes or the Bologna-Verona connection. Only with these improvements can the full potential of the ETR 450 be reached on those lines where it is now used or will be transferred after the high speed lines are in use. Although these track improvements were not made with the ETR 450 in mind, they are essential to its rational exploitation (IRJ, Dec. 87: 22-23, 29-30).

In Sweden, the main axial routes Stockholm-Göteborg and Stockholm-Malmö are already double-track, though there is extensive single-track elsewhere on lines which may ultimately profit from tilting train operation, notably the West Coast mainline Malmö-Göteborg, upon which work has already started. Lines west (to Oslo) and north from Stockholm may later benefit from track doubling. The most important improvements are needed in the greater Stockholm area. The biggest and most expensive of these is the Grödinge line, replacing the last 30 km. from Södertälje to Stockholm with a brand-new line, which will release the present line for commuter traffic. It will be completed in 1994 and will benefit directly the present X-2000 trains to Göteborg and future ones to Malmö by lopping 15-20 minutes off their overall journey times, even though it is clearly a multi-purpose improvement.

### **Seismics**

Seismic activity is not a measurable risk in Sweden -- no precautions are taken against the threat of earthquakes. On the contrary, earthquakes and volcanic activity pose real threats in all parts of Italy, with real risks in the southern half. There appear to be no quickly found references to any special monitoring programs or control devices to deal with this issue on Italian railways, but such programs and devices may exist.

## CONTROL SYSTEMS

NOTA: On 1 Jan. 1989, a new state agency, Banverket (the Track Administration), took over ownership of the Swedish rail infrastructure. SJ became a purely train-operating agency, paying rent to Banverket for the right to operate trains. Right of way and signalling were agreed at once as belonging to Banverket; electricity supply is now theirs, but stations/buildings were in dispute. SJ, although operating the X-2000 trains, now has no direct control over the needed infrastructure investment in track work, new lines, new signalling, and so on. The text below is written as though SJ is still responsible; over the next few years their present long-term plans will normally be honored by Banverket. SJ still owns the rolling stock. (See *Appendix*.)

While the status of FS has been changed from government department to autonomous entity during the 1980s, its control over infrastructure investment has evolved from being entirely at the mercy of the Italian Parliament, to a greater degree of independence under long-term programs initially underwritten by the government. The 1990s are expected to see more and more private capital in infrastructure investment through joint ventures. (See *Appendix*.)

### Central Control

Control systems — signalling, centralized traffic control, automatic train control— are all in need of improvement if the potential of the tilting train is to be fully exploited. Much of the infrastructure money is being spent on new and more sophisticated forms of train control.

The series of investment plans of FS beginning in the early 1980s have placed much emphasis on improved train control. In the first investment plan of the 1980s, the long-term objective was to provide automatic block signalling with repeater signals in the cabs for all lines worked at over 150 km/h (95 mi/h). The combined effect of high speed and safe braking distance (the higher the speed the longer the braking distance) required either more powerful brakes on the trains or longer braking distances which the block signalling system was not equipped to handle. At very high speeds, maximum acceptable rates of deceleration place a limit on the minimum braking distance. The specifics of braking rates and distances are discussed in the section below.

Operating the original Pendolino trains over the new Direttissima was limited by the constraints of the signalling system in the late 1970s and early 1980s. FS plans to install automatic block working/train control (ATC) on 1,800 km. (1,100 mi.) of track (this would seem equal to the total planned high speed mileage) and CTC (centralized train control) on a further 2,000 km. (1,200 mi.) All automatic block-controlled sections are to be signalled for bi-directional working.

In addition, track-train radio is being introduced on arterial lines, and cab signalling is proposed for lines beyond the automatic block network. All of these improvements should improve significantly the operation of ETR 450 trains.

Likewise, SJ has developed since 1978 a series of computer-controlled signalling systems, the pioneer work being installed at Göteborg. In 1986 the first mainline control system was installed at Hallsberg, about halfway between Stockholm and Göteborg (RGI, Jan. 86: 37-38). All the later investment plans of the new rail authority, Banverket, include money for ATC and CTC installations on main lines (RGI, Feb. 91: 75-6).

## **Vehicular Control Systems**

### *Basics of the Tilting Mechanism*

A totally reliable car-tilting control system is the key to the development of a successful tilting train. The control systems must work accurately to split-second timing. A central computer processor unit in the lead car and linked to slave units in each car of the train provides the brain and central nervous network. The central computer transmits instructions to the slaves to activate the tilting jacks quickly and exactly. Both ETR 450 and X-2000 now use similar master computer systems for processing and transmitting information, but the original Pendolino had separate information-processing computers in each car.

The information sent to the tilting jacks is obtained initially from an accelerometer installed on the leading car of the train. Essentially the accelerometer measures the lateral thrust (lateral acceleration) of the lead car as it enters a curve. The lateral thrust is measured in meters/per second/per second. It is simple in principle, but complex in practice to get a correct reading, because the train sways from side to side in normal motion. These endless minor variations need to be eliminated before the computer can send workable information to the slave computers.

The information from the accelerometers is deficient if the transition curves are super-elevated. To measure train movement out of the vertical, the ETR 450 uses information from a gyroscope to supplement that from the accelerometer. The X-2000 control system works without the supplementary gyroscope (see Figures 12a, 12b, and 12c).

The computers have to be programmed to activate the jacks promptly, with delays of only a fraction of a second, and to apply the correct amount of tilt in order to nullify the lateral thrust. The tilt is required solely for passenger comfort. The average passenger's tolerance of lateral acceleration is limited. Thus the system works within tight parameters and a minor malfunction can lead

FIGURES 12a, 12b, and 12c

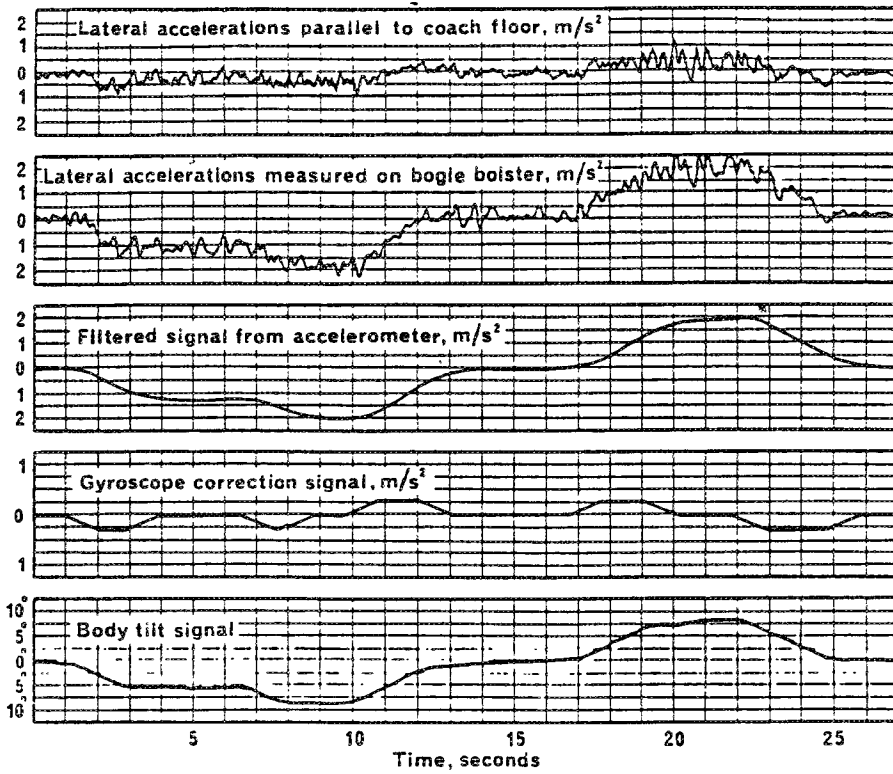
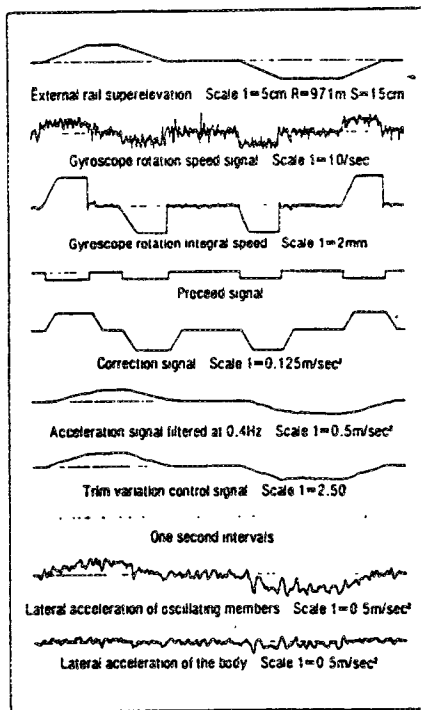

Fig. 12a



CRITICAL problems were encountered on curve radii from 1200m. Entry into the transition was achieved by use of a gyroscope.

Fig. 12b

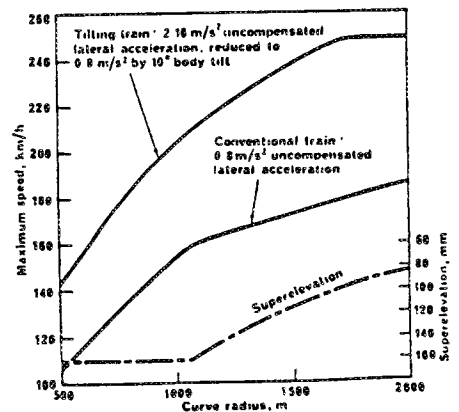

Fig. 12c

to significant passenger discomfort — the history of British Rail's APT is a poignant reminder of this fact. The trains themselves can safely withstand a substantial lateral acceleration— a car with no passengers does not need to tilt. The X-2000 power car does not tilt; it has only a seated driver when it is the lead car.

### *Tolerances of the Passengers*

FS has determined that normal passenger tolerance of lateral acceleration is 0.8 m/per sec/per sec. For example, this is the lateral acceleration produced on a 450-meter-radius curve taken at 100 km/h. Train speed through such a curve can safely be raised to 135 km/h, but the lateral acceleration increases rapidly to 2.15 m/per sec/per sec. A tilt of 9° will reduce this lateral acceleration back down to the acceptable 0.8 m/per sec/per sec. Work with high speed trains has suggested that passengers may tolerate greater levels of lateral acceleration in cars with a better ride (higher-quality suspension)

This relationship holds roughly true for a wide range of curve radii and speeds— thus the general assumption that tilting a car body to about 8° permits a 30+ percent increase in running speed. The pattern of curves and grades on any individual line will lead to wide variation in this relationship.

There are no similar numerical values given for track in Sweden, but we may assume that same principles apply. SJ assumes a similar average 30+ percent percentage speed increase with only a 6.5° tilt, a fact which may reflect the apparently less severe grades and curves in Sweden when compared to those of Italy.

Passengers must not be subjected, even momentarily, to excessive lateral acceleration. It is therefore important that tilting begin immediately a train enters a curve. SJ has determined that the maximum acceptable tilt speed is 4° per second, from which it follows that the train may reach its maximum tilt position in under two seconds. At 200 km/h it will have travelled under less than 100 meters in that time (speed is 55 meters per second at 200 km/h). If the tilting mechanism response to a lateral acceleration is immediate, the train will tilt sufficiently fast to cause no discomfort to passengers. However, an immediate response of the tilting device is not readily obtainable, as we note below.

### *Control of the Tilting Mechanism in Transit*

In sum, the technical problem then resolves itself into:

- (a) an accurate reading of the lateral acceleration, followed by
- (b) almost instantaneous transmission of the information to the tilting jacks, and
- (c) fast and accurate action of the jacks to tilt the cars to the correct position.

The accurate reading of the lateral acceleration is difficult. The normal swaying of the train, the yaw, produces endless minor and constantly changing irregular patterns of lateral acceleration. The motors of the ETR 450 were attached to the underside of the car bodies, rather than directly to the bogies, to avoid the common problem of lateral oscillations of the car bodies which typically result from direct-drive axle-suspended motors. More lateral oscillations would have further complicated the accurate reading of lateral acceleration. Putting the motors in a power car on the X-2000 minimizes this problem, but design problems with some heavy power cars may lead to pounding and track damage at high speed.

The accelerometer information has to be filtered so that only constant lateral thrust in one direction is noted. On the ETR 450 the filter causes a one-second delay in system response. The train travels 50 m. in one second at 180 km/h. On short and reverse curves the train is well into the curve, therefore, before any response occurs. Furthermore, on the entrance to super-elevated transition curves the accelerometer does not detect any lateral acceleration because initially there is none; the low cant eliminates it (see Figure 12b).

For these reasons the ETR 450 is equipped with a gyroscope on the lead cars to detect train movement out of a horizontal plane when the first car enters a transition curve, and before any lateral acceleration can be felt. This information will be immediately fed to the computer. The signal to tilt the car bodies will now be given only 0.1 second after the lead car enters the curve, i.e. in less than 10 meters of forward travel, or under half a car length. The sensitivity of the gyroscope is set to ignore the first 10 mm. of cant (super-elevation). Normal track may depart from the horizontal by up to this amount. To read these minute variations would then defeat the purpose of the gyroscope.

There is no indication of how the problem of cant and transition curves is resolved on the X-2000 without a gyroscope, but a shorter filtered delay in response time is the most likely explanation. However, one very minor peculiarity does result from this sole reliance on accelerometers on the X-2000. When the driving trailer is leading, the split-second delay in response to lateral acceleration will cause standing passengers in that car momentarily to feel the centrifugal force.

Seated passengers are not normally affected. When the power car (which does not tilt and has no passengers) is leading, this problem does not arise.

The values transmitted to the tilting mechanism then have to be smoothed and dampened so that the jacks work in a fast but smooth consistent fashion. Computer-controlled mechanisms capable of the required level of accuracy were perfected in the extensive running trials by Fiat and FS, and by ASEA in Sweden in the 1970s and early 1980s. The length of the trial period testifies to the difficulty of achieving the precision required.

In sum, the accelerometers (with or without the aid of a gyroscope) measure both the amount of lateral acceleration and the speed of the train at the lead car and process this information through a master computer before transmitting it to the slave computers in each car. There it is verified and corrected for both speed and lateral acceleration of the individual cars (read by a speedometer and accelerometer on each car) before being used to determine the rate and degree of tilt.

As a further refinement, on the X-2000 each slave computer can communicate with the adjacent slave units in the adjoining cars. This electronic interconnection permits the tilting mechanisms continually to monitor themselves for consistent operation with their neighbors, and the car will still tilt correctly even if its slave loses direct contact with the master computer. The tilting mechanism on the X-2000 is inactive at speeds below 70 km/h (40 mi/h). (There is no mention of a similar lower limit on the ETR 450.)

### *The Train Braking System*

Both the ETR 450 and the X-2000 use the modern tri-modal braking format for fast electric trains:

- (a) regenerative braking (dynamic, rheostatic) in which the motors are used as generators (dynamos) and return current to the catenary.
- (b) air or pneumatic (electro-pneumatic) disc braking in which air pressure applies disc pads to wheel rims or to separate axle mounted discs.
- (c) electro-magnetic braking applied directly to the rails and for emergency use only.

Regenerative and disc braking are the primary and normal means of stopping the trains. The multiple-unit formation of the ETR 450 makes regenerative braking the normal means of controlling train speed in motion and decelerating to low speed, with the air brake used for the final stop. The air brake applies synthetic shoes to two iron discs on each axle. The entire braking system is integrated through a single electric control device.



The X-2000 has regenerative braking available only on the power car, and thus a "blended" application (both air and regenerative) of the brakes is the normal method of slowing or stopping, but the driver can choose air braking only. The "blended" control automatically chooses the best mix of regenerative and air applications. Both braking system options of the X-2000 were described as "extremely smooth" and effective in operation in the 1990 US Railroad Administration Report (Dorer, 1990). No mention is made of the braking qualities for the ETR 450 in any source.

On both systems the electro-magnetic system is applied only in emergencies.

### **Station Control Systems**

Although the tilting trains operate on existing track, the higher running speeds usually require significant improvements in signalling. Modern signalling has become more and more centralized and computer-controlled and has been discussed previously in this paper. In addition to preventing collisions between trains, the signalling system also controls train movements in and around stations, and this has also historically included the control of grade crossings. Stations, with their complex trackwork, local train movements, and rail personnel, are major potential sources of danger and accident. They frequently impose speed limits on the transit of non-stop trains, or the trains are exposed to dangers in a high speed transit.

In short, for effective high speed operations, major reconstruction of station areas may be very desirable. The FS Direttissima line, by avoiding all stations and providing frequent interconnections from the old to the new line in the vicinity of stations (as noted in the introduction) deals most effectively at great cost with the problem. But much of the infrastructure investment needed to support a new tilting train service must essentially look to rebuilding station areas, separating high speed from local lines, preventing direct pedestrian access to the high speed tracks, and even building short stretches of station-avoiding lines if necessary. Few of the references identify specific work in these areas, but all refer to the need for such investment.

Perhaps the gravest potential source of danger lies in grade crossings, whether located near stations or in open country. A fully safe, custom-designed, new, dedicated high speed line has no grade crossings. Heavily used older lines in dense traffic areas have frequently seen their significant reduction in number if not total disappearance. More lightly used main lines, or trunk routes built in poorer regions, unfortunately still have many grade crossings. FS and SJ recognize a serious problem in this respect.

SJ will reduce the number of grade crossings between Stockholm and Göteborg from 300 to 100, and the surviving 100 will all be equipped with automatic barriers controlled by the ATC system. The busiest of these crossings will be equipped with automatic detectors to stop a train if a road vehicle is trapped between the barriers. Traffic volume to qualify for this second level of protection is not defined. The total number of crossings between the two cities still averages 1 per 4.5 km; prior to this modernization it was an unacceptable 1 crossing per 1.5 km. (1 per mi.). Nowhere do the sources tell us if the 200 abolished crossings were simply closed off because they were the least used (the most likely explanation), or whether they were the busiest and were replaced by bridges (less likely). However, 100 grade crossings remaining on a 450 km route seems a high and possibly risky number.

In 1983 FS launched a ten-year program, costing 350 bn lire (\$320 mn), to eliminate grade crossings, of which 2,500 had been removed by late 1985 (RGI, Dec.: 85). The removal of such a large number in such a short time suggests the closed crossings were essentially minor, but none the less potentially dangerous if on busy lines. By definition, all new direttissima lines do not have any, and they are almost certainly eliminated on the numerous single-track doubling projects noted above. There are no other references to the use of CTC or ATC control of crossings similar to the changes made by SJ.

### 3. PERFORMANCE

#### VEHICLE (TRAIN)

##### Maximum Speed (Acceleration/Deceleration)

##### *Acceleration and Speed*

The ETR 450 was designed to operate at a maximum speed of 250 km/h long before any track on FS was capable of supporting such a speed. The new Roma-Firenze direttissima was designed to be travelled at 250 km/h, and until the newer ETR 500 trains enter service, the ETR 450 is the only train capable of exploiting the maximum speed of this line. The multiple unit design of the ETR 450 with motors suspended from the car bodies permits higher speeds without track damage. Direct-drive motors attached to the bogies (typical of multiple unit suburban train sets) exert forces which lead to "hunting" (excessive lateral oscillations) which damages the track at high speed. Similarly, the design of some heavy electrical locomotives also leads to pounding of the track at high speed; locomotive-hauled trains were initially restricted to 180 km/h on the Direttissima for this reason.

In 1988, FS decided to increase the planned maximum operating speed of its future direttissima lines (Milano-Bologna, Roma-Battipaglia) to 300 km/h. The ETR 450 trains will remain limited to 250 km/h and thus will be eclipsed by the ETR 500 trains which should enter service at 300 km/h some time in 1992. Although the longer 11-car ETR 450 carries as many as four pantographs, the issue of stress on the catenary on older lines has not been discussed (see below for the SJ problem in this respect). The Direttissima was presumably constructed with a much stronger catenary.

The X-2000 was originally designed for a maximum operating speed of 210 km/h and a normal maximum line speed of 200 km/h. As with the ETR 450, little of the existing track is capable of exploitation at 200 km/h, and until improvements are made, much of the Göteborg line service will be just below this speed. At present most service is run with a single six-car set drawing power from one pantograph, and an expanded set with a power car at each end could still be supplied from one pantograph. But two independent sets running in multiple and requiring two pantographs are limited to 180 km/h until the catenary is strengthened. There is no mention in the literature of track damage at high speed as a result of the pounding which may come from a heavy power car or independent locomotive, and which therefore would lead to an imposed speed limit.

The X-2000 has been recently (1991) test-operated in Germany at 250 km/h on the new Hannover-Würzburg (Neubaustrecken) line, and is evidently capable of running regularly at this speed on high-quality permanent way (IRJ, Oct. 91: 10).

Very rapid acceleration is not an important consideration for either tilting train. Most station starts require a lengthy traverse of congested track before high line speeds are possible. Thus, no special mention is made of acceleration capability. Traditionally the multiple-unit format of the ETR 450 with motors on every bogie or every axle has been used for commuter electric trains because it maximizes the rate of acceleration and deceleration for any given rate of installed power. The X-2000 accelerates to the following speeds over the following distances (presumably from a standing start and on level track):

|             |                   |            |
|-------------|-------------------|------------|
| to 130 km/h | in 1 min. 41 sec  | at 1.95 km |
| to 160 km/h | in 2 min. 19 sec. | at 3.5 km  |
| to 200 km/h | in 3 min. 49 sec. | at 8.05 km |

#### *Deceleration and Braking Distances*

Rate of deceleration is important. Although trains running at high speeds (over 200 km/h) can be brought to a halt in a short distance (and in an emergency this may be necessary), the rate of deceleration is a function of train weight, application of braking power, and acceptable rate of deceleration for passengers. The Pendolino was designed with this factors in mind (lightweight, multiple-unit formation).

Braking distance up to a stop signal in Italy was 1.2 km in the mid-1970s, which required a high level of braking power at a speed of 180 km/h. Braking distances have since been increased to 2.7 km, which permits a train travelling at 250 km/h to stop at an average rate of deceleration of 1 m/per sec/per sec — a rate within tolerable limits for passengers.

The X-2000 travelling at 200 km/h has a specification braking distance of 1.75 km, but can stop in 1.45 km in normal service and in 1.1 km in an emergency. There are shorter measured braking distances in each of these categories for lower speeds: e.g. at a speed of 160 km/h the specification braking distance is 1.1 km and the normal service distance is 0.95 km.

As braking distance increases exponentially as a function of speed, it can be stated that the FS and SJ deceleration rates and braking distances are virtually identical.

### **Maximum Grades**

The main lines of the FS network fall into three broad groups:

- (a) Flat-land lines in the lowland north with very low ruling grades, and for which no problems exist. Normal ruling grades are under 1 per cent.
- (b) Trans-Appennine lines, both tortuous and with steep grades, for which the ETR 450 should provide distinct advantages, and on one of which (Orte-Ancona) the Pendolino was extensively tested. These lines will remain as they currently are, with the exception of the new Firenze-Bologna direttissima which, like its 1930s predecessor, will require even longer tunnels to keep the ruling grade down.
- (c) Coastal or hill-country lines in the peninsula, in which short steep grades may be a problem. Sinuous routes are a much more serious problem, and ruling curves rather than ruling grades are the principal issue.

FS does not have a ruling grade for operations of the ETR 450. The new direttissima lines will have a ruling grade dependent upon the maximum permitted speed:

- (a) Roma-Firenze Direttissima: (250 km/h); 0.85 percent open track; 0.75 percent in tunnel.
- (b) All future direttissime: (250 & 300 km/h); 1.8 percent open track; 1.5 percent in tunnel.<sup>2</sup>

SJ operates for the most part in low but often rugged terrain. The current ruling grade on the SJ main lines is a relatively low 1.8 percent. There are no plans to change this in the future.

### **Maximum Speed/Grade/Distance**

No particular constraints exist with respect to the combined impact of these three factors on either FS or SJ.

### **Energy Use**

There are no references to energy use, which presumably indicate that it is appropriate for the speeds and train weights on both FS and SJ networks.

### **Minimum Curve Radius**

Because the tilting trains are designed to operate on tight curves at a higher speed, there is no ruling minimum curve in normal operation. Some gains accrue from removing very tight curves

---

<sup>2</sup>300 km/h lines will have larger minimum-curve radius than 250 km/h lines.

—the example of uncompensated lateral acceleration for a curve of 450 m. radius previously in the paper shows that the tilting vehicle on this radius only raised the acceptable speed from 100 to 135 km/h. It was when the Pendolino operated at higher speeds through super-elevated transition curves into minimum radius curves of 1.2 km or greater that the installation of a gyroscope became necessary.

FS has built minimum-radius curves of 3km on the original Direttissima, and has set standards of 3.7 km radius on new 250 km/h lines and 5.4 km radius on the 300 km/h lines.

### **Changing Train Length**

The ETR 450 is a multiple-unit train: two pairs of cars form a traction unit, and the train can be assembled in multiples of two cars, from a minimum of four cars to a potential maximum of 10-12. Each train requires two traction units with a cab end, and a varying number of intermediate non-driving units. In practice and in view of the type of service offered (see forthcoming section on passenger service), FS chooses to assemble cars in a non-symmetrical multiple formation which it could easily vary if alternate equipment were available.

The X-2000 has been so far operated in a Power-car/four-trailers/Driving-trailer formation. The four trailers consist of three different car layouts within a standard body shell: open first, open second, and a buffet vehicle with second-class seating. The six-car trains can easily be re-arranged, if the vehicles are available, into all-first, all-second, and variable first- and second-formations, each with or without a catering vehicle. One additional passenger car can be added to the six-car formation without any noticeable power loss.

Two trains can be run in multiple, with no interconnection, but the use of two pantographs would reduce maximum speed from 200 to 180 km/h. Two trains can be remarshalled into a single long train with a power car at each end, operating from a single pantograph at the same speeds as the short train. Lack of vehicles will prevent Sf from making much use of these variations until the full fleet of 20 trains is delivered in 1994.

### **Wear and Maintenance**

Tight curves travelled at higher speeds lead to heavy wear on the outside rail. The use of tilting trains therefore may tend to increase rail wear in tighter curves. This problem prevented the maximum exploitation of the Pendolino's speed potential when it was introduced on the Roma-Ancona line where older worn outside rail. Between Orte and Ancona there are curves of as little

as 350 m. radius whose outer rails wear rapidly and where the Pendolino was not therefore used to advantage.

There are no recent references to the problem of rail wear on either SJ or FS tilting operations. It is obvious that more frequent replacement than normal may be required in tight curves to ensure benefits from tilting train operations.

The use of "soft" (radial steering, or self-steering) bogies by SJ on the X-2000 has a dual purpose. One is to smooth the ride in conjunction with the softer suspension. The other is to reduce rail wear on curves by allowing the wheels on the bogie to steer through the curve, keeping the axle aligned with the radius of the curve and eliminating any grinding of the wheel flange against the outside rail (see Figures 11a, 11b, 11c, and 11d). There is no explanation as to why FS has not adopted this radial steering bogie — it may be a function of the ETR 450 tilting mechanism. The bogie has been well-tested in Sweden — a version in a less soft form has been used for many years on Stockholm suburban train sets. FS has proposed modifications to the suspension of the forthcoming order for ten more ETR 450 train sets, planned for 1992, but there is no indication that they plan to use radial steering bogies.

## **PASSENGERS**

The seating capacities and services offered on each train are enumerated below. In general both trains are fully air-conditioned, and both provide food services. Both types of car body have been built so that sound insulation in the interior is maximized — in neither case does the exterior metal of the body shell touch any interior metal, the two being separated by wood, synthetics, or rubber and plastic. The interior sound level in the X-2000 is limited to 65 dB — the train was remarkably quiet inside on a trip in September 1991. No comparable interior noise values are given for the ETR 450. In both trains the style of air travel is seen in the services: the ETR 450 uses airline-style food service in some cars, the X-2000 seats have armrest controls (light switches and headphone outlets) similar to those found in aircraft cabins.

### *The Original Pendolino Passenger Services*

There was a total of 49 seats in each standard car, driving end cars and well as interior trailing cars (see plan). The entire four-car Pendolino normally had one car fitted as a counter-service catering vehicle with only 24 seats, giving a total of 171 passengers for the train. Some versions may have been run with no buffet car and therefore had a total of 196 seats in four identical saloons.

### *The ETR 450 Passenger Services*

The ETR 450 cars are very similar to the Pendolino cars. Each traction unit of a pair of cars now normally has an airline-type galley in one end, sacrificing a further six seats. There are now 86 seats per traction unit of two cars, or 172 in a four-car pair instead of the 171 in the original four-car unit. The galley is marshalled in the center of the two-car traction unit (see Figure 5b).

In practice, however, the train configurations shown in 1988 include a non-motored restaurant car in both the 5- and 11-car consists, and only three 40-seat galley cars, marshalled to one end in the 11-car version. The restaurant vehicle contains 23 seats, presumably for use during meals by passengers seated elsewhere. Total seating capacity is therefore 442 in the 11-car version (+23 in the restaurant), and 178 (+ 23 in the restaurant) in the 5-car version (see Figure 7c).

The logical explanation of these variations lies in the market for the trains, which will be discussed below. However, trains could be simply formed in multiples of two-car traction units and/or modified into first- and second-class configurations with a total of at least 100 seats per two-car set. FS and Fiat have made no such provision to date and there is no indication they will, but provision will be made for a conference grouping of 12-18 seats within a first-class car in versions to be on order in 1992.

### *The X-2000 Passenger Services*

At present the first trains have both first- and second-class seating: the standard first-class car has 51 seats, the second-class has 76 in 2+2 seating. The driving trailer has 47 second-class seats plus space for two wheel chairs; the catering vehicle has 15 seats for patrons plus standing room and 29 additional second-class seats. In the standard formation there are 102 first- and 152 second-class seats for a total of 254, but SJ envisages variations on this arrangement— notably increasing the first-class space by adding one first-class vehicle or substituting a first-class for a second-class car. SJ may eventually consider an all-first-class train, which would be a break with long-standing practice. This first-class emphasis reflects a desire to develop the market for business travel. As noted earlier, trains up to 12 cars long are possible by coupling to five- or six-car sets in multiple, or by reconfiguring a long train with a power car at each end (removing the driving trailers) (see Figure 6b).

The interior design of the cars uses cloth on walls and laminate on ceiling in similar pastel soft shades to the seat upholstery. Low-intensity center-aisle lighting is supplemented with individual lights at each seat controlled from a seat arm switch. A music program is broadcast through the train from the buffet car— passengers can use headphones plugged into individual seat



outlets. Unlike the ETR 450 cars, the X-2000 car interiors have a railroad rather than an airline cabin feel to them.

### **Handicapped Facilities**

FS has made no provision for handicapped passengers in the present ETR 450 train sets, but the new sets to be ordered in 1992 will include special provision for the disabled.

SJ has included two wheelchair spaces in the second-class driving trailer. These two spaces are located adjacent to the entry vestibule and there is an oversized handicapped toilet compartment adjoining. Access to the wheelchair space is provided by a lift and an extra-wide door for a 70 cm wheelchair on the driving trailer. In addition there are a number of fully adjustable seats for physically handicapped persons, an auditory loop for the deaf in all cars, and all seat numbers are in relief for the blind.

### **Amenities**

The major amenity provided in both trains is food service. Due to the length of the journeys, some catering service is essential. Given the orientation of the service to the business passenger, the food services offered may need to be beyond the simple buffet and the travelling food trolley in the aisle. Clearly FS has some problems in knowing what kind and level of catering to provide.

The pattern of services offered on the ETR 450, which have been summarized in the section on Trains and Passengers, shows a major market orientation to business traffic. The morning trip to Roma makes no major demand on food services, certainly not full meals. Back from Roma in the evening may lead to a strong demand for dinner service. Providing the best combination of at-seat and dining car food service under these conditions is probably difficult. The original Pendolino made no effort to offer more than buffet service, but on a 4- to 5-hour journey between Roma and any major northern city (Torino, Genova, Milano) leaving Roma between 7 and 8 pm, there will be many business travellers who would wish to eat a dinner. The catering services required in each direction are not easily balanced. A future reduction of journey times from Roma to Milano to 3 hours 15 minutes may reduce the need for full meal service.

On the X-2000 the plans show only one type of catering vehicle, a self-service buffet occupying one-half of a full-length car, with a limited menu, and a handful of short-stay seats nearby. In the first-class cars provision is made for at-seat service of coffee and snacks by a steward using a centrally located service point. Other catering arrangements could be offered— there appear to

be no constraints on car weight or length, nor problems with the tilting mechanism. There are apparently no plans to introduce full-scale dining cars even though the Stockholm-Göteborg journey time today is almost as long as Roma-Milano. In 1994 it will be reduced to under three hours, which may make the present catering service more suitable. The Stockholm-Malmö journey will be over four hours and may require more sophisticated catering services.

Both FS and SJ see their tilting trains as vital tools to capture the business traffic, and it will have to be captured from the competing air services. The advantages are not only a competitive timing from city center to city center, but also tangible amenity advantages including more comfortable seating and more space. It may be even more important to offer better supplementary services, in particular quality food and dining. The railway management therefore can hardly afford to downplay this aspect of services in their marketing programs.

The additional on-board amenities on the X-2000 include a payphone cabin in the buffet car, and two cordless telephones in each first-class car. There is a somewhat cumbersome fax service via SJ's Stockholm office. Outlets for passengers' mobile phones and personal computers are provided at five single seats in each first-class car. Three conference groupings of four seats are provided in each first-class car — these are enclosed in glass panels and have curtains for greater privacy.

## **RELIABILITY**

### **On Time, Time Late, Reason Late**

The reliability of the two tilting-train systems may be seriously affected by track congestion from slower traffic. No statistical information is provided for the ETR 450 services; FS has a great interest in ensuring a high level of on-time arrivals.

No lengthy on-time record has yet been established for the X-2000, but the lower intensity of use of SJ main lines should not create problems of late running under normal conditions.

### **Kilometers in Service**

The Pendolino accomplished 250,000 km. of service between its introduction at the start of summer of 1976 and the end of summer 1978, a total of 27 months in which 63,000 passengers were carried. FS felt that this period of service established a good level of reliability.

A rough calculation of the service of the first 11-car ETR 450 would suggest five or six roundtrip journeys, Roma-Milano weekly, at 1,250 km. per day. With time out for major service

the train could operate for 10 months at 25,000 km. a month or 250,000 a year. It is quite possible that the first ETR 450 sets have already reached 750,000+ km. in service. There is no suggestion in the literature that any one set has developed major problems.

The oldest X-2000 set ran three round trips a week from Stockholm to Göteborg for much of 1990, for a total of 2,700 km. With maintenance time it possibly reached 100,000 km. in the first year, and may have reached close to 250,000 by now. There have been no problems of reliability reported in recent literature.

### **Accidents**

No accidents have yet occurred to either type of tilting train.

## 4. ENVIRONMENTAL IMPACTS

### LAND USE

Land-use impacts are relatively minor. Use of existing tracks means that land-use patterns have hardly changed. The building of the new direttissima lines in Italy has been frequently delayed by local disputes as to the precise path for new trackwork.

### POLLUTION

#### Noise

FS reports no standards for the ETR 450, and no other source raises the issue of noise pollution. SJ set the specification (which has been met) that the X-2000 at 200 km/h would generate no more noise than a locomotive-hauled train running at 130 km/h at a distance of 25 meters from the track. The dB value of this standard is not given. 130 km/h was the normal maximum speed of SJ express trains in the mid-1980s.

#### Visual/Barrier Effect

The rebuilding of older Italian lines has not increased their visibility. The Roma-Firenze direttissima is marginally more visible than the old line, but it has a number of longer tunnels. The new direttissima from Milano to Bologna may be more visible than the present line; about 35 percent of its trackage will be on a viaduct, but there is no indication of the height of the viaduct. This elevated line may be the only one to create a noticeable barrier effect.

For almost its entire length, the introduction of high speed operations will not change the landscape of central Sweden at all. The major new line in Sweden, the Grödinge cut-off (from Södertälje to Stockholm), will have a striking feature at Södertälje, where it crosses the canal on a high viaduct on which the new station will be located. Far from being a visual pollutant, this striking construction will be a dramatic feature in the somewhat featureless landscape.

#### Other Environmental Impacts

The tilting trains make no other environmental impact — they lead to the least change from the present system. Both trains make one other useful contribution to environmental awareness: sealed chemical toilets are installed on both trains in lieu of the traditional railway practice of emptying waste on the track.

## 5. REVENUE (vs. competing mode)

### TICKET PER PASSENGER/KILOMETER

The specific revenues of the new tilting trains on FS and SJ are not available in any accessible source. However, in each case they may represent among the highest earnings per passenger/kilometer. In both cases they also represent the new approach to marketing rail service on the respective systems: provision of more than mere seating and of pricing by kilometer. The higher-revenue efforts include emphasizing first-class service, charging special supplements, and setting fares in relation to competing modes of travel (primarily by air). Whether the revenues earned represent a true return on investment is somewhat more difficult to determine.

The revenues from these new services contribute to the total revenue of two well-established state-created organizations in which purely commercial considerations had long ceased to play an unswerving central role in determining where to invest or what to charge.

In the past ten years major changes have been made in the legal status and commercial orientation of each organization. FS remained until a few years ago still close to the old model of a European state railway — supporting uneconomic services for social purposes, massively over-staffed, with many fares kept low for socio-political reasons, and with location and level of investment determined by outside agencies. SJ by contrast has moved furthest to the commercial model — it no longer owns the permanent way, and it is at the start of an era in which all of its operations are judged commercially. Within a few years SJ should be able to make a sound economic appraisal of its tilting train venture (*see Appendix*).

#### **First Class**

The ETR 450 is a first-class-only train. In revenue service between Roma and the northern cities, the 11-car versions are used; with 442 seats per train the maximum revenue is five round trips from Roma to northern cities, plus the supplements charged. The volume of traffic between Roma and the "main commercial centers" of Italy increased 65 percent from June 1990 to June 1991, and it increased 35 percent alone from January to June 1991. The only train not in service in June 1991 was the Roma-Reggio in Calabria service, and therefore these increases must almost entirely represent growth in traffic on nearly the same base of service. Passengers must pay a "hefty supplement" in addition to the first-class fare, which includes meals and other services, and is described as "FS's first venture into a market pricing system" (IRJ, Dec. 1991).

For example, in 1988, before the ETR 450 trains entered service, SNCF first-class fares were 2.4 times higher per kilometer for distances over 300 km (shorter-distance and second-class fares showed an even greater discrepancy). Since 1989, in conjunction with a major restructuring of FS finances, regular fares are to rise steadily by up to 20 percent a year until they reach Western European average levels. The market pricing introduced with the ETR 450 service is viewed as the model for market pricing for all future quality long-distance service.

By FS standards the ETR 450 trains earn excellent revenues — FS certainly seems to view them as important money-makers compared with the massive losses in other operation areas.

The X-2000 trains have 102 first-class seats out of a total seating capacity of 254; they have been in revenue service for such a short time that no revenue figures are yet available in readily accessible sources. The premium on first-class fares should mean that the earning capacity per car is about the same whether set up in first- or second-class configuration. SJ also charges a high supplement for the use of these trains (SEK 100/\$18, in 1991 over the entire journey).

### **Second Class**

The emphasis in marketing the new tilting trains has been toward premium service, with first class receiving the emphasis. There is no reason why, as noted above, in any given car, second-class service should not earn as much revenue per mile.

### **5.2 Per Train/Km**

No information on this aspect of revenues has been published in accessible sources.

## 6. COSTS

The costs of the tilting trains now running on the FS and SJ networks are not easily to determine. The costs fall into two parts: the trains themselves, easier to identify, but for which limited information is available; and the infrastructure costs, which are embedded within the capital investment programs for modernization of the overall network, and can rarely be attributed solely to the requirements of the tilting trains.

### INFRASTRUCTURE

The overall costs of the tilting trains are not easily disentangled from the total pattern of new investment in the fixed equipment of both FS and SJ over the past ten years. In each case the tilting train forms part of a program of renewal of the network after two or more decades of relative neglect. Modernization of the infrastructure benefits a wide variety of rail operations, including the new tilting trains; this investment would almost certainly not be undertaken just for the tilting trains, but the tilting trains would not be an attractive proposition without a minimum level of infrastructure upgrading.

The minimum amount of infrastructure upgrading required to justify the investment in the tilting trains is also probably difficult to determine. As the Swedish experience shows, much of it does not have to be in place before the tilting train service is launched; it can be undertaken progressively as tilting-train service expands. Equally, as the Italian experience shows, infrastructure upgrading primarily directed at other rail services will offer important benefits to the tilting trains.

Finally, the way in which new capital investment in the rail system is determined has changed significantly in both Sweden and Italy in the past ten years. What access the rail system has to capital, its role in choosing how the capital is used, the accountability for making a return on capital—all these have changed significantly for both FS and SJ since the beginning of the decade. A summary of the changes in organization and capital funding are provided in the *Appendix*. It is important to note here that ten years ago neither FS nor SJ was usually required to raise capital in a free capital market, nor were they required to use business principles to justify investments. They spent government money, and the government usually decided how, when, and where it was spent. This situation was not much different elsewhere in the European world of state-run railways. In 1991 it is very different indeed.

## Stations

### *Station Operating and Rebuilding on FS*

The introduction of high speed services has forced FS into some major investments in station rebuilding. As the result of historical choices concerning station location made over 100 years ago, the major Italian cities (Bologna and Genova excepted) have terminal rather than through stations. In an era of slower rail travel and with the frequent remarshalling of through sections of long-distance trains, this type of station layout was not a source of problems. On a five- to six-hour journey from Milano to Roma, it was not important that a train stood for at least ten minutes at Firenze SMN (Santa Maria Novella), a station right in the heart of the city. Terminal stations permitted the railroad to get close to the city center without either blasting a path of destruction across a historic city center, or boring even more costly central-city tunnels. This dominance of terminal stations is now a serious liability for high speed services.

Consequently, FS has been forced to consider alternatives: the cheaper one is to use a non-central station on an inner through line; the more costly is to rebuild or replace terminal stations with through stations at or near the same site. The introduction of the ETR 450 trains has thrown this issue into high relief. Station rebuilding will take a lot of money and a long time. The use of inner suburban stations as the calling point for through trains has now been adopted. It had already been introduced in a limited way before high speed services came along.

The most serious problem is at Firenze. The station of Santa Maria Novella is very well located close to the city center at the end of a 500-meter spur line. This branches from the through line which passes to the northeast of the central city just outside the renaissance-walled area. The introduction of the ETR 450 service, emphasizing fast morning and evening service between Roma and northern cities, meant either a costly and time-consuming reversal into and out of Firenze SMN, omitting a stop at Firenze altogether, or using an alternative station. Prior to the ETR 450 service even the famed "Settebello," the luxury first-class predecessor to the present ETR services, spent 8 minutes on a station stop at SMN, and must have lost 12-14 minutes on the exit and entry to the station. By contrast only a 2-minute station stop has been required at Bologna for any high speed service.

Although the initial ETR 450 Roma-Milano service ran non-stop in 1989, passing within a kilometer of SMN, from 1990 all trains on the current service called at Firenze (Rifredi)— a somewhat small dowdy station on the through line, about two kilometers north of SMN. Neither the location nor the image was that sought by FS for the ETR 450 service. However, a second inner-city through station at Campo di Marte (nearer to the city center) has been used for the Firenze stop of a few through trains in the dead of night for many years.



FS has plans to upgrade Campo di Marte and switch the Firenze stop of the ETR 450 from Rifredi to Campo di Marte, but the preferred solution is an expensive new underground line through Firenze, with low-level through platforms at SMN. The tunnel will be costly and possibly risky to build in view of the historic district above it, but the present terminal can remain in use, and only a modest set of platforms will be needed below-ground. Furthermore, the tunnel cannot be opened for at least ten years. The new line and station in-tunnel at SMN is the most expensive of the station modifications which high speed service imposes. The most recent references to this project give no indication of its estimated costs, but stress its value.

Roma, Napoli, Milano, Torino, and Venezia are similarly affected because their principal station is a terminus. The geographical site of Venezia offers no alternative solutions— trains travelling beyond Venezia either reverse in and out over the causeway across the lagoon, adding 30 minutes to a through journey, or passengers have to use Venezia (Mestre) on the mainland.

Napoli has an older underground line across the central city giving through trains stopping possibilities at Piazza Garibaldi, almost alongside the terminal station itself, and/or at Mergellina or Campi Flegrei 8 and 10 kilometers away on the opposite side of the central city. This tunnel line is part of the coastal route from Roma. Unfortunately the new high speed line from Roma follows the inland route via Cassino, from which access to Napoli is now limited to Centrale, the terminal station. Thus another costly line, the Vesuvio tunnel line, is now under construction to provide a through station on a high speed route through a major city. The cost of projects like this does not necessarily come from the FS capital budget: the south of Italy qualifies for separate government aid to promote economic development.

Milano not only has an imposing terminal station (Centrale) but has the highest use of two inner suburban stations by through trains (Lambrate and Porta Garibaldi). Centrale is not as centrally located as other big-city terminal stations, thus use of two other inner-city stations is made more acceptable by a metro line connecting Lambrate with Porta Garibaldi via Centrale.

Although currently no high speed trains run through the city, the same potential problem exists at Roma. A major capital investment in completing the ring rail lines through Roma was made in the 1970s and 1980s to ease congestion at Roma Termini, and allow easier use by main-line trains of inner suburban through stations, principally Tiburtina and Ostiense, both recently modernized. Many N-S express through trains already use Tiburtina, and through high speed service is planned. Fortunately the very recent (1991) extension of a metro line from Termini to Tiburtina makes the latter much more accessible than before.

No specific information on the costs of these major station renewals is available.

#### *Station Operating and Renewal on SJ*

Stockholm Central station is a large through station able to handle the X-2000 trains easily, but there is a major bottleneck with only two tracks over the first 4.5 km. south from Central Station through Södermalm, almost entirely in-tunnel. Without some relief for this two-line section, which carries over 300 trains a day in each direction (one every three minutes over a 20-hour day), reliable high speed service could be badly affected by delays.

The duplication of this tunnel over its entire length has been rejected for the short term; instead, a short section with a third track and new bridge will be provided for the first kilometer south out of the station at a cost of SEK 1 bn (\$180 mill) for a solution that will work only to the end of the century. At some time in the next century the long tunnel will be needed.

A brand-new station, served by all X-2000 trains, has been built in conjunction with a local transport interchange at Stockholm Syd on the south-western edge of the metropolitan area— this is a basic building whose cost must have fallen well within reasonable limits. Södertälje will have a brand-new station on the viaduct over the canal, as part of the new Grödinge line; its costs are included in the SEK 3 bn (\$750 mill) cost of the new line. The Grödinge line is essential to the long-term success of the X-2000 services, and although the new trains do not now stop at Södertälje, it is too important a city not to have a station on the main line.

No major work was evidently required at Göteborg station.

#### **Track (Upgraded and New)**

##### *Costs of Track Investment on FS High Speed Routes*

In 1985 the Direttissima, with over 200 km. of the planned 261 km open, had already cost 750 Bn lire, and the remaining 50+ km. were estimated to require another 400 Bn lire— a total of 1,150 Bn lire (\$1 Bn). By 1987 the remaining 44 km. were estimated at 860 Bn lire, more than the rest of the line because of costly tunnels through extremely difficult terrain. In total, this was the single most expensive project ever undertaken by FS until then; its total cost was, however, overshadowed by the proposed 12,400 Bn lire of the original 1981 Integrated Plan, increased by 6,400 Bn lire in 1983, for a total of almost 19,000 Bn lire. This sum represents \$16 Bn for all kinds of investment (track work, rolling stock, and so on).

For the rest of the 1980s, government-directed programs sent money to FS for investment in all aspects of the system. The status of FS changed to independent public body in 1985, and it is now being redefined in 1991 as a state company. In 1990-91 FS has been allocated a capital fund and is expected to raise 60 percent of capital in future high speed services, establishing mixed companies, with the new lines themselves remaining under FS control.

#### *Costs of Track Improvements on SJ High Speed Routes*

The capital investment in the general upgrading of the Stockholm-Göteborg line (track renewal, signalling, and grade crossings) to full 200 km/h capability will be about SEK 1 billion (\$200 mill) by the end of 1992. A new high speed dedicated line between the same two cities was estimated to cost SEK 9 billion — a sum which would have consumed most of Banverket's SEK 10 billion allocated budget for the next ten years. By far the biggest track renewal project, the Grödinge line, will cost SEK 3 billion (\$600 mill) to complete over the next three years, the most important single project currently being undertaken by Banverket.

Providing improved track for high speed service is just one of Banverket's responsibilities, which has led to dissatisfaction with the present SEK 10 Bn ten-year budget. If the costs for upgrading the Stockholm-Malmö line to 200 km/h by 1996 are proportional to the Göteborg line costs, then clearly Banverket does not have the resources at present to undertake it. In late 1991 Banverket decided to press hard for a two- to threefold increase in its ten-year budget.

#### **Control System**

There are no separate figures for the costs of signalling and control systems on the FS high speed lines. The "fixed installations" (signalling and modification of the surviving grade crossings) upgrading on the Stockholm-Göteborg line cost SEK 500 million, presumably about 50 percent of the SEK 1 billion cost of overall improvements mentioned above.

#### **Power Distribution System**

All the lines used by tilting trains were already electrified, but none of the catenary structures were able to support 200 km/h or higher running without strengthening. The cost of doing this seems to be included in the general costs of upgrading (track, signalling, and so on). In Sweden this work is the responsibility of Banverket.

## VEHICLES

The tilting-train cars were the product of a long period of research and testing by two very big industrial companies: Fiat Ferroviaria for the Pendolino, and ASEA for the X-2 train.

Both of these companies had substantial resources available for the long-term investment, both would expect to profit from the experimental work through applications elsewhere in their diverse range of industrial goods, and both effectively retained the patents and the future production of new vehicles. Under these conditions it would be difficult to estimate the true cost of the vehicles. The prices paid by SJ and FS for their trains may not reflect the overall costs of the research, but, on the other hand, Fiat and ASEA (now ABB) required the full cooperation of the railway management in order to test their prototypes, a cooperation which was of value to them as manufacturers.

The first four ETR 450 trainsets ordered in 1985 cost 90 Bn lire (\$75 mill), i.e., about 22 Bn lire (\$17 mill) a set; it is not clear if these were the five-car or 11-car sets. Fifty percent of the funding came from the 1981 Integrated Plan, with the remainder coming initially from FS's own resources. However, immediately after placing the order, FS was given the other 50 percent by the state under a technological research program created by parliament. Thus FS used none of its own money to buy the trains.

The X-2000 train sets were reported to cost SEK 90 mill (\$17 mill) in 1991. There is no mention of the costs of individual items, such as the power car or the trailer cars.

Since 1989 SJ has had to pay a track use fee to Banverket, the owner of the permanent way in Sweden (see *Appendix*). This sum is 0.22 kronor (5 cents) per vehicle per kilometer for cars with radial steering bogies as on the X-2000. For traditional passenger cars the fee is 0.31 kr per kilometer. The savings per car are unfortunately outweighed by the higher fees per power car; at 160 km/h usage the fee is 0.79 kr per kilometer, above the 0.55 kr charged for power cars travelling up to 120 km/h. The total fee paid by SJ to BV for the use of its tracks in 1990 was SEK 800 mill (\$130 mill).

## PERSONNEL

There are no specific figures on the costs of personnel— either on board, in station, or service or maintenance staff. Both trains require a fairly large number of on-board personnel to deliver the services offered. Each first-class car requires one attendant for the at-seat refreshment service. The high supplements charged are no doubt intended to pay for this unusual level of staffing.

## **Maintenance**

In the only comment on maintenance costs, FS stated in 1979, with respect to the Pendolino after almost three years in operation, that "maintenance costs . . . were not appreciably different from those for operating equivalent conventional rolling stock" (IRJ, June 1979).

No further references in recent literature give information on the current maintenance costs of the ETR 450 fleet. The X-2000 trains have not been in service long enough to establish any norms for maintenance costs.

## 7. SYSTEM STATUS

### RESEARCH AND DEVELOPMENT

The research and development of tilting trains has been in both government and private hands. The major failure of British Rail to build a reliable tilting train, the APT, was ascribed to the problems inherent in a long-established bureaucratic organization such as British Rail, where research and development was not a separate institutional activity but rather a branch office in each of the organizations major operating divisions (see Potter, S., 1989).

The two successful developments which are the subject of this paper were launched in the private sector and brought to full working success in the public one. However, there is strong criticism of the failure of FS and the Italian government to exploit the potential of the Pendolino over a long period of time (Giuntini, A., 1990).

#### Government

The role of the governments of Sweden and Italy in promoting the research and development of tilting trains was secondary. It was primarily provided by the state-owned railroads who offered support, a test location, and engineering assistance with the standards of design. This is something of a break from the longer history of railroad development, when the private railroad companies or the state railroads did most of their own research and development.

FS and the Italian government committed themselves to further development when FS ordered the four-car Pendolino train in 1976. The Italian government underwrote, after the fact, some of the development costs when it agreed to pay for 50 percent of the purchase price of the first ETR 450 train sets with funds from a program designed to promote scientific and technological activity.

The completion of the final section (Arezzo-Figlione Valdarno) of the original Firenze-Roma Direttissima, in early 1990, took longer than planned so that it could be built to 300 km/h standards and used as a test track. (In September 1991 this section was not being used by regular services, and thus was evidently being used for test purposes.) The high speed trials currently impair the value of the line for revenue service, but FS was planning to complete a 40 km section of the Milano-Bologna new line, near Modena, as a 300 km/h high speed test track, in early 1992. These test sections now primarily benefit the ETR 500 project.

SJ equally provided a test track facility in the early 1980s, and provided clear-cut guidance for the train builders by publishing specifications for a high speed train in 1986. It seems by then

that there was only one possible developer. From the specifications came the positive orders for the new X-2000 trains in 1988.

### **Companies**

It is quite accurate to characterize the development of the two tilting trains in this report as a success for the private industrial sector. Two major European engineering concerns have spent up to 20 years working on a project which has proved technically valuable, and will equally hope to prove financially profitable. The engineering companies have been major players in their respective fields with a diversity of engineering interests for many decades; they are well established and have the necessary resources to plow into these long-term ventures.

(a) **Fiat Ferroviaria** — the railroad engineering unit of **FIAT Spa** — is the developer of the ETR 450. **FIAT** (**Fabricata Italiana Automobile Torino**) is the oldest and biggest of the Italian car manufacturers, dating from the first decade of the century. Headquartered in Torino, it has progressively expanded over the past 80 years into other transportation engineering fields and into other regions of Italy. It has become an international enterprise on only a limited basis. Fiat has been in railroad vehicle engineering and building for almost as long as it has been in automobiles, with long experience in building and improving car bodies and bogies. To build a tilting train was a natural development of existing Fiat business.

**FIAT** and its subsidiaries still remains a separate company, but the scale of new rail contracts makes the formation of consortia essential. In 1991 Fiat Ferroviaria has joined with other Italian transportation engineering firms (**Ansaldo**, **Breda**, **Firema**, **TIBB**) to build the new lines and rolling stock for the future high speed system in Italy (IRJ, June 1991: 12). These other firms have agreements with other major European engineering firms, **Breda** with **Siemens**, and **Ansaldo** with **ABB**. **TIBB** is the Italian subsidiary (**Tecnomasio ABB**) of the Swedish-Swiss builder of the Swedish tilting train. In 1991 Fiat negotiated, then withdrew from, an agreement whereby **GEC-Alsthom**, prime contractor of the **TGV**, would take a 51 percent share in Fiat Ferroviaria (IRJ, May 1991: 13).

(b) **ABB (ASEA-Brown-Boveri)** is a relative new multinational corporation under that name. Most of the development work on the tilting train was done by **ASEA (Allemanna Svenska Elektriske AB)**, the Swedish General Electric Company, the leading heavy electrical engineering company in Sweden, whose roots go back also to the beginning of this century. Headquartered in Västerås, Sweden, its principal products have been in heavy electrical equipment and motors, and as such it has been a major builder of electric locomotives and traction equipment for decades. Its markets have not been confined to Sweden, but are widely sold in Europe and the world (**Amtrak** uses **ASEA** locomotives in the **NE Corridor**).

In 1988 ASEA merged with Brown-Boveri, a major Swiss transportation engineering firm with an equally long history. Brown-Boveri AG is headquartered in Zurich, within a region of noted electrical and locomotive engineering companies (Winterthur, Oerlikon) of which it was the leading member. The combined business of ABB brings together strengths in electrical and in mechanical engineering, making the new business very well equipped to build tilting trains.

Both of these firms have a lot invested in tilting trains, a long-established research and development program, and no signs of lack of commitment to future growth and improvements in this rail technology. The consortia, the working agreements, and the existence of mutual patterns of cross-shareholding suggest that there is a single transportation engineering giant developing quite rapidly in the Europe of the 1990s.

### **Current Use**

The current use is confined to the national rail networks of both Italy and Sweden, as outlined previously in this paper.

### **Near-Future Use**

The immediate growth will be on the FS and SJ networks.

FS announced that a letter of intent was sent to Fiat in May 1991 for the purchase of six more tilting trains "of a new design," and a second letter of intent (IRJ, Dec. 91) stating that it plans to place an order for an additional ten nine-car ETR 450 train sets within the next two years, following the delivery of the 15th ETR 450 early in 1992. These items do not make it clear if the order for ten trains in December included the six referred to in May, or was additional. (Given the potential use of the trains, an upward revision from six to ten is the most likely explanation.) Nothing explains where the 15th ETR 450 came from — the original order was for 14, all presumably delivered by Spring 1990. Without an announcement of the routes for which these new sets are destined, we can only speculate on the following possible choices:

- (a) a strengthening of the present axial routes to and from Roma
- (b) service along the Torino-Venezia axis, for which a high speed line is planned
- (c) through service Milano/Genova/Torino to Napoli, via Roma
- (d) extended service from Roma to southern Italy

This last is favored by government aid for the development of the south (successor funds to the "Cassa per il Mezzogiorno"), including to Sicilia (Palermo and Siracusa) where permanent way upgrading (double track and new electrification) are well underway. The new metro access to Roma (Tiburtina) and the emphasis on finishing the Roma-Battipaglia line and the Vesuvio tunnel under Napoli also support a growing importance for categories (c) and (d) above.



SJ will take delivery of its order of 20 sets through to early 1994. No further announcements of new orders have been made through December 1991, though SJ's management has characterized the X-2000 as its "survival tool," and, under the new structural organization in which SJ is merely a train operator, attention is focussed on survival because the current monopoly on long distance passenger service which it holds will expire in a decade. Services at the national level will then be open to competitive bidding, just as they have already been at the local level. It is conceivable that SJ could go out of business by the year 2000, if it is underbid by other potential operators. ABB may well be capable of bidding for the service itself.

### *Proposals for Tilting Trains Elsewhere*

Both FS and SJ, and the companies building the tilting trains, have an interest in much wider markets in Europe and elsewhere. As of this writing, only one firm order exists for a variant of the ETR 450.

**Austria —OBB (Österreichischen Bundesbahnen)**, as part of a major investment program adopted in 1990, placed an order for three prototype six-car Fiat tilting trains, to be delivered by the end of 1993. They will undergo a four-year test program, which if successful will lead to an order of a production fleet (number unstated) beginning in 1997. The investment plan will put a lot of capital into rebuilding the heavily used lines, principally Wien-Linz-Salzburg, for 200 km/h regular train operation. The tilting trains will go to other main lines where conventional trains are or will be limited to 160 km/h, such as Wien-Graz, Graz-Innsbruck, and Wien-Villach.

The Austrian train sets will be built under license from Fiat by two domestic firms in conjunction with ABB and Siemens. They will be wider and slightly heavier, and operated normally as fixed-formation six-car trains to which four additional cars can be added. The basic six-car train will have 80 first-class and 210 second-class seats, with the body width increased from 2.75 m. to 2.82 m to allow for four-a-side second-class seating. They will operate at lower maximum speeds than the ETR 450 and will therefore have less powerful motors, but otherwise the traction system is identical to the ETR 450 (IRJ, Dec. 1990: 30).

Among the many railroad administrations and regions which have expressed an interest in the X-2000 are:

**Canada.** The Québec-Montréal-Toronto-Windsor corridor, subject of a task force of the Québec and Ontario provincial governments. ABB Canada has proposed "Sprinter" train sets based on the X-2000 for this line in contrast to the dedicated line proposed by Bombardier Inc., a leading Canadian transport engineering firm. ABB Canada's service would be cheaper and in service much earlier than the Bombardier proposal. (IRJ, July 90: 12). Via Rail had proposed a similar plan for a dedicated line before its services were drastically cut back in early 1990.

**Norway and Finland.** The management cooperation group of the four Scandinavian railroad systems (SJ, NSB, DSB, and VR) has been promoting a Nordic high speed train based on the X-2000 since 1986. NSB (Norske Statsbaner), the Norwegian state railway, has had its own tilting car in service since 1986, using its own engineering services (short transition curves in Norway imposed the use of two accelerometers and a gyroscope) (IRJ, Feb. 1987: 30). By 1990 both NSB and the Finnish Railways (VR) were proceeding with plans to adapt and adopt the X-2000 in conjunction with track investments to upgrade normal running speeds to 160 km/h. Tilting cars or tilting trains could then operate at 200 km/h over those lines (IRJ July 1990: 19).

[Although interested in faster speeds, the Danish State Railway, DSB (Danske Statsbaner), has built its own new fleet of conventional higher-speed train sets, the IC3, designed to run at 160 km/h — these trains were serious competitors for a new contract from the New South Wales State rail system in 1990 (IRJ, Apr. 1991: 14).]

**Germany and Switzerland.** The X-2000 was extensively tested on the tracks of DB and SBB/FSS during the summer of 1991. Engineers of both networks provided a test track and expressed interest in the use of the tilting trains on secondary lines. The X-2000 was operated safely up to 250 km/h on the new German high speed lines. Of more importance was safe operation at 160 km/h in extensive tests in the Saar valley, where the normal maximum speed is 125 km/h (IRJ, Oct. 1991: 10).

**United States.** In November 1991 Amtrak announced an agreement for the testing of the X-2000 on the Washington-Boston corridor during 1992, followed by a period in passenger service in 1993, using a modified formation of three first-class cars, a buffet car, power car, and driving trailer. Between New Haven and Boston the train would require diesel haulage using Turbotrain power cars. Amtrak would like to electrify to Boston and develop a high speed service reducing travel time from 4 hours 30 minutes to 3 hours. The 19 trains required for a complete service are estimated to cost \$15 mill each (RGI, Jan. 1992: 7).

## APPENDIX

### Investment Plans and Planning for FS and SJ

The administrative organization of both FS and SJ and the relationship of each state railway to the national government have changed significantly during the 1980s. This appendix summarizes the changes in administrative structure and its relationship to investment planning and decision-making for the two rail systems.

The investment programs of FS and SJ for their high speed services need to be put in a context of state and railroad relationships in order to be understood clearly. At the beginning of the 1980s, both FS and SJ were badly in need of major new investment in the infrastructure, primarily tracks and signalling (control) systems. Both had been seriously underfunded, if not neglected, since the 1950s, in part at the expense of highway development. A need to step up investment was finally recognized in the later 1970s.

#### FS — Investment Planning and Administrative Reorganization

In the case of FS, beginning in 1981, there have been a series of major investment programs proposed, amended, and later replaced. One overriding theme has been that ambitious plans have later been scaled back. The stages of the investment plans were:

- (a) The Integrated Plan (1981), the first modern large-scale investment program, amended frequently until
- (b) The Multi-Annual plan (1985), which was subsumed into
- (c) The Master Plan for Transport (1986), which included all transportation modes
- (d) The new ten-year plan (1989), following a corruption crisis in the FS management.

The current ten-year plan has already been scaled back in 1991.

The original Multi-Annual Plan was started in 1981 with a 12,500 Bn lire (\$11 Bn) fund, to which was added 6.4 Bn lire (\$5 Bn) in 1983. The state considered adding yet another 15,500 Bn lire in 1985, again for all types of investment. Then the National Transportation Plan of 1986 proposed a 220,000 Bn lire (\$200 Bn) ten-year investment program in all transportation, including such spectacular projects for FS as a complete network of new direttissime lines, a base tunnel at the Brenner Pass, and a 3.3 km bridge across the Straits of Messina.

Neither the Pendolino nor the original work on the Direttissima train formed part of these overall investment programs, but the ETR 450 and all subsequent high speed programs are included in them, including completion of the Direttissima.

In 1985 FS became an independent public agency (*Ente Pubblico*), changing from its former status as an autonomous government department (*Azienda Autonoma*); earlier it had been simply a government department.

In 1987, as the new plan and new management moved ahead, the state specifically agreed to 18,000 Bn lire for a through Milano-Battipaglia HS line, incorporating the then almost completed Roma-Firenze direttissima. The two new separate sections, almost exactly equal in length (290 km each), were estimated at 13,500 Bn lire (\$11 Bn) for track and ancillary infrastructures, with the Roma-Battipaglia section (including the Vesuvio tunnel through Napoli) to be built first. This total is considerably higher per km. than the Roma-Firenze section, which reflects both inflation in Italy and a decision to construct a line for 300 km/h operation which increased the minimum curve radius significantly, and thereby the cost as well.

In 1989, FS was still saddled with operations that were an immense financial burden. The annual report of that year noted, and later reports added that:

- Commuter traffic accounted for 17 percent of passenger/Km, but 0.5 percent of revenues
- Commuter journeys cost 10 lire per km (1.3 cents per mile)
- FS had an excess of 20,000 employees, mostly in the south, and for which in part the government paid a wage subsidy
- FS fares for distances over 300 km were only 37-40 percent of those charged by SNCF, and increases still required government approval,

and in December 1991, the system still had:

- 2,000 km of route (10 percent of the network) cost 2,000 Bn (\$1.8 Bn) lire to operate, and earned only 25 mill lire (\$50,000)
- One retired worker collecting a pension for every active worker

In late 1989, after a period of administrative turmoil and resignations due to corruption, the new administrator of FS presented another 52,600 billion lire (\$40 Bn) ten-year investment plan. Now, in conjunction with reorganization plans partially to privatize FS, occurs the first mention of private capital. Separately, a new high speed line, Milano-Genova, 135 km long with a 20 km tunnel, was proposed by a Milano engineering consortium — no estimate of costs was given for this joint state-private sector project. 5,000 Bn lire of investment was reserved for southernmost Italy.

In 1990-91 FS has been allocated a capital fund and is expected to raise 60 percent of capital in future high speed services, establishing mixed companies, with new lines remaining under FS

control. In March 1991, FS established a mixed company called *Treno Alta Velocita* (TAV), capitalized at 100 Bn lire (\$90 mill) — 40 percent from FS and the remainder from a consortium of European banks — to "develop" high speed services. The now-defined "T"-form network (Torino-Venezia, and Milano-Napoli) is estimated to cost 30,000 Bn lire (\$26 Bn), of which the Italian government will provide 40 percent (12,000 Bn lire), with the rest coming from the private sector. FS will form a separate wholly owned subsidiary to build the new lines, and another company, in which FS will have a 40 percent stake, will market the new high speed services. In December 1991, details of the new organization for building the high speed lines were released. TAV will build the new lines, FS will lease them.

On the provision of non-profitable services, FS has finally in 1991 got agreement in principle to government contracts for the support of non-viable services, which would attract a fixed state subsidy to replace the general subsidies which FS had been receiving up to then.

In summary, as FS has progressed from being a government department to an autonomous state agency, the source of its capital funding is now rapidly moving from the control of the Italian Parliament to mixed public and private sources. By the end of the century, FS should have evolved into a public corporation using basic commercial principles to justify its investments. A big share of the new capital will still come indirectly from the state, but in the context of a National Transport Plan, which includes investment programs for all transportation modes in which the state has an interest. Within this same time-frame, FS expects to have categorized its finances into clearcut business and social (subsidy requiring) areas.

### **SJ — Investment Planning and Organizational Restructuring**

Sweden has moved much more rapidly toward a similar end, but using a substantially different structural approach. Beginning in 1979 a slow but steady program of deregulation of transportation has been pursued. Counties (län) were made the primary agencies for transportation planning and, if they wished, operation of services (directly or under contract). In the context of an integrated national transportation plan, a major change was made in 1988, a complete innovation for a European state railway system.

Using the analogy of highways, the state established Banverket (the State Rail Agency) to own and modernize the rail infrastructure. SJ became solely an operating agency paying a fee for the use of Banverket's track. Signalling and power supply are provided by Banverket. Stations are currently a gray area — SJ owns them now, but is strongly persuaded they should be under Banverket. SJ owns the rolling stock and makes its own decisions on equipment investment; it has to depend on

Banverket for the infrastructure investment. SJ may not survive in the long term. It has no monopoly on local services controlled by county administrations and has already lost the contract in one county. It will probably ultimately lose its monopoly on long-distance and freight services, and will then have to bid competitively for the right to operate such services.

Banverket was given SEK 10 Bn (\$1.8 Bn) by the Swedish government in 1989 for a ten-year investment program in the rail infrastructure. SJ countered with arguments that SEK 40 Bn was needed. In 1990 Banverket adopted four levels of investment program: Plan 10, the basic allotment it originally had; Plan 20 (SEK 20 Bn, \$3.5 Bn) which it designated as a Formal Project Design to upgrade the basic 6,300 km. trunk network; Plan 30 (SEK 30 Bn), which was designated the Long Term Strategic Plan. In 1991, the Swedish Parliament voted an additional SEK 20 Bn for all transport investment, of which a major share will probably go to Banverket.

## REFERENCES

### Materials on the SJ (Swedish State Railways) Tilting Train

- "ABB proposes cheaper Canadian HS Line." 1990. *International Railway Journal and Rapid Transit Review* 30(7), July: 12.
- Alexandersson, Jan. 1991. "X2: Sweden's Curve-Dependent Tilting Body High-Speed Train." *Rail International* 22(5), May: 38-44.
- \_\_\_\_\_. 1987. "Development of high-speed trains in Sweden." *Rail International* 18(2), February.
- "Amtrak to test X-2000." 1992. *Railway Gazette International* 148(1), January: 7.
- "Banverket calls for Higher Rail Investment." 1991. *International Railway Journal and Rapid Transit Review* 31(10), October: 6.
- Federal Railroad Administration (FRA). 1990. "Safety Relevant Observations on the X2000 trains as developed for the Swedish National Railways." US Department of Transportation (Office of Research and Development), Washington, D.C.: December.
- Hanson, Lars, and J-E. Nilsson. 1991. "A new Swedish Railroad Policy: separation of infrastructure and traffic production." *Rail International* 22(6-7), June/July, .
- "High Speed Makes Commercial Sense." 1990. *International Railway Journal and Rapid Transit Review* 30(7), July: 19.
- "Innovating for Survival." 1990. *International Railway Journal and Rapid Transit Review* 30(7), July: 15-19.
- Jansson, Jan Owen, and P. Cardebring. 1989. "Swedish Railway Policy 1979-88." *Journal of Transport Economics and Policy* 23(3), September: 329-337.
- Jansson, K., and B. Wallin. 1991. "Deregulation of Public Transport in Sweden." *Journal of Transport Economics and Policy* 25(1), January: 97-107.
- Kottenhoff, Karl. 1991. "Regional Train Development in Sweden." *Public Transport International* 40(1), Mar-May: 68-76.
- "Mulum in Parvo." 1987. *International Railway Journal and Rapid Transit Review* 27(2), February: 16-18.
- "New Tax threat to SJ Finances." 1990. *International Railway Journal and Rapid Transit Review* 30(7), July: 27-28.

- "NSB Operating Subsidy grows." 1987. *International Railway Journal and Rapid Transit Review* 27(2), February: 30-33.
- Potter, Stephen. 1989. "High Speed Rail Technology in the UK, France and Japan. Managing Innovation — the Neglected Factor." *Technology Analysis and Strategic Management* 1(1). Also given as a paper at the conference on "High Speed Trains, Entrepreneurship and Society," held in the Stockholm School of Economics, Sweden, 12-14 June.
- "Public transport in Sweden." 1990-91. *Public Transport International* 39(4), December-February: 80-90.
- "Skr IObn. investment programme disappoints operators." 1991. *Railway Gazette International* 147(2), February: 75-80.
- "SJ makes progress." 1987. *International Railway Journal and Rapid Transit Review* 27(2), February: 25-27.
- "SJ Welcomes Competition." 1991. *Railway Gazette International* 147(2), February: 73.
- Sjoberg, Anders, and D. Nordenfors. "Computer-based signalling at Hallsberg brings major savings." *Railway Gazette International* 142(1), January: 37-39.
- "Tilting Train is SJ's Survival Tool." 1990. *International Railway Journal and Rapid Transit Review* 30(4), April: 37-40.
- "X2000 could run at 250 km/h." 1991. *Railway Gazette International* 147(2), February: 79.
- "X2000 reaches 250 km/h." 1991. *International Railway Journal and Rapid Transit Review* 31(10), October: 10.



## Materials on the FS (Italian State Railways) Tilting Train

- Allen, G. F. 1988. "The Italians gather speed." *Passenger Train Journal* 19(2), February .
- "Bold Strategies to improve performance." 1991. *International Railway Journal and Rapid Transit Review* 31(12), December: 33-34.
- Camposano, Dr. Paolino. 1979. "Italy's Pendolino: a successful experiment." *International Railway Journal* 19(6), June: 76-82.
- Cardini, E., C. Casini, M. Cavagnaro, and G. Piro. 1988. "FS Rolling Stock for highspeed service in the nineties." *Rail International* 19(10), October: 17-27.
- Cardini, E., and M. Cavagnaro. 1985. "Italie, chemin de fer et grande vitesse." *Transports* 310, December.
- Di Miceli, G. B. 1988. "A new strategy for Italian Railways." *Rail International* 19(11), November.
- "Direttissima inches towards completion." 1985. *Railway Gazette International* 141(12), December: 930.
- "ETR Y 500 debut soon." 1990. *International Railway Journal and Rapid Transit Review* 30(5), May: 12.
- "Fiat withdraws from deal." 1991. *International Railway Journal and Rapid Transit Review* 31(5), May: 13.
- "Flow of orders keeps industry busy." 1985. *Railway Gazette International* 141(12), December: 941-942.
- Focacci, Carlo. 1990. "Ballastless track, the Italian experience." *Rail international* 21(2), February.
- "FS future hangs in the balance." 1989. *International Railway Journal and Rapid Transit Review* 29(12), December: 18-21.
- "FS launches high-speed train project." 1985. *International Railway Journal* 25(2), February: 24-25.
- "FS reaches agreement on its future." 1991. *International Railway Journal and Rapid Transit Review* 31(2), February: 7.
- "FS seeks more investment." 1985. *International Railway Journal* 25(2), February: 27-30.
- "FS sets 1900 high speed rendezvous." 1985. *Railway Gazette International* 141(12), December: 937-940.

- "FS steps up rate of investment." 1987. *International Railway Journal and Rapid Transit Review* 27(12), December: 29-32.
- "FS strives to reduce its huge losses." 1991. *International Railway Journal and Rapid Transit Review* 31(12), December: 19-20.
- "FS tries slab track." 1987. *International Railway Journal and Rapid Transit Review* 27(12), December: 32.
- Gardini, E. 1985. "The high-speed passenger service on the FS network." *Transport Policy and decision making* 3(3): 251-254.
- Giuntini, A. 1990. "A Historical Survey of High Speed Trains in Italy." Paper presented at the conference on "High Speed Trains, Entrepreneurship and Society," held in the Stockholm School of Economics, Sweden, 12-14 June.
- Gratreau, R. 1988. "The Management and modernisation of the Italian State Railways." *Rail international* 19(4), April: 17-23.
- Graziiosi, Sergio, M. Mancini, and A. Regoli. 1991. "FS Track Renewal and Maintenance Policy." *Rail International* 22(6/7), June/July: 84-88.
- "High-speed gets Green Signal." 1987. *International Railway Journal and Rapid Transit Review* 27(12), December: 22-26.
- "High Speed Project all systems go." 1991. *International Railway Journal and Rapid Transit Review* 31(12), December: 28-31.
- "Integrated Plan swells investment funds." 1985. *Railway Gazette International* 141(12), December: 933-935.
- "Inserto speciale alta velocita: il mercato della domanda." 1988. *Bollettino di Informazione sistemu trasDorto* (anno) 11(5), September/October.
- "Inter-City and intermodal spearhead commercial strategy." 1985. *Railway Gazette International* 141(12), December: 928-929.
- "Italian High-speed agreement." 1991. *International Railway Journal and Rapid Transit Review* 31(6), June: 12.
- "Italy launches HS Project." 1991. *International Railway Journal and Rapid Transit Review* 31(9), September: 7.
- "Legal Autonomy will bring market-oriented policies." 1985. *Railway Gazette International* 141(12), December: 926-927.
- "Master Plan in minister's brainchild." 1985. *Railway Gazette International* 141(12), December: 925.