

# UC Riverside

## UC Riverside Electronic Theses and Dissertations

### Title

Taxonomy, Phylogenetics, Comparative Morphology and Evolution of Assassin Bugs (Hemiptera: Reduviidae) With Emphasis on Harpactorinae and Peiratinae

### Permalink

<https://escholarship.org/uc/item/0rz861d9>

### Author

Zhang, Guanyang

### Publication Date

2012

### Supplemental Material

<https://escholarship.org/uc/item/0rz861d9#supplemental>

Peer reviewed|Thesis/dissertation

UNIVERSITY OF CALIFORNIA  
RIVERSIDE

Taxonomy, Phylogenetics, Comparative Morphology and Evolution of Assassin Bugs  
(Hemiptera: Reduviidae) With Emphasis on Harpactorinae and Peiratinae

A Dissertation submitted in partial satisfaction  
of the requirements for the degree of

Doctor of Philosophy

in

Entomology

by

Guanyang Zhang

December 2012

Dissertation Committee:

Dr. Christiane Weirauch, Chairperson

Dr. James Baldwin

Dr. John Heraty

Copyright by  
Guanyang Zhang  
2012

The Dissertation of Guanyang Zhang is approved:

---

---

---

Committee Chairperson

University of California, Riverside

## Acknowledgments

I am grateful for the opportunity to pursue a PhD degree in Entomology, specializing in taxonomy and systematics, which has opened the door to the knowledge of insects and the natural world to me. I am especially thankful to my advisor, Dr. Christiane Weirauch, for her unfailing and tireless support, guidance and mentorship, which have been pivotal in my completing the dissertation projection and my development as a researcher. I also thank my dissertation committee members, Drs. John Heraty and James Baldwin for their mentoring.

I would like to express my gratitude to the following individuals at University of California, Riverside (UCR) and elsewhere who have provided technical assistance to my dissertation research: Matthew Buffington, Scott Whittaker (United States National Museum of Natural History, USNM), Vincent Careau, Tracy Castaneda, Nicholas Duncan, Dimitri Forero, Wei Song Hwang, Erika Olson, Elizabeth Romero, Jessica Rosales, Laura Soto, Amanda Villarreal, Douglas Yanega, Harris Yu, David Collar (University of California, Santa Cruz), Brian O'Meara (University of Tennessee, Knoxville) and Qiang Xie (Nankai University).

I would like to thank those individuals who have arranged specimen loans or made specimen donations, which have in part made this study possible. Loans of museum specimens of *Zelus* spp. were arranged by those named in Table 4.1. Loans or donations of specimens used in molecular work were made by: Caroline Chaboo (University of Kansas), Jason Cryan (New York State Museum), Torsten Dikow (The Field Museum), José A. Fernandes (Universidade Federal do Pará), Dimitri Forero (UCR, now Pontificia Universidad Javeriana), Dave Hawks (UCR), Thomas Henry (USNM), Jeremy Huff (American Museum of Natural History, AMNH), Hui Liu (Kyushu

University), Joseph McHugh (University of Georgia), Dmitri Maslov (UCR), Rudolf Meier (National University of Singapore), Jim Miller (AMNH), Jason Mottern (UCR), Norman Penny (California Academy of Sciences), Mike Sharkey (University of Kentucky), and Steffen Roth (University of Bergen).

My current or former colleagues, Wei Song Hwang, Dimitri Forero, Lily Berniker, Zhen Zou and Shiping Liu have been especially helpful and supportive to me and my dissertation research. I have also benefited from interacting with members of the systematic entomology community at UCR: Michael Forthman, Eric Gordon, Jason Mottern, Elizabeth Murray, John Hash, Douglas Yanega, James Munro, Roger Burks, David Hawks, Melissa Yoder and Jeremiah George.

I am also indebted to the support, encouragements and patience afforded by my wife, Jingjing Lou, and members of my family.

Financial support to my dissertation research has come from the National Science Foundation grant PEET DEB-0933853 (to Christiane Weirauch), the Department of Entomology at UCR, the UCR Graduate Division Dissertation Year Fellowship and Dissertation Research Grant, the Robert van den Bosch Scholarship in Biological Control (University of California, Berkeley), and the Smithsonian Institution Graduate Student Fellowship. The text of this dissertation, in part, is a reprint of the material as it appears in *Systematic Entomology* (2011, pp 115-138) and *Acta Zoologica* (2011). The co-author, Christiane Weirauch, listed in these publications directed and supervised the research which forms part of this dissertation.

## ABSTRACT OF THE DISSERTATION

Taxonomy, Phylogenetics, Comparative Morphology and Evolution of Assassin Bugs  
(Hemiptera: Reduviidae) With Emphasis on Harpactorinae and Peiratinae

by

Guanyang Zhang

Doctor of Philosophy, Graduate Program in Entomology  
University of California, Riverside, December 2012  
Dr. Christiane Weirauch, Chairperson

The current dissertation project integrates revisionary taxonomy, comparative morphology, molecular phylogenetics and comparative evolutionary analyses to investigate the diversity and evolution of assassin bugs, focusing on the Malagasy *Bekilya* group (Peiratinae) and the New World Harpactorini (Harpactorinae). Four objectives and research topics are addressed. (1) Association of dimorphic sexes in the *Bekilya* group and taxonomic revisions. Members of three genera of Malagasy Peiratinae, *Bekilya* Villiers, *Hovacoris* Villiers, and *Mutillocoris* Villiers, appear to be mimics of mutillid wasps. *Mutillocoris* was originally described only from female specimens, the two remaining genera from males. Molecular data demonstrate that species of *Mutillocoris* represent females of *Bekilya* and *Hovacoris*. *Mutillocoris* is therefore synonymized with *Bekilya*. The current project treats a total of 10 species as belonging to the *Bekilya* group, including 6 species that are described as new. (2) Investigation of the taxonomic distribution of sticky glands. Specialized glands have been known from species of *Zelus* Fabricius for more than 50 years. The current study examines 67 taxa of Reduviidae and finds sticky glands in 12 genera of Harpactorini. (3) Reconstruct a molecular phylogeny of Harpactorini and investigate the evolution of sticky trap predation and its relationship to accelerated morphological diversification. A

molecular phylogeny of the Harpactorini is presented, sampling 198 taxa of Harpactorini and using 5 genes. Comparative analyses show that bugs exhibiting sticky trap predation have evolved more slender and longer fore femora than non-sticky bugs. Using phylogenetically independent contrast analyses, correlated evolution between femoral thickness and length is documented, thus providing support for the existence of a functional constraint on the fore femur and a trade-off between femoral thickness and length. It is argued that the novel sticky trap predation strategy may allow sticky bugs to alleviate functional constraints on the fore femur and thus to attain a higher rate of fore leg evolution than other Harpactorini or Reduviidae. (4) Taxonomic revision of *Zelus* Fabricius, 1803. The harpactorine genus *Zelus* is revised based on examination of ~11,000 specimens, recognizing 70 species as valid. Twenty-four new species are described, 13 new synonymies proposed, and 5 previously synonymized names are returned to species status. Additionally, eight species that were previously treated as *Zelus* are removed from this genus.



## Table of Contents

Introduction .....	1
References .....	5
<b>Chapter 1: Matching dimorphic sexes and immature stages with adults: resolving the systematics of the <i>Bekilya</i> group of Malagasy assassin bugs (Hemiptera: Reduviidae: Peiratinae)</b>	
Abstract .....	8
Introduction.....	8
Materials and Methods .....	11
Results and discussion.....	18
References .....	60
Figures and Tables.....	64
Supporting Information .....	73
<b>Chapter 2: Sticky predators: a comparative study of sticky glands in harpactorine assassin bugs (Insecta: Hemiptera: Reduviidae)</b>	
Abstract .....	89
Introduction.....	89
Materials and Methods .....	92
Results .....	96
Discussion .....	98
References .....	102
Figures and Tables.....	105
<b>Chapter 3: Novel predation strategy is correlated with accelerated evolution of predatory leg morphology in assassin bugs (Insecta: Hemiptera: Reduviidae)</b>	

Abstract .....	116
Introduction.....	116
Materials and Methods .....	120
Results .....	124
Discussion .....	128
References .....	132
Figures and Tables.....	137
Supporting Information .....	143

**Chapter 4: Taxonomic revision of *Zelus* Fabricius, 1803 (Hemiptera: Reduviidae:**

**Harpactorinae: Harpactorini) of 70 species based on 11,000 specimens**

Abstract .....	172
Introduction.....	172
Materials and Methods .....	173
Results .....	179
References .....	360
Figures and Tables.....	364
<b>Conclusion.....</b>	<b>418</b>

## List of Figures

<b>Figure. 1.1.</b> Habitus of adults of <i>Bekilya</i> spp. and <i>Hovacoris</i> spp. ....	64
<b>Figure. 1.2.</b> SEM images of species of the <i>Bekilya</i> group .....	65
<b>Figure. 1.3.</b> Morphological characters of the species of the <i>Bekilay</i> group and outgroups .....	66
<b>Figure. 1.4.</b> Male genitalia of <i>Bekilya</i> spp. and <i>Hovacoris</i> spp. ....	68
<b>Figure. 1.5.</b> Distributions of <i>Bekilya</i> spp. . ....	69
<b>Figure. 1.6.</b> The most parsimonious tree based on morphological characters of species of the <i>Bekilya</i> group .....	70
<b>Figure. 1.7.</b> Strict consensus of 16 equally most parsimonious trees of species of the <i>Bekilya</i> group based on molecular data .....	71
<b>Figure 2.1.</b> Predation behaviors of <i>Zelus</i> spp. ....	105
<b>Figure 2.2.</b> Illustrations or images of glandular units, saccules of sticky glands, and fore tibia in <i>Zelus</i> spp. ....	106
<b>Figure 2.3.</b> Distribution of sticky glands in <i>Zelus renardii</i> . ....	107
<b>Figure 2.4.</b> Compound microscopic images of glands.....	108
<b>Figure 2.5.</b> Compound microscopic images of fore tibial sticky glands in selected species of Harpactorini .....	109
<b>Figure 2.6.</b> Scanning electron micrographs of sundew and lamellate setae and pores on cuticle in Harpactorini .....	110
<b>Figure 3.1.</b> Molecular phylogeny of Harpactorini .....	137
<b>Figure 3.2.</b> Character evolution of sticky glands, sundew setae, lamellate setae, and fore femur thickness and relative length.....	139

<b>Figure 3.3.</b> Linear regression analysis (through the origin) showing correlation between fore femur thickness and relative length .....	141
<b>Figure 4.1.</b> Habitus images of <i>Zelus minutus</i> Hart 1987, <i>Zelus prolixus</i> Stål, 1860, <i>Zelus rosolentus</i> sp. nov. and <i>Zelus tetracanthus</i> Stål, 1862, <i>Zelus ambulans</i> Stål, 1862, <i>Zelus antiguensis</i> sp. nov., <i>Zelus exsanguis</i> Stål, 1862, <i>Zelus grandoculus</i> sp. nov., <i>Zelus luridus</i> Stål, 1862 and <i>Zelus spatulosus</i> sp. nov.....	364
<b>Figure 4.2.</b> Habitus images of 1987, <i>Zelus inconstans</i> Champion, 1898, <i>Zelus mimus</i> Stål 1862, <i>Zelus grassans</i> Stål, 1862, <i>Zelus illotus</i> Berg, 1879, <i>Zelus impar</i> Kuhlitz, 1902, <i>Zelus nugax</i> Stål, 1862 and <i>Zelus pedestris</i> Fabricius, 1803, <i>Zelus puertoricensis</i> Hart and <i>Zelus bruneri</i> De Zayas, 1960. ....	365
<b>Figure 4.3.</b> Habitus images of <i>Zelus subimpressus</i> Stål, 1872, <i>Zelus cervicalis</i> Stål, 1872 and <i>Zelus renardii</i> Kolenati, 1856, <i>Zelus amblycephalus</i> sp. nov., <i>Zelus annulosus</i> (Stål, 1866), <i>Zelus armillatus</i> (Lepeletier & Serville, 1825), <i>Zelus conjungens</i> (Stål, 1860), <i>Zelus janus</i> Stål, 1862 and <i>Zelus leucogrammus</i> (Perty, 1833). ....	366
<b>Figure 4.4.</b> Habitus images of <i>Zelus lewisi</i> sp. nov., <i>Zelus litigiosus</i> Stål, 1862, <i>Zelus ruficeps</i> , <i>Zelus sulcicollis</i> Champion, 1899, <i>Zelus umbraculoides</i> sp. nov., <i>Zelus umbraculus</i> sp. nov., <i>Zelus aithaleos</i> sp. nov., <i>Zelus bahiaensis</i> sp. nov., <i>Zelus championi</i> sp. nov. and 1803 and <i>Zelus fuliginatus</i> sp. nov. ....	367
<b>Figure 4.5.</b> Habitus images of <i>Zelus errans</i> Fabricius, 1803, <i>Zelus gracilipes</i> sp. nov., <i>Zelus longipes</i> (Linnaeus, 1767), <i>Zelus means</i> Fabricius, 1803, <i>Zelus vagans</i> Fabricius, 1803 and <i>Zelus vespiformis</i> Hart, 1987.....	368

**Figure 4.6.** Habitus images of *Zelus banksi* sp. nov., *Zelus chamaeleon* Stål, 1872, *Zelus cordazulus* sp. nov., *Zelus filicauda* Bergroth, 1893, *Zelus gilboventris* sp. nov., *Zelus korystos* Hart, 1987, *Zelus nigromaculatus* Champion, 1898, *Zelus panamensis* sp. nov., *Zelus truxali* sp. nov., *Zelus varius* (Herrich-Schaeffer, 1853) and *Zelus xouthos* sp. nov. .... 369

**Figure 4.7.** Habitus images of *Zelus auralanus* sp. nov., *Zelus casii* sp. nov., *Zelus erythrocephalus* Fabricius, 1803, *Zelus kartabenooides* sp. nov., *Zelus kartabensis* Haviland, 1931, *Zelus laticornis* (Herrich-Schäffer, 1853), *Zelus mattogrossensis* Wygodzinsky, 1947, *Zelus paracephalus* sp. nov. .... 370

**Figure 4.8.** Habitus images of *Zelus russulumus* sp. nov., *Zelus versicolor* (Herrich-Schäffer, 1848), *Zelus fasciatus* Champion, 1899, *Zelus plagiatus* (Signoret, 1862) and *Zelus sphegeus* Fabricius, 1803. .... 371

**Figure 4.9.** Illustrations of male genitalia of *Z. tetracanthus*, *Z. minutus*, *Z. prolixus*, *Z. exsanguis*, *Z. luridus*, *Z. antiguensis* and *Z. granduculus* ..... 372

**Figure 4.10.** Illustrations of male genitalia of *Z. ambulans*, *Z. spatulosus*, *Z. mimus*, *Z. inconstans*, *Z. impar*, *Z. illotus*, *Z. pedestris* and *Z. nugax*, after Hart (1972) ..... 373

**Figure 4.11.** Illustrations of male genitalia of *Z. grassans*, *Z. puertoricensis*, *Z. subimpressus*, *Z. renardii* and *Z. cervicalis* ..... 374

**Figure 4.12.** Illustrations of male genitalia of *Z. amblycephalus*, *Z. annulosus*, *Z. armillatus*, *Z. janus* and *Z. conjugens* ..... 375

**Figure 4.13.** Illustrations of male genitalia of *Z. leucogrammus*, *Z. litigiosus*, *Z. ruficeps*, *Z. sulcicollis* and *Z. umbraculus* ..... 376

<b>Figure 4.14.</b> Illustrations of male genitalia of <i>Z. longipes</i> , <i>Z. vespiformis</i> , <i>Z. baiaensis</i> , <i>Z. errans</i> , <i>Z. gracilipes</i> and <i>Z. aithaleos</i> .....	377
<b>Figure 4.15.</b> Illustrations of male genitalia of <i>Z. vagans</i> , <i>Z. fuliginatus</i> , <i>Z. championi</i> , <i>Z. xouthos</i> , <i>Z. korystos</i> and <i>Z. filicauda</i> .....	378
<b>Figure 4.16.</b> Illustrations of male genitalia of <i>Z. banksi</i> , <i>Z. gilboventris</i> , <i>Z. cordazulus</i> , <i>Z. varius</i> , <i>Z. truxali</i> , <i>Z. chamaeleon</i> and <i>Z. panamensis</i> .....	379
<b>Figure 4.17.</b> Illustrations of male genitalia of <i>Z. kartabensis</i> , <i>Z. auralanus</i> , <i>Z. versicolor</i> , <i>Z. laticornis</i> and <i>Z. mattogrossensis</i> .....	380
<b>Figure 4.18.</b> Illustrations of male genitalia of <i>Z. russulumus</i> , <i>Z. casii</i> , <i>Z. paracephalus</i> , and <i>Z. erythrocephalus</i> .....	381
<b>Figure 4.19.</b> Distributions of <i>Z. minutus</i> , <i>Z. prolixus</i> and <i>Z. rosolentus</i> .....	382
<b>Figure 4.20.</b> Distribution of <i>Z. tetracanthus</i> .....	383
<b>Figure 4.21.</b> Distributions of <i>Z. luridus</i> , <i>Z. granduculus</i> , <i>Z. antiguensis</i> , <i>Z. ambulans</i> .....	384
<b>Figure 4.22.</b> Distributions of <i>Z. mimus</i> and <i>Z. inconstans</i> .....	385
<b>Figure 4.23.</b> Distributions of <i>Z. grassans</i> , <i>Z. illotus</i> and <i>Z. impar</i> .....	386
<b>Figure 4.24.</b> Distributions of <i>Z. nugax</i> and <i>Z. pedestris</i> .....	387
<b>Figure 4.25.</b> Distributions of <i>Z. puertoricensis</i> , <i>Z. subimpressus</i> and <i>Z. zayasi</i> .....	388
<b>Figure 4.26.</b> Distributions of <i>Z. cervicalis</i> and <i>Z. renardii</i> .....	389
<b>Figure 4.27.</b> Distributions of <i>Z. sulcicollis</i> , <i>Z. litigiosus</i> , <i>Z. lewisi</i> and <i>Z. janus</i> ..	390
<b>Figure 4.28.</b> Distributions of <i>Z. umbraculoides</i> , <i>Z. umbraculus</i> , <i>Z. conjungens</i> , <i>Z. leucogrammus</i> and <i>Z. annulosus</i> .....	391
<b>Figure 4.29.</b> Distributions of <i>Z. ruficeps</i> and <i>Z. amblycephalus</i> .....	392

<b>Figure 4.30.</b> Distribution of <i>Z. armillatus</i> .....	393
<b>Figure 4.31.</b> Distributions of <i>Z. vagans</i> , <i>Z. means</i> , <i>Z. gracilipes</i> , <i>Z. championi</i> and <i>Z. aithaleos</i> .....	394
<b>Figure 4.32.</b> Distributions of <i>Z. bahiaensis</i> , <i>Z. errans</i> and <i>Z. vespiformis</i> .....	395
<b>Figure 4.33.</b> Distribution of <i>Z. longipes</i> .....	396
<b>Figure 4.34.</b> Distributions of <i>Z. korystos</i> , <i>Z. gilboventris</i> , <i>Z. filicauda</i> , <i>Z.</i> <i>cordazulus</i> , <i>Z. chamaeleon</i> and <i>Z. banksi</i> .....	397
<b>Figure 4.35.</b> Distributions of <i>Z. nigromaculatus</i> , <i>Z. xouthos</i> , <i>Z. varius</i> and <i>Z.</i> <i>panamensis</i> .....	398
<b>Figure 4.36.</b> Distributions of <i>Z. erythrocephalus</i> , <i>Z. versicolor</i> , <i>Z.</i> <i>mattogrossensis</i> , <i>Z. russulumus</i> and <i>Z. paracephalus</i> .....	399
<b>Figure 4.37.</b> Distributions of <i>Z. auralanus</i> , <i>Z. laticornis</i> , <i>Z. kartabenoides</i> , <i>Z.</i> <i>kartabensis</i> and <i>Z. casii</i> .....	400
<b>Figure 4.38.</b> Distributions of <i>Z. fasciatus</i> , <i>Z. plagiatus</i> and <i>Z. spegeus</i> .....	401

## List of Tables

<b>Table 1.1.</b> Pairwise genetic distances between <i>COI</i> sequences of species of the <i>Bekilya</i> group.....	72
<b>Table 2.1.</b> Taxonomic distribution and morphological characterizations of sticky glands and specialized tibial setae in Harpactorini.....	111
<b>Table 2.2.</b> Examined reduviid taxa without sticky glands, including classification and voucher information.....	112
<b>Table 3.1.</b> Morphological evolutionary rate tests using Brownie .....	142
<b>Table 4.1.</b> List of collections, acronyms and managers/curators in charge .....	402
<b>Table 4.2.</b> Measurements of <i>Zelus</i> spp.....	403



## INTRODUCTION

With close to 7,000 species, Reduviidae, the assassin bugs, are the second largest and one of the morphologically and ecologically most diverse families of true bugs (Hemiptera: Heteroptera) (Putshkov & Putshkov, 1986-89; Froeschner & Kormilev, 1989; Maldonado, 1990; Schuh & Slater, 1995). Reduviids exhibit prey specializations and special predation strategies such as millipede-feeding in the Ectrichodiinae (Forthman; 2012), spider-hunting in the thread-legged bugs or Emesinae (Wignall & Taylor, 2008; Wygodzinsky 1966), blood-feeding in the Triatominae (Lent & Wygodzinsky, 1979) and resin/sticky trap predation in the Harpactorinae (Forero et al., 2011; Weirauch 2006).

Despite the fascinating biology of Reduviidae, only a few recent systematists work on the group. Monographic taxonomic revisions are lacking for the majority of species. Modern phylogenetic analyses of subfamilial relationships did not exist until Weirauch (2008) (but see Clayton 1990 for an unpublished cladistic analysis). Several subfamilies (Maldonado 1990) such as Saicinae (~138 spp.), Salyavatinae (~98 spp.), and Reduviinae (~1,000 spp.) are ill-defined and possibly paraphyletic or polyphyletic (Weirauch, 2008; Weirauch & Munro, 2009). Few studies have performed phylogenetic analyses within the subfamilies (e.g., Dougherty, 1995; Forero et al. 2013). The lack of phylogenetic hypotheses and the rather incomplete knowledge of the diversity of assassin bugs preclude a rigorous understanding of the evolutionary history of this fascinating group of insects.

The current dissertation project integrates revisionary taxonomy, comparative morphology, and molecular phylogenetics to improve our systematic knowledge of Reduviidae by revising the taxonomy of the Malagasy *Bekilya* group, whose members are apparently mimics of mutillid wasps, studying the comparative morphology of sticky

glands, investigating the phylogenetics of Harpactorini, and conducting a monographic revision of *Zelus* Fabricius 1803 (Harpactorini).

*Malagasy mutillid mimicking peiratines and the problem of associating sexually dimorphic sexes* – Villiers described three genera of Peiratinae from Madagascar, *Bekilya* Villiers, *Hovacoris* Villiers and *Mutillocoris* Villiers, and distinguished them from other Malagasy peiratines by the presence of distinctive tubercles on the pronotal lobe (Villiers 1968). *Bekilya* and *Hovacoris* are monotypic and based on single macropterous male specimens, whereas *Mutillocoris* contains two species, each based on a single brachypterous female specimen. Members of these genera appear to be mimics of velvet ants (Hymenoptera: Mutillidae). The orange-colored body, heavy setation, and bright patches of setae on the abdomen of females and immature stages closely resemble the patterns seen in velvet ants. Recently collected material by the California Academy of Sciences contained representatives of all three genera and provided an opportunity to test the validity of the genera and investigate whether members of *Mutillocoris* actually represent females of the other genera.

*Comparative morphology of sticky trap predation in Zelus and Harpactorinae* – Fourteen genera within Ectinoderini, Apiomerini and Harpactorini are known to be associated with plants that produce resins or sticky substances (Berénger & Pluot-Sigwalt, 1997). Species of Ectinoderini, Apiomerini and Diaspidiini collect plant resins, which are smeared onto the legs and body and used to capture prey or glue eggs into a clutch (Usinger 1958; Choe & Rust, 2007; Forero et al. 2011). Members of these three tribes are called resin bugs (Davis, 1969). Resin-collecting has not been documented in members of the tribe Harpactorini. By contrast, species of *Zelus* utilize an endogenous source of sticky substances. Four species of *Zelus*, *Zelus leucogrammus* (Perty), *Zelus*

*longipes* (Linnaeus), *Zelus luridus* Stål, and *Zelus renardii* Kolenati are documented to secrete sticky substances from dermal glands on the front tibiae (Barth, 1952; Weirauch, 2006; Wolf & Reid, 2001). The sticky secretions are retained by specialized setae resembling the trichomes of sundew leaves (Weirauch, 2006; Wolf & Reid, 2001). Behavioral observations (Weirauch, 2006) suggest that the sticky substances secreted onto the front tibiae assist the bugs in capturing prey. No studies have investigated homologous structures on the front tibiae of other genera of Harpactorini and the taxonomic distribution and the phylogenetic origin of this phenomenon are therefore unknown. Only two anecdotal records are published: Readio (1927) mentioned secretory setae in *Pselliopus cinctus* (Fabricius) without documentation of the structures involved, and Cobben & Wygodzinsky (1975) speculated on the existence of sticky setae in *Cosmoclopius curacavensis* Cobben & Wygodzinsky. The current study aims to address this deficiency of knowledge by performing comparative morphological examinations of representative genera of Harpactorini.

*Harpactorini: molecular phylogeny and evolution of sticky trap predation –*

Harpactorini currently comprise 289 genera and 2003 described species (Maldonado, 1990), i.e. 87% of the species diversity of Harpactorinae and 30% of that of Reduviidae. Harpactorini contain some of the largest genera in Reduviidae such as *Sphedanolestes* Stål (181 spp.) and *Rhynocoris* Kolenati (118 spp.) from the Old World and *Zelus* Fabricius (60 spp.) from the New World (Maldonado 1990). To date no comprehensive phylogenetic analyses of Harpactorini are available and the monophyly of this tribe remains contentious. A recent molecular phylogeny of Reduviidae recovered the paraphyly of Harpactorini with respect to Rhabdosomini (Harpactorinae) (Weirauch & Munro, 2009). The current study represents a first attempt to reconstruct the phylogeny

of Harpactorini and investigate the evolution of the unique sticky trap predation strategy and its relationship to morphological diversification of the predatory leg in light of that phylogeny.

*Zelus: natural enemies & systematics* – With 60 valid species and a total of ~70 estimated species, *Zelus* is one of the largest genera of Reduviidae (Hart, 1972; Maldonado, 1990). Its species are among the most frequently collected reduviids in the New World as indicated by the large number of specimens in museums (>10,000). Species of *Zelus*, among several other genera of Harpactorinae (e.g., *Arilus* Hahn, *Sinea* Amyot & Serville, and *Montina* Amyot & Serville) have been explored and studied as natural enemies in the Americas (Cogni et al. 2002, Cohen & Tang 1997, reviewed in Hagen et al. 1999). To advance the research on *Zelus* spp. as natural enemies, reliable taxonomic information such as accurate species description and correct species identification is indispensable since misidentifications can arise easily for similar species. My dissertation research takes advantage of the abundance of available material from museums and collections to produce a monographic revision of this genus.

## References

- Barth, R. 1952. Dei Fangdruse an den Beine von *Zelus (Diplocodus) leucogrammus* (Perty). *Zoologische Jahrbücher*, 73, 323-336.
- Bérenger, J-M and Pluot-Sigwalt, D. 1997. Relations privilégiées de certain Heteroptera Reduviidae prédateurs avec les végétaux. Premier cas connu dun Harpactorinae phytophage. (Special relationships of certain predatory Heteroptera Reduviidae with plants. First known case of a phytophagous Harpactorinae). *Comptes Rendus de l'Académie des Sciences*, 320, 1007-1012.
- Choe, D.-H. and Rust, M. K. 2007. Use of Plant Resin by a Bee Assassin Bug, *Apiomerus flaviventris* (Hemiptera: Reduviidae). *Annals of the Entomological Society of America*, 100, 320-326.
- Clayton, R. A. 1990. *A Phylogenetic Analysis of the Reduviidae (Hemiptera: Heteroptera) with Redescription of the Subfamilies and Tribes*. Dissertation, The George Washington University, Washington D.C., 191 pp.
- Cobben, R. and Wygodzinsky, P. 1975. The Heteroptera of the Netherlands Antilles – IX. Reduviidae Assassin Bugs). *Studies on the Fauna of Curaçao and other Caribbean Islands*, 48, 1-62.
- Cogni, R., Freitas, A. V. L. and Amaral Filho, B. F. 2002. Influence of prey size on predation success by *Zelus longipes* L. (Het., Reduviidae). *Journal of Applied Entomology*, 126, 74-78.
- Cohen, A. C. and Tang, R. 1997. Relative prey weight influences handling time and biomass extraction in *Sinea confusa* and *Zelus renardii* (Heteroptera: Reduviidae). *Environmental Entomology*, 26, 559-565.
- Davis, N. T. 1969. Contribution to the morphology and phylogeny of the Reduvoidea. Part 4. The harpactoroid complex. *Annals of the Entomological Society of America*, 62, 74-94.
- Dougherty, V. 1995. A review of the New World Ectrichodiinae genera (Hemiptera: Reduviidae). *Transactions of the American Entomological Society*, 121, 173-225.
- Forero, D., Choe, D-H, Weirauch, C. 2011. Resin gathering in Neotropical resin bugs (Insecta: Hemiptera: Reduviidae): functional and comparative morphology. *Journal of Morphology*, 272, 204-229.
- Forero, D., Berniker, L., Weirauch, C. 2013. Phylogeny and character evolution in the bee-assassins (Insecta: Heteroptera: Reduviidae). *Molecular Phylogenetics and Evolution*, 66, 283-302

- Forthman, M. and Weirauch, C. 2012. Toxic associations: a review of the predatory behaviors of millipede assassin bugs (Hemiptera: Reduviidae: Ectrichodiinae). *European Journal of Entomology*, 109, 147-153.
- Froeschner, R. and Kormilev, N. 1989. Phymatidae of the World – A synonymic list with keys to species except *Lophoscutus* and *Phymata*. *Entomography*, 6, 1-76.
- Hagen, K. S., Mills, N. J., Gordh, G. and Mcmurty, J. A. 1999. Terrestrial arthropod predators of insect and mite pests. Chapter 16. In: *Handbook of Biological Control: Principles and Application of Biological Control* (T. Bellows, et al. Eds.) Academic Press. pp. 382-504.
- Hart, E. R. 1972. *A Systematic Revision of the Genus Zelus Fabricius (Hemiptera: Reduviidae)*. Ph.D dissertation. Texas A&M University.
- Hart, E. R. 1986. Genus *Zelus* Fabricius in the United States, Canada, and Northern Mexico (Hemiptera: Reduviidae). *Annals of the Entomological Society of America*, 79, 535-548.
- Hart, E. R. 1987. The genus *Zelus* Fabricius in the West Indies (Hemiptera: Reduviidae). *Annals of the Entomological Society of America*, 80, 293-305.
- Lent, H. and Wygodzinsky, P. 1979. Revision of the Triatominae (Hemiptera, Reduviidae), and their significance as vectors of Chagas' disease. *Bulletin of American Museum of Natural History*, 163, 125-520.
- Maldonado, J. 1990. Systematic catalogue of the Reduviidae of the World. *Caribbean Journal of Science*, Special publication No. 1, University of Puerto Rico, Mayagüez, Puerto Rico, 694 pp.
- Putshkov, V. G. and Putshkov, P. V. 1986-1989. *A catalogue of the Reduviidae (Heteroptera) of the world*. Vinity, Lyubertsy. 6 volumes.
- Radio, P.A. 1927 Studies on the biology of the Reduviidae of America north of Mexico. University of Kansas Science Bulletin 17, 5-291.
- Schuh, R. T. and Slater, J. A. 1995. *True bugs of the world (Hemiptera: Heteroptera). Classification and natural history*. Cornell University Press, Ithaca, USA. 336 p.
- Usinger, R. L. 1958. Harzwanzen or “resin bugs” in Thailand. Pan-Pac. Entomol. 34, 52.
- Villiers, A. 1968. Insectes. Hémiptères. Reduviidae. (1<sup>ère</sup> partie). *Faune de Madagascar*, 28, 1-198.
- Weirauch, C. 2006. Observations on the sticky trap predator *Zelus luridus* Stål (Heteroptera, Reduviidae, Harpactorinae), with the description of a novel gland associated with the female genitalia. *Denisia*, 19, 1169-1180.

- Weirauch, C. 2008. Cladistic analysis of Reduviidae (Heteroptera: Cimicomorpha) based on morphological characters. *Systematic Entomology*, 33, 229-274.
- Weirauch, C. and Munro, J. 2009. A molecular phylogeny of Reduviidae based on ribosomal genes. *Molecular Phylogenetics and Evolution* 53, 287-299.
- Wignall A. E. and Taylor, P. W. 2008. Biology and life history of the araneophagic assassin bug *Stenolemus bituberus* including a morphometric analysis of the instars (Heteroptera, Reduviidae). *Journal of Natural History* 42, 59-76.
- Wolf, K. W. and W. Reid. 2001. Surface morphology of legs in the assassin bug *Zelus longipes* (Hemiptera: Reduviidae): a scanning electron microscopy study with an emphasis on hairs and pores. *Annals of the Entomological Society of America* 94, 457-461.
- Wygodzinsky, P. W. 1966. A monograph of the Emesinae (Reduviidae: Hemiptera). *Bulletin of the American Museum of Natural History*, 133, 1-614.

**CHAPTER 1: Matching dimorphic sexes and immature stages with adults:  
resolving the systematics of the *Bekilya* group of Malagasy assassin bugs  
(Hemiptera: Reduviidae: Peiratinae)**

**Abstract**

The Madagascar endemic assassin bugs *Bekilya* Villiers and *Hovacoris* Villiers were described from macropterous male specimens with striking color patterns, and are currently monotypic. *Mutillocoris* Villiers, with two species from Madagascar, was based on brachypterous female specimens that resemble female mutillid wasps. To investigate the validity of the three genera, recently collected specimens from Madagascar were studied with both morphological and molecular techniques. Morphology alone appeared to be of limited value for associating males with females and immature stages with adults because of drastic differences between the sexes and the life stages. However, its use in conjunction with molecular data resolved these associations and showed that species of *Mutillocoris* represent females of *Bekilya* and *Hovacoris*, which we transfer accordingly to these two genera as the *Bekilya* group. The type species of *Mutillocoris* belongs in *Bekilya*, resulting in the synonymy of these two genera (*Mutillocoris* **syn. nov.**). The *Bekilya* group is diagnosed and several new species described, viz: *Bekilya mahafalya* **sp. nov.**, *B. tenebra* **sp. nov.** and *B. tuleara* **sp. nov.**, *Hovacoris bicolornotum* **sp. nov.**, *H. melanoceps* **sp. nov.** and *H. rufiventris* **sp. nov.** A total of ten species are recognized within the *Bekilya* group. The monophyly of *Bekilya*, *Hovacoris* and the *Bekilya* group is confirmed by morphological and molecular phylogenetic analyses.



## Introduction

Combining high species richness and drastic loss of primary vegetation, Madagascar is one of the Biodiversity Hotspots and a critical conservation priority (Myers *et al.*, 2000; Goodman & Benstead, 2005). Taxonomic surveys and studies of the Malagasy flora and fauna are in urgent need in view of constant habitat loss, invasion of exotic species (Green & Sussman, 1990; Fisher, 2005) and poor knowledge of the island's species richness and endemism (Goodman & Benstead, 2005; Schatz, 2002). The "Terrestrial Arthropod Inventory of Madagascar" project led by Brian Fisher and Charles Griswold at the California Academy of Sciences (CAS) addresses this need for taxonomic exploration focusing on the mega-diverse arthropods. Some taxonomic studies based on material from this project are completed (e.g., Brailovsky, 2006; Fisher & Smith 2008; Göllner-Scheiding, 2005; Heterick, 2006), but much material remains to be studied (D. Penny, pers. comm.). Our laboratory focuses on Reduviidae (Hemiptera: Heteroptera) or assassin bugs derived from the Malagasy Arthropod Survey that currently comprise ~3,000 specimens (Weirauch, 2008a; Hwang & Weirauch, in press; Radabaugh & Weirauch, in prep.).

With more than 6,600 described species (Maldonado, 1990; Putshkov & Putshkov 1986–1989), Reduviidae are the second largest family of Heteroptera (Schuh & Slater, 1995) and exhibit an amazing array of morphological and ecological diversity. By 1990, about 238 species of reduviids were recorded from Madagascar (Maldonado, 1990). The most recent comprehensive taxonomic treatments of Malagasy Reduviidae were conducted by André Villiers, who over a period of 31 years (1948–79) described almost two thirds of Madagascar's known reduviid species. Since then very little

taxonomic work has been carried out on the Malagasy reduviid fauna (but see Labina & Kerzhner, 2000; Maldonado, 1988; Weirauch, 2008a).

Peiratinae currently comprise 34 genera and about 342 described species (Cai & Taylor, 2006; Gil-Santana & Costa, 2003; Moulet, 2000; Maldonado, 1990). Peiratinae have a worldwide distribution, but show greatest diversity in tropical areas (Willemse, 1985). About 6% of Peiratinae, i.e. 21 species, are described from Madagascar (Villiers, 1968).

Villiers described three new genera of Peiratinae from Madagascar, *Bekilya* Villiers, 1949, *Hovacoris* Villiers, 1964, and *Mutillocoris* Villiers, 1964, and distinguished them from other Malagasy peiratines by the presence of distinctive tubercles on the pronotal lobe (Villiers, 1968). Here we refer to this group of genera as the *Bekilya* group. *Bekilya* and *Hovacoris* are monotypic and based on single macropterous male specimens, while *Mutillocoris* contains two species, both based on single brachypterous female specimens. *Hovacoris* was distinguished from *Bekilya* and *Mutillocoris* in its regularly-arranged tubercles of granulated lines on the anterior pronotal lobe. *Mutillocoris* was diagnosed by brachyptery. Species of the *Bekilya* group possibly are mimics of velvet ants (Hymenoptera: Mutillidae). The orange-colored body, heavy setation, and bright patches of setae on the abdomen of females and immature stages closely resemble patterns seen in velvet ants.

Specimens of the three genera of the *Bekilya* group are represented in the CAS material. During sorting, we noticed that males and females could not be matched due to drastic morphological differences even when several male (macropterous) and female (brachypterous) specimens occurred in sympatry. Following Villiers' classification, they would be placed in two genera, *Bekilya* and *Mutillocoris*. However, we hypothesized that

males and females of the same species could be present as sexual dimorphism in wing morphs is widespread in Reduviidae (e.g., Wygodzinsky, 1966 [Emesinae]; Dougherty, 1995 [Ectrichodiinae]), and occurs in several peiratine genera such as *Lestomerus* Amyot & Serville, *Ectomocoris* Mayr, and *Catamiarus* Amyot & Serville. Further, we encountered immature specimens from several localities that have granulated pronotal lobes, a character that suggests their placement in the *Bekilya* group. To test our hypothesis and associate immature stages with adults we obtained DNA sequences of the mitochondrial gene Cytochrome c Oxidase Subunit I (*COI*) from six species. Using DNA sequences to associate sexually dimorphic specimens and different life stages has been successful in various holometabolous insect groups including velvet ants (Mutillidae) (Pilgrim & Pitts, 2006), dytiscid beetles (Miller *et al.*, 2005), histerid beetles (Caterino & Tishechkin, 2006), staphylinid beetles (Jeon & Ahn, 2009), Lycid beetles (Levkanicova & Bocak, 2009), hydropsychid caddisflies (Zhou *et al.*, 2007), chironomid flies (Cranston, 2009), and Strepsiptera (Kathirithamby *et al.*, 2010).

The CAS material also harbored 6 undescribed species belonging to the *Bekilya* group. In our study, we examine the potential synonymy of genera, associate males with females and immature stages with adults, describe new species, redescribe existing species and genera, and conduct species-level phylogenetic analyses based on both morphological and molecular data.

## **Material and Methods**

### *Specimens*

The two hundred and twelve specimens belonging to the *Bekilya* genus group were examined in this project were collected by the CAS using various methods including

malaise traps, pitfall traps and sifting of leaf litter. Holotypes of *Bekilya mira* Villiers, 1949, *Hovacoris bipunctatus* Villiers, 1964, *Mutillocoris tricolor* Villiers, 1964 and *Mutillocoris vadoni* Villiers, 1968 are deposited at the Muséum national d'Histoire naturelle (Paris, France) (MNHN). These were not examined physically due to loan policies of that museum and instead, habitus photos were used for evaluating species concepts. Each specimen was assigned a Unique Specimen Identifier (USI) label. "UCR\_ENT" was used as the prefix of the USI labels and the depositories (e.g., CAS\_ENT) of the specimens were indicated on the label. A caslot number with prefix 'caslot' and a collection code designated by CAS are included for each specimen and presented as "[caslot .../'collection code']". Specimens deposited at the MNHN were not attached with USI labels, and some have a museum code with prefix 'MNHN (EH)'. Acronyms of depositories of specimens are included in parentheses at the end of specimen information. The following immature specimens were not associated with adults: MADAGASCAR: Mahajanga: Forêt Ambohimanga, 26.1 km 314° Mampikony, 15.96277°S 47.43805°E, 250 m, 13 Dec 2004, B.L.Fisher, 2 specs (UCR\_ENT 00005314–5 [caslot 029434/BLF11672]) (CAS). Institutional depositories and their acronyms are as follows:

AMNH-American Museum of Natural History, New York

CAS-California Academy of Sciences, San Francisco

MNHN-Muséum national d'Histoire naturelle, Paris

UCR- Entomology Research Museum at the University of California, Riverside,  
Riverside

Initials of collectors of the CAS are used in the collecting event information and they are: CAS - Frontier Wilderness Project (as CAS-FWP), F. Parker (as FP), M. Irwin (as MI), Ra. Harin'Hala (as RHH)

#### *Databasing and distribution maps*

All specimens with USI labels examined were databased using the Planetary Biodiversity Inventory (PBI) for Plant Bugs project locality database [<https://research.amnh.org/pbi/locality>]. Distribution maps were generated with DIVA-GIS [<http://www.diva-gis.org/>] based on coordinates downloaded from the PBI database. All CAS specimens have coordinates on their locality labels. Coordinates of historical locality data were estimated with the georeferencing software GEOLocate (Rios and Bart, 2005) in conjunction with Global Gazetteer at <http://www.fallingrain.com> and were included in brackets '['']. The locality of *Hovacoris vadoni* (Villiers, 1968) comb.n. could not be determined unambiguously and thus was excluded in the distribution maps. The locality label of *Bekilya tricolor* (Villiers, 1964) comb.n. reads 'Route Tsihombe, Beloha'. The locality of that species was plotted at the midpoint of the line connecting the two places drawn in Google Earth. Locality information is available and distributions can be viewed through the global mapper at [http://www.discoverlife.org/mp/20m?act=make\\_map](http://www.discoverlife.org/mp/20m?act=make_map). Geographic distances between localities were estimated with Google Earth by plotting a straight line between two localities.

#### *Morphological methods and measurements*

Habitus images of pinned specimens (dorsal, lateral, and ventral views) were taken with a Microptics-USA imaging system. Male genitalia including the eighth abdominal

segment, the pygophore, and the phallus were removed, cleared in heated 10% potassium hydroxide (KOH) solution for 5–10 minutes, washed in distilled water, and stored in glycerol. Phallus, parameres, and pygophore were dissected, temporarily mounted in glycerin gelatin, and photos taken with an Auto–montage GT–Vision imaging system. Dissected body parts were stored in genitalic vials and attached to the specimens. Scanning electron microscopy (SEM) images of uncoated specimens were obtained with a Hitachi TM 1000 table top SEM at the Institute for Integrative Genome Biology at UC Riverside. Line drawings were made with a camera lucida on a Nikon SMZ 1500 stereomicroscope. Photos were edited with ADOBE PHOTOSHOP CS3 and plates were assembled with CORELDRAW X3 (Version 13). Measurements (Supporting Information 1.1) were done with a Nikon SMZ 15000 stereomicroscope mounted with a micrometer.

#### *Terminology and abbreviations*

Terminology follows Davis (1966), Weirauch (2007, 2008b) and Willemse (1985). The term lateral phallothecal plate (Fig. 1.4) is used for the first time. It refers to a sclerite only present on the right lateral side of the phallotheca. It is posteriorly fused with the phallotheca, dorsally in contact with the dorsal phallothecal sclerite, and extends anteriorly like a broad process.

Abbreviations: cu, cubitus; dphap, apex of dorsal phallothecal sclerite; dphs, dorsal phallothecal sclerite; est, endosomal struts of aedeagus; fs, fossula spongiosa; lphap, apex of lateral phallothecal plate; lphp, lateral phallothecal plate; mxpl, maxillary plate; pygmpr, median process of pygophore; par, paramere; parst, paramere stem; pcu, post-cubitus.

### *Morphological characters and phylogenetic analysis*

Fifty eight characters derived from Colour, vestiture, and structures including male genitalia were coded. Characters are based on male specimens. The character and character states list is presented in Supporting Information 1.2. The morphological character matrix (Supporting Information 1.3) was generated with the software DDescriptive Language for TAxonomy (DELTA) (Dallwitz, 1980; Dallwitz, Paine & Zurcher, 1999 onwards). It comprises 10 taxa, including seven species of the *Bekilya* group as ingroups and three species as outgroups that represent three genera of Peiratinae occurring in Madagascar. Three species of the *Bekilya* group, *B. mira*, *B. tricolor* comb.n., *H. vadoni* comb.n., were excluded due to lack of material. Also, the latter two species are known from female singletons and thus are unsuitable for the morphological phylogenetic analysis. Three characters (Supporting Information 1.2, 1.3; character No. 15, 27, 53) were inapplicable in *Sirthenea* sp., the taxon used to root the tree. Most (42) characters were coded as binary; 16 characters were multistate and were coded as non-additive. Forty three characters were parsimony informative. Fifteen parsimony uninformative autapomorphic characters were included because of their potential as species-level diagnostic characters.

The phylogenetic analysis was performed with NONA (Version 2) (Goloboff, 1999) spawned from WinClada (Version 1.00.08) (Nixon, 1999–2002). *Sirthenea* sp. was used to root the tree. A heuristic search was carried out holding a maximum of 10,001 trees in memory, with 1000 replications and 10 trees to hold per replication, in random addition sequence. For each replication a Subtree Pruning and Regrafting (SPR) and a Tree Bisection and Reconnection (TBR) were performed. Characters were optimized

unambiguously on the most parsimonious tree in WinClada, treating each additional occurrence of a character state as homoplastic.

#### *Descriptions and diagnoses*

Observations of morphological characters were recorded with DELTA. Natural descriptive language was exported and edited. Generic descriptions contain all characters, but invariable characters were not repeated in the description of each species. Diagnoses of the genera *Bekilya* and *Hovacoris* are based on synapomorphies revealed in the phylogenetic analyses using unambiguous optimization. Some characters used in the diagnoses were not included in the phylogenetic analyses because they are valuable for distinguishing the *Bekilya* group from other peiratine genera. Diagnoses of each species are autapomorphies or unique characters regardless of character polarity. Diagnoses of females could not be based on a phylogenetic analysis and unique characters were used.

#### *Molecular data and phylogenetic analysis*

Twenty five specimens were sequenced, 20 of which belong to the *Bekilya* group and 5 to other Peiratinae genera. The right hind leg or tibia was excised from each specimen. Genomic DNA extractions were conducted using the QIAGEN DNeasy Blood & Tissue Kit®. *COI* primers C1–J–2183 (CAACATTTATTTTGATTTTTTGG, forward) (Simon *et al.* 1994) and C1–N–2609 (CGAATACTGCTCCTATTGATA, reverse) (Damgaard *et al.* 2000) were used. Amplifications were performed using GE Healthcare Life Sciences PuReTaq–Ready–To–Go–PCR–Beads™. The PCR reactions consisted of denaturation 94°C (30 sec.), annealing 48°C (30 sec.) and extension 72°C (45 sec.) for 35 cycles; with initial denaturation 94°C (2 min.) and final extension 72°C (7 min). PCR products



were gene-cleaned using Bio 101 GENE CLEAN Kit® or SureClean. Sequencing was performed at the UC Riverside Core Instrumentation Facility using an ABI 340 sequencing machine. Sequences were verified with Sequencher 4.8™. Beginning and ending nucleotides with unresolved chromatograms were deleted. All sequences were checked with the software 'Molecular Evolutionary Genetics Analysis' (MEGA) (Kumar *et al.*, 2008; Tamura *et al.*, 2007) to make sure they are translatable. Sequences are available at GenBank under the accession numbers listed in Supporting Information 1.4. Sequence lengths range from 373 to 471 base pairs (bp). The complete *COI* sequence of *Triatoma dimidiata* was obtained from GenBank (Accession No. NC\_002609, Region: 1388..2921). The alignment was performed with MAFFT (Katoh *et al.* 2002; Katoh *et al.* 2005) via the online server using the default settings [<http://align.bmr.kyushu-u.ac.jp/mafft/software/>]. No gaps were present in the alignment. Non-overlapping regions between *T. dimidiata* and sequences of species of the *Bekilya* group were deleted. The resulting alignment consisted of 26 sequences with 471 bp.

The software TNT (version 1.1.) (Goloboff *et al.*, 2008) was used to perform the phylogenetic analysis, obtaining trees from random addition sequences with 1000 replicates, using the New Technology search function with all four tree-searching methods: sectorial search, with RSS and CSS options chosen; tree fusing with three rounds, the parsimony Ratchet and Drift. A strict consensus of multiple equally most parsimonious trees was then generated. A bootstrap analysis was performed with 1000 replicates with the above setting. Bootstrap values above 50% were indicated on the strict consensus tree.

### *Genetic analyses of COI sequences*

Uncorrected pairwise genetic distances were computed using the program package TaxonDNA (Meier *et al.* 2006). Smallest distances between sequences of unidentified female and immature and identified male and adult specimens were reported and compared with distances to the next closest sequences (Table 1.1).

### **Results and Discussion**

Results from the above studies revealed previously unknown associations between male, female and immature stages of the *Bekilya* group, the synonymy of *Bekilya* with *Mutillocoris*, the monophyly of *Bekilya*, *Hovacoris* and *Bekilya* group, and several new species (see below). Nomenclatorial changes are summarized in a checklist (Supporting Information 1.5).

### *Associating male and female, and immature and adults*

The associations of female with male and immature stages with adults were based on three lines of evidence: small genetic distance to the closest sequence of a male or adult specimen, close or identical locality to male or adult specimens, and morphological similarities to matching male or adult specimens. Final decisions are based on congruence among molecular, morphological and geographical information (DeSalle *et al.* 2005), although molecular data took the primacy.

Small genetic distances indicate possible species membership, but does not necessarily confirm it per se. Among several groups of arthropods studied by Meier *et al.* (2008), 7.4% to 15.2% species had genetic distances below 1% to allospecific sequences for *COI*. Here, the shortest distances that sequences of unidentified female and immature specimens had to an identified male or adult specimen sequence ranged

from 0.2% to 1.8% (Table 1.1). These values were much smaller than the smallest interspecific distance (10.2%) found in the *Bekilya* group, and we decided to treat these values as intraspecific distances and thus provide evidence for conspecificity. In the molecular phylogenetic analysis with parsimony the sequences of the female or immature specimens also were nested within or 'sister' to the sequences of the male or adult specimens to which they had the closest distances, further corroborating their species memberships (Fig. 1.7). The evidence provided from molecular data were corroborated further by the collection of female and immature specimens from identical or close localities to the male or adult specimens that had the closest matching sequences. However, proximity itself does not confirm species identity since different species such as *H. bipunctatus* and *Bekilya tenebra* **sp. nov.** were sympatric. Lastly, morphology was used to strengthen the hypotheses and discussions of morphology are presented in the taxonomy section.

However, we could not associate the immature specimens from the province Mahajanga to adult specimens. The sequence (GenBank accession No. GU198529) of one of these immature specimens had a closest match to a specimen of *H. bipunctatus* collected about 1,000 km away with a genetic distance of 9.4%. This value was very close to the smallest interspecific distance (10.2%) and also the largest intraspecific distance (11.0%) found in the *Bekilya* group, so it is difficult to determine whether it is intraspecific or interspecific. In the consensus tree obtained from the molecular phylogenetic analysis using parsimony, that sequence of the immature specimen was nested in a polytomy of multiple species (Fig. 1.7) and inference of its species membership could not be made. These immature specimens have dark orange heads, indicating their probable species membership with *H. bipunctatus* and rejecting

conspecificity with *Hovacoris melanoceps* **sp. nov.**, because the immature stages of that species have blackish brown heads. The large genetic distances of the immature specimen sequence to the sequences of *H. melanoceps* **sp. nov.** (15.8–16.4%) also negated their conspecificity. Large genetic distances (14.5%, 15.3%) preclude belonging either to *Hovacoris rufiventris* **sp. nov.** or *Hovacoris bicolornotum* **sp. nov.**

#### *Morphological and molecular phylogenetic analyses*

The phylogenetic analysis based on morphological characters resulted in one most parsimonious tree (Consistency Index = 88, Retention Index = 89, length = 90) (Fig. 1.6). The supporting characters for each clade are shown in Fig. 1.6. A species of *Sirthenea* was chosen to root the tree. Phylogenetic relationships between genera of Peiratinae have not been explored and the phylogenetic position of *Sirthenea* is unknown. Hence, character polarity determination in the morphological analysis is tentative. Twelve unambiguously optimized characters supported the monophyly of the *Bekilya* genus group (Fig. 1.6) and that number increased to 18 when the ‘slow’ optimization option was used (not shown in Fig. 1.6). The monophyly of *Bekilya* and *Hovacoris* each was well supported by many characters. Relationships between species were resolved, but supported by only one or two characters. *Bekilya tuleara* **sp. nov.** is the sister taxon to *Bekilya mahafalya* **sp. nov.**. Together they form the sister group to *B. tenebra* **sp. nov.**. *H. melanoceps* **sp. nov.** is the sister taxon to *H. rufiventris* **sp. nov.**, and they together form the sister to *H. bipunctatus*. *Hovacoris bicolornotum* **sp. nov.** is the sister taxon to the remaining species of *Hovacoris*. The sister relationship between *Pseudolestomerus* and *Lestomerus* is recovered and supported by four characters.

The molecular phylogenetic analysis resulted in 16 equally most parsimonious trees (length 682), the strict consensus of which is presented in Fig. 1.7. Within the

*Bekilya* group, *Bekilya*, and *Hovacoris* were each recovered monophyletic. However, only *Bekilya* had bootstrap support above 50. The molecular phylogenetic analysis generated similar results to the morphological analysis except for the largely unresolved relationships between species and the well supported sister-group relationship between *B. mahafalya* **sp. nov.** and *B. tenebra* **sp. nov.** (Fig. 1.7). In the morphological analysis, *B. mahafalya* **sp. nov.** was sister to *B. tuleara* **sp. nov.**, defined by character 58, the setae adjacent to paramere insertion located on a small protrusion on pygophore sparse (Fig. 1.3–J2; 58–2).

#### *Taxonomy*

#### ***Bekilya* genus group**

Figs 1.1–1.7

*Diagnosis.* Male. Distinguished from other Malagasy Peiratinae by the following combination of characters: pronotum dark orange or dark red (bicolorous in *H. bicolornotum* **sp. nov.**) (Fig. 1.1); corium bicolored, proximally brown and distally whitish (Fig. 1.1; character 9, state 1, or 9–1, ‘character’ and ‘state’ omitted hereafter); abdomen laterally brown or reddish, medially white or pale (Fig. 1.1; 17–1); with heavy tuberculation on head, anterior pronotal lobe, scutellum (Fig. 1.2), pleura, thoracic sternites, and femora; tubercles on anterior pronotal lobe arranged in stripes (Figs 1.2G,I); antero–lateral pronotal angles slightly pointed, not tubercle–shaped (Fig. 1.3–D4; 30–2); fore femur incrassate, ventrally with strong conical tubercles; fore tibia straight, slightly dilated and distally oblique (Fig. 1.1); metasternite rounded ; fossula spongiosa on fore tibia extending about half of the apex of tibia; apex of dorsal phallosclerite sharply projected (Fig. 1.4; 52–1); lateral phallosclerite dorsally

ridged (Fig. 1.4; 50–1); body and corium covered with dense setae, particularly prominent on head, pronotum, scutellum, legs and parameres (Figs 1, 2, 4).

Female. Recognized by the orange pronotum and scutellum (Fig. 1.1); the brachypterous wings (Fig. 1.2K); the heavy tuberculation on head and thorax and the tubercles on anterior pronotal lobe arranged in stripes (Figs 1.2B, E, H); the fore femur ventrally with conical tubercles; the abdominal tergites anteriorly with a patch of bright orange setae (Fig. 1.1).

*Discussion.* We define the genus group as consisting of *Bekilya* and *Hovacoris*. It is endemic to Madagascar. The monophyly of *Bekilya* and *Hovacoris* is confirmed by both morphological and molecular phylogenetic analyses (Figs 1.6, 1.7). The two genera can be diagnosed easily based on morphological characters (Fig. 1.6) and thus we decided to keep them as separate genera.

Some of the diagnostic characters are found also in other genera of Malagasy Peiratinae. A straight tibia is present in *Sirthenea* Spinola, 1840, *Ectomocoris* Mayr, 1865, *Cleptocoris* Stål, 1866, *Pseudolestomerus* Villiers, 1964, and *Lestomerus* Amyot & Serville, 1843. An oblique and dilated tibial apex is found in *Pseudolestomerus* Villiers, 1964, and *Lestomerus* Amyot & Serville, 1843. One of the most unusual characters, tuberculation on the anterior pronotal lobe has been recorded also in another monotypic genus, *Catamiarus* Amyot & Serville, 1843, found only in India. We did not examine specimens of this genus due lack of material.

#### Key to Genera of the *Bekilya* Genus Group

##### Adult Male.

1– Relatively large (12.0–13.1 mm); fore femur Colour almost uniform; membrane of hemelytron proximally with whitish patch (Fig. 1.1); eye large and interocular distance

small (Fig. 1.2A); posterior pronotal lobe much wider and slightly shorter than anterior pronotal lobe (Fig. 1.2D; Supporting Information 1.1); dorsal rim of parameres almost flat, not humped, with setae reaching paramere stems (Fig. 1.4)..... *Bekilya*

– Relatively small (8.8–11.2 mm); fore femur brown suffused with white (Fig. 1.1);

membrane of hemelytron entirely brown (Fig. 1.1); eye small and interocular distance

large (Fig. 1.2C); posterior pronotal lobe slightly wider and much shorter than anterior

pronotal lobe (Fig. 1.2F); dorsal rim of parameres humped, with setae restricted to

medial half, not reaching paramere stems (Fig. 1.4)..... *Hovacoris*

Adult Female.

1– Relatively large (12–15mm); abdominal tergites 1 and 2 medially with bright orange

setae arranged in a square, tergites 4 and 5 uniformly with bright golden setae, tergites 6

and 7 without orange setae forming a large patch (Fig. 1.1)..... *Bekilya*

– Relatively small (~10mm); abdominal tergites 1 and 2 medially with bright orange

setae forming a semi-circle, tergites 6 and 7 with orange setae in a large patch (Fig. 1.1)

..... *Hovacoris*

### *Bekilya* Villiers

(Figs 1.1; 1.2A,B,D,E,G,H,J,K, 1.3–B1,D4,E2,F2,G2,H3,J2,J3,H2,I1)

*Bekilya* Villiers, 1949, 21 (6): 708 [gen.n.]; Villiers, 1968 [redescription, key]

*Mutillocoris* Villiers, 1964, 31 (3): 194 [gen.n.], **syn. nov.**; Villiers, 1968 [redescription, key]

Type species: *Bekilya mira* Villiers, 1949 (by original designation)

*Revised diagnosis.* Male. Recognized by the membrane of hemelytron proximally with a whitish or yellowish patch and distally usually whitish or pale brown (Fig. 1.1; 10–1); the basiflagellomere and distiflagellomere brown, basally pale (Fig. 1.1; 4–1); the

dark-colored coxae (Fig. 1.1; 12–3); the fore trochanter dark orange to orangish brown, mid and hind trochanters brown to dark brown; the fore femur dark orange to dark brown, without a ring, the mid femur mostly brown, proximally whitish (Fig. 1.1; 15–1); the eye and ocellus large (Fig. 1.2A; 20–1, 22–1); the tuberculated stripes on anterior pronotal lobe each with usually only 2 or 3 columns of tubercles; the tubercles randomly distributed within each column (Fig. 1.2G); the posterior pronotal lobe slightly shorter and much wider than the anterior pronotal lobe (Fig. 1.2D; 32–1); the scutellum about as wide as long (Fig. 1.2J; 33–1); the scutellar process short and knob-shaped; the subcostal margin of hemelytron almost straight (Fig. 1.1; 43–1); the setae on dorsal rim of parameres reaching paramere stems (Fig. 1.4; 57–1).

Distinguished from *Hovacoris* by the above characters and also by the larger body size (12–13.3mm) (Supporting Information 1.1); the maxillary plate blunt, not forming a sharp projection (Fig. 1.3–B1; 26–1); the mesosternite medially with a longitudinal ridge; the apex of the lateral phallothecal plate convex (Fig. 1.4; 51–0); and the dorsal rims of the parameres almost flat, not humped (Fig. 1.4; 49–0).

Female (Fig. 1.1): Recognized by the larger body (12–15 mm); the orange setae arranged in a square antero–medially on abdominal tergites; the abdominal tergites 4 and 5 with golden setae uniformly, and the absence of a patch of orange setae posteriorly on the abdominal tergites.

*Redescription.* Male. Macropterous, 12–13.3 mm. Colour (Fig. 1.1): Head: Uniformly dark orange to dark brown. Antenna: Scapus and pedicellus entirely brown; basiflagellomere and distiflagellomere brown, basally pale. Labium: Brown to dark brown, sometimes second visible segment paler. Thorax: Pronotum and scutellum either uniformly dark reddish or dark orange; propleuron dark orange; mesopleuron orangish



brown to dark brown; metapleuron dark brown to blackish brown; thoracic sternites brown to dark brown, sometimes with metasternite darker. Hemelytron: Clavus mostly brown, reddish brown to dark brown, paler or whitish at proximal margin; corium proximally brown, reddish brown or dark brown, basally almost entirely yellowish or whitish; membrane of hemelytron mostly brown or dark brown, proximally whitish to yellowish as an inverse triangle, distally whitish to pale brown. Legs: Fore coxa either dark orange or dark brown; mid and hind coxae dark brown; trochanters brown to dark brown suffused with white; fore femur entirely dark reddish, orangish brown, or dark brown, sometimes anteriorly pale, mid and hind femora mostly brown or dark brown with basally whitish band; fore and mid tibiae dorsally brown or dark brown, laterally and ventrally whitish or pale brown, distally darker, hind tibia uniformly whitish to brown, subapically darker; tarsi and pretarsi brown.

Abdomen: Tergites and connexivum with alternating whitish and brown bands; sternites entirely brown or dark brown, sometimes paler or whitish medially. Vestiture: Entire body except membrane of hemelytron covered with dense setae. Head: Setae brown to dark brown, medium to long, semierect, anteriorly dense, shorter and subadpressed, ventrally sparse (Fig. 1.2A). Antenna: Scapus with brown, short, erect, sparse setae; pedicellus and basiflagellomere with pale brown, long, erect setae, longer than diameter of scapus, and very short, suberect setae; pedicellus with long trichobothria; distiflagellomere with mostly pale brown, very short, dense setae, basally with longer setae. Labium: Setae sparse overall, mainly present dorsally, ventrally sparse.

Thorax: Anterior pronotal lobe with orange, semierect, dense setae restricted to tuberculated stripes and between tubercles, absent from grooves between tuberculated

stripes (Figs 1.1; 1.2D,G); posterior pronotal lobe with orange, sparse setae (Fig. 1.2D); scutellum with dense, orange, long setae (Figs 1.1; 1.2J); thoracic sternites with brown, moderately long, dense setae. Hemelytron: Setae constricted on clavus and corium, denser along subcostal margins and veins, sparse between veins. Legs: All segments with semierect to erect, long setae blended with shorter setae, long setae about or longer than length of scapus, short setae about or longer than diameter of scapus. Abdomen: Ventrally with short, sparse, sub-addressed setae, mostly along segment articulations; connexium with short to long, semierect setae, dense on terminal segments. Genitalia: Pygophore: postero–ventrally with short, sparse setae; median process of pygophore flanked with very short, dense setae. Parameres: Dorsal rims of parameres with stout, semierect setae reaching paramere stems (Fig. 1.4); surface of paramere ventrally with very long, semierect setae pointing ventrad or horizontally, medially with short, semierect setae pointing upward, dorsally without setae (Fig. 1.4).

Structure: Head: Tuberculated, tubercles absent on neck; anteocular slightly longer than postocular; eye large and prominent, interocular space much less than width of an eye in dorsal view (Fig. 1.2A), eye almost as high as head in lateral view; ocellus large, situated on a large tubercle (Fig. 1.2A); preocellar constriction somewhat impressed; antennal insertion adjacent to anterior margin of eye; maxillary plate blunt (Fig. 1.3–B1). Antenna: Scapus stout, short, shorter than length of head (Fig. 1.1); pedicellus longest, almost three times as long as scapus (Supporting Information 1.1), basiflagellomere slightly shorter than pedicellus, distiflagellomere slightly shorter than basiflagellomere. Labium: Curved, second visible labial segment slightly swollen, longest, about twice as long as third visible segment, first segment slightly shorter than second. Thorax: Pronotum: Antero–lateral angle of pronotum slightly pointed, not

tubercle-shaped (Fig. 1.3–D4); pronotal collar slightly curved; anterior pronotal lobe with longitudinal and diagonal tuberculated stripes, separated by grooves, tuberculated stripes narrow, usually with only 2 or 3 columns of tubercles within each stripe, tubercles randomly arranged within each column; lateral margins of anterior pronotal lobe ridged; posterior pronotal lobe much wider and slightly shorter than anterior pronotal lobe (Fig. 1.2D); transverse groove between anterior and posterior pronotal lobes almost straight (Figs 1.2D,G). Scutellum: Almost as wide as long, sublaterally swollen, forming two lobes; scutellar process short, knob-shaped (Fig. 1.2J). Legs: Fore coxa stout, somewhat elongate; fore femur stout, incrassate, ventrally with strong conical tubercles; fore tibia shorter than fore femur, apex dilated and oblique, fossula spongiosa present, small, extending less than half of tibial apex; mid coxa short, rounded; mid femur stout, not greatly incrassate, sub-distally thickened, and distally tapering; mid tibia a little shorter than mid femur, apically slightly dilated, apex oblique, fossula spongiosa present, small, slightly extending beyond tibial apex; hind coxa short and rounded; hind femur long, slender, longer than fore and mid femora, distally slightly narrowed; hind tibia long and slender. Tarsi 3-segmented, pretarsi claw-shaped. Hemelytron (Fig. 1.1): Surpassing abdomen, covering connexivum; subcostal margin almost straight or distally slightly curving inward. Abdomen (Fig. 1.1): Elongate, sometimes medially forming an angle; connexivum not inflated; eighth abdominal sternite ring-like, dorsally membranous, ventro-posterior margin slightly convex, without distinct process (Fig. 1.3–G2; 46–1 ). Genitalia (Fig. 1.2): Pygophore: somewhat elongate in ventral view; median process of pygophore strongly bent to right in posterior view, with transverse ridges (Fig. 1.3–H3). Parameres: Narrow or broad, convex in posterior view, transverse-medially not forming a distinct angle; dorsal rims of parameres almost flat, without a hump; left and

right paramere somewhat asymmetrical, with left paramere larger, left paramere stem pointing upward and right paramere stem horizontally or ventrally, and setae on right paramere denser. *Phallus*: Apex of lateral phallothecal plate convex; dorsal phallothecal sclerite more heavily sclerotized on right side; apex of dorsal phallothecal sclerite tooth-shaped, projecting to left; endosomal struts of aedeagus ('struts' hereafter) partially fused, almost as long as half length of phallotheca, convex at right side, concave at left.

Female. Brachypterous, stout, medium or large (12–15mm). Colour (Fig. 1.1): Head: Uniformly dark orange. Antenna: Scapus brown, basally darker; pedicellus brown; basiflagellomere brown, basal third lighter; distiflagellomere brown. Labium: Uniformly orangish brown. Thorax: Pronotum, scutellum, pro- and meso-pleuron dark orange; meta-pleuron dark brown; thoracic sternites brown, with meta-sternite darker. Wing pad: Whitish yellow. Legs: Colour as in description of male, with fore coxa and fore femur dark orange. Abdomen: Tergites: Mostly dark brown, some parts masked by bright orange or yellow setae. Connexivum: Mostly dark brown, segments 4–6 with narrow white bands. Sternites: Uniformly dark brown, glabrous. Vestiture: Entire body pilose. Head (Figs 1.1, 1.2B): Including antenna and labium as in description of male. Thorax (Figs 1; 2E,H,K): Including legs as in description of male, with setae on scutellum sparse. Wing pad (Fig. 1.2K): Laterally with long, sparse, suberect setae. Abdomen (Fig. 1.1): Tergites: With short, dense, suberect to sub-adpressed setae; tergites 1 and 2 laterally with brown, short, suberect setae and medially with bright orange, short, sub-adpressed, dense setae arranged in a square; tergite 3 medially with mostly brown, short, suberect or erect setae and a few bright orange setae; tergites 4 and 5 with bright yellow, short, subadpressed and adpressed setae, interspersed with brown setae; tergite 6 with brown, short, erect setae; segment 7 with mostly dark brown, short, erect setae,

sparsely interspersed with bright yellow, short, sub-adpressed setae; tergites 8–10 with brown, short, suberect setae. Connexivum: With dense, brown, short, suberect or erect setae, segments 4 and 5 interspersed with bright yellow setae. Sternites: With sparse, pale brown, short, erect setae, mostly along segment articulations. External genitalia: Valvifers and valvulae with dense setae. Structure: Head (Figs 1.1, 1.2B): Tuberculated except two patches below and posterior to eye; longer than wide; antocular longer than postocular; eye small, interocular space much wider than width of eye in dorsal view, ventral margin of eye far from ventral outline of head in lateral view, ventro–posteriorly slightly notched; ocellus absent. Antenna: Scapus short, thick; pedicellus twice as long as scapus, thinner than scapus; basiflagellomere slender, slightly shorter than pedicellus, distiflagellomere slender, slightly shorter than basiflagellomere. Labium (Fig. 1.1): Stout, curved, barely surpassing neck; second visible segment incrassate, slightly longer than first segment, about twice as long as third segment. Thorax (Figs 1.1; 1.2E,H,K): Anterior pronotal lobe greatly enlarged, laterally ridged, much longer and slightly wider than posterior pronotal lobe; pronotal collar straight, antero–lateral angles not strongly projected; posterior pronotal lobe narrow, entire pronotum tuberculated, tubercles distinct, arranged in longitudinal and diagonal stripes on anterior pronotal lobe, stripes wider than that in males; tubercles randomly distributed on posterior pronotal lobe; scutellum wider than long, slightly swollen; scutellar process very short; metanotum exposed; pleura and sternites tuberculated, pro–sternal stridulatory groove exceeds fore coxal cavity; mesosternite medially ridged; metasternite rounded. Wing pad (Fig. 1.2K): Pad–like, either exceeding or not exceeding scutellum, with diagonal groove. Legs (Fig. 1.1): Fore coxa stout, somewhat elongate, tuberculated dorsally, fore coxal cavity open; trochanters simple; fore femur stout, incrassate, ventrally with strong conical tubercles;

fore tibia shorter than fore femur, apex dilated, fossula spongiosa present with less than half extending beyond tibial apex; mid and hind coxae globular; mid femur stout, slightly swollen; mid tibia slightly shorter than mid femur, distally dilated, fossula spongiosa present and extending little beyond tibial apex; hind femur stout, not incrassate, longer than fore and mid tibiae; hind tibia slightly longer than hind femur, much longer than fore and mid tibiae, without fossula spongiosa. Abdomen (Fig. 1.1): Stout, dorsally flat, ventrally strongly convex. Genitalia: Valvifer 1 narrow and strap-like, valvula 1 triangular.

Immature stages: Known for a single species, *B. tuleara* **sp. nov.** Description is provided under that species.

*Distribution.* Known from the southern Malagasy province Toliara (Tuléar).

*Discussion.* Basi- and distiflagellomere with pale brown or whitish base in the male are seen also in *H. rufiventris* **sp. nov.** However, in *H. rufiventris* **sp. nov.**, the base of the basiflagellomere appears whitish compared to pale brown in the species of *Bekilya*.

In the current project, two female specimens were identified to belong to what Villiers (1964, 1968) recognized as *Mutillocoris*. Molecular data confirmed that they are the females of *B. tuleara* **sp. nov.** They are not conspecific with either *M. tricolor* or *M. vadoni* based on morphological observations. The holotype or the single known specimen of *M. vadoni* measures about 10mm in length. This value falls within the length range of *Hovacoris* (8.8 – 11.2 mm) and is much smaller than the length of the smallest male specimen of *Bekilya* (12.0 mm). We deemed *M. vadoni* as a member of *Hovacoris*. The holotype, also the single known specimen of *M. tricolor* is about 3mm larger than the females of *B. tuleara* **sp. nov.** The size difference is much larger than the range of intraspecific variation in size of male specimens of *B. tuleara* **sp. nov.**, and we treated it

as evidence of the female specimen of *M. tricolor* representing a different species. Also, the wing pads of females of *B. tuleara* **sp. nov.** do not surpass scutellum, but the wing pad of the female *M. tricolor* specimen clearly exceeds the apex of scutellum.

*Mutillocoris tricolor* was therefore transferred to *Bekilya* and the new combination *Bekilya tricolor* (Villiers, 1964) created. However, it could not be associated with male specimens as a result of lack of molecular data. Morphology alone is not a sufficient source of evidence for associating females with males.

#### Key to the Species of *Bekilya*

Adult Male.

- 1– Pronotum and scutellum dark reddish brown, legs reddish brown (Fig. 1.1)  
 ..... *Bekilya mira* Villiers
- Pronotum and scutellum dark orange, legs dark orange or brown..... 2
- 2 – Fore femur dark orange to orangish brown, always lighter than the brown parts of mid and hind femora (Fig. 1.1; 16–0); corium distally without or with a very small brown patch (Fig.1; 11–1)..... *Bekilya tuleara* **sp. nov.**
- Fore femur brown or dark brown, as dark as the brown parts of mid and hind femora (Fig. 1.1; 16–1); corium distally with a large brown patch (Fig. 1.1; 11–2)..... 3
- 3 – Head dark orange; legs, hemelytron and abdomen brown (Fig. 1.1); basiflagellomere distally with only short setae, without long setae (Fig. 1.3–I2; 55–1).....  
 ..... *Bekilya mahafalya* **sp. nov.**

– Head dark brown; legs, hemelytron and abdomen dark brown (Fig. 1.1),  
basiflagellomere distally with both long and short setae (Fig. 1.3–I1; 55–0) .....  
..... *Bekilya tenebra* **sp. nov.**

Adult Female.

1– Relatively large (~15 mm); wing pad exceeding scutellum, reaching abdomen (Fig.  
1.1)..... *Bekilya tricolor* comb.n.

– Relatively small (~12 mm); wing pad not exceeding scutellum, not reaching abdomen  
(Fig. 1.1) ..... *Bekilya tuleara* **sp. nov.**

***Bekilya mahafalya* sp. nov.**

(Figs 1.1; 1.3–J2,I2; 1.4; 1.5)

Holotype. Male. MADAGASCAR: Toliara (Tuléar): Beza Mahafaly Reserve,  
Parcelle I near research station, 23.6865°S 44.591°E, 165 m, 02–09 Jan 2002, (RHH),  
(UCR\_ENT 00005305 [caslot 028708/MA–02–16–01]) (CAS).

Paratypes. Male. as holotype except 22 Feb – 01 Mar 2002, (UCR\_ENT  
00005306 [caslot 031367/MA–02–14A–17]) (CAS).

*Diagnosis.* Male. Recognized by the dark orange head (Fig.1; 1–1); the pro– and  
mesopleuron dark orange, metapleuron orangish brown (Fig. 1.1); the basiflagellomere  
distally with only short sub-adpressed setae (Fig. 1.3–I2; 55–1). Different from *B. tuleara*  
**sp. nov.** in the fore femur brown and as dark as the brown parts of mid and hind femora  
(Fig. 1.1); the corium distally with a large brown patch (Fig. 1.1; 11–2). Distinguished  
from *B. tenebra* **sp. nov.** by the lighter brown legs, hemelytron and abdomen; the  
narrower parameres (Fig. 1.4); and the setae adjacent to paramere insertion located on  
a small protrusion on pygophore sparse (Fig. 1.3–J2; 58–2).

*Description.* Male. Macropterous, ~ 12.8 mm. Colour (Fig. 1.1.): Head: Dark



orange; antenna and labium as in generic description. Thorax: As in generic description, with pronotum dark orange; pro- and mesopleuron dark orange; metapleuron orangish brown, slightly lighter than brown parts of mid and hind femora; fore femur brown apically with a small pale brown patch, brown part as dark as brown parts of mid and hind femora, and corium distally with a large brown patch. Abdomen: As in generic description, with brown parts lighter. Vestiture: As in generic description, with setae adjacent to paramere insertion located on a small protrusion on pygophore sparse (Fig. 1.3–J2; 58–2). Structure: As in generic description, with parameres apically narrowed, convex.

Female. Unknown.

*Etymology.* The species epithet is a noun in apposition, named after the type locality, Beza Mahafaly Reserve, Madagascar.

*Distribution.* Known from one locality in Toliara (Tuléar), Madagascar (Fig. 1.5).

*Discussion.* The two specimens that represent this species currently did not come to our attention until we noticed that the *COI* sequence obtained for one showed high genetic distance from other congeners. One specimen of *B. tuleara* **sp. nov.** (UCR\_ENT 00005307) was found very close (~1.6 km) to the locality of *B. mahafalya*, but it can be identified unambiguously as *B. tuleara* **sp. nov.** based on morphology. The genetic distance between *B. mahafalya* and *B. tuleara* **sp. nov.** ranged from 11.5% to 12.4%, considerably larger than the largest intraspecific distance (7.7%) found within *B. tuleara* **sp.n**, thus assuring the species boundary between the two.

The morphological and molecular phylogenetic analyses showed discrepancy in the phylogenetic position of *B. mahafalya*. The former placed that species as the sister group to *B. tuleara* **sp. nov.** based on a single character (Fig. 1.6) (Fig. 1.3–J2; 58–2),

whereas the latter recovered the sister relationship between *B. mahafalya* and *B. tenebra* **sp. nov.** with strong bootstrap support (Fig. 1.7). Further investigations are warranted to resolve this discrepancy.

Both specimens were collected using malaise trap. The habitat as recorded on the locality label is dry deciduous forest. This differs from that of the nearby collected *B. tuleara* **sp. nov.** specimen, i.e. spiny forest. However, a strict correspondence between microhabitat and species limit is absent as some specimens of *B. tuleara* **sp. nov.** were collected from dry deciduous forest as well.

### ***Bekilya mira* Villiers**

(Figs 1.1, 1.5)

*Bekilya mira* Villiers, 1949, 21 (6): 708 [sp. nov.]; Villiers, 1968 [redescription, key]

Holotype : Male. MADAGASCAR: Toliara (Tuléar): Bekily, [24.22802°S 45.30858°E] Jan. 1940, (A. Seyrig), MNHN (EH) 4108, (MNHN) (Abdomen missing).

*Revised Diagnosis.* Male. Recognized by the dark reddish brown pronotum and scutellum, and reddish brown legs.

*Redescription* (Fig. 1.1): Male. Macropterous, ~13.5 mm. Colour: Head: Dark brown; labium reddish brown. Thorax: Pronotum and scutellum dark reddish brown; dark parts of legs and thoracic sternites reddish brown, hind femur almost entirely reddish brown; dark portions of hemelytron reddish brown. Abdomen: Missing. Vestiture: Entire body except membrane of hemelytron pilose. Structure: Details of head and thorax not examined. Abdomen and Genitalia: Missing from specimen.

Female. Unknown.

*Distribution:* A single specimen is known from Bekily in the province Toliara (Tuléar) in southern Madagascar (Fig. 1.5).

*Discussion.* Our redescription is based on dorsal and ventral habitus images of the type specimen. Our observation is consistent with Villiers' (1949) original description, and thus the colour we observe in the photograph appears to be natural. The locality is non-overlapping with that of either *B. tenebra* **sp. nov.** or *B. tuleara* **sp. nov.**

***Bekilya tenebra* sp. nov.**

(Figs 1.1, 1.3–J3, 1.4, 1.5)

Holotype: Male. MADAGASCAR: Toliara (Tuléar): Berenty Special Reserve, 25.021°S 46.3055°E, 35 m, 31 Jul–15 Aug 2004, (MI, FP, RHH), 1♂ (UCR\_ENT 00005355 [caslot 026914/MA–02–22A–23]) (CAS).

Paratypes. 1♂: as holotype except 21–23 Nov 2003, (UCR\_ENT 00005326 [caslot 029389/MA–02–20–49]) (CAS); 1♂ Cap Ste Marie Special Reserve, 74km S of Tsihombe, 25.58766°S 45.163°E, 37 m, 18–25 Nov 2002, (MI, FP, RHH), (UCR\_ENT 00005310 [caslot 028684/MA–02–23–05]) (CAS).

*Diagnosis.* Male. Recognized by the blackish dark brown fore femur, the overall rather dark body Colour especially the brown parts on legs, hemelytron and abdomen (Fig. 1.1); the very broad parameres (Fig. 1.4). Distinguished from *B. tuleara* **sp. nov.** also by the corium distally with a larger brown patch (Fig. 1.1; 11–2). Different from *B. mahafalya* in the dark brown head, the basiflagellomere distally with both short and long setae (Fig. 1.3–I2; 55–0), and the setae adjacent to paramere insertion located on a small protrusion on the pygophore forming a dense patch (Fig. 1.3–J3; 58–3).

*Description.* Male. Macropterous, 12–13.1 mm. Colour (Fig. 1.1): Head: Dark brown; labium dark brown; antenna as in generic description. Thorax: as in generic description, with head dark brown; mesopleuron dark brown, metapleuron blackish brown, metasternite blackish brown; fore femur blackish brown, and dark parts of mid

and hind legs and hemelytron blackish brown. Abdomen: As in generic description. Vestiture (Figs 1.1, 1.2): As in generic description, with right paramere dorso–medially with dense setae, and setae adjacent to paramere insertion located on a small protrusion on pygophore forming a dense patch (Fig. 1.2). Structure: (Figs 1.1, 1.2): as in generic description, with lateral margins of anterior pronotal lobe clearly ridged, parameres very broad, and struts long and slender.

Female. Unknown.

*Etymology.* The name is taken from the Latin noun *tenebra*, meaning darkness, and refers to the dark brown fore femur and overall dark body colour.

*Distribution.* Known from south Toliara (Tuléar) in Madagascar (Fig. 1.5).

*Discussion.* Molecular analysis supported the sister relationship between *B. tenebra* and *B. mahafalya* (Fig. 1.7). They are morphologically similar in having the fore femur as dark as the brown parts of mid and hind femora and also the corium distally with a relatively large patch. However, these are plesiomorphic conditions as revealed by the morphological phylogenetic analysis where *B. tenebra* is the sister taxon to *B. tuleara* **sp. nov.** The specimens were collected using malaise traps from three localities with different habitats such as transitional forest and spiny bush forest.

***Bekilya tricolor* (Villiers, 1964), comb.n.**

(Fig. 1.1)

*Mutillocoris tricolor* Villiers, 1964, 31 (3): 194 [sp. nov.]; Villiers, 1968

[redescription, key]

Holotype: Female. MADAGASCAR: Toliara (Tuléar): Route Tsihombe et Beloha (road between Tsihombe and Beloha), [25.24537°S 45.2711°E], MNHN (EH) 4106, (MNHN).

*Revised Diagnosis.* Female. As in generic diagnosis; distinguished from females of *B. tuleara* **sp. nov.** by the larger body size (15mm), and the wing pads surpassing scutellum.

*Redescription.* Female. Brachypterous, ~15 mm. Colour as in generic description of female. Vestiture and Structure unknown, since specimen not physically examined. Wing pads clearly exceeding scutellum. Male. Unknown

*Distribution.* South of Toliara (Tuléar) in southern Madagascar (Fig. 1.5).

*Discussion.* This redescription is based on a habitus photograph of the female holotype. The close proximity to *B. tenebra* indicate that *B. tricolor* could be the female of *B. tenebra*. Nevertheless, we decided to refrain from making this association at this point because we did not physically examine the holotype and did not obtain molecular data.

***Bekilya tuleara* sp. nov.**

(Figs 1.1; 1.2; 1.3A,D,G,J; 1.4; 1.5)

Holotype: Male. MADAGASCAR: Toliara (Tuléar): Mikea Forest, NW of Manombo, 22.90366°S 43.4755°E, 30 m, 30 Oct–14 Nov 2002, (MI, RHH), (UCR\_ENT 00005234 [cat MA-02-18A-39]) (CAS).

Paratypes (Only brief specimen information provided here. For details see Supporting Information 1.6): Males: MADAGASCAR: Toliara (Tuléar): Ifaty, near Hotel Paradisia - in costal dunes, 23.17966°S 43.61683°E, 13 Oct–12 Nov 2001, (MI, FP, RHH), 4♂ (CAS). Ranobe, 23.04638°S 43.61028°E, 20 m, 27 Oct–03 Nov 2003, (CAS–FWP), 1♂ (CAS). Tulear: Beza Mahafaly Reserve, Parcelle II near Bellevue, 23.68983°S 44.5755°E, 180 m, 28 Nov–04 Dec 2001, (MI, RHH), 1♂ (CAS); Beza Mahafaly Reserve, Parcelle I near research station, 23.6865°S 44.591°E, 165m, malaise trap in dry deciduous forest, 16 – 28 Aug 2002, (RHH), 1♂ (CAS). Mikea Forest, NW of

Manombo, 22.90366°S 43.4755°E, 30 m, Nov 2001–Mar 2002, (MI, RHH), 9♂ (AMNH); 16–26 Dec 2001, (MI, RHH), 3♂ (MNHN); Jan–Oct 2002, (MI, RHH), 8♂ (UCR); Oct 2002–Nov 2003, (MI, RHH), 38♂ (CAS). Females: Lake Ranobe, 23.04901°S 43.61058°E, 30 m, 21–28 Jan 2003, (CAS–FWP), 1♀ (CAS). Ranobe, 23.03944°S 43.61027°E, 30 m, 05–28 Jan 2003, (CAS–FWP), 1♀ (MNHN).

Other specimens examined: Immature stages: MADAGASCAR: Toliara (Tuléar): Lake Ranobe, 23.03916°S 43.61166°E, 30 m, 25–28 Apr 2003, (CAS–FWP), 2 specs (CAS); 1 spec (UCR). Ranobe, 23.03416°S 43.61194°E, 30 m, 05–09 Feb 2003, (CAS–FWP), 1 spec (CAS). Ranobe, 23.03944°S 43.61027°E, 30 m, 05–28 Jan 2003, (CAS–FWP), 4 specs (CAS).

*Diagnosis:* Male. Recognized by the orangish brown fore femur (Fig. 1.1) lighter than the dark parts of mid and hind femora (Fig. 1.1; 16–0), and the corium distally without or with a very small brown patch (Fig. 1.1; 11–1). Distinguished from *B. mahafalya* also by the dark brown head and the basiflagellomere distally with both long and short setae (Fig. 1.3–11; 55–0). Different from *B. tenebra* in the overall lighter body colour, the paramere apically narrowed, and the sparse setae adjacent to the paramere insertion located on a small protrusion on the pygophore.

*Female.* As in generic diagnosis; distinguished from *B. tricolor* by the wing pad not surpassing scutellum.

*Description:* Male. Macropterous, medium size (12–13.3 mm). Colour (Fig. 1.1): Head: including antenna and labium as in generic description, with head orangish brown to dark brown and labium orangish brown. Thorax: including legs and hemelytron as in generic description, with mesopleuron brown to dark brown, metapleuron dark brown to blackish brown, fore femur uniformly orangish brown, dark portions of mid and hind legs

and hemelytron brown, and thoracic sternites dark brown. Abdomen: As in generic description, with abdomen ventrally brown. Vestiture: Head (Figs 1.1, 1.2A), Thorax (Figs 1.1; 1.2A,D,G,J), Abdomen (Fig. 1.1), and Genitalia (Fig. 1.4) as in generic description. Structure: Head (Fig. 1.1, 2A): including eye, antenna, and labium as in generic description. Thorax (Figs 1.1; 1.2D,G,J): including hemelytron and legs as in generic description. Abdomen (Fig. 1.1): As in generic description. Genitalia (Fig. 1.4): including pygophore, parameres and phallus as in generic description, with parameres narrow, and struts short and broad.

Female. Brachypterous, ~12.1 mm. Colour, vestiture and structure as in generic description, with wing pad not surpassing scutellum.

Immature: Fifth instar: Male. (Fig. 1.1) Colour: Head and Thorax: Head including antenna and labium, and thorax including legs as in adult male description, with basiflagellomere basal half pale, fore femur with dorso- and ventro-lateral longitudinal dark brown stripes, mid and hind coxae proximally dark brown and distally whitish, mesopleuron dark orange, mesonotum, pre-scutellum and metanotum orange, wing pads proximally orange, distally yellowish, and thoracic sternites pale orange. Abdomen: Dorsum mostly blackish brown, laterally suffused with white, tergite 1 orange, tergite 2 yellowish, tergite 6 medially yellowish and 7 mostly pale brown; abdominal sternite 2 dark brown, laterally and medially whitish; sternites 3–6 mostly reddish orange, laterally dark; sternites 3–7 each anteriorly with two small blackish brown spots hidden under cuticular folding, and posteriorly a large patch, size of latter decreases from segment 3 to 7, minute on segment 7; sternite 7 whitish; sternite 8–10 entirely blackish. Vestiture: Entire body including head, thorax, and abdomen covered with dense setae; mostly subadpressed to suberect, pale brown to brown, with setae golden or bright yellowish on

yellowish or orange patches on abdomen; setal length varies, mostly medium-length, about or slightly longer than diameter of fore tibia, longer setae interspersed with medium setae on most of parts of body, usually as long as scapus; mostly long setae on legs, median on dorsum and venter, and long on terminal segments; very short on pedicellus, basiflagellomere, and distiflagellomere, much shorter than diameter of distiflagellomere; long trichobothria present on pedicellus. Structure. Head: Nearly globular in lateral view, entire head except neck tuberculated, tuberculation ventrally sparse. Antecular longer than postocular, antecular region triangular in dorsal view, postocular round at lateral margin; transverse groove present behind eye, not very impressed; V-shaped grooves not conspicuous; eye small, interocular space almost twice as much as width of eye in dorsal view; eye not attaining either dorsal or ventral outline of head, and ventro-posteriorly notched in lateral view; mandibular plate flat, maxillary plate rounded, not projected; clypeus slightly bulging, forming a ridge in lateral view. Antenna: Scapus stout, distally slightly thickened, short, as long as first visible labial segment; pedicellus and distiflagellomere sub-equal in length, slightly more than twice length of scapus; distiflagellomere slightly longer than basiflagellomere; thickness of antennal segments decreases from scapus to distiflagellomere, with scapus much thicker than other segments. Labium: Curved; second visible segment longest, ventrally slightly incrassate; first visible segment slightly shorter than second segment; last segment shortest, apically acute, about half length of second segment. Thorax: Pronotum with longitudinal and diagonal tuberculated stripes; pronotal collar slightly curved; pronotal lateral margin convex, posterior margin nearly straight, slightly convex; mesonotum evenly tuberculated, medially differentiated into pre-scutellum and laterally wing buds; wing buds reaching third abdominal tergite and sparsely tuberculated;



metanotum as two small lobes between wing buds; pleura evenly tuberculated; metapleuron almost entirely flat, dorsally slightly curved, but not ridged; thoracic sternites sparsely tuberculated, tubercles medially absent on ridge; meso- and meta-sternite medially strongly ridged; legs as in adult male description, with femora stouter, mid femur ventrally with small, indistinct conical tubercles, fore and mid tibial apex rounded, and fossula spongiosa entirely on tibial apex, not extending out. Abdomen: Tergites 1 and 2 mostly covered by wing buds, appearing like small patches.

Immature: Fifth instar: Female. Larger than immature fifth instar male. Colour: as in immature fifth instar male description, with abdominal tergite 1 mostly pale brown, tergite 2 medially with yellowish sub-rectangular patch, tergites 6 and 7 entirely yellowish, lateral margins of abdomen mostly whitish with small brown patches, small spots on each abdominal sternite exposed. Vestiture: As in immature fifth instar male description, with setae on abdominal sternites sparse. Structure: as in immature fifth instar male description, with pronotum more round, mesonotum not differentiated and without wing buds, metanotum narrow and exposed, abdomen large, abdominal tergites 1 and 2 completely exposed, all abdominal segments band-like, with slight cuticular folding, but not overlapping one another, tergite 6 medially not overlapping with tergite 7, and tergite 10 very narrow.

Immature: Fourth instar: Sex unidentified: Colour, vestiture and structure as in description of fifth instar immature male, with abdomen small, more globular.

Immature: Early instars: Sex undetermined: Other specimens representing possibly both males and females at various developmental stages are similar to fifth instar male and female. Differences are mainly seen in relative proportions of body regions, tubercle formation on pronotum, shapes of mesonotum, metanotum and

abdomen, and presence of wing pads. Descriptions are not provided due to difficulty in accurate determination of stage. Refer to Fig. 1.1 for images of a representative.

*Etymology*: the species epithet is a noun in apposition, named for the one of the localities, the city Tuléar in the province Toliara (Tuléar), where both sexes were collected.

*Distribution*: Northwestern and central parts of the province Toliara (Tuléar) in Madagascar.

*Discussion*. Genetic variation in this species is relatively large. The largest intraspecific distance in *COI* amounts to 7.7%. However, morphological variation is low. Immature stages were associated with adult specimens primarily based on molecular data. Male specimens were collected using malaise trap, and females and immature by sifting leaf litter. Five types of habitats/microhabitats were recorded: vegetation in sandy area, spiny forest, spiny forest thicket, leaf mold rotten wood in spiny forest thicket and deciduous forest.

### ***Hovacoris* Villiers**

(Figs 1.1–1.5)

*Hovacoris* Villiers, 1964: 187 [gen.n.]; Villiers, 1968: 41 [redescription, key]

Type-species: *Hovacoris bipunctatus* Villiers, 1964 (by original designation)

*Diagnosis*. Male. Recognized by the scapus whitish to brown, basally darker (Fig. 1.1; 2–1, 2–2); the coxae and trochanters almost entirely whitish (Fig. 1.1); the fore femur color non–uniform, brown, distally and ventrally suffused with white; mid femur mostly whitish with brown ventrally broken ring (Fig. 1.1); the ocellus situated on relatively flat surface (Fig. 1.2C; 23–1); the maxillary plate forming a projection (Figs 1.3–B2,B3; 26–2); the mesosternite slightly rounded, without a ridge; the dorsal rim of

the parameres humped, particularly pronounced in the left paramere (Fig. 1.4; 49–1); the lateral phallosomal plate anteriorly slightly concave (Fig. 1.4; 51–1); the setae adjacent to paramere insertion located on a small protrusion on pygophore very sparse (Fig. 1.3–J1; 58–1).

Most similar to *Bekilya* among Malagasy peiratines, but can be distinguished by the above characters and also by the smaller body size (8.8–11.2 mm), the membrane of the hemelytron uniformly brown, proximally or distally without whitish or yellowish patches (Fig. 1.1; 10–0); the small eye and ocellus (Figs 1.1; 1.2C, 20–0, 22–0); the posterior pronotal lobe narrow, slightly wider than anterior pronotal lobe and about half length of anterior pronotal lobe (Fig. 1.2F; 32–0); the tuberculated stripes on the anterior pronotal lobe each with 4 or 5 columns of regularly arranged tubercles; the hairs on dorsal rim of parameres restricted to apical half, not reaching paramere stem (Fig. 1.4; 57–0).

Female. Recognized by the small size (~10 mm), the blackish brown head, and the orange setae on abdomen anteriorly arranged as a semi-circle and posteriorly a subcircle.

*Redescription:* Male. Macropterous, small (8.8–11.2 mm). Colour (Fig. 1.1): Head: Uniformly dark orange or blackish brown. Antenna: scapus either brown or whitish, basally darker; pedicellus either brown or whitish; basiflagellomere either uniformly dark brown or with basal third whitish; distiflagellomere uniformly dark brown, basally sometimes paler. Labium: Brown to dark brown, sometimes second visible segment paler. Thorax: Anterior and posterior pronotal lobes and scutellum either uniformly dark orange or anterior pronotal lobe and scutellum blackish brown and posterior pronotal lobe pale brown; propleuron dark orange or blackish brown;

mesopleuron uniformly dark orange, dark brown, or blackish brown; metapleuron dark orange or blackish brown; pro- and meso-sternites orangish brown, dark orange or dark brown, metasternite orangish brown or blackish brown. Hemelytron: Clavus mostly brown or dark brown, proximally paler, corium proximally brown or dark brown, distally with yellowish to pale brownish patch, patch size varies; membrane of hemelytron uniformly brown. *Legs*: Fore coxa whitish, pale or dark orange, sometimes basally suffused with brown, mid and hind coxae whitish, basally dark; trochanters whitish, sometimes suffused with brown; fore femur mostly brown, apically and ventrally suffused with white, or mostly pale brown; fore tibia dorsally brown, laterally and ventrally whitish to pale brown; mid femur mostly whitish, sub-distally with brown and ventral incomplete ring; dorsally mid tibia brown, ventrally whitish; hind femur proximally whitish, brown at extreme base, distally pale brown to brown, sometimes whitish near apex; hind tibia whitish or brown; tarsi and pretarsi brown or pale brown. *Abdomen*: Tergites uniformly brown, pale brown, or reddish, sometimes medially whitish; connexivum mostly whitish, pale brown or brown band adjacent to intersegmental suture posteriorly on each segment; sternites laterally dark brown, suffused with white, medially whitish. *Vestiture*: body except membrane of hemelytron covered with dense setae (Figs 1.1; 1.2A,D,G,J). *Head* (Figs 1.1, 1.2A): Setae dorsally long, slightly shorter than scapus, semierect, and dense; setae anteriorly shorter and sub-adpressed, ventrally sparse. *Antenna*: Scapus with short, erect, and sparse setae; pedicellus and basiflagellomere with both long, erect setae that are about diameter of scapus and short, suberect setae; distiflagellomere with mostly very short, dense, sub-adpressed setae except basally long setae. *Labium*: Setae mainly ventrally present, dorsally sparse, length varies, ventrally as long as diameter of labial segment 2, dorsally mostly short setae. *Thorax*: Pronotum, pleura, and sternites

with moderately long, mostly semierect or erect to some sub-adpressed, dense setae, with setae on anterior pronotal lobe constricted within tuberculated stripes and between tubercles (Figs 1.1, 1.2G); scutellum with dense, semierect, long setae, longer than scapus, interspersed with shorter setae (Figs 1.1, 1.2L). *Legs*: All segments with semierect to erect, long and short setae, long setae about or longer than length of scapus, short setae about or longer than diameter of scapus. Hemelytron: Setae on hemelytron restricted on clavus and corium, short, about or shorter than diameter of hind femur, and dense along costa, scattered on corium and clavus. Abdomen: Ventrally with short, semierect to sub-adpressed, sparse setae, shorter than diameter of hind femur. *Genitalia*: *Pygophore*: Postero–ventrally with short, sparse setae; median process of pygophore flanked with short, dense setae. *Parameres*: Dorsal rims of parameres with stout, erect setae restricted to medial half, absent towards paramere stem (Fig. 1.4); surface of paramere with long, semierect setae projecting horizontally or downward ventrally from posterior view, and medially with short, semierect setae projecting upward (Fig. 1.4), setae absent dorsally towards dorsal rim. *Structure*: Head (Figs 1.1; 1.2C): Slightly longer than wide, entirely tuberculated except on interocellus area, mandibular plate and two small patches anterior and posterior to ventral outline of eye in lateral view; anteocular slightly more than twice as long as postocular (Supporting Information 1.1); preocellar transverse groove deeply impressed; antennal insertions adjacent to anterior margin of eyes; vertex postero–medially with deep depression, immediate in front of preocellar groove, V–shaped grooves originating from this depression, extending diagonally to base of antenna (Fig. 1.3-A); clypeus elevated, slightly convex and slightly ridged in lateral view; mandibular plate simple, flat; maxillary plate pointed, either forming a small angle or an almost 90–degree large angle in dorso-frontal view (Figs

1.3–B2, B3). Eye: Small, not attaining ventral outline and almost reaching dorsal outline of head in lateral view, slightly concave at posterior margin, interocular space much wider than width of eye in dorsal view. Ocellus: Small, situated on small tubercle. Antenna: Scapus stout, shorter than length of head; pedicellus thinner, long, almost three times as long as scapus, longer than all other antennal segments; basiflagellomere slightly shorter and thinner than pedicellus; distiflagellomere about same length of basiflagellomere, slightly thinner, and apically tapers. Labium: Stout, curved, reaching fore coxal cavity; second visible segment longest, slightly incrassate, first visible segment slightly shorter than second; third segment short, less than half length of second segment, conical. Thorax (Figs 1.1; 1.2F,I,L): Pronotum: Antero–lateral pronotal angle slightly pointed, not tubercle–shaped; pronotal collar slightly curved; anterior pronotal lobe with tuberculated stripes, separated by grooves, running longitudinally or diagonally; tubercles regularly arranged into 4 to 5 columns within each stripe; anterior pronotal lobe laterally clearly ridged; posterior pronotal lobe little wider and much shorter than anterior pronotal lobe, with sparse tubercles in the front; transverse groove between anterior and posterior pronotal lobes clearly curved (Figs 1.1, 1.2F); prosternal stridulatory process long, beyond fore coxal cavity; mesosternite slightly convex; metasternite strongly convex. Scutellum: Much wider than long, or longer than wide (i.e. in *H. bicolornotum* **sp. nov.**), laterally swollen, medially depressed, scutellar process length and shape vary, short in most species, long in *H. bicolornotum*, tubercle–like or knob–shaped. Hemelytron (Fig. 1.1): Surpassing abdomen; corium medially slightly narrowed. Legs (Fig. 1.1): Fore coxa stout, elongate, dorsally with tubercles; mid and hind coxae short, rounded; trochanters simple, conical; fore femur stout, incrassate, ventrally with conical tubercles; mid femur stout, not incrassate, sub–distally thickened,

ventrally without spines or tubercles; hind femur thinner and longer than fore and mid femora, distally narrowed; fore tibia short, shorter than fore femur, stout, distally dilated, apex oblique, less than half of fossula spongiosa extending beyond tibial apex; mid tibia stout, about as long as mid femur, distally slightly thickened, apex oblique, fossula spongiosa present, small, slightly extending beyond tibial apex; hind tibia long, much longer than hind femur, slender, without fossula spongiosa; all tarsi 3-segmented, first (basal) segment very short, second segment longest, third segment slightly shorter than second; all pre-tarsi claw-like, hind pre-tarsi slightly larger than fore and mid pre-tarsi; parempodium present, bristle-like.

Abdomen (Fig. 1.1): Elongate, subrectangular, or somewhat rounded in ventral view; eighth abdominal sternite ring-like, dorsally membranous, ventro-posterior margin slightly or strongly convex (Figs 1.3–G2,G3), not forming a distinct process.

Connexivum: narrow, uninflated. Genitalia (Fig. 1.4): Pygophore: Rounded in ventral view, median process strongly bent towards right in posterior view. Parameres: Dorsal rims of both parameres humped; left and right parameres slightly asymmetrical, with left paramere slightly larger, dorsal hump more prominent, paramere stem projecting upward, and right paramere slightly smaller, dorsal hump inconspicuous or almost non-existent, paramere stem orienting horizontally or downward. *Phallus*: Lateral phallothecal plate only present on left side, anterior margin of lateral phallothecal plate slightly concave, articulation between lateral phallothecal plate and phallosoma distinct; dorsal phallothecal sclerite more heavily sclerotized on right side; apical process of dorsal phallothecal sclerite projected to left; struts incompletely fused, asymmetrical, with left strut almost straight or slightly concave and right strut convex or somewhat twisted in *H*.

*rufiventris* **sp. nov.**; pedicel of phallobase orienting towards right; basal plate arms straight to strongly curved.

Female. Only a single specimen is known. See description of *H. vadoni* comb.n.

Immature stages: Known from a new species, *H. melanoceps* **sp. nov.** described here, and from two individuals whose species identity could not be confirmed.

Descriptions of immature stages are provided in description of *H. melanoceps* **sp. nov.**

*Discussion.* Three species of this genus are distributed in northern Madagascar, with one species, *H. bipunctatus* having a wide distribution (Fig. 1.5). This distribution pattern contrasts to the southern Madagascar distribution of the species of *Bekilya*.

#### Key to the species of *Hovacoris*

Adult Male.

- 1 – Anterior pronotal lobe blackish brown; posterior pronotal lobe pale brown (Fig. 1.1)  
..... *Hovacoris bicolornotum* **sp. nov.**
- Pronotal lobes uniformly dark orange (Fig. 1.1) .....2
- 2 – Head and pleura dark orange (Fig. 1.1) ..... *Hovacoris bipunctatus* Villiers
- Head blackish brown; propleuron dark orange, mesopleuron dark brown, metapleuron blackish brown (Fig. 1.1) .....3
- 3 – Scapus and pedicellus brown; abdomen brown, sometimes medially white (Fig. 1.1)  
..... *Hovacoris melanoceps* **sp. nov.**
- Scapus white, basally brown; pedicellus white; abdomen reddish (Fig. 1.1).....  
.....*Hovacoris rufiventris* **sp. nov.**

#### ***Hovacoris bicolornotum* sp. nov.**

(Figs 1.1, 1.4, 1.5)



Holotype: Male. MADAGASCAR: Antsiranana: Marojejy Nat'l Park, 5 km W Manantenina village, Camp Mantella, 14.43816°S 49.774°E, 490 m, 04–16 Apr 2005, (MI, RHH), (UCR\_ENT 00005324 [caslot 029422/MA–31–18]) (CAS).

*Diagnosis.* Male. Recognized by the bicolourous pronotum, with anterior pronotal lobe blackish brown and posterior lobe pale brown (Fig. 1.1); the blackish brown scutellum and pleura (Fig. 1.1); the color patterns of legs indistinct (Fig. 1.1); the subrectangular abdomen; the rather broad parameres (Fig. 1.4); and the long and narrow apical process of dorsal phallosclerite (Fig. 1.4; 53–1). Distinguished from *H. bipunctatus* also by the blackish brown head, a character similar to *H. melanoceps* **sp. nov.** and *H. rufiventris* **sp. nov.**, but can be differentiated from both by the above-mentioned characters and the long scutellar process.

*Description.* Male. Colour (Fig. 1.1): Head: Uniformly blackish brown. Antenna (left antenna is anomalous – three segments are present, with basiflagellomere apparently fused with pedicellus and distiflagellomere): Scapus whitish, basally dark brown; other antennal segments uniformly dark brown. Labium: First visible segment dark brown; second segment brown, dorsally paler; last segment brown. Thorax: Anterior pronotal lobe and scutellum blackish brown; posterior pronotal lobe pale brown; all pleura blackish brown; prosternite mostly blackish brown, with prosternal stridulatory groove apically pale brown; mesosternite laterally blackish brown, medially pale brown; metasternite pale brown. Hemelytron: including clavus, corium and membrane as in generic description, with yellowish patch on corium relatively large. *Legs:* Almost all leg segments pale brown, fore femur mostly pale brown, anteriorly and posteriorly with indistinct brown patches, mid femur with weak brown band, and hind femur proximally whitish. Abdomen: Tergites, pale brown, connexivum mostly whitish, with pale brown

bands; sternites mostly pale brown, laterally with minor brown patches. Vestiture (Fig 1, 2): As in generic descriptions. Structure (Fig 1, 2): Head (Fig. 1.1): Head including eyes, antenna and labium as in generic description, with maxillary plate projection forming a small angle. Thorax (Fig. 1.1): Thorax including hemelytron and legs as in generic description, with tubercles on anterior pronotal lobe distinct, scutellum longer than wide, medial–laterally swollen; scutellar process very long and apically slightly enlarged. Abdomen (Fig. 1.1): Abdomen broad, subrectangular. Genitalia (Fig. 1.2): Genitalia including pygophore, parameres and phallus as in generic descriptions, with parameres rather broad, apical process of dorsal phallosclerite long, narrow, sharp; basal plate arms slightly curving.

Female. Unknown.

*Distribution*: known from the type locality in province Antsiranana in northeast Madagascar.

*Etymology*: named after the bicolourous pronotum, a noun in apposition.

*Discussion*: This species known from a single specimen possesses many unique characters, such as the bicolourous pronotum, the indistinct leg Colour pattern, and the very broad parameres. However, generic placement in *Hovacoris* is unambiguous. The shape and size of the head and eye, the hemelytron color pattern, the phallus structure, the shape of parameres, and the setation pattern all conform to the diagnosis of *Hovacoris*. The species is represented by a single specimen collected using malaise trap from low altitude rainforest.

*Hovacoris bipunctatus* Villiers

(Figs 1.1, 1.3–B3, 1.4, 1.5)

*Hovacoris bipunctatus* Villiers 1964, **31**: 187 [sp.n.] ; Villiers 1968: 41

[redescription, key]

Holotype: Male. MADAGASCAR: Mahajanga: Ampijoroa, Ankarafantsika, [16.23334°S 46.46666°E], P. Griveaud, (MNHN).

*Revised diagnosis.* Male. Recognized by the dark orange head (Fig. 1.1; 1–1) and pleura; and the maxillary plate forming a large projection (Fig. 1.3–B3; 27–1). The head dark orange in *H. bipunctatus* superficially resembles that of *B. mahafalya*, but they can be clearly distinguished by generic diagnoses.

*Redescription.* Male. Macropterous, medium size (8.8–10.1mm). Colour (Fig. 1.1): Head: Uniformly dark orange. Antenna: Scapus whitish to pale brown, basally darker; pedicellus, basiflagellomere, distiflagellomere uniformly dark brown. Labium: Uniformly dark orange. Thorax: Anterior and posterior pronotal lobes, scutellum and thoracic pleura uniformly dark orange; thoracic sternites pale brown to dark orange, metasternite sometimes paler. Hemelytron: Clavus mostly brown, anteriorly paler; corium anteriorly almost uniformly brown, posteriorly with a relatively large subtriangular patch; membrane of hemelytron uniformly brown, apically slightly paler. Legs: As in generic description, with fore coxa pale orangish. Abdomen: Tergites laterally brown, medially whitish; connexivum mostly whitish, with pale brown bands; sternites dark brown, laterally suffused with white, medially whitish. Vestiture (Fig. 1.1): As in generic description. Structure: Head (Fig. 1.1): Including eye, antenna and labium as in generic description; maxillary plate projection large in dorso-frontal view. Thorax: Including hemelytron and legs as in generic description, with tubercles on anterior pronotal lobe distinct, and scutellum process short, tubercle-like or somewhat knob-shaped. Abdomen (Fig. 1.1): Abdomen oval, somewhat elongate. Genitalia (Fig. 1.4): including pygophore, parameres and phallus as in generic descriptions, with parameres narrow and long, right paramere

dorsally clearly humped, right strut posteriorly oblique, apical process of dorsal phallosomal sclerite short and broad, and basal plate arms strongly curved.

Female. Unknown.

*Distribution.* Widely distributed primarily along the west coast of Madagascar in two provinces, Mahajanga and Toliara (Tuléar).

*Discussion.* The CAS specimens were identified as *H. bipunctatus* by possessing the most distinct character, the orange head, which is also observed in the holotype. This character is also seen in *B. mahafalya*. The slightly elongate abdomen and lighter thoracic sternites seen in both the holotype and the examined CAS specimens also corroborated their conspecificity. The orange head was consistently observed in all specimens, but variations in color patterns of abdominal sternites and connexivum is large. The CAS specimens were all collected using malaise traps in a variety of habitats such as dry wash, bamboo forest, dry forest, gallery forest and spiny bush.

Other material examined (Only brief specimen information described here. For detailed information see Supporting Information 1.6):

MADAGASCAR: Mahajanga: Ambovomamy Belambo 20 km NW of Port Berger, 15.45116°S 47.61333°E, 33 m, 04–18 Aug 2007, (MI, RHH), 1♂ (CAS). Analamanitra Forest, 14 km NE of Misinjo, 16.13333°S 45.7°E, 20 m, Sep 2007–Jan 2008, (MI, RHH), 5♂ (CAS). Beaboaly Bamboo Forest, 10 km SW of Soalala, 4 km from Baly village, 16.04533°S 45.804°E, 9 m, 04–10 Oct 2007, (MI, RHH), 1♂ (CAS). Parc National de Namoroka, 16.8 km 329° WNW Vilanodro, 16.376667°S 45.326667°E, 100m, 08–12 2002, (Fisher, Griswold et al.), 1♂ (CAS). Besalampy District, Analangidro dry forest, 16.6915°S 44.5235°E, 61 m, Oct–Dec 2007, (MI, RHH), 2♂(CAS). Besalampy District, Marofotra dry forest, 17 km W of Besamlampy, 16.72166°S 44.42366°E, 52 m, Dec

2007–Feb 2009, (MI, RHH), 34♂ (CAS); 21–28 Jan 2008, (MI, RHH), 2♂ (UCR).  
Maintirano District Asondrodava dry forest, 15 km N of Maintirano, 17.96533°S  
44.0355°E, 61 m, 14–21 Jan 2008, 2♂ (CAS). Namoroka 53 km from Soalala 3 km N  
Vilanandro Village, 16.47333°S 45.39133°E, 122 m, 16–23 Nov 2007, (MI, RHH), 6♂  
(CAS). Namoroka village Befatika Andranovory, 7 km NW Vilanandro village,  
16.47333°S 45.39133°E, 122 m, Sep–Oct 2007, (MI, RHH), 5♂ (AMNH); Oct 2007, (MI,  
RHH), 12♂ (CAS); 12–19 Oct 2007, (MI, RHH), 7♂ (UCR); 26 Oct–02 Nov 2007, (MI,  
RHH), 8♂ (MNHN). Parc National Tsingy de Bemaraha, 3.4 km 93(degree) E Bekopaka,  
Tombeau Vazimba, 19.14194°S 44.82805°E, 50 m, 06–10 Nov 2001, Fisher, Griswold et  
al., 1♂ (CAS). Toliara (Tuléar): Beroboka village 45 km NE Morondava, 19.9775°S  
44.82483°E, 128 m, 26–30 Oct 2007, (MI, RHH), 2♂(CAS). Cap Ste Marie Special  
Reserve, 74km S of Tsihombe, 25.58766°S 45.163°E, 37 m, Oct 2002–Nov 2003, (MI,  
FP, RHH), 7♂(CAS); 07–17 Mar 2003, (MI, FP, RHH), 1♂(UCR), 1♂ (CAS); Apr–Jul  
2003, (MI, FP, RHH), 6♂ (AMNH).

***Hovacoris melanoceps* sp. nov.**

(Figs 1.1; 1.2C,F,I,L; 1.3–A,B2,G3; 1.4)

Holotype: Male. MADAGASCAR: Antsiranana: Parc National Montagne d'Ambre,  
12.52027°S 49.17916°E, 1125 m, 29 Jan–11 Feb 2001, (MI, RHH), (UCR\_ENT  
00005279 [caslot 028766/MA–01–01D–03]) (CAS).

Paratypes (Only brief specimen information described here. For detailed  
information see Supporting Information 1.6): Males: MADAGASCAR: Antsiranana:  
Montagne des Français, 7.2 km 142 (degree) SE Antsiranana (=Diego Suarez),  
12.32277°S 49.33805°E, 180 m, 22–28 Feb 2001, Fisher, Griswold et al., 1♂ (CAS).  
Parc National Montagne d'Ambre, 12.52027°S 49.17916°E, 1125 m, Jan–Apr 2001, (MI,

RHH), 2♂ (CAS); 12–14 May 2001, (MI, RHH), 1♂ (UCR). Rés. Analamerana, 28.4 km 99° Anivorano–Nord, 12.74666°S 49.49472°E, 60 m, 05 Dec 2004, B.L. Fisher, 1♂ (CAS). Sakalava Beach, dwarf littoral forest, 12.26277°S 49.3975°E, 10 m, 07–21 Apr 2001, (MI, RHH), 2♂ (AMNH); Apr–May 2001, (MI, RHH), 7♂ (CAS); 31 May–07 Jun 2001, (MI, RHH), 1♂ (UCR); Jul–Aug 2001, (MI, RHH), 3♂ (MNHN). Dry forest, 7km N of Joffreville, 12.33333°S 49.25°E, 360 m, Feb–May 2001, (MI, RHH), 2♂ (CAS).

Other specimens examined: Imatures: MADAGASCAR: Antsiranana: Rés. Analamerana, 28.4 km 99° Anivorano–Nord, 12.74666°S 49.49472°E, 60 m, 05 Dec 2004, B.L. Fisher, 3 specs (CAS).

*Diagnosis*. Male. Recognized by the blackish brown head, the brown scapus; the generally darker body colors; the small whitish patch on corium; the slightly rounded abdomen (Fig. 1.1); the somewhat broad parameres, the dorsal hump of the right paramere very reduced, almost non-existent (Fig. 1.4); and the right strut almost straight, apically gradually tapering (Fig. 1.4).

Female. Unknown.

*Description*. Male. Colour (Fig. 1.1): Head: Dorsally uniformly blackish brown; ventrally paler and slightly reddish. *Antenna*: Scapus brown, basally darker; pedicellus brown; basiflagellomere dark brown; distiflagellomere uniformly brown. *Labium*: Dark brown, sometimes ventro–medially paler. Thorax: Pronotum and scutellum uniformly dark orange; propleuron dark orange; mesopleuron dark brown; metapleuron blackish brown; prosternite dark orange, mesosternite brown or orangish brown, metasternite dark brown to blackish brown. *Hemelytron*: Clavus mostly dark brown, proximally paler; corium mostly dark brown, distally with a relatively small pale brownish to yellowish patch, anterior margin of this patch not or barely exceeding cu–pcu crossvein;

membrane of hemelytron uniformly brown. *Legs*: As in generic description, with fore coxa dark orange. *Abdomen*: Tergites nearly uniform brown; connexivum mostly whitish, each segment posteriorly with pale brown band adjacent to intersegmental suture; sternite segments 2–6 (visible segments 1–5) dark brown, laterally suffused with white, medially whitish, segment 7 entirely dark brown. *Vestiture* (Fig 1, 2): As in generic descriptions. *Structure*: (Figs 1.1; 1.2C,F,I,L; 1.3–A,B2; 1.4): *Head*: Including eyes, antenna, and labium as in generic description, with maxillary plate projection forming a small angle. *Thorax*: Including hemelytron and legs as in generic description, with scutellar process short, sometimes nearly knob-shaped, and tubercles on anterior pronotal lobe indistinct. *Abdomen*: Short and somewhat rounded in ventral view. *Genitalia*: including pygophore, parameres and phallus as in generic description, with left paramere relatively short and broad, dorsal hump of right paramere very reduced, almost non-existent; right strut anteriorly straight, posteriorly gradually tapering, apical process of dorsal phallothecal sclerite short, and basal plate arms almost straight.

Female. Unknown.

*Immature*: Fifth instar: Sex unknown (UCR\_ENT 00005311): Small. Colour, Vestiture and Structure as in description of fifth instar immature male of *B. tuleara*, with head dorsally blackish brown and ventrally reddish brown, fore femur dark brown, abdominal sternite 3–6 mostly whitish, sternites 6 and 7 reddish orange, 7 without brown dots, 8–10 dark reddish brown, setae colors generally darker, setae on abdominal tergite 2 brown-colored, maxillary plate projected, tuberculated stripes on anterior pronotal lobe wide, each with 4 or 5 columns, wing pads with few tubercles, and abdomen elongate.

*Distribution*: Madagascar, Province Anatsiranana. Found from low elevation littoral or dry tropical forest to high elevations. immature stages are in close proximity

with some of the adult specimens.

*Etymology*: Named for the blackish brown head from combining the Greek adjective *melanos* and noun *ceps*, meaning black and head, a noun in apposition.

*Discussion*. *Hovacoris melanoceps* is most similar to *H. rufiventris* **sp. nov.**, but differs from the latter in the dark brown abdomen, the somewhat short and broad parameres, the right paramere without clear dorsal hump. *Hovacoris melanoceps* can be easily distinguished from *H. bipunctatus* by the blackish brown head and features of parameres and phallus. Few morphological characters can be used to differentiate immature specimens of *H. melanoceps* from that of *B. tuleara*. The leg Colour patterns of the immature specimens including the uniformly colored fore femur, and the brown trochanters are indeed similar to that of adult specimens of *Bekilya* and rather different from *Hovacoris* species. All specimens were collected using malaise traps from low elevation (10 m) dwarf littoral forest, mid elevation (60, 180 and 360 m) dry forest, and high elevation area (1125 m).

***Hovacoris rufiventris*, sp. nov.**

(Figs 1.1, 1.4)

Holotype: Male. MADAGASCAR: Antsiranana: Forêt d'Analabe, 30.0 km 72° ENE Daraina, 13.08333°S 49.90833°E, 30 m, 27 Nov 2003, B.L. Fisher, (UCR\_ENT 00005325 [caslot 026889/CBLF9428]) (CAS).

*Diagnosis*. Male. Recognized by the blackish brown head; the whitish pedicellus; the large yellowish patch on corium; the almost entirely reddish abdomen (Fig. 1.1); the long and narrow parameres; the left paramere apically broad; the straight basal plate arms, the struts somewhat twisted. (Fig. 1.4). Female. Unknown.

*Description*. Male. Colour (Fig. 1.1): Head: Uniformly blackish brown, ventrally



paler and appearing slightly reddish. Antenna: Scapus whitish, basally dark; pedicellus entirely whitish; basiflagellomere dark, distally brown, basal third whitish; distiflagellomere dark brown, basally lighter. Labium: dark brown, last visible segment paler. Thorax: Pronotum and scutellum uniformly dark orange; propleuron dark orange, mesopleuron dark brown, metapleuron blackish brown; thoracic sternites orangish brown. Hemelytron: Clavus mostly brown, proximally pale, corium proximally brown, distally with large whitish patch, anterior margin of which clearly exceeding cu–pcu crossvein; membrane of hemelytron uniformly brown. Legs: As in generic description, with all coxae whitish, basally brown, and hind tibia entirely brown. Abdomen: Tergites and sternites uniformly orangish red, connexivum almost entirely red, banded with white. Vestiture (Fig. 1.1): As in generic descriptions. Structure (Figs 1.1, 1.4): Head (Fig. 1.1): Including eye, antenna, and labium as in generic description, with maxillary plate projection forming a small angle. Thorax (Fig. 1.1): Including hemelytron and legs as in generic description, with tubercles on anterior pronotal lobe indistinct, scutellum wider than long, scutellar process short, tubercle–like. Abdomen (Fig. 1.1): Short and somewhat rounded, sternal segments about equal width. Genitalia: Including pygophore, parameres and phallus as in generic description, with left paramere apically broad, dorsal hump on right paramere distinct, apical process of dorsal phallosomal plate short and broad, struts a little bit twisted, and basal plate arms straight.

*Female.* Unknown.

*Distribution.* Madagascar, western part of province Antsiranana.

*Etymology.* Formed by combining the Latin adjective *rufus* and noun *venter*, meaning red and belly for the red–colored abdomen.

*Discussion.* *Hovacoris rufiventris* is most similar and sister to *H. melanoceps* in

the morphological phylogenetic analysis. Both have blackish brown head and metapleuron, abdomen slightly rounded, and straight basal plate arms. It differs from the latter by the red-colored abdomen, the shape of parameres, the whitish scapus and pedicellus and the basally whitish basiflagellomere.

***Hovacoris vadoni* (Villiers) comb.n.**

(Fig. 1.1)

*Mutillocoris vadoni* Villiers, 1968: 53 [sp. nov.]

Holotype: Female. MADAGASCAR: Sahafary, J. Vadon, and A. Peyrieras.

MNHN (EH) 4107, (MNHN).

*Revised diagnosis.* Female. As in generic diagnosis.

*Redescription.* Female. brachypterous, small (~10mm). Colour, vestiture and structure very similar to that of *Bekilya* spp. Details not provided since specimen was examined only from photos. Male. unknown.

*Distribution.* A single female specimen known from Sahafary, eastern Madagascar.

*Discussion.* Several places with the same name, Sahafary were found in eastern Madagascar, and this locality was not geo-referenced. Associating the single female specimen with any of the males of *Hovacoris* spp. was impossible for *H. vadoni* due to the lack of specimens suitable for extracting DNA. Morphology was thus used as the basis for its generic placement. Its affinity to the *Hovacoris* genus group was confirmed by the color patterns and the body tuberculation. The smaller body size (10 mm) and the blackish head support its placement in *Hovacoris*. The blackish head and locality rule out *H. bipunctatus*, the males of which all have dark orange heads and are known from south and northwest Madagascar. *Hovacoris vadoni* could be conspecific with *H.*

*bicolornotum*, *H. melanocephs*, or *H. rufiventris* and association would become possible once specimens for extracting molecular data become available.

## References

- Brailovsky, H. 2006. A new species of *Hydara* (Hemiptera: Coreidae: Coreinae: Hydarini) from Madagascar. *Zootaxa*, 1351, 15-22.
- Cai, W. and Taylor, S. J. 2006. *Lentireduvius*, a new genus of Peiratinae from Brazil, with a key to the New World genera (Hemiptera: Reduviidae). *Zootaxa*, 1360, 51-60.
- Caterino, M. S. and Tishechkin, A. K. 2006. DNA identification and morphological description of the first confirmed larvae of Hetaeriinae (Coleoptera: Histeridae). *Systematic Entomology*, 31, 405-418.
- Cranston, P. S. 2009. A new genus of trans-Tasman midge: *Anzacladius* gen. n. (Diptera: Chironomidae: Orthocladiinae). *Australian Journal of Entomology*, 48, 130-139.
- Dallwitz, M.J. 1980. A general system for coding taxonomic descriptions. *Taxon*, 29, 41-46.
- Dallwitz, M. J., Paine, T. A. and Zurcher, E. J. 1999 onwards. User's guide to the DELTA Editor. <http://delta-intkey.com>
- Damgaard, J., Andersen, N. M., Cheng, L. and Sperling, F. A. H. 2000. Phylogeny of sea skaters, *Halobates* Eschscholtz (Hemiptera, Gerridae), based on mtDNA sequence and morphology. *Zoological Journal of the Linnean Society*, 130, 511-526.
- Davis, N. T. 1966. Contributions to morphology and phylogeny of Reduvidae (Hemiptera - Heteroptera). Part III. The male and female genitalia. *Annals of the Entomological Society of America*, 59, 911-924.
- DeSalle, R., Egan, M. G. and Siddall, M. 2005. The unholy trinity: taxonomy, species delimitation and DNA barcoding. *Philosophical Transactions of the Royal Society B-Biological Sciences*, 360, 1905-1916.
- Dougherty, V. 1995. A review of the New World Ectrichodiinae genera (Hemiptera: Reduviidae). *Transactions of the American Entomological Society* (Philadelphia), 121, 173-225
- Fisher, B. L. 2005. A model for a global inventory of ants: a case study in Madagascar. *Proceedings of the California Academy of Sciences*, ser. 4, 56 (Suppl. I).
- Fisher, B. L. and Smith, M. A. 2008. A revision of Malagasy species of *Anochetus* Mayr and *Odontomachus* Latreille (Hymenoptera: Formicidae). *PLoS ONE*, 3, e1787. doi:10.1371/journal.pone.0001787.

- Goloboff, P. 1999. NONA (NO NAME) ver. 2 Published by the author, Tucumán, Argentina.
- Goloboff, P. A., Farris, J. S. and Nixon, K.C. 2008. TNT, a free program for phylogenetic analysis. *Cladistics*, 24, 774-786.
- Goodman, S. M. and Benstead, J. P. 2005. Updated estimates of biotic diversity and endemism for Madagascar. *Oryx*, 39, 73-77.
- Göllner-Scheiding, U. 2005. Revision der afrikanischen Arten der Gattung *Lasiacantha* Stål, 1873 (Heteroptera: Tingidae: Tinginae: Tingini). *Beitrage Entomologischen*, 55, 363-386.
- Green, G. M. and Sussman R. W. 1990. Deforestation history of the eastern rain forests of Madagascar from satellite images. *Science*, 248, 212-215.
- Heterick, B. 2006. A Revision of the Malagasy Ants Belonging to Genus *Monomorium* Mayr, 1855 (Hymenoptera: Formicidae). *Proceedings of the California Academy of Sciences*, 57, 69-202.
- Hwang, W. S. and Weirauch, C. 2010 Revision of the Malagasy *Durevius* Villiers with descriptions of two new species (Hemiptera: Reduviidae: Reduviinae). *Insect Systematics and Evolution*, 41, 123-141.
- Jeon, M. J. and Ahn, K. J. 2009. Description of late-instars of *Bryothinusa koreana* Ahn and Jeon (Coleoptera: Staphylinidae: Aleocharinae) by association of life stage based on DNA sequence data. *Florida Entomologist*, 92, 367-373.
- Kathirithamby, J., Hayward, A., McMahon, D. P., Ferreira, R. S., Andreatze, R., de Almeida Andrade, H.T., and Fresneau, D. 2010. Conspecifics of a heterotrophic heteronomous species of Strepsiptera (Insecta) are matched by molecular characterization. *Systematic Entomology*.
- Katoh, K., Kuma, K.-I., Toh, H. and Miyata, T. 2005. MAFFT version 5: improvement in accuracy of multiple sequence alignment. *Nucleic Acids Research*, 33, 511-518.
- Katoh, K., Misawa, K., Kuma, K. and Miyata, T. 2002. MAFFT: a novel method for rapid multiple sequence alignment based on fast Fourier transform. *Nucleic Acids Research*, 30, 3059-3066.
- Kumar, S., Dudley, J., Nei, M. and Tamura, K. 2008. MEGA: A biologist-centric software for evolutionary analysis of DNA and protein sequences. *Briefings in Bioinformatics*, 9, 299-306.
- Labina, E. S. and Kerzhner, I. M. 2000. A complex case of homonymy in the Emesinae from Madagascar (Heteroptera: Reduviidae). *Zoosystematica Rossica*, 9, 226.

- Levkanicova, Z. and Bocak, L. 2009. Identification of net-winged beetle larvae (Coleoptera: Lycidae) using three mtDNA fragments: a comparison of their utility. *Systematic Entomology*, 34, 210-221.
- Maldonado Capriles, J. 1988. A new species of *Chondrolophus* and a key to the species (Insecta: Hemiptera: Reduviidae). *Bulletin and Annales de la Societe Royale Belge d'Entomologie*, 124, 229-232.
- Maldonado Capriles, J. 1990. *Systematic Catalogue of the Reduviidae of the World (Insecta: Heteroptera)*. (Special edition of the *Caribbean Journal of Science*). University of Puerto Rico, Mayagüez, Puerto Rico.
- Meier, R., Shiyang, K., Vaidya, G. and Ng, P. K. L. 2006. DNA barcoding and taxonomy in diptera: A tale of high intraspecific variability and low identification success. *Systematic Biology*, 55, 715-728.
- Meier, R., Zhang, G. and Ali, F. 2008. The use of mean instead of smallest interspecific distances exaggerates the size of the "barcoding gap" and leads to misidentification. *Systematic Biology*, 57, 809-813.
- Miller, K. B., Alarie, Y., Wolfe, G. W. and Whiting, M. F. 2005. Association of insect life stages using DNA sequences: the larvae of *Philodytes umbrinus* (Motschulsky) (Coleoptera: Dytiscidae). *Systematic Entomology*, 30, 499-509.
- Miller, N. C. E. 1956) *The Biology of the Heteroptera*. Leonard Hill Books Limited, London.
- Moulet, P. 2000. Two new palaeartic Reduviidae and synonymic note (Hemiptera, Heteroptera). *Nouvelle Revue d'Entomologie*, 17, 197-203.
- Myers, N., Mittermeier, R. A., Mittermeier, C. G., da Fonseca, G.A.B. and Kent, J. 2000. Biodiversity hotspots for conservation priorities. *Nature*, 403, 853-858.
- Nixon, K. C. 1999-2002. WinClada ver. 1.0000 Published by the author, Ithaca, NY, USA.
- Pilgrim, E. M. and Pitts, J. P. 2006. A molecular method for associating the dimorphic sexes of velvet ants (Hymenoptera: Mutillidae). *Journal of the Kansas Entomological Society*, 79, 222-230.
- Putshkov, V. G. and Putshkov, P. V. 1986-1989. A catalogue of the Reduviidae (Heteroptera) of the world, 6 volumes. Vinity, Lyubertsy.
- Rios, N. E. and Bart, H. L. Jr. 2005. GEOLocate. Georeferencing software for natural history collections. Version 2.13 [software]. Available at: <http://www.museum.tulane.edu/geolocate/default.aspx>.

- Schatz, G. E. 2002. Taxonomy and herbaria in service of plant conservation: lessons from Madagascar's endemic families. *Annals of the Missouri Botanical Garden*, 89, 145-152.
- Schuh, R. T. and Slater, J. A. 1995. *True Bugs of the World (Hemiptera: Heteroptera): Classification and Natural History*. Cornell University Press, Ithaca, New York.
- Simon, C., Frati, F., Beckenbach, A. and Crespi, B. 1994. Evolution, weighting, and phylogenetic utility of mitochondrial gene sequence and a compilation of conserved polymerase chain reaction primers. *Annals of the Entomological Society of America*, 87, 651-701.
- Smith, M. L., Brian, L. F. and Hebert P. D. N. 2005. DNA barcoding for effective biodiversity assessment of a hyperdiverse arthropod group: the ants of Madagascar. *Philosophical Transactions of the Royal Society B: Biological Sciences*, 360, 1825-1834.
- Tamura, K., Dudley, J., Nei, M. and Kumar, S. 2007. MEGA4: Molecular Evolutionary Genetics Analysis (MEGA) software version 4.0. *Molecular Biology and Evolution* 24, 1596-1599.
- Villiers, A. 1968. Insectes. Hémiptères. Reduviidae. (1<sup>ère</sup> partie). *Faune de Madagascar*, 28, 1-198.
- Weirauch, C. 2007. Hairy attachment structures in Reduviidae (Cimicomorpha, Heteroptera), with observations on the fossula spongiosa in some other Cimicomorpha. *Zoologischer Anzeiger*, 246, 155-175.
- Weirauch, C. 2008a. *Mangabea barbiger*, new species of Collartidini (Heteroptera, Reduviidae, Emesinae) from Madagascar. *Advances in Heteroptera Research*. (ed. by S. Grozeva and N. Simov), Pensoft Publishers, Sofia, Bulgaria.
- Weirauch, C. 2008b. Cladistic analysis of Reduviidae (Heteroptera: Cimicomorpha) based on morphological characters. *Systematic Entomology*, 33, 229-274.
- Willemsse, L. 1985. A taxonomic revision of the New World species of *Sirthenea* (Heteroptera: Reduviidae: Peiratinae). *Zoologische Verhandlungen*, 215, 1-67.
- Wygodzinsky, P. 1966. A monograph of the Emesinae (Reduviidae, Hemiptera). *Bulletin of the American Museum of Natural History*, 133, 1-614.
- Zhou, X., Kjer, K. M. and Morse, J. C. 2007. Associating larvae and adults of Chinese Hydropsychidae caddisflies (Insecta: Trichoptera) using DNA sequences. *Journal of the North American Benthological Society*, 26, 719-7.

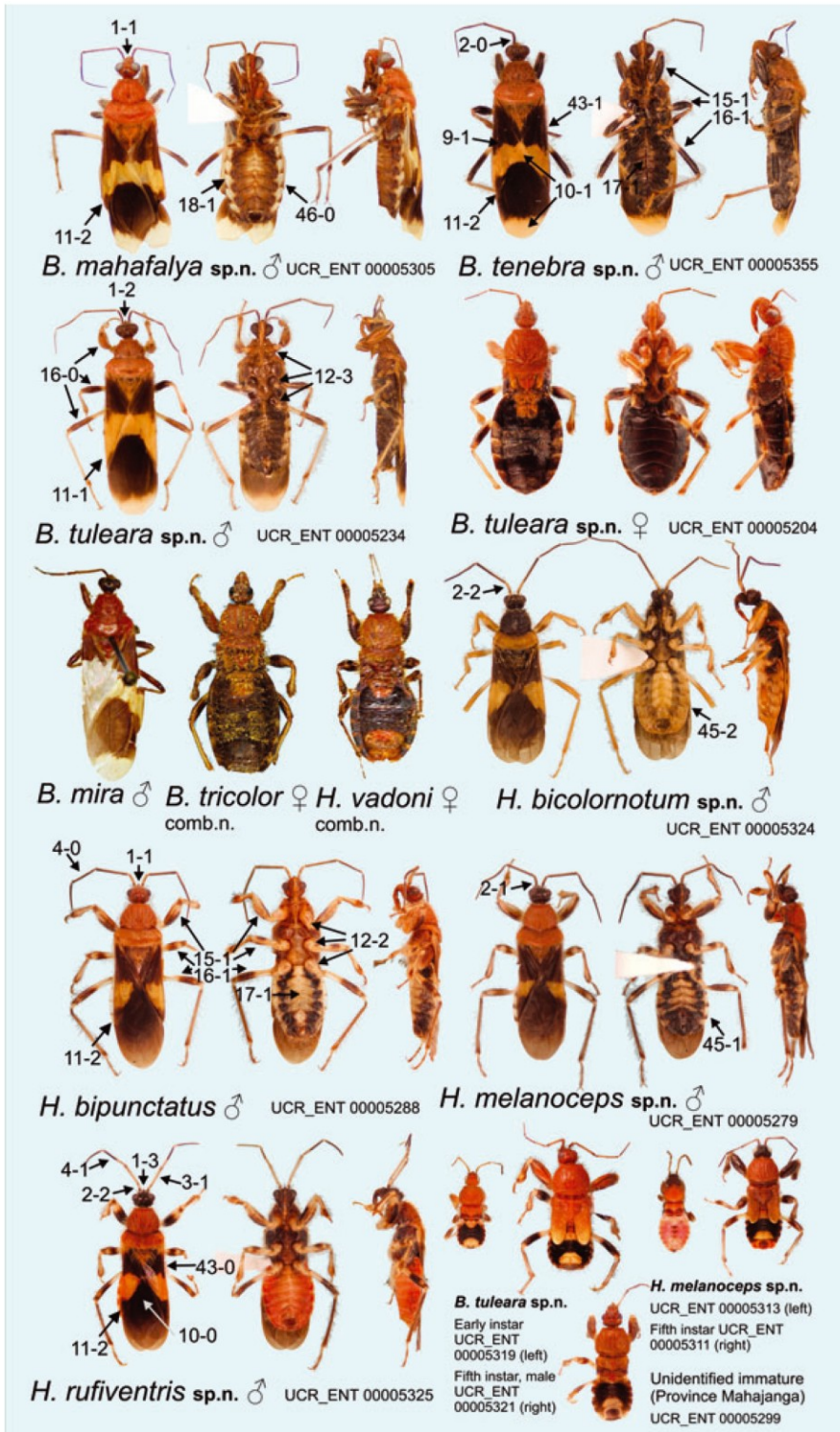

Figure 1.1. Habitus of adults of *Bekilya* spp. and *Hovacoris* spp. in dorsal, ventral and lateral views and immature stages in dorsal view.



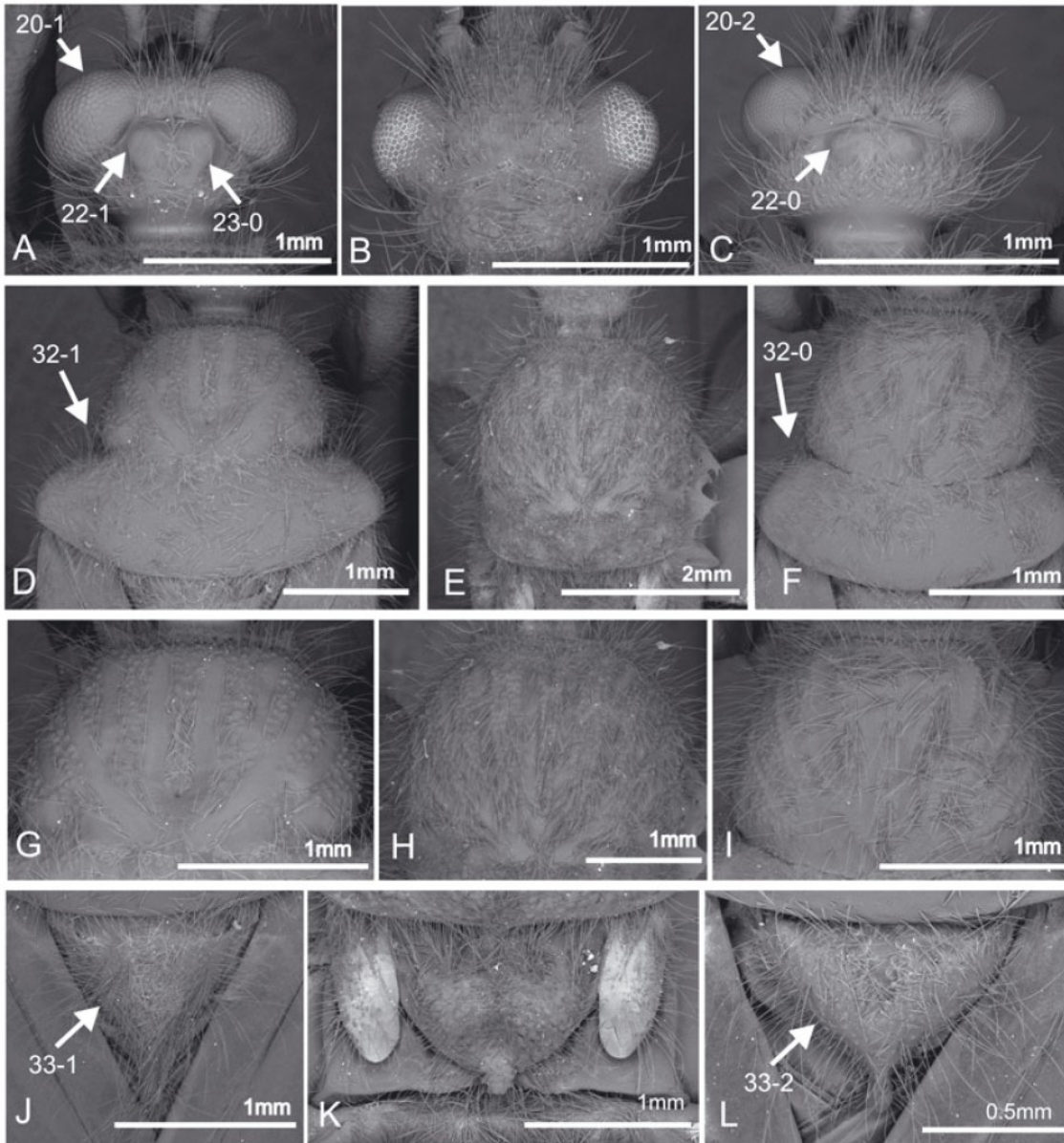

Figure 1.2. Scanning electron microscopy images. A,D,G,J – *B. tuleara* **sp. nov.**, male, UCR\_ENT 00005225; B,E,H,K – *B. tuleara* **sp. nov.**, female, UCR\_ENT 00005204; C,F,I,L – *H. melanoceps* **sp. nov.**, male, UCR\_ENT 00005265. A–C, head; D–F, pronotum; G–I, anterior pronotal lobe; J–L, scutellum.

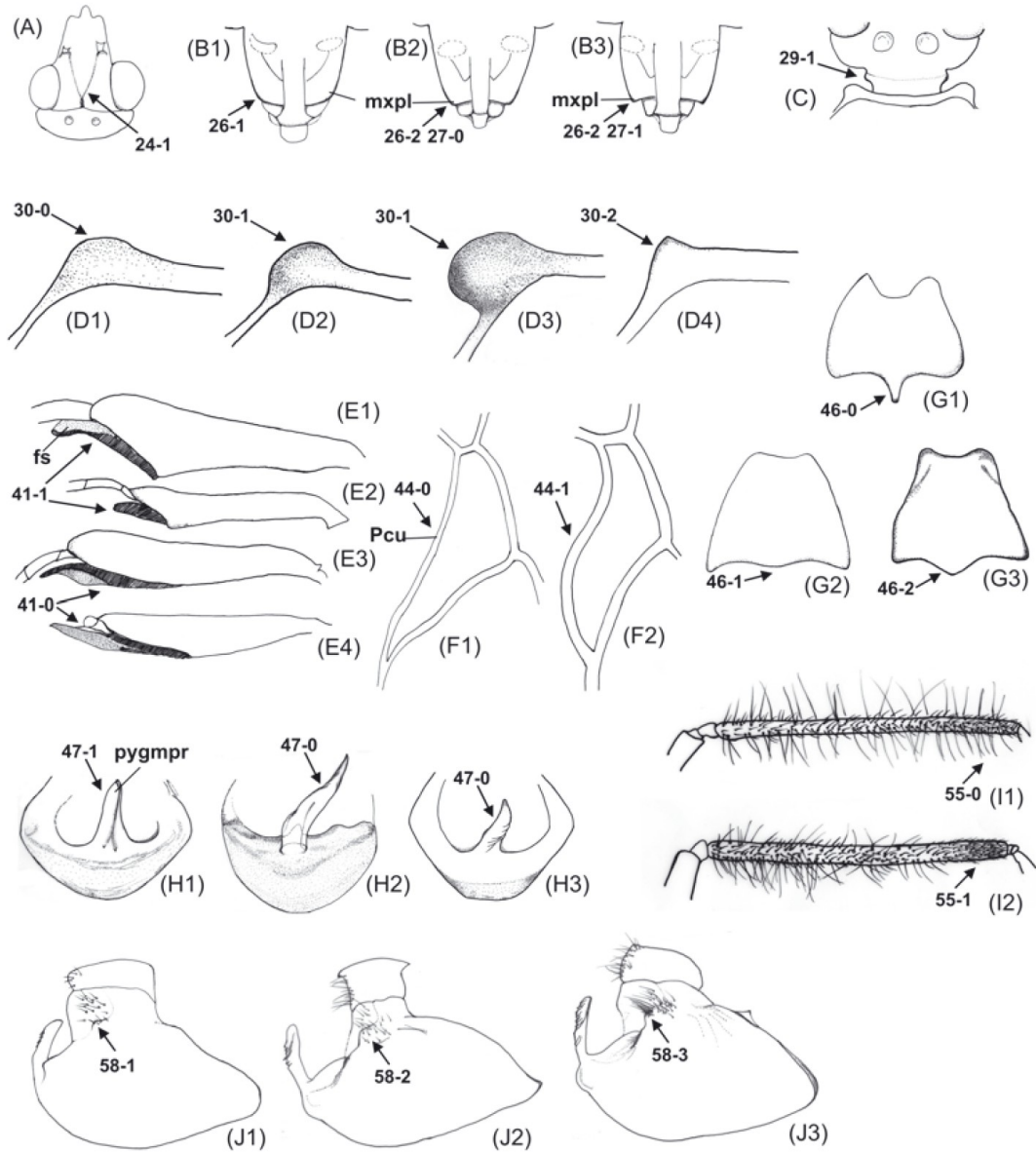

Figure 1.3. Morphological characters of the species of *Bekilay* group and outgroups. (A) *H. melanoceps* **sp. nov.**, UCR\_ENT 000005265; (B1) *B. tuleara* **sp. nov.**, UCR\_ENT00005250; (B2) *H. melanoceps* **sp. nov.**, UCR\_ENT 00023173; (B3) *H. bipunctatus*, UCR\_ENT 00005279; (C1) (D2) (E3) (G1) (H1) *Pseudolestomerus* **sp.**, UCR\_ENT 00000175; (D1) (E4) (F1) (H2) *Sirthenea* **sp.**, UCR\_ENT 00006048; (D3) (E1) *Lestomerus* **sp.**, UCR\_ENT 00000176; (D4) *B. tuleara* **sp. nov.**, UCRENT 00023159; (E2) *B. tuleara* **sp. nov.**, UCR\_ENT 00003674; (F2) *B. tuleara* **sp. nov.**, UCR\_ENT 00005235; (G2) (H3) *B. tuleara* **sp. nov.**, UCR\_ENT 00003667; (G3) *H. melanoceps* **sp. nov.**, UCR\_ENT 00005266; (J1) *H. bipunctatus*, UCR\_ENT 00005290; (J2) *B. mahafalya* **sp. nov.**, UCR\_ENT 00005305; (J3) (I2) *B. tenebra* **sp. nov.**, UCR\_ENT 00005355; (I1) *B. tuleara* **sp. nov.**, UCR\_ENT 00003671. (A) v-shaped groove on head

in dorsal view; (B1)-(B3) maxillary plate in dorso-frontal view; (C) tubercle on neck; (D1)-(D4) left antero-lateral angle of anterior pronotal lobe; (E1), (E2) left fore tibia showing fossula spongiosa; (F1), (F2) postcubitus; (G1)-(G3) eighth abdominal segment in ventral view; (H1)-(H2) pygophore in posterior view; (J1)-(J3) pygophore in right lateral view; (I1)-(I2) basiflagellomere.

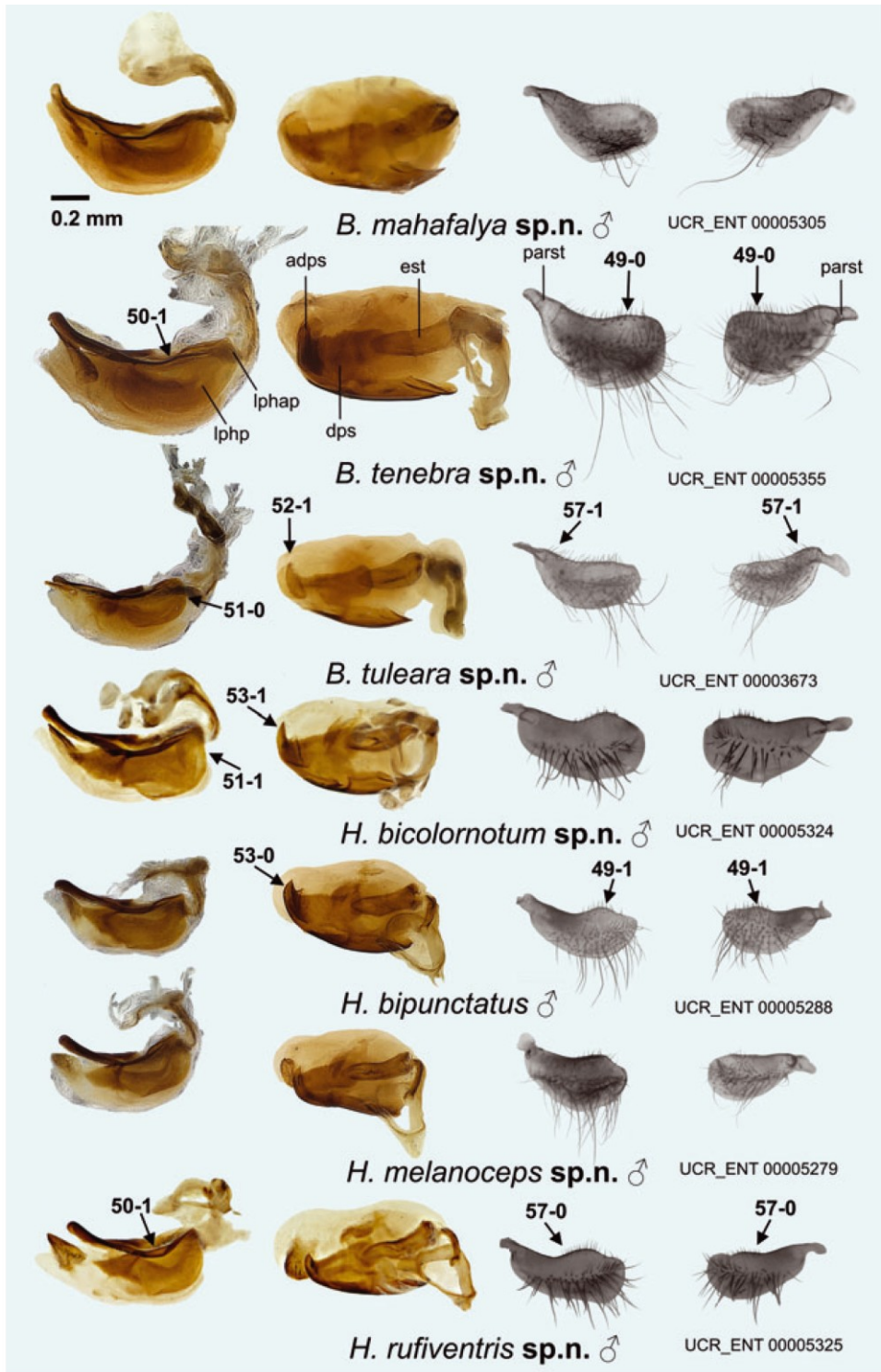

Figure 1.4. Male genitalia of *Bekilya* spp. and *Hovacoris* spp. From left to right: phallus in right lateral view, phallus in dorsal view, left paramere and right paramere in posterior view.

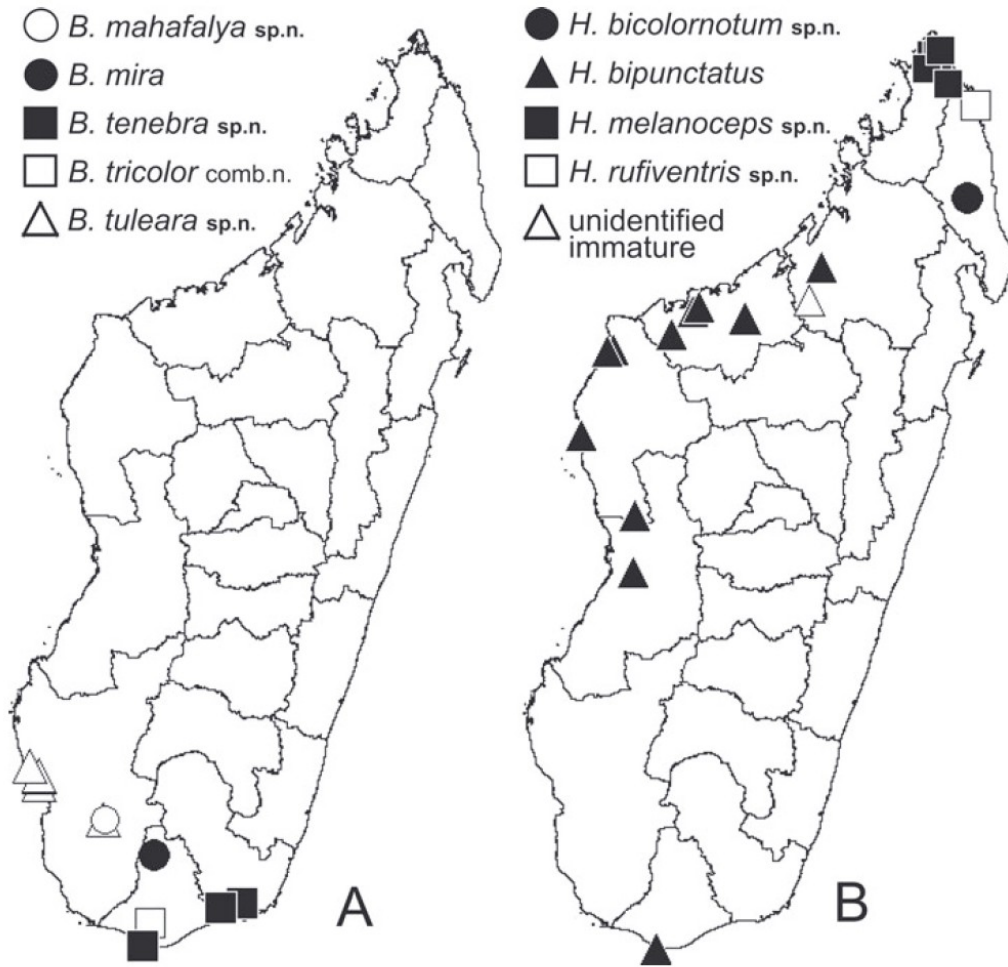

Figure 1.5. Distributions of *Bekilya* spp. (A) and *Hovacoris* spp. (B). The unidentified immature is plotted on the map of *Hovacoris*.

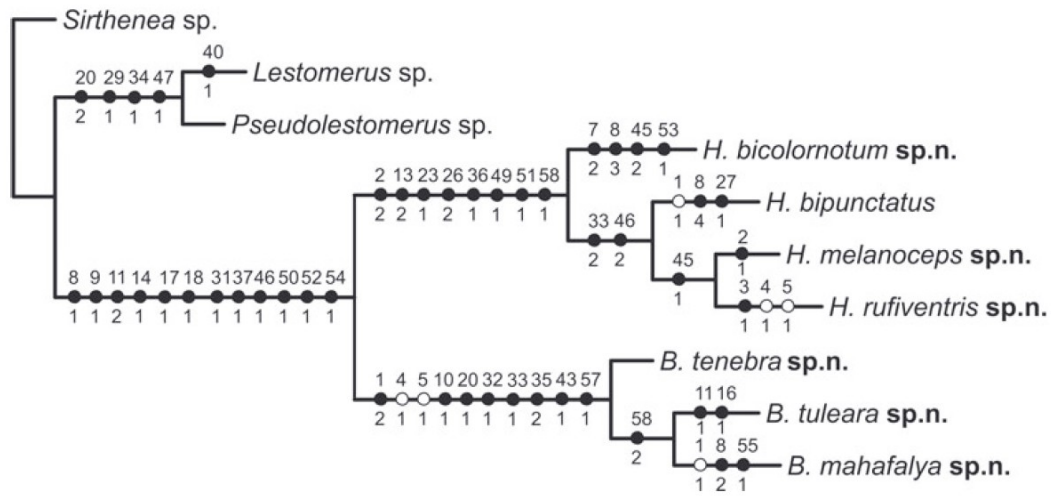

Figure 1.6. The most parsimonious tree based on morphological characters (Tree length=90, CI=88, RI=89). Characters are mapped unambiguously. Filled circles indicate non-homoplastic characters, open circles homoplastic characters. Numbers above circles refer to character number and below circles character state.

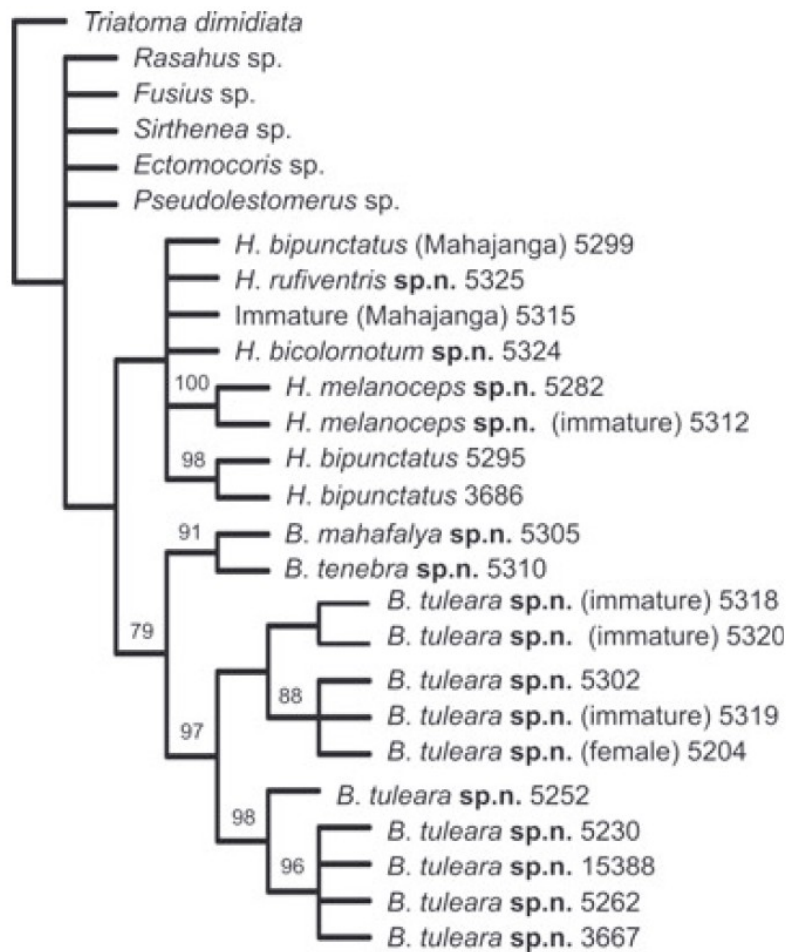

Figure 1.7. Strict consensus of 16 equally most parsimonious trees of species of the *Bekilya* group based on molecular data (Tree length=682, CI=40, RI=52, 1000 bootstrap replicates). Numbers above branches indicated bootstrap supports of more than 50%. Numbers after species or terminal names are Unique Specimen Identifier (USI) label numbers with prefix 'UCR\_ENT' and four zeros omitted, e.g., 5299 refers to specimen with USI: UCR\_ENT 00005299.

Table 1.1. Pairwise genetic distances between *COI* sequences of female or immature specimens and male or adult specimens of species of the *Bekilya* group. Geographic distances were estimated using Google Earth by plotting a straight line between two localities.

Female/immature specimen(s)	Distance to/identity of the closest sequence (locality)	Distance to/identity of next closest sequence of a second species	Gap between the smallest and next smallest distances	Geographic distance (km)
Female ( <i>B. tuleara</i> <b>sp.n.</b> )	0.2%/ <i>B. tuleara</i> <b>sp.n.</b>	12.4%/ <i>B. mahafalya</i> <b>sp.n.</b>	12.2%	~15
Immature ( <i>B. tuleara</i> <b>sp.n.</b> )	0.4-1.8%/ <i>B. tuleara</i> <b>sp.n.</b>	12.4%/ <i>B. mahafalya</i> <b>sp.n.</b>	10.6-12%	~15.4
Immature ( <i>H. melanoceps</i> <b>sp.n.</b> )	0.9%/ <i>H. melanoceps</i> <b>sp.n.</b>	14.2%/ <i>H. bipunctatus</i>	13.3%	0
Immature (Unidentified from province Mahajanga)	9.4%/ <i>H. bipunctatus</i>	15.3%/ <i>H. bicolornotum</i> <b>sp.n.</b>	5.9%	~1,090



Supporting Information 1.1. Measurements of species of *Bekilya* spp.

		Length (mm)											Width (mm)				
		Total	Head	Ante-ocular	Post-ocular	Scapus	Pedicellus	Anterior pronotal lobe	Posterior pronotal lobe	Scutellum	Abdomen	Wing (Obliquely)	Head	Inter-ocular	Anterior pronotal lobe (width)	Posterior pronotal lobe (width)	Abdomen (width, including connexivum)
<i>B. mahafalya</i> (n=1)	UCR_ENT 00005305	12.80	1.80	0.64	0.26	0.68	2.02	1.40	1.30	1.30	5.80	9.50	1.58	0.46	1.82	3.40	3.90
<i>B. tuleara</i>	<b>Mean</b>	<b>12.68</b>	<b>1.74</b>	<b>0.65</b>	<b>0.31</b>	<b>0.79</b>	<b>2.29</b>	<b>1.58</b>	<b>1.15</b>	<b>1.20</b>	<b>5.39</b>	<b>9.44</b>	<b>1.46</b>	<b>0.40</b>	<b>1.94</b>	<b>3.23</b>	<b>3.27</b>
Males (n=5)	Standard Deviation	0.63	0.05	0.04	0.01	0.06	0.14	0.11	0.06	0.07	0.27	0.47	0.07	0.04	0.21	0.08	0.08
	Range	1.30	0.14	0.10	0.02	0.12	0.38	0.28	0.13	0.18	0.65	1.10	0.20	0.10	0.57	0.20	0.20
	Minimum	12.00	1.66	0.60	0.30	0.72	2.07	1.45	1.07	1.12	4.95	8.80	1.34	0.34	1.66	3.15	3.13
	Maximum	13.30	1.80	0.70	0.32	0.84	2.45	1.73	1.20	1.30	5.60	9.90	1.54	0.44	2.23	3.35	3.33
Female (n=1)	UCR_ENT 00005204	12.10	2.10	0.35	0.42	0.88	1.68	2.05	0.72	0.88	6.40	1.00	1.55	0.70	2.65	2.55	4.48
<i>B. tenebra</i>	UCR_ENT 00005310	12.00	1.92	0.84	0.36	0.72	2.25	1.63	1.33	1.36	5.80	9.10	1.54	0.48	2.40	3.23	3.90
Males (n=2)	UCR_ENT 00005355	13.10	1.94	0.82	0.32	0.86	2.38	1.77	1.43	1.30	6.00	10.20	1.60	0.48	2.43	3.33	3.60
<i>H. bicolornotum</i> . Male (n=1)	UCR_ENT 00005324	11.20	1.60	0.64	0.30	0.68	1.90	1.54	1.08	0.96	4.80	8.20	1.36	0.60	1.86	2.93	3.33
<i>H. bipunctatus</i>	<b>Mean</b>	<b>9.36</b>	<b>1.48</b>	<b>0.66</b>	<b>0.30</b>	<b>0.56</b>	<b>1.56</b>	<b>1.46</b>	<b>0.87</b>	<b>0.76</b>	<b>3.94</b>	<b>6.82</b>	<b>1.25</b>	<b>0.59</b>	<b>1.86</b>	<b>2.55</b>	<b>2.92</b>
Male (n=5)	Standard Deviation	0.49	0.04	0.03	0.02	0.04	0.12	0.10	0.09	0.04	0.25	0.37	0.07	0.04	0.14	0.13	0.08
	Range	1.30	0.08	0.08	0.04	0.08	0.24	0.28	0.22	0.10	0.65	1.00	0.16	0.10	0.38	0.30	0.17
	Minimum	8.80	1.44	0.64	0.28	0.52	1.42	1.30	0.72	0.70	3.60	6.30	1.18	0.54	1.70	2.40	2.83
	Maximum	10.10	1.52	0.72	0.32	0.60	1.66	1.58	0.94	0.80	4.25	7.30	1.34	0.64	2.08	2.70	3.00
<i>H. melanoceps</i>	<b>Mean</b>	<b>9.45</b>	<b>1.50</b>	<b>0.64</b>	<b>0.27</b>	<b>0.57</b>	<b>1.51</b>	<b>1.38</b>	<b>0.81</b>	<b>0.74</b>	<b>3.93</b>	<b>6.67</b>	<b>1.20</b>	<b>0.53</b>	<b>1.83</b>	<b>2.53</b>	<b>3.08</b>
Males (n=4)	Standard Deviation	0.44	0.02	0.02	0.01	0.02	0.01	0.04	0.03	0.03	0.22	0.50	0.02	0.01	1.83	0.09	0.26
	Range	0.90	0.04	0.04	0.02	0.04	0.02	0.08	0.06	0.08	0.50	1.00	0.04	0.02	0.12	0.21	0.62
	Minimum	9.20	1.48	0.62	0.26	0.54	1.50	1.36	0.78	0.70	3.70	6.20	1.18	0.52	1.78	2.43	2.73
	Maximum	10.10	1.52	0.66	0.28	0.58	1.52	1.44	0.84	0.78	4.20	7.20	1.22	0.54	1.90	2.63	3.35
<i>H. rufiventris</i>																	
Male (n=1)	UCR_ENT 00005325	9.00	1.36	0.54	0.28	0.52	1.42	1.40	0.80	0.62	3.90	6.40	1.18	0.58	1.80	2.28	2.87

Supporting Information 1.2. List of characters and character states used in the cladistic analysis

COLORATION (Fig. 1)

1. Head: brown = 0; orange = 1; dark brown suffused with orange = 2; blackish brown = 3.
2. Scapus: uniformly brown = 0; brown, darker basally = 1; whitish to pale brown, darker basally = 2.
3. Pedicellus: brown = 0; Whitish = 1.
4. Basiflagellomere: uniformly brown = 0; brown with basal third whitish = 1.
5. Distiflagellomere: uniformly brown = 0; brown, basally lighter = 1.
6. Labium: uniformly brown = 0; orange brown = 1; uniformly dark brown = 2.
7. Pronotum and scutellum: uniformly dark brown = 0; uniformly dark orange = 1; anterior pronotal lobe and scutellum blackish brown, posterior pronotal lobe pale brown = 2; uniformly blackish brown = 3.
8. Pro-, meso- and metapleuron: all brown or dark brown = 0; dark orange, dark brown, blackish brown = 1; dark orange, dark orange, orangish brown = 2; all blackish brown = 3; all dark orange = 4.
9. Corium: uniformly colored = 0; bicolored = 1.
10. Color pattern of membrane of hemelytron: entirely brown = 0; proximally and distally whitish or yellowish = 1.
11. Distal half of corium: entirely brown = 0; mostly whitish, apex with a very small brown patch = 1; mostly whitish, apex with a relatively large brown patch = 2.
12. Color patterns of coxae: coxae pale brown = 0; brown or dark brown = 1; fore coxa whitish to orangish, mid and hind coxae whitish to yellowish = 2; fore coxa orangish brown, mid and hind coxae dark brown = 3.

13. Color patterns of trochanters: pale brown = 0; brown = 1; whitish, sometimes suffused with brown very basally = 2.
14. Bands on femora: absent = 0; present = 1.
15. Patterns of banding on femora: fore femur almost uniform, without an obvious white apical ring, mid femur mostly brown, with a white basal band, hind femur white basally, brown apically, white area shorter than brown = 0; fore femur brown medially, with a white apical ring, mid femur mostly whitish, with a brown subapical ring, hind femur white basally, brown apically, white area subequal to brown = 1.
16. Dark parts of fore femur compared to other femora: brown or dark brown, as dark as brown parts of other femora = 0; dark orange or orangish brown, lighter than brown parts of other femora = 1.
17. Abdominal sternites: uniform = 0; brown or reddish laterally, whitish or pale medially = 1.
18. Connexivum: uniform = 0; banded = 1.

## STRUCTURE

### Head:

19. Anteocular region: more than three times as long as postocular region = 0; two to three times as long as postocular region = 1.
20. Eye in dorsal view: small, width of eye less than interocular space = 0; large, width of eye about as wide as interocular space = 1 (Fig. 2A); small, width of eye less than interocular space = 2 (Fig. 2C).
21. Eye in lateral view: not attaining dorsal outline of head = 0; attaining or surpassing dorsal outline of head = 1.
22. Ocellus: small = 0 (Fig. 2C); large = 1 (Fig. 2A)

23. Ocellus: situated on conspicuous tubercle = 0 (Fig. 2A); situated on slightly elevated surface = 1 (Fig. 2C).
24. V-shaped groove on frons and vertex: absent = 0; present = 1 (Fig. 3A).
25. Antennal insertion: removed from anterior margin of eye = 0; adjacent to anterior margin of eye = 1.
26. Maxillary plate: flat = 0; blunt = 1 (Fig. 3-B1); forming a projection = 2 (Figs 3-B2, B3).
27. Maxillary plate projection: small = 0 (Fig. 3-B2); large = 1 (Fig. 3-B3).
28. Third visible labial segment: much longer than first visible labial segment, longer than half of second visible labial segment = 0; shorter than or subequal to first visible labial segment, shorter than half of second segment = 1.
29. Neck: without lateral tubercle = 0; with lateral tubercle = 1 (Fig. 3C)

Thorax:

30. Antero-lateral angles of pronotum: rounded = 0 (Fig. 3-D1); tubercle-shaped = 1 (Figs 3-D2, D3); slightly pointed (Fig. 3-D4) = 2.
31. Tuberculation on body: pleura with small, inconspicuous tubercles = 0; head, pronotum, pleura, and thoracic sternites with large, conspicuous tubercles = 1.
32. Posterior pronotal lobe: slightly wider than anterior pronotal lobe, shorter than or subequal to half length of anterior lobe = 0; much wider than anterior pronotal lobe, longer than half length of anterior lobe = 1.
33. Scutellum: narrow and long, much longer than wide = 0; about as wide as long = 1; broad and short, much wider than long = 2.
34. Scutellum: swollen laterally = 0; ridged laterally = 1.

35. Scutellar process: long and narrow = 0; short and slightly tapering, not knob-shaped = 1; short and knob-shaped = 2.
36. Mesosternite: with a longitudinal ridge medially = 0; slightly rounded, without a ridge = 1.
37. Metasternite: V-shaped = 0; rounded = 1.
38. Ventral outline of fore femur: almost straight = 0; slightly convex = 1.
39. Conical tubercles on fore femur: absent = 0; present = 1.
40. Conical tubercles on mid femur: absent = 0; present = 1.
41. Fossula spongiosa on fore tibia: large and long, reaching half length of fore tibia = 0 (Figs 3–E3, E4); small, only occupying apex of fore tibia (less than one third of length of tibia) (Figs 3–E1, E2) = 1.
42. Fossula spongiosa on mid tibia: absent = 0; present = 1.
43. Subcostal margin of hemelytron (Fig. 1): slightly curved = 0; almost straight = 1.
44. Post-Cubitus: almost straight = 0 (Fig. 3–F1); curved = 1 (Fig. 3–F2).

Abdomen & male genitalia:

45. Abdomen (Fig. 1): elongate = 0; rounded and slightly inflated laterally = 1; sub-rectangular = 2.
46. Postero-medial margin of eighth abdominal segment: forming a long and narrow process = 0 (Fig. 3–G1); slightly convex = 1 (Fig. 3–G2); strongly convex, but not forming a distinct process = 2 (Fig. 3–G3).
47. Median process of pygophore: strongly bent = 0 (Figs 3–H2, H3); slightly bent = 1 (Fig. 3–H1).
48. Left and right parameres: strongly asymmetrical = 0; slightly asymmetrical = 1.

49. Dorsal rims of parameres (Fig. 4): flat, without an obvious hump = 0; obviously humped = 1.
50. Dorsal margin of lateral phalloshecal plate: smoothly curving, not ridged = 0; ridged = 1.
51. Apex of lateral phalloshecal plate (Fig. 4): convex = 0; slightly concave = 1.
52. Apex of dorsal phalloshecal sclerite: blunt or rounded = 0; with a tooth-like projection = 1.
53. Shape of the apical projection of dorsal phalloshecal sclerite: short and broad = 0; long and narrow = 1

VESTITURE:

54. Body setation: sparse = 0; dense = 1 (Figs 1, 2).
55. Distal part of basi-flagellomere: with both long erect, and short sub-adpressed setae = 0 (Fig. 3-I1); with only short sub-adpressed setae (Fig. 3-I2).
56. Short setae on membrane of hemelytron: present = 0; absent = 1.
57. Setae on dorsal rim of parameres (Fig. 4): confined to apical portion of paramere = 0; reaching paramere stems = 1,
58. Setae adjacent to paramere insertion located on a small protrusion on pygophore (Fig. 3): absent = 0; very sparse = 1; sparse = 2; dense and form a patch = 3

Supporting Information 1.3. Morphological character matrix of 7 species of the *Bekilya* group and 3 species of outgroups

	Character Number
	000000000111111111222222222233333333334444444444555555555
	1234567890123456789012345678901234567890123456889012345678
<i>Bekilya tuleara</i> <b>sp. nov.</b>	200111111131101111110111?102111020111011101010101010112
<i>Bekilya mahafalya</i> <b>sp. nov.</b>	10011112112311001111110111?102111020111011101010101011112
<i>Bekilya tenebra</i> <b>sp. nov.</b>	20011111112311001111110111?102111020111011101010101010113
<i>Hovacoris bicolornotum</i> <b>sp. nov.</b>	320002231022211011100011120102100001111011012101111110101
<i>Hovacoris bipunctatus</i>	1200011410222110111000111211021020111110110102011111010101
<i>Hovacoris melanoceps</i> <b>sp. nov.</b>	3100011110222110111000111201021020111110110112011111010101
<i>Hovacoris rufiventris</i> <b>sp. nov.</b>	3211111110222110111000111201021020111110110112011111010101
<i>Lestomerus</i> sp.	30000230000110?00012110111?1110001100111110100110000?00103
<i>Pseudolestomerus</i> sp.	30000230000110?00012110111?1110001100000010100110000?00103
<i>Sirthenea</i> sp.	00000000000000?0000000000?000000000000000000000000?00000

Supporting Information 1.4. GenBank accession numbers of *COI* sequences ('USI': Unique Specimen Identifier; 'R\_CW': ethanol specimen collection number; Weirauch laboratory)

<b>Species</b>	<b>USI (UCR_ENT)</b>	<b>R_CW</b>	<b>GenBank accession No.</b>
<i>Bekilya tuleara</i> <b>sp. nov.</b>	00003667	373	GU198505
<i>Bekilya tuleara</i> <b>sp. nov.</b>	00005204	382a	GU198506
<i>Bekilya tuleara</i> <b>sp. nov.</b>	00005302	372	GU198507
<i>Bekilya tuleara</i> <b>sp. nov.</b>	00005230	387a	GU198508
<i>Bekilya tuleara</i> <b>sp. nov.</b>	00005252	407a	GU198509
<i>Bekilya tuleara</i> <b>sp. nov.</b>	00015388	405a	GU198510
<i>Bekilya tuleara</i> <b>sp. nov.</b>	00005262	406a	GU198511
<i>Bekilya tuleara</i> <b>sp. nov.</b>	00005318	378	GU198512
<i>Bekilya tuleara</i> <b>sp. nov.</b>	00005319	386a	GU198513
<i>Bekilya tuleara</i> <b>sp. nov.</b>	00005320	416	GU198514
<i>Bekilya mahafalya</i> <b>sp. nov.</b>	00005305	409	GU198515
<i>Bekilya tenebra</i> <b>sp. nov.</b>	00005310	410	GU198516
<i>Ectomocoris</i> sp.	00003264	363	GU198517
<i>Fusius</i> sp.	00005172	404a	GU198518
<i>Hovacoris bicolornotum</i> <b>sp. nov.</b>	00005324	418	GU198519
<i>Hovacoris bipunctatus</i>	00003686	411	GU198520
<i>Hovacoris bipunctatus</i>	00005299	381a	GU198521
<i>Hovacoris bipunctatus</i>	00005295	413	GU198522
<i>Hovacoris melanoceps</i> <b>sp. nov.</b>	00005282	385a	GU198523
<i>Hovacoris melanoceps</i> <b>sp. nov.</b>	00005312	377	GU198524
<i>Hovacoris rufiventris</i> <b>sp. nov.</b>	00005235	417	GU198525
<i>Pseudolestomerus</i> sp.	00000175	380	GU198526
<i>Rasahus</i> sp.	00003265	400	GU198527
<i>Sirthenea</i> sp.	00006047	379	GU198528
Peiratinae immature (Province Mahajanga)	00005315	383a	GU198529



Supporting Information 1.5. Checklist of genera and species of the *Bekilya* group

*Bekilya*

Type species: *Bekilya mira* Villiers, 1949 (by original designation)

*Bekilya* Villiers, 1949

*Mutillocoris* Villiers, 1964, **syn.n.**

*Bekilya mahafalya* **sp. nov.**

*Bekilya mira* Villiers, 1949

*Bekilya tenebra* **sp. nov.**

*Bekilya tricolor* (Villiers, 1964), **comb.n.**

*Mutillocoris tricolor* Villiers, 1964

*Bekilya tuleara* **sp. nov.**

*Hovacoris*

Type species: *Hovacoris bipunctatus* Villiers, 1964 (by original designation)

*Hovacoris* Villiers, 1964

*Hovacoris bicolornotum* **sp. nov.**

*Hovacoris bipunctatus* Villiers 1964

*Hovacoris melanoceps* **sp. nov.**

*Hovacoris rufiventris* **sp. nov.**

*Hovacoris vadoni* (Villers, 1968), **comb.n.**

*Mutillocoris vadoni* Villiers, 1968

Supporting Information 1.6. Detailed specimen information of 'paratypes' and 'other material examined' for *Bekilya tuleara* **sp. nov.**, *Hovacoris bipunctatus* Villiers, and *Hovacoris melanoceps* **sp. nov.**

*Bekilya tuleara* **sp. nov.**

Paratypes: Males: MADGASCAR: Toliara (Tuléar): Ifaty, near Hotel Paradisia - in costal dunes, 23.17966°S 43.61683°E, 13 Oct–12 Nov 2001, (M. Irwin, FP, R. Harin'Hala), 4♂(UCR\_ENT 00005301–4 [caslot 028708/MA-02-16-01]) (CAS). Ranobe, 23.04638°S 43.61028°E, 20 m, 27 Oct–03 Nov 2003, (CAS - Frontier Wilderness Project, or CAS - Frontier Wilderness Project), 1♂( UCR\_ENT 00005300 [caslot 028710/MGF082]) (CAS). Tulear: Beza Mahafaly Reserve, Parcelle II near Bellevue, 23.68983°S 44.5755°E, 180 m, 28 Nov–04 Dec 2001, (M. Irwin, R. Harin'Hala), 1♂(UCR\_ENT 00005307 [caslot 031383/MA-02-14B-04]) (CAS). Beza Mahafaly Reserve, Parcelle I near research station, 23.6865°S 44.591°E, 165m, malaise trap in dry deciduous forest, 16 – 28 Aug 2002, (R. Harin'Hala), 1♂ (UCR\_ENT 00003703 [caslot 041596/MA-02-14A-33]) (CAS). Mikea Forest, NW of Manombo, 22.90366°S 43.4755°E, 30 m, 27 Nov–06 Dec 2001, (M. Irwin, R. Harin'Hala), 2♂( UCR\_ENT 00015389–90 [caslot 026931/MA-02-18A-04]) (AMNH); 16–26 Dec 2001, (M. Irwin, R. Harin'Hala), 3♂( UCR\_ENT 00023159–61 [caslot 028826/MA-02-18A-06]) (MNHN); 16–17 Jan 2002, (M. Irwin, R. Harin'Hala), 1♂( UCR\_ENT 00003667 [caslot 031404/MA-02-18A-10]) (UCR); 28 Jan–08 Feb 2002, (M. Irwin, R. Harin'Hala), 3♂( UCR\_ENT 00015382–4 [caslot 031399/MA-02-18A-12]) (AMNH); 19 Feb–01 Mar 2002, (M. Irwin, R. Harin'Hala), 2♂( UCR\_ENT 00015385–6 [caslot 031388/MA-02-18A-14]) (AMNH); 08–18 Mar 2002, (M. Irwin, R. Harin'Hala), 2♂( UCR\_ENT 00015387– 8 [caslot

031235/MA-02-18A-16]) (AMNH); 19 Aug–03 Sep 2002, (M. Irwin, R. Harin'Hala), 1♂( UCR\_ENT 00003668 [caslot 031423/MA-02-18A-31]) (UCR); 23 Sep–03 Oct 2002, (M. Irwin, R. Harin'Hala), 2♂( UCR\_ENT 00003669–70 [caslot 031265/MA-02-18A-34]) (UCR); 13–21 Oct 2002, (M. Irwin, R. Harin'Hala), 4♂( UCR\_ENT 00003671–4 [caslot 031420/MA-02-18A-36]) (UCR); 21–28 Oct 2002, (M. Irwin, R. Harin'Hala), 5♂( UCR\_ENT 00005225–9 [caslot 028827/MA-02-18A-37]) (CAS); 28–30 Oct 2002, (M. Irwin, R. Harin'Hala), 1♂( UCR\_ENT 00005230 [caslot 031409/MA-02-18A-38]) (CAS); 30 Oct–14 Nov 2002, (M. Irwin, R. Harin'Hala), 4♂( UCR\_ENT 00005231–3, UCR\_ENT 00005235 [caslot 031283/MA-02-18A-39]) (CAS); 28 Nov–11 Dec 2002, (M. Irwin, R. Harin'Hala), 3♂( UCR\_ENT 00005236–8 [caslot 028828/MA-02-18A-41]) (CAS); 11–21 Dec 2002, (M. Irwin, R. Harin'Hala), 1♂( UCR\_ENT 00005239 [caslot 028829/MA-02-18A-42]) (CAS); 18–27 Apr 2003, (M. Irwin, R. Harin'Hala), 2♂( UCR\_ENT 00005240–1 [caslot 028830/MA-02-18A-52]) (CAS); 09–19 May 2003, (M. Irwin, R. Harin'Hala), 4♂( UCR\_ENT 00005242–5 [caslot 031224/MA-02-18A-55]) (CAS); 30 May–10 Jun 2003, (M. Irwin, R. Harin'Hala), 2♂( UCR\_ENT 00005246–7 [caslot 031381/MA-02-18A-57]) (CAS); 03–10 Aug 2003, (M. Irwin, R. Harin'Hala), 1♂( UCR\_ENT 00005248 [caslot 031282/MA-02-18A-64]) (CAS); 10–21 Aug 2003, (M. Irwin, R. Harin'Hala), 2♂( UCR\_ENT 00005249–50 [caslot 031405/MA-02-18A-65]) (CAS); 12–23 Oct 2003, (M. Irwin, R. Harin'Hala), 1♂( UCR\_ENT 00005251 [caslot 031417/MA-02-18A-71]) (CAS); 23 Oct–02 Nov 2003, (M. Irwin, R. Harin'Hala), 10♂( UCR\_ENT 00005252–61 [caslot 031394/MA-02-18A-72]) (CAS); 02–12 Nov 2003, (M. Irwin, R. Harin'Hala), 2♂( UCR\_ENT 00005262– 3 [caslot 028833/MA-02-18A-73]) (CAS). Females: Lake Ranobe, 23.04901°S 43.61058°E, 30 m, 21–28 Jan 2003, (CAS - Frontier Wilderness Project), 1♀ ( UCR\_ENT 00005204 [caslot 026833/MGF059]) (CAS). Ranobe, 23.03944°S

43.61027°E, 30 m, 05–28 Jan 2003, (CAS - Frontier Wilderness Project), 1 ♀ (UCR\_ENT 00023162 [caslot 026831/MGF054]) (MNHN).

Other specimens examined: Immature stages: MADAGASCAR: Toliara (Tuléar): Lake Ranobe, 23.03916°S 43.61166°E, 30 m, 25–28 Apr 2003, (CAS - Frontier Wilderness Project), 3 specs (UCR\_ENT 00005320–1 [caslot 026834/MGF064]) (CAS); UCR\_ENT 00003675 [caslot 026834/MGF064]) (UCR). Ranobe, 23.03416°S 43.61194°E, 30 m, 05–09 Feb 2003, (CAS - Frontier Wilderness Project), 1 spec (UCR\_ENT 00005323 [caslot 026832/MGF056]) (CAS). Ranobe, 23.03944°S 43.61027°E, 30 m, 05–28 Jan 2003, (CAS - Frontier Wilderness Project), 4 specs (UCR\_ENT 00005316–9 [caslot 026831/MGF054]) (CAS).

*Hovacoris bipunctatus* Villiers

Other material examined: MADAGASCAR: Mahajanga: Ambovomamy Belambo 20 km NW of Port Berger, 15.45116°S 47.61333°E, 33 m, 04–18 Aug 2007, M. Irwin, R. Harin'Hala, 1 ♂ (UCR\_ENT 00005956 [caslot 038142/MG –33–31 ]) (CAS). Analamanitra Forest, 14 km NE of Misinjo, 16.13333°S 45.7°E, 20 m, 18–25 Sep 2007, M. Irwin, R. Harin'Hala, 1 ♂ (UCR\_ENT 00005958 [caslot 038169/MG–38–01]) (CAS); 09–16 Oct 2007, M. Irwin, R. Harin'Hala, 3 ♂ (UCR\_ENT 00005983–5 [caslot 038171/MG–38–04]) (CAS); 01–15 Jan 2008, M. Irwin, R. Harin'Hala, 1 ♂ (UCR\_ENT 00005941 [caslot 038190/MG–38–13]) (CAS). Beaboaly Bamboo Forest, 10 km SW of Soalala, 4 km from Baly village, 16.04533°S 45.804°E, 9 m, 04–10 Oct 2007, M. Irwin, R. Harin'Hala, 1 ♂ (UCR\_ENT 00005905 [caslot 039043/MG–39A–03]) (CAS). Parc National de Namoroka, 16.8 km 329° WNW Vilanodro, 16.376667°S 45.326667°E, 100m, 08–12 2002, (Fisher, Grisowold et al.), 1 ♂ (UCR\_ENT 00003702 [caslot041669/BLF6506])

(CAS). Besalampy District, Analangidro dry forest, 16.6915°S 44.5235°E, 61 m, 23–28 Oct 2007, M. Irwin, R. Harin'Hala, 1♂(UCR\_ENT 00005957 [caslot 038215/MG–41–05]) (CAS); 07–14 Dec 2007, M. Irwin, R. Harin'Hala, 1♂(UCR\_ENT 00005989 [caslot 038214/MG–41–11]) (CAS). Besalampy District, Marofototra dry forest, 17 km W of Besalampy, 16.72166°S 44.42366°E, 52 m, 24–31 Dec 2007, M. Irwin, R. Harin'Hala, 8♂(UCR\_ENT 00005925–32 [caslot 039024/MG–42A–14]) (CAS); 31 Dec–07 Jan 2008, M. Irwin, R. Harin'Hala, 6♂(UCR\_ENT 00005919–24 [caslot 039018/MG–42A–15]) (CAS); 07–14 Jan 2008, M. Irwin, R. Harin'Hala, 5♂(UCR\_ENT 00005909–13 [caslot 039014/MG–42A–16]) (CAS); 14–21 Jan 2008, M. Irwin, R. Harin'Hala, 5♂(UCR\_ENT 00005897–901 [caslot 039013/MG–42A–17]) (CAS); 21–28 Jan 2008, M. Irwin, R. Harin'Hala, 2♂(UCR\_ENT 00003676–7 [caslot 039012/MG–42A–18]) (UCR); 23–30 Jun 2008, M. Irwin, R. Harin'Hala, 2♂(UCR\_ENT 00005987–88 [caslot 039094/MG–42A–26]) (CAS); 07–14 Jul 2008, M. Irwin, R. Harin'Hala, 2♂(UCR\_ENT 00005917–18 [caslot 039017/MG–42A–28]) (CAS); 28 Jul–04 Aug 2008, M. Irwin, R. Harin'Hala, 3♂(UCR\_ENT 00005906–08 [caslot 039015/MG–42A–31]) (CAS); 04–11 Aug 2008, M. Irwin, R. Harin'Hala, 1♂(UCR\_ENT 00005914 [caslot 039023/MG–42A–32]) (CAS); 11–18 Aug 2008, M. Irwin, R. Harin'Hala, 2♂(UCR\_ENT 00005915–16 [caslot 039025/MG–42A–33]) (CAS); 04–11 Feb 2009, M. Irwin, R. Harin'Hala, 1♂(UCR\_ENT 00005904 [caslot 039011/MG–42A–20]) (CAS). Maintirano District Asondrodava dry forest, 15 km N of Maintirano, 17.96533°S 44.0355°E, 61 m, 14–21 Jan 2008, M. Irwin, R. Harin'Hala, 2♂(UCR\_ENT 00005954–55 [caslot 038217/MG–43A–15]) (CAS). Namoroka 53 km from Soalala 3 km N Vilanandro Village, 16.47333°S 45.39133°E, 122 m, 16–23 Nov 2007, M. Irwin, R. Harin'Hala, 6♂(UCR\_ENT 00005977–82 [caslot 038194/MG–40A–08]) (CAS). Namoroka village Befatika Andranovory, 7 km NW Vilanandro village,

16.47333°S 45.39133°E, 122 m, 21–28 Sep 2007, M. Irwin, R. Harin'Hala,  
 2♂(UCR\_ENT 00015394 –5 [caslot 038205/MG–40B–01]) (AMNH); 28 Sep–05 Oct  
 2007, M. Irwin, R. Harin'Hala, 3♂(UCR\_ENT 00015396–8 [caslot 038204/MG-40B-02])  
 (AMNH); 05–12 Oct 2007, M. Irwin, R. Harin'Hala, 3♂(UCR\_ENT 00005951–53 [caslot  
 038201/MG–40B–03]) (CAS); 12–19 Oct 2007, M. Irwin, R. Harin'Hala, 7♂(UCR\_ENT  
 00003678–84 [caslot 038206/MG–40B–04]) (UCR); 19–26 Oct 2007, M. Irwin, R.  
 Harin'Hala, 9♂(UCR\_ENT 00005942–50 [caslot 038200/MG–40B–05]) (CAS); 26 Oct–  
 02 Nov 2007, M. Irwin, R. Harin'Hala, 8♂(UCR\_ENT 00023163–70 [caslot 038207/MG–  
 40B–06]) (MNHN). Parc National Tsingy de Bemaraha, 3.4 km 93(degree) E Bekopaka,  
 Tombeau Vazimba, 19.14194°S 44.82805°E, 50 m, 06–10 Nov 2001, Fisher, Griswold et  
 al., 1♂(UCR\_ENT 00005299 [caslot 028754/BLF4233]) (CAS). Toliara (Tuléar):  
 Beroboka village 45 km NE Morondava, 19.9775°S 44.82483°E, 128 m, 26–30 Oct  
 2007, M. Irwin, R. Harin'Hala, 1♂(UCR\_ENT 00005986 [caslot 039109/MG–45A–06])  
 (CAS); 26–30 Oct 2007, M. Irwin, R. Harin'Hala, 1♂(UCR\_ENT 00005940 [caslot  
 039101/MG–45B–06]) (CAS). Cap Ste Marie Special Reserve, 74km S of Tsihombe,  
 25.58766°S 45.163°E, 37 m, 27 Oct–04 Nov 2002, M. Irwin, FP, R. Harin'Hala,  
 2♂(UCR\_ENT 00005290–91 [caslot 028683/MA-02-23-02]) (CAS); 07–17 Mar 2003, M.  
 Irwin, FP, R. Harin'Hala, 2♂(UCR\_ENT 00003686 [caslot 028686/MA-02-23-19]) (UCR),  
 (UCR\_ENT 00005288 [caslot 028686/MA-02-23-19]) (CAS); 11–20 Apr 2003, M. Irwin,  
 FP, R. Harin'Hala, 2♂(UCR\_ENT 00015399–400 [caslot 028687/MA-02-23-23])  
 (AMNH); 26 May–02 Jun 2003, M. Irwin, FP, R. Harin'Hala, 2♂( UCR\_ENT 00015401–2  
 [caslot 028690/MA-02-23-28]) (AMNH); 29 Jun–05 Jul 2003, M. Irwin, FP, R. Harin'Hala,  
 2♂( UCR\_ENT 00015403–4 [caslot 028692/MA-02-23-33]) (AMNH); 26 Oct–05 Nov

2003, M. Irwin, FP, R. Harin'Hala, 5♂( UCR\_ENT 00005292–96 [caslot 028695/MA-02-23-46]) (CAS).

*Hovacoris melanoceps* **sp. nov.**

Paratypes: Males: MADAGASCAR: Antsiranana: Montagne des Français, 7.2 km 142 (degree) SE Antsiranana (=Diego Suarez), 12.32277°S 49.33805°E, 180 m, 22–28 Feb 2001, Fisher, Griswold et al., 1♂(UCR\_ENT 00005276 [caslot 026849/BLF3130]) (CAS). Parc National Montagne d'Ambre, 12.52027°S 49.17916°E, 1125 m, 29 Jan –11 Feb 2001, M. Irwin, R. Harin'Hala, 1♂(UCR\_ENT 00005280 [caslot 028766/MA-01-01D-03]) (CAS); 21–26 Apr 2001, M. Irwin, R. Harin'Hala, 1♂( UCR\_ENT 00005283 [caslot 028649/MA-01-01D-08]) (CAS); 12–14 May 2001, M. Irwin, R. Harin'Hala, 1♂(UCR\_ENT 00005281 [caslot 026946/MA-01-01D-10]) (UCR). Rés. Analamerana, 28.4 km 99° Anivorano–Nord, 12.74666°S 49.49472°E, 60 m, 05 Dec 2004, B.L. Fisher, 1♂(UCR\_ENT 00005282 [BLF11399]) (CAS). Sakalava Beach, dwarf littoral forest, 12.26277°S 49.3975°E, 10 m, 07–21 Apr 2001, M. Irwin, R. Harin'Hala, 2♂( UCR\_ENT 00015405–6 [caslot 028652/MA-01-04B-06]) (AMNH); 27 Apr–13 May 2001, M. Irwin, R. Harin'Hala, 3♂(UCR\_ENT 00005264–6 [caslot 028653/MA-01-04B-08]) (CAS); 16–31 May 2001, M. Irwin, R. Harin'Hala, 4♂( UCR\_ENT 00005267–70 [caslot 026946/MA-01-04B-10]) (CAS); 31 May–07 Jun 2001, M. Irwin, R. Harin'Hala, 1♂ (UCR\_ENT 00019650 [caslot 028771/MA-01-04B-11]) (UCR); 28 Jul–13 Aug 2001, M. Irwin, R. Harin'Hala, 2♂(UCR\_ENT 00023171–2 [caslot 028773/MA-01-04B-16]) (MNHN); 13–20 Aug 2001, M. Irwin, R. Harin'Hala, 1♂(UCR\_ENT 00023173 [caslot 028774/MA-01-04B-17]) (MNHN). Dry forest, 7km N of Joffreville, 12.33333°S 49.25°E, 360 m, 15 Feb–06 Mar 2001, M. Irwin, R. Harin'Hala, 1♂(UCR\_ENT 00005277 [caslot 026892/MA-01-

07–07]) (CAS); 13–16 May 2001, M. Irwin, R. Harin'Hala, 1♂ (UCR\_ENT 00005278 [caslot 029378/MA–01–07–12]) (CAS).

Other specimens examined: Imatures: MADAGASCAR: Antsiranana: Rés.

Analamerana, 28.4 km 99° Anivorano–Nord, 12.74666°S 49.49472°E, 60 m, 05 Dec 2004, B.L. Fisher, 3 specs (UCR\_ENT 00005311–3 [caslot 029437/BLF11400]) (CAS).



## **CHAPTER 2: Sticky predators: a comparative study of sticky glands in harpactorine assassin bugs (Insecta: Hemiptera: Reduviidae)**

### **Abstract**

For more than 50 years, specialized dermal glands that secrete sticky substances and specialized setae have been known from the legs of New World assassin bugs in the genus *Zelus* Fabricius (Reduviidae, Harpactorinae). The gland secretions and specialized 'sundew setae' are involved in enhancing predation success. We here refer to this predation strategy as 'sticky trap predation' and the specialized dermal glands as 'sticky glands'. To determine how widespread sticky trap predation is among Reduviidae, we investigated taxonomic distribution of sticky glands and sundew setae using compound light microscopical and SEM techniques and sampling 67 species of Reduviidae that represent 50 genera of Harpactorini. We found sticky glands in 12 genera of Harpactorini and thus show that sticky trap predation is much more widespread than previously suspected. The sticky glands vary in shape, size and density, but are always located in the dorsolateral position on the fore tibia. Sundew setae are present in all taxa with sticky glands with the exception of *Heza* that instead possess unique lamellate setae. The sticky trap predation taxa are restricted to the New World, suggesting a New World origin of this unique predation strategy.

### **Introduction**

A diverse array of predation methods and associated morphological structures exists in Reduviidae or assassin bugs. Thread-legged bugs (Emesinae) possess raptorial fore legs that resemble those of preying mantises (Wygodzinsky 1966), species of ambush

bugs (Phymatinae) have highly modified sub-chelate or chelate fore legs (Weirauch *et al.* 2010), and feather-legged bugs (Holoptilinae) lure their ant prey with specialized abdominal glands (Weirauch and Cassis, 2006; Weirauch *et al.* 2010). Additional recent studies have focused on *fossula spongiosa*, an adhesive structure on the tibiae that aids in prey capture and is widespread in Reduviidae and other Cimicomorpha (Weirauch 2007; Schuh *et al.* 2009).

Harpactorinae, the largest subfamily in Reduviidae, exhibit an intriguing predation strategy: some species are known to use sticky substances to enhance predation success (Law and Sediqi 2010), a phenomenon referred to as 'sticky trap predation' (Forero *et al.* 2011; Weirauch 2006). This predation strategy can be categorized into two types, according to the source of the sticky substance. Species in the tribes Ectinoderini, Apiomerini and Diaspidiini, the resin bugs (Davis 1969), are known to collect plant resins; this exogenous substance is smeared onto legs and body and used to facilitate prey capture (Forero *et al.* 2011; Miller 1942, 1971; Roepke 1932; Usinger 1958). In contrast, species of the large (>60 spp.) genus *Zelus* Fabricius in the tribe Harpactorini utilize an endogenous source of sticky substances for prey capture. Barth (1952) and Weirauch (2006) documented specialized epidermal glands on the fore tibiae of *Zelus leucogrammus* (Perty) and *Zelus luridus* (Stål), respectively. They concluded that these glands are responsible for secreting a viscous cover on the fore tibiae of these assassin bugs. This sticky cover was also noted in adults or nymphs of several other *Zelus* species including *Zelus longipes* (Linnaeus) (Wolf and Reid 2001) and *Zelus tetracanthus* Stål (Cobben and Wygodzinsky 1975). In addition, Edwards (1966) described the predation behavior of adult *Z. luridus* [as *Z. exsanguis*; see Hart (1986) for taxonomy of *Zelus* in North America]. This species, when provided with fast moving prey

such as *Drosophila*, remained motionless with the fore tibiae raised and waited until the prey adhered to the sticky legs; we also observed this behavior in *Zelus renardii* Kolenati and *Z. tetracanthus*, the two species we keep in culture in our lab (Fig. 2.1).

In his histological study on *Z. leucogrammus*, Barth (1952) provided a description of the morphology of the specialized dermal glands that we here refer to as “sticky glands”. According to Barth, the glandular unit (*sensu* Noirot and Quennedey 1974) consists of one gland cell and potentially up to three canal cells and their chitinous components. The sclerotized components of the glandular unit comprise a thin ductule, surrounded by canal cells, and a heavily sclerotized funnel that may be a combined product of the canal and gland cells (Fig. 2.2A). Following Noirot and Quennedey (1974, 1991) these glandular units can be classified as class 3 glands (i.e., comprising separate canal and gland cells). We here refer to the funnel-shaped sclerotized structure of the glandular unit as “sacculi” (Fig. 2.2A,B). Using macerated specimens (i.e. only sclerotized parts retained), Weirauch (2006) observed funnel-shaped sacculi also in *Z. luridus* and considered them as homologous to those found in *Z. leucogrammus*.

Species of *Zelus* with sticky glands possess specialized setae that resemble the trichomes on the leaves of sundew plants (e.g., *Drosera*). They are referred to as sundew hairs (Edwards 1966; Wolf and Reid 2001) or sundew setae (Weirauch 2006) and are found in high densities on the fore tibiae in *Zelus* (Barth 1952; Edwards 1966; Weirauch 2006; Wolf and Reid 2001). They are suspected to function in retaining the secreted viscous substances (Barth 1952; Wolf and Reid 2001; Weirauch 2006) and restraining prey (Edwards 1966). Sundew setae are currently not documented for Reduviidae outside the genus *Zelus*.

Besides sticky glands, we also observed regular class 3 dermal glands, which have ovoid or balloon-like saccules (e.g., Fig. 2.2F). This type of glands seems to be widespread in Harpactorinae and Reduviidae (unpublished data) and thus is not the focus of the current study. Wolf and Reid (2001) and Weirauch (2006) documented a peculiar cuticular structure in *Zelus* spp., the so-called ring-like invagination. The former study interpreted these structures as openings of sticky glands, but Weirauch (2006) determined pores with a small diameter that are internally connected to the saccules of the sticky glands as the actual external openings of the sticky glands. The function of the ring-like invaginations remains unknown and we here do not attempt to document their distribution across the studied taxa.

Sundew setae and sticky glands have so far only been documented for several species of *Zelus*. Homologous structures on the fore tibiae of other genera of Harpactorinae or other Reduviidae are unknown. Based on current knowledge, sticky trap predation based on sticky glands and sundew setae would appear to be restricted to the genus *Zelus* among Harpactorinae. We here address the following questions: Are sticky glands and sundew setae restricted to the fore legs in *Z. renardii* or do they also occur on other body parts? If the latter is true, what are the densities of sticky glands on relevant structures and can we find evidence that they are primarily used for raptorial purposes? What is the taxonomic distribution of sticky glands and is sticky trap predation based on sticky glands a widespread phenomenon within Harpactorinae? And do sticky glands and sundew setae co-occur?

## **Materials and Methods**

### *Taxon sampling and specimens*

Sixty seven species of Reduviidae were examined, representing 50 genera of Harpactorini and nine species and eight genera of Apiomerini, Ectinoderini, Rhaphidosomini, and Tegeini (Harpactorinae) and other reduviid subfamilies (Bactrodinae, Peiratinae, Stenopodainae, and Triatominae). Genera and species of Harpactorini were chosen to represent broad taxonomic and biogeographic coverage, but selection was also determined by availability of longer series of material. Each specimen was assigned a unique specimen identifier (USI) barcode label and databased using the Planetary Biodiversity Inventory plant bug project online locality database [<https://research.amnh.org/locality>]. A male specimen was examined for each species and multiple specimens were examined when SEM and light microscopical information could not be obtained from a single specimen. Voucher specimens were deposited in the following museums: the Hungarian Natural History Museum (HNHM), the Bohart Museum of Entomology at the University of California, Davis (UCD), the Entomology Research Museum at the University of California, Riverside (UCR), and the United States National Museum of Natural History (USNM). Taxon and specimen information including classification, USI and depository are shown in Tables 2.1 and 2.2.

#### *Study of Zelus renardii*

To study the structural distribution and densities of sticky glands and sundew setae in adult *Z. renardii*, tibiae and femora, antennal segments, thoracic pleura, terga and sterna, and abdominal terga and sterna were examined with compound and scanning electron microscopical techniques as described below. The results revealed that all tibiae and femora possess sticky glands and sundew setae, but they are more abundant on the fore leg. Therefore, we focused on examining the fore tibiae in other taxa, an approach also taken by Wolf and Reid (2001).

### *Compound light microscopy*

Specimens used for this study were either preserved in 100% ethanol or pinned mounted. The right fore tibia was excised and macerated in hot 10% potassium hydroxide (KOH) for five to ten minutes and rinsed in 70% ethanol. Some dark colored or heavily sclerotized tibiae were macerated for 12-72 hours at room temperature. The tibia was transferred onto a glass slide in glycerol with the anterior side facing the observer (Fig. 2.2D) and examined using a Nikon Eclipse 80i (UCR) or a Leica DMRB (USNM) compound microscope. Photographs were taken with a JVC KY-F55B camera mounted on the Nikon Eclipse 80i scope (UCR) or a JVC KY-75 3CCD camera on the Leica DMRB scope (USNM). Images were captured and processed with the software Cartograph 5.6.0 (Microvision Instruments, France). When sticky glands were found, the tibia was remounted to allow for dorsal observation (Fig. 2.2C).

### *Scanning electron microscopy*

Usually, the same tibia prepared for compound microscopy was subsequently used for scanning electron microscopic examinations. Sometimes the left tibia of the same specimen or the right tibia of another specimen was used. Following Choe and Rust (2007), we immersed the tibiae in limonene oil overnight to remove viscous substances on the cuticle, which might otherwise obscure ultra-microscopic structures. Cleaned tibiae were dehydrated in an ethanol series at concentrations of 25%, 50%, 75% and 100%, followed by air drying. Each tibia was cut in half and each half was placed with the dorsal or ventral surface facing up on an aluminum SEM stub with adhesive carbon stickers (Ted Pella, Inc). A Cressington 108 auto sputter coater (UCR) or Eiko IB-3 ion coater (USNM) was used for a 60-second coating with platinum. The samples were observed with a Phillips XL30-FEG (UCR) or an Amray 1810 (USNM) scanning electron

microscope. Some samples were not coated and were observed with a Hitachi TM-1000 Tabletop Electron Microscope (UCR).

#### *Measurements and characterizations of sticky glands*

The number of saccules observed per 0.1 mm length of the tibia or femur in lateral view at a fixed observation plane was used as an approximation to glandular unit density (Fig. 2.2E). The density was classified into four categories, high (>30), medium (16–30), low (6–15) and very low (5 or less). The length and width of a saccule were measured as shown in Fig. 2.2B. Five saccules were measured for each specimen and we here report their average (Table 2.1). Shapes of saccules of sticky glands were defined by the ratio of length to width of a saccule. We classified shapes of saccules into three categories (the smaller the ratio, the more roundish the saccule): roundish (ratio 1.0–1.2), regular (1.4–1.6), and elongate (1.8–2.1).

#### *Image editing and plate preparation*

Images were edited and enhanced with Photoshop CS3. Plates were assembled with Coreldraw X3.

#### *Terminology and abbreviations*

Terminology and abbreviations generally follow Weirauch (2006) and Wolf and Reid (2001). The specialized setae on the fore tibia of *Heza* spp. are here called lamellate setae. Abbreviations: duc, ductule of glandular unit; las, lamellate setae; pogl, pore of glandular unit; sdg, saccule of regular dermal gland; ssg, saccule of sticky gland; ss simple setae; sus, sundew setae.

## Results

### *Sticky glands and sundew setae in Zelus renardii*

Gland distribution: Sticky glands are present on first antennal segment, tibiae, and femora in *Z. renardii* (Fig. 2.3). They are absent from other antennal and leg segments, thoracic pleura, terga and sterna, and abdominal terga and sterna. On the first antennal segment, the sticky glands are restricted to the dorsal surface (Fig. 2.4A). Their distribution on tibiae is dorsolateral with sticky glands being absent from the strict dorsal and lateral, and ventral surfaces (Figs 2.4B,C,E,F). On the fore femur, sticky glands occur on the ventral and lateral surfaces (Figs 2.4G,H), but they are found on both the dorsal and ventral surfaces on the mid and hind femora (Figs 2.4K,L). Gland density: The densities of the sticky glands are very low on the scapus (5–10 saccules per 0.1mm, Fig. 2.4A, the unit ‘saccules per 0.1mm’ omitted hereafter). Among the femora, the fore femur (>50, Fig. 2.4G) shows much higher density of the glands than mid and hind femora (15–20, Fig. 2.4K,L). Sticky glands on the fore and mid tibiae have about the same density (20–30, Fig. 2.2B,E), and they have a lower density on the hind tibia (10–15, Fig. 2.4F). Among all body parts with sticky glands, the fore femur shows the highest density of glands. Cuticular structures: Sundew setae are present on all tibiae and femora, but are much more numerous on the fore femur and tibia. They are absent from all antennal segments, thoracic terga and sterna, and abdomen. Distributions of pores of the glands correspond to the distributions of the glands. On the fore tibia, pores were only observed on the dorsolateral surfaces of the cuticle (Fig. 2.4D). On the fore femur, pores are abundant on the lateral and ventral surfaces and are absent or very scarce on the dorsal surface (Fig. 2.4I,J).



*Sticky glands: taxonomic distribution and morphological characteristics*

Sticky glands were found on the fore tibia in 12 genera of Harpactorini (Table 2.1). They are absent in the remaining 38 genera of Harpactorini examined as well as other Reduviidae including Apiomerini, Ectinoderini, Rhaphidosomini, Tegeini, Bactrodinae, Peiratinae, Stenopodainae, and Triatominae (Table 2.2). Interestingly, all 12 taxa with sticky glands are from the New World, with the majority being Neotropical. In addition to genera that we here refer to as the *Zelus* genus group (*Zelus*, *Atopozelus*, Hartzelus [manuscript name]), sticky glands were found in species of *Atrachelus*, *Castolus*, *Corcia*, *Graptocleptes*, *Heza*, *Hiranetis*, *Mucrolicter*, *Myocoris*, and *Repipta*. Notably, sticky glands are absent in *Heza aurantia*, but present in the four other species of *Heza* studied.

All taxa show a dorsolateral distribution of the sticky glands on the fore tibia (Figs 2.5A–I). The tapering ends of the sacculs are predominantly oriented towards cuticle (Figs 2.5C,F), because they are continuous with the ductule that opens to the outside. Density of sticky glands varies greatly among taxa. High density of sticky glands is found in *Atrachelus*, *Hiranetis*, *Mucrolicter* and *Myocoris*. We here classify *Atopozelus*, *Castolus*, *Heza* and *Zelus* as showing medium density. The density of sticky glands is low in *Corcia*, *Graptocleptes* and *Repipta*. Hartzelus [manuscript name] has very low density. The sacculs are variable in size and shape between taxa. The width of the sacculs, as an indicator of their size, ranges from 5.0 $\mu$ m to 11.4 $\mu$ m (Table 2.1). Shapes of the sacculs vary from roundish to elongate (Figs 2.5K,L,M) and are summarized in Table 2.1.

### *Sundew setae and pores on cuticle*

With the exception of *Heza* spp., sundew setae were found in all genera that possess sticky glands. Sundew setae are absent from all other reduviids examined. The lateral projections of the sundew setae are always arranged in two or three columns (Figs 2.6A,B). In all examined species of *Heza*, setae on the ventral surfaces of tibiae are ornamented (Figs 2.6C,D), but we do not consider them to be sundew setae. They show two laterally flattened lamellae that appear to undulate along the body of the seta. We here refer to them as 'lamellate setae'. Pores of sticky glands on the cuticle were observed in all taxa with sticky glands. They have a dorsolateral distribution (e.g., Figs 2.4E,F) that corresponds to the distribution of sticky glands seen with light microscope. Density of the pores corresponds to density of the glands.

## **Discussion**

### *Sticky glands and sundew setae in Zelus renardii and their functional significance in predation*

Sticky glands and sundew setae in *Z. renardii* are most abundant on the fore leg, especially on the fore femur (Fig. 2.4). This supports the hypothesis that the sticky secretions and sundew setae function in immobilizing prey as the bugs predominantly use fore legs to capture and manipulate prey insects. It is possible that other appendages with sticky glands and sundew setae are also involved in trapping prey. We have frequently observed in the lab that *Drosophila* flies adhere to any leg of *Z. renardii* or *Z. tetracanthus* and subsequently get transferred to and immobilized with the fore legs by the bug. The ventral concentration of sticky glands on the fore femur of *Z. renardii* can be explained by the predatory behavior of the bug. The prey is usually held between

the ventral surfaces of the fore tibia and femur (Fig. 2.1B) before consumption. An abundance of sticky glands on the ventral surface of the fore femur could therefore enhance predation success. The dorsolateral distribution of sticky glands on the fore tibia (Fig. 2.4B,C) may also be explained by the predatory behavior: given the raised position of the tibiae in an ambushing *Zelus* individual (Fig. 2.1A), the prey items are likely to first make contact with the dorsolateral surfaces of the raised tibiae. More detailed behavioral observations and experiments will allow further insights into this fascination predation strategy.

*Sticky glands are widespread and restricted to New World Harpactorini*

Sticky glands in the fore tibia are here documented for 12 genera of Harpactorinae, including *Zelus*, the only taxon for which such glands were previously known. Sticky glands are thus much more widespread among Reduviidae than formerly known. These glands are presumably involved in sticky trap predation and we therefore present evidence that this predation strategy is more common among Harpactorinae than so far documented. Within Harpactorinae, these sticky glands characterized by funnel-shaped saccules appear to be restricted to the tribe Harpactorini and we here consider them to be primarily homologous. Given the lack of a comprehensive phylogenetic framework of Harpactorini (but see Weirauch 2008 and Weirauch and Munro, 2009), we have no basis to assess relatedness of these taxa and cannot determine if sticky trap predation evolved once or multiple times within Harpactorini. However, the genera *Atopozelus* and *Hartzelus* [manuscript name], are assumed to be closely related to *Zelus* (Hart 1972) and the presence of sticky glands in these taxa might therefore have been expected. Intriguingly, we found sticky glands to only occur in New World taxa, despite our broad taxonomic sampling in all biogeographic regions (Tables 2.1,2.2). We here speculate

that sticky trap predation using endogenous sticky substances may have evolved in the New World. This hypothesis needs to be tested with a phylogeny of Harpactorini. This phylogeny will also allow determining if sticky glands evolved once or multiple times and thus provide insights into the evolution of a unique predation strategy.

In addition to the funnel-shaped sticky glands documented in this paper, other types of structures that potentially secrete sticky substances and may aid in prey capture have been described or hypothesized for Harpactorinae. We here comment on the validity of the previous reports based on our observations. Readio (1927) mentioned secretory setae in *Pselliopus cinctus* (Fabricius) (Harpactorini). According to our compound microscopical observations, *Pselliopus* spp. do not possess sticky glands (Table 2.2) and the SEM observations did not reveal setae with pores, thus making a secretory function of these setae unlikely. Cobben and Wygodzinsky (1975) speculated on the existence of 'integumental glands' responsible for viscous substances on the body and appendages (except the antennae) in *Cosmoclopius curacavensis* Cobben and Wygodzinsky (Harpactorini). We here did not find sticky glands in the congeneric *Cosmoclopius nigroannulatus* (Stål). Species of *Cosmoclopius*, including *C. curacavensis*, have been reported to be associated with plants that secrete sticky substances such as *Cleome viscosa* L. or *Eupatorium* spp. (Cobben and Wygodzinsky 1975, Weirauch per. pers. obs). The viscous substances observed by Cobben and Wygodzinsky (1975) on *Cosmoclopius* specimens might thus have been derived from external sources. Finally, Wygodzinsky (1947) noted specialized hairs on the body and legs of *Heniartes jaakkoi* Wygodzinsky (Harpactorinae: Apiomerini). He described them as having an internal duct and being apically clavate. He also observed that nymphs from second instars and adults are covered with viscous substances. In our study, no

sticky glands were observed in this species. Our recent field observations on immatures and adults of an undetermined species of *Heniartes* (Weirauch, Berniker, Zhang, pers. obs.) indicate that this species completes its development on Melostomataceae that have viscous trichomes. Assuming that an association with sticky plants is a widespread trait within the genus *Heniartes*, the viscous substances in *H. jaakkoi* observed by Wygodzinsky may have also been of exogenous origin. Many other species of Harpactorinae appear to be associated with sticky plants and this phenomenon has been reviewed by Bérenger and Pluot-Sigwalt (1997).

*Specialized setae: sundew and lamellate setae*

With the exception of *Heza* spp. all taxa with sticky glands have sundew setae similar to those described by Wolf and Reid (2001) and Weirauch (2006) and we here consider these sundew setae to be primarily homologous (de Pinna 1991). All species of *Heza* examined lack sundew setae, but possess lamellate setae. The different morphology suggests that they are not homologous with the sundew setae and probably represent convergent specializations of un-ornamented setae. We speculate that both sundew and lamellate setae may be involved in retaining sticky substances on the legs and increasing sticky surface area. Under this scenario, the presence of lamellate setae in *H. aurantia* that does not possess sticky glands might be interpreted as a relict or the lamellate setae might have adopted a novel function. Phylogenies of Harpactorini and *Heza* are required to test evolutionary scenarios for the evolution of sticky glands, sundew and lamellate setae.

## References

- Barth, R. 1952. Die Fangdruese an den Beinen von *Zelus (Diplocodus) leucogrammus* (Perty). *Zoologische Jahrbuecher* 73, 323-336.
- Bérenger, J.-M. and Pluot-Sigwalt, D. 1997. Relations privilégiées de certains Heteroptera Reduviidae prédateurs avec les végétaux. Premier cas connu d'un Harpactorinae phytophage. *Comptes Rendus de l'Académie des Sciences - Series III - Sciences de la Vie* 320, 1007-1012.
- Choe, D.-H. and Rust, M. K. 2007. Use of plant resin by a bee assassin bug *Apiomerus flaviventris* (Hemiptera, Reduviidae). *Annals of the Entomological Society of America* 100, 320-326.
- Cobben, R. H. and Wygodzinsky, P. 1975. The Heteroptera of the Netherlands Antilles—IX Reduviidae (Assassin bugs). *Studies on the Fauna of Curaçao and other Caribbean Islands* 48, 1-62.
- Davis, N. 1969. Contribution to the morphology and phylogeny of the Reduvidae. IV. The Harpactorid complex. *Annals of the Entomological Society of America* 62, 74-94.
- Edwards, J. S. 1966. Observations on the life history and predatory behaviour of *Zelus exsanguis* (Stål) (Heteroptera, Reduviidae). *Proceedings of the Royal Entomological Society of London, Series A, General Entomology* 41, 21-24.
- Forero, D., Choe, D.-H. and Weirauch, C. 2011. Resin gathering in neotropical resin bugs (Insecta, Hemiptera, Reduviidae), Functional and comparative morphology. *Journal of Morphology* 272, 204-229.
- Hart, E. R. 1972. *A Systematic Revision of the Genus Zelus Fabricius (Hemiptera, Reduviidae)*. Ph.D dissertation. Texas A&M University.
- Hart, E. R. 1986. Genus *Zelus* Fabricius in the United States, Canada, and Northern Mexico (Hemiptera, Reduviidae). *Annals of the Entomological Society of America* 79, 535-548.
- Law, Y.-H. and Sediqi, A. 2010. Sticky substance on eggs improves predation success and substrate adhesion in newly hatched *Zelus renardii* (Hemiptera, Reduviidae) instars. *Annals of the Entomological Society of America* 103, 771-774.
- Miller, N. C. E. 1942. On the structure of the legs in Reduviidae (Rhynchota). *Proceedings of the Royal Entomological Society of London, Series A, General Entomology* 17, 49-58.
- Miller, N. C. E. 1971. *The biology of the Heteroptera*, 2nd edn. E. W. Classey Ltd., Hampton, Middlesex, England.

- Noirot, C. and Quennedey, A. 1974. Fine structures of insect epidermal glands. *Annual Review of Entomology* 19, 61-80.
- Noirot, C. and Quennedey, A. 1991. Glands, gland cells, glandular units, some comments on terminology and classification. *Annales de la Société Entomologique de France* 27, 123-128.
- de Pinna, M.C. 1991. Concepts and tests of homology in the cladistic paradigm. *Cladistics* 7, 367-394.
- Readio, P. A. 1927. Studies on the biology of the Reduviidae of America north of Mexico. *The University of Kansas Science Bulletin* 17, 5-291.
- Roepke, W. 1932. Über "Harzwanzen" von Sumatra und Java. *Miscell. Zoologica Sumatrana* 68, 1-5.
- Schuh, R. T., Weirauch, C. and Wheeler, W. C. 2009. Phylogenetic relationships within the Cimicomorpha (Hemiptera, Heteroptera), a total-evidence analysis. *Systematic Entomology* 34, 15-48.
- Usinger, R. L. 1958. Harzwanzen or "resin bugs" in Thailand. *Pan-Pacific Entomologist* 34, 52.
- Weirauch, C. 2006. Observations on the sticky trap predator *Zelus luridus* Stål (Heteroptera, Reduviidae, Harpactorinae), with the description of a novel gland associated with the female genitalia. *Denisia* 50, 1169-1180.
- Weirauch, C. 2007. Hairy attachment structures in Reduviidae (Cimicomorpha, Heteroptera), with observations on the fossula spongiosa in some other Cimicomorpha. *Zoologischer Anzeiger - A Journal of Comparative Zoology* 246, 155-175.
- Weirauch, C. 2008. Cladistic analysis of Reduviidae (Heteroptera, Cimicomorpha) based on morphological characters. *Systematic Entomology* 33, 229-274
- Weirauch, C. and Cassis, G. 2006. Attracting ants, the trichome in *Ptilocnemus lemur* (Heteroptera, Reduviidae, Holoptilinae) and novel glandular areas on the sternum. *Journal of the New York Entomological Society* 114, 28-37.
- Weirauch, C. and Munro, J. 2009. A molecular phylogeny of Reduviidae based on ribosomal genes. *Molecular Phylogenetics and Evolution* 53, 287-299.
- Weirauch, C., Bulbert, M. and Cassis, G. 2010. Comparative trichome morphology in feather-legged assassin bugs (Insecta, Heteroptera, Reduviidae, Holoptilinae). *Zoologischer Anzeiger - A Journal of Comparative Zoology* 248, 237-253.
- Weirauch, C., Forero, D. and Jacobs, D. H. 2010. On the evolution of raptorial legs - an insect example (Hemiptera, Reduviidae, Phymatinae). *Cladistics* 26, 1-12.

- Wolf, K. W. and Reid, W. 2001. Surface morphology of legs in the assassin bug *Zelus longipes* (Hemiptera, Reduviidae), a scanning electron microscopy study with an emphasis on hairs and pores. *Annals of the Entomological Society of America* 94, 457-461.
- Wygodzinsky, P. 1947. Contribuição ao conhecimento do gênero *Heniartes* Spinola, 1837 (Apiomerinae, Reduviidae, Hemiptera). *Arquivos do Museu Nacional* 41, 11-64.
- Wygodzinsky, P. 1966. A monograph of the Emesinae (Reduviidae, Hemiptera). *Bulletin of the American Museum of Natural History* 133, 1-614.



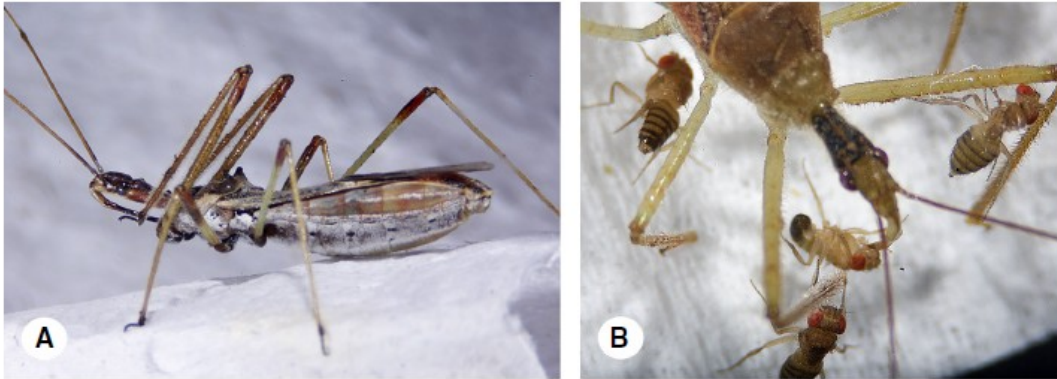

Figure 2.1. Predation behaviors of *Zelus* spp. A. *Zelus tetracanthus* assuming a striking posture with fore legs raised. B. *Zelus renardii* with *Drosophila* flies adhered on legs.

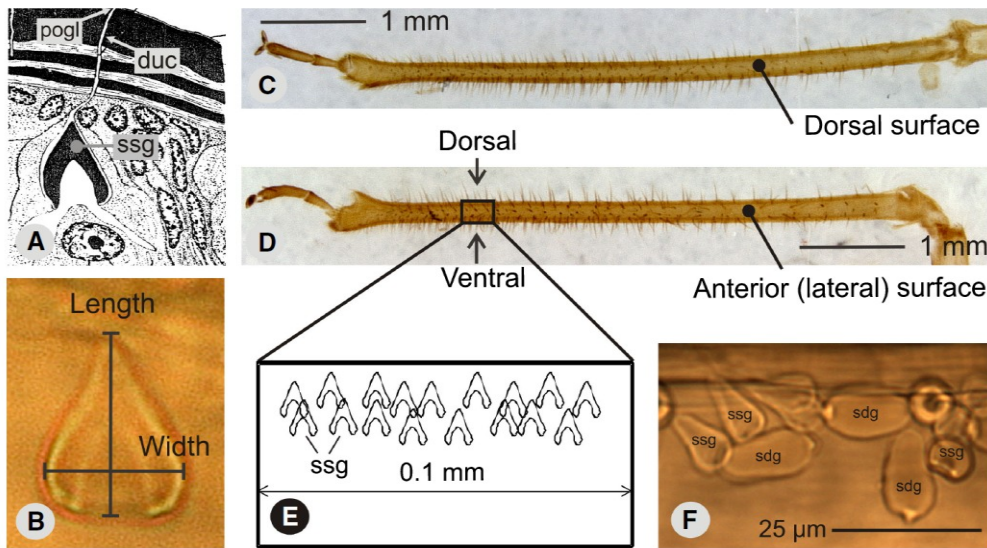

Figure 2.2. Illustrations or images of glandular units, saccules of sticky glands, and fore tibia in *Zelus* spp. A. Histological observation of a glandular unit of sticky gland in *Zelus leucogrammus*, reproduced from Barth (1952). B. Measurement of length and width of the saccule of a sticky gland in *Atrachelus* sp. C–D. Right fore tibia of *Zelus renardii* in dorsal and lateral views. E. Close-up lateral view of sticky glands on the fore tibia. Density of glands is measured as the number of saccules observed per 0.1 mm length. F. Saccules of sticky glands and regular class 3 dermal glands in *Z. renardii*. duc, ductule of glandular unit; pogl, pore of glandular unit; sdg, saccule of regular dermal gland; ssg, saccule of sticky gland.

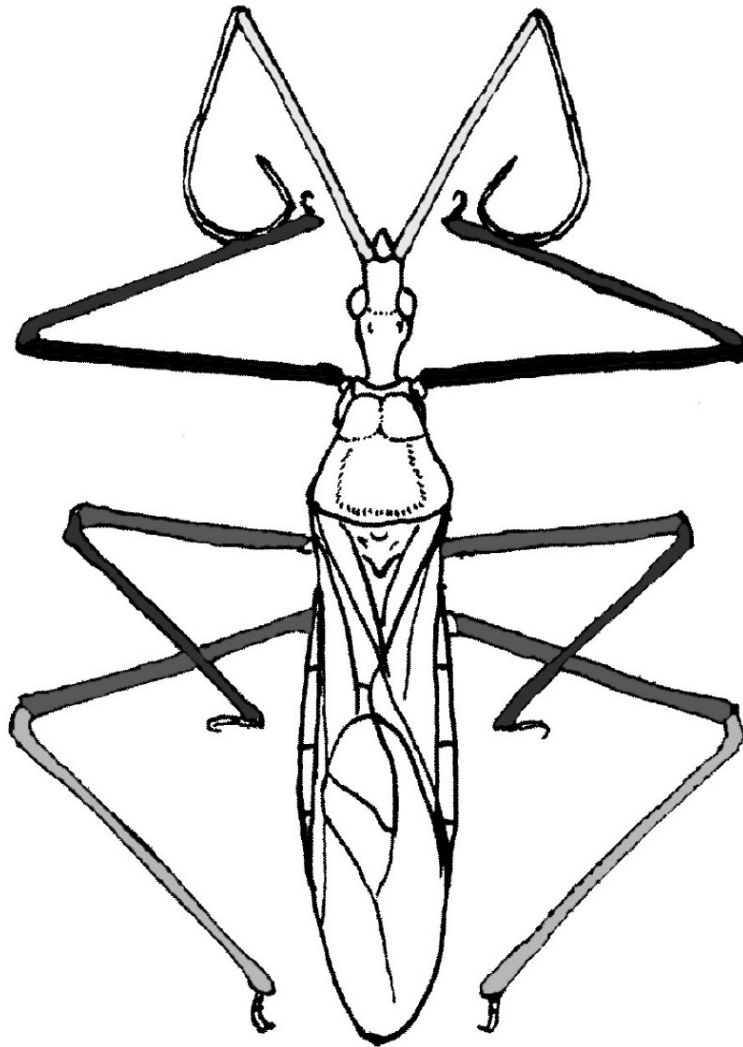

Figure 2.3. Distribution of sticky glands in *Zelus renardii*. Shaded body parts (first antennal segment, tibiae and femora) contain sticky glands. Density of sticky glands is indicated by the intensity of shade. Fore femur displays the highest density, followed by fore and mid tibiae, and mid and hind femora, hind tibia, and scapus shows the lowest density.

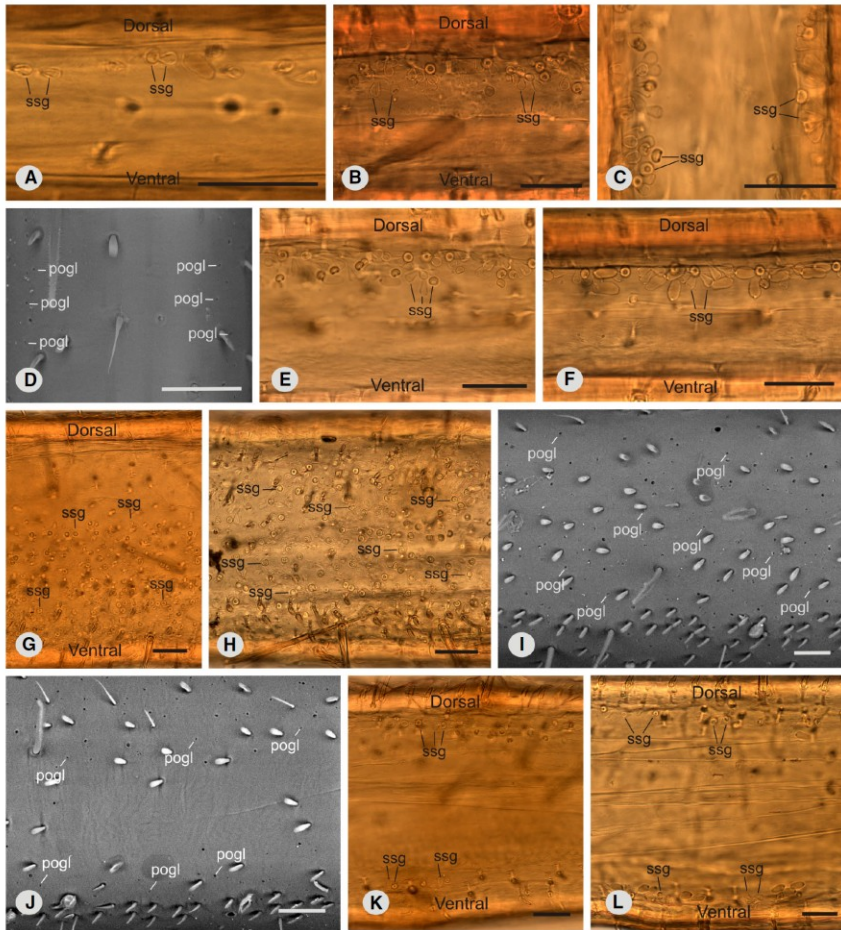

Figure 2.4. Compound microscopic images of glands (A–C, E–H, K, L) and scanning electron micrographs of pores of glandular units (D, I, J) in *Zelus renardii* showing distributions and densities on different body parts. A. First antennal segment. B–D. Fore tibia. E. Mid tibia. F. Hind tibia. G–J. Fore femur. K. Mid femur. L. Hind femur. A, B, E, F, G, K, L, lateral view. C, D, J, dorsal view. H, I, ventral view. pogl, pore of glandular unit; ssg, sacculi of sticky gland. Scale bars are 50  $\mu$ m.

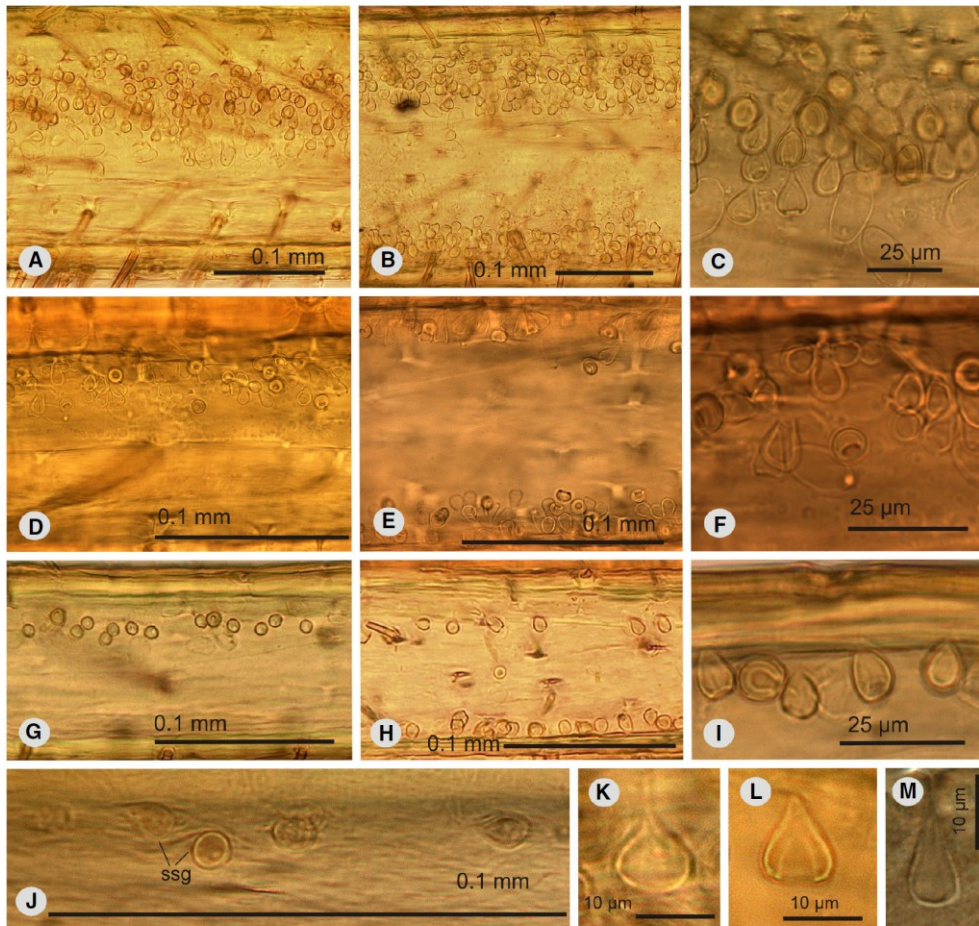

Figure 2.5. Compound microscopic images of fore tibial sticky glands in selected species of Harpactorini showing various densities and shapes. A–C. *Mucrolicter alienus*. D–F. *Zelus renardii*. G–I. *Graptocleptes* sp. J. *Hartzelus* [manuscript name]. K. *Heza ephippium*. L. *Atrachelus* sp. L. *Atopozelus* sp. A, C, D, F, G, I, lateral view; B, E, H, dorsal view. ssg, saccule of sticky gland.

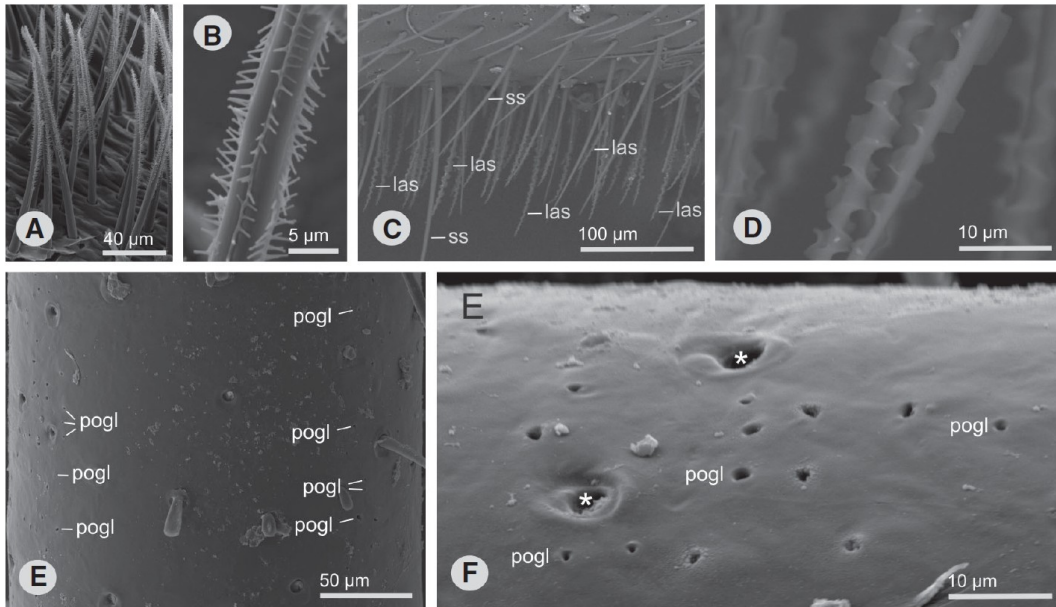

Figure 2.6. Scanning electron micrographs of sundew and lamellate setae and pores on cuticle in Harpactorini. A, B. Sundew setae on fore tibia of *Mucrolicter alienus*. C, D. Lamellate setae on fore tibia of *Heza similis*. E, F. Pores on fore tibia of *Castolus ferox*. Star signs indicate sockets of broken setae. las, lamellate setae; pogl, pore of glandular unit; ss simple setae; sus, sundew setae.

Table 2.1. Taxonomic distribution and morphological characterizations of sticky glands and specialized tibial setae in Harpactorini, including voucher information. +, very low; ++, low; +++, medium; +++++, high.

Taxon	Country	Density of sticky glands	Length/width (µm) (Ratio)	Shape of saccule	Type of specialized setae	USI (UCR_ENT)	Depository
<i>Atopozelus</i> sp.	Ecuador	+++	12.5/6.5 (1.9)	Elongate	Sundew	2576	UCR
<i>Atrachelus fusca</i> (Stål, 1872)	Colombia	++++	10.6/7.8 (1.4)	Regular	Sundew	29710	USNM
<i>Castolus ferox</i> (Banks, 1910)	USA	+++	11.5/7.5 (1.5)	Regular	Sundew	3301	UCR
Hartzelus [manuscript name]	Brazil	+	10.0/5.7 (1.8)	Elongate	Sundew	29718	USNM
<i>Corcia columbica</i> Stål, 1859	Ecuador	++	10.3/6.4 (1.6)	Regular	Sundew	29248	USNM
<i>Graptocleptes</i> sp.	Colombia	++	7.8/5.0 (1.6)	Regular	Sundew	29374	USNM
<i>Heza</i> cf. <i>ephippium</i>	Ecuador	+++	11.0/10.4 (1.1)	Roundish	Lamellate	1096	UCR
<i>Heza ephippium</i> (Lichtenstein, 1797)	Paraguay	+++	10.8/9.6 (1.1)	Roundish	Lamellate	29715	USNM
<i>Heza similis</i> Stål, 1859	Mexico	+++	10.8/9.1 (1.2)	Roundish	Lamellate	1094	UCR
<i>Heza</i> sp.	Argentina	+++	9.0/8.7 (1.0)	Roundish	Lamellate	43312	UCD
<i>Hiranetis braconiformis</i> (Burmeister, 1835)	Costa Rica	++++	14.2/8.9 (1.6)	Regular	Sundew	29254	USNM
<i>Mucrolicter alienus</i> Elkins, 1962	Guatemala	++++	14.2/9.4 (1.5)	Regular	Sundew	29258	USNM
<i>Myocoris nugax</i> Stål, 1872	Argentina	++++	15.1/8.1 (1.9)	Elongate	Sundew	29260	USNM
<i>Repipta</i> sp.	Mexico	++	11.6/8.5 (1.4)	Roundish	Sundew	3144	UCR
<i>Zelus renardii</i> Kolenati 1857	USA	+++	12.8/6.2 (2.1)	Elongate	Sundew	475	UCR

Table 2.2. Examined reduviid taxa without sticky glands, including classification and voucher information. N, New World; O, Old World.

Subfamily	Tribe	Taxon	Country	New World or Old World	USI (UCR_ENT )	Depository
Harpactorinae	Apiomerini	<i>Apiomerus flaviventris</i> Herrich-Schäffer, 1846	USA	N	29745	USNM
	Apiomerini	<i>Heniartes annulatus</i> Spinola, 1840	Brazil	N	29744	USNM
	Apiomerini	<i>Heniartes jaakkoi</i> Wygodzinsky, 1947	Paraguay	N	12272	HNHM
	Ectinoderini	<i>Ectinoderus sumptuosus</i> Distant 1903	Philippines	O	29749	USNM
	Rhaphidosomini	Rhaphidosomini sp.	Niger	O	29750	USNM
	Tegeini	<i>Lophocephala guerini</i> Laporte, 1833	Sri Lanka	O	29255	USNM
	Harpactorini	<i>Acholla ampliata</i> Stål, 1872	USA	N	29708	USNM
	Harpactorini	<i>Alcmena spinifex</i> (Thunberg, 1783)	Sri Lanka	O	29246	USNM
	Harpactorini	<i>Ambastus villosus</i> Stål, 1872	Colombia	N	29245	USNM



Harpactorini	<i>Aulacosphodrus leucocephalus</i> (Fabricius, 1794)	Liberia	O	29247	USNM
Harpactorini	<i>Coilopus vellus</i> Elkins, 1969	Brazil	N	29811	USNM
Harpactorini	<i>Cosmoclopius nigroannulatus</i> (Stål, 1860)	Paraguay	N	29249	USNM
Harpactorini	<i>Cosmolestes</i> sp.	Singapore	O	1507	UCR
Harpactorini	<i>Debilis</i> sp.	Colombia	N	29711	USNM
Harpactorini	<i>Diarthrotarsus</i> sp.	Brazil	N	30109	USNM
Harpactorini	<i>Doldina interjungens</i> (Bergroth, 1913)	USA	N	29251	USNM
Harpactorini	<i>Euagoras</i> sp.	Malaysia	O	2627	UCR
Harpactorini	<i>Fitchia aptera</i> Stål, 1859	USA	N	29721	USNM
Harpactorini	<i>Hagia bituberculata</i> Stål, 1870	Philippines	O	29253	USNM
Harpactorini	<i>Harpactor tuberculosus</i> Stål, 1872	Brazil	N	29713	USNM
Harpactorini	<i>Havinthus</i> sp.	Australia	O	29714	USNM
Harpactorini	<i>Hediocoris tibialis</i> Stål, 1855	South Africa	O	29272	USNM
Harpactorini	<i>Heza aurantia</i> Maldonado, 1976	Peru	N	1095	UCR
Harpactorini	<i>Macracanthopsis hampsoni</i> Distant,	India	O	29256	USNM

1909

Harpactorini	<i>Montina nigripes</i> Stål, 1859	Panama	N	29257	USNM
Harpactorini	<i>Montina</i> sp.	Ecuador	N	2615	UCR
Harpactorini	<i>Notocyrtus</i> <i>vesiculosus</i> (Perty, 1834)	Panama	N	29259	USNM
Harpactorini	<i>Orbella</i> sp.	Ecuador	N	30108	USNM
Harpactorini	<i>Pantoleistes</i> <i>princeps</i> Stål, 1859	Swaziland	O	29262	USNM
Harpactorini	<i>Pisilus tipuliformis</i> (Fabricius, 1794)	Liberia	O	29263	USNM
Harpactorini	<i>Ploeogaster</i> sp.	Brazil	N	81	UCR
Harpactorini	<i>Polididus</i> sp.	Thailand	O	4031	UCR
Harpactorini	<i>Pristhesancus</i> <i>phemiodes</i> Stål, 1863	Philippines	O	29264	USNM
Harpactorini	<i>Pselliopus cinctus</i> (Fabricius, 1776)	USA	N	29716	USNM
Harpactorini	<i>Pselliopus</i> sp.	Mexico	N	3160	UCR
Harpactorini	<i>Pyrrhosphodrus</i> sp.	French Guiana	N	2626	UCR
Harpactorini	<i>Rhynocoris</i> <i>segmentarius</i> (Germar, 1837)	South Africa	O	29266	USNM
Harpactorini	<i>Rhynocoris ventralis</i> (Say, 1832)	USA	N	29267	USNM
Harpactorini	<i>Ricolla</i> sp.			43311	

Harpactorini	<i>Rocconota tuberculigera</i> Stål, 1862	Mexico	N	2490	UCR
Harpactorini	<i>Sinea</i> sp.	Mexico	N	3302	USNM
Harpactorini	<i>Spedanolestes</i> sp.	Nigeria	O	1501	UCR
Harpactorini	<i>Sphedanolestes trichrous</i> Stål, 1874	Sri Lanka	O	29268	USNM
Harpactorini	<i>Sphodronyttus erythropterus</i> (Burmeister, 1834)	Philippines	O	29269	USNM
Harpactorini	<i>Velinus nigrigenus</i> (Amyot and Serville, 1843)	Malaysia	O	29270	USNM
Harpactorini	<i>Vesbius</i> sp.	Malaysia	O	1522	USNM
Harpactorini	<i>Vestula lineaticeps</i> (Signoret, 1858)	Congo	O	29261	USNM
Harpactorini	<i>Yolinus albopustulatus</i> China, 1940	China	O	29271	USNM
Bactrodinae	<i>Bactrodes femoratus</i> (Fabricius, 1803)	Brazil	N	29746	USNM
Peiratinae	<i>Ectomocoris elegans</i> (Fabricius, 1803)	Myanmar	O	29755	USNM
Stenopodainae	<i>Stenopoda cinerea</i> Laporte, 1833	USA	N	29753	USNM
Triatominae	<i>Triatoma protracta</i> (Uhler, 1894)	USA	N	29756	USNM

## **CHAPTER 3: Novel predation strategy is correlated with accelerated evolution of predatory leg morphology in assassin bugs (Insecta: Hemiptera: Reduviidae)**

### **Abstract**

Much research has focused on the effects of key innovations on species diversification, whereas little has been done to investigate their role in morphological evolution. Here, we present a phylogenetically informed study to demonstrate a correlation between a putative key innovation, the sticky trap predation strategy, and accelerated morphological diversification of the predatory fore leg in assassin bugs. Based on the first comprehensive molecular phylogeny of Harpactorini we show that bugs exhibiting sticky trap predation have evolved more slender and longer fore femora than non-sticky bugs. Using phylogenetically independent contrast analyses we document correlated evolution between femoral thickness and length, thus providing support for the existence of a functional constraint on the fore femur (i.e., a certain thickness as a requirement for muscular mechanical strength) and a trade-off between femoral thickness and length. We argue that the novel sticky trap predation strategy may allow sticky bugs to alleviate functional constraints on the fore femur and thus to attain a higher rate of fore leg evolution than other Harpactorini or Reduviidae. We also discuss the possibility that the sticky trap predation represents a case of adaptive radiation.

### **Introduction**

The term “key innovation” is mostly used to refer to a character that is considered to be critically linked to the origin of a higher taxon, niche and lineage diversification, or

adaptive radiation (reviewed in Hunter 1998 and Yoder et al. 2010). The connection of key innovations to these phenomena of biological diversifications has been and continues to be the subject of extensive theoretical discussion and numerous empirical or comparative studies (e.g., Cracraft 1990; Slowinski and Guyer 1993; Bond and Opell 1998; Ree 2005; Alfaro et al. 2009a; Moore and Donoghue 2009; Drummond et al. 2012; Erkens et al. 2012). However, relatively little attention has been paid to the role of key innovations in phenotypic or morphological diversification. As discussed in Wainwright (2007) and Price et al. (2010), most studies and discussions on this topic have not taken explicit phylogenetic approaches, nor have they measured phenotypic or morphological diversity directly (but see Thomas et al. 2006; Dornburg. et al. 2011). Besides, a taxonomic bias towards vertebrates is evident in the literature. In contrast to key innovations, a number of recent comparative phylogenetic studies have focused on the connection between extrinsic factors, such as 'ecological opportunity' and 'habitat use', and the rates of morphological diversification (Harmon 2008; Collar et al. 2009, 2010, 2011; Moen and Wiens 2009; Hulseley et al. 2010; Mahler et al. 2010; Derryberry et al. 2011; Martin and Wainwright 2011; Price et al. 2011). The current study explores the relationship between a potential key innovation, a novel predation strategy and rates of evolution of the predatory fore leg in assassin bugs (Insecta: Hemiptera: Reduviidae).

One of the mechanisms by which a key innovation provides the potential for morphological diversification is by breaking existing constraints and therefore by facilitating increased evolutionary change (Galis 2001; Price et al. 2010). For instance, powered flight as a novel locomotory system in birds has eased the constraint of maintaining running proficiency on the hind limbs, resulting in their greater morphological disparities compared to those of non-avian bipedal theropods (Gatesy and Middleton

1997). Price et al. (2010) found eight times faster rates of jaw diversification in parrot fishes that possess two ‘design breakthroughs’, an intramandibular joint and pharyngeal jaw modifications. They argue that these innovations reduce constraints on the structural elements of the jaw by increasing the degree of freedom of the jaw morphospace. Evidence for the opposite phenomenon—limited morphological diversification due to the conservation of functional constraints—also exists. For example, Cooper and Steppan (2010) showed for marsupial mammals that functional requirements of the natal climb limit the evolution of forelimb shape diversity.

A novel predation strategy called ‘sticky trap predation’ has been documented for 12 New World genera in the assassin bug tribe Harpactorini (Hemiptera: Heteroptera: Reduviidae: Harpactorinae) (Zhang and Weirauch 2011). Members, called ‘sticky bugs,’ and are characterized by unique dermal glands—‘sticky glands’—on the legs that secrete a sticky substance (Barth 1952; Ambrose 1999; Weirauch 2006). They also possess two categories of modified setae on the legs: ‘sundew setae’ that have projections resembling trichomes on the leaves of sundews (*Drosera* Linnaeus), or ‘lamellate setae’ that have undulate lamellae along the setal body (Barth 1952; Wolf and Reid 2001; Weirauch 2006; Zhang and Weirauch 2011). The setae are usually covered with the sticky secretion and their presence likely increases the surface and reach of the sticky foreleg. Sticky trap predation has been shown to be effective for trapping small, fast-flying prey, such as *Drosophila* flies (Edwards 1966; Law and Sediqi 2010; Zhang and Weirauch 2011). In contrast, other assassin bugs, including non-sticky Harpactorini, usually grasp their prey items between the fore femur and tibia (Ambrose 1999).

We propose that the sticky trap predation strategy may allow sticky bugs to break functional constraints on the fore femur and therefore may promote its morphological

diversification. The fore femur contains extensor and flexor muscles that move the fore tibia, with the flexor muscle generating the grasping force used to hold a prey item (Chapman 1998). The fore femur in raptorial assassin bugs commonly features a large flexor muscle and is enlarged compared to the femora of the mid and hind legs. We further argue that there is likely a trade-off between the thickness and length of the fore femur: to retain mobility, a thick femur may have to be relatively short and a long femur relatively slender. Therefore, we hypothesize that the thickness and length of the fore femur in Reduviidae evolve in a correlated manner. We further suggest that sticky bugs may rely to a lesser degree on mechanical power to capture prey, potentially resulting in the reduced size of the flexor muscle and reduced femur thickness, and providing increased potential for the fore femur to become diversified. Thus, we predict that the rate of morphological evolution of the fore femur is higher in sticky bugs than that in non-sticky assassin bugs and hypothesize that their fore femur is longer and more slender. We conduct phylogenetically informed comparative analyses to test these hypotheses. We reconstruct the first comprehensive molecular phylogeny of the Harpactorini, sampling 195 taxa of Harpactorini and 34 other reduviid taxa and utilizing five molecular markers. Harpactorini consist of >2,000 species (~30% of the described species diversity of assassin bugs), are the largest tribe in the Reduviidae, have worldwide distribution, and contain many charismatic species, e.g., the wheel bugs in the genus *Arilus* Hahn and the wasp or bee mimicking bugs (e.g., *Harpagocoris* Stål, *Hiranetis* Spinola, *Notocyrtus* Burmeister, *Xystonyttus* Kirkaldy; Fig. 3.1) and natural enemies (Ambrose 1999; Maldonado 1990). In addition to reconstructing the evolution of sticky trap predation within Harpactorini, the phylogeny is used to test the monophyly of Harpactorini and previous hypotheses of relationships and classifications within the

Harpactorini (e.g., Amyot & Serville 1843; Distant 1904, Villiers 1982; reviewed in Forero 2011). To test the hypothesis of correlated evolution of fore femur thickness and length, we use the phylogenetically independent contrast method (Felsenstein 1985; Garland et al. 1992). We quantify the thickness and length of the fore femur and employ the recently developed maximum likelihood method utilizing a Brownian motion model to test the rates of morphological evolution of those characters (O'Meara 2006).

## **Materials and Methods**

### *Taxon sampling and molecular methods*

We sampled 72 genera and 195 terminal taxa of Harpactorini representing ~30% of the generic diversity of the tribe and covering all major zoogeographical regions (Afrotropical, Palearctic, Oriental, Australasian, Nearctic and Neotropical). We also included 7 samples of two other tribes of the subfamily Harpactorinae (Apiomerini and Rhaphidosomini) and 27 representatives of 9 non-harpactorine reduviid subfamilies, generating a dataset of 229 taxa. We here refer to Harpactorini and Rhaphidosomini as the ingroup, since according to our and previous analyses, Rhaphidosomini are nested within the Harpactorini; we treat the remaining taxa as the outgroup. For identification and information association purposes, each specimen was given a molecular voucher number (RCW\_XXX) and a unique specimen identifier number (UCR\_ENT XXX or AMNH\_PBI XXX), the latter used to log specimen information into the Plant Bug Planetary Biodiversity Inventory project database [<https://research.amnh.org/pbi/locality/>]. DNA extraction, PCR amplification, and sequencing reaction protocols including primer information follow those described in Weirauch and Munro (2009) with modifications (Supporting Information 3.1). The five



molecular markers used include three nuclear or mitochondrial ribosomal DNAs (16S, 302-562bp; 28S D2 region, 332-694bp; 28S D3-D5 region, 293-632bp), the mitochondrial protein-coding cytochrome c oxidase subunit I (COI) gene (331-833bp) and the 5' end of a nuclear protein-coding Homeobox gene, Deformed (5' Dfd, 223-590bp) (Tian et al. 2011). A small number of DNA sequences (134 sequences or 15% of the entire data set) were obtained from previous studies (Weirauch and Munro 2009; Liu et al. 2009). For specimen voucher information and Genbank accession numbers, see Supporting Information 3.2.

#### *Morphological observations and fore femur measurements*

Information on presence or absence of sticky glands and modified setae was extracted from Zhang and Weirauch (2011) for 36 taxa. Fifty four additional taxa, mostly generic representatives (Supporting Information 3.3), were sampled across major clades included in the phylogeny and examined for absence/presence of sticky glands and modified setae following protocols used in Zhang and Weirauch (2011). Despite the differences in sticky gland morphology between *Heza* spp. and the remaining sticky bug genera that may indicate non-homology (Zhang and Weirauch, 2011), we here coded sticky glands as one absent/present character to test the possibility that the glands are homologous across the sticky bugs. To quantify the thickness of the fore femur, we used the ratio of length to width of the femur as a thickness index (TI; the higher the value of TI, the more slender the femur). The width of the fore femur at the midpoint in lateral view was measured by using an ocular micrometer mounted on a Nikon SMZ1500 dissecting microscope. For specimens with unequal widths along the femur, measurements were taken at three points (distally, medially and proximally) and the average of the three values was used. To quantify the relative length of the fore femur, a

relative length index (RLI) was determined as the ratio between the femur and body length measured from the anterior margin of the clypeus to the apex of the abdomen (the larger the RLI, the longer the fore femur relative to the body length). Data of morphological observations and fore femur measurements are provided in Supporting Information 3.3.

*Phylogenetic reconstruction, character evolution, and analyses of Phylogenetic correlation and rate of morphological evolution*

Ribosomal DNA markers (16S, 28S D2, 28S D3-D5) were aligned with MAFFT (Kato et al. 2005) using the E-INS-i algorithm and default settings. COI and 5' Dfd were aligned with MUSCLE (Edgar 2004) via the European Bioinformatics Institute portal [<http://www.ebi.ac.uk/Tools/msa/muscle/>]. The five data sets were concatenated with the program 'Sequence Matrix' (Vaidya et al. 2011) to generate a matrix of 229 taxa and 3820 characters. Phylogenetic tree reconstruction using maximum likelihood was conducted in RAxML 7.3.0 (Stamatakis 2006; Stamatakis et al. 2008) via the CIPRES (Cyberinfrastructure for Phylogenetic Research) portal (RAxML-HPC2 on XSEDE; default parameters) [<http://www.phylo.org/>]. Five hundred rapid bootstrap replicates were performed to assess nodal supports (random seed value set to default). The tree was rooted with a species of Phymatinae, a taxon that has been consistently recovered as part of the sister group to all other Reduviidae included in this study (Weirauch 2008; Weirauch and Munro 2009; Hwang and Weirauch, submitted). Character evolution of sticky glands, sundew setae, lamellate setae (discrete characters), and fore femur thickness and length (as thickness and relative length indices; continuous characters) were traced using parsimony in Mesquite (Maddison and Maddison 2011). To test the correlation between the two continuous characters (i.e., fore femur thickness and

length), the phylogenetically independent contrasts method (Felsenstein 1985) was used as implemented in PDAP (Garland et al. 1992). The thickness index was Ln-transformed and the relative length index was square rooted to create normalized distributions. Branch length transformation of Nee's method (Purvis 1995) was used, and diagnostic tests were performed to ensure statistical assumptions were met (Garland et al. 1992). Linear regression analysis of the contrasts was performed using the software QI Macros 2011 [www.qimacros.com] embedded in Microsoft Excel 2010.

We used the program Brownie (O'Meara et al. 2006) to test if rates of morphological evolution have changed across Reduviidae and Harpactorini, in particular between non-sticky and sticky Harpactorini. Three analyses were performed that contrasted the rates in the following groups with each other: (1) sticky bugs vs. non-sticky Harpactorini; (2) sticky bugs vs. all other taxa; and (3) Harpactorini (including Rhapsidosomini) vs. other tribes and subfamilies. We used the censored rate test method and both the hypothesis-testing and the model-selection approaches. In the hypothesis-testing approach, 1,000 parametric bootstrapping replicates were performed. For the likelihood ratio test of this approach, a p-value less than 0.05 was considered as significant for rejection of the null hypothesis (i.e., rate of evolution is constant throughout the tree). In the model-selection approach, two models were compared for their fit to the data, one with a single rate and another with two rates. A smaller value of the second-order Akaike Information Criterion ( $AIC_c$ ) indicates a better fitting model. An absolute difference in the  $AIC_c$  of the two models ( $\Delta AIC_c$ )  $\geq 8$  suggests that the better fitting model is strongly favored, and a value of  $\Delta AIC_c \geq 4$  indicates the better fitting model is moderately supported. Instead of using a chronogram, we used the maximum likelihood-based phylogram shown in Fig. 3.1 that has branch lengths proportional to the

number of substitutions, which is appropriate for the rate tests implemented in Brownie (O'Meara, pers. comm.). The Ln or square-root transformed thickness index and relative length index were used for the tests. For testing rate evolution using Brownie, we considered the clade containing *Heza* Amyot and Serville and *Isocondylus* Amyot and Serville as part of the non-sticky bugs. This is because the evolutionary scenarios of sticky trap predation in this clade are ambiguous and pertinent morphological characteristics (i.e., lamellate setae versus sundew setae; different shapes of sticky gland sacculi) are rather different in this clade than in the majority of sticky bugs.

## Results

### *Morphological observations and measurements of fore femur thickness and length*

Three previously unstudied genera of Harpactorini, *Ischnoclopius* Stål, *Neotropiconyttus* Kirkaldy, and *Xystonyttus* are here shown to possess sticky glands and sundew setae, increasing the known number of sticky bug genera to 15 (Supporting Information 3.3). Sticky glands and sundew setae are present in all examined species of 14 sticky bug genera. The remaining genus, *Heza*, includes species with sticky glands and lamellate setae and species that lack one or both structures. The thickest fore femora were found in non-harpactorine taxa – *Racelda* sp. (Ectrichodiinae; TI=2.57), *Cnizocoris* sp. (Phymatinae; 2.62), and *Peirates* sp. (Peiratinae; 3.10). The most slender fore femora were found in *Ischnoclopius* (Harpactorini; TI=49.50), *Rhaphidosomini* sp. RCW\_2736 (29.02) and 'Hartzelus' [manuscript name] RCW\_2862 (Harpactorini; 28.64). Two of these, *Ischnoclopius* and 'Hartzelus', are sticky bugs. The three relatively shortest fore femora were also found in the outgroup taxa: *Ploiaria hirticornis* (Banks) (Emesinae; RLI=0.17), *Rhiginia* sp. (Ectrichodiinae; 0.19) and *Platymeris biguttatus* (Linnaeus)

(Reduviinae; 0.19). The three relatively longest fore femora were found in the sticky bugs: *Ischnoclopius* (0.75) and two species of *Zelus* Fabricius (0.66 and 0.58). The sticky bug *Ischnoclopius* has both the most slender and the relatively longest fore femur.

### *Phylogeny*

The best likelihood phylogenetic tree in the current analysis is shown in Fig. 3.1. Harpactorinae, represented in the present study by Apiomerini, Harpactorini, and Rhaphidosomini, were recovered as monophyletic. Apiomerini are monophyletic and the sister group to the remaining Harpactorinae included in this analysis. The tribe Harpactorini is paraphyletic with respect to the Rhaphidosomini, which are the sister group to the Harpactorini genus *Coranus* Curtis. Fourteen genera of sticky bugs are represented in the phylogeny and fall into two clades. The sticky bug genus *Heza* and the non-sticky *Isocondylus* form a clade (clade H; Fig. 3.1), with *Heza* being paraphyletic with respect to *Isocondylus*. The remaining 13 sticky bug genera are recovered as a monophyletic clade (clade S; Fig. 3.1).

Nineteen genera were recovered as monophyletic, including relatively speciose genera such as *Coranus*, *Euagoras* Burmeister, *Ploeogaster* Amyot and Serville and *Sinea* Amyot and Serville. Genera recovered as paraphyletic are *Cosmolestes* Stål, 'Hartzelus', *Heza*, *Repipta* Stål and *Ricolla* Stål. The genera *Endochus* Stål, *Graptocleptes* Stål, *Myocoris* Burmeister, *Rhynocoris* Hahn, *Rocconota* Stål, *Sphedanolestes* Stål and *Zelus* are polyphyletic. Nearly all historically proposed suprageneric groups within the Harpactorini are paraphyletic or polyphyletic in the current phylogeny (Supporting Information 3.4).

To describe aspects of the overall phylogeny of Harpactorini and to place sticky bugs in that context, we highlight three well supported clades within the Harpactorini +

Rhaphidosomini group (bootstrap value >85; indicated by numbers in black circles; Fig. 3.1): Clade 1 contains some of the largest harpactorine assassin bugs (e.g., *Eulyes* Amyot & Serville, *Sycanus* Amyot & Serville, *Pantoleistes* Stål; body length 27-29 mm), with species mostly restricted to the Old World tropics. Interestingly, the New World genus *Sinea* is nested within this clade and recovered as sister to the Old World genus *Irantha* Stål. Members of these two genera are heavily tuberculate and possess acute spines on the fore leg (Fig. 3.1), features that we now propose to be homologous in the two taxa and potentially synapomorphic for the *Irantha* + *Sinea* clade. Clade 2 has an exclusive Old World distribution and contains Rhaphidosomini and some small to mid-sized Harpactorini. The Afrotropical wasp-mimetic *Harpagocoris* and two of the most speciose genera of Harpactorinae and Reduviidae, *Rhynocoris* and *Sphedanolestes* belong to this clade. Clade 3 contains all the New World taxa sampled except *Sinea*, but also a small Old World group that is recovered as the sister group to the Neotropical taxa. The sticky bug genera are nested within this Neotropical clade.

*Character Evolution, tests of correlated evolution and rates of morphological evolution*

The most parsimonious reconstruction unambiguously shows that sticky glands evolved independently three times, once at the base of clade S and twice within clade H (Fig. 3.2). This result reflects the morphological differences of the sticky glands in *Heza* spp. and taxa in clade S described by Zhang and Weirauch (2011). Sundew setae evolved once at the base of clade S and are retained in all taxa examined within this clade. Three equally most parsimonious reconstructions exist for the evolution of lamellate setae: one gain and three losses; three gains and one loss; and four gains (the first scenario is shown in Fig. 3.2). The evolution of sticky glands and sundew setae coincide at the base of clade S. We hereafter refer to clade S as the 'sticky bugs'.

Based on the parsimony reconstruction of fore femur thickness and relative length, the ancestral condition in Reduviidae is a relatively thick (TI=4.9) and short (RLI=0.25) fore femur. The ancestor of Harpactorinae was reconstructed to have values of TI=7.64 and RLI=0.32. Those values are even higher in sticky bugs (clade S) (TI=13.1, RLI=0.41), indicating that the ancestor of this clade had a relatively more slender and longer fore femur. The phylogenetically independent contrasts analysis shows that fore femur thickness and relative length are strongly correlated ( $R^2=0.41$ ,  $df=227$ ,  $P<0.001$ ) (Fig. 3.3). This correlation is also documented in the lateral habitus images and line drawings of the fore femur of selected Reduviidae (Fig. 3.2).

When sticky bugs were compared with all other assassin bugs, the hypothesis of a constant rate of evolution throughout the tree was rejected for both fore femur thickness ( $p=0.003$ ) and relative length ( $p<0.001$ ) using the parametric bootstrapping likelihood ratio test (Table 3.1). The model-selection approach also found moderate or strong support, respectively, for a two-rate model for the evolution of fore femur thickness ( $\Delta AICc=6.8$ ) and relative length ( $\Delta AICc=20.7$ ). In clade S, the fore femur thickness index (Ln-transformed) exhibited a Brownian motion rate 1.8 times faster than the rate in the remaining Reduviidae; the rate for relative femur length index (square rooted) was 2.6 times higher than the rate in other Reduviidae. For the analyses comparing sticky bugs to other Harpactorini, and Harpactorini to other reduviids, a two rate model was also favored (Table 3.1). The rate differences were smaller between sticky bugs and other Harpactorini than that between sticky bugs and all other reduviids. Within the sticky bugs (clade S), multiple taxa show exceptionally slender and long fore femora (e.g., *Ischnoclopius* sp. RCW 2679, 'Hartzelus' sp. RCW 2681, *Zelus* sp. RCW 2095).

## Discussion

The current study investigates the evolutionary history of a novel predation strategy, sticky trap predation, and tests its correlation with the morphological diversification of the predatory fore leg in assassin bugs. We show that the evolution of sticky trap predation is correlated with the evolution of a fore femur that is more slender and longer than that of a typical raptorial fore leg as seen in most other assassin bugs. We argue that sticky trap predation may have reduced constraints on the fore femur and accelerated the evolution of more slender and longer fore legs.

### *Molecular phylogeny of Harpactorini and evolutionary scenarios for sticky trap predation*

The result of a paraphyletic Harpactorini (with respect to Rhaphidosomini) is consistent with that seen in phylogenies in Weirauch and Munro (2009) and warrants further investigation and inclusion of morphological characters. Historical suprageneric classifications within the Harpactorini are shown to not reflect natural relationships, and we argue that this may be due to the use of homoplastic characters in defining these groups. For instance, the presence of a mesopleural tubercle or 'plica' has been used to group genera within Harpactorini (Stål 1859; Villiers 1982). Based on our phylogenetic analysis, this structure is shown to have independently evolved at least 10 times (clades or taxa indicated by asterisks; Fig. 3.1).

Sticky trap predation, characterized by the possession of sticky glands and modified setae, evolved more than once based on the current analysis. Sticky bugs in clade S have elongate or pear-shaped sacculles of sticky glands and possess sundew setae, whereas those of clade H have roundish sacculles and lamellate setae (Zhang and Weirauch 2011). Based on these morphological differences and the current tree topology, we corroborate a previous speculation that these sticky glands may not be



homologous and that sticky trap predation may have evolved convergently in *Heza* and in the remaining sticky bugs. In addition, we show that the sticky trap predation strategy has evolved within the New World. Future research may be directed towards inferring the historical contexts in the New World that might have initiated or favored the evolution of this novel predation strategy.

*Sticky trap predation strategy correlates with faster rates of morphological evolution of predatory leg*

Our analyses support higher rates of morphological evolution of fore femur thickness and relative length in the sticky bugs, providing evidence for the hypothesis that sticky trap predation, as an evolutionary innovation, is correlated with faster evolution of predatory leg morphology. The smaller rate difference between sticky bugs and other Harpactorini compared to the difference between sticky bugs and all other reduviids, can be explained by the already faster rates of evolution in this group compared to other reduviids (Table 3.1). We argue that the accelerated evolution in sticky bugs may be attributed to relaxed constraints on the morphology of the fore femur. Using the phylogenetically independent contrasts method we show that fore femur thickness and relative length are correlated as predicted by the constraint and trade-off theories.

Wainwright (2007) pointed out that a possible consequence of evolutionary innovations is the potential decoupling of performance traits that are originally linked to a trade-off. In the context of a raptorial fore leg, these two performance traits could be the reach (determined by the length of fore femur) and the speed and strength with which a prey organism can be captured and held (determined by the thickness of the fore femur as a proxy for size and power of the tibial flexor muscle). A thick femur containing a larger flexor can generate a larger force, but would be compromised in its length or how far it

can reach due to the difficulty of moving a long and heavy femur. On the other hand, a longer femur enables the bug to reach further, but would be more slender and thus compromising mechanical strength or prey capture efficiency. Sticky trap predation breaks these constraints by exchanging mechanical strength with a sticky trap and provides an opportunity for faster evolution of the fore femur that becomes both longer and more slender within the sticky bug group. However, the realization of this opportunity varies across sticky bugs, with some taxa retaining legs that are comparable to those of non-sticky harpactorines (e.g., *Castolus* sp. RCW 1097). It could be argued that this predation strategy does not necessarily replace the raptorial function of the fore leg, but only supplements it, and we suspect that faster morphological evolution may be realized only under certain ecological circumstances.

#### *Sticky trap predation and adaptive radiation*

Simpson (1953) argued that the acquisition of a novel trait that influences the ability to exploit unused resources may be critical for the initiation of an adaptive radiation. Under this scenario, the sticky trap predation strategy may have initiated an adaptive radiation of sticky bugs (clade S). According to Schluter (2000) and Glor (2010), several criteria need to be met to qualify as adaptive radiation, i.e., common ancestry, rapid speciation and extraordinary diversity, and trait utility. In the present study, we have shown that the sticky bugs of clade S share a common ancestor. Second, the extraordinary diversification and rapid speciation of the sticky bugs will need to be demonstrated. Sticky bugs currently comprise 134 valid species, they are an order of magnitude more speciose than their sister group (*Debilina*; 9 spp.), and comprise a large proportion (~43%) of all described New World species of Harpactorini (Maldonado 1990). Additional studies should investigate if sticky bugs also show elevated speciation rates, using a

time-calibrated phylogeny and speciation rate estimates (e.g., Alfaro et al. 2009b). Finally, the trait utility or adaptive function of the sticky trap predation strategy will need to be demonstrated. This will require tests of prey capture efficiency of sticky and non-sticky bugs with various prey items. We speculate that sticky trap likely increases the efficiency of capturing small and fast flying prey and therefore opens a previously inaccessible ecological opportunity. In summary, we propose that sticky bugs may indeed represent an adaptive radiation, but the above mentioned studies are required to further test this hypothesis.

## References

- Alfaro, M. E., Brock, C. D., Banbury, B. and Wainwright, P. C. 2009a. Does evolutionary innovation in pharyngeal jaws lead to rapid lineage diversification in labrid fish? *BMC Evolutionary Biology*, 9, 255.
- Alfaro, M. E., Santini, F., Brock, C., Alamillo, H., Dornburg, A., Rabosky, D. L., Carnevale, G. and Harmon, L. J. 2009b. Nine exceptional radiations plus high turnover explain species diversity in jawed vertebrates. *Proceedings of the National Academy of Sciences USA* 106, 13410-13414.
- Ambrose, D. P. 1999. *Assassin Bugs*. Science Publishers, Enfield, NH, 337 pp.
- Amyot, C. J. B. and Serville, A. 1843. *Histoire naturelle des insectes. Hémiptères. Librairie encyclopédique de Roret; Fain et Thunot, Paris*. lxxvi + 675 + 12 pls.
- Barth, R. 1952. Die Fangdrüsen an den Beinen von *Zelus (Diplocodus) leucogrammus* (Perty). *Zoologische Jahrbücher*, 73, 323-336.
- Bond, J. E. and Opell, B. D. 1998. Testing adaptive radiation and key innovation hypotheses in spiders. *Evolution*, 52, 403-414.
- Collar, D. C., O'Meara, B. C. Wainwright, P. C. and Near, T. J. 2009. Piscivory limits morphological diversification in centrarchid fishes. *Evolution*. 63, 1557-1573
- Collar, D. C., Schulte II, J. A., O'Meara, B. C. and Losos, J. B. 2010. Habitat use affects morphological diversification in dragon lizards (Agamidae). *Journal of Evolutionary Biology*, 23, 1033-1049.
- Collar, D. C., Schulte II, J. A. and Losos, J. B. 2011. Evolution of extreme body size disparity in monitor lizards (*Varanus*). *Evolution*, 65, 2664-2680.
- Cooper, D. W. and Steppan, S. J. 2010. Developmental constraint on the evolution of marsupial forelimb morphology. *Australian Journal of Zoology*, 58, 1-15.
- Cracraft, J. 1990. The origin of evolutionary novelties: pattern and process at different hierarchical levels. In: *Evolutionary Innovations* (M. Nitecki, ed.) pp. 21-44. University of Chicago Press, Chicago, USA
- Derryberry, E. P., Claramunt, S., Derryberry, G., Chesser, R. T., Cracraft, J., Aleixo, A., Pérez-Emán, J., Remsen, J. V. Jr. and Brumfield, R. T. 2011. Lineage diversification and morphological evolution in a large-scale continental radiation: the Neotropical ovenbirds and woodcreepers (aves: Furnariidae). *Evolution* 65, 2973-2986
- Distant, W. L. 1904. *The fauna of British India, including Ceylon and Burma*. Rhynchota. Vol. 2. (Heteroptera). Taylor and Francis, London. U.K. xvii + 503 p

- Dornburg, A., Sidlauskas, B., Santini, F., Sorenson, L., Near, T. J. and Alfaro, M. E. 2011. The influence of an innovative locomotor strategy on the phenotypic diversification of triggerfish (Family: Balistidae). *Evolution*, 65, 1912-1926.
- Drummond C. S., Eastwood, R. J. Miotto, S. T. and Hughes, C. E. 2012. Multiple continental radiations and correlates of diversification in *Lupinus* (Leguminosae): Testing for key innovation with incomplete taxon sampling. *Systematic Biology*, doi: 10.1093/sysbio/syr126.
- Edgar, R. C. 2004. MUSCLE: multiple sequence alignment with high accuracy and high throughput. *Nucleic Acids Research*, 32, 1792-1797.
- Edwards, J. S. 1966. Observations on the life history and predatory behaviour of *Zelus exsanguis* (Stål) (Heteroptera: Reduviidae). *Proceedings of the Royal Entomological Society of London (A)*, 41, 21-24.
- Erkens, R. H. J., Chatrou, L. W. and Couvreur, T. L. P. 2012. Radiations and key innovations in a basal angiosperm lineage (Annonaceae; Magnoliales). *Botanical Journal of the Linnean Society*, 169, 117-134.
- Felsenstein, J. 1985. Phylogenies and the comparative method. *American Naturalist*, 125, 1-15.
- Forero, D. 2011. Classification of Harpactorinae assassin bugs (Hemiptera: Heteroptera: Reduviidae). *Boletín del Museo Entomológico Francisco Luis Gallego*, 3, 9-24.
- Galis, F. 2001. Key innovations and radiations. In: *The Character Concept in Evolutionary Biology*. (ed. G. P. Wagner) pp. 583-607. Academic Press, San Diego, USA.
- Garland, T. Jr., Harvey, P. H. and Ives, A. R. 1992. Procedures for the analysis of comparative data using phylogenetically independent contrasts. *Systematic Biology*, 41, 18-32.
- Gatesy, S. M. and Middleton, K. M. 1997. Bipedalism, flight, and the evolution of theropod locomotor diversity. *Journal of Vertebrate Paleontology*, 17, 308-329.
- Harmon, L. J., Melville, J. Larson, A. and Losos, J. B. 2008. The role of geography and ecological opportunity in the diversification of day geckos (*Phelsuma*). *Systematic Biology*, 57, 562-573.
- Hulsey, C. D., Mims, M. C., Parnell, N. F. and Streelman, J. T. 2010. Comparative rates of lower jaw diversification in cichlid adaptive radiations. *Journal of Evolutionary Biology*, 23, 1456-1467.
- Hunter, J. P. 1998. Key innovations and the ecology of macroevolution. *Trends in Ecology and Evolution*, 13, 31-36.

- Hwang, W. S. and Weirauch, C. 2012 Evolutionary History of Assassin Bugs (Insecta: Hemiptera: Reduviidae): Insights from Divergence Dating and Ancestral State Reconstruction. *PLoS ONE*, 7: e45523. doi:10.1371/journal.pone.0045523
- Katoh, K., Kuma, K., Toh, H. and Miyata, T. 2005. MAFFT version 5: improvement in accuracy of multiple sequence alignment. *Nucleic Acids Research*, 33, 511-518.
- Law, Y.-H., and Sediqi, A. 2010. Sticky substance on eggs improves predation success and substrate adhesion in newly hatched *Zelus renardii* (Hemiptera: Reduviidae) instars. *Annals of the Entomological Society of America*, 103, 771-774.
- Liu, H., Zhao, P., Li, S. and Cai, W. 2009. Taxonomic status of *Velinoides* Matsumura (Hemiptera: Reduviidae: Harpatorinae) inferred from mitochondrial and nuclear genes. *Zootaxa*, 2080, 55-68.
- Maddison, W. P. and Maddison, D. R. 2011. Mesquite: a modular system for evolutionary analysis. Version 2.75 <http://mesquiteproject.org>.
- Mahler, D. L., Revell, L. J., Glor, R. E. and Losos, J. B. 2010. Ecological opportunity and the rate of morphological evolution in the diversification of Greater Antillean anoles. *Evolution*, 64, 2731-2745.
- Maldonado, J. 1990. Systematic catalogue of the Reduviidae of the world (Insecta: Heteroptera). *Caribbean Journal of Science, Special Edition*, No. 1. Mayaguez, Puerto Rico, USA. pp. i-x, 1-694
- Martin, C. H. and Wainwright, P. C. 2011. Trophic novelty is linked to exceptional rates of morphological diversification in two adaptive radiations of Cyprinodon pupfish. *Evolution*, 65, 2197-2212.
- Moen, D. S. and Wiens, J. J. 2009. Phylogenetic evidence for competitively-driven divergence: body-size evolution in Caribbean treefrogs (Hylidae: *Osteopilus*). *Evolution*, 63, 195-214.
- O'Meara, B. C., Ané, C., Sanderson, M. J. and Wainwright, P. C. 2006. Testing for different rates of continuous trait evolution using likelihood. *Evolution*, 60, 922-933.
- Moore, B. R. and Donoghue, M. J. 2009. A Bayesian approach for evaluating the impact of historical events on rates of diversification. *Proceedings of the National Academy of Sciences USA*, 106, 4307-4312.
- Price, S., Holzman, A. R., Near, T. J. and Wainwright, P. C. 2011. Coral reefs promote the evolution of morphological diversity and ecological novelty in labrid fishes. *Ecology Letters*, 14, 462-469.

- Price, S. A., Wainwright, P. C., Bellwood, D. R., Kazancioglu, E., Collar, D. C. and Near, T. J. 2010. Functional innovations and morphological diversification in parrotfishes. *Evolution*, 64, 3057-3068.
- Purvis, A. 1995. A composite estimate of primate phylogeny. *Philosophical Transactions of the Royal Society-B*, 348, 405-421.
- Ree, R. H. 2005. Detecting the historical signature of key innovations using stochastic models of character evolution and cladogenesis. *Evolution* 59, 257-265.
- Schluter, D. 2000. *The Ecology of Adaptive Radiation*. Oxford University Press, Oxford, U.K. viii +288 pp.
- Simpson, G. G. 1953. *The major features of evolution*. Columbia University Press, New York. USA. 434 pp.
- Slowinski, J. B., and Guyer, C. 1993. Testing whether certain traits have caused amplified diversification-an improved method based on a model of random speciation and extinction. *American Naturalist*, 142, 1019-1024.
- Stål, C. 1859. Till kännedomen om Reduvini. Ofversigt af Kongl. Vet.-Akad. Förhandl. 16, 175-204.
- Stamatakis, A. 2006. RAxML-VI-HPC: maximum likelihood-based phylogenetic analyses with thousands of taxa and mixed models. *Bioinformatics*, 22, 2688-2690.
- Stamatakis, A., Hoover, P. and Rougemont, J. 2008. A Fast Bootstrapping Algorithm for the RAxML Web-Servers. *Systematic Biology*, 57, 758-771.
- Thomas, G. H., Freckleton, R. P. and Szekely, T. 2006 Comparative analysis of the influence of developmental mode on phenotypic diversification rates in shorebirds. *Proceedings of the Royal Society-B*, 273, 1619-1624.
- Tian, X., Xie, Q., Li, M., Gao, C., Cui, Y., Xi, L. and Bu, W. 2011. Phylogeny of pentatomomorphan bugs (Hemiptera-Heteroptera: Pentatomomorpha) based on six Hox gene fragments. *Zootaxa* 2888, 57-68.
- Vaidya, G., Lohman, D. J. and Meier, R. 2011. SequenceMatrix: concatenation software for the fast assembly of multi-gene datasets with character set and codon information. *Cladistics* 27, 171-180.
- Villiers A. 1982. Hémiptères Reduviidae africains. Localisations et descriptions. 3. Harpactorinae, Rhinocorini. *Revue Francaise d'Entomologie Nouvelle Serie* 4, 126-136.
- Wainwright, P. C. 2007. Functional versus morphological diversity in macroevolution. *Annual Review of Ecology, Evolution and Systematics*, 38, 381-401.

- Weirauch, C. 2006. Observations on the sticky trap predator *Zelus luridus* Stål (Heteroptera: Reduviidae: Harpactorinae), with the description of a novel gland associated with the female genitalia. *Denisia* 50, 1169-1180.
- Weirauch, C. 2008. Cladistic analysis of Reduviidae (Heteroptera: Cimicomorpha) based on morphological characters. *Systematic Entomology* 33, 229-274.
- Weirauch, C., and Munro, J. B. 2009. Molecular phylogeny of the assassin bugs (Hemiptera: Reduviidae), based on mitochondrial and nuclear ribosomal genes. *Molecular Phylogenetics and Evolution*, 53, 287-99.
- Wolf, K. W. and Reid, W. 2001. Surface morphology of legs in the assassin bug *Zelus longipes* (Hemiptera: Reduviidae): A scanning electron microscopy study with an emphasis on hairs and pores. *Annals of the Entomological Society of America*, 94, 457-461.
- Yoder, J. B., Des Roches, S., Eastman, J. M., Gentry, L., Godsoe, W. K. W., Hagey, T., Jochimsen, D., Oswald, B. P., Robertson, J., Sarver, B. A. J., Schenk, J. J., Spear, S. F. and Harmon, L. J. 2010. Ecological opportunity and the origin of adaptive radiations. *Journal of Evolutionary Biology* 23, 1581-1596.
- Zhang, G. and Weirauch C. 2011. Sticky predators: a comparative study of sticky glands in harpactorine assassin bugs (Insecta: Hemiptera: Reduviidae). *Acta Zoologica*, DOI: 10.1111/j.14636395.2011.00522.x



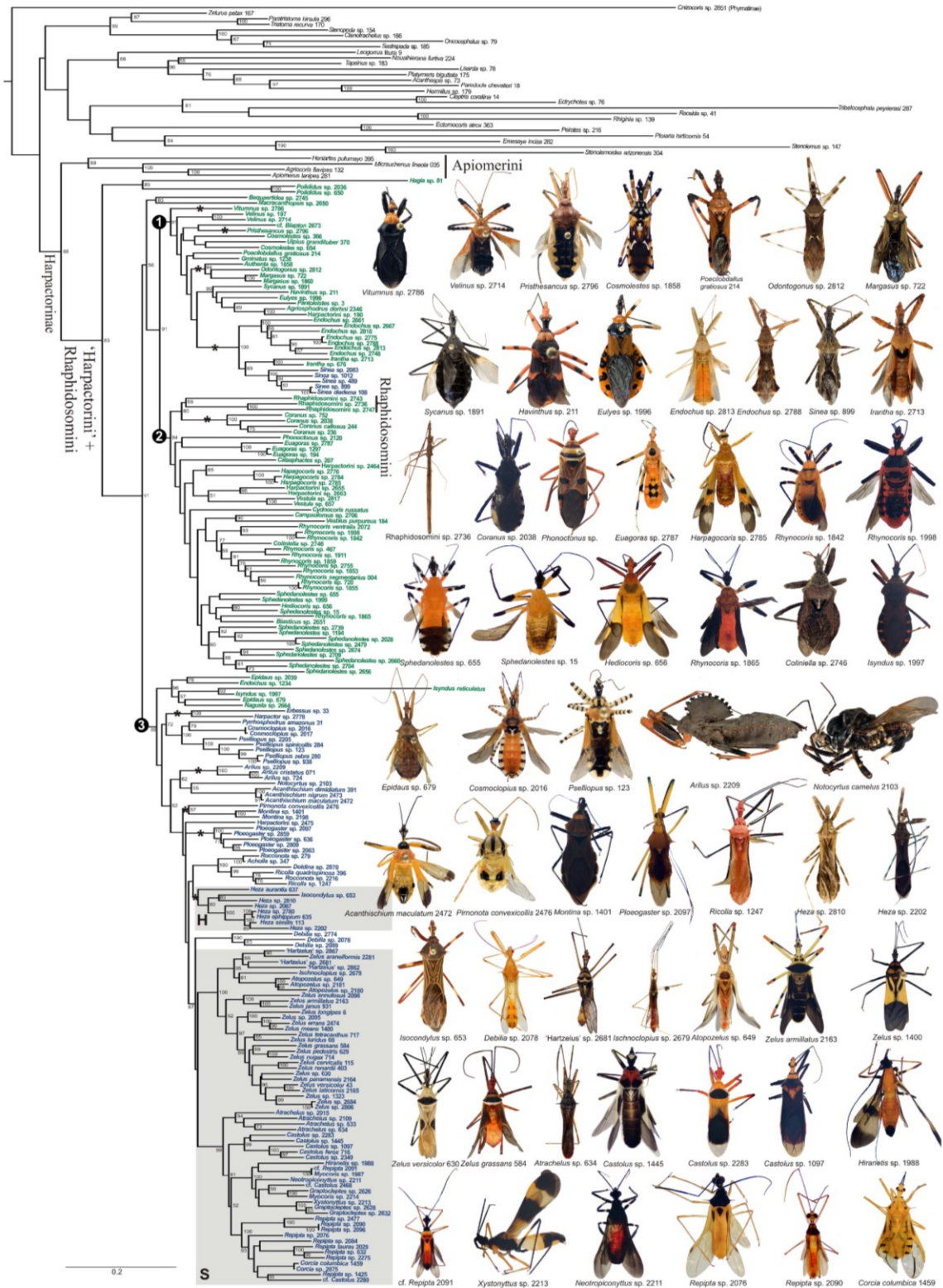

Figure 3.1. Molecular phylogeny of Harpactorini reconstructed using maximum likelihood and habitus images of representatives of Harpactorini and Rhabidosomini. Numbers after taxon names are RCW numbers. Taxa in blue are found in the New World, taxa in green in the Old World. Clades boxed in grey contain sticky bugs (for ancestral state reconstruction see Fig. 3.2). S – Sticky bug clade. H – *Heza* clade (including *Isocondylus*). Three clades are indicated by circled numbers and referred to in the results. Asterisks (\*) indicate clades where taxa possess a mesopleural tubercle (plica). Numbers adjacent to nodes are bootstrap support values (shown only if greater than 50).

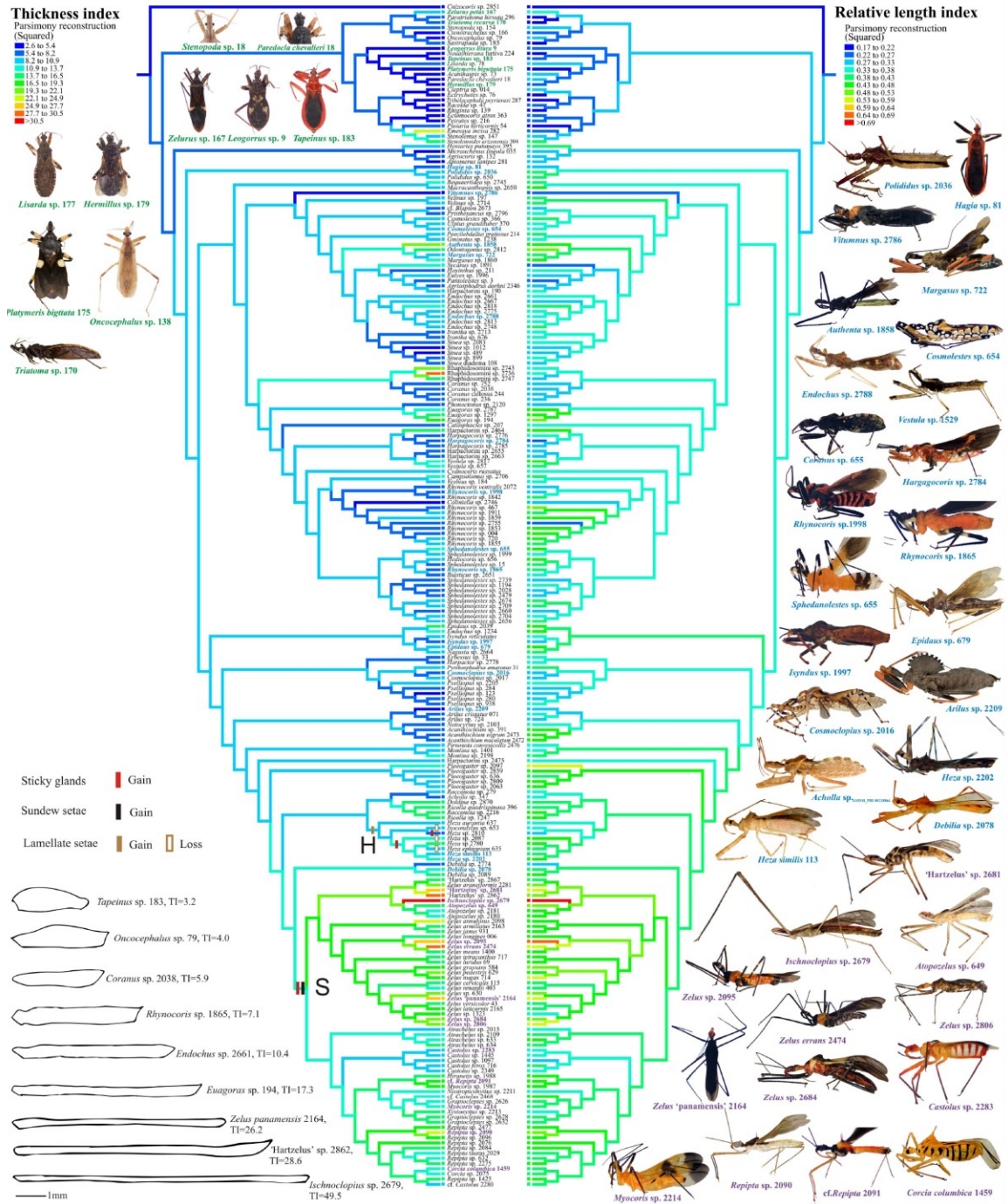

Figure 3.2. Character evolution of sticky glands, sundew setae, lamellate setae, and fore femur thickness and relative length using parsimony methods implemented in Mesquite. Numbers after taxon names are RCW numbers. Fore femur thickness and relative length indices are mapped on the phylogeny as continuous characters. Colder colors (e.g., blue) indicate low values and warmer colors (e.g., red) high values. Habitus images of representative species show the length of fore femur relative to body length. Clade H

includes *Heza* and *Isocondylus*. Clade S includes remaining 13 genera of sticky bugs sampled (sticky bug clade). Bars on tree indicate gains or losses of characters. In clade H, one of three equally most parsimonious scenarios of the evolution of lamellate setae is shown (one gain and three losses). Lower left are illustrations of a series of fore femur in lateral view with increasing thickness index (i.e., more slender). Habitus images of representative species show the length of the fore femur relative to body length. Outgroup taxa are on the left panel and Harpactorini on the left. Taxon names are colored to correspond to those on the tree (green—outgroup taxa; blue—non-sticky Harpactorini; purple—sticky bugs).

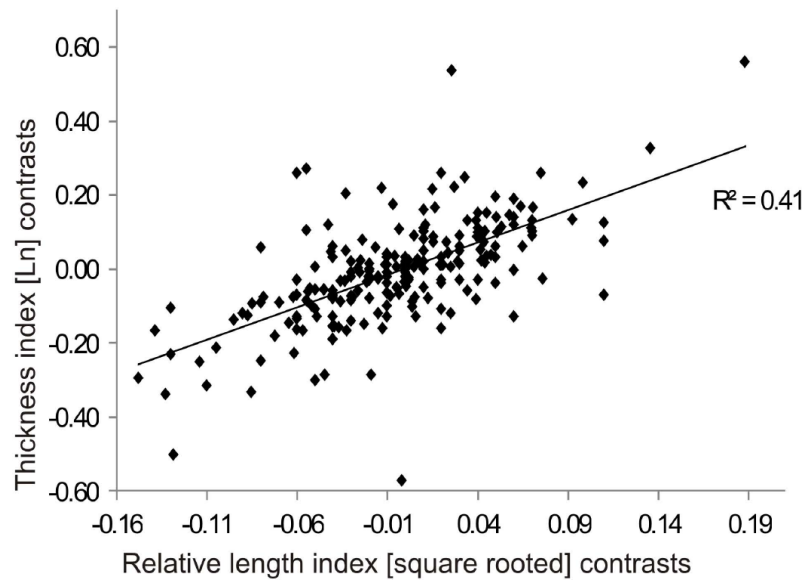

Figure 3.3. Linear regression analysis (through the origin) showing correlation between fore femur thickness and relative length.

Table 3.1. Morphological evolutionary rate tests using Brownie. A parametric bootstrap p-value smaller than 0.05 weakly rejects a constant rate hypothesis; smaller than 0.01 moderately rejects a constant rate hypothesis; and smaller than 0.001 strongly rejects a constant rate hypothesis.  $\Delta AICc < 4$  weakly favors a multi-rate model;  $\geq 4$  moderately favors a multi-rate model; and  $\geq 8$  strongly favors a multi-rate model. Ln-transformed thickness index and square-rooted relative length index were used in the rate test.

analysis	parametric bootstrap p-value		$\Delta AICc$	Rates and ratio		
	Thickness	Length		Thickness	Length	Thickness
Sticky bugs vs. all other assassin bugs	0.003	<0.001	6.8	20.7	0.22/0.12=1.8	0.049/0.019=2.6
Sticky bugs vs. other Harpactorini	<0.027	<0.001	3.03	12.38	0.22/0.14=1.6	0.049/0.022=2.2
Harpactorini VS. other tribes and subfamilies	<0.001	<0.001	10.2	30.48	0.18/0.043=4.2	0.030/0.0043=7.1

Supporting Information 3.1. Molecular protocol.

This protocol is based on Weirauch & Munro (2009) with modifications. The right hind leg/tibia was removed from each specimen. Genomic DNA extraction followed the QIAGEN DNeasy Blood & Tissue Kit protocols. Primer sequences used for PCR amplification of the 16S rDNA fragment, the 18S rDNA fragment, and the 28S rDNA D2, D3-D5 expansion regions are provided below. PCR was performed using GE Healthcare Life Sciences PuReTaq- Ready-To-Go-PCR-Beads with an Eppendorf Thermo Cycler. Thermocycler programs used: denaturation 94 °C (30 s), annealing 44-48 °C (30 s), extension 72 °C (45 s) for 35 cycles; with initial denaturation 94 °C (2-5 min) and final extension 72 °C (7 min). For the nuclear protein coding gene *Deformed*, gel extraction was performed when multiple bands appeared using the QIA Quick Gel Extraction Kit.

Primer information:

Gene	Forward	Reverse
16S	16sa: 5'-CGC CTG TTT ATC AAA AAC AT-3'	16sb: 5'-CTC CGG TTT GAA CTC AGA TCA-3'
28S D2	28S-CW-D2F: 5'- CGG GTT GCT TGA GAG TGC AGC-3'	28S-CW-D2R: 5'- CCG TCT TGA AGC ACG GAC CAA-3'
28S D3-D5	28S-CW-D3Fa: 5'- CCG TCT TGA AGC ACG GAC C -3'	28S-CW-D5R: 5'- CCC ACA GCG CCA GTT CTG CTT -3'
<i>COI</i> (~800bp fragment)	LCO1490: 5'-GGT CAA CAA ATC ATA AAG ATA T-3'	Hcoutout: 5'-GTA AAT ATA TGR TGD GCT C-3'
<i>COI</i> (~400bp fragment)	<i>COI_Harp_F</i> : 5'-ATT GGA AAT GAY CAA ATY TAT A-3'	<i>COI_Harp_R</i> : 5'-GAD GTA TTA AAR TTW CGR TCW-3'
5' end of <i>Dfd</i>	5'-C GTC GAY CCN AAR TTY CCN CC-3'	5'-TGT ATY TTN CGC ATC CAN GGR TA-3'

Supporting Information 3.2. Voucher information and Genbank accession numbers. The RCW No. is a voucher number used in the Weirauch Lab. The unique specimen identifier number (USI) is a number on a barcode label and is used for recording specimens in the Plant Bug Inventory database [<https://research.amnh.org/pbi/locality/>]. CAS: California Academy of Sciences; FCAP: The insect collection of the Universidade Federal do Para; INBio: Instituto Nacional de Biodiversidad; UCR: Entomology Research Museum University of California, Riverside; USNM: United States National Museum.



Taxon	RCW No.	USI (Unique Specimen Identifier)	Depository	Locality (country: state)	Genbank accession number				
					16S	28S D2	28S D3-D5 <sup>2</sup>	COI	5' Dfd
<i>Acanthaspis</i> sp.	73	AMNH_PBI 00218828	UCR	South Africa: Northern Cape)	*FJ230403	*FJ230559	*FJ230637 *FJ230716	JQ888541	–
<i>Acanthischium dimidiatum</i> Stål <sup>1</sup>	391	UCR_ENT 00000074	FCAP	Brazil: Para	*FJ230450	*FJ230607	*FJ230685 *FJ230764	JQ888543	–
<i>Acanthischium maculatum</i> Amyot & Serville	2472	UCR_ENT 44410	UCR	Peru: Madre de Dios	JQ888387	JQ888731	JQ888894	–	JQ889021
<i>Acanthischium nigrum</i> Stål	2473	UCR_ENT 44336	UCR	Peru: Madre de Dios	JQ888388	JQ888732	JQ888895	JQ888542	–
<i>Acholla</i> sp. <sup>1</sup>	347	UCR_ENT 00000089	UCR	USA: Arizona	*FJ230446	–	*FJ230681 *FJ230760	–	–
<i>Agriocoris flavipes</i> (Fabricius)	132	AMNH_PBI 00218885	UCR	French Guiana: Cayenne	–	*FJ230569	*FJ230646 *FJ230725	JQ888544	–
<i>Agriosphodrus dorhni</i> (Signoret)	2346	UCR_ENT 00005143	UCR	Japan	JQ888389	JQ888733	JQ888896	JQ888545	JQ889022
<i>Apiomerus lanipes</i> (Fabricius)	281	AMNH_PBI 00219016	UCR	Argentina: Santiago del Estero	*FJ230435	*FJ230597	*FJ230671 FJ230750	JQ888546	JQ889023
<i>Arilus cristatus</i> (Linne)	71	AMNH_PBI 00218826	UCR	USA: Pennsylvania	*FJ230402	*FJ230558	*FJ230636 *FJ230715	JQ888547	JQ889024
<i>Arilus</i> sp.	2209	UCR_ENT 00005042	UCR	Colombia: Meta	JQ888390	JQ888734	–	JQ888548	JQ889025
<i>Arilus</i> sp.	724	UCR_ENT 00051658	UCR	Costa Rica: Guanacaste	JQ888391	JQ888735	–	JQ888549	–
<i>Atopozelus</i> sp.	2180	UCR_ENT 00005013	UCR	Colombia: Meta	–	–	–	JQ888550	JQ889026
<i>Atopozelus</i> sp.	2181	UCR_ENT 00005014	UCR	Colombia: Valle del Cauca	JQ888392	JQ888736	JQ888897	JQ888551	–
<i>Atopozelus</i> sp.	649	UCR_ENT 00001514	UCR	Ecuador: Guayas	JQ888393	JQ888737	JQ888898	JQ888552	JQ889027

<i>Atrachelus</i> sp.	2015	UCR_ENT 00051670	UCR	Argentina: Catamarca	JQ888394	JQ888738	JQ888899	JQ888553	JQ889028
<i>Atrachelus</i> sp.	2109	UCR_ENT 00004187	UCR	French Guiana: Roura	JQ888395	JQ888739	–	JQ888554	JQ889029
<i>Atrachelus</i> sp.	633	UCR_ENT 00051669	UCR	Ecuador	JQ888396	–	–	–	–
<i>Atrachelus</i> sp.	634	UCR_ENT 00051668	UCR	Ecuador: Morona- Santiago	JQ888397	JQ888740	JQ888900	JQ888555	JQ889030
<i>Authenta</i> sp.	1858	UCR_ENT 00003996	UCR	D. R. Congo: Orientale	JQ888398	JQ888741	JQ888901	JQ888556	JQ889031
<i>Bequaertidea</i> sp.	2745	UCR_ENT 00004539	UCR	Malawi: Mangochi	JQ888399	JQ888742	JQ888902	–	JQ889032
<i>Biasticus</i> sp.	2651	UCR_ENT 00004467	UCR	Thailand: Nakhon Nayok	JQ888400	JQ888743	JQ888903	JQ888558	–
cf. <i>Blapton</i>	2673	UCR_ENT 00019763	CAS	Madagascar: Fianarantsoa	–	–	–	JQ888565	JQ889038
<i>Campsolomus</i> sp.	2706	UCR_ENT 00043565	UCR	Papua New Guinea: Morobe	–	JQ888744	–	JQ888559	–
cf. <i>Castolus</i>	2280	UCR_ENT 00005122	UCR	Colombia: Meta	JQ888401	JQ888751	JQ888909	JQ888566	JQ889039
cf. <i>Castolus</i>	2468	UCR_ENT 00004376	UCR	Colombia: Meta	JQ888402	JQ888752	JQ888910	JQ888567	JQ889040
<i>Castolus ferox</i> (Banks 1910)	716	UCR_ENT 00001500	UCR	USA: Arizona	JQ888403	JQ888745	JQ888904	JQ888560	JQ889033
<i>Castolus</i> sp.	1097	UCR_ENT 00002493	UCR	Mexico: Oaxaca	JQ888404	JQ888746	JQ888905	JQ888561	JQ889034
<i>Castolus</i> sp.	1445	UCR_ENT 00002769	UCR	Ecuador: Santo Domingo	JQ888405	JQ888747	JQ888906	JQ888562	–
<i>Castolus</i> sp.	2283	UCR_ENT 00004200	UCR	Costa Rica: Guanacaste	JQ888406	JQ888748	JQ888907	JQ888563	JQ889035
<i>Castolus</i> sp.	2349	UCR_ENT 00005146	UCR	Mexico: Sonora	JQ888407	JQ888749	JQ888908	–	JQ889036

<i>Catasphactes</i> sp.	207	UCR_ENT 00001513	UCR	Australia: Western Australia	JQ888408	JQ888750	–	JQ888564	JQ889037
<i>Cleptria corallina</i> Villiers	14	AMNH_PBI 00218770	UCR	Guinea-Bissau	*FJ230388	*FJ230543	*FJ230621 *FJ230700	JQ888569	JQ889042
<i>Coliniella</i> sp.	2746	UCR_ENT 00004608	UCR	Malawi	JQ888409	JQ888754	–	JQ888570	JQ889043
<i>Coranus callosus</i> Stål	244	AMNH_PBI 00218984	UCR	Australia: Western Australia	*FJ230433	*FJ230594	*FJ230669 *FJ230748	JQ888571	JQ889044
<i>Coranus</i> sp.	2038	UCR_ENT 00004130	UCR	Brunei	JQ888410	–	JQ888911	JQ888572	JQ889045
<i>Coranus</i> sp.	236	UCR_ENT 00001510	UCR	Australia: South Australia	JQ888411	JQ888756	JQ888912	JQ888573	JQ889046
<i>Coranus</i> sp.	752	UCR_ENT 00001530	UCR	Nigeria: Ondo	JQ888412	–	–	JQ888574	JQ889047
<i>Corcia columbica</i> Stål	1459	UCR_ENT 00002782	UCR	Ecuador: Napo	JQ888413	JQ888757	JQ888913	JQ888575	JQ889048
<i>Corcia</i> sp.	2075	UCR_ENT 00004153	UCR	Ecuador: Sucumbios	JQ888414	JQ888758	JQ888914	JQ888576	JQ889049
<i>Cosmoclopius</i> sp.	2016	UCR_ENT 00004944	UCR	Argentina: Catamarca	JQ888415	JQ888759	JQ888915	JQ888577	JQ889050
<i>Cosmoclopius</i> sp.	2017	UCR_ENT 00051662	UCR	Argentina: Catamarca	JQ888416	JQ888760	–	JQ888578	JQ889051
<i>Cosmolestes</i> sp.	366	UCR_ENT 00001507	UCR	Singapore	JQ888417	JQ888761	–	JQ888579	–
<i>Cosmolestes</i> sp.	654	UCR_ENT 00051664	UCR	Kenya	–	JQ888762	JQ888916	JQ888580	JQ889052
<i>Ctenotrachelus</i> sp.	166	UCR_ENT 00000181	UCR	Costa Rica	*FJ230415	*FJ230575	*FJ230652 *FJ230731	–	–
<i>Cydnocoris russatus</i> Stål <sup>3</sup>	–	–	–	China	*EU128697	–	*EU12868	*EU128708	–
<i>Debilis</i> sp.	2078	UCR_ENT 00004156	UCR	Ecuador: Orellana	JQ888418	JQ888763	JQ888917	JQ888581	JQ889053

<i>Debilis</i> sp.	2089	UCR_ENT 00004167	UCR	French Guiana: Roura	–	JQ888764	JQ888918	JQ888582	JQ889054
<i>Debilis</i> sp.	2774	UCR_ENT 00004614	UCR	Bolivia: Santa Cruz	JQ888419	JQ888765	JQ888919	JQ888583	–
<i>Doldina</i> sp.	2870	UCR_ENT 00038863	UNAM	Mexico: Campeche	–	JQ888766	–	JQ888584	–
<i>Ectomocoris atrox</i> (Stål)	363	UCR_ENT 00000088	UCR	Singapore	*FJ230447	–	*FJ230682 *FJ230761	–	–
<i>Ectrychotes</i> sp.	76	AMNH_PBI 00218830	UCR	Malaysia: Johor	–	*FJ230560	*FJ230638 *FJ230717	–	–
<i>Emesaya incisa</i> (McAtee and Malloc)	282	AMNH_PBI 00219017	UCR	USA: California	*FJ230436	*FJ230598	*FJ230672 *FJ230751	JQ888585	JQ889055
<i>Endochus</i> sp.	1234	UCR_ENT 00002578	UCR	Australia: Western Australia	JQ888420	JQ888767	JQ888920	JQ888586	JQ889056
<i>Endochus</i> sp.	2661	UCR_ENT 00019754	UCR	Madagascar: Fianarantsoa	JQ888421	JQ888768	JQ888921	JQ888587	JQ889057
<i>Endochus</i> sp.	2667	UCR_ENT 00004472	UCR	Thailand: Phetchabun	JQ888422	JQ888769	JQ888922	JQ888588	JQ889058
<i>Endochus</i> sp.	2748	UCR_ENT 00004536	UCR	Malawi: Mangochi	JQ888423	JQ888770	JQ888923	JQ888589	JQ889059
<i>Endochus</i> sp.	2775	UCR_ENT 00004615	UCR	Cameroon: Adamaoua	JQ888424	JQ888771	JQ888924	JQ888590	JQ889060
<i>Endochus</i> sp.	2788	UCR_ENT 00004627	UCR	Zambia: Copperbelt	JQ888425	JQ888772	JQ888925	JQ888591	JQ889061
<i>Endochus</i> sp.	2813	UCR_ENT 00004652	UCR	Cameroon: Adamaoua	JQ888426	JQ888773	JQ888926	–	JQ889062
<i>Endochus</i> sp.	2818	UCR_ENT 00004657	UCR	Cameroon: Adamaoua	JQ888427	JQ888774	JQ888927	JQ888592	–
<i>Epidaus</i> sp.	2039	UCR_ENT 00004131	UCR	Brunei	JQ888428	JQ888775	JQ888928	JQ888593	JQ889063
<i>Epidaus</i> sp.	679	UCR_ENT 00004763	UCR	Malaysia: Terengganu	JQ888429	–	JQ888929	JQ888594	JQ889064

<i>Erbessus</i> sp.	33	UCR_ENT 00001498	UCR	French Guiana	JQ888430	JQ888776	JQ888930	JQ888595	–
<i>Euagoras</i> sp.	1297	UCR_ENT 00002631	UCR	Singapore	JQ888431	JQ888777	–	JQ888596	JQ889065
<i>Euagoras</i> sp.	194	UCR_ENT 00004760	UCR	Malaysia: Selangor	*FJ230427	*FJ230587	*FJ230663 *FJ230742	JQ888597	JQ889066
<i>Euagoras</i> sp.	2787	UCR_ENT 00004626	UCR	Australia: Queensland	–	JQ888778	JQ888931	JQ888598	JQ889067
<i>Eulyes</i> sp.	1996	UCR_ENT 00004113	UCR	Brunei	JQ888432	JQ888779	JQ888932	JQ888599	JQ889068
<i>Gminatus</i> sp.	1238	UCR_ENT 00002581	UCR	Australia: Western Australia	JQ888433	JQ888780	JQ888933	JQ888600	JQ889069
<i>Graptocleptes</i> sp.	2626	UCR_ENT 00004429	UCR	Peru: Loreto	JQ888434	JQ888781	JQ888934	JQ888601	JQ889070
<i>Graptocleptes</i> sp.	2628	UCR_ENT 00004431	UCR	Peru: Loreto	JQ888435	JQ888782	JQ888935	JQ888602	JQ889071
<i>Graptocleptes</i> sp.	2632	UCR ENT 44412	UCR	Peru: Madre de Dios	JQ888436	JQ888783	JQ888936	JQ888603	JQ889072
<i>Hagia</i> sp.	81	UCR_ENT 00004759	UCR	Singapore	JQ888437	JQ888784	JQ888937	–	JQ889073
<i>Harpactor</i> sp.	2778	UCR_ENT 00004661	UCR	Bolivia: Santa Cruz	JQ888438	JQ888785	JQ888938	JQ888604	–
<i>Harpactorini</i> sp.	190	AMNH_PBI 00218934	UCR	Malaysia: Selangor/Pahang boarder	*FJ230425	*FJ230585	*FJ230662 *FJ230741	–	JQ889074
<i>Harpactorini</i> sp.	2464	UCR_ENT 00019741	CAS	Madagascar: Fianarantsoa	JQ888439	JQ888786	–	JQ888605	JQ889075
<i>Harpactorini</i> sp.	2475	UCR ENT 44350	UCR	Peru: Madre de Dios	JQ888440	JQ888787	JQ888939	JQ888606	JQ889076
<i>Harpactorini</i> sp.	2655	UCR_ENT 00019749	CAS	Madagascar: Antsiranana	–	JQ888788	–	JQ888607	–
<i>Harpactorini</i> sp.	2663	UCR_ENT 00019748	CAS	Madagascar: Mahajanga	–	JQ888789	–	JQ888608	–

<i>Harpagocoris</i> sp.	2776	UCR_ENT 00004616	UCR	Zambia: North- Western	JQ888441	JQ888790	JQ888940	JQ888609	JQ889077
<i>Harpagocoris</i> sp.	2784	UCR_ENT 00004623	UCR	Zambia: Copperbelt	JQ888442	JQ888791	JQ888941	JQ888610	JQ889078
<i>Harpagocoris</i> sp.	2785	UCR_ENT 00004624	UCR	Zambia: Copperbelt	JQ888443	JQ888792	JQ888942	JQ888611	JQ889079
<i>Hartzelus</i> sp.	2681	UCR_ENT 00030114	USNM	Ecuador: Orellana	–	JQ888793	–	JQ888612	–
<i>Hartzelus</i> sp.	2862	UCR_ENT 00004769	UCR	Ecuador: Orellana	JQ888444	–	–	JQ888613	–
<i>Hartzelus</i> sp.	2867	UCR_ENT 00030115	USNM	Ecuador: Orellana	–	JQ888794	JQ888943	–	–
<i>Havinthus</i> sp.	211	UCR_ENT 00001515	UCR	Australia: Western Australia	JQ888445	JQ888795	JQ888944	JQ888614	–
<i>Hediocoris</i> sp.	656	UCR_ENT 00001528	UCR	South Africa: North West	JQ888446	JQ888796	JQ888945	JQ888615	–
<i>Heniartes putumayo</i> (Wygodzinsky)	395	UCR_ENT 00000079	FCAP	South America	–	*FJ230609	*FJ230686 *FJ230766	JQ888616	–
<i>Heza aurantia</i> Maldonado	637	UCR_ENT 00001095	UCR	Peru: Loreto	JQ888447	JQ888797	JQ888946	JQ888617	JQ889080
<i>Heza ephippium</i> (Lichtenstein)	635	UCR_ENT 00001096	UCR	Ecuador: Loja	JQ888448	JQ888798	JQ888947	JQ888618	JQ889081
<i>Heza similis</i> (Stål)	113	UCR_ENT 00001094	UCR	Mexico: Chihuahua	JQ888449	JQ888799	JQ888948	JQ888619	JQ889082
<i>Heza</i> sp.	2087	UCR_ENT 00004165	UCR	French Guiana: Regina	JQ888450	JQ888800	JQ888949	JQ888620	JQ889083
<i>Heza</i> sp.	2202	UCR_ENT 00005035	UCR	Colombia: Valle del Cauca	–	–	–	JQ888621	–
<i>Heza</i> sp.	2780	UCR_ENT 00004811	UCR	Nicaragua: Matagalpa	JQ888451	JQ888801	–	JQ888622	–
<i>Heza</i> sp.	2810	UCR_ENT 00004649	UCR	Nicaragua: Rio San Juan	JQ888452	JQ888802	JQ888950	JQ888623	JQ889084

<i>Hiranelis</i> sp.	1988	UCR_ENT 00004092	UCR	French Guiana: Roura	JQ888453	JQ888803	JQ888951	JQ888624	JQ889085
<i>Irantha</i> sp.	2713	UCR_ENT 00004477	UCR	Brunei	JQ888454	JQ888804	–	JQ888625	JQ889086
<i>Irantha</i> sp.	676	UCR_ENT 00005147	UCR	Singapore [?]	–	JQ888805	–	JQ888626	–
<i>Ischnoclopius</i> sp.	2679	UCR_ENT 00009253	USNM	Ecuador: Orellana	–	JQ888806	–	JQ888627	–
<i>Isocondylus</i> sp.	653	UCR_ENT 00001509	UCR	Honduras: Cortes	JQ888455	–	–	JQ888628	–
<i>Isyndus reticulatus</i> Stål <sup>3</sup>	–	–	–	–	*AY127038	–	–	–	*FJ851781
<i>Isyndus</i> sp.	1997	UCR_ENT 00004114	UCR	China: Yunnan	JQ888456	JQ888807	JQ888952	JQ888629	JQ889087
<i>Leogorrus litura</i> (Fabricius) <sup>1</sup>	9	AMNH_PBI 00218765	UCR	Dominican Republic	*FJ230386	*FJ230540	*FJ230618 *FJ230697	–	JQ889088
<i>Lisarda</i> sp.	78	AMNH_PBI 00218832	UCR	Singapore	*FJ230404	*FJ230561	*FJ230639 *FJ230718	–	–
<i>Macracanthopsis</i> sp.	2650	UCR_ENT 00004466	UCR	Thailand: Nakhon Nayok	JQ888457	JQ888808	–	JQ888630	JQ889089
<i>Margasus</i> sp.	1860	UCR_ENT 00003998	UCR	D. R. Congo: Orientale	JQ888458	JQ888809	JQ888953	JQ888631	JQ889090
<i>Margasus</i> sp.	722	UCR_ENT 00001506	UCR	Nigeria: Ondo	JQ888459	JQ888810	JQ888954	JQ888632	JQ889091
<i>Micrauchenus lineola</i> (Fabricius)	35	AMNH_PBI 00218790	UCR	French Guiana	*FJ230397	*FJ230552	*FJ230630 *FJ230709	–	–
<i>Montina</i> sp.	1401	UCR_ENT 00002725	UCR	Ecuador: Napo	JQ888460	JQ888811	JQ888955	JQ888633	JQ889092
<i>Montina</i> sp.	2198	UCR_ENT 00005031	UCR	Colombia: Meta	JQ888461	JQ888812	JQ888956	JQ888634	JQ889093
<i>Myocoris</i> sp.	1987	UCR_ENT 00004091	UCR	French Guiana: Regina	JQ888462	JQ888813	JQ888957	JQ888635	–
<i>Myocoris</i> sp.	2214	UCR_ENT 00005056	UCR	Colombia: Cundinamarca	JQ888463	JQ888814	JQ888958	JQ888636	JQ889094

<i>Nagusta</i> sp.	2664	UCR_ENT 00019755	CAS	Madagascar: Antsiranana	JQ888464	JQ888815	JQ888959	JQ888637	–
<i>Neotropiconyttus</i> sp.	2211	UCR_ENT 00005044	UCR	Colombia: Meta	JQ888465	JQ888816	JQ888960	JQ888638	JQ889095
<i>Notocyrtus camelus</i> Stål	2103	UCR_ENT 0004181	UCR	French Guiana	JQ888466	JQ888817	–	JQ888639	JQ889096
<i>Noualhierana furtiva</i> Miller	224	AMNH_PBI 00218966	UCR	Australia: New South Wales	*FJ230432	*FJ230592	*FJ230668 *FJ230747	–	–
<i>Odontogonus</i> sp.	2812	UCR_ENT 00004651	UCR	Cameroon: Adamaoua	JQ888467	JQ888818	JQ888961	JQ888640	JQ889097
<i>Oncocephalus</i> sp.	79	UCR_ENT 00000182	UCR	Singapore	*FJ230405	*FJ230562	*FJ230640 *FJ230719	–	–
<i>Pantoleistes</i> sp.	3	UCR_ENT 00001497	UCR	South Africa: Limpopo	JQ888468	JQ888819	–	JQ888641	JQ889098
<i>Paraplynus lugubris</i> (Stål) <sup>1</sup>	179	AMNH_PBI 00218923	UCR	Guinea-Bisseau	*FJ230420	*FJ230580	*FJ230657 *FJ230736	–	–
<i>Paratriatoma hirsuta</i> Barber	296	AMNH_PBI 00218745	UCR	USA: California	*FJ230443	*FJ230604	*FJ230676 *FJ230755	–	–
<i>Paredocla chevalieri</i> Jeannel	18	AMNH_PBI 00218774	UCR	Senegal	*FJ230391	*FJ230546	*FJ230623 *FJ230702	–	–
<i>Peirates punctorius</i> (Stål)	216	AMNH_PBI 00218960	UCR	Australia: New South Wales	*FJ230430	*FJ230590	*FJ230666 *FJ230745	JQ888642	JQ889099
<i>Phonoctonus</i> sp.	2120	UCR_ENT 00051666	UCR	Nigeria: Osun	JQ888469	–	JQ888962	JQ888643	JQ889100
<i>Cnizocoris</i> sp.	2851	UCR_ENT 00004817	UCR	China: Yunnan	JQ888470	JQ888820	JQ888963	JQ888644	–
<i>Pirnonota convexicollis</i> Stål	2476	UCR ENT 44315	UCR	Peru: Madre de Dios	JQ888471	JQ888821	JQ888964	–	JQ889101
<i>Platyeris biguttata</i> (Linne)	175	AMNH_PBI 218919	UCR	Guinea-Bisseau	*FJ230418	*FJ230578	*FJ230655 *FJ230734	–	–
<i>Ploeogaster</i> sp.	2063	UCR_ENT 00004142	UCR	Ecuador: Orellana	JQ888472	–	–	JQ888645	JQ889102
<i>Ploeogaster</i> sp.	2097	UCR_ENT 00004175	UCR	French Guiana: Regina	JQ888473	JQ888822	–	JQ888646	JQ889103



<i>Ploeogaster</i> sp.	2809	UCR_ENT 00004648	UCR	Costa Rica: Heredia	–	JQ888823	JQ888965	JQ888647	JQ889104
<i>Ploeogaster</i> sp.	2859	UCR_ENT 00030673	USNM	Ecuador: Orellana	–	JQ888824	JQ888966	–	–
<i>Ploeogaster</i> sp.	636	UCR_ENT 00001516	UCR	Peru: Loreto	JQ888474	JQ888825	JQ888967	–	JQ889105
<i>Ploiaria hirticornis</i> (N. Banks)	54	AMNH_PBI 00218808	UCR	Mexico: Sonora	–	*FJ230556	*FJ230634 *FJ230713	–	–
<i>Poecilobdallus gratiosus</i> (Stål) <sup>1</sup>	214	AMNH_PBI 00218958	UCR	Australia: Western Australia	*FJ230429	*FJ230589	*FJ230665 *FJ230744	–	–
<i>Polididus</i> sp.	2036	UCR_ENT 00004128	UCR	Brunei	JQ888475	JQ888826	JQ888968	JQ888648	JQ889106
<i>Polididus</i> sp.	650	UCR_ENT 00001511	UCR	Laos: Vientane	JQ888476	–	JQ888969	JQ888649	JQ889107
<i>Pristhesancus</i> sp.	2796	UCR_ENT 00004635	UCR	Australia: Queensland	JQ888477	JQ888827	JQ888970	JQ888650	–
<i>Pselliopus</i> sp.	123	AMNH_PBI 00218876	UCR	Mexico: Chihuahua	JQ888478	JQ888828	–	JQ888651	JQ889108
<i>Pselliopus</i> sp.	2205	UCR_ENT 00005038	UCR	Colombia: Valle del Cauca	JQ888479	JQ888829	–	–	JQ889109
<i>Pselliopus zebra</i> (Stål)	280	AMNH_PBI 00219015	UCR	Guatemala: Sacatepequez	*FJ230434	*FJ230596	*FJ230670 *FJ230749	JQ888654	JQ889112
<i>Pselliopus spinicollis</i> (Champion)	284	AMNH_PBI 00219019	UCR	USA: California	*FJ230438	*FJ230600	–	JQ888653	JQ889111
<i>Pselliopus</i> sp.	938	UCR_ENT 00003225	UCR	Mexico: Chiapas	JQ888480	JQ888830	–	JQ888652	JQ889110
<i>Pyrrhosphodrus amazonus</i> (Champion)	31	AMNH_PBI 00218786	UCR	USA: California	*FJ230396	*FJ230551	*FJ230629 *FJ230708	JQ888655	JQ889113
<i>Racelda</i> sp.	41	AMNH_PBI 00218801	UCR	French Guiana: Approuague-Kaw	*FJ230398	*FJ230553	*FJ230631 *FJ230710	–	–

<i>cf. Rapipta</i>	2091	UCR_ENT 00004169	UCR	French Guiana: Regina	JQ888483	JQ888753	–	JQ888568	JQ889041
<i>Rapipta</i> sp.	1425	UCR_ENT 00002749	UCR	Ecuador: Napo	JQ888484	JQ888831	–	JQ888656	JQ889114
<i>Rapipta</i> sp.	2076	UCR_ENT 00004154	UCR	Ecuador: Sucumbios	JQ888485	JQ888832	JQ888971	–	JQ889115
<i>Rapipta</i> sp.	2084	UCR_ENT 00004162	UCR	French Guiana: Regina	–	JQ888833	JQ888972	JQ888657	JQ889116
<i>Rapipta</i> sp.	2090	UCR_ENT 00004168	UCR	French Guiana: Regina	JQ888486	JQ888834	–	JQ888658	JQ889117
<i>Rapipta</i> sp.	2096	UCR_ENT 00004174	UCR	French Guiana: Regina	–	JQ888835	JQ888973	JQ888659	JQ889118
<i>Rapipta</i> sp.	2275	UCR_ENT 00005117	UCR	Colombia: Valle del Cauca	JQ888487	JQ888836	JQ888974	JQ888660	JQ889119
<i>Rapipta</i> sp.	2477	UCR ENT 00044289	UCR	Peru: Madre de Dios	JQ888488	JQ888837	JQ888975	JQ888661	JQ889120
<i>Rapipta</i> sp.	632	UCR_ENT 00051667	UCR	Ecuador: Loja	JQ888489	JQ888838	JQ888976	JQ888662	–
<i>Rapipta taurus</i> (Fabricius)	2029	UCR_ENT 00004120	UCR	USA: Florida	JQ888490	JQ888839	JQ888977	JQ888663	JQ889121
<i>Rhaphidosomini</i> sp.	2736	UCR_ENT 00004610	UCR	Malawi: Rumphu	JQ888491	JQ888840	JQ888978	JQ888664	JQ889122
<i>Rhaphidosomini</i> sp.	2743	UCR_ENT 00004565	UCR	Malawi: Mangochi	JQ888492	JQ888841	JQ888979	JQ888665	JQ889123
<i>Rhaphidosomini</i> sp.	2747	UCR_ENT 00004605	UCR	Malawi: Mzimba	JQ888493	JQ888842	–	–	–
<i>Rhiginia</i> sp.	139	AMNH_PBI 00218801	UCR	Nicaragua: Granada	*FJ230410	*FJ230571	*FJ230648 *FJ230727	–	–
<i>Rhynocoris</i> <i>segmentarius</i> (Germar)	4	UCR_ENT 00218760	UCR	South Africa: Limpopo	*FJ230384	*FJ230538	*FJ230616 *FJ230695	JQ888666	JQ889124
<i>Rhynocoris</i> sp.	1842	UCR_ENT 00003979	UCR	Brunei	JQ888494	JQ888843	–	JQ888667	JQ889125

<i>Rhynocoris</i> sp.	1853	UCR_ENT 00003991	UCR	D. R. Congo: Orientale	JQ888495	JQ888844	–	JQ888668	JQ889126
<i>Rhynocoris</i> sp.	1855	UCR_ENT 00003993	UCR	D. R. Congo: Orientale	JQ888496	JQ888845	–	JQ888669	JQ889127
<i>Rhynocoris</i> sp.	1859	UCR_ENT 00003997	UCR	D. R. Congo: Orientale	JQ888497	JQ888846	JQ888980	JQ888670	JQ889128
<i>Rhynocoris</i> sp.	1865	UCR_ENT 00004001	UCR	Brunei	JQ888498	JQ888847	JQ888981	JQ888671	JQ889129
<i>Rhynocoris</i> sp.	1911	UCR_ENT 00004943	UCR	Brunei	JQ888499	JQ888848	JQ888982	JQ888672	–
<i>Rhynocoris</i> sp.	1998	UCR_ENT 00004115	UCR	China: Yunnan	JQ888500	JQ888849	JQ888983	JQ888673	–
<i>Rhynocoris</i> sp.	2755	UCR_ENT 00004557	UCR	Malawi	JQ888501	JQ888850	JQ888984	JQ888674	JQ889130
<i>Rhynocoris</i> sp.	467	UCR_ENT 00004762	UCR	Thailand: Ubon Ratchathani	–	JQ888851	JQ888985	JQ888675	–
<i>Rhynocoris</i> sp.	720	UCR_ENT 00001508	UCR	Nigeria: Ondo	JQ888502	JQ888852	JQ888986	JQ888676	JQ889131
<i>Rhynocoris ventralis</i> Hahn	2072	UCR_ENT 00004150	UCR	USA: California	JQ888503	JQ888853	–	JQ888677	–
<i>Ricolla quadrispinosa</i> (Linne)	396	UCR_ENT 00000075	FCAP	Brazil: Mato Grosso	–	*FJ230610	*FJ230687 –	JQ888678	–
<i>Ricolla</i> sp.	1247	UCR_ENT 00012923	UCR	Peru: Loreto	JQ888504	JQ888854	–	JQ888679	JQ889132
<i>Rocconota</i> sp.	2216	UCR_ENT 00005054	UCR	Colombia: Valle del Cauca	JQ888505	JQ888855	–	JQ888680	JQ889133
<i>Rocconota</i> sp.	279	UCR_ENT 00001499	UCR	Nicaragua: Granada	JQ888506	JQ888856	JQ888987	–	JQ889134
<i>Sastrapada</i> sp.	185	AMNH_PBI 00218929	UCR	Malaysia: Selangor	*FJ230423	*FJ230583	*FJ230660 *FJ230739	–	–
<i>Sinea diadema</i> Caudell	108	AMNH_PBI 00218861	UCR	Mexico: Chihuahua	*FJ230408	*FJ230566	*FJ230644 *FJ230723	JQ888681	JQ889135

<i>Sinea</i> sp.	1012	UCR_ENT 00003145	UCR	Mexico: Veracruz	JQ888507	JQ888857	–	JQ888682	JQ889136
<i>Sinea</i> sp.	2083	UCR_ENT 00004161	UCR	USA: Texas	JQ888508	JQ888858	–	JQ888683	JQ889137
<i>Sinea</i> sp.	489	UCR_ENT 00051665	UCR	Costa Rica: Guanacaste	JQ888509	JQ888859	–	JQ888684	JQ889138
<i>Sinea</i> sp.	899	UCR_ENT 00051663	UCR	Mexico: Baja California Norte	JQ888510	JQ888860	–	JQ888685	JQ889139
<i>Sphedanolestes</i> sp.	1194	UCR_ENT 00002550	UCR	Thailand: Phetchabun	JQ888511	JQ888861	JQ888988	JQ888686	–
<i>Sphedanolestes</i> sp.	15	AMNH_PBI 00218711	UCR	Guinea-Bissau	–	JQ888862	JQ888989	JQ888687	JQ889140
<i>Sphedanolestes</i> sp.	1999	UCR_ENT 00004116	UCR	China: Yunnan	JQ888512	JQ888863	JQ888990	JQ888688	JQ889141
<i>Sphedanolestes</i> sp.	2028	UCR_ENT 00004119	UCR	Brunei	JQ888513	–	JQ888991	JQ888689	JQ889142
<i>Sphedanolestes</i> sp.	2479	UCR_ENT 00051660	UCR	Thailand: Prachuab Khiri Khan	–	JQ888864	JQ888992	–	JQ889143
<i>Sphedanolestes</i> sp.	2656	UCR_ENT 00019758	CAS	Madagascar: Antsiranana	–	JQ888865	JQ888993	JQ888690	–
<i>Sphedanolestes</i> sp.	2660	UCR_ENT 00019753	CAS	Madagascar: Toliara	–	JQ888866	JQ888994	JQ888691	–
<i>Sphedanolestes</i> sp.	2674	UCR_ENT 00019764	CAS	Madagascar: Fianarantsoa	–	JQ888867	JQ888995	JQ888692	–
<i>Sphedanolestes</i> sp.	2704	UCR_ENT 00046576	CAS	Madagascar: Fianarantsoa	–	–	–	JQ888693	JQ889144
<i>Sphedanolestes</i> sp.	2709	UCR_ENT 00019767	CAS	Madagascar: Toliara	JQ888514	JQ888868	–	JQ888694	–
<i>Sphedanolestes</i> sp.	2739	UCR_ENT 00004611	UCR	Malawi: Mzimba	JQ888515	JQ888869	JQ888996	JQ888695	JQ889145
<i>Sphedanolestes</i> sp.	655	UCR_ENT 00001518	UCR	Nigeria: Ondo	–	JQ888870	JQ888997	JQ888696	–

<i>Stenolemoides arizonensis</i> (N. Banks)	304	AMNH_PBI 00218753	UCR	USA: California	*FJ230444	*FJ230605	*FJ230677 *FJ230756	–	–
<i>Stenolemus</i> sp.	147	AMNH_PBI 00218899	UCR	Ecuador: Pichincha	*FJ230413	*FJ230573	–	–	–
<i>Stenopoda</i> sp.	154	AMNH_PBI 00218904	UCR	Nicaragua: Granada	*FJ230414	*FJ230574	*FJ230651 *FJ230730	–	JQ889146
<i>Sycanus</i> sp.	1891	UCR_ENT 00004024	UCR	Brunei	JQ888516	JQ888871	JQ888998	JQ888697	JQ889147
<i>Tapeinus</i> sp.	183	AMNH_PBI 00218927	UCR	Malaysia: Pahang	*FJ230421	*FJ230581	*FJ230658 *FJ230737	JQ888698	JQ889148
<i>Triatoma recurva</i> (Stål)	170	AMNH_PBI 00218913	UCR	Mexico: Sonora	*FJ230417	*FJ230577	*FJ230654 *FJ230733	JQ888699	–
<i>Tribelocephala peyrierasi</i> Villiers	287	AMNH_PBI 00219033	CAS	Madagascar: Mahajanga	*FJ230440	*FJ230601	–	–	–
<i>Ulpinus grandituber</i> Bergroth <sup>1</sup>	370	UCR_ENT 00000086	CAS	Madagascar: Toliara	*FJ230449	–	*FJ230684 *FJ230763	JQ888700	JQ889149
<i>Velinus</i> sp.	197	UCR_ENT 00004761	UCR	Malaysia: Pahang	*FJ230428	*FJ230588	*FJ230664 *FJ230743	JQ888701	JQ889150
<i>Velinus</i> sp.	2714	UCR_ENT 00004473	UCR	Thailand: Loei	JQ888517	JQ888872	–	JQ888702	JQ889151
<i>Vesbius purpureus</i> (Thunberg)	184	UCR_ENT 00001523	UCR	Malaysia: Pahang	*FJ230422	*FJ230582	*FJ230659 *FJ230737	JQ888703	JQ889152
<i>Vestula</i> sp.	2817	UCR_ENT 00004656	UCR	Cameroon: Southwest	JQ888518	JQ888873	JQ888999	JQ888704	JQ889153
<i>Vestula</i> sp.	657	UCR_ENT 00001501	UCR	Nigeria: Ondo	JQ888519	JQ888874	JQ889000	JQ888705	JQ889154
<i>Vitumnus</i> sp.	2786	UCR_ENT 00004625	UCR	Zambia: North- Western	JQ888520	JQ888875	JQ889001	JQ888706	JQ889155
<i>Xystonyttus</i> sp.	2213	UCR_ENT 00005057	UCR	Colombia: Meta	JQ888521	JQ888876	JQ889002	JQ888707	JQ889156
<i>Zelurus petax</i> (Breddin)	167	AMNH_PBI 00218911	UCR	Ecuador: Pichincha	*FJ230416	*FJ230576	*FJ230653 *FJ230732	JQ888708	–

<i>Zelus annulosus</i> (Stål)	2098	UCR_ENT 00004176	UCR	French Guiana: Roura	JQ888522	JQ888877	–	JQ888709	JQ889157
<i>Zelus araneiformis</i> Haviland	2281	UCR_ENT 00005123	UCR	French Guiana: Roura	JQ888523	JQ888878	JQ889003	JQ888710	JQ889158
<i>Zelus armillatus</i> (Lepeletier and Serville)	2163	UCR_ENT 00004996	UCR	Colombia: Meta	JQ888524	JQ888879	JQ889004	JQ888711	JQ889159
<i>Zelus cervicalis</i> Stål	115	UCR_ENT 00001505	UCR	Mexico: Sonora	JQ888525	JQ888880	JQ889005	JQ888712	JQ889160
<i>Zelus errans</i> Fabricius	2474	UCR_ENT 00044265	UCR	Peru: Madre de Dios	–	JQ888881	JQ889006	JQ888713	JQ889161
<i>Zelus grassans</i> Stål	584	UCR_ENT 00001211	UCR	Costa Rica: Guanacaste	JQ888526	JQ888882	JQ889007	JQ888714	JQ889162
<i>Zelus janus</i> Stål	931	UCR_ENT 00003218	UCR	Mexico: Oaxaca	JQ888527	JQ888883	JQ889008	JQ888715	JQ889163
<i>Zelus laticornis</i> (Herrich- Schaeffer)	2165	UCR_ENT 00004998	UCR	Colombia: Meta	JQ888528	–	JQ889009	JQ888716	JQ889164
<i>Zelus longipes</i> (Linne)	6	AMNH_PBI 00218762	UCR	Dominican Republic: Santiago	*FJ230385	*FJ230539	*FJ230617 *FJ230696	JQ888717	JQ889165
<i>Zelus luridus</i> Stål	69	UCR_ENT 00001504	UCR	USA: Rhode Island	JQ888529	JQ888884	JQ889010	JQ888718	JQ889166
<i>Zelus means</i> Fabricius	1400	UCR_ENT 00002724	UCR	Ecuador: Napo	JQ888530	JQ888885	JQ889011	JQ888719	–
<i>Zelus nugax</i> Stål	714	UCR_ENT 00001214	UCR	French Guiana: Montsinery	JQ888531	JQ888886	JQ889012	JQ888720	JQ889167
<i>Zelus panamensis</i> [manuscript name]	2164	UCR_ENT 00004997	UCR	Colombia: Meta	JQ888532	JQ888887	JQ889013	JQ888721	JQ889168
<i>Zelus pedestris</i> Fabricius	629	UCR_ENT 00001215	UCR	Ecuador: Napo	JQ888533	JQ888888	JQ889014	JQ888722	JQ889169
<i>Zelus renardii</i> Kolenati	403	UCR_ENT 00000076	UCR	USA: California	JQ888534	–	JQ889015	JQ888723	JQ889170

<i>Zelus</i> sp.	2095	UCR_ENT 00004173	UCR	French Guiana: Roura	JQ888536	JQ888890	–	JQ888725	JQ889171
<i>Zelus</i> sp.	2684	UCR_ENT 00014321	INBio	Costa Rica: Limon	–	–	–	JQ888726	JQ889172
<i>Zelus</i> sp.	2806	UCR_ENT 00004645	UCR	Nicaragua: Rio San Juan	JQ888537	JQ888891	JQ889017	JQ888727	JQ889173
<i>Zelus</i> sp.	630	UCR_ENT 00001212	UCR	Ecuador: Napo	JQ888538	JQ888892	JQ889018	JQ888728	JQ889174
<i>Zelus tetracanthus</i> Stål	717	UCR_ENT 00051661	UCR	USA: California	JQ888539	–	JQ889019	JQ888729	JQ889175
<i>Zelus versicolor</i> (Herrich-Schaeffer)	43	UCR_ENT 00001210	UCR	French Guiana: Montsinery	JQ888540	JQ888893	JQ889020	JQ888730	JQ889176

\*Downloaded from Genbank. In 'USI' the prefix (UCR\_ENT, AMNH\_PBI) does not indicate depository, which is listed in a separate column.

<sup>1</sup> Taxon name differs from that in Weirauch & Munro (2009) due to identification updates or spelling changes.

<sup>2</sup> Two accession numbers are shown for some taxa because the D3-D5 region of 28S appears as two sequences in Genbank for those taxa.

<sup>3</sup> Taxon not extracted at the authors' lab and no voucher information is available.

Supporting Information 3.3. Measurements of fore femur and data of glands and setae.

Taxon (R_CW No.)	R CW No.	Fore femur width (mm)	Fore femur length (mm)	Body length (mm)	Thickn ess Index= Fore femur length/ width	Relative Length Index=Fore femur length/ Body length	Ln TI	Square rooted RLI	Sticky gland †	Type of setae <sup>2</sup>	Gland & Setae data source <sup>3</sup> (USI)
<i>Acanthaspis</i> sp.	73	1.00	4.80	16.93	4.80	0.28	1.57	0.53	–	–	–
<i>Acanthischium dimidiatum</i> Stål	391	0.83	5.70	13.00	6.87	0.44	1.93	0.66	–	–	–
<i>Acanthischium maculatum</i> Amyot & Serville	2472	0.90	6.00	13.80	6.67	0.43	1.90	0.66	–	–	–
<i>Acanthischium nigrum</i> Stål	2473	0.69	4.70	10.70	6.81	0.44	1.92	0.66	–	–	–
<i>Acholla</i> sp.	347	0.70	4.75	13.33	6.79	0.36	1.91	0.60	0	0	0 (29708) <sup>4</sup>
<i>Agriocoris flavipes</i> (Fabricius)	132	0.35	2.50	8.10	7.14	0.31	1.97	0.56	–	–	–
<i>Agriosphodrus dorhni</i> (Signoret)	2346	0.69	5.50	19.00	7.97	0.29	2.08	0.54	–	–	–
<i>Apiomerus lanipes</i> (Fabricius)	281	1.12	5.80	21.00	5.18	0.28	1.64	0.53	0	0	0 (29745) <sup>4</sup>
<i>Arilus cristatus</i> (Linne)	71	1.18	8.70	25.00	7.37	0.35	2.00	0.59	–	–	–
<i>Arilus</i> sp.	2209	1.50	8.00	28.00	5.33	0.29	1.67	0.53	–	–	–
<i>Arilus</i> sp.	724	1.35	7.50	24.50	5.56	0.31	1.71	0.55	–	–	–
<i>Atopozelus</i> sp.	2180	0.25	3.40	7.50	13.60	0.45	2.61	0.67	–	–	–
<i>Atopozelus</i> sp.	2181	0.25	3.30	7.30	13.20	0.45	2.58	0.67	–	–	–
<i>Atopozelus</i> sp.	656	0.26	3.60	7.30	13.85	0.49	2.63	0.70	1	1	0 (2576) <sup>4</sup>
<i>Atrachelus</i> sp.	2015	0.24	2.60	7.50	10.83	0.35	2.38	0.59	1	1	0 (29710) <sup>4</sup>
<i>Atrachelus</i> sp.	2109	0.25	3.00	7.70	12.00	0.39	2.48	0.62	–	–	–



<i>Atrachelus</i> sp.	633	0.25	3.40	8.00	13.60	0.43	2.61	0.65	–	–	–
<i>Atrachelus</i> sp.	634	0.22	3.25	8.60	14.55	0.38	2.68	0.61	–	–	–
<i>Authenta</i> sp.	1858	0.45	8.70	20.00	19.33	0.44	2.96	0.66	–	–	–
<i>Bequaertidea</i> sp.	2745	0.33	3.70	9.20	11.21	0.40	2.42	0.63	–	–	–
<i>Blasticus</i> sp.	2651	0.42	3.25	9.50	7.74	0.34	2.05	0.58	0	1	1
cf. <i>Blapton</i>	2673	0.47	3.20	11.50	6.81	0.28	1.92	0.53	–	–	–
<i>Campsolomus</i> sp.	2706	0.40	4.60	11.30	11.50	0.41	2.44	0.64	–	–	–
cf. <i>Castolus</i>	2280	0.39	4.25	10.30	10.90	0.41	2.39	0.64	–	–	–
cf. <i>Castolus</i>	2468	0.29	3.85	8.80	13.28	0.44	2.59	0.66	–	–	–
<i>Castolus ferox</i> (Banks)	716	0.40	4.30	11.00	10.75	0.39	2.37	0.63	1	1	0 (3301) <sup>4</sup>
<i>Castolus</i> sp.	1097	0.52	5.00	16.00	9.62	0.31	2.26	0.56	1	1	1
<i>Castolus</i> sp.	1445	0.37	3.10	9.20	8.45	0.34	2.13	0.58	1	1	1
<i>Castolus</i> sp.	2283	0.38	3.25	9.00	8.55	0.36	2.15	0.60	1	1	1
<i>Castolus</i> sp.	2349	0.52	4.30	12.50	8.27	0.34	2.11	0.59	1	1	1
<i>Catasphactes</i> sp.	207	0.33	2.60	7.80	7.90	0.33	2.07	0.58	0	0	1
<i>Cleptria corallina</i> Villiers	14	0.71	3.10	10.60	4.37	0.29	1.47	0.54	–	–	–
<i>Coliniella</i> sp.	2746	0.76	3.70	12.50	4.87	0.30	1.58	0.54	–	–	–
<i>Coranus callosus</i> Stål	244	0.31	1.83	5.80	5.91	0.32	1.78	0.56	–	–	–
<i>Coranus</i> sp.	2038	0.49	2.90	10.00	5.92	0.29	1.78	0.54	–	–	–
<i>Coranus</i> sp.	236	0.32	2.00	7.00	6.30	0.29	1.84	0.53	–	–	–
<i>Coranus</i> sp.	752	0.45	2.80	9.70	6.22	0.29	1.83	0.54	0	0	1
<i>Corcia columbica</i> Stål	1459	0.36	4.00	10.50	11.11	0.38	2.41	0.62	1	1	0 (29248) <sup>4</sup>
<i>Corcia</i> sp.	2075	0.29	3.90	9.90	13.45	0.39	2.60	0.63	–	–	–
<i>Cosmoclopius</i> sp.	2016	0.48	3.65	11.80	7.60	0.31	2.03	0.56	0	0	0 (29249) <sup>4</sup>
<i>Cosmoclopius</i> sp.	2017	0.48	4.00	13.10	8.33	0.31	2.12	0.55	–	–	–
<i>Cosmolestes</i> sp.	366	0.42	4.10	10.00	9.76	0.41	2.28	0.64	0	0	0
<i>Cosmolestes</i> sp.	654	0.50	4.60	12.50	9.20	0.37	2.22	0.61	–	–	–
<i>Ctenotrachelus</i> sp.	166	0.78	4.00	17.10	5.11	0.23	1.63	0.48	–	–	–
<i>Cydnocoris russatus</i> Stål <sup>5</sup>	–	0.44	4.00	12.00	9.09	0.33	2.21	0.58	–	–	–
<i>Debilila</i> sp.	2078	0.39	4.50	11.50	11.54	0.39	2.45	0.63	–	–	–
<i>Debilila</i> sp.	2089	0.34	5.10	10.60	15.00	0.48	2.71	0.69	0	0	1

<i>Debilis</i> sp.	2774	0.48	3.70	13.00	7.71	0.28	2.04	0.53	–	–	–
<i>Doldina</i> sp.	2870	0.45	6.30	15.50	14.00	0.41	2.64	0.64	0	0	1
<i>Ectomocoris atrox</i> (Stål)	363	1.23	4.00	15.73	3.25	0.25	1.18	0.50	0	0	0 (29755) <sup>4</sup>
<i>Ectrychotes</i> sp.	76	0.66	2.35	10.53	3.56	0.22	1.27	0.47	–	–	–
<i>Emesaya incisa</i> (McAtee and Malloc)	282	0.27	6.00	23.47	22.22	0.26	3.10	0.51	–	–	–
<i>Endochus</i> sp.	1234	0.50	5.90	13.50	11.80	0.44	2.47	0.66	0	0	1
<i>Endochus</i> sp.	2661	0.49	5.10	14.00	10.41	0.36	2.34	0.60	–	–	–
<i>Endochus</i> sp.	2667	0.49	4.50	14.30	9.18	0.31	2.22	0.56	–	–	–
<i>Endochus</i> sp.	2748	0.52	4.80	12.70	9.23	0.38	2.22	0.61	–	–	–
<i>Endochus</i> sp.	2775	0.51	5.10	14.50	10.00	0.35	2.30	0.59	–	–	–
<i>Endochus</i> sp.	2788	0.55	5.30	15.00	9.64	0.35	2.27	0.59	–	–	–
<i>Endochus</i> sp.	2813	0.68	6.50	17.70	9.56	0.37	2.26	0.61	–	–	–
<i>Endochus</i> sp.	2818	0.44	5.30	12.80	12.05	0.41	2.49	0.64	–	–	–
<i>Epidaus</i> sp.	2039	0.42	5.90	12.60	14.05	0.47	2.64	0.68	–	–	–
<i>Epidaus</i> sp.	679	0.80	7.50	17.60	9.38	0.43	2.24	0.65	–	–	–
<i>Erbessus</i> sp.	33	1.06	6.20	17.70	5.85	0.35	1.77	0.59	–	–	–
<i>Euagoras</i> sp.	1297	0.38	5.50	12.10	14.47	0.45	2.67	0.67	0	0	0 (2627) <sup>4</sup>
<i>Euagoras</i> sp.	194	0.37	6.30	12.50	17.03	0.50	2.83	0.71	–	–	–
<i>Euagoras</i> sp.	2787	0.48	6.40	14.70	13.33	0.44	2.59	0.66	–	–	–
<i>Eulyes</i> sp.	1996	0.90	8.00	29.00	8.89	0.28	2.18	0.53	–	–	–
<i>Gminatus</i> sp.	1238	0.45	3.90	11.60	8.67	0.34	2.16	0.58	0	0	1
<i>Graptocleptes</i> sp.	2626	0.33	4.10	10.40	12.42	0.39	2.52	0.63	1	1	1
<i>Graptocleptes</i> sp.	2628	0.23	3.60	9.20	15.43	0.39	2.74	0.63	–	–	–
<i>Graptocleptes</i> sp.	2632	0.23	3.60	9.00	15.65	0.40	2.75	0.63	–	–	–
<i>Hagia</i> sp.	81	0.59	4.40	15.00	7.50	0.29	2.01	0.54	0	0	0 (29253) <sup>4</sup>
<i>Harpactor</i> sp.	2778	1.15	7.60	22.50	6.61	0.34	1.89	0.58	0	0	1
<i>Harpactorini</i> sp.	190	0.35	3.00	8.60	8.57	0.35	2.15	0.59	–	–	–
<i>Harpactorini</i> sp.	2464	0.48	6.70	14.10	13.96	0.48	2.64	0.69	–	–	–
<i>Harpactorini</i> sp.	2475	0.45	4.70	12.70	10.44	0.37	2.35	0.61	–	–	–
<i>Harpactorini</i> sp.	2655	0.51	3.25	11.00	6.37	0.30	1.85	0.54	–	–	–
<i>Harpactorini</i> sp.	2663	0.45	2.60	9.30	5.78	0.28	1.75	0.53	–	–	–

<i>Harpagocoris</i> sp.	2776	0.46	3.00	8.50	6.52	0.35	1.88	0.59	–	–	–
<i>Harpagocoris</i> sp.	2784	0.58	3.50	13.80	6.03	0.25	1.80	0.50	–	–	–
<i>Harpagocoris</i> sp.	2785	0.45	3.20	10.30	7.11	0.31	1.96	0.56	–	–	–
<i>Hartzelus</i> sp.	2681	0.21	5.70	10.40	26.72	0.55	3.29	0.74	1	1	1
<i>Hartzelus</i> sp.	2862	0.29	8.40	15.73	28.64	0.53	3.35	0.73	1	1	1
<i>Hartzelus</i> sp.	2867	0.22	3.50	8.40	15.67	0.42	2.75	0.65	1	1	1
<i>Havinthus</i> sp.	211	0.70	4.70	14.00	6.71	0.34	1.90	0.58	0	0	0 (29714) <sup>4</sup>
<i>Hediocoris</i> sp.	656	0.39	4.25	10.00	10.90	0.43	2.39	0.65	0	0	0 (29272) <sup>4</sup>
<i>Heniartes putumayo</i> (Wygodzinsky)	395	0.62	6.00	15.07	9.73	0.40	2.28	0.63	0	0	0 (29744) <sup>4</sup>
<i>Heza aurantia</i> Maldonado	637	0.79	6.90	21.00	8.73	0.33	2.17	0.57	0	2	0
<i>Heza</i> <i>ephippium</i> (Lichtenstein)	635	0.85	8.30	21.00	9.76	0.40	2.28	0.63	1	2	0
<i>Heza similis</i> (Stål)	113	0.66	7.10	17.00	10.80	0.42	2.38	0.65	1	2	0
<i>Heza</i> sp.	2087	0.55	7.00	15.90	12.73	0.44	2.54	0.66	0	0	1
<i>Heza</i> sp.	2202	0.56	7.60	17.70	13.57	0.43	2.61	0.66	1	2	1
<i>Heza</i> sp.	2780	0.46	7.00	15.80	15.22	0.44	2.72	0.67	1	0	1
<i>Heza</i> sp.	2810	1.05	7.90	28.00	7.52	0.28	2.02	0.53	1	2	1
<i>Hirantetis</i> sp.	1988	0.36	5.20	12.00	14.44	0.43	2.67	0.66	–	–	0 (29254) <sup>4</sup>
<i>Irantha</i> sp.	2713	0.50	3.10	9.10	6.20	0.34	1.82	0.58	–	–	–
<i>Irantha</i> sp.	676	0.53	3.30	9.50	6.23	0.35	1.83	0.59	–	–	–
<i>Ischnoclopius</i> sp.	2679	0.20	9.90	13.20	49.50	0.75	3.90	0.87	1	1	1
<i>Isocondylus</i> sp.	653	0.89	9.20	26.80	10.38	0.34	2.34	0.59			1
<i>Isyndus reticulatus</i> Stål <sup>5</sup>	–	0.83	7.00	19.20	8.48	0.36	2.14	0.60	–	–	–
<i>Isyndus</i> sp.	1997	1.10	6.70	21.50	6.09	0.31	1.81	0.56	–	–	–
<i>Leogorrus litura</i> (Fabricius)	9	0.70	2.50	10.50	3.57	0.24	1.27	0.49	0	0	1
<i>Lisarda</i> sp.	78	0.55	3.75	13.47	6.78	0.28	1.91	0.53	0	0	1
<i>Macracanthopsis</i> sp.	2650	0.38	4.10	9.30	10.79	0.44	2.38	0.66	0	0	0 (29256) <sup>4</sup>
<i>Margasus</i> sp.	1860	0.83	9.50	20.00	11.45	0.48	2.44	0.69	–	–	–
<i>Margasus</i> sp.	722	1.10	10.00	26.00	9.09	0.38	2.21	0.62	–	–	–

<i>Micrauchenus lineola</i> (Fabricius)	35	1.20	5.50	17.20	4.58	0.32	1.52	0.57	–	–	–
<i>Montina</i> sp.	1401	0.61	6.30	18.00	10.33	0.35	2.33	0.59	0	0	0 (29257) <sup>4</sup>
<i>Montina</i> sp.	2198	0.55	6.40	15.80	11.64	0.41	2.45	0.64	–	–	–
<i>Myocoris</i> sp.	1987	0.18	3.40	7.80	18.55	0.44	2.92	0.66	–	–	–
<i>Myocoris</i> sp.	2214	0.30	4.10	10.00	13.67	0.41	2.61	0.64	1	1	1
<i>Nagusta</i> sp.	2664	0.44	4.50	11.50	10.23	0.39	2.33	0.63	–	–	–
<i>Neotropiconyttus</i> sp.	2211	0.28	3.20	9.50	11.64	0.34	2.45	0.58	1	1	1
<i>Notocyrtus camelus</i> Stål	2103	0.31	2.40	7.20	7.74	0.33	2.05	0.58	0	0	0 (29259) <sup>4</sup>
<i>Noualhierana furtiva</i> Miller	224	0.53	1.67	7.90	3.17	0.21	1.16	0.46	–	–	–
<i>Odontogonus</i> sp.	2812	0.50	7.30	15.00	14.60	0.49	2.68	0.70	–	–	–
<i>Oncocephalus</i> sp.	79	0.82	3.30	12.00	4.02	0.28	1.39	0.52	0	0	1
<i>Pantolestes</i> sp.	3	1.05	7.60	28.00	7.20	0.27	1.97	0.52	0	0	0 (29262) <sup>4</sup>
<i>Paraplynus lugubris</i> (Stål) <sup>a</sup>	179	0.78	2.80	10.93	3.59	0.26	1.28	0.51	–	–	–
<i>Paratriatoma hirsuta</i> Barber	296	0.46	2.75	12.67	5.98	0.22	1.79	0.47	–	–	–
<i>Paredocla</i> chevalieriJeannel	18	0.86	3.55	12.00	4.13	0.30	1.42	0.54	0	0	1
<i>Peirates punctorius</i> (Stål)	216	0.86	2.67	10.93	3.10	0.24	1.13	0.49	–	–	–
<i>Phonoctonus</i> sp.	2120	0.86	6.40	23.00	7.44	0.28	2.01	0.53	–	–	–
<i>Cnizocoris</i> sp.	2851	0.86	2.25	10.70	2.62	0.21	0.96	0.46	0	0	1
<i>Pirnonota convexicollis</i> Stål	2476	0.37	3.10	8.50	8.38	0.36	2.13	0.60	–	–	–
<i>Platymeris biguttata</i> (Linne)	175	2.20	7.00	36.00	3.18	0.19	1.16	0.44	0	0	1
<i>Ploeogaster</i> sp.	2063	0.73	7.50	16.30	10.27	0.46	2.33	0.68	0	0	0 (81) <sup>4</sup>
<i>Ploeogaster</i> sp.	2097	0.56	7.00	12.20	12.50	0.57	2.53	0.76	–	–	–
<i>Ploeogaster</i> sp.	2809	0.75	7.40	16.20	9.87	0.46	2.29	0.68	–	–	–
<i>Ploeogaster</i> sp.	2859	0.59	5.00	10.60	8.52	0.47	2.14	0.69	–	–	–
<i>Ploeogaster</i> sp.	636	0.99	9.30	24.00	9.43	0.39	2.24	0.62	–	–	–
<i>Ploiaria hirticornis</i> (N.	54	0.14	0.98	5.70	7.00	0.17	1.95	0.41	–	–	–

Banks)

<i>Poecilobdallus gratiosus</i> (Stål) <sup>a</sup>	214	0.65	7.00	16.50	10.77	0.42	2.38	0.65	–	–	–
<i>Polididus</i> sp.	2036	0.41	4.30	10.50	10.49	0.41	2.35	0.64	0	0	0 (4031) <sup>4</sup>
<i>Polididus</i> sp.	650	0.45	3.80	10.10	8.44	0.38	2.13	0.61	–	–	–
<i>Pristhesancus</i> sp.	2796	1.40	8.20	25.00	5.86	0.33	1.77	0.57	0	0	0 (29264) <sup>4</sup>
<i>Pselliopus</i> sp.	123	0.84	4.00	13.50	4.76	0.30	1.56	0.54	0	0	0 (3160) <sup>4</sup>
<i>Pselliopus</i> sp.	2205	0.42	3.50	10.10	8.43	0.35	2.13	0.59	–	–	–
<i>Pselliopus zebra</i> (Stål)	280	0.38	2.80	9.00	7.10	0.31	1.96	0.56	–	–	–
<i>Pselliopus spinicollis</i> (Champion)	284	0.33	2.40	8.10	7.10	0.30	1.96	0.54	–	–	–
<i>Pselliopus</i> sp.	938	0.68	4.50	12.50	6.62	0.36	1.89	0.60	–	–	–
<i>Pyrrhosphodrus amazonus</i> (Champion)	31	0.66	6.00	15.60	9.09	0.38	2.21	0.62	0	0	0 (2626) <sup>4</sup>
<i>Racelda</i> sp.	41	1.23	3.17	12.50	2.57	0.25	0.95	0.50	–	–	–
cf. <i>Repipta</i>	2091	0.18	3.40	7.70	18.68	0.44	2.93	0.66	1	1	1
<i>Repipta</i> sp.	1425	0.25	3.90	9.10	15.92	0.43	2.77	0.65	–	–	–
<i>Repipta</i> sp.	2076	0.23	4.10	9.50	17.83	0.43	2.88	0.66	1	1	1
<i>Repipta</i> sp.	2084	0.24	3.50	7.50	14.89	0.47	2.70	0.68	1	1	1
<i>Repipta</i> sp.	2090	0.17	3.75	7.10	22.50	0.53	3.11	0.73	1	1	1
<i>Repipta</i> sp.	2096	0.21	3.85	8.00	18.63	0.48	2.92	0.69	1	1	1
<i>Repipta</i> sp.	2275	0.30	4.40	9.80	14.83	0.45	2.70	0.67	–	–	–
<i>Repipta</i> sp.	2477	0.23	4.30	9.10	18.97	0.47	2.94	0.69	1	1	1
<i>Repipta</i> sp.	632	0.30	3.90	9.70	13.00	0.40	2.56	0.63	–	–	–
<i>Repipta taurus</i> (Fabricius)	2029	0.28	3.70	9.20	13.21	0.40	2.58	0.63	1	1	1
<i>Rhaphidosomini</i> sp.	2736	0.41	11.90	36.00	29.02	0.33	3.37	0.57	0	0	0 (29750) <sup>4</sup>
<i>Rhaphidosomini</i> sp.	2743	0.45	9.00	26.60	20.00	0.34	3.00	0.58	–	–	–
<i>Rhaphidosomini</i> sp.	2747	0.40	6.40	21.50	16.00	0.30	2.77	0.55	–	–	–
<i>Rhiginia</i> sp.	139	0.88	3.05	16.00	3.47	0.19	1.24	0.44	–	–	–
<i>Rhynocoris segmentarius</i> (Germar)	4	0.86	5.80	13.00	6.70	0.45	1.90	0.67	0	0	1
<i>Rhynocoris</i> sp.	1842	0.65	4.80	12.80	7.38	0.38	2.00	0.61	–	–	–

<i>Rhynocoris</i> sp.	1853	0.70	5.60	13.00	8.00	0.43	2.08	0.66	0	0	1
<i>Rhynocoris</i> sp.	1855	0.49	4.65	11.50	9.49	0.40	2.25	0.64	–	–	–
<i>Rhynocoris</i> sp.	1859	0.49	4.65	10.50	9.49	0.44	2.25	0.67	–	–	–
<i>Rhynocoris</i> sp.	1865	0.60	4.25	11.00	7.08	0.39	1.96	0.62	–	–	–
<i>Rhynocoris</i> sp.	1911	0.59	5.20	13.33	8.81	0.39	2.18	0.62	–	–	–
<i>Rhynocoris</i> sp.	1998	0.61	3.50	11.00	5.74	0.32	1.75	0.56	–	–	–
<i>Rhynocoris</i> sp.	2755	0.59	3.30	12.30	5.59	0.27	1.72	0.52	–	–	–
<i>Rhynocoris</i> sp.	467	0.50	3.80	7.20	7.60	0.53	2.03	0.73	–	–	–
<i>Rhynocoris</i> sp.	720	0.46	4.65	10.70	10.11	0.43	2.31	0.66	–	–	–
<i>Rhynocoris ventralis</i> Hahn	2072	0.56	3.25	11.00	5.80	0.30	1.76	0.54	0	0	0 (29267) <sup>4</sup>
<i>Ricolla quadrispinosa</i> (Linne)	396	0.47	7.00	16.90	14.89	0.41	2.70	0.64	–	–	–
<i>Ricolla</i> sp.	1247	0.45	7.40	16.70	16.44	0.44	2.80	0.67	0	0	1
<i>Rocconota</i> sp.	2216	0.56	7.80	18.00	13.93	0.43	2.63	0.66	0	0	1
<i>Rocconota</i> sp.	279	0.79	6.70	18.00	8.50	0.37	2.14	0.61	0	0	1
<i>Sastrapada</i> sp.	185	0.48	3.50	16.27	7.29	0.22	1.99	0.46	–	–	–
<i>Sinea diadema</i> Caudell	108	0.49	3.05	10.30	6.30	0.30	1.84	0.54	0	0	0 (3302) <sup>4</sup>
<i>Sinea</i> sp.	1012	0.60	3.00	9.50	5.00	0.32	1.61	0.56	–	–	–
<i>Sinea</i> sp.	2083	0.55	3.70	10.90	6.73	0.34	1.91	0.58	–	–	–
<i>Sinea</i> sp.	489	0.55	2.85	9.40	5.18	0.30	1.65	0.55	–	–	–
<i>Sinea</i> sp.	899	0.45	3.40	10.00	7.56	0.34	2.02	0.58	–	–	–
<i>Sphedanolestes</i> sp.	1194	0.32	2.45	7.00	7.66	0.35	2.04	0.59	–	–	–
<i>Sphedanolestes</i> sp.	15	0.45	3.20	8.50	7.11	0.38	1.96	0.61	–	–	–
<i>Sphedanolestes</i> sp.	1999	0.32	2.75	7.90	8.59	0.35	2.15	0.59	0	0	1
<i>Sphedanolestes</i> sp.	2028	0.51	3.50	12.50	6.86	0.28	1.93	0.53	–	–	–
<i>Sphedanolestes</i> sp.	2479	0.42	2.95	9.40	7.02	0.31	1.95	0.56	–	–	–
<i>Sphedanolestes</i> sp.	2656	0.40	3.80	9.60	9.70	0.40	2.27	0.63	–	–	–
<i>Sphedanolestes</i> sp.	2660	0.30	2.25	7.30	7.50	0.31	2.01	0.56	–	–	–
<i>Sphedanolestes</i> sp.	2674	0.38	3.75	9.10	9.87	0.41	2.29	0.64	0	0	1
<i>Sphedanolestes</i> sp.	2704	0.37	3.20	9.00	8.65	0.36	2.16	0.60	–	–	–
<i>Sphedanolestes</i> sp.	2709	0.28	3.00	7.60	10.71	0.39	2.37	0.63	0	0	1

<i>Sphedanolestes</i> sp.	2739	0.36	2.20	7.00	6.11	0.31	1.81	0.56	0	0	1
<i>Sphedanolestes</i> sp.	655	0.40	4.60	10.50	11.50	0.44	2.44	0.66	–	–	–
<i>Stenolemoides</i> <i>arizonensis</i> (N. Banks)	304	0.23	3.20	8.50	13.91	0.38	2.63	0.61	–	–	–
<i>Stenolemus</i> sp.	147	0.21	2.20	8.00	10.48	0.28	2.35	0.52	–	–	–
<i>Stenopoda</i> sp.	154	0.90	7.00	22.80	7.78	0.31	2.05	0.55	0	0	0 (29753) <sup>4</sup>
<i>Sycanus</i> sp.	1891	0.59	7.30	27.00	12.37	0.27	2.52	0.52	0	0	1
<i>Tapeinus</i> sp.	183	1.00	3.15	13.70	3.15	0.23	1.15	0.48	0	0	1
<i>Triatoma recurva</i> (Stål)	170	0.79	6.20	31.00	7.85	0.20	2.06	0.45	0	0	0 (29756) <sup>4</sup>
<i>Tribelocephala</i> <i>peyrierasi</i> Villiers	287	0.29	1.45	7.10	5.00	0.20	1.61	0.45	0	0	1 (4818) <sup>4</sup>
<i>Ulpinus grandituber</i> Bergroth	370	0.59	5.80	15.60	9.83	0.37	2.29	0.61	–	–	–
<i>Velinus</i> sp.	197	0.73	7.60	18.00	10.50	0.42	2.35	0.65	0	0	0 (29270) <sup>4</sup>
<i>Velinus</i> sp.	2714	0.70	6.50	15.70	9.29	0.41	2.23	0.64	–	–	–
<i>Vesbius purpureus</i> (Thunberg)	184	0.28	3.00	9.00	10.71	0.33	2.37	0.58	0	0	0 (1522) <sup>4</sup>
<i>Vestula</i> sp.	2817	0.42	5.50	12.80	13.10	0.43	2.57	0.66	–	–	–
<i>Vestula</i> sp.	657	0.40	4.70	12.00	11.75	0.39	2.46	0.63	0	0	0 (29261) <sup>4</sup>
<i>Vitumnus</i> sp.	2786	1.13	4.80	18.00	4.25	0.27	1.45	0.52	–	–	–
<i>Xystonyttus</i> sp.	2213	0.23	3.40	9.40	14.78	0.36	2.69	0.60	1	1	1
<i>Zelurus petax</i> (Breddin)	167	0.44	4.00	12.10	9.09	0.33	2.21	0.57	0	0	1
<i>Zelus annulosus</i> (Stål)	2098	0.36	8.25	18.00	22.92	0.46	3.13	0.68	–	–	–
<i>Zelus araneiformis</i> Haviland	2281	0.23	4.80	9.60	21.18	0.50	3.05	0.71	1	1	1
<i>Zelus armillatus</i> (Lepeletier and Serville)	2163	0.55	7.70	17.50	14.00	0.44	2.64	0.66	–	–	–
<i>Zelus cervicalis</i> Stål	115	0.30	4.55	11.50	15.17	0.40	2.72	0.63	–	–	–
<i>Zelus errans</i> Fabricius	2474	0.34	9.70	17.50	28.25	0.55	3.34	0.74	–	–	–
<i>Zelus grassans</i> Stål	584	0.35	6.20	12.50	17.88	0.50	2.88	0.70	–	–	–
<i>Zelus janus</i> Stål	931	0.65	9.00	19.80	13.85	0.45	2.63	0.67	–	–	–
<i>Zelus laticornis</i>	2165	0.25	4.10	10.50	16.62	0.39	2.81	0.62	–	–	–

(Herrich- Schaeffer)											
<i>Zelus longipes</i> (Linne)	6	0.45	7.30	15.87	16.22	0.46	2.79	0.68	–	–	–
<i>Zelus luridus</i> Stål	69	0.39	6.20	13.50	15.90	0.46	2.77	0.68	–	–	–
<i>Zelus means</i> Fabricius	1400	0.44	7.00	16.00	15.91	0.44	2.77	0.66	–	–	–
<i>Zelus nugax</i> Stål	714	0.28	5.00	9.10	17.86	0.55	2.88	0.74	–	–	–
<i>Zelus panamensis</i> [manuscript name]	2164	0.26	6.90	11.80	26.20	0.58	3.27	0.76	–	–	–
<i>Zelus pedestris</i> Fabricius	629	0.28	5.40	11.30	19.64	0.48	2.98	0.69	–	–	–
<i>Zelus renardii</i> Kolenati	403	0.38	4.50	11.60	11.84	0.39	2.47	0.62	1	1	0 (475) <sup>4</sup>
<i>Zelus</i> sp.	1323	0.33	5.50	15.00	16.54	0.37	2.81	0.61	–	–	–
<i>Zelus</i> sp.	2095	0.27	6.90	10.50	25.24	0.66	3.23	0.81	–	–	–
<i>Zelus</i> sp.	2684	0.33	6.90	13.00	20.91	0.53	3.04	0.73	1	1	1
<i>Zelus</i> sp.	2806	0.27	5.80	10.30	21.48	0.56	3.07	0.75	–	–	–
<i>Zelus</i> sp.	630	0.33	6.50	13.30	19.90	0.49	2.99	0.70	–	–	–
<i>Zelus tetracanthus</i> Stål	717	0.30	4.60	10.20	15.33	0.45	2.73	0.67	1	1	1
<i>Zelus versicolor</i> (Herrich- Schaeffer)	43	0.33	5.20	13.10	15.64	0.40	2.75	0.63	–	–	–

<sup>1</sup> 0=absent, 1= present.

<sup>2</sup> 0=simple, 1= sundew, 2 =lamellate.

<sup>3</sup> 0=Zhang & Weirauch (2011), 1=current study. When the source of data is current study (1), the same molecular voucher was usually used for the morphological examinations of glands and setae unless otherwise noted, and no additional voucher information is provided. If the data is obtained from Zhang & Weirauch (2011), the USI of the morphology voucher in Zhang & Weirauch (2011) is indicated. A few specimens used in Zhang & Weirauch (2011) are also molecular vouchers in current study and no USI is specified. The prefix of USI numbers is 'UCR\_ENT' and is omitted.

<sup>4</sup> The gland and setae data are based on a conspecific or congeneric specimen used either in Zhang & Weirauch (2011) or current study and do not come from observations of molecular voucher used in the phylogeny.

<sup>5</sup> Measurements were done on a specimen different from molecular voucher. USIs of actual specimen used for measurements are: UCR\_ENT 00030206 (*Isyndus reticulatus*); UCR\_ENT 00029250 (*Cydnocoris russatus*).



Supporting Information 3.4. Suprageneric classification within the Harpactorini and results of relationships tested in the phylogeny represented by Fig. 3.1. Suprageneric groups are listed by year of publication.

Suprageneric group	Status in current phylogeny	Authority	Proposed constituent genera	Genera represented in the current phylogeny
Harpactorides	2	Amyot and Serville (1843)	<i>Cidoria</i> , <i>Prionotus</i> (synonym of <i>Arilus</i> ), <i>Yolinus</i> , <i>Eulyes</i> , <i>Sycanus</i> , <i>Pristhesancus</i> , <i>Helonotus</i> , <i>Piezopleura</i> (Synonym of <i>Harpactor</i> ), <i>Montina</i> , <i>Ploeogaster</i> , <i>Harpactor</i> (synonym of <i>Rhynocoris</i> , in part), <i>Acantischium</i>	<i>Arilus</i> , <i>Eulyes</i> , <i>Sycanus</i> , <i>Pristhesancus</i> , <i>Harpactor</i> , <i>Montina</i> , <i>Ploeogaster</i> , <i>Rhynocoris</i> , <i>Acanthichium</i>
Zelides	2	Amyot and Serville (1843)	<i>Euagoras</i> (synonym of <i>Zelus</i> ), <i>Zelus</i> , <i>Isocondylus</i> , <i>Darbanus</i> (Synonym of <i>Euagoras</i> ), <i>Passaleutus</i> (Synonym of <i>Ploeogaster</i> ), <i>Myocoris rubrithorax</i> (as <i>Inserta Sedis</i> ), <i>Atrachelus</i> , <i>Heza</i> , <i>Sinea</i> , <i>Scipinia</i> (as <i>Sinea javanensis</i> , synonym of <i>Scipinia horrida</i> ), <i>Pselliopus</i> (as <i>Sinea punctipes</i> , synonym of <i>Pselliopus punctipes</i> )	<i>Zelus</i> , <i>Isocondylus</i> , <i>Euagoras</i> , <i>Ploeogaster</i> , <i>Atrachelus</i> , <i>Heza</i> , <i>Sinea</i> , <i>Pselliopus</i>
Saccodérides	3	Amyot and Serville (1843)	<i>Sava</i> , <i>Notocyrtus</i> (as <i>Saccoderes</i> )	None
Sycanidae	0	Dohrn (1859)	<i>Eulyes</i> , <i>Sycanus</i> , <i>Yolinus</i>	<i>Eulyes</i> , <i>Sycanus</i>
Haematocharidae	3	Dohrn (1859)	<i>Haematochares</i>	None

Harpactoridae	2	Dohrn (1859)	<i>Cidoria</i> , <i>Prionotus</i> (synonym of <i>Arilus</i> ), <i>Pristhesancus</i> , <i>Helonotus</i> , <i>Laphyetes</i> (synonym of <i>Odontogonus</i> ), <i>Piezopleura</i> (Synonym of <i>Harpactor</i> ), <i>Montina</i> , <i>Ploeogaster</i> , <i>Acantischium</i> , <i>Pantoleistes</i> , <i>Phonoctonus</i> , <i>Harpagocoris</i> , <i>Acanthischium</i> , <i>Heza</i> , <i>Atrachelus</i> , <i>Zelus</i> , <i>Myocoris</i> , <i>Passaleutus</i> (Synonym of <i>Ploeogaster</i> ), <i>Darbanus</i> (synonym of <i>Euagoras</i> )	<i>Arilus</i> , <i>Pristhesancus</i> , <i>Odontogonus</i> , <i>Harpactor</i> , <i>Montina</i> , <i>Ploeogaster</i> , <i>Acantischium</i> , <i>Pantoleistes</i> , <i>Phonoctonus</i> , <i>Harpagocoris</i> , <i>Acanthischium</i> , <i>Heza</i> , <i>Atrachelus</i> , <i>Zelus</i> , <i>Myocoris</i> , <i>Euagoras</i>
Saccoderidae	3	Dohrn (1859)	<i>Sava</i> , <i>Notocyrtus</i>	<i>Notocyrtus</i>
Hezida	2	Stål (1859)	<i>Heza</i> , <i>Arilus</i> (as <i>Prionotus</i> ), <i>Isocondylus</i>	<i>Heza</i> , <i>Arilus</i> , <i>Isocondylus</i>
Reduviida	2	Stål (1859)	<i>Harpactor</i> , <i>Zelus</i>	<i>Harpactor</i> , <i>Zelus</i>
Harpactoraria	0	Distant (1904)	<i>Rhynocoris</i> , <i>Sphedanolestes</i> , <i>Biasticus</i>	<i>Rhynocoris</i> , <i>Sphedanolestes</i> , <i>Biasticus</i>
Vesbiaria	3	Distant (1904)	<i>Vesbius</i>	<i>Vesbius</i>
Velinaria	2	Distant (1904)	<i>Cosmolestes</i> , <i>Velinus</i>	<i>Cosmolestes</i> , <i>Velinus</i>
Sycanaria	3	Distant (1904)	<i>Sycanus</i> , <i>Arcesius</i> , <i>Narsetes</i>	<i>Sycanus</i>
Yolinaria	3	Distant (1904)	<i>Yolinus</i> , <i>Agriolestes</i> , <i>Agriosphodrus</i>	<i>Agriosphodrus</i>
Euagorasaria	2	Distant (1904)	<i>Euagoras</i> , <i>Macracanthopsis</i> , <i>Cydnocoris</i> , <i>Villanovanus</i> , <i>Endochus</i> , <i>Platerus</i> , <i>Alcmena</i> , <i>Epidaus</i> , <i>Brassivola</i> , <i>Bartacus</i> , <i>Isyndus</i> , <i>Rihirbus</i>	<i>Euagoras</i> , <i>Macracanthopsis</i> , <i>Cydnocoris</i> , <i>Endochus</i> , <i>Epidaus</i> , <i>Isyndus</i>
Panthousaria	3	Distant (1904)	<i>Panthous</i>	None
Coranusaria	3	Distant (1904)	<i>Coranus</i>	<i>Coranus</i>
Pristhesancusaria	3	Distant (1904)	<i>Pristhesancus</i>	<i>Pristhesancus</i>
Polididusaria	2	Distant (1904)	<i>Scipinia</i> , <i>Irantha</i> , <i>Polididus</i> , <i>Henricohahnia</i>	<i>Irantha</i> , <i>Polididus</i>
Perissorhynchinae	3	Miller (1952)	<i>Perissorhynchus</i>	None

Harpactorini	2	Villiers (1983)	Genera with a tubercle on the mesopleura	<i>Authenta, Coranus, Endochus, Harpactor, Heza, Irantha, Isocondylus, Montana, Odontogonus, Pirmonota, Ploegaster, Pristhesancus, Sinea, Vitumnus</i>
Rhinocorini (sic)	2	Villiers (1982)	Genera without a tubercle on the mesopleura (plica)	All remaining Harpactorini

---

<sup>1</sup> 0=monophyletic, 1=paraphyletic, 2=polyphyletic, 3=Not applicable because not represented in the phylogeny or only represented by a single genus.

## **CHAPTER 4: Taxonomic revision of *Zelus* Fabricius, 1803 (Hemiptera: Reduviidae: Harpactorinae: Harpactorini) of 70 species based on 11,000 specimens**

### **Abstract**

The New World harpactorine genus *Zelus* Fabricius, 1803 is revised based on 11,000 specimens. Seventy species are recognized and 24 described as new. Five species are removed from *Zelus*. Ten species groups are proposed primarily on the basis of male genitalic characters. Three species known from only female specimens are unplaced. Habitus images, illustrations of male genitalia and distribution maps are provided. Measurements of specimens were performed and are provided for nearly all valid species. It is also proposed that *Zelus* is closely related to three other New World genera: *Atopozelus* Elkins, *Ischnoclopius* Stål and an undescribed genus.

### **Introduction**

With 61 described species, *Zelus* Fabricius, 1803 is one of the largest reduviid genera (Hart, 1972; Maldonado, 1990) and the largest New World genus in the Harpactorini. *Zelus* is endemic to and widely distributed throughout the Western Hemisphere, ranging from southern Canada through central Argentina. It has also been introduced to Hawaii (Kirkaldy, 1903a, 1910; Zimmermann, 1948), and was recently found in Spain and Chile (Curkovic et al., 2004; Davranoglou, 2011, Klaus Kamppeter, pers. comm). Species of *Zelus*, among several other genera (e.g., *Arilus* Hahn, *Sinea* Amyot & Serville, and *Montina* Amyot & Serville) have been explored and studied as natural enemies in the Americas (Cohen & Tang, 1997; Cogni et al., 2002; reviewed in Hagen et al., 1999).

*Zelus* spp. prey on a wide range of insects in cotton, soybean, alfalfa crops and fruit tree in California and elsewhere (Ali & Watson, 1978; McPherson et al. 1982; Cisneros & Rosenheim, 1998), may reach population densities of up to 50,000 to 75,000/ha, and prevent outbreaks of lepidopteran larvae (Ables, 1978). Hart (1972) conducted a taxonomic revision of *Zelus* with descriptions of 21 new species and proposition of 15 new synonyms, which remained largely unpublished (see Hart 1986, and 1987, for revisions of 20 North American and Northern Mexican and Caribbean species, respectively). Despite such an effort, the current state of taxonomy of *Zelus* is unsatisfactory and impedes further research on using species in this genus as biological control agents and on unraveling the evolutionary history of the group. Species identification is difficult in many instances, leading to misidentifications. For instance, *Zelus renardii* Kolenati was misidentified as *Zelus cervicalis* Stål when the latter was reported as having been introduced to Chile (Curkovic et al. 2004).

## **Materials and Methods**

### *Specimens, databasing and georeferencing*

A total of 11,000 specimens were examined and databased. Among those, 4,915 are males and 5,899 are females. Specimens loans were kindly provided by museums or collections listed in Table 4.1. Each specimen was affixed with a Unique Specimen Identifier (USI) and label information, including locality, was entered into the Plant Bug Planetary Biodiversity Inventory (PBI) locality database ([https://research.amnh.org/pbi/databases/locality\\_database.html](https://research.amnh.org/pbi/databases/locality_database.html)) located at the American Museum of Natural History (AMNH) (Schuh 2012). When coordinates were not provided on the locality label, which is the situation for the absolute majority of the

specimens, the locality was geo-referenced using gazetteers. These include the USGS Geographic Names Information System (<http://geonames.usgs.gov/pls/gnispublic>), Google Earth, Fallingrain.com and Fuzzy Gazetteer. For localities outside the USA, higher level administration divisions included only country and state (or department), and no county-level administrative division was used. Localities at only the country and/or state level were not geo-referenced. Localities consisting of only a U.S. county, but no locality within that county, were given the coordinates of the county seat. Specimen information was then exported from the PBI database. Information of holotype, lectotype, neotype, paratype and paralectotype is provided in the description (for both described and new species), and information of other material examined is provided in a separate supplemental information file (not printed as part of the dissertation).

*Morphological methods – dissections, observations, imaging and measurements*

Dissection. Male genitalia including the eighth abdominal segment, the pygophore, and the phallus were removed, cleared in heated 10% potassium hydroxide (KOH) solution for 5–10 minutes, washed in distilled water, and stored in glycerol.

Observations using a dissecting microscope. Observations were made using a Nikon stereo dissecting microscope SMZ1500. Specimens or dissected structures were illuminated by a Nikon NI-150 High Intensity Illuminator. Initial observations of morphological characters were made based on typically a small number of specimens (1-5) and intraspecific variation was examined based on a larger selection of geographical representation of specimens. Observations were primarily based on male specimens and descriptions of females were restricted to only those characters different from the male. Three character systems were observed: coloration, vestiture and structure, the latter also including male genitalia. Genitalic structures were observed in

observed in glycerol. Structures in this medium may look different from their dry state, especially for soft cuticle. For example, apices of the parameres of *Zelus cervicalis* usually appear shriveled in dry specimens, but are fully expanded in glycerol. Orientation of structures of the dissected structures shown in illustrations or images does not necessarily reflect their natural condition. Description of orientation of genitalic structures (e.g., posteriorly directed, forming 45-degree angle) was based on *in situ* observation of an intact specimen, except for the following species where the genitalia was observed only in its dissected condition in glycerol: *Zelus aithaleos* sp. nov., *Zelus bahiaensis* sp. nov., and *Zelus fuliginatus* sp. nov.

Imaging, image processing, figures and maps. Dorsal and lateral habitus images of specimens and dissections were taken with a Microptics-USA system with a K2 lens and CF-2 or CF-4 objectives. Dissected structures, mainly of male genitalic structures, were photographed in glycerol with an Auto–montage GT–Vision imaging system. Images were edited in PHOTOSHOP (CS3/CS4) to adjust levels and sharpness. Figures of habitus images were assembled with CORELDRAW X3 (Version 13) (Figs 4.1-4.8). Illustrations of male genitalia were made after Hart (1972) (Figs 4.9-4.18). Distribution maps were created using “Simple Mapper” (<http://research.amnh.org/pbi/maps/>). Maps were produced by using the Simple Mapper module of the PBI database based on the geo-referenced locality data (Figs 4.19-4.38). Because accuracy and error of geo-referencing are highly variable, distribution records shown on the maps are at best indicative. It is therefore advisable to look up the material examined section for actual locality information.

Measurements. Measurements (Table 4.2) were made on a dissecting scope equipped with a 2-axes movable stage (Mitutoyo Corp.), with the aid of two digital

micrometers (Boeckeler®) which were connected to a Microcode II RS-232 digital readout (Boeckeler®). All measurement values are in mm.

#### *Literature review and taxonomic history*

Literature review and description of taxonomic history were primarily based on Hart (1972) and Maldonado (1990).

#### *Descriptive taxonomy*

Description. Observations were recorded with the software DDescriptive Language for Taxonomy (DELTA) (Dallwitz, 1980; Dallwitz, Paine & Zurcher, 1999 onwards). Natural descriptive language was exported and edited. Observation and description were done primarily based on male specimens. Three types of character systems, coloration, vestiture and structures were described separately. For vestiture and structure, description is usually divided to head, thorax, abdomen or genitalia. Sometimes this subdivision is not strictly followed for vestiture. Description of abdominal vestiture is restricted to the ventral surface only. Description of a body part usually starts with an overview of overall appearance of that body part such as length, width, and general shape. Structures on a body part are then described in the order from anterior to posterior, medial to lateral, dorsal to ventral, and proximal to distal. Ratios are determined by comparing mean values. The segment 8 of the abdomen of male specimens is described as part of genitalic structures because it is attached to the pygophore and was usually observed together with the genitalic structures rather than with the non-genitalic structures. Ratio between the segments of labium or antenna is in reference to the respective first segment. Unless otherwise stated, all measurement values reported in the text are mean values. For closely related or very similar species, a



full description is provided for one representative and only variable characters are described for other species. Description of female was provided only for those characters that differ from male. However, structural ratio (e.g. ratio between the lengths of antennal segments) was not compared between the sexes. Such information can be derived from the measurement table. The singular form is used for paired structures except when referring to spatial relationships between these structures, e.g., struts (of phallus) separate, sub-parallel. It was noted that many dried specimens show browning and fading of colors and present coloration different from that in their live condition. This is particularly evident in some light or bright-colored species. Descriptions of coloration were based observations of dried specimens, but notes were made if images or observations of live specimens were available. It has been noted that in a number of species that the ventral outline of abdomen is curved, a condition apparently resulting from the folding of segments 3-6 (sometimes 2 too). It is not clear this is a preservation artifact or represents the natural condition, but it has been consistently seen with species, as well as across species. Thus, this character was described as observed.

Description of intraspecific variation. Intraspecific variations were described and indicated by terms or phrases as the following: sometimes, occasionally, in some specimens, something to/or something. The last is not to be confused with how they were used to indicate differences in the type of setae found on the same specimen (e.g, short to long setae; erect or recumbent setae). When variations in coloration can be roughly delimited to several patterns, they were described and the frequency of the patterns sometimes mentioned as well. Intraspecific variations in male genitalic structures were usually not described or documented unless they are important for

species diagnosis and identification, which were usually the case only for closely related species.

Association between male and female. For the majority of species, males and females show limited sexual dimorphism in size and coloration, and could be associated readily based on external morphology, corroborated by collecting data. However, sexual dimorphism is pronounced in a number of species. Males and females differ drastically in size, body conformation and coloration. The association of sexes for these species was mainly based on locality data and series of specimens of both sexes. Observations of mating reported in literature were also consulted and used as corroborative evidence whenever available.

Diagnosis. I have tried to use external morphology and male genitalic features that do not require dissection (i.e., paramere, medial process and part of ventral outline of pygophore) as primary diagnostic characters, because of their easy access for observation. Other male genitalic structures were also included, especially when they are useful for distinguishing closely related species. The illustrated documentations of male genitalia (Figs Fig. 4.08-4.18) can always also serve as an additional source of information. While males of most species can be readily identified based on characters of the genitalia, identification of female is less straightforward. Collecting and geographical information is often used to aid identification.

Terminology and abbreviation. External morphology and genitalic terminology follow Davis (1966) and Weirauch (2008). Illustrated terminology of male genitalic characters can be found in Fig. 4.9. The term 'proximal edge' is used to refer to the margin that is close to the base of dorsal phallosclerite (dps), but is distal to the basal arms of the dps. The following abbreviations were used: A and S=Amyot and

Serville; BL=body length; cat=catalogue; Cu=Cubitus; descr=description; desig=designation; f=female; fig.=figure; L=length; m=male; orig=original; preocc=preoccupied; SD=standard deviation; sp. nov.=species novum; syn.=synonym; W=width.

## Results

### *Taxonomic history*

The taxonomic history of *Zelus* is complex and the generic limit of *Zelus* has undergone constant fluctuations. The first species of *Zelus*, *Z. longipes*, was described by Linnaeus in the twelfth edition of *Systema Naturae* (1767) under *Cimex*, a genus in which he also included various other Heteroptera that are now classified within a number of families. Fabricius (1775) transferred *longipes* from *Cimex* to *Reduvius*, a genus that was established to accommodate most of the Reduviidae known at the time. It was again Fabricius who later in the first comprehensive treatment of Hemiptera (1803) erected the genus *Zelus*. In this work for each genus Fabricius selected one species for which he repeated the short generic description, expanded the species description and italicized the terms referring to the morphological structures described. *Zelus longipes* was treated by Fabricius this way for the genus *Zelus*. Therefore, many workers considered assumed that Fabricius had indicated *Zelus longipes* as the type species of the genus (Kirkaldy 1900a).

Le Peletier and Serville (1825) expanded the limit of *Reduvius* to include nearly all then described Reduviidae and described many new species; several of them would now be considered members of *Zelus*. An erroneous designation of *Zelus festinans* as the type species of *Zelus* was made by Laporte (1832). He erected new genera and

removed some species from *Zelus*, somewhat changing the generic limit of this genus. Perty (1834) treated *Reduvius* similarly to La Peletier and Serville and described several new species of *Zelus*, placing them in *Reduvius*.

Burmeister (1835) modified the classification of Reduviidae and divided members of *Zelus* into two genera: *Euagoras* Burmeister, 1835 and *Arilus* Hahn, 1831. The limits of *Zelus* were expanded by Brulle (1836) to include part of *Reduvius* as defined by Fabricius, *Harpactor* and *Prionotus* as defined by Laporte and *Myocoris*, *Evagoras* (for *Euagoras*), *Notocyrtus* and *Arilus* as used by Burmeister. Blanchard (1840) again changed the limit of *Zelus*. It was to include some species of *Cimex* of Linnaeus and Stoll (1790), *Reduvius* of Fabricius and Wolff and *Prionotus* of Laporte. Amyot and Serville (1843) erected a new genus *Diplodus* to accommodate both described and new species of some *Zelus*. Herrich-Schaeffer (1848, 1853) described several new species of what would be considered as members of *Zelus* by subsequent workers. Signoret (1862) described a new species of *Diplodus* which would eventually be transferred to *Zelus*.

A series of works by Stål greatly change the generic limits of *Zelus* (1855, 1859, 1860, 1861, 1862, 1866). Among those, Stål (1862) redefined *Zelus* as containing 3 subgeneric groupings: (1) *Zelus* of Fabricius, which also contained *Euagoras* Burmeister; posterior pronotal lobe unarmed, lateral angles rounded. One previously described species was listed, 4 species being therein synonymized as part of a total of 9 varieties listed for that species. (2) *Diplodus* of Amyot and Serville; disc of posterior pronotal lobe unarmed, lateral angles armed with a tooth or spine. Ten new species were described therein, one of these with 3 varieties, one with 2 varieties and another

with 4 varieties. (3) *Pindus* Stål; posterior pronotal lobe armed with 2 spines on the disc and a spine on each lateral angle. One new species was described.

However, the subgeneric groups were raised to the generic rank by Stål (1866) in a key to the genera of new world reduviids. Later Stål (1872) again recognized *Zelus*, *Diplodus* and *Pindus* as subgenera of the genus *Zelus*, with 15, 30, and 2 species respectively. A Fabrician species was not assigned to a subgenus. He also provided a key to the genera, subgenera and species and a list of synonymy. The geographical distribution of *Zelus*, according to this study, is restricted to the New World.

Uhler listed a species of *Diplodus* from one of the U. S. Geological Survey expeditions (1872a), described a new *Pindus* (1872b) and compiled a checklist of North American Hemiptera. This checklist recognized 6 species of *Zelus*, 16 species of *Diplodus* and 1 species, which in reality should have been assigned to *Zelus*, had been incorrectly described as a *Darbanus* by Provancher (1872). Based on the framework established by Stål (1872), Berg in 1879 described 2 new species of *Zelus* in his faunal study of the Hemiptera of Argentina.

Lethierry and Severin (1891), in their catalogue of the Hemiptera-Heteroptera of the world, adopted Stål's 1872 definition of *Zelus*. Fifty-two species, 9 synonymized names and 11 varieties were recognized.

Champion (1898) recorded 18 species within Mexico and Central America, 8 of which were described as new species. A short discussion of the genus, a key to the 18 species, drawings, descriptions, redescriptions and species discussions were included.

Kirkaldy (1900a, 1900b, 1901, 1903b) reviewed the nomenclatural validity and history of the types, genera and subgenera of the new species, discussed the possible synonymy of some others and synonymized several species. As *Diplodus* Amyot and

Serville was proven to be preoccupied, Kirkaldy (1900b) proposed *Diplacodus* as a new name for this subgenus. However, this name was also preoccupied and most following taxonomists used the name *Diplocodus*.

The generic and subgeneric definitions of Stål were also used by Fracker (1913). In North America, including Mexico, 20 species were included in a key. In a list of the geographic distribution, 3 additional species for which no specimens were available were discussed. One of these is noted as being a probable synonymy and another as probably belonging to *Castolus* Stål.

Van Duzee's checklist of Hemiptera of the United States included *Zelus* as a genus of the tribe Zelini, subfamily Harpactorinae. Stål's 3 subgenera were recognized. Kirkaldy's *Diplacodus* was accepted for *Diplodus*, but was here and after spelled *Diplocodus*, no explanation being given for the change. There were 9 species recognized in the genus and 5 names were listed in synonymy. The known references for the genus, subgenera and these 9 species were compiled in Van Duzee's catalogue in 1917.

In his study of the Heteroptera of eastern North America, Blatchley (1926) used the subfamily Zelinae to include *Zelus* and related genera. *Zelus* was redescribed and a short discussion of the distribution and habits of the genus was included. Each of the 6 species of this area was keyed, redescribed, and short notes on its biology and distribution made.

Radio (1927) made studies of the biology of the 10 species which he recognized in America north of Mexico. These species were keyed and the descriptions and distributions of each were included. A major addition to the number of species of was made in 1931 by Haviland. A total of 9 species, including 6 new species, was

reported from British Guiana. Wygodzinsky (1949a) published a checklist of the Reduviidae of the Americas. He included 66 species, most of which are Neotropical in distribution, as valid members of the genus. Zayas (1960) described a new species from Cuba. Elkins (1954) removed two species. Hart in two publications (1986, 1987) treated the North American and Caribbean species of *Zelus*, describing 4 new species and proposing 15 new synonyms. The majority of the undescribed species proposed in his dissertation (1972) remains unpublished.

*Zelus* Fabricius, 1803

TYPE SPECIES: *Cimex longipes* Linnaeus, 1767 (original designation)

*Zelus* Fabricius, 1803, p. 281, orig. descr.; Latreille, 1804, p. 260, list; Latreille, 1807, p. 129, list; Latreille, 1810, p. 433, type designation; Le Peletier and Serville, 1825, p. 815, list and descr.; Laporte, 1832, p. 9, type designation; Burmeister, 1835, p. 225, descr.; Brulle, 1836, p. 316-317, descr.; Blanchard, 1840, p. 100, descr. And note; Blanchard, 1845, p. 433, 438, list and note; Herrich-Schaeffer, 1848, p. 88, descr. and note; Kolenati, 1857, p. 458-459, descr.; Stål, 1861, p. 148, descr.; Stål, 1862, p. 449-454, key and subgeneric descr. (with subgenus *Zelus*); Carpenter and Westwood, 1863, p. 565, note; Mayr, 1866, p. 138, list; Stål, 1866, p. 296, list; Stål, 1868, p. 107, restriction of definition; Stål, 1872, p. 69, 88, key and cat. (with subgenus *Zelus*); Walker, 1873, VII., p. 49, key, VIII., p. 131-136, cat.; Berg, 1879, p. 150, list (with subgenus *Zelus*); Uhler, 1886, p. 24, checklist; Provancher, 1887, p. 179, note; Lethierry and Severin, 1896, p. 151, cat.; Champion, 1898, p. 251, cat. and note; Kirkaldy, 1900a, p. 263, type verification; Kirkaldy, 1900b, p. 242, synonymy; Kirkaldy, 1902, p. 149, note; Fracker, 1913, p. 223, 238-240, key and note (with subgenus *Zelus*); Van Duzee, 1916, p. 30,

checklist (with subgenus *Zelus*); Van Duzee, 1917, p. 258-259, cat. (with subgenus *Zelus*); Blatchley, 1926, p. 567-568, key, descr. and note (with subgenus *Zelus*); Radio, 1927, p. 167, 168-169, key, descr. and note; Zimmerman, 1948, p. 137, note; Wygodzinsky, 1949a, p. 48, checklist; Fracker and Usinger, 1949, p. 277, key to nymphs; Alayo, 1967, p. 5, 35, list, key and note; Hart, 1986, redescription and key Hart 1987, orig. descr. and key.

*Reduvius* Fabricius, 1775 (type by subsequent designation, *Cimex personatus* Linnaeus, 1758), Le Peletier and Serville, 1825 (in part), p. 272, descr.; Perty, 1834 (in part), p. 173, list of species.

*Arilus* Hahn, 1831 (type by subsequent designation, *Cimex carinatus* Forster, 1771), Burmeister, 1835 (in part), p. 227-228, descr.; Herrich-Schaeffer, 1848 (in part), p. 33-35, descr.

*Euagoras* Burmeister, 1835 (type by subsequent designation, *E. stollii* Burmeister, 1835) (in part), p. 226, descr.; Amyot and Serville, 1843 (in part), p. 368, descr. (as *Evagoras*); Herrich-Schaeffer, 1848 (in part), p. 43-44, descr.; Stål, 1855 (in part), p. 189, list (as *Eccaqoras*); Stål, 1861, p. 148, syn. (*Zelus* Fabr.); Mayr, 1866, p. 139, list; Walker, 1873, p. 49, 117, key and cat.; Provancher, 1887, p. 182, descr. (as *Evagoras*); Kirkaldy, 1900b, p. 242, syn. (= *Zelus* Fabr.); Kirkaldy, 1903, p. 215-216, note.

*Diplodus* Amyot and Serville, 1843, p. 370, descr.; Burmeister, 1853, p. 91, list (included in *Euagoras* Burm.); Stål, 1860, p. 74, list; Stål, 1862, p. 450, descr. (as subgenus of *Zelus*); Stål, 1866, p. 296, key; Stål, 1872, p. 90, list (as subgenus of *Zelus*); Walker, 1873, VII., p. 49, VIII., p. 123, key and cat. (as *Diploda*); Berg, 1879, p. 151, list (as subgenus of *Zelus*); Uhler, 1886, p. 24, checklist;



Provancher, 1887, p. 179, key and descr.; Kirkaldy, 1903, p. 232, note; Fracker, 1913, p. 239, 240, key and list (as subgenus of *Zelus*).

*Diplacodus* Kirkaldy, 1900b, p. 242, new name for *Diplodus* A. and S. (preocc.).

*Diplocodus* Van Duzee, 1916, p. 30, checklist (new name for *Diplacodus* Kirkaldy, preocc.); Van Duzee, 1917, p. 260, cat.; Blatchley, 1926, p. 569, key.

*Pindus* Stål, 1862, p. 454, orig. descr. (as subgenus of *Zelus*); Stål, 1866, p. 296, key (as genus); Stål, 1872, p. 92, list and cat., as subgenus of *Zelus*); Walker, 1873, VII., p. 66, list and cat. (as genus); Berg, 1879, p. 150, list (as subgenus of *Zelus*); Thierry and Severin, 1896, p. 151, cat.; Fracker, 1913, p. 223, 240, key and list; Van Duzee, 1916, p. 30, checklist; Van Duzee, 1917, p. 261, cat.; Blatchley, 1926, p. 569, key.

*Darbanus* Amyot and Serville, 1843 (type by monotypy, *D. nigrolineatus*), Provancher, 1872, p. 106, species descr.; Uhler, 1886, p. 24, checklist; Provancher, 1887, p. 179, 181, key and note; Van Duzee, 1912, p. 324, syn. (*Darbanus*, Provancher = *Zelus* Fabr.); Fracker, 1913, p. 241, note.

DIAGNOSIS: This genus is distinguished from most other genera of New World Harpactorini by the cylindrical head, the length of the head being at least 1.9X its width; the unarmed antenniferous tubercles; the second labial segment being at least 1.3x the length of the first segment; the long scape and basiflagellomere that are subequal in length and the short pedicel and distiflagellomere; the unarmed (i.e. no tubercles or spines) disc of the posterior pronotal lobe (with the exception of *Zelus tetracanthus* Stål); the humeral angles with or without processes, and if present, usually not prominently projected; the legs with sundew setae and sticky glands (Zhang & Weirauch, 2011); and the profemur subequal in length and diameter to the metafemur. *Zelus* is apparently

closely related to three other genera, *Atopozelus* Elkins, *Ischnoclopius* Stål and 'Hartzelus' [manuscript name], that share many of the aforementioned characters. It is separated from *Atopozelus* by the presence of paramere (lacking in *Atopozelus*). *Ischnoclopius* is distinguished from *Zelus* by its rather slender body form, the profemur being at least 0.6x of the body length, and the very short paramere. An undescribed genus, 'Hartzelus' (sensu Gil-Santana and Berenger, pers. com.), that would be based on species that are to be removed from *Zelus*, differs from *Zelus* in having a bifurcating medial process of the pygophore (medial process not bifurcating in *Zelus*). No Old World Harpactorini are similar or appear to be closely related to *Zelus*. Confusion may potentially arise with genera that show a similar slender body form and slender legs (e.g., *Euagoras*, Stål, *Vestula* Stål), but these are distinguished from *Zelus* based on the characters listed above.

REDESCRIPTION: **MALE:** Small to large, total length 8-25 (Table 4.2), with most of moderate size (11-18mm); usually slender (length/width=4.0-5.0), some species relatively robust (<3.5) to quite slender (>6.0). **COLORATION:** Color and patterns of preserved specimens variably yellowish brown, reddish-brown, orange-brown, and brownish-black to black, with most species uniformly colored. **VESTITURE:** Most species with moderately dense or dense, fine, short, decumbent and short, long, erect setae; some species with short, spine-like setae on head and pronotum; few species nearly glabrous. Setation on legs sparse in most species; profemur and tibia with dense sundew setae in some species. **STRUCTURE: Head:** Length much greater than width across eye. Postocular lobe usually longer than antecular, tube-like posteriorly in most species. Ocellus raised, directed somewhat laterally. Eye variably sized, not protruding above or below dorsal or ventral surfaces of head, with one exception (*Zelus*

*granduculus* **sp. nov.**). **Antenna:** Scape and basiflagellomere long and subequal in length, usually longer than head and pronotum combined; pedicel and distiflagellomere short and about 1/3 length of scape. Scape thickest; basiflagellomere usually thicker than pedicel, subequal in some species. **Labium:** Segment II longest, 1.3-2.2x length of segment I; segment III shortest, usually ~0.5x length of segment 1; variably curved between segments I and II. **Thorax:** Anterior pronotal lobe about 1/2 to 3/4 length of posterior lobe; antero-lateral collar dorsolateral angles rounded, with or without tuberculate protrusion; medial dorsal longitudinal sulcus usually shallow at collar, deepening through posterior 1/2; sometimes with subtuberculate elevation near posterior margin laterad to medial sulcus. Posterior pronotal lobe rugulose (sometimes not conspicuous in species with dense setation); slightly or greatly wider than anterior lobe; disc of most species elevated above humeral angles and posterior margin of lobe; humeral angles with tuberculate to long spinous lateral processes, round and unarmed in small number of species. Scutellum in most species with angulate apex, slightly produced and projected upward in some species. **Legs:** long, slender in most species; femoral diameters generally subequal, mesofemur usually more slender; pro- and metafemoral lengths subequal, greater than mesofemoral length. **Hemelytron:** Attaining or surpassing apex of abdomen, by large proportion in the male of certain species. Quadrate cell small to large; M conspicuous in some species and specimens and not visible in many. Proximal and distal margins of cubital cell subparallel in most species, converging in some. **Abdomen:** Lateral margins subparallel; ventral outline usually straight, in some species somewhat concave and abdomen appearing arch-shaped (see Material and Methods for discussion of this character). **Genitalia:** Segment 8 usually short, less than 1/2 length of pygophore; posterior margin generally slightly concave,

straight in some species, never convex. *Pygophore*: ovoid to elongated; expanded laterally close to base of paramere; dorsal bridge short to long. Medial process single, not bifurcating, of variable length and shape; distinct and slender in most species; triangular or cylindrical as most common configuration; apex with hook-like process in many species. Paramere generally cylindrical, often swollen and bending apically, length variable. *Phallus*: Dorsal phallosomal sclerite generally semi-cylindrical, broad and shield-like in many species, elongated in some; dorsal surface lacking armature in most species, with projection, process or elevation in some species; lateral margins usually straight or convex, constricted or recurved in some species; apical part may be keeled and/or curved dorsad, apex usually rounded or truncate with medial emargination. Struts attached to dorsal phallosomal sclerite in majority of species; apical part recurved dorsad and often semi-circular; with bridge connecting two sides in many species. Basal plate arms slender to heavy, separate or fused; basal plate bridge present, variable in width and degree of sclerotization; basal plate extension short, often extended onto basal plate arms.

*FEMALE*: Larger than male. Coloration similar to male and more variable than in male in some species. Eye and ocellus smaller than in male in some species. Basiflagellomere not swollen and about equal diameter as or smaller than pedicel. Lateral process on humeral angle, if present, usually more produced and longer than in male. Mesofemur slightly swollen in many species. Lateral margins of abdomen expanded in some species.

*DISTRIBUTION*: Native to and throughout the New World (except for Chile), including the Caribbean, with majority of species in the Neotropics. One species (Z.

*renardii*) was introduced to Hawaii, the Polynesian islands (current study), Spain, Greece and Chile

DISCUSSION: The generic limit of *Zelus* is now relatively well defined and the genus can be separated from all other described genera of New World Harpactorini based on characters discussed in the diagnosis. Previous proposals on subgeneric groups were based on superficial resemblances and are not adopted here. Except for several pairs or complexes of closely related species, identification of males can be almost always unambiguously performed based on exposed genitalic structures such as paramere and medial process, further corroborated with external morphology and coloration. Identification of females can be straightforward based on coloration and external morphology for many species where the female appears to be as distinct as the male. However, identification can be difficult for closely related species where the females are sometimes indistinguishable. In these cases, association of males and females and identification of females were primarily based on collecting event information. Sexual dimorphism presents another special challenge. While most species show limited sexual dimorphism that does not go beyond minor size and coloration differences, some species exhibit pronounced differences between the sexes (see Material and Methods for discussion of association between male and female specimens). Based on observations that of closely related genera does not exhibit strong sexual dimorphism, I here hypothesize that pronounced sexual dimorphism is a derived condition within *Zelus*. Several species are possibly mimics of various other insects. *Zelus errans* Hart, 1987 and *Z. vespiformis* Fabricius, 1803 have a habitus similar to many braconid wasps, a very common form of mimicry seen across the insect world. *Zelus larticornis* (Herrich-Schäffer, 1853) and *Z. ruficeps* Stål, 1862 have red and

dark markings, a coloration pattern found in many species of pyrrhocorids and coreids. Interestingly, in the former species, it is only the female showing this coloration. *Zelus longipes* is clearly a mimic of the milkweed bug, *Oncopeltus fasciatus* (Dallas).

### *Species groups*

Following Hart (1972) and with modifications, ten species groups are recognized in the current study, primarily based on characters of the male genitalia. Several species for which only female specimens are known are therefore not assigned to a species group. Although the groupings proposed here are not based on a formal cladistic analysis, they are largely congruent with the relationships recovered by the phylogenetic analysis based on molecular data presented in Chapter 3 (Fig. 3.1). A brief discussion of the species groups and their potential diagnostic characters is presented as follows.

#### 1. *tetracanthus* species group.

Members: *Zelus minutus* Hart 1987, *Zelus prolixus* Stål, 1860, *Zelus rosolentus* **sp. nov.** and *Zelus tetracanthus* Stål, 1862. Members of this group have a rather wide and indistinct medial process, the base of which is nearly continuous with the ventral rim of the pygophore. It is suspected that this character represents a plesiomorphic condition as it is seen in several other genera of New World Harpactorini and therefore the monophyly of this group will need to be tested. *Zelus tetracanthus* and *Z. minutus* also both have posterior pronotal tubercles, more pronounced in the former. Species of this group are widely distributed. *Zelus tetracanthus* and *Z. minutus* are some of the few species that occur across the New World.

#### 2. *luridus* species group.

Members: *Zelus ambulans* Stål, 1862, *Zelus antiguensis* **sp. nov.**, *Zelus exsanguis* Stål, 1862, *Zelus grandoculus* **sp. nov.**, *Zelus luridus* Stål, 1862 and *Zelus*

*spatulosus* **sp. nov.** This is a group of species with primarily North American distribution, with some species extending to northern Central America. The males show an apically enlarged paramere and a broadly triangular medial process that has a protrusion at the base. Also, three of the species have the humeral angle elevated to about the same level as the disc of the posterior pronotal lobe, a condition rarely seen in the genus. The coloration is quite homogenous among members of this genus, most of which have a uniform greenish (in live specimens) or dull brownish habitus, with only *ambulans* showing variable patterns on the pronotum and legs.

### 3. *mimus* species group

Members: *Zelus inconstans* Champion, 1898, *Zelus mimus* Stål 1862. Members of this group, consisting of only 2 species, exhibit a highly unique paramere and medial process of the pygophore. The paramere is slender and apically curved dorsad at an angle of nearly 90-degrees. The medial process is apically bent, but not hook-like as in many other species.

### 4. *nugax* species group.

Members: *Zelus grassans* Stål, 1862, *Zelus illotus* Berg, 1879, *Zelus impar* Kuhlitz, 1902, *Zelus nugax* Stål, 1862 and *Zelus pedestris* Fabricius, 1803. This is a group of smallish species with diverse distribution ranges. The defining characters include a slender, compressed paramere that is curved and recurved, a slender, laterally compressed medial process, and a sharp, apically tapering apex of the dorsal phallosomal sclerite (except for *grassans*). *Zelus nugax* has one of the widest distributions in this genus, ranging from much of Mexico to Northern South America. Its species identify can be easily confused with *pedestris* (see discussion in respective

species). *Zelus grassans* is found primarily in Central America and the remaining two species mainly in northern South America.

5. *puertoricensis* species group.

Members: *Zelus bruneri* De Zayas, 1960, *Zelus puertoricensis* Hart, 1987, *Zelus subimpressus* Stål, 1872 and *Zelus zayasi* Bruner and Barber, 1937. Members of this group are restricted to the Caribbean. They can be easily recognized by the rather slender body form. The posteriorly directed, robust medial process with a somewhat blunt apical protrusion is also distinctive of this group. The basal plate arms are widely separate and diverging and these features are rare in other species in the genus. They show resemblance to species of the next group, especially to *Z. cervicalis*. *Zelus bruneri* was not physically examined, but the rather slender body form as seen in the original illustration place it with certainty within this group.

6. *renardii* species group.

Members: *Zelus cervicalis* Stål, 1872 and *Zelus renardii* Kolenati, 1856. The two members of this group are very likely sister species since they share a number of unique characters: the apex of the medial process is greatly bent ventrad and somewhat hook-like; the lateral margin of the dorsal phallothecal sclerite is recurved dorsad and the basal part of the struts is absent. Evidence suggests that *Z. cervicalis* is related to species of the preceding group in that they share a posterior constriction. This relationship would have bearing on the historical biogeographical scenarios of the origin of the Caribbean species of *Zelus*.

7. *armillatus* species group.

Members: *Zelus amblycephalus* **sp. nov.**, *Zelus annulosus* (Stål, 1866), *Zelus armillatus* (Lepelletier & Serville, 1825), *Zelus conjungens* (Stål, 1860), *Zelus janus* Stål,



1862, *Zelus leucogrammus* (Perty, 1833), *Zelus lewisi* **sp. nov.**, *Zelus litigiosus* Stål, 1862, *Zelus ruficeps*, *Zelus sulcicollis* Champion, 1899, *Zelus umbraculoides* **sp. nov.** and *Zelus umbraculus* **sp. nov.** This is one of the two largest groups in the genus (the other being the *panamensis* group). Species in this group are generally rather large (15-25mm), and some are among the largest in the genus. The most distinctive character is that of the medial process, which has the apex slightly projected into two minute or small lateral prongs or processes. This condition is different from that in several genus groups listed below, where the apex of the medial process is more hook-like and more strongly projected. The pygophore of members of this genus is generally somewhat more rounded than in those of other species groups. The dorsal phallothecal sclerite having a lateral expansion or projection close to the basal arm is also unique to species of this group. This character is not seen in *Z. amblycephalus* or *Z. umbraculus*, two species that appear to be divergent from the remainder of the group, but the feature of the medial process unambiguously places the two species in this species group.

8. *vagans* species group.

Members: *Zelus aithaleos* **sp. nov.**, *Zelus bahiaensis* **sp. nov.**, *Zelus championi* **sp. nov.**, *Zelus errans* Fabricius, 1803, *Zelus fuliginatus* **sp. nov.**, *Zelus gracilipes* **sp. nov.**, *Zelus longipes* (Linnaeus, 1767), *Zelus means* Fabricius, 1803, *Zelus vagans* Fabricius, 1803 and *Zelus vespiformis* Hart, 1987. Among the groups defined herein, this species group is the most heterogeneous. Diagnostic characters are the dense, spine-like pubescence on the head and pronotum and the rounded, unarmed humeral angle of the posterior pronotal lobe. The former character is potentially homoplastic as it is also seen in two species in the *armillatus* group. The condition of the humeral angle is unique within *Zelus* and it is primarily based on this character that this group is erected. Two

general forms of the male genitalia are seen in this group. The medial process in four species, *Z. bahiaensis*, *Z. errans*, *Z. longipes* and *Z. vespiformis* is rather slender and this condition is among the most extreme in the genus. In the second configuration, the medial process appears somewhat cone-shaped in that the base is relatively broad and it gradually narrows through to the apical part, which is also laterally compressed. This is seen in the remainder of the species (except for *Z. means*, for which only the female is known). Furthermore, in this latter group, the phallus is elongated. Another interesting feature found in this group is a wasp mimicking habitus, where the body shows alternating black and yellow or orange areas. This is evident in *Z. errans* and *Z. vespiformis*. It is less clear whether *Z. vagans* can be considered as a wasp mimic – it does show areas of black and orange colors, however, the posterior pronotal lobe is medially dark and laterally orangish, a pattern deviating from the former two species (uniformly orangish). *Zelus gracilipes* also shows a uniformly orange posterior pronotal lobe, but the hemelytron is dark and lacks any pattern suggestive of a wasp mimic.

9. *panamensis* species group.

Members: *Zelus banksi* **sp. nov.**, *Zelus chamaeleon* Stål, 1872, *Zelus cordazulus* **sp. nov.**, *Zelus filicauda* Bergroth, 1893, *Zelus gilboventris* **sp. nov.**, *Zelus korystos* Hart, 1987, *Zelus nigromaculatus* Champion, 1898, *Zelus panamensis* **sp. nov.**, *Zelus truxali* **sp. nov.**, *Zelus varius* (Herrich-Schaeffer, 1853) and *Zelus xouthos* **sp. nov.** This is another large group with 11 species. It is characterized by having an acute apical modification usually in the shape of a hook and the conspicuous medial carination of the apical part of the dorsal phallothecal sclerite. The condition of the apical modification differs from that in the *armillatus* group in that it is much more prominent, usually acute and sometimes extending further ventrad. Sexual dimorphism is

pronounced in some species in this group (e.g., *Z. gilboventris*, ). The female shows drastically different coloration from the male and a much larger body size. Most species in this group are concentrated in southern Central America and northern South America.

10. *erythrocephalus* species group.

Members: *Zelus auralanus* **sp. nov.**, *Zelus casii* **sp. nov.**, *Zelus erythrocephalus* Fabricius, 1803, *Zelus kartabenoides* **sp. nov.**, *Zelus kartabensis* Haviland, 1931, *Zelus laticornis* (Herrich-Schäffer, 1853), *Zelus mattogrossensis* Wygodzinsky, 1947, *Zelus paracephalus* **sp. nov.**, *Zelus russulumus* **sp. nov.** and *Zelus versicolor* (Herrich-Schäffer, 1848). Two diagnostic characters identify members of this group. The medial process possesses a modification that is either subapical or apical, but extending ventrad to a subapical position on the body of the medial process. The part that is projecting away from the medial process in this latter situation is therefore subapical. The second feature is the generally apically oriented lateral sharp process or projection on the dorsal phallothecal sclerite that is continuous with the basal arms. This is not to be confused with the lateral expansion seen in the *armillatus* group where a lateral expansion also exists, but the direction of the expansion is laterad. In *Z. auralanus* and *Z. versicolor*, this process is short and appears dorsad, rather than being apically directed. Two possible sister species, *Z. kartabenoides* and *Z. kartabensis* lack this structure. Their membership of this group is primarily based on the configuration of the medial process and the absence of characters of other groups. Also, the longitudinal ridge-like elevation or hook on the medial process is similar to the condition in another species, *Z. laticornis*, albeit the latter having a short modification. This species is clearly a member of the *erythrocephalus* group. It is a question whether the lateral expansion in *armillatus* group and the current group are homologous. The positions of the structures

are similar, both close to the basal arms, but the shape of the modification is quite drastically different and no intermediate forms are observed. No other characters seem to suggest a common ancestry of the two groups. Pronounced sexual dimorphism is seen in some but not all species of this group. Of those, *Z. laticornis* stands out as the male is rather indelible in coloration (with some minor banding), and the female strikingly resemble coreid bugs in the genus *Hypselonotus*. Notably, three species, *Z. erythrocephalus*, *Z. paracephalus* and *Z. russulumus* have purple, blue or greenish iridescence on the membrane of the hemelytron. Species of this group shows a predominantly southern South America distribution, with a few found in the Amazon region.

Because of the heavy emphasis on male genitalic characters for species grouping, three species described only from female are not placed in any of the species groups defined above. These are: *Zelus fasciatus*, *Z. plagiatus* and *Z. sphegeus*. The former is similar to the females of some of the species in the *panamensis* group and also occurs in an overlapping geographical region (southern Central America). The latter two species show resemblance to the female of *Z. versicolor* in the *erythrocephalus* species group. Future cladistic analysis, including morphological and molecular data, will test the composition of these species groups and have also the potential to place these female-based species.

Furthermore, 5 species are removed from *Zelus* and they are: *Z. araneiformis* Haviland, 1931, *Z. gradarius* Bergroth, 1905, *Z. iopterus* (Perty, 1832), *Z. modestus* (Stål, 1862) and *Z. vittaticeps*, Stål, 1866. These species represent an undescribed genus and will be treated in a separate study.

*Descriptions of species of Zelus*

***Zelus minutus* Hart, 1987** Figs 4.1, 4.9, 4.19.

HOLOTYPE: **SURINAME: Commewijne:** Leliendaal, 17 Mar 1963, P.H. v. Doesburg 1;m (UCR\_ENT 00040915) (NHRS).

*Zelus minutus* Hart, 1987, orig. descr.

DIAGNOSIS: This species can be readily recognized by the small size and the posterior lobe with spinous tubercles. The male can be recognized among the *tetracanthus* group by the relatively long paramere, exceeding the medial process (Fig. 4.9).

DESCRIPTION: **MALE:** Small, total length 7.80–10.13 (mean 9.00, Table 4.2); slender. **COLORATION:** Yellowish-brown to brownish-black, shining. Antennae yellowish-brown to brown, apex of I and II and base of II darker than remainder of segments. Anterior pronotal lobe yellowish-brown to brownish-black, shining. Posterior pronotal lobe yellowish-brown to brownish-black, pattern variable, medial and lateral areas lightest in dark specimens. Scutellum yellowish-brown, apex lighter than surrounding area. Legs yellowish-brown with two to four brown rings on apical 1/2 of femora, variable brown areas on tibiae. Clavus and corium yellowish-brown to brown, darkest along costal margin, membrane nearly clear, veins dark brown. Dorsum of abdomen yellowish-brown to dark brown, pattern variable, lateral surfaces yellowish-brown. Pygophore yellowish-brown to brown, parameres dark brown to brownish-black. **VESTITURE:** Moderately setose. Scattered erect and decumbent setae over entire surface of head, longer ventrally. Anterior pronotal lobe with very sparse short decumbent setae on reduced setal tracts dorsally, more dense laterally; posterior pronotal lobe with short decumbent setae over entire surface, some

erect setae laterally; scutellum with long decumbent setae. Abdominal venter with sparse short to long erect setae. Parameres with erect setae. **STRUCTURE: Head:** Cylindrical, L/W = 2.13. Postocular lobe long; in dorsal view distinctly narrowing through anterior 2/3, posterior 1/3 constant, tube-like. Eye prominent; lateral margin much wider than postocular lobe; dorsal margin removed from postocular transverse groove, ventral margins attaining ventral surface of head in lateral view. *Labium:* I: II: III = 1: 2.0: 0.5. Basiflagellomere diameter larger than that of pedicel. **Thorax:** Antero-lateral angle with inconspicuous subtuberculate projection; medial longitudinal sulcus shallow near collar, deepening posteriorly. Posterior pronotal lobe with rugulose surface; disc slightly elevated above humeral angle; humeral angle rounded, without projection. Scutellum moderately long; apex angulate, very slightly projected upward. *Legs:* Slender. *Hemelytron:* Surpassing apex of abdomen by about length of abdominal segment 7; quadrate cell small; Cu and M of cubital cell subparallel. **GENITALIA: Pygophore:** Elongate ovoid; not expanded laterally in dorsal view. Medial process broadly triangular; short; posteriorly directed, in less than 45-degree with body axis; straight; apex in posterior view angulate, without modification. *Paramere:* Cylindrical; long, surpassing medial process; directed posteriad; basally slightly narrower; nearly straight; apical part very slightly enlarged. *Phallus:* Dorsal phallothecal sclerite somewhat squarish; somewhat enlarged at base; apical portion of phallothecal sclerite not distinctly tapered, flat; apex truncate, medially emarginate; proximal edge broadly concave. Struts attached to dorsal phallothecal sclerite; apically separate, connected by bridge; basally fused. Basal plate arm robust; separate; subparallel; in lateral view nearly straight, very slightly curved; bridge moderately long; extension of basal plate small, marginally expanded onto arm.

*FEMALE*: Similar to male, except for the following. Larger than male, total length 10.7.

DISTRIBUTION: Central America, northern South America.

PARATYPES: **PANAMA: Colon:** Barro Colorado Island, Canal Zone, 9.15472°N 79.84806°W, Oct 1700, M. Bates, 1;m (UCR\_ENT 00017868) (AMNH). Coco Solo, 9.37°N 79.8817°W, 27 Apr 1944, Unknown, 1;m (UCR\_ENT 00030177) (USNM).

**VENEZUELA: Portuguesa:** Guanare, 9.05°N 65.75°W, 173 m, 10 Sep 1957 – 13 Sep 1957, Borys Malkin, 1;m (UCR\_ENT 00019690) (CAS).

***Zelus prolixus* Stål, 1860** Figs 4.1, 4.9, 4.19.

HOLOTYPE: **Brazil:** F. Sahib. 1;m (UCR\_ENT 00040925) (NHRS).

*Euagoras prolixus* Stål, 1860, p. 74, orig. descr.

*Zelus prolixus*, Stål, 1872, p. 89, cat. (subgenus *Zelus*); Lethierry and Severin, 1896, p. 153, cat. ; Wygodzinsky, 1949a; p. 50, checklist; Elkins, 1954, p. 39, 40, note.

Identifications not verified:

*Euagoras prolixus*, Walker, 1873, p. 118, cat.

*Zelus prolixus*, Champion, 1898, p. 255, note.

DIAGNOSIS: Distinguished by the greenish coloration; the veins of membrane darker than the cells; the smallish size; the rather slender body and legs; the head somewhat dorso-ventrally flattened; and the eye somewhat elongated. The male can be recognized by the base of the medial process indistinct from the postero-ventral rim of the pygophore and the short paramere not exceeding the medial process (Fig. 4.9).

DESCRIPTION: *MALE*: Small, total length 8.64–10.10 (mean 9.35, Table 4.2); very slender. **COLORATION**: Pale or greenish brown. Single ring near femoral apices; tibiae

banded. **VESTITURE:** Sparsely setose. Dorsum of head and anterior pronotal lobe with very sparse short, erect and decumbent setae. Head ventrally with long, erect setae. Posterior pronotal lobe and hemelytron with dense, short, decumbent setae. Abdominal venter with moderately dense, short, decumbent and short to moderately long, erect setae. Paramere apex with sparse, short setae. Antecular lobe nearly glabrous except for some sparse, erect setae; recumbent and erect setae on remainder of surface of head. Dorsal surface of anterior pronotal lobe nearly glabrous, some recumbent setae on lateral surface; recumbent setae on entire surface of posterior pronotal lobe. Abdomen with scattered, short, recumbent setae, sparse erect setae. **STRUCTURE:**

**Head:** Dorso-ventrally flat, L/W = 2.25. Postocular lobe short; in dorsal view anteriorly gradually narrowing, posterior portion constant, slightly narrower. Eye moderately sized; lateral margin only slightly wider, roughly on line with margin of postocular lobe; dorsal margin removed from postocular transverse groove, ventral margins attaining ventral surface of head in lateral view. *Labium:* I: II: III = 1: 2.3: 0.5. Basiflagellomere diameter larger than that of pedicel. **Thorax:** Antero-lateral angle rounded, without projection; medial longitudinal sulcus evident only on posterior 1/2, deepening anterior to transverse sulcus of pronotum. Posterior pronotal lobe with rugulose surface; disc distinctly elevated above humeral angle; humeral angle rounded, without projection. Scutellum long; apex angulate, not projected. *Legs:* Very slender. *Hemelytron:* Surpassing apex of abdomen by about length of abdominal segment 7; quadrate cell small and slender; Cu and M of cubital cell subparallel. **GENITALIA:** *Pygophore:* Ovoid; not expanded laterally in dorsal view. Medial process broadly triangular; very short; semi-erect; nearly straight; apex in posterior view blunt, without modification. *Paramere:* Cylindrical; short, not reaching apex of medial process; directed posteriad; nearly straight; apical part not



enlarged. *Phallus*: Dorsal phallothecal sclerite somewhat squarish; small longitudinal dorso-lateral ridge; apical portion of phallothecal sclerite not distinctly tapered, flat, laterally rounded, not forming angle; apex truncate; proximal edge broadly concave. Struts attached to dorsal phallothecal sclerite; apically fused; basally almost completely fused. Basal plate arm slender; separate; subparallel; in lateral view nearly straight, very slightly curved; bridge moderately long; extension of basal plate expanded onto arm.

*FEMALE*: Similar to male, except for the following. Larger than male, total length 10.29–11.79 (mean 11.10, Table 4.2). Hemelytron attaining apex of abdomen.

*DISTRIBUTION*: South America.

*DISCUSSION*: The feature of the male genitalia is rather similar to those in *minutus*, *rosulentus* and *tetracanthus*. But *prolixus* can be unambiguously distinguished from these three species by its general body shape and coloration for both sexes.

***Zelus rosulentus* sp. nov.** Figs 4.1, 4.19.

*HOLOTYPE*: **ECUADOR: Orellana**: Reserva Etnica Waorani, 1 km S. Onkone Gare Camp, Transect Ent., 0.65713°S 76.453°W, 216 m, 30 Sep 1996, T. L. Erwin et al., 1;m (UCR\_ENT 00009487) (USNM).

*DIAGNOSIS*: Recognized by the pink coloration; the rather slender legs. The male is recognized by the rather broad base of the medial process, nearly continuous with the postero-ventral rim of the pygophore.

*DESCRIPTION*: *MALE*: Medium-sized, total length 11.49–12.39 (mean 11.97, Table 4.2); very slender. **COLORATION**: Entire surface pink; areas on hemelytron lighter, sometimes apex of membrane darkened. Femora subapically with single dark band.

**VESTITURE**: Moderately setose. **STRUCTURE: Head**: Cylindrical, L/W = 2.00.

Postocular lobe long; in dorsal view distinctly narrowing through anterior 2/3, posterior 1/3 constant, tube-like. Eye prominent; lateral margin only slightly wider, roughly on line with margin of postocular lobe; dorsal margin removed from postocular transverse groove, ventral margins attaining ventral surface of head in lateral view. *Labium*: I: II: III = 1: 2.1: 0.5. Basiflagellomere diameter slightly larger than that of pedicel. **Thorax**: Antero-lateral angle rounded, without projection; medial longitudinal sulcus shallow near collar, deepening posteriorly. Posterior pronotal lobe with smooth surface; disc distinctly elevated above humeral angle; humeral angle armed, with short tuberculate processes. Apex angulate. *Legs*: Very slender. *Hemelytron*: Surpassing apex of abdomen by about length of abdominal segment 7; quadrate cell large and broad; Cu and M of cubital cell subparallel. **GENITALIA**: *Pygophore*: Rounded; slightly expanded laterally near base of paramere in dorsal view. Medial process broadly triangular; short; semi-erect; straight; basally without protrusion; apex in posterior view blunt, without modification. *Paramere*: Cylindrical; moderately long, slightly exceeding medial process; directed posteriad; nearly straight; apical part not enlarged.

*FEMALE*: Unknown.

ETYMOLOGY: The specific epithet indicates the pink coloration of this species.

DISTRIBUTION: South America.

PARATYPES: **ECUADOR: Orellana**: Reserva Etnica Waorani, 1 km S. Onkone Gare Camp, Transect Ent., 0.65713°S 76.453°W, 216 m, 10 Feb 1995, T. L. Erwin et al., 1;m (UCR\_ENT 00009485) (USNM); 12 Feb 1995, T. L. Erwin et al., 1;m (UCR\_ENT 00009488) (USNM); 07 Feb 1996, T. L. Erwin et al., 1;m (UCR\_ENT 00009486) (USNM); 21 Jun 1996, T. L. Erwin et al., 1;m (UCR\_ENT 00009484) (USNM).

***Zelus tetracanthus* Stål, 1862** Figs 4.1, 4.9, 4.20.

HOLOTYPE: **MEXICO**: Signoret, 1;m (UCR\_ENT 00075078) (NHMW).

*Zelus tetracanthus* Stål , 1862, p. 454, orig. descr. (subgenus *Pindus* ) ; Stål , 1872, p. 92, cat. (subgenus *Pindus*); Lethierry and Severin, 1896, p. 153, cat.; Champion, 1898, p. 362, Tab. XV, fig. 27, note and fig.; Fracker, 1913, p. 240, key and list (subgenus *Pindus*); Wygodzinsky, 1949a, p. 50, checklist.

*Diplodus tetracanthus*, Uhler, 1886, p. 24, checklist.

*Pindus socius* Uhler, 1872b, p. 420, orig. descr.; Uhler, 186, p. 62, list (reprint) ; Uhler, 1877, p. 1329, list; Uhler, 1894, p. 284, list.

*Diplodus socius*, Uhler, 1886, p. 24, checklist; Gillette and Baker, 1895, p. 60, list.

*Zelus socius*, Lethierry and Severin, 1896, p. 153 cat.; Banks, 1910b, p. 16, cat.; Fracker, 1913, p. 240, key and list (subgenus *Pindus*); Van duzee, 1916, p. 30, checklist (subgenus *Pindus*); Van Duzee, 1917, p. 261, cat. (subgenus *Pindus*); Blatchley, 1926, p. 569, 571, key and descr. (subgenus *Pindus*); Readio, 1927, p. 169, 179-181, P1. XIV. fig. 1,2,5, descr., notes and fig.; Wygodzinsky, 1949a, p. 50, checklist.

*Zelus audax* Banks, 1910, p. 325, orig. descr. (**syn. nov.**); Fracker, 1913, p. 240, note; Van Duzee, 1916, p. 30 checklist (subgenus *Pindus*); Van Duzee, 1917, p. 261, cat. (subgenus *Pindus*); Britton, 1923, p. 687, list (*subgenus Pindus*); Blatchley, 1926, p. 569, 571-572, key and descr. (subgenus *Pindus*); Readio, 1927, p. 169, 181, descr.; Leonard, 1928, p. 105, list; Wygodzinsky, 1949a, p. 48, checklist.

*Zelus occiduus* Torre-Bueno, 1913a, p. 22, orig. descr. (subgenus *Pindus*) (**syn. nov.**); Van Duzee, 1916, p. 30, checklist; Van Duzee, 1917, p. 261, cat. (subgenus *Pindus*) ; Readio, 1927, p. 169, 181-182, key and descr.; Wygodzinsky, 1949a, p.

50, checklist.

*Zelus anquastatus* Hussey, 1925, p. 66-67, orig. descr.; Blatchley, 1926, p. 569, 572, descr. and note (subgenus *Pindus*); Readio, 1927, p. 169, 182., key and descr.; Wygodzinsky, 1949a, p. 48, checklist; Hussey, 1953, p. 9-11, note.

Identifications not verified:

*Diplodus tetracanthus*, Walker, 1873, p. 124, cat.

*Diplocodus socius*, Van Duzee, 1914, p. 13, list and note.

*Zelus socius* Barber, 1906, p. 28,6, list; Hart, 1907, p. 237, list; Torre-Bueno, 1908, p. 235, list (subgenus *Pindus*); Van Duzee, 1909, p. 177, list; Torre-Bueno, 1913, p. 60, list (subgenus *Pindus*); Barber, 1914, p. 506, list; Parshley, 1914, p. 144, list; Parshley, 1921, p. 5, list; Anonymous, 1923, p. 120-135, note; Readio, 1926, p. 168, 177, note and fig.; Leonard, 1928, p. 105, list; Essig, '1929, p. 357, note; Knowlton, 1932, p. 12, note; Harris, 1937, p. 174, list; Brimley, 1938, p. 73, list; Procter, 1946, p. 319, list; Elkins, 1951, p. 410, list; Sibley, 1951, p. 92, list; Elkins, 1954, p. 47, note; Atkins, et. al., 1957, p. 251-259, note; Drew and Schaeffer, 1962, p. 106, list; Wene and Sheets, 1962, p. 395-398, note; Whitcomb and Bell, 1964, p. 22, list; Butler, 1966, p. 1306-1307, note; Nutting and Spangler, 1969, p. 763-769, note and photo.

*Zelus audax*, Britton, 1923, p. 685-687, note (subgenus *Pindus*); Leonard, 1928, p. 105, list.

*Zelus occiduus*, Elkins, 1951, p. 410, list.

*Zelus anquastatus*, Blatchley, 1928, p. 6, note (subgenus *Pindus*); Elkins, 1951, p. 410, list.

DIAGNOSIS: Recognized by the disc of the posterior pronotal lobe with tubercles; the generally greyish black coloration. The male can be recognized by the base of the medial process broad, continuous with postero-ventral rim of the pygophore; the dorsal phalloshecal sclerite apically with deep emargination.

DESCRIPTION: *MALE*: Medium-sized, total length 11.34–13.73 (mean 12.36, Table 4.2); slender. **COLORATION**: Brown to black. Anteocular lobe dark reddish-brown to brownish-black, variable yellowish-brown areas usually present dorso-laterally anterior to compound eyes, dorsally and medially at antennal bases, and on lateral and ventral surfaces. Postocular lobe dark reddish-brown with lighter areas between ocelli and compound eyes, along mid-dorsal line, longitudinally on lateral and ventral surface. Labium reddish-brown to brownish-black with anterior surface of segment I lighter in color, yellowish-brown to reddish brown. Antennal segments I and II reddish-brown, outer dorsolateral surface of I darker, especially near base, base and apex of II darker, segments III and IV yellowish-brown to reddish-brown. Anterior pronotal lobe reddish-brown to brownish-black, occasionally with variable lighter areas, especially near margins, lateral surface reddish brown to brownish black, usually lighter ventrally. Posterior pronotal lobe reddish brown to brownish-black with dark yellowish-brown posterior margin and/or darker reddish brown to brownish-black apices on lateral and dorsal processes. Scutellum variably yellowish-brown to brownish-black, usually with lighter apex. Legs yellowish-brown to reddish-brown, usually with variable darker reddish-brown spots or bands, especially near dorsal surfaces of femoral apices. Hemelytron brown to dark brown, veins in area anterior to basal and discal cells lighter. Abdomen variable, dark yellowish-brown to reddish-brown, darker areas usually at posterior of segments of connexivum and mid-laterally at anterior of segments 3–7.

Abdomen yellowish-brown with variable reddish-brown areas on lateral and posterior margins and posterior surface. **VESTITURE:** Moderately setose. Short decumbent and short to long erect setae, many specimens covered with white waxlike exudation. Antecular lobe with short decumbent setae on entire surface, longer erect setae on tylus and ventral surface; postocular lobe with short decumbent setae over entire surface, moderate to long erect setae on postero-dorsal and ventral surfaces. Entire surface of anterior pronotal lobe with short decumbent and erect setae, confined to setal tracts dorsally, longer erect setae laterally; posterior lobe with short decumbent setae over surface, some long erect setae laterally; scutellum setae short, decumbent to semi-erect. Corium and clavus with short, recumbent setae. Abdominal dorsum with sparse short erect setae, remainder of surface with short decumbent and sparse moderate erect setae. Exposed surface of pygophore with short to long semi-erect and erect setae, especially posteriorly. **STRUCTURE: Head:** Elongated, L/W = 2.63. Postocular lobe long; in dorsal view anteriorly gradually narrowing, posterior portion constant, slightly narrower. Eye moderately sized; lateral margin only slightly wider, roughly on line with margin of postocular lobe; margins removed from dorsal and ventral surfaces of head in lateral view. *Labium:* I: II: III = 1: 2.3: 0.4. Basiflagellomere diameter larger than that of pedicel. **Thorax:** Antero-lateral angle rounded, without projection; medial longitudinal sulcus shallow near collar, deepening posteriorly. Posterior pronotal lobe with finely rugulose surface; disc slightly elevated above humeral angle; humeral angle armed, with short tuberculate processes. Scutellum moderately long; apex angulate, very slightly projected upward. *Legs:* Slender. *Hemelytron:* Surpassing apex of abdomen by about length of abdominal segment 7; quadrate cell small and slender; Cu and M of cubital cell subparallel. **GENITALIA:** *Pygophore:* Ovoid; not expanded laterally in dorsal view.

Medial process broadly triangular; very short; semi-erect; straight; apex in posterior view blunt, without modification. *Paramere*: Cylindrical; short, not reaching apex of medial process; directed posteriad; nearly straight; apical part enlarged. *Phallus*: Dorsal phallosomal sclerite somewhat ovoid; apical portion of phallosomal sclerite not distinctly tapered, slightly convex; apex medially notched; proximal edge nearly straight. Struts attached to dorsal phallosomal sclerite; apically separate, connected by bridge; basally fused. Basal plate arm slender; separate; subparallel; in lateral view very slightly curved; bridge long; extension of basal plate small and confined to apex of basal plate arm.

*FEMALE*: Similar to male, except for the following. Larger than male, total length 13.22–15.63 (mean 14.43, Table 4.2). Often darker than male. Tuberculate processes of posterior pronotal lobe usually more pronounced, apex often produced. Mid femur slightly swollen on central 1/4, fore and mid femoral diameters subequal, about 1.4–1.5x diameter of hind femur. Hemelytron attaining apex of abdomen.

*DISTRIBUTION*: Throughout the New World (except for the Caribbean).

*DISCUSSION*: The tuberculate posterior pronotal lobe can distinguish *Z. tetracanthus* from all other species except for *Z. minutus*, but the two can be easily separated based on coloration and body shape. This is a rather widely distributed species, found nearly throughout North America, ranging from southern Canada to part of Central America. A few records were also from Brazil and Paraguay. As the collecting events of these specimens are unrelated, it is highly unlikely these specimens are mislabelled.

***Zelus ambulans* Stål, 1862** Figs 4.1, 4.10, 4.21.

LECTOTYPE: **MEXICO:** salle, 1;m (UCR\_ENT 00040998) (NHRS) (**new designation**).

*Zelus ambulans* Stål, 1862, p. 451, orig. descr.; Stål, 1872, p. 91, cat. (sag. *Diplodus*);

Lethierry and Severin, 1896, p. 151, cat. Champion, 1898, p. 259–260, Tab. XV.

fig. 23, 23a; syn. (of *Z. exsanguis*).

*Diplodus ambulans*, Uhler, 1886, p. 24, checklist.

Identifications not verified:

*Diplodus ambulans*, Walker, 1873, cat.

DIAGNOSIS: Recognized by the humeral angle raised to the level of the disc of the posterior pronotal lobe. The male is recognized by the relatively slender medial process among species of the *ambulans* group and the apical enlargement of the paramer smaller than that in *Z. spatulosus* and *Z. exsanguis*, but larger than that in *Z. granduculus* and *Z. luridus* and *Z. antiguensis*.

DESCRIPTION: **MALE:** Medium-sized, total length 12.89–15.19 (mean 14.27, Table 4.2); slender. **COLORATION:** Dorsal surface brown; yellowish areas on head, anterior pronotal lobe, veins of corium. Legs yellowish, apices dark brown. Lateral surfaces and abdomen yellowish. **VESTITURE:** Moderately setose. Anteocular lobe with recumbent and erect setae on entire surface; postocular lobe with recumbent and scattered erect setae. Anterior pronotal lobe with erect and recumbent setae confined to setal tracts, erect setae laterally; posterior pronotal lobe with recumbent setae. Abdomen with recumbent and scattered erect setae. **STRUCTURE: Head:** Cylindrical, L/W = 2.30. Postocular lobe long; in dorsal view anteriorly gradually narrowing, posterior portion constant, slightly narrower. Eye moderately sized; lateral margin only slightly wider,



roughly on line with margin of postocular lobe; margins removed from dorsal and ventral surfaces of head in lateral view. *Labium*: I: II: III = 1: 1.8: 0.4. Basiflagellomere diameter larger than that of pedicel. **Thorax**: Antero-lateral angle with inconspicuous subtuberculate projection; medial longitudinal sulcus evident only on posterior 1/2, deepening anterior to transverse sulcus of pronotum. Posterior pronotal lobe with finely rugulose surface; disc about same level as humeral angle; humeral angle armed, with spinous processes. Scutellum short; apex blunt, not projected. *Legs*: Slender. *Hemelytron*: Surpassing apex of abdomen by about length of abdominal segment 7; quadrate cell small; Cu and M of cubital cell subparallel. **GENITALIA**: *Pygophore*: Elongate ovoid; not expanded laterally in dorsal view. Medial process triangular; broad; moderately long; semi-erect; nearly straight; apex in posterior view blunt, without modification. *Paramere*: Cylindrical; moderately long, nearly reaching apex of medial process; slightly curved ventrad; apical part enlarged. *Phallus*: Dorsal phallosclerite elongated; medially slightly constricted; apical portion of phallosclerite not distinctly tapered, slightly convex; apex truncate, medially emarginate; proximal edge broadly concave. Struts attached to dorsal phallosclerite; apically separate, connected by bridge; basally separate. Basal plate arm moderately robust; separate; converging; in lateral view nearly straight, very slightly curved; bridge short; extension of basal plate small and confined to apex of basal plate arm.

*FEMALE*: Similar to male, except for the following. Larger than male, total length 15.43–18.59 (mean 16.55, Table 4.2). Legs more or less uniformly colored, apices somewhat reddish.

**DISTRIBUTION**: North America, Central America.

***Zelus antiguensis* sp. nov.** Figs 4.1, 4.9, 4.21.

HOLOTYPE: **GUATEMALA: Sacatepequez:** Antigua, 14.5611°N 90.7344°W, 1583 m, 01 Jan 1700, B. Lott, 2;m (UCR\_ENT 00007955, UCR\_ENT 00007995) (USNM).

DIAGNOSIS: The male can be recognized by the base of the medial process extended; the apex of the paramere not greatly enlarged; and the phallosheath sclerite rather short.

DESCRIPTION: *MALE*: Medium-sized, total length 13.69–16.28 (mean 14.98, Table 4.2); slender. **COLORATION**: Dorsum dark brown; lateral processes on humeral angles darker; lateral surfaces and legs brown; apices of femora reddish. **VESTITURE**: Moderately setose. Antecular lobe with recumbent setae, erect setae sparse; postocular lobe with recumbent setae dorsally, long and fine setae postero-ventrally and on lateral surfaces. Anterior pronotal lobe with recumbent and short, erect setae, scattered on lateral surfaces; posterior pronotal lobe with short, recumbent and erect setae on entire surface. Abdomen with short, recumbent and longer erect setae on lateral and ventral surfaces, moderate to long erect setae postero-ventrally on segment 7. **STRUCTURE: Head**: Cylindrical, L/W = 2.29. Postocular lobe relatively short; in dorsal view anteriorly gradually narrowing, posterior portion constant, slightly narrower. Eye moderately sized; lateral margin only slightly wider, roughly on line with margin of postocular lobe; dorsal margin attaining postocular transverse groove, ventral margin removed from ventral surface of head in lateral view. *Labium*: I: II: III = 1: 1.8: 0.6. Basiflagellomere diameter larger than that of pedicel. **Thorax**: Antero-lateral angle rounded, without projection; medial longitudinal sulcus shallow near collar, deepening posteriorly. Posterior pronotal lobe with finely rugulose surface; disc slightly elevated

above humeral angle; humeral angle armed, with short tuberculate processes. Scutellum moderately long; apex angulate, not projected. *Legs*: Slender. *Hemelytron*: Surpassing apex of abdomen by about length of abdominal segment 7; quadrate cell small, elongate; Cu and M of cubital cell subparallel. **GENITALIA**: *Pygophore*: Elongate ovoid; not expanded laterally in dorsal view. Medial process triangular; broad; moderately long; semi-erect; nearly straight; apex in posterior view blunt, without modification. *Paramere*: Cylindrical; moderately long, nearly reaching apex of medial process; not distinctly curved; apical part very slightly enlarged. *Phallus*: Dorsal phallothecal sclerite somewhat squarish; medially slightly constricted; apical portion of phallothecal sclerite not distinctly tapered, flat; apex truncate, medially emarginate; proximal edge broadly concave. Struts attached to dorsal phallothecal sclerite; apically separate, connected by bridge; basally mostly separate, moderately fused. Basal plate arm slender; separate; converging; in lateral view nearly straight, very slightly curved; bridge moderately long; extension of basal plate small and confined to apex of basal plate arm.

*FEMALE*: Similar to male, except for the following. Larger than male, total length 15.77–18.15 (mean 16.91, Table 4.2). Coloration very similar to that in male, slightly lighter overall.

ETYMOLOGY: Named after the type locality, Antigua, in Guatemala.

DISTRIBUTION: Mexico.

PARATYPES: **GUATEMALA: Sacatepequez**: Antigua, 14.5611°N 90.7344°W, 1583 m, 12 Sep 1951, R. H. Painter, 1;f (UCR\_ENT 00029478) (USNM). **MEXICO**: Pine Forst 87 miles S of Manzanitla, 01 Dec 1948, E. S. Ross, 1;f (UCR\_ENT 00019699) (CAS). **GUATEMALA: Sacatepequez**: Antigua, 14.5611°N 90.7344°W, 1583 m, 01 Jul 1930, D. M. Bates, 1;f (UCR\_ENT 00015069) (AMNH). **MEXICO: Chiapas**: Tuxtla

Gutierrez, 16.75469°N 93.11485°W, 549 m, 06 Jul 1955 – 10 Jul 1955, P. & C. Vaurie, 1;f (UCR\_ENT 00017184) (AMNH). Jalisco: 6 mi W of Chapala, 20.29709°N 103.28149°W, 30 Jun 1963, J. Doyen, 1;f (UCR\_ENT 00038423) (UCB). unknown: Jalapa, 1700, Unknown, 1;f (UCR\_ENT 00023699) (RMNH).

***Zelus cognatus* (Costa, 1864)**

*Diplodus cognatus* Costa, 1864, p. 81, orig. descr.; Uhler, 1886, p. 24, checklist.

*Zelus cognatus*, Stål, 1872, p. 91, cat. (subgenus *Diplodus*); Lethierry and Severin, 1896, p. 151, cat.; Champion, 1898, p. 259–260, syn. (=Z. *exsanguis* Stål).

Identifications not verified:

*Diplodus cognatus*, Walker, 1873, p. 125, cat.

This species was originally described from a single specimen from Mexico. The original description did not indicate its sex. Champion's synonymy was apparently based on the description and not upon examination of the specimen.

***Zelus exsanguis* Stål, 1862** (Figs 4.1, 4.9, 4.21).

LECTOTYPE: **MEXICO**: salle, 1;m (UCR\_ENT 00041004) (NHRS).

*Zelus exsanguis* Stål, 1862, p. 452, orig. descr.; Stål, 1872, p. 91, cat. (subgenus *Diplodus*); Lethierry and Severin, 1896, p. 152, cat.; Champion, 1898, p. 259–260, syn. (of Z. *Luridus* Stål, Z. *ambulans* Stål and Z. *cognatus* Costa); Banks, 1910, p. 16, cat.; Fracker, 1913, p- 239, 240, 241, key, list and note (subgenus *Diplodus*); Van Duzee, 1916, p. 30, checklist (subgenus *Diplodus*); Van Duzee, 1917, p. 260, cat. (subgenus *Diplodus*); Wygodzinsky, 1949a, p. 49, checklist; Hart, 1986, p. 539, Lectotype desig.

*Diplodus exsanguis*, Uhler, 1886, p. 24, checklist.

Identifications not verified:

*Diplodus exsanguis*, Walker, 1873, p. 124, cat.; Uhler, 1894, p. 283, list.

**DIAGNOSIS:** The male is distinguished from species of the *ambulans* group by the greatly enlarged apical part of the paramere; the medial process moderately broad; and the apex of the medial process somewhat narrowed. Can also be distinguished from several species of the same group by the disc of the posterior pronotal lobe elevated above humeral angles.

**DESCRIPTION:** *MALE:* Medium-sized, total length 13.79–16.41 (mean 14.98, Table 4.2); slender. **COLORATION:** Dorsal surface brown to dark brown, slightly lighter on anterior pronotal lobe; blackish brown markings on head. Lateral surfaces, legs and abdomen yellowish brown; apices of femora reddish. **VESTITURE:** Moderately setose. Anteocular lobe with short recumbent setae dorsally and laterally, short to moderately long erect setae on ventral surface; postocular lobe with short, recumbent setae on dorsal and lateral surfaces, moderately erect setae scattered over surface, long, fine setae laterally. Anterior pronotal lobe with short, recumbent setae; posterior pronotal lobe with recumbent and sparse, erect setae. Abdomen with short, recumbent and short to moderately long erect setae. **STRUCTURE: Head:** Cylindrical, L/W = 2.31. Postocular lobe moderately long; in dorsal view anteriorly gradually narrowing, posterior portion constant, slightly narrower. Eye smallish; lateral margin only slightly wider, roughly on line with margin of postocular lobe; margins removed from dorsal and ventral surfaces of head in lateral view. *Labium:* I: II: III = 1: 1.8: 0.5. Basiflagellomere diameter larger than that of pedicel. **Thorax:** Antero-lateral angle with inconspicuous subtuberculate projection; medial longitudinal sulcus shallow near collar, deepening posteriorly. Posterior pronotal lobe with finely rugulose surface; disc about same level as humeral

angle; humeral angle armed, with dentate projection. Scutellum moderately long; apex blunt, not projected. *Legs*: Slender. *Hemelytron*: Surpassing apex of abdomen by about length of abdominal segment 7; quadrate cell small; Cu and M of cubital cell subparallel. **GENITALIA**: *Pygophore*: Elongate ovoid; not expanded laterally in dorsal view. Medial process triangular; broad; moderately long; semi-erect; nearly straight; apex in posterior view blunt, without modification. *Paramere*: Cylindrical; moderately long, slightly exceeding medial process; slightly curved ventrad; apical part enlarged. *Phallus*: Dorsal phallosomal sclerite somewhat squarish; medially slightly constricted; apical portion of phallosomal sclerite not distinctly tapered, flat; apex truncate, medially emarginate; proximal edge broadly inversely V-shaped. Struts attached to dorsal phallosomal sclerite; apically separate, connected by bridge; basally separate. Basal plate arm slender; separate; converging; in lateral view nearly straight, very slightly curved; bridge short; extension of basal plate small and confined to apex of basal plate arm.

*FEMALE*: Similar to male, except for the following. Larger than male, total length 15.12–19.36 (mean 17.00, Table 4.2). Coloration rather similar to that in male; more uniform on head. Lateral process on humeral angle spinous, long. Hemelytron slightly surpassing apex of abdomen.

DISTRIBUTION: North America, Central America.

***Zelus granduculus* sp. nov.** Figs 4.1, 4.9, 4.21.

HOLOTYPE: **GUATEMALA: Sacatepequez:** Antigua, 14.5611°N 90.7344°W, 1583 m, 01 Jan 1700, B. Lott, 1;m (UCR\_ENT 00007999) (USNM).

**DIAGNOSIS:** This is the only species in the genus with the margins of the eye exceeding outline of the head. The paramere is short, slender, without apical enlargement.

**DESCRIPTION:** *MALE:* Medium-sized, total length 14.63 (n=1); slender.

**COLORATION:** Entire surface of body brown, darker on posterior pronotal lobe and apices of femora. **VESTITURE:** Moderately setose. Head with recumbent setae on entire surface. Anterior pronotal lobe with scattered patches of recumbent and semi-erect setae; posterior pronotal lobe with recumbent setae on entire surface. Abdomen with sparse, erect setae on entire surface. **STRUCTURE: Head:** Cylindrical, L/W = 1.75.

Postocular lobe moderately long; in dorsal view anteriorly gradually narrowing, posterior portion constant, slightly narrower. Eye extremely large; lateral margin much wider than postocular lobe; margins beyond dorsal and ventral outlines of head in lateral view.

*Labium:* I: II: III = 1: 1.9: 0.6. Basiflagellomere diameter larger than that of pedicel.

**Thorax:** Antero-lateral angle with inconspicuous subtuberculate projection; medial longitudinal sulcus shallow near collar, deepening posteriorly. Posterior pronotal lobe with finely rugulose surface; disc slightly elevated above humeral angle; humeral angle armed, with dentate projection. Scutellum moderately long; apex blunt, not projected.

*Legs:* Slender. *Hemelytron:* Surpassing apex of abdomen by about length of abdominal segment 7; quadrate cell small, elongate; Cu and M of cubital cell subparallel.

**GENITALIA:** *Pygophore:* Elongate ovoid; not expanded laterally in dorsal view. Medial process triangular; broad; moderately long; semi-erect; nearly straight; apex in posterior view blunt, without modification. *Paramere:* Cylindrical; moderately long, slightly exceeding medial process; slightly curved ventrad; apical part enlarged. *Phallus:* Dorsal phallosheath sclerite somewhat squarish; medially slightly constricted; apical portion of

phallothecal sclerite not distinctly tapered, slightly convex; apex truncate, medially emarginate; proximal edge broadly concave. Struts attached to dorsal phallothecal sclerite; apically separate, connected by bridge; basally separate. Basal plate arm slender; separate; converging; in lateral view nearly straight, very slightly curved; bridge moderately long; extension of basal plate small and confined to apex of basal plate arm.

*FEMALE*: Unknown.

ETYMOLOGY: The species epithet combines *grandis*, meaning large with *oculus*, meaning eye, to indicate the prominently large sized compound eye.

DISTRIBUTION: Mexico.

***Zelus luridus* Stål, 1862** Figs 4.1, 4.9, 4.21.

LECTOTYPE: **USA: North Carolina:** Stål, 1;f (UCR\_ENT 00041007) (NHRS).

*Zelus luridus* Stål, 1862, p. 452, orig. descr.; Stål, 1872, p. 91, cat. (subgenus *Diplodus*)

Lethierry and Severin, 1896, p. 152, cat.; Champion, 1898, p. 259–260, syn. (= *Z. exsanguis*); Hart, 1986, p. 537, lectotype desig.

*Diplodus luridus*, Uhler, 1886, p. 24, checklist.

*Darbanus georgiae* Provancher, 1872, p. 106, orig. descr.; Uhler, 1886, p. 24, checklist;

Provancher, 1887, p. 181, note; Kelton, 1968, p. 1070, note; Hart, 1986, p. 53, syn (= *Z. luridus*).

*Zelus georgiae*, Lethierry and Severin, 1896, p. 152, cat.; Banks, 1910, p. 16, cat.; Van

Duzee, 1916, p. 30, syn. (= *Z. exsanguis*).

*Darbanus palliatus* Provancher, 1887, p. 182, orig. descr.; Kelton, 1968, 1070, note;

Hart, 1986, p. 53, syn (= *Z. luridus*).



*Zelus palliates* Lethierry and Severin, 1896, p. 153, cat.; Banks, 1910, p. 16, cat.; Van Duzee, 1916, p. 30, syn. (= *Z. exsanguis*).

*Reduvius* sp. Emmons, 1854, p. 168, P1. 7, fig. 3, note and fig.

Identifications not verified:

*Diplodus luridus*, Uhler, 1872a, p. 471, checklist; Uhler, 187213, p. 420, note; Walker, 1873, p. 124, cat.; Uhler, 1876, p. 61, note; Uhler, 1877, p. 429, note; Uhler, 1878, p. 427, note; Provancher, 1887, p. 181, note; Van Duzee, 1894, p. 183, list; Gillette and Baker, 1895, p. 60, list.

*Zelus luridus*, Uhler, 1904, p. 364, list; Wirtner, 1904, p. 206, list; Torre-Bueno and Brimley, 1907, p. 437, list; Torre-Bueno, 1910, p. 32, note; Torre-Bueno and Engelhardt, 1910, p. 150, note; Torre-Bueno, 1913, p. 60, note (subgenus *Diplodus*); Barger, 1914, p. 506, list; Van Duzee, 1916, p. 60, syn. (of *Z. exsanguis*).

*Diplocodus luridus*, Van Duzee, 1912, p. 324, note.

*Zelus exsanguis*, Wirtner, 1904, p. 206, list; Barber, 1906, p. 285, list; Snow, 1907, p. 159, list; Parshley, 1914, p. 144, list; Hussey, 1922, p. 24, list; Britton, 1923, p. 687, list; Blatchley, 1926, p. 570–571, descr. and note (*Diplodus*); Readio, 1926, 167, P1. X, fig. 5, 6 and 7, note and fig.; Readio, 1927, p. 169, 171–177, P1. XIII, descr., notes and fig. ; Leonard, 1928, p. 105, list; Brimley, 1938, p. 73, list; Harris, 1943, p. 151, list; Procter, 1946, p. 319, list; Elkins, 1951, p. 410, list; Sibley, 1951, p. 92, list; Hall, Downe, MacLellan and West, 1953, p. 199–204, note; Dome and West, 1954, p. 181–184, behavior; West and De Long, 1955, p. 97–101, biology; Davis, 1961, p. 351, note; Drew and Schaeffer, 1962, p. 106,

list; Whitcomb and Bell, 1964, p. 22, list; Kelton, 1968, p. 1070– 1071, note;

Yonke and Medler, 1970, p. 441–443, biology.

*Zelus acanthosonius* Say, Uhler, 1878, p. 427, manuscript name.

*Evagoras viridis* Uhler, 1878, p. 427, manuscript name.

**DIAGNOSIS:** The male can be recognized by the cylindrical paramere, the apex not greatly enlarged; and the medial process relatively broad.

**DESCRIPTION:** *MALE:* Medium-sized, total length 13.21–15.27 (mean 13.89, Table 4.2); slender. **COLORATION:** Dorsal surface dark brown; lateral surfaces, legs and abdomen yellowish brown, darker on apices of femora. In live specimens the coloration is more vibrant and somewhat greenish. **VESTITURE:** Moderately setose. Anteocular lobe with short, recumbent and erect setae; postocular lobe with mostly recumbent and some erect setae dorsally. Anterior pronotal lobe with short, erect and recumbent setae; posterior pronotal lobe with short, recumbent setae. Abdomen with short, erect and recumbent setae and some scattered, long setae. **STRUCTURE: Head:** Cylindrical, L/W = 2.44. Postocular lobe moderately long; in dorsal view anteriorly gradually narrowing, posterior portion constant, slightly narrower. Eye moderately sized; lateral margin only slightly wider, roughly on line with margin of postocular lobe; dorsal margin removed from postocular transverse groove, ventral margins attaining ventral surface of head in lateral view. *Labium:* I: II: III = 1: 1.8: 0.4. **Thorax:** Antero-lateral angle bearing small protuberance; medial longitudinal sulcus evident only on posterior 1/2, deepening anterior to transverse sulcus of pronotum. Posterior pronotal lobe with rugulose surface; disc slightly elevated above humeral angle; humeral angle armed, with dentate projection. Scutellum moderately long; apex angulate, slightly projected upward. *Legs:* Slender. *Hemelytron:* Surpassing apex of abdomen by about length of abdominal

segment 7; quadrate cell small, elongate; Cu and M of cubital cell converging towards R.

**GENITALIA:** *Pygophore:* Elongate ovoid; not expanded laterally in dorsal view. Medial process triangular; broad; moderately long; semi-erect; nearly straight; apex in posterior view blunt, without modification. *Paramere:* Cylindrical; moderately long, slightly exceeding medial process; nearly straight; apical part very slightly enlarged. *Phallus:* Dorsal phallosomal sclerite somewhat squarish; medially slightly constricted; apical portion of phallosomal sclerite not distinctly tapered, flat; apex truncate, medially emarginate; proximal edge broadly inversely V-shaped. Struts attached to dorsal phallosomal sclerite; apically separate, connected by bridge; basally separate. Basal plate arm slender; separate; subparallel; in lateral view nearly straight, very slightly curved; bridge moderately long; extension of basal plate small and confined to apex of basal plate arm.

*FEMALE:* Similar to male, except for the following. Larger than male, total length 13.26–18.48 (mean 15.48, Table 4.2). Coloration rather similar to that in male; lateral processes on humeral angles dark brown, apices of femora reddish. Lateral process on humeral angle spinous, long. Hemelytron slightly surpassing apex of abdomen.

DISTRIBUTION: North America.

***Zelus spatulosus* sp. nov.** Figs 4.1, 4.10.

HOLOTYPE: **Belize:** Rio Grande, 12 Jun 1931, J. J. White/J.C. Lutz Collection, 1961. 1;m (UCR\_ENT 00008002) (USNM).

DIAGNOSIS: This species has a rather distinctly enlarged apical part of the paramere. Also, the rather slender form of the medial process is distinctive among the *ambulans* group.

DESCRIPTION: *MALE*: Medium-sized, total length 13.17 (n=1); slender.

**COLORATION**: Entire surface of body dark brown, yellowish brown on ventral surface of head and lateral margins of posterior pronotal lobe; legs banded. **VESTITURE**:

Moderately setose. Antecular lobe with short, recumbent to erect setae; postocular lobe with short, recumbent setae, some long, erect setae on lateral and ventral surfaces.

Anterior pronotal lobe with moderately long, recumbent to semi-erect setae; posterior pronotal lobe with short, decumbent setae, long setae laterally. Abdomen with dense, short, recumbent and moderate to long erect setae. **STRUCTURE: Head**: Cylindrical,

L/W = 2.12. Postocular lobe moderately long; in dorsal view anteriorly gradually narrowing, posterior portion constant, slightly narrower. Eye moderately sized; lateral margin only slightly wider, roughly on line with margin of postocular lobe; dorsal margin attaining postocular transverse groove, ventral margin removed from ventral surface of head in lateral view. *Labium*: I: II: III = 1: 2.4 :0.7. **Thorax**: Antero-lateral angle bearing small protuberance; medial longitudinal sulcus evident only on posterior 1/2, deepening anterior to transverse sulcus of pronotum. Posterior pronotal lobe with finely rugulose surface; disc slightly elevated above humeral angle; humeral angle armed, with dentate projection. Scutellum moderately long; apex angulate, not projected. *Legs*: Slender.

*Hemelytron*: Surpassing apex of abdomen by about length of abdominal segment 7; quadrate cell small; Cu and M of cubital cell converging towards R. **GENITALIA**:

*Pygophore*: Elongate ovoid; not expanded laterally in dorsal view. Medial process triangular; slender; moderately long; semi-erect; nearly straight; apex in posterior view blunt, without modification. *Paramere*: Cylindrical; moderately long, slightly exceeding medial process; apical part enlarged. *Phallus*: Dorsal phallosclerite elongated; apical portion of phallosclerite not distinctly tapered, slightly convex; apex

truncate, medially emarginate; proximal edge inversely V-shaped. Struts missing. Basal plate arm moderately robust; basally fused; in lateral view nearly straight, very slightly curved; bridge short; extension of basal plate expanded onto arm.

*FEMALE*: Unknown.

ETYMOLOGY: The name is from *spatula*, referring to the rather broad apical part of the paramere.

DISTRIBUTION: Central America.

***Zelus inconstans* Champion, 1898** Figs 4.2, 4.10, 4.22.

LECTOTYPE: **PANAMA: Chiriqui**: Bugaba, No date provided, G.C. Champion, 1;f (UCR\_ENT 00048756) (BMNH) (**new designation**).

*Zelus inconstans* Champion, 1898, p. 254–255, Tab. XV., fig. 13, orig. descr. and fig.;

Wygodzinsky, 1947, p. 43, note; Wygodzinsky, 1949a, p. 49, checklist.

DIAGNOSIS: The male has the paramere apically greatly projected dorsad, nearly 90 degree; the apex of the medial process folded posteriorly. Very similar to *Z. mimus*, but the medial process much shorter and broader.

DESCRIPTION: *MALE*: Small, total length 10.05–12.70 (mean 11.42, Table 4.2); slender. **COLORATION**: Dorsum brown to dark brown. Pale yellow or light brown on head and lateral surface of posterior pronotal lobe. Legs with yellow and brown bands.

**VESTITURE**: Sparsely setose. Anteoconular lobe with short, recumbent setae. Anterior pronotal lobe with sparse, short, erect setae dorsally confined to setal tracts, more dense, recumbent and erect setae laterally; posterior pronotal lobe with short, erect and recumbent setae. Abdomen with short, recumbent to moderate, erect setae.

**STRUCTURE: Head**: Cylindrical, L/W = 2.04. Postocular lobe long; in dorsal view

distinctly narrowing through anterior 2/3, posterior 1/3 constant, tube-like. Eye moderately sized; lateral margin only slightly wider, roughly on line with margin of postocular lobe. *Labium*: I: II: III = 1: 1.9: 0.5. Basiflagellomere diameter larger than that of pedicel. **Thorax**: Antero-lateral angle bearing small projection; medial longitudinal sulcus shallow near collar, deepening posteriorly. Posterior pronotal lobe with rugulose surface; disc distinctly elevated above humeral angle; humeral angle armed, with dentate projection. Scutellum moderately long; apex angulate. *Legs*: Slender. *Hemelytron*: Slightly surpassing apex of abdomen, not more than length of abdominal segment 7; quadrate cell small; Cu and M of cubital cell subparallel. **GENITALIA**: *Pygophore*: Elongate ovoid. Medial process cylindrical; slender; long; erect; apex in posterior view modified, folded posteriad. *Paramere*: Cylindrical; moderately long, nearly reaching apex of medial process; directed posteriad, slightly curved towards medial process; strongly curved dorsad, nearly vertical; apical part not enlarged. *Phallus*: Dorsal phallothecal sclerite somewhat pundurate, fiddle-shaped, medially constricted; medially slightly constricted; apical portion of phallothecal sclerite gradually tapering, convex, laterally rounded, not forming angle; apex rounded, medially emarginate; proximal edge broadly concave. Struts attached to dorsal phallothecal sclerite; apically separate, connected by bridge; basally fused. Basal plate arm moderately robust; basally fused; in lateral view slightly curved; bridge extremely short; extension of basal plate small, marginally expanded onto arm.

*FEMALE*: Similar to male, except for the following. Larger than male, total length 11.26–11.64 (mean 11.49, Table 4.2). Posterior pronotal lobe orangish.

**DISTRIBUTION**: Southern Central America, South America.

***Zelus mimus* Stål 1862** Figs 4.2, 4.10, 4.22.

LECTOTYPE: **MEXICO**: Signoret, 1;f (UCR\_ENT 00075074) (NHMW) (**new designation**).

*Zelus mimus* Stål, 1862, p. 451, orig. descr. (subgenus *Diplodus*); Stål, 1872, p. 91, cat. (subgenus *Diplodus* ); Lethierry and Severin, 1896, p. 152, cat.; Champion, 1898, p. 257, 261, note, list and syn. (of *Z. umbratilis*); Fracker, 1913, p. 239, 240, list (subgenus *Diplodus*); Wygodzinsky, 1949a, p. 49, checklist.

*Diplodus mimus*, Uhler, 1886, p. 24, checklist.

*Zelus umbratilis* Stål, 1862, p. 451, orig. descr. (subgenus *Diplodus*); Stål, 1872, p. 91, cat. (subgenus *Diplodus*); Lethierry and Severin, 1896, p. 153, cat.; Champion, 1898, p. 261, syn. (= *Z. mimus*).

*Diplodus umbratilis*, Uhler, 1886, p. 24, checklist.

Identifications not verified:

*Zelus mimus*, Kuhlitz, 1902, p. 266, note; Williams, 1918, p. 163–173,

*Diplodus mimus*, Walker, 1873, p. 124, cat.

*Diplodus umbratilis*, Walker, 1873, p. 124, cat.

DIAGNOSIS: Recognized by the banded legs; the humeral angle with short dentate or subtuberculate process. The male has the paramere apically greatly projected dorsad, nearly 90 degree; the apex of the medial process folded posteriorly. Very similar to *Z. inconstans*, but the medial process much longer and more slender. In female the coloration of the posterior pronotal lobe brown to reddish-brown;.

DESCRIPTION: **MALE**: Small, total length 9.69–11.32 (mean 10.64, Table 4.2); slender. **COLORATION**: Dorsum brown to dark brown; posterior pronotal lobe sometimes slightly lighter. Pale yellow or light brown on ventral surface of head,

maxillary plate, lateral surface of posterior pronotal lobe, parts of pleura and medial surface of abdominal venter. Legs with yellow and brown bands. **VESTITURE:** Sparsely setose. Dorsum of head and anterior pronotal lobe with very sparse, short, erect or decumbent setae, nearly glabrous; ventral surface of head with sparse, long, erect and short, decumbent setae. Posterior pronotal lobe with short, erect or decumbent setae. Hemelytron primarily with short, decumbent setae. Pleura and abdominal venter with short, erect or decumbent setae, as well as wax-like setae. Very sparse, short setae on apical half of parameres. **STRUCTURE: Head:** Cylindrical, L/W = 2.17. Postocular lobe relatively short; in dorsal view distinctly narrowing through anterior 2/3, posterior 1/3 constant, tube-like. Eye prominent; lateral margin much wider than postocular lobe; dorsal margin attaining postocular transverse groove, ventral margin removed from ventral surface of head in lateral view. *Labium:* I: II: III = 1: 1.8: 0.4. Basiflagellomere diameter larger than that of pedicel. **Thorax:** Antero-lateral angle bearing small projection; medial longitudinal sulcus shallow near collar, deepening posteriorly. Posterior pronotal lobe with rugulose surface; disc distinctly elevated above humeral angle; humeral angle armed, with dentate projection. Scutellum long; apex angulate, slightly projected upward. *Legs:* Slender. *Hemelytron:* Surpassing apex of abdomen by about length of abdominal segment 7; quadrate cell small and slender; Cu and M of cubital cell subparallel. **GENITALIA: Pygophore:** Ovoid. Medial process cylindrical; slender; long; erect; apex in posterior view modified, folded posteriad. *Paramere:* Cylindrical; moderately long, achieving apex of medial process; directed posteriad; strongly curved dorsad, nearly vertical; apical part not enlarged. *Phallus:* Dorsal phallothecal sclerite shield-shaped; apical portion of phallothecal sclerite tapered, convex, laterally rounded, not forming angle; apex rounded; proximal edge broadly



concave. Struts attached to dorsal phallothecal sclerite; apically separate, connected by bridge; basally almost completely fused. Basal plate arm moderately robust; basally fused; in lateral view nearly straight, very slightly curved; bridge short; extension of basal plate expanded onto arm.

*FEMALE*: Similar to male, except for the following. Larger than male, total length 11.81–14.06 (mean 13.14, Table 4.2). Posterior pronotal lobe sometimes brownish orange or with orange longitudinal stripes; occasional specimens with entire pronotum reddish brown. Legs banded or unicolorous.

DISTRIBUTION: Central America.

**Zelus grassans Stål, 1862** Figs 4.2, 4.11, 4.23.

HOLOTYPE: **MEXICO**: Signoret, 1;f (UCR\_ENT 00075073) (NHMW).

*Zelus grassans* Stål, 1862, p. 450, orig. descr.; Stål, 1872, p. 91, cat.; Lethierry and Severin, 1896, p. 152, cat.; Champion, 1898, p. 256–257, Tab. XV, fig. 16, 17, note and fig.; Kuhlitz, 1902, p. 266, note; Fracker, 1913, p. 239, 240, key and list (subgenus *Diplodus*); Wygodzinsky, 1949a, p. 49, checklist.

*Diplodus grassans*, Uhler, 1886, p. 24, checklist.

Identifications not verified:

*Diplodus grassans*, Walker, 1872, p. 124, cat.

DIAGNOSIS: The male shows several highly unique characters of the genitalia. The paramere is greatly curved at middle and tapered apically; the medial process is curved and directed posteriad; and the dorsal phallothecal sclerite constricted and the apex truncate, without emargination.

DESCRIPTION: *MALE*: Medium-sized, total length 12.42–15.02 (mean 13.76, Table 4.2); slender. **COLORATION**: Orangish to reddish, with variable amount of black areas. Legs usually reddish, parts black. Black, red or whitish markings on abdomen.

**VESTITURE**: Sparsely setose. Head with short, spine-like setae dorsally, finer, short to long semi-erect and erect setae over entire surface. Anterior pronotal lobe with sparse, erect setae on entire surface; posterior pronotal lobe with short, heavy, erect setae on dorsal surface, longer laterally. Abdomen with short to moderately long erect setae on entire surface. **STRUCTURE: Head**: Cylindrical, L/W = 2.22. Postocular lobe relatively short; in dorsal view distinctly narrowing through anterior 1/2, posterior 1/2 constant, tube-like. Eye prominent; lateral margin much wider than postocular lobe; dorsal margin attaining postocular transverse groove, ventral margin removed from ventral surface of head in lateral view. *Labium*: I: II: III = 1: 1.5: 0.4. Basiflagellomere diameter larger than that of pedicel. **Thorax**: Antero-lateral angle bearing small protuberance; medial longitudinal sulcus evident throughout, deepening posteriorly. Posterior pronotal lobe with rugulose surface; disc distinctly elevated above humeral angle; humeral angle armed, with minute projection, absent in some specimens. Scutellum short; apex angulate. *Legs*: Slender. *Hemelytron*: Slightly surpassing apex of abdomen, not more than length of abdominal segment 7; quadrate cell small; Cu and M of cubital cell subparallel. **GENITALIA**: *Pygophore*: Ovoid; not expanded laterally in dorsal view. Medial process cylindrical; very slender; long, only slightly shorter than paramere; laterally somewhat compressed; posteriorly directed; curved at middle; apex in posterior view acute, without modification. *Paramere*: Somewhat sickle-shaped; long, nearly reaching apex of medial process; directed toward medial process; curved ventrad at mid-point, apex recurved; apical part not enlarged. *Phallus*: Dorsal phallosomal sclerite

somewhat pundurate, fiddle-shaped, medially constricted; apical portion of phallothecal sclerite gradually tapering, flat, laterally rounded, not forming angle; apex truncate, not emarginate; proximal edge nearly straight. Struts attached to dorsal phallothecal sclerite; apically separate, connected by bridge; basally separate. Basal plate arm moderately robust; basally fused; in lateral view very slightly curved; bridge extremely short; extension of basal plate expanded onto arm.

*FEMALE*: Similar to male, except for the following. Larger than male, total length 14.06–18.13 (mean 16.91, Table 4.2). Reduced amount of dark areas on body, dorsal surface usually yellowish.

DISTRIBUTION: Central America.

***Zelus illotus* Berg, 1879** Figs 4.2, 4.10, 4.23.

LECTOTYPE: **ARGENTINA**: Corrientes 1;m, (MLP).

*Zelus illotus* Berg, 1879, p. 153–154, orig. descr. (subgenus *Diplodus*); Lethierry and Severin, 1896, p. 152, cat.; Wygodzinsky, 1949a, p. 49, checklist; Wygodzinsky, 1949b, p. 336, note; Wygodzinsky, 1957, p. 264, 268, list and syn. (= *Z. obscuridorsis*); Hart, 1987, p. 297, lectotype desig.

*Zelus carvalhoi* Wygodzinsky, 1947, p. 428–431, orig. descr. and fig.; Zikan and Wygodzinsky, 1948, p. 17, list; Wygodzinsky, 1949a, p. 48, checklist; Wygodzinsky, 1949b, p. 336, note; wygodzinsky, 1957, p. 264, 268, list and syn. (= *Z. obscuridorsis*); Hart, 1987, p. 297, syn.

DIAGNOSIS: The combination of characters of the male genitalia can easily diagnose this species. The paramere is rather slender, curved in middle and recurved

apically and the medial process shows a strong curvature too. It is not necessary to examine the phallus.

DESCRIPTION: *MALE*: Small, total length 9.96–11.91 (mean 11.03, Table 4.2); slender. **COLORATION**: Dorsal surface nearly uniformly dark brown; lateral surfaces, legs and abdomen yellowish brown, apices of femora reddish, black ring. **VESTITURE**: Sparsely setose. Entire surface of head with short, recumbent setae, short to moderate semi-erect setae and erect setae on lateral and ventral surfaces. Anterior pronotal lobe with short, recumbent setae, some longer, erect setae laterally; posterior pronotal lobe with short, recumbent setae, some erect setae laterally. Abdomen with short, recumbent and scattered, erect setae. **STRUCTURE: Head**: Elongated, L/W = 2.79. Postocular lobe long; in dorsal view anteriorly gradually narrowing, posterior portion constant, slightly narrower. Eye smallish; lateral margin only slightly wider, roughly on line with margin of postocular lobe; margins removed from dorsal and ventral surfaces of head in lateral view. *Labium*: I: II: III = 1: 2.0: 0.4. Basiflagellomere diameter larger than that of pedicel. **Thorax**: Antero-lateral angle bearing small projection; medial longitudinal sulcus shallow near collar, deepening posteriorly. Posterior pronotal lobe with rugulose surface; disc distinctly elevated above humeral angle; humeral angle armed, with dentate projection. Scutellum short; apex angulate. *Legs*: Very slender. *Hemelytron*: Slightly surpassing apex of abdomen, not more than length of abdominal segment 7; quadrate cell small, elongate; Cu and M of cubital cell subparallel. **GENITALIA: Pygophore**: Ovoid; not expanded laterally in dorsal view. Medial process cylindrical; very slender; long, only slightly shorter than paramere; laterally somewhat compressed; semi-erect; apically recurved; apex in posterior view acute, without modification. *Paramere*: Cylindrical; long, achieving apex of medial process; directed posteriad, slightly curved

towards medial process; apically recurved; apical part not enlarged. *Phallus*: Dorsal phallothecal sclerite shield-shaped; small indentation of lateral margin at about midpoint; apical portion of phallothecal sclerite distinctly tapered, slightly convex, laterally rounded, not forming angle; proximal edge inversely V-shaped. Struts apical portion missing; basally separate. Basal plate arm moderately robust; basally fused; in lateral view very slightly curved; bridge extremely short; extension of basal plate small, marginally expanded onto arm.

*FEMALE*: Similar to male, except for the following. Larger than male, total length 12.35–14.28 (mean 13.68, Table 4.2). Coloration lighter than in male.

DISTRIBUTION: South America.

PARALECTOTYPES (**new designation**): **SURINAME: Commewijne**: Rust en Werk, 5.91667°N 55.08333°W, 11 Oct 1939, Reitsma, 1;f (UCR\_ENT 00013479) (RMNH). **Marowijne**: Galibi, 5.75°N 54°W, 29 Jul 1959, P.H. van Doesburg, Jr, 1;m (UCR\_ENT 00013468) (RMNH). **Unknown**: "Surinam", 1700, Unknown, 1;m (UCR\_ENT 00013477) (RMNH). Coronie Totness, 5.88333°N 56.31667°W, 09 Jun 1963, J. v. d. Vecht, 1;f (UCR\_ENT 00013480) (RMNH). Coronie Weg, 5.8°N 56.08333°W, 23 Dec 1948, Unknown, 1;m (UCR\_ENT 00013478) (RMNH). Marienburg, 5.86667°N 55.03333°W, 15 May 1963, P.H. van Doesburg, Jr, 1;f (UCR\_ENT 00013481) (RMNH).

***Zelus impar* Kuhlitz, 1902** Figs 4.2, 4.10, 4.23.

NEOTYPE: **COLOMBIA**: Santa Marta Mts., Mt. San Lorenzo, 1926 1;m (UCR\_ENT 00012153) (AMNH).

*Zelus impar* Kuhlitz, 1902, p. 264–266, Tab. IV, fig. 6, 6a, 6b, orig. descr. and fig.;

Wygodzinsky, 1949a, p. 49, checklist; Hart, 1987, p. 297, neotype desig.

DIAGNOSIS: The male is recognized by the slender, curved, laterally compressed, and apically tapered medial process. Most similar to *Z. illotus*, but the paramere is straight.

DESCRIPTION: *MALE*: Small, total length 9.47–12.05 (mean 11.23, Table 4.2); slender. **COLORATION**: Most surface of body dark brown; posterior pronotal lobe orangish; entire surface of body dark brown in some specimens; femora with two yellowish bands. **VESTITURE**: Sparsely setose. Head with short, recumbent and moderate to long erect setae, erect setae sparse dorsally. Anterior pronotal lobe with short, recumbent and moderately long, erect setae; posterior pronotal lobe with short, recumbent and moderately long, erect setae. Abdomen with short, recumbent and short to moderately long erect setae. **STRUCTURE: Head**: Cylindrical, L/W = 2.24. Postocular lobe long; in dorsal view anteriorly gradually narrowing, posterior portion constant, slightly narrower. Eye smallish; lateral margin only slightly wider, roughly on line with margin of postocular lobe; margins removed from dorsal and ventral surfaces of head in lateral view. *Labium*: I: II: III = 1: 1.8: 0.5. Basiflagellomere diameter larger than that of pedicel. **Thorax**: Antero-lateral angle bearing small protuberance; medial longitudinal sulcus evident only on posterior 1/2, deepening anterior to transverse sulcus of pronotum. Posterior pronotal lobe with rugulose surface; disc distinctly elevated above humeral angle; humeral angle armed, with dentate projection. Scutellum long; apex slightly pointed. *Legs*: Very slender. *Hemelytron*: Slightly surpassing apex of abdomen, not more than length of abdominal segment 7; quadrate cell small and slender; Cu and M of cubital cell subparallel. **GENITALIA: Pygophore**: Ovoid; not expanded laterally in dorsal view. Medial process cylindrical; very slender; long, only slightly shorter than paramere; laterally somewhat compressed; semi-erect; apically recurved; apex in

posterior view acute, without modification. *Paramere*: Cylindrical; long, achieving apex of medial process; directed posteriad, slightly curved towards medial process; nearly straight; apical part not enlarged. *Phallus*: Dorsal phallothecal sclerite shield-shaped; small indentation of lateral margin at about mid-point; apical portion of phallothecal sclerite distinctly tapered, slightly convex, laterally rounded, not forming angle; proximal edge inversely V-shaped. Struts attached to dorsal phallothecal sclerite; apically fused; basally fused. Basal plate arm moderately robust; basally fused; in lateral view very slightly curved; bridge extremely short; extension of basal plate small, marginally expanded onto arm.

*FEMALE*: Similar to male, except for the following. Larger than male, total length 10.38–14.18 (mean 12.24, Table 4.2).

DISTRIBUTION: Northern South America.

***Zelus nugax* Stål, 1862** Figs 4.2, 4.10, 4.24.

LECTOTYPE: **MEXICO**: salle, 1;f (UCR\_ENT 00041008) (NHRS).

*Zelus nugax* Stål, 1862, p. 450–451, orig. descr. (subgenus *Diplodus*); Stål, 1872, p. 91, cat. (subgenus *Diplodus*); Lethierry and Severin, 1896, p. 152, cat.; Fracker, 1913, p. 239, 240, key and list (subgenus *Diplodus*); Wygodzinsky, 1949a, p. 49, checklist.

*Diplodus nugax*, Uhler, 1886, p. 24, checklist; Hart, 1986, p. 540, lectotype desig.

*Zelus rufigeniculatus* Haviland, 1931, p. 137, 148, 153–154, list, fig. and orig. descr.

(subgenus *Diplodus*); Wygodzinsky, 1949a, p. 50, checklist; Hart, 1986, p. 540, syn.

Identifications not verified:

*Diplodus nugax*, Walker, 1873, p. 124, cat.

*Zelus nugax*, Champion, 1898, p. 257, 2, note and list; Kuhlitz, 1902, p. 266, note;

Fracker and Bruner, 1924, p. 171, list; Haviland, 1931, p. 137, 152, list and note;

Leonard and Mills, 1931, p. 309–323, note; Wygodzinsky, 1947, p. 431, note;

Guagliumi, 1953, p. 16, note; Wygodzinsky, 1957, p. 268, syn. (of *Zelus*

*obscuridorsis*); Sucre, et. al., 1966, p. 31, note.

**DIAGNOSIS:** The slender, cylindrical paramere and the laterally compressed medial process can separate the male of this species from most other species of the genus. Difficult to distinguish from *Z. pedestris*, but the paramere is more truncate and the dorsal phlotheal sclerite laterally without indentation.

**DESCRIPTION:** *MALE:* Small, total length 9.54–10.78 (mean 10.23, Table 4.2); slender. **COLORATION:** Dorsal surface brown, sometimes disc of posterior pronotal lobe and scutellum yellowish brown. **VESTITURE:** Sparsely setose. Head with moderate to long erect setae and recumbent setae. Anterior pronotal lobe with short, recumbent setae dorsally confined to setal tracts, laterally with longer, recumbent to erect setae; posterior pronotal lobe with recumbent setae. Abdomen with short, recumbent and short to moderately long, erect setae. **STRUCTURE: Head:** Elongated, L/W = 2.48. Postocular lobe long; in dorsal view anteriorly gradually narrowing, posterior portion constant, slightly narrower. Eye smallish; lateral margin only slightly wider, roughly on line with margin of postocular lobe; margins removed from dorsal and ventral surfaces of head in lateral view. *Labium:* I: II: III = 1: 2.0: 0.4. Basiflagellomere diameter larger than that of pedicel. **Thorax:** Antero-lateral angle with inconspicuous subtuberculate projection; medial longitudinal sulcus shallow near collar, deepening posteriorly. Posterior pronotal lobe with rugulose surface; disc distinctly elevated above humeral



angle; humeral angle armed, with dentate projection. Scutellum long; apex slightly pointed. *Legs*: Very slender. *Hemelytron*: Slightly surpassing apex of abdomen, not more than length of abdominal segment 7; quadrate cell small; Cu and M of cubital cell subparallel. **GENITALIA**: *Pygophore*: Ovoid; not expanded laterally in dorsal view. Medial process cylindrical; very slender; long, only slightly shorter than paramere; laterally somewhat compressed; semi-erect; nearly straight; apex in posterior view acute, without modification. *Paramere*: Cylindrical; moderately long, achieving apex of medial process; directed posteriad; nearly straight; apical part not enlarged. *Phallus*: Dorsal phallothecal sclerite shield-shaped; apical portion of phallothecal sclerite distinctly tapered, slightly convex, laterally rounded, not forming angle; proximal edge deeply concave. Struts attached to dorsal phallothecal sclerite; apically fused; basally fused. Basal plate arm moderately robust; separate; diverging; in lateral view very slightly curved; bridge short; extension of basal plate not distinctly visible.

*FEMALE*: Similar to male, except for the following. Larger than male, total length 12.25–14.14 (mean 12.99, Table 4.2).

*DISTRIBUTION*: Throughout the New World (except for the Caribbean).

***Zelus pedestris* Fabricius, 1803** Figs 4.2, 4.10, 4.24.

*LECTOTYPE*: Am. mer. Schmidt. 1;f (ZMUC). (**new designation**)

*Zelus pedestris* Fabricius, 1803, p. 288, orig. descr.; Stål, 1872, p. 91, cat. (subgenus

*Diplodus*); Lethierry and Severin, 1896, p. 151, cat.; Wygodzinsky, 1949a, p. 50, checklist.

*Diplodus pedestris*, Stål, 1868, p. 109, descr. and note.

*Zelus dispar* Fabricius, 1803, p. 291, orig. descr. (**syn. nov.**); Stål, 1872, p. 92, cat. (subgenus *Diplodus*); Lethierry and Severin, 1896, p. 151, cat.; Wygodzinsky, 1949a, p. 49, checklist.

*Diplodus dispar*, Stål, 1868, p. 109–110, descr. and note.

*Diplodus obscuridorsus* Stål, 1860, p. 75, orig. descr. (**syn. nov.**); Stål, 1868, p. 109, note.

*Zelus obscuridorsus*, Stål, 1872, p. 91, cat. and descr. (subgenus *Diplodus*); Thierry and Severin, 1896, p. 152, cat.; Wygodzinsky, 1949a, p. 50, checklist; Wygodzinsky, 1957, p. 26, note and syn. (of *Zelus nugax*, *Zelus illotus* and *Zelus carvalhoi*); Wygodzinsky, 1960, p. 307–308, list.

Identifications not verified:

*Diplodus pedestris*, Walker, 1873, p. 125, cat.

*Diplodus dispar*, Walker, 1873, p. 125, cat.

*Diplodus obscuridorsus*, Walker, 1873, p. 125, cat.

**DIAGNOSIS:** The slender, cylindrical paramere and the laterally compressed medial process can separate this species from most other species of the genus. Difficult to distinguish from *Z. nugax*, but the paramere is more rounded and the dorsal phllothecal sclerite laterally without indentation.

**DESCRIPTION:** *MALE:* Small, total length 9.63–11.26 (mean 10.60, Table 4.20); slender. **COLORATION:** Dorsal surface dark brown; lighter on posterior pronotal lobe; legs yellowish brown. **VESTITURE:** Sparsely setose. Entire surface of head with short, recumbent and erect setae, some scattered longer erect setae on postocular lobe, especially ventrally. Anterior pronotal lobe with short, recumbent to short, erect setae, confined to setal tracts dorsally, longer setae laterally; posterior pronotal lobe with short,

recumbent and moderat, erect setae. Abdomen with short, recumbent and erect and scattered, longer erect setae. **STRUCTURE: Head:** Cylindrical, L/W = 2.37. Postocular lobe long; in dorsal view anteriorly gradually narrowing, posterior portion constant, slightly narrower. Eye smallish; lateral margin only slightly wider, roughly on line with margin of postocular lobe; margins removed from dorsal and ventral surfaces of head in lateral view. *Labium:* I: II: III = 1: 2.1: 0.4. Basiflagellomere diameter larger than that of pedicel. **Thorax:** Antero-lateral angle bearing small projection; medial longitudinal sulcus shallow near collar, deepening posteriorly. Posterior pronotal lobe with rugulose surface; disc distinctly elevated above humeral angle; humeral angle armed, with dentate projection. Scutellum long; apex slightly pointed. *Legs:* Very slender. *Hemelytron:* Slightly surpassing apex of abdomen, not more than length of abdominal segment 7; quadrate cell small; Cu and M of cubital cell subparallel. **GENITALIA:** *Pygophore:* Ovoid; not expanded laterally in dorsal view. Medial process cylindrical; very slender; long, only slightly shorter than paramere; laterally somewhat compressed; semi-erect; nearly straight; apex in posterior view acute, without modification. *Paramere:* Cylindrical; moderately long, achieving apex of medial process; directed posteriad; nearly straight; apical part not enlarged. *Phallus:* Dorsal phallothecal sclerite shield-shaped; small indentation of lateral margin at about mid-point; apical portion of phallothecal sclerite distinctly tapered, slightly convex, laterally rounded, not forming angle; proximal edge deeply concave. Struts attached to dorsal phallothecal sclerite; apically fused; basally fused. Basal plate arm slender; basally fused; in lateral view very slightly curved; bridge extremely short; extension of basal plate small, marginally expanded onto arm.

*FEMALE*: Similar to male, except for the following. Larger than male, total length 12.15–13.36 (mean 13.09, Table 4.2). Coloration lighter than in male, apices of femora banded.

DISTRIBUTION: South America.

PARALECTOTYPES (**new designation**): **GUYANA: Demerara-Mahaica:**

Demerara, 6.8°N 58.1667°W, 22 Apr 1901, R. J. Crew, 1;f (UCR\_ENT 00019713) (CAS); 24 May 1901, R. J. Crew, 1;m (UCR\_ENT 00019712) (CAS). **PERU: Huanuco:** 67 mi E. of Tingo Maria, 9.29528°S 75.99754°W, 350 m, 11 Dec 1954, Unknown, 1;f (UCR\_ENT 00019717) (CAS). Monzon valley, Tingo Maria, 9.27816°S 76.05562°W, 23 Sep 1954, E. I. Schlinger & E. S. Ross, 1;f (UCR\_ENT 00019714) (CAS); 08 Oct 1954, E. I. Schlinger & E. S. Ross, 1;f (UCR\_ENT 00019716) (CAS); 10 Oct 1954, E. I. Schlinger & E. S. Ross, 1;m (UCR\_ENT 00019709), 2;f (UCR\_ENT 00019715, UCR\_ENT 00019719) (CAS); 26 Oct 1954, E. I. Schlinger & E. S. Ross, 1;f (UCR\_ENT 00019718) (CAS); 20 Nov 1954, E. I. Schlinger & E. S. Ross, 1;m (UCR\_ENT 00019711) (CAS); 29 Nov 1954, E. I. Schlinger & E. S. Ross, 1;m (UCR\_ENT 00019708) (CAS); 02 Dec 1954, E. I. Schlinger & E. S. Ross, 1;m (UCR\_ENT 00019710) (CAS).

***Zelus bruneri* De Zayas, 1960** Fig 4.2.

HOLOTYPE: **Cuba:** Piloto, Moa, Oriente, Jun 1954 (not examined).

*Zelus bruneri* De Zayas, 1960, p. 125–127, orig. descr. and fig; Alayo, 1967, p. 5, 36, 37, list, key and note.

DISCUSSION: Two male specimens are known from Cuba. The specimen was not physically examined, but the original description and illustration provided strong basis for

placing this species in the *puertoricensis* group. This is confirmed by the narrow, elongated body form; the flat and rectangular pronotum; the general genitalic shape indicated in the figure. The much smaller size and flat postocular lobe negates it being a male of *Z. subimpressus*. It is more likely to be the male of *Z. zayasi*.

DISTRIBUTION: The Caribbean, Cuba.

***Zelus puertoricensis* Hart, 1987** Figs 4.2, 4.11, 4.25.

HOLOTYPE: **PUERTO RICO**: Coamo Springs, 17 Jul 1914 – 19 Jul 1914, Unknown, 1;m (UCR\_ENT 00057799) (AMNH).

*Zelus puertoricensis* Hart, 1987, p. 294, origi. descr. and fig.

DIAGNOSIS: The rather slender body form is characteristic of the *puertoricensis* group (total length/width more than 8x). The male can be recognized by the robust, posteriorly directed medial process, apex bent and the short, cylindrical paramere. This is smaller in *Z. puertoricensis* than in *subimpressus*.

DESCRIPTION: **MALE**: Small, total length 10.22–11.74 (mean 11.20, Table 4.2); very slender. **COLORATION**: Dorsal surfaces brown; corium reddish. Lateral surfaces yellowish brown. **VESTITURE**: Anteocular lobe with recumbent and sparse, erect setae on entire surface; postocular lobe with recumbent setae, more dense dorsally, erect setae ventrally. Anterior pronotal lobe with recumbent setae, confined setal tracts dorsally, mixed with erect setae laterally; posterior pronotal lobe with short, inconspicuous, erect setae and recumbent setae. Abdomen with short to long, erect setae. **STRUCTURE: Head**: Cylindrical, L/W = 2.27. Postocular lobe moderately long; in dorsal view anteriorly gradually narrowing, posterior portion constant, slightly narrower. Eye smallish; lateral margin only slightly wider, roughly on line with margin of postocular

lobe; margins removed from dorsal and ventral surfaces of head in lateral view. *Labium*: I: II: III = 1: 1.9: 0.5. Basiflagellomere diameter larger than that of pedicel. **Thorax**: Antero-lateral angle with inconspicuous subtuberculate projection; medial longitudinal sulcus shallow near collar, deepening posteriorly. Posterior pronotal lobe with rugulose surface; disc distinctly elevated above humeral angle; humeral angle armed, with dentate projection. Scutellum long; apex angulate, not projected. *Legs*: Slender. *Hemelytron*: Slightly surpassing apex of abdomen, not more than length of abdominal segment 7; quadrate cell small, elongate; Cu and M of cubital cell subparallel. **GENITALIA**: *Pygophore*: Elongate; mid-lateral fold adjacent to paramere insertion; not expanded laterally in dorsal view. Medial process robust; short; posteriorly directed; nearly straight; apex in posterior view blunt, slightly folded posteriad. *Paramere*: Cylindrical; short, not reaching apex of medial process; directed posteriad; basally slightly constricted; not distinctly curved; apical part slightly enlarged. *Phallus*: Dorsal phallosomal sclerite elongated; apical portion of phallosomal sclerite gradually tapering, flat; apex rounded; proximal edge inversely V-shaped. Struts attached to dorsal phallosomal sclerite; apically separate, connected by bridge; basally mostly separate, moderately fused. Basal plate arm robust; separate; diverging; in lateral view nearly straight, very slightly curved; bridge long; extension of basal plate small and confined to apex of basal plate arm.

*FEMALE*: Similar to male, except for the following. Larger than male, total length 12.03–14.33 (13.20, Table 4.2). Hemelytron slightly surpassing apex of abdomen.

DISTRIBUTION: The Caribbean.

PARATYPES: **PUERTO RICO**: **Jayuya**: Jayuya, 18.2186°N 66.5916°W, Dec 1934, V. Biaggi, 1;m (UCR\_ENT 00016144) (AMNH). **San Juan**: San Juan, 18.46633°N

66.10573°W, 16 Sep 1942, Unknown, 1;m (UCR\_ENT 00030178), 1;f (UCR\_ENT 00030179) (USNM). Coamo Springs, 18.07996°N 66.35794°W, 126 m, 17 Jul 1914 – 19 Jul 1914, Unknown, 6;f (UCR\_ENT 00016146, UCR\_ENT 00016992-UCR\_ENT 00016996) (AMNH).

***Zelus subimpressus* Stål, 1872** Figs 4.3, 4.11, 4.25.

LECTOTYPE: **CUBA**, 1;f (NHRS).

*Zelus subimpressus* Stål, 1872, p. 91, orig. descr. (subgenus *Diplodus*); Lethierry and Severin, 1896, p. 153, cat.; Fracker, 1913, p. 239, 240, key and list (subgenus *Diplodus*); Wygodzinsky, 1949a, p. 50, checklist; Hart, 1987, p. 294, redescription, fig. and key

*Diplodus subimpressus*, Uhler, 1886, p. 24, checklist; Gundlach, 1894, p. 598, checklist.

Identifications not verified:

*Zelus subimpressus*, Fracker and Bmer, 1924, p. 170, note; Bruner 1926, p. 78, 79, key and note; Leonard, 1933, p. 319, note; Wolcott, 1950, p. 212, note; Alayo, 1967, p. 37, note.

DIAGNOSIS: The rather slender body form is characteristic of the *puertoricensis* group (total length/width more than 8x). The male can be recognized by the robust, posteriorly directed medial process, apex bent and the short, cylindrical paramere. This is larger in *Z. subimpressus* than in *puertoricensis*.

DESCRIPTION: **MALE**: Medium-sized, total length 11.59–12.40 (mean 12.13, Table 4.2); very slender. **COLORATION**: Dorsal surfaces brown; corium and apices of femora reddish. Lateral surfaces yellowish brown. **VESTITURE**: Moderately setose. Head with moderately long, recumbent and sparse, erect setae dorsally, less dense and with some

longer setae on ventral surface. Anterior pronotal lobe with with recumbent setae scattered over entire surface, mainly confined to setal tracts; posterior pronotal lobe with recumbent setae and some erect setae. Abdomen with sparse, erect and recumbent setae. **STRUCTURE: Head:** Elongated, L/W = 2.64. Postocular lobe moderately long; in dorsal view anteriorly gradually narrowing, posterior portion constant, slightly narrower. Eye smallish; lateral margin only slightly wider, roughly on line with margin of postocular lobe; margins removed from dorsal and ventral surfaces of head in lateral view. *Labium:* I: II: III = 1: 1.8: 0.5. Basiflagellomere diameter larger than that of pedicel. **Thorax:** Antero-lateral angle with inconspicuous subtuberculate projection; medial longitudinal sulcus shallow near collar, deepening posteriorly. Posterior pronotal lobe with rugulose surface; disc distinctly elevated above humeral angle; humeral angle armed, with dentate projection. Scutellum long; apex angulate, not projected. *Legs:* Slender. *Hemelytron:* Slightly surpassing apex of abdomen, not more than length of abdominal segment 7; quadrate cell small, elongate; Cu and M of cubital cell subparallel. **GENITALIA:** *Pygophore:* Elongate; mid-lateral fold adjacent to paramere insertion; not expanded laterally in dorsal view. Medial process robust; short; posteriorly directed; nearly straight; apex in posterior view blunt, slightly folded posteriad. *Paramere:* Cylindrical; short, not reaching apex of medial process; directed posteriad; basally slightly constricted; not distinctly curved; apical part slightly enlarged. *Phallus:* Dorsal phallothecal sclerite shield-shaped; apical portion of phallothecal sclerite not distinctly tapered, flat; apex truncate; proximal edge deeply concave. Struts attached to dorsal phallothecal sclerite; apically separate, connected by bridge; basally mostly separate, moderately fused. Basal plate arm robust; separate; diverging; in lateral view nearly



straight, very slightly curved; bridge long; extension of basal plate small and confined to apex of basal plate arm.

*FEMALE*: Similar to male, except for the following. Larger than male, total length 14.36–16.08 (mean 15.06, Table 4.2).

*DISTRIBUTION*: The Caribbean.

***Zelus zayasi* Bruner and Barber, 1937** Figs 4.25.

*HOLOTYPE*: **CUBA**: El Yunque, Baracoa, 20.35237°N 74.57356°W, 557 m, 10 Jul 1935, F. de Zayas, 1;f (UCR\_ENT 00007933) (USNM).

*Zelus zayasi* Bruner and Barber, 1937, p. 186–188, orig. descr. and fig. (subgenus

*Zelus*); Wygodzinsky, 1949a, p. 50, checklist; Zayas, 1960, p. 125, 126, note;

Alayo, 1967, p. 36, 37, key and list.

*DIAGNOSIS*: The extremely slender body form separates this species from most other species of *Zelus*. Can be distinguished from *Z. puertoricensis* by the lack of conspicuous lateral process on the humeral angle and from *Z. subimpressus* by the parallel dorsal and ventral surfaces on the anterior 2/3 of the postocular lobe. The dorsal surface in *Z. subimpressus* is sloping.

*DESCRIPTION*: *MALE*: unknown.

*FEMALE*: Medium-sized, total length 12.39 (n=1); very slender. **COLORATION**:

Dorsal surface brown, lighter on lateral surfaces and abdomen. **VESTITURE**:

Moderately setose. Head with erect setae. Anterior pronotal lobe with sparse, recumbent and erect setae; posterior pronotal lobe with scattered, short, erect and recumbent

setae. Abdomen with short, erect setae. **STRUCTURE**: **Head**: Cylindrical, L/W = 2.29.

Postocular lobe moderately long; in dorsal view anteriorly gradually narrowing, posterior

portion constant, slightly narrower. Eye smallish; lateral margin only slightly wider, roughly on line with margin of postocular lobe; margins removed from dorsal and ventral surfaces of head in lateral view. *Labium*: I: II: III = 1: 1.6: 0.3. **Thorax**: Antero-lateral angle bearing small projection; medial longitudinal sulcus evident only on posterior 1/2, deepening anterior to transverse sulcus of pronotum. Posterior pronotal lobe with rugulose surface; disc distinctly elevated above humeral angle; humeral angle rounded, without projection. Scutellum moderately long; apex angulate. *Legs*: Slender.

*Hemelytron*: Attaining apex of abdomen.

DISTRIBUTION: The Caribbean.

DISCUSSION: From the description and figure of *Z. bruneri*, it is possible that *Z. bruneri* is the male of *Z. zayasi*. Because the specimens of *Z. bruneri* were not physically examined, I restrain from making this association and a formal synonymy between these two species.

***Zelus cervicalis* Stål, 1872** Figs 4.3, 4.11, 4.26.

LECTOTYPE: **USA: North Carolina**, Belfrage, 1;f (NHRS)

*Zelus cervicalis* Stål, 1872, p. 90, orig. descr. (*Zelus*); Uhler, 1876, p. 61, list (reprint);

Uhler, 1886, p. 24, checklist; Lethierry and Severin, 1896, p. 151, cat.;

Champion, 1898, p. 255, cat.; Banks, 1910, p. 16, cat.; Torre-Bueno and

Engelhardt, 1910, p. 150, note; Van Duzee, 1912, p. 324, syn. (of *Z. marginata* (Provancher)); Fracker, 1913, p. 239, 240, key and list (subgenus *Zelus*); Torre-

Bueno, 1913, p. 60, list; Barber, 1914, p. 506, list; Van Duzee, 1916, p. 30,

checklist (subgenus *Zelus*); Van Duzee, 1917, p. 260, cat. (subgenus *Zelus*);

Dozier, 1920, p. 357, list; Blatchley, 1926, p. 569, key and note (subgenus

*Zelus*); Readio, 1927, p. 169, 170, key and descr.; Wygodzinsky, 1949a, p. 48, checklist; Elkins, 1951, p. 410, list; Sibley, 1951, p. 92, list; Kelton, 1968, p. 1071, note; Hart, 1986, p. 542, lectotype design.

*Evagoras marginata* Provancher, 1887, p. 182–183, orig. descr.; Van Duzee, 1912, p. 324, syn. (= *Z. cervicalis*); Kelton, 1968, p. 1071, note.

*Zelus marginatus*, Lethierry and Severin, 1896, p. 152, cat.; Banks, 1910, p. 16, cat.

*Zelus pictipes* Champion, 1898, p. 255, Tab. XV, fig. 14, orig. descr, and fig.; Fracker, 1913, p. 239, 240, key and list; Van Duzee, 1916, p. 30, checklist (subgenus *Zelus*); Van Duzee, 1917, p. 259, cat. (subgenus *Zelus*); Readio, 1927, p. 169, 170, key and descr.; Wygodzinsky, 1949a, p. 50, checklist; Hart, 1986, p. 542, syn., fig and key.

Identifications not verified:

*Zelus cervicalis*, Snow, 1906, p. 180, list; Van Duzee, 1909, p. 177, list; Osborne and Drake, 1915, p. 531, note; Brimley, 1938, p. 73, list; Elliott, 1938, p. 39, list; Tenhet and Howe, 1939, p. 24, note; Drew and Schaeffer, 1962, p. 106, list; Oliver, 1964, p. 316, note; Whitcomb and Bell, 1964, p. 22, List and note.

*Zelus pictipes*, Snow, 1906, p. 180, list; Elkins, 1951, p. 410, list; Sibley, 1951, p. 92, list; Drew and Schaeffer, 1962, p. 106, list.

DIAGNOSIS: The slender body form makes it easy to separate out from other species that occur the same geographical region. Male can be recognized by the paramere apically greatly enlarged; the medial process apically curved ventrad, somewhat hook-like; the lateral margin of the dorsal phallothecal sclerite recurved.

DESCRIPTION: *MALE*: Medium-sized, total length 9.81–13.08 (mean 11.78, Table 4.2); very slender. **COLORATION**: Yellowish brown to dark brown, some specimens

with dark spots or bands on legs. Anteocular lobe yellowish brown to reddish brown, dark brown between eye and antennal insertion, some specimens with dark brown variable mid-dorsal areas. Dorsum of postocular lobe dark brown, variably shaped medial longitudinal line and area between ocelli and eye yellowish brown, ventral surface yellowish brown. Labial segments I & II yellowish brown; segment III reddish to dark brown. Antennal segments brown, sometimes scapus darker on dorsal surface or pedicel darker apically. Anterior pronotal lobe yellowish-brown to brown, collar and setal tracts darker, some specimens with dark brown spot on pro-episternum. Posterior pronotal lobe yellowish-brown to brown. Pleura yellowish-brown. Sternites yellowish-brown; meso-sternum with dark brown area anterior to meso-coxa. Scutellum yellowish-brown to brown, apex lighter. Legs yellowish brown, many specimens with dark brown raised spots or bands on femora and tibiae (see Discussion below). Corium and clavus reddish brown, veins yellowish brown; membrane yellowish brown. Dorsum of abdomen yellowish, reddish, or dark brown; connexival margins and ventral surface yellowish brown. Pygophore yellowish-brown; some specimens with medial process apically reddish-brown or brown. **VESTITURE:** Moderately setose. Pubescence of short decumbent and short to long erect setae. Anteocular lobe with short decumbent and erect setae over entire surface, more dense dorsally; postocular lobe with short to moderate decumbent and moderate to long erect setae, erect setae more dense posteriorly. With short to moderate decumbent setae over entire surface, confined to setal tracts on dorsum of anterior pronotal lobe, longer erect setae on lateral surface; scutellum with short decumbent and short to moderate semi-erect and erect setae over surface. Legs with short to long semi-erect to erect setae. Corium and clavus with short, recumbent setae. Abdomen with short decumbent and some short to moderate erect

setae over ventral and lateral surfaces. Exposed surface of pygophore with short decumbent and short to long erect setae; short to moderate stiff erect setae on apical half of parameres. **STRUCTURE: Head:** Cylindrical, L/W = 2.83. Postocular lobe moderately long; in dorsal view anteriorly gradually narrowing, posterior portion constant, slightly narrower. Eye moderately sized; lateral margin only slightly wider, roughly on line with margin of postocular lobe; margins removed from dorsal and ventral surfaces of head in lateral view. *Labium:* I: II: III = 1: 2.0: 0.5. Basiflagellomere diameter larger than that of pedicel. **Thorax:** Antero-lateral angle bearing small projection; medial longitudinal sulcus evident only on posterior 1/2, deepening anterior to transverse sulcus of pronotum. Posterior pronotal lobe with finely rugulose surface; disc slightly elevated above humeral angle; humeral angle armed, with dentate projection. Scutellum long; apex angulate, not projected. *Legs:* Slender. *Hemelytron:* Slightly surpassing apex of abdomen, not more than length of abdominal segment 7; quadrate cell small, elongate; Cu and M of cubital cell subparallel. **GENITALIA: Pygophore:** Ovoid. Medial process cylindrical; slender; long; laterally somewhat compressed; erect; nearly straight; basally without protrusion; apex in posterior view modified, hook-like. *Paramere:* Cylindrical; moderately long, achieving apex of medial process; directed toward medial process; basally narrower; curved dorsad; apical part enlarged. *Phallus:* Dorsal phallothecal sclerite shield-shaped; lateral margin recurved dorsad; apical portion of phallothecal sclerite gradually tapering, flat, lateral margin recurved; apex rounded, medially emarginate; proximal edge broadly concave. Struts attached to dorsal phallothecal sclerite; apically missing. Basal plate arm moderately robust; basally fused; in lateral view basally strongly curved; bridge short; extension of basal plate small, marginally expanded onto arm.

*FEMALE*: Similar to male, except for the following. Larger than male, total length 12.89–15.26 (mean 14.25, Table 4.2). Basiflagellomere subequal in diameter to pedicel. Central 1/3 of mesofemur slightly swollen, pro- and meso-femoral diameters subequal, about 1.3–1.4x diameter of metafemur.

*DISTRIBUTION*: North America, Central America. South Atlantic and Gulf Coast states of the United States, southeastern Arizona, most of Mexico, Central America and Northern Colombia. The known northern limit of this species is 38.9° N.

*PARALECTOTYPES*: **MEXICO: Jalisco**: Guadalajara, 20.66667°N 103.33333°W, 01 Jan 1700, McConnell, 3;m (UCR\_ENT 00019720-UCR\_ENT 00019722) (CAS).

***Zelus renardii Kolenati, 1856*** Figs 4.11, 4.26.

*HOLOTYPE*: **USA: California**: unknown Co. 1;f (UCR\_ENT 00075077) (NHMW).  
*Zelus renardii* Kolenati, 1857, p. 460, Tab. III. fig. 2, orig. descr. and fig.; Stål, 1872, p. 91, cat.; Kirkaldy, 1908, p. 195, list and syn. (of *Z. laevicollis* Champion and *Z. perigrinus* Kirkaldy); Banks, 1910b, p. 16, cat.; Fracker, 1913, p. 239, 240, key and checklist; Van Duzee, 1914, p. 13, list; Van Duzee, 1916, p. 30, checklist (subgenus *Diplocodus*); Van Duzee, 1917, p. 261, cat. (subgenus *Diplocodus*); Muir, 1920, p. 285–286, note; Muir, 1921, p. 119, note; Horton, 1922, p. 385, note; Hawaiian Sugar Planter's Association, 1924, p. 29, note; Readio, 1927, p. 169, 178–179, key, descr. and note; Williams, 1931, p. 101, note; Haldaway and Look, 1942, p. 257–258, note; Ewing and Ivy, 1943, p. 604–606, note; Clancy, 1946, p. 326, note; Van Zwaluwenburg, 1946, p. 15, note; Zimmerman, 1948, p. 137–138, note and fig.; Wygodzinsky, 1949a, p. 50, checklist; Elkins, 1951, p. 410, list; Nishida, 1955, p. 172, note; Wygodzinsky, 1966, p. 66, note.

*Zelus laevicollis* Champion, 1898, p. 260–261, Tab. XV. fig. 24, orig. descr. and fig.;  
Banks, 1910, p. 16, cat.; Fracker, 1913, p. 239, 240, key and list; Osborne and  
Drake, 1915, p. 531, note; Van Duzee, 1916, p. 30, checklist (subgenus  
*Diplocodus*); Van Duzee, 1917, p. 261, cat. (subgenus *Diplocodus*); Readio,  
1927, p. 177–178, descr.; Wygodzinsky, 1949a, p. 49, checklist; Hart, 1986, p.  
540, syn.

*Zelus peregrinus* Kirkaldy, 1902, p. 149–150, orig. descr.; Swezey, 1905, p. 232–234,  
biology; Kirkaldy, 1907a, p. 247, note; Kirkaldy, 1907b, p. 156–518, biology;  
Kirkaldy, 1908, p. 195, syn. (of *Z. renardii*); Severin, et. al., 1914, p. 197, note;  
Fullaway, 1918, p. 12, note; Clausen, 1940, p. 589–590, note (sic. *Zellus*).

Identifications not verified:

*Diplodus renardii*, Uhler, 1894, list.

*Zelus renardii*, Sibley, 1951, p. 92, list; Atkins, et. al., 1957, p. 258, note; Nielsen and  
Henderson, 1959, p. 159, note; Wene and Sheets, 1962, p. 397, note; Butler,  
1966, p. 1306–1307, note; Lingren, Ridgway and Jones, 1968, p. 615, note;  
Parenica, 1968, p. 276, note; Nutting and Spangler, 1969, p. 765, note.

*Zelus laevicollis*, Elkins, 1951, p. 410, list; Sibley, 1951, p. 92, list; Young and Sifuentes,  
1960, p. 1109–1111, biology.

*Diplocodus exsanguis*, Van Duzee, 1914, p. 13, list (probable misidentification).

DIAGNOSIS: Can be recognized by the reddish corium; the remainder of the body  
surface greenish; the humeral angle with small subtuberculate projection. More robust  
than a very similar species, *Z. cervicalis*. Male can be recognized by the paramere  
apically greatly enlarged; the medial process apically curved ventrad, somewhat hook-

like, more strongly than in *Z. cervicalis*, the only species that may be confused with; the lateral margin of the dorsal phalloshecal sclerite recurved.

DESCRIPTION: *MALE*: Medium-sized, total length 10.57–12.98 (mean 12.01, Table 4.2); robust. **COLORATION**: Antecular lobe yellowish-brown, some specimens with darker areas on either side of mid-dorsal line. Postocular lobe yellowish-brown, usually with variable brownish-black areas dorsally but always with mid-dorsal area and area anterior to ocellus yellowish-brown. Labium yellowish-brown, some specimens with brown labrum. Antennae yellowish-brown to light reddish-brown. Anterior pronotal lobe uniformly yellowish-brown or yellowish-brown with reddish-brown to dark brown setal tracts. Posterior pronotal lobe yellowish-brown to dark brown, margins light yellowish-brown, lateral surfaces yellowish-brown. Scutellum yellowish-brown to brown, apex lighter in color. Legs yellowish-brown, some specimens with apices of tibiae reddish-brown. Hemelytron yellowish-brown to dark brown, veins of clavus and corium usually lighter in color than surrounding area. Dorsum of abdomen reddish-brown to brown, connexival margins yellowish-brown, lateral and ventral surfaces usually yellowish-brown, some specimens with reddish-brown areas laterally. Pygophore yellowish-brown. **VESTITURE**: Moderately setose. Short decumbent and variable erect setae over surface. Antecular lobe with short decumbent setae dorsally and laterally, short erect setae on tylus and ventral surface; postocular lobe with recumbent setae dorsally, longer erect setae on lateral surface and on dorsal and ventral surfaces of posterior half. Dorsal surface of anterior pronotal lobe with short decumbent setae confined to setal tracts, remainder of surface with longer decumbent and erect setae; posterior lobe with short decumbent and erect setae and some longer erect setae lateroventrally; scutellum with semi-erect setae over surface. Abdominal dorsal setae very short, erect, lateral and



ventral surfaces with short decumbent and some short to moderately long erect setae. Exposed surface of pygophore with short decumbent and some short to moderate erect setae; erect setae over apical 3/5 of parameres. **STRUCTURE: Head:** Cylindrical, L/W = 2.61. Postocular lobe moderately long; in dorsal view anteriorly gradually narrowing, posterior portion constant, slightly narrower. Eye smallish; lateral margin only slightly wider, roughly on line with margin of postocular lobe; margins removed from dorsal and ventral surfaces of head in lateral view. *Labium:* I: II: III = 1: 1.6: 0.4. Basiflagellomere diameter larger than that of pedicel. **Thorax:** Medial longitudinal sulcus shallow near collar, deepening posteriorly. Posterior pronotal lobe with rugulose surface; disc slightly elevated above humeral angle; humeral angle armed, with dentate projection. Scutellum long; apex angulate, not projected. *Legs:* Robust. *Hemelytron:* Attaining apex of abdomen; quadrate cell small; Cu and M of cubital cell subparallel. **GENITALIA:** *Pygophore:* Ovoid. Medial process cylindrical; slender; long; laterally somewhat compressed; erect; nearly straight; basally without protrusion; apex in posterior view modified, hook-like. *Paramere:* Cylindrical; moderately long, not reaching apex of medial process; directed toward medial process; basally narrower; curved dorsad; apical part enlarged. *Phallus:* Dorsal phallothecal sclerite shield-shaped; lateral margin recurved dorsad; apical portion of phallothecal sclerite gradually tapering, flat, lateral margin recurved; apex medially notched; proximal edge broadly concave. Struts not attached to base of dorsal phallothecal sclerite; apically missing. Basal plate arm robust; separate; converging; in lateral view basally strongly curved; bridge moderately long; extension of basal plate small, marginally expanded onto arm, lateral margins recurved.

*FEMALE*: Similar to male, except for the following. Larger than male, total length 12.14–14.25 (mean 13.29, Table 4.2). Hemelytron slightly surpassing apex of abdomen.

DISTRIBUTION: North America, North America.

***Zelus amblycephalus* sp. nov.** Figs 4.3, 4.12, 4.29.

HOLOTYPE: **COSTA RICA: Puntarenas:** Golfito, 13 Jul 1957, A. S. Menke, 1;m (UCR\_ENT 00022669) (LACM).

DIAGNOSIS: The coloration dull, somewhat greenish. The paramere long, somewhat recurved; the apex of the paramere bearing small projection.

DESCRIPTION: *MALE*: Large, total length 14.97–17.49 (mean 15.70, Table 4.2); robust. **COLORATION**: Yellowish or greenish brown. Head yellowish brown to brown. Antennae and femoral apices reddish. Anterior pronotal lobe uniformly yellowish-brown or brown. Posterior pronotal lobe yellowish brown or brown with lateral processes and surrounding area darker, brown to dark brown. Clavus and corium brown to dark brown, veins yellowish-brown, membrane brown. Pygophore yellowish-brown. **VESTITURE**: Sparsely setose. Sparse, short, erect setae over most of integument. Abdominal venter with moderately long, erect setae. Sparse, moderately long setae on apical 1/2 of paramere. Head with short spinelike setae on dorsal surface with some short decumbent setae dorsally on posterior lobe, sparse short decumbent and erect setae on lateral and ventral surfaces. Anterior pronotal lobe with short spinelike setae dorsally and short erect and decumbent setae laterally; posterior lobe with short decumbent and erect setae on entire lobe; scutellum short erect and decumbent setae. Corium and clavus with short, recumbent setae. Abdominal venter with erect setae over entire surface, interspersed with long setae. Parameres with long silky setae on distal 1/2.

**STRUCTURE: Head:** Cylindrical, L/W = 2.21. Postocular lobe very long; in dorsal view anteriorly gradually narrowing, posterior portion constant, slightly narrower. Eye prominent; lateral margin only slightly wider, roughly on line with margin of postocular lobe; margins removed from dorsal and ventral surfaces of head in lateral view. *Labium:* I: II: III = 1: 1.4: 0.3. Basiflagellomere diameter larger than that of pedicel. **Thorax:** Antero-lateral angle rounded, without projection; medial longitudinal sulcus evident throughout, deepening posteriorly. Posterior pronotal lobe with smooth surface; disc distinctly elevated above humeral angle; humeral angle armed, with spinous processes. Scutellum long; apex angulate, not projected. *Legs:* Moderately robust. *Hemelytron:* Surpassing apex of abdomen by about length of abdominal segment 7; quadrate cell small and slender; Cu and M of cubital cell subparallel. **GENITALIA:** *Pygophore:* Ovoid. Medial process cylindrical; slender; long; posteriorly directed, in less than 45-degree with body axis; nearly straight; apex in posterior view rounded. *Paramere:* Cylindrical; long, surpassing medial process; directed posteriad; not distinctly curved; apical part very slightly enlarged. *Phallus:* Dorsal phallothecal sclerite somewhat ovoid; flat, laterally indistinctly angulate; apex truncate; proximal edge broadly concave. Struts attached to dorsal phallothecal sclerite; basally separate. Basal plate arm robust; separate; converging; in lateral view nearly straight, very slightly curved; bridge moderately long; extension of basal plate expanded onto arm.

*FEMALE:* Similar to male, except for the following. Larger than male, total length 15.21–18.67 (mean 16.69, Table 4.2). Pleura and abdominal segments with patch of whitish hairs. Basiflagellomere diameter smaller or subequal to that of pedicel. Small, slightly raised, less than in male. Hemelytron slightly surpassing apex of abdomen.

ETYMOLOGY: The species epithet refers to the generally dull coloration of this species.

DISTRIBUTION: Central America, South America.

PARATYPES: **BRAZIL: Amazonas:** Rio Janauaca, 40 km SW Manaus, 3.33333°S 60.28333°W, 10 Mar 1979, Unknown, 1;m (UCR\_ENT 00009315) (USNM). Teffe, 3.3667°S 64.7°W, 06 Dec 1918, Unknown, 1;m (UCR\_ENT 00009316) (USNM). **Rondonia:** 62 km SW of Ariquemes, near Fzda. Rancho Grande, 10.32921°S 63.46881°W, 03 Dec 1996 – 15 Dec 1996, J. E. Eger, 1;m (UCR\_ENT 00029368) (USNM). **COLOMBIA: Cundinamarca:** Villeta, 5.01444°N 74.47305°W, 799 m, 10 May 2003, C. Ardila, A. Montano, A. Pachon, 1;m (UCR\_ENT 00025328) (UNAB). **ECUADOR: Orellana:** Reserva Etnica Waorani, 1 km S. Onkone Gare Camp, Transect Ent., 0.65713°S 76.453°W, 216 m, 09 Oct 1994, T. L. Erwin et al., 1;m (UCR\_ENT 00009473) (USNM). **MEXICO: Chiapas:** 10 m N of Mexico 190 Tuztla Gutierrez, 16.90574°N 93.16486°W, 24 Aug 1956 – 28 Aug 1956, A. Lewis, 1;m (UCR\_ENT 00010840) (LACM). **Oaxaca:** Temascal, 18.23882°N 96.40034°W, 31 Oct 1963, D.H. Jansen, 5;m (UCR\_ENT 00009493-UCR\_ENT 00009497) (USNM). **PANAMA: Canal Zone:** Barro Colodrado, 9.16666°N 79.83333°W, 01 Apr 1941, J. Zetek, 1;m (UCR\_ENT 00009270) (USNM). **SURINAME: Unknown:** unknown, 12 Dec 1965, Geyskes, 1;u (UCR\_ENT 00023698) (RMNH).

***Zelus annulosus* (Stål, 1866)** Figs 4.3, 4.12, 4.28.

HOLOTYPE: **Country unknown.** Amazon, No date provided, Stevens, 1;f (UCR\_ENT 00040999) (NHRS).

*Diplodus annulosus* Stål, 1866, p. 299, orig. descr.

*Zelus annulosus*, Stål, 1872, p. 92, cat. (subgenus *Diplodus*); Lethierry and Severin, 1896, p. 151, cat.; Fracker and Bruner, 1924, p. 170, note; Wygodzinsky, 1949a, p. 48, checklist.

Identifications not verified:

*Diplodus annulosus*, Walker, 1873, p. 126, cat.

**DIAGNOSIS:** The posterior pronotal and corium dark green; the legs with 4–5 alternative yellow and black bands; the head, pronotum, scutellum and corium with moderately dense, black, erect, spine-like setae; the rather long and slender legs, the profemoral length 1/2 the body length; the rather long postocular lobe, enlarged at posterior 3/4; the quadrate cell on corium rather slender, length more than 2x width. The long paramere, reaching apex of medial process, the apex of paramere recurved; the medial process apically with two lateral sharp projections; the membranous sclerite between paramere and medial process, not distinctly protruding posteriorly; the dorsal phallothecal sclerite with lateral expansion close to basal arm, sharp, dorsad.

**DESCRIPTION:** *MALE:* Large, total length 14.57 (n=1); very slender.

**COLORATION:** Yellowish with dark brown patches; green on posterior pronotal lobe and corium. Most surface of head yellowish, dark stripe between eye and antennal insertion, on postocular lobe behind ocellus, and on lateral surface. Scape dark brown with three yellowish bands. Labium yellowish, dark band on first and second segments. Anterior pronotal lobe yellowish, anterior medial brown patch, antero-lateral angle dark brown, connected to dark brown patch on lateral surface. Posterior pronotal lobe, anterior part of corium green; rest of hemelytron brown to dark brown. Pleura yellowish with dark brown patch. Femora and tibiae with alternating yellow and dark brown bands, six of each on femora, four of each on tibiae, yellow band smaller, more so on

tibiae. **VESTITURE:** Moderately setose. Entire dorsal surface, including corium and clavus, with dark, dense, short to moderately long, erect, spine-like setae. Ventral surface of head, pleura with short, semi-erect to recumbent setae. Abdomen with moderately dense, short, semi-erect to recumbent setae, intermixed with long, erect setae. Sundew setae on profemur sparse. **STRUCTURE: Head:** Elongated, L/W = 2.13. Postocular lobe very long; in dorsal view distinctly narrowing through anterior 1/2, posterior 1/2 constant, tube-like. Eye prominent; lateral margin much wider than postocular lobe; dorsal margin attaining postocular transverse groove, ventral margin removed from ventral surface of head in lateral view. *Labium:* I: II: III = 1: 1.5: 0.4. Basiflagellomere diameter subequal to that of pedicel. **Thorax:** Antero-lateral angle bearing small protuberance; medial longitudinal sulcus shallow near collar, deepening posteriorly. Posterior pronotal lobe with finely rugulose surface; disc distinctly elevated above humeral angle; humeral angle armed, with short tuberculate processes. Scutellum moderately long; apex angulate. *Legs:* Slender. *Hemelytron:* Slightly surpassing apex of abdomen, not more than length of abdominal segment 7; quadrate cell small and slender; Cu and M of cubital cell subparallel. **GENITALIA: Pygophore:** Ovoid; not expanded laterally in dorsal view; broad lightly sclerotized expansion between paramere and medial process. Medial process expanded laterally; short; semi-erect; basally slightly protruding; apex in posterior view truncate, with small sharp lateral projections. *Paramere:* Cylindrical; long, nearly reaching apex of medial process; directed toward medial process; apically recurved. *Phallus:* Dorsal phallothecal sclerite shield-shaped; sharp, dorsal projection arising close to base; apical portion of phallothecal sclerite not distinctly tapered, flat, laterally distinctly angulate, ridge-like; apex truncate, not emarginate; proximal edge broadly inversely V-shaped. Struts attached to dorsal

phallothecal sclerite; apically separate, not connected by bridge; basally fused. Basal plate arm moderately robust; separate; converging; in lateral view slightly curved; bridge moderately long; extension of basal plate expanded onto arm.

*FEMALE*: Similar to male, except for the following. Larger than male, total length 21.19–22.72 (mean 21.91, Table 4.2). Some dry-preserved specimens have posterior pronotal lobe and corium not green but brown, probably a result of preservation artifact.

*DISTRIBUTION*: South America. The Colombian and Brazilian Amazonia and French Guiana.

*PARALECTOTYPES*: The female lectotype (**new designation**) of *conjungens* is deposited in the NHRS, and bears the following labels: Rio Jan / Stål. A female paralectotype (**new designation**) with the same labels is also deposited in the same museum. The female holotype of *atripes* is deposited in the BMNH, and bears the following labels: Type / Panama (Boucard) / *Zelus atripes* Ch. / B.C.A. Sp. figured.

*DISCUSSION*: This is one of the most distinct species in the genus. The large body size and rather slender and long habitus can separate both sexes of this species from most other congeners. Current specimens records are from the Colombian, Brazilian and Guyanian Amazon, suggesting that its distribution is probably across the Amazonia. Revel et al. (2010) reported an association between *Z. annulosus* with *Hirtella physophora* (Chrysobalanaceae), a myrmecophyte that houses colonies of *Allomerus decemarticulatus* (Myrmicinae). They observed that nymphs walk on the trichomes on the leaves of *H. physophora* and in doing so avoid contact with the ant. They suggested the bug-plant association is mutualistic as the plant also gain protection from the bug by its feeding on defoliators. They further claimed that the bugs gain protection against army ants from their ant co-inhabitant, *A. decemarticulatus*. Furthermore, their

observation did not reveal feeding of the bug on the extral-floral bodies of the plant. Instead, the bugs were seen feeding on over 40 prey.

***Zelus armillatus* (Lepelletier & Serville, 1825)** Figs 4.3, 4.12, 4.30.

NEOTYPE: **Brzil**: Nova Teutonia, Sta. Catarina, Brazil, 111–21, 1951, F.

Plaumann / J. C. Lutz Collection / USNM, UCR\_ENT 00003513 (**new designation**).

*Reduvius armillatus* Le Peletier and Serville, 1825, p. 278, orig. descr.

*Diplodus armillatus*, Amyot and Serville, 1843, p. 370, descr.

*Euagoras armillatus*, Herrich-Schaeffer, 1853, p. 91, list.

*Zelus armillatus*, Stål, 1872, p. 90, cat. (sag. *Diplodus*); Lethierry and Severin, 1896, p. 151, cat.; Wygodzinsky, 1949a, p. 49, checklist.

*Reduvius brasiliensis* Le Peletier and Serville, 1825, p. 278, orig. descr.

*Diplodus brasiliensis*, Amyot and Serville, 1843, p. 370, descr.

*Euagoras brasiliensis*, Herrich-Schaeffer, 1853, p. 91, list.

*Zelus brasiliensis*, Stål, 1872, p. 90, cat. (subgenus *Diplodus*); Lethierry and Severin, 1896, p. 151, syn. (=Z. *armillatus*).

*Arilus aurantiacus* Herrich-Schaeffer, 1848, p. 35-36 Tab. CCLXI. fig. 809, orig. descr. and fig.; Stål, 1872, p. 90, syn. (=Z. *armillatus*).

*Euagoras aurantiacus*, Herrich-Schaeffer, 1853, p. 91, list (*aurantius* (sic)).

*Ploeogaster aurantiacus*, Herrich-Schaeffer, 1853, p. 168, list.

*Arilus guttifer* Herrich-Schaeffer, 1848, p. 36, Tab. CCLXI, fig. 810, orig. descr. and fig.; Stål, 1872, p. 90, syn. (=Z. *brasiliensis*).

*Euagoras guttifer*, Herrich-Schaeffer, 1853, p. 92, list.

*Ploeogaster guttifer*, Herrich-Schaeffer, 1853, p. 168, list.



Identifications not verified:

*Diplodus armillatus*, Stål, 1860, p. 75, list; Walker, 1873, p. 123, cat.

*Zelus armillatus*, Mayr, 1866, p. 138-139, syn. (of *Z. brasiliensis*, *aurantiacus*, *guttifer* and *conjungens*); Berg, 1879, p. 151-152, list and nymphs (subgenus *Diplodus*); Costa Lima, 1940, 218, list (subgenus *Diplocodus*); Wygodzinsky, 1957, p. 268, note; Wygodzinsky, 1960; p. 307, list.

*Diplodus brasiliensis*, Stål, 1860, p. 75, note; Mayr, 1866, p. 138- 139, syn. (= *Z. armillatus*); Walker, 1873, p. 123, cat.

*Arilus aurantiacus*, Mayr, 1866, p. 138-139, syn. (= *Z. armillatus*).

*Arilus guttifer*, Mayr, 1866, p. 138-139, syn. (= *Z. armillatus*).

*Diplodus guttifer*, Stål, 1860, p. 74, descr.; Walker, 1873, p. 126, cat.

*Zelus guttifer*, Stål 1862, p. 453, note.

**DIAGNOSIS:** The large and robust body; the dorsal coloration usually bright, orangish or reddish with black. The medial process short, relatively slender.

**DESCRIPTION:** *MALE:* Large, total length 17.15–19.02 (mean 17.87, Table 4.2); robust. **COLORATION:** Highly variable, with varying combinations and amounts of yellow, yellowish-brown and brownish-black; margins of posterior pronotal lobe and corium yellowish, rest brownish-black as most common pattern, amount of black varies, sometimes almost entirely black; legs uniformly black or apically reddish, sometimes yellow-black banded. Abdominal dorsal surface dark brown, segments with yellowish-brown posterior and lateral margins; lateral and ventral surfaces dark brown to brownish-black with lighter mid-ventral line or yellowish-brown with variable darker areas. Pygophore yellowish-brown to brownish-black, pattern variable. **VESTITURE:** Densely setose. Head with dense, moderately long, adpressed setae, intermixed with dense,

long, erect setae, long setae more than half diameter of labial segment II. Pronotum with dense, short or long, erect setae and sparse, short, decumbent setae. Hemelytron with dense, short, decumbent setae. Abdominal venter primarily with dense, short, adpressed setae, sparsely intermixed with long, erect setae. Parameres apically with short, erect setae. Bulbous sclerite flanking medial process with dense, short to long, erect setae. Short decumbent and short to long erect setae over entire surface of head. Anterior pronotal lobe with short decumbent and short to long erect setae on lateral surface, short to long erect setae confined to tracts dorsally; posterior lobe with decumbent to erect setae on lateral surface, erect setae on dorsal surface; scutellum with dense moderate to long semi-erect to erect setae, denser on apex. Corium and clavus with short, recumbent or erect setae. Scattered short erect setae on abdominal dorsum, lateral and ventral surfaces with short decumbent setae interspersed with erect setae of varying lengths. Decumbent and erect setae on exposed surface of pygophore; apical 1/3 of parameres with erect setae on dorsal surface. **STRUCTURE: Head:** Cylindrical, L/W = 2.40. Postocular lobe relatively short; in dorsal view anteriorly gradually narrowing, posterior portion constant, slightly narrower. Eye moderately sized; margins removed from dorsal and ventral surfaces of head in lateral view. *Labium:* I: II: III = 1: 1.5: 0.4. Basiflagellomere diameter subequal to that of pedicel. **Thorax:** Antero-lateral angle rounded, without projection; medial longitudinal sulcus evident throughout, deepening posteriorly. Posterior pronotal lobe with finely rugulose surface; disc slightly elevated above humeral angle; humeral angle armed, with spinous processes. Scutellum short; apex rounded, not projected. *Legs:* Robust. *Hemelytron:* Surpassing apex of abdomen by about length of abdominal segment 7; quadrate cell large and broad; Cu and M of cubital cell converging towards R. **GENITALIA:** *Pygophore:* Ovoid; posteriorly expanded

sac-like sclerite between parameres and medial process. Medial process cylindrical; slender; moderately long, almost as long as exposed part of parameres; posteriorly directed, in less than 45-degree with body axis; nearly straight; basally without protrusion; apex in posterior view rounded, with minute projection. *Paramere*: Cylindrical; long, not reaching apex of medial process; directed posteriad; not distinctly curved; apical part not enlarged to very slightly enlarged. *Phallus*: Sharp laterally oriented process close to proximal edge and basal arms; apical portion of phallothecal sclerite not distinctly tapered, flat, laterally angulate; apex truncate; proximal edge broadly concave. Struts attached to dorsal phallothecal sclerite; apically separate, not connected by bridge; basally mostly separate, moderately fused. Basal plate arm robust; separate; converging; in lateral view nearly straight, very slightly curved; bridge short; extension of basal plate expanded onto arm.

*FEMALE*: Similar to male, except for the following. Larger than male, total length 19.0–24.7 (mean 21.94, Table 4.2). Coloration variation more extensive than in male.

DISTRIBUTION: South America.

***Zelus conjungens* (Stål, 1860)** Figs 4.3, 4.12, 4.28.

LECTOTYPE: **BRAZIL: Rio de Janeiro**, Stål, 1;f (UCR\_ENT 00041000) (NHRS) (**new designation**).

*Diplodus conjungens* Stål, 1860, p. 75, orig. descr.

*Zelus conjungens*, Stål, 1872, p. 90, cat. (subgenus *Diplodus*); Lethierry and Severin, 1896, p. 151, syn. (of *Z. armillatus*); Wygodzinsky, 1949a, p. 49, checklist.

*Zelus atripes* Champion, 1898, p. 259, Tab. XV. fig. 22, orig. descr. and fig. (**syn. nov.**); Wygodzinsky, 1949a, p. 48, checklist.

Identifications not verified:

*Diplodus conjungens*, Mayr, 1866, p. 138–139, syn. (of *Z. armillatus*); Walker, 1873, p. 125, cat.

**DIAGNOSIS:** Among species of the *armillatus* group, the medial process in *Z. conjungens* is the broadest, being more than 2x the diameter of paramere and more than 1.5x the diameter of ocellus. Other characters helpful for identification may include the lateral processes on apex of medial process minute, inconspicuous. Most similar to *Z. armillatus*, but can be separated by characters aforementioned, and also the lateral expansion on dorsal phallosomal sclerite close to basal arm not as sharp process. In female the mesofemur swollen nearly throughout, much thicker than profemur.

**DESCRIPTION:** *MALE:* Large, total length 16.64–19.80 (mean=18.34, Table 4.2); robust. **COLORATION:** Variably yellowish brown to brownish black. Dorsal surface of head brown, mixed brownish black; ventral surface brown. Anterior pronotal lobe variably brown to brownish black, nearly entirely brownish black in some specimens, never entirely yellowish brown, with at least brownish black spots. Posterior pronotal lobe usually brownish black in center, margins yellowish brown, entirely yellowish brown in occasional specimens. Corium and clavus with proximal portion brownish black, distal portion yellowish brown, entire surface yellowish brown in some specimens. Legs with or without bands. Lateral and ventral surface varying from most yellowish brown with brownish black spots to nearly entirely brownish black. **VESTITURE:** Sparsely setose. Very similar to that in *Z. armillatus*; adpressed setae more sparse. **STRUCTURE: Head:** Cylindrical, L/W = 2.29. Postocular lobe long; in dorsal view anteriorly gradually narrowing, posterior portion constant, slightly narrower. Eye smallish; lateral margin only slightly wider, roughly on line with margin of postocular lobe; margins removed from

dorsal and ventral surfaces of head in lateral view. *Labium*: I: II: III = 1: 1.4: 0.4. Basiflagellomere diameter smaller than that of pedicel. **Thorax**: Antero-lateral angle bearing small projection; medial longitudinal sulcus shallow near collar, deepening posteriorly. Posterior pronotal lobe with finely rugulose surface; disc slightly elevated above humeral angle; humeral angle armed, with short tuberculate processes. Scutellum moderately long; apex blunt, very slightly projected upward. *Legs*: Robust. *Hemelytron*: Slightly surpassing apex of abdomen, not more than length of abdominal segment 7; quadrate cell large and broad; Cu and M of cubital cell converging towards R.

**GENITALIA**: *Pygophore*: Ovoid; slightly expanded laterally near base of paramere in dorsal view; posteriorly expanded sac-like sclerite between parameres and medial process. Medial process robust; broad; short; posteriorly directed; basally slightly protruding; apex in posterior view truncate, with very inconspicuous lateral prongs. *Paramere*: Cylindrical; moderately long, not reaching apex of medial process; directed posteriad; slightly curved dorsad; apical part not enlarged. *Phallus*: Dorsal phallothecal sclerite shield-shaped; lateral expansion arising close to base; apical portion of phallothecal sclerite not distinctly tapered, flat, laterally angulate; apex rounded; proximal edge broadly concave. Struts attached to dorsal phallothecal sclerite; apically separate, connected by bridge; basally separate. Basal plate arm moderately robust; separate; converging; in lateral view slightly curved; bridge moderately long; extension of basal plate expanded onto arm.

*FEMALE*: Similar to male, except for the following. Larger than male, total length 20.74–22.64 (mean 21.68, Table 4.2). Similar to male.

**DISTRIBUTION**: Southern Central America, South America. Costa Rica, Panama, Colombia, Venezuela, Ecuador, southern states of Brazil.

DISCUSSION: *Zelus conjungens* is a very widespread species, however, as indicated by the relative scarcity of specimens, is apparently not often encountered. The males of *conjungens* may be easily distinguished by the wide medial process, the diameter of which near the middle is at least 1.5x the ocellar diameter, all other species of this group being less than 1.5x this distance. The females have a rather swollen mesofemora, being spindle-shaped and ~1.10x the diameter of the profemora. Other species of *Zelus* have only about the central 1/4 to 1/3 swollen and the diameter is less than 1.10x that of the profemora. There seems to be a general trend toward the lighter colorations in Colombia, Costa Rica and Panama. Males from these areas show a narrower apical part of the medial process.

***Zelus janus* Stål, 1862** Figs 4.3, 4.12, 4.27.

LECTOTYPE: **MEXICO:** salle, 1;m (UCR\_ENT 00041005) (NHRS) (**new designation**).

*Zelus janus* Stål, 1862, p. 452, orig. descr.; Stål, 1872, p. 90, cat. (subgenus *Diplodus*); Lethierry and Severin, 1896, p. 152, cat.; Champion, 1898, (in part), p. 257–258, Tab. XV. fig. 19, note, fig. and syn. ( of *Z. litigiosus* ) ; Fracker, 1913, p. 239, 240, key and list (subgenus *Diplodus*); Wygodzinsky, 1949a, p. 49, checklist.

*Diplodus janus*, Uhler, 1886, p. 24, checklist.

Identifications not verified:

*Zelus janus*, Fracker and Bruner, 1924, p. 170–171, note.

*Diplodus janus*, Walker, 1873, p. 124, cat.

DIAGNOSIS: Among closely related species from overlapping distribution ranges, *Z. janus* is the only species with the humeral angle elevated to about same level as the disc

of the posterior pronotal lobe; much larger than and the coloration different from two other species sharing this feature, *Z. exanguis* and *Z. ambulans*, from the same geographical areas. Other characters useful for diagnosis: the dorsal surface usually mostly brown and the lateral and ventral surfaces lighter, yellowish brown; the abdominal segment each with single dark spot anteriorly. The medial process narrower, relatively short.

DESCRIPTION: *MALE*: Large, total length 15.44–19.55 (mean=17.63, Table 4.2); robust. **COLORATION**: Dorsal surface nearly uniformly brown; distal part of corium sometimes yellowish or reddish. Lateral and ventral surfaces yellowish brown; dark brown stripe along posterior margin of abdominal segment and spot anteriorly. Legs with indistinct banding or completely dark brown. **VESTITURE**: Sparsely setose. Similar to that in *Z. armillatus*; adpressed setae denser; long, erect setae on head and pronotum relatively shorter. **STRUCTURE: Head**: Cylindrical, L/W = 2.28. Postocular lobe long; in dorsal view anteriorly gradually narrowing, posterior portion constant, slightly narrower. Eye smallish; lateral margin much wider than postocular lobe; margins removed from dorsal and ventral surfaces of head in lateral view. *Labium*: I: II: III = 1: 1.3: 0.3. Basiflagellomere diameter smaller than that of pedicel. **Thorax**: Antero-lateral angle bearing small projection; medial longitudinal sulcus shallow near collar, deepening posteriorly. Posterior pronotal lobe with finely rugulose surface; disc about same level as humeral angle; humeral angle armed, with short tuberculate processes. Scutellum short; apex angulate. *Legs*: Robust. *Hemelytron*: Slightly surpassing apex of abdomen, not more than length of abdominal segment 7; quadrate cell large and broad; Cu and M of cubital cell converging towards R. **GENITALIA: Pygophore**: Ovoid; slightly expanded laterally near base of paramere in dorsal view; posteriorly expanded sac-like sclerite

between parameres and medial process. Medial process cylindrical; slender; short; semi-erect; slightly curved; apex in posterior view truncate, with small sharp lateral projections. *Paramere*: Cylindrical; short, not reaching apex of medial process; directed posteriad; not distinctly curved; apical part not enlarged. *Phallus*: Dorsal phallosclerite shield-shaped; lateral expansion arising close to base; apical portion of phallosclerite not distinctly tapered, flat, laterally angulate; apex truncate, not emarginate; proximal edge broadly concave, medially deeper. Struts attached to dorsal phallosclerite; apically separate, connected by bridge; basally separate. Basal plate arm moderately robust; separate; converging; in lateral view slightly curved; bridge short; extension of basal plate expanded onto arm.

*FEMALE*: Similar to male, except for the following. Larger than male, total length 19.01–21.96 (mean 20.53, Table 4.2). Whitish area on distal part of corium smaller, almost non-existent in some specimens; posterior pronotal lobe, corium and clavus entirely yellowish brown in some specimens.

*DISTRIBUTION*: North America, Central America. Texas, Mexico, Belize, Honduras, Guatemala, Nicaragua.

*DISCUSSION*: This species is impossible to distinguish from *armillatus* on the basis of the male genitalia alone, the only 2 species in the genus where such distinction cannot be made. As the humeral angles of the posterior pronotal lobe are raised to the level of and are nearly continuous with the disc, however, it is quite easy to separate specimens of these species. There is further divergence in coloration and pattern between the 2 which may be seen in the descriptions of these species. A sympatric and closely related species, *litigiosus*, also has the disc elevated above the humeral angles



and is easily distinguished. *Z. janus* has a somewhat more uniform brown dorsal coloration, whereas the color pattern in *litigiosus* is more variable.

***Zelus leucogrammus* (Perty, 1833)** Figs 4.3, 4.13, 4.28.

HOLOTYPE: Destroyed. See 'Discussion'.

*Reduvius leucogrammus* Perty, 1834, p. 174, pl. 34, fig. 14, orig. descr. and fig.

*Zelus leucogrammus*, Stål, 1872, p. 90, cat. (subgenus *Diplodus*); Lethierry and Severin, 1896, p. 152, cat.; Costa Lima, 1940, p. 7, 218, 224 illus., biol. notes (subgenus *Diplocodus*); Wygodzinsky, 1949a, p. 49, checklist.

Identifications not verified:

*Zelus leucogrammus*, Berg, 1879, p. 152–153, cat., descr. and nymph (subgenus *Diplodus*); Wygodzinsky, 1957, p. 264, list (*Z. leucogramus* (sic.)); Wygodzinsky, 1960, p. 307, local.

DIAGNOSIS: The black dorsal and red ventral coloration is distinctive of this species; the legs uniformly black; the posterior lobe with medial depression.

DESCRIPTION: *MALE*: Large, total length 15.44–19.55 (mean=19.05, Table 4.2); robust. **COLORATION**: Reddish and brownish black. Surface of head primarily reddish, except for around ocellus and lateral stripe on postocular lobe brownish black, occasional specimens with most of dorsal surface of head brownish black. Scape and pedicel dark brown; flagellomeres reddish brown. Dorsal surface of pronotum mostly brownish black, margins usually reddish, sometimes also with reddish patch at center; lateral surface with mixed red and black. Scutellum red to brownish black. Hemelytron nearly entirely brownish black, extreme distal end somewhat reddish. Legs uniformly brownish black, without bands. Abdomen nearly entirely reddish, sometimes with dark

brown patch on connexivum or brownish strip on posterior margin of segment. Often with whitish wax-like exudation. **VESTITURE:** Sparsely setose. Similar to that in *Zelus armillatus*; lacking adpressed setae; some erect setae on dorsum of head and pronotum spine-like. **STRUCTURE: Head:** Cylindrical, L/W = 2.45. Postocular lobe long; in dorsal view anteriorly gradually narrowing, posterior portion constant, slightly narrower. Eye smallish; lateral margin much wider than postocular lobe; margins removed from dorsal and ventral surfaces of head in lateral view. *Labium:* I: II: III = 1: 1.5: 0.4. Basiflagellomere diameter slightly larger than that of pedicel. **Thorax:** Antero-lateral angle bearing small projection; medial longitudinal sulcus shallow near collar, deepening posteriorly. Posterior pronotal lobe with smooth surface; disc distinctly elevated above humeral angle; humeral angle armed, with spinous processes. Scutellum short; apex angulate. *Legs:* Robust. *Hemelytron:* Slightly surpassing apex of abdomen, not more than length of abdominal segment 7; quadrate cell moderately large; Cu and M of cubital cell converging towards R. **GENITALIA: Pygophore:** Ovoid; slightly expanded laterally near base of paramere in dorsal view; posteriorly expanded sac-like sclerite between parameres and medial process. Medial process cylindrical; slender; moderately long; posteriorly directed; basally slightly protruding; apex in posterior view truncate, with very inconspicuous lateral prongs. *Paramere:* Cylindrical; moderately long, not reaching apex of medial process; directed posteriad; slightly curved dorsad; apical part enlarged. *Phallus:* Dorsal phallothecal sclerite shield-shaped; lateral expansion arising close to base; apical portion of phallothecal sclerite not distinctly tapered, flat, laterally angulate; apex truncate, not emarginate; proximal edge broadly inversely V-shaped. Struts attached to dorsal phallothecal sclerite; apically separate, connected by bridge; basally

separate. Basal plate arm moderately robust; separate; converging; in lateral view slightly curved; bridge short; extension of basal plate expanded onto arm.

*FEMALE*: Similar to male, except for the following. Larger than male, total length 21.67–24.62 (mean 21.67, Table 4.2).

*DISTRIBUTION*: South America. Colombia, Paraguay, Brazil, Argentina.

*DISCUSSION*: *Zelus leucogrammus* is one of the most distinctive species among *Zelus*. It can be easily recognized the red and black coloration, the medial depression on the posterior pronotal lobe. Variation in coloration is minimal and is usually seen in the size the dark area on the posterior pronotal lobe. The type material for this species was destroyed during World War II. The original description lists this species from the Amazon River. As this is such an distinctive species, a neotype is not designated.

***Zelus lewisi* sp. nov.** Figs 4.4, 4.27.

*HOLOTYPE*: **COSTA RICA: Alajuela**: San Cristobal, 10.49557°N 84.55206°W, 610 m, Mar 1998, F. Quesada, 1;m (UCR\_ENT 00014249) (INBIO).

*DIAGNOSIS*: The body size large. The male can be easily recognized by the black coloration with white markings on scutellum and abdomen. The female yellowish with black spots and markings.

*DESCRIPTION*: *MALE*: Small, total length 18.71–20.15 (mean 19.20, Table 4.2); slender. **COLORATION**: Entire surface blackish. Femora basally brown, single medial band, apically dark brown. Pleura and abdomen with whitish markings. **VESTITURE**: Sparsely setose. Similar to that in *Z. armillatus*, less dense. **STRUCTURE: Head**: Cylindrical, L/W = 2.36. Postocular lobe very long; in dorsal view distinctly narrowing through anterior 2/3, posterior 1/3 constant, tube-like. Eye moderately sized; lateral

margin much wider than postocular lobe; dorsal margin removed from postocular transverse groove, ventral margins attaining ventral surface of head in lateral view. *Labium*: I: II: III = 1: 1.1: 0.3. Basiflagellomere diameter subequal to that of pedicel. **Thorax**: Antero-lateral angle bearing small protuberance; medial longitudinal sulcus distinct throughout. Posterior pronotal lobe with smooth surface; disc distinctly elevated above humeral angle; humeral angle armed, with spinous processes. Scutellum moderately long; apex angulate. *Legs*: Very slender. *Hemelytron*: Surpassing apex of abdomen by about length of abdominal segment 7; quadrate cell small, relatively broad; Cu and M of cubital cell subparallel.

*FEMALE*: Different from male as outlined below. Larger than male, total length 22.52–24.06 (mean 23.29, Table 4.2). Yellowish or reddish with dark spots or markings; hemelytron dark.

ETYMOLOGY: The specific epithet is a patronym, named after Dr. James Lewis, in honor of his contribution to the curation of Heteroptera from Costa Rica at the INBio, without which, the current discovery might not have been possible.

DISTRIBUTION: Central America.

PARATYPES: **COSTA RICA**: **Cartago**: Monumento Nacional Guayabo, Turrialba, 9.97159°N 83.69072°W, 1100 m, 21 Jun 1994, J. F. Corrales, 1;f (UCR\_ENT 00014265) (INBIO). Turrialba, 9.9°N 83.683°W, 1700, K. Cooper, 1;u (UCR\_ENT 00046751) (AMNH).

***Zelus litigiosus* Stål, 1862** Figs 4.4, 4.13, 4.27.

LECTOTYPE: MEXICO: *salle*, 1;f (UCR\_ENT 00041006) (NHRS) (**new designation**).

*Zelus litigiosus* Stål, 1862, p. 453, orig. descr.; Stål, 1872, p. 90, cat. (subgenus *Diplodus*); Lethierry and Severin, 1896, p. 152, cat.; Champion, 1898, p. 257, Tab. XV. fig. 20, 20a, fig. and syn. (= *Z. janus*)

*Diplodus litigiosus*, Uhler, 1886, p. 24, checklist.

Identifications not verified:

*Diplodus litigiosus*, Walker, 1873, p. 124, cat.

DIAGNOSIS: Among species in the *armillatus* group occurring in the general geographical region, *Z. litigiosus* can be easily distinguished from *Z. janus* by the elevated disc of the posterior pronotal lobe. It can be separated from *Z. sulcicollis* by the flat or slightly convex disc of the posterior pronotal lobe, and that being depressed in *Z. sulcicollis*.

DESCRIPTION: *MALE*: Large, total length 17.10–18.80 (mean 18.15, Table 4.2); robust. **COLORATION**: Brown, brownish black, sometimes with orange or red. Dorsal and lateral surfaces of head usually brownish black, ventral surface yellowish brown; variable amount of yellowish brown on antecular lobe; yellowish brown patch usually between eye and ocellus and medially on postocular lobe. Scape and pedicel with yellow and black bands. Areas of setal tracts on anterior pronotal lobe lighter than glabrous surface, difference subtle in some specimens. Posterior lobe usually uniformly brown, orange or red; lateral surfaces lighter in some specimens. Scutellum dark brown. Corium and clavus usually uniform, orange, brown or dark brown; some specimens with distal part lighter; membrane dark brown. Legs usually yellowish brown with black bands, usually one on tibiae and two or three on femora; completely black in some dark specimens. **VESTITURE**: Densely setose. Head with both recumbent and erect setae dorsally, and predominantly short, recumbent setae ventrally. Anterior pronotal lobe with

long erect setae, mainly occupying setal tracs; posterior pronotal lobe with fine, erect setae. Abdomen with short, recumbent setae, interspersed with long, erect setae.

**STRUCTURE: Head:** Cylindrical, L/W = 2.25. Postocular lobe long; in dorsal view anteriorly gradually narrowing, posterior portion constant, slightly narrower. Eye smallish; lateral margin only slightly wider, roughly on line with margin of postocular lobe; dorsal margin removed from postocular transverse groove, ventral margins attaining ventral surface of head in lateral view. *Labium:* I: II: III = 1: 1.4: 0.4. Basiflagellomere diameter subequal to that of pedicel. **Thorax:** Antero-lateral angle bearing small protuberance; medial longitudinal sulcus evident throughout, deepening posteriorly. Posterior pronotal lobe with rugulose surface; disc distinctly elevated above humeral angle; humeral angle armed, with short tuberculate processes. Scutellum moderately long; apex angulate. *Legs:* Slender. *Hemelytron:* Slightly surpassing apex of abdomen, not more than length of abdominal segment 7; quadrate cell large and broad; Cu and M of cubital cell converging towards R. **GENITALIA:** *Pygophore:* Rounded; slightly expanded laterally near base of paramere in dorsal view; posteriorly expanded sac-like sclerite between parameres and medial process. Medial process cylindrical; slender; moderately long; posteriorly directed; straight; apex in posterior view rounded, with very inconspicuous lateral prongs. *Paramere:* Cylindrical; moderately long, not reaching apex of medial process; directed posteriad; nearly straight; apical part not enlarged. *Phallus:* Dorsal phallothecal sclerite somewhat squarish; sharp laterally oriented process close to proximal edge and basal arms; apical portion of phallothecal sclerite not distinctly tapered, flat, lateral margin narrowly angulate; apex rounded; proximal edge broadly concave, medially deeper. Struts attached to dorsal phallothecal sclerite; apically fused; basally mostly separate, moderately fused. Basal plate arm moderately robust; separate;

diverging; in lateral view very slightly curved; bridge short; extension of basal plate small and confined to apex of basal plate arm.

*FEMALE*: Similar to male, except for the following. Larger than male, total length 19.75–21.95 (mean 20.88, Table 4.2). Dorsal surface never entirely brownish black.

DISTRIBUTION: Central America.

***Zelus ruficeps* Stål, 1862** Figs 4.4, 4.13, 4.29.

LECTOTYPE: **MEXICO**: salle, 1;m (UCR\_ENT 00041010) (NHRS) (**new designation**).

*Zelus ruficeps* Stål, 1862, p. 453–454, orig. descr.; Stål, 1872, p. 90, cat. (subgenus *Diplodus*); Lethierry and Severin, 1896, p. 153, cat.; Champion, 1898, p. 256, Tab. 15. fig. 15, note and fig.; Kuhlitz, 1902, p. 266, note; Fracker, 1913, p. 239, 240, list (subgenus *Diplodus*); Wygodzinsky, 1949a, p. 50, checklist.

*Diplodus ruficeps*, Uhler, 1886, p. 24, checklist.

Identifications not verified:

*Diplodus ruficeps*, Walker, 1873, p. 124, cat.

DIAGNOSIS: The combination of relatively large size, stout body, the reddish head and parts of of body can separate both sexes of this species from other species of *Zelus*.

DESCRIPTION: *MALE*: Medium-sized, total length 13.24–16.83 (mean 14.93, Table 4.2); robust. **COLORATION**: Orangish to reddish, with black areas. Head orangish or reddish brown; dark areas on postocular lobe in some specimens. Anterior pronotal lobe orangish or reddish brown; posterior margin dark, sometimes occupying more than 1/2 of surface. Posterior pronotal lobe, corium and clavus orangish brown; sometimes with dark areas on each. Scutellum dark brown; margins yellowish brown. Membrane dark

brown. Legs not distinctly banded; femoral apical portion usually reddish, occasionally dark, single small black band subapically, sometimes very faint black marking medially. Lateral and ventral surfaces orangish to reddish brown; variable black areas on pleura and abdomen; dark stripe along posterior margin of each segment, width variable; pygophore usually reddish. **VESTITURE:** Densely setose. Dorsal surface of head with fine to stiff erect setae and some recumbent setae, lateral and ventral surfaces with erect and recumbent setae. Anterior pronotal lobe with recumbent and erect setae, confined to setal tracts, erect setae predominant; posterior pronotal lobe with erect setae and some recumbent setae. Abdomen with short, recumbent setae, interspersed with erect setae. **STRUCTURE: Head:** Cylindrical, L/W = 2.21. Postocular lobe relatively short; in dorsal view distinctly narrowing through anterior 1/2, posterior 1/2 constant, tube-like. Eye smallish; lateral margin only slightly wider, roughly on line with margin of postocular lobe; dorsal margin attaining postocular transverse groove, ventral margin removed from ventral surface of head in lateral view. *Labium:* I: II: III = 1: 1.4: 0.4. Basiflagellomere diameter subequal to that of pedicel. **Thorax:** Antero-lateral angle bearing small protuberance; medial longitudinal sulcus distinct throughout. Posterior pronotal lobe with rugulose surface; disc distinctly elevated above humeral angle; humeral angle armed, with short tuberculate processes. Scutellum moderately long; apex angulate. *Legs:* Moderately robust. *Hemelytron:* Slightly surpassing apex of abdomen, not more than length of abdominal segment 7; quadrate cell large and broad; Cu and M of cubital cell converging towards R. **GENITALIA: Pygophore:** Rounded; slightly expanded laterally near base of paramere in dorsal view; posteriorly expanded sac-like sclerite between parameres and medial process. Medial process cylindrical; slender; moderately long; posteriorly directed; nearly straight; apex in posterior view



rounded, with small sharp lateral projections. *Paramere*: Cylindrical; moderately long, not reaching apex of medial process; directed posteriad; nearly straight; apical part not enlarged. *Phallus*: Dorsal phallothecal sclerite somewhat squarish; lateral expansion arising close to base; apical portion of phallothecal sclerite not distinctly tapered, flat, lateral margin narrowly angulate; apex rounded; proximal edge broadly inversely V-shaped. Struts attached to dorsal phallothecal sclerite; apically fused; basally separate throughout. Basal plate arm moderately robust; basally fused; in lateral view very slightly curved; bridge extremely short; extension of basal plate small, marginally expanded onto arm.

*FEMALE*: Similar to male, except for the following. Larger than male, total length 16.46–20.01 (mean 17.84, Table 4.2). Usually lighter than male and larger areas of red and yellow.

DISTRIBUTION: Central America, southern Central America.

PARALECTOTYPES: **COLOMBIA: Valle del Cauca**: Buenaventura, 3.8933°N 77.0697°W, 02 Nov 1950, Michelbacher and Ross, 1;m (UCR\_ENT 00019703) (CAS); 06 Nov 1950, Michelbacher and Ross, 1;m (UCR\_ENT 00019704) (CAS). **COSTA RICA: Unknown**: Costa Rica, Jul 1905, P. Biolley, 1;m (UCR\_ENT 00019705), 2;f (UCR\_ENT 00019706, UCR\_ENT 00019707) (CAS). (**new designation**)

***Zelus sulcicollis* Champion, 1899** Figs 4.4, 4.13, 4.27.

LECTOTYPE: **GUATEMALA: Baja Verapaz**: San Geronimo, No date provided, G.C. Champion, 1;f (UCR\_ENT 00048760) (BMNH) (**new designation**).

*Zelus sulcicollis* Champion, 1898, p. 258–259, Tab. XV. fig. 21, orig. descr. and fig.;

Fracker, 1913, p. 239, 240, key and list (subgenus *Diplodus*); Wygodzinsky, 1949a, p. 50, checklist.

**DIAGNOSIS:** Recognized by the dorsal coloration nearly uniformly brown, somewhat reddish and the posterior pronotal lobe medially somewhat depressed.

**DESCRIPTION:** *MALE:* Large, total length 14.86–20.26 (mean 18.10, Table 4.2); robust. **COLORATION:** Brown to reddish; uniform. Entire surface quite uniformly brown, appearing reddish in some specimens. Legs usually uniform, not distinctly banded; femora with faint dark markings in some specimens. Connexivum banded. **VESTITURE:** Densely setose. Similar to that in *Z. armillatus*; dorsal setation more spine-like.

**STRUCTURE: Head:** Cylindrical, L/W = 2.47. Postocular lobe moderately long; in dorsal view anteriorly gradually narrowing, posterior portion constant, slightly narrower. Eye smallish; lateral margin only slightly wider, roughly on line with margin of postocular lobe; dorsal margin attaining postocular transverse groove, ventral margin removed from ventral surface of head in lateral view. *Labium:* I: II: III = 1: 1.4: 0.3. Basiflagellomere diameter subequal to that of pedicel. **Thorax:** Antero-lateral angle bearing small protuberance; medial longitudinal sulcus distinct throughout. Posterior pronotal lobe with rugulose surface; disc distinctly elevated above humeral angle; humeral angle armed, with spinous processes. Scutellum moderately long; apex angulate. *Legs:* Moderately robust. *Hemelytron:* Slightly surpassing apex of abdomen, not more than length of abdominal segment 7; quadrate cell large and broad; Cu and M of cubital cell converging towards R. **GENITALIA:** *Pygophore:* Rounded; slightly expanded laterally near base of paramere in dorsal view; posteriorly expanded sac-like sclerite between parameres and medial process. Medial process cylindrical; slender; moderately long; posteriorly

directed; straight; apex in posterior view rounded, with very inconspicuous lateral prongs. *Paramere*: Cylindrical; moderately long, not reaching apex of medial process; directed posteriad; slightly curved dorsad; apical part very slightly enlarged. *Phallus*: Dorsal phallosomal sclerite somewhat squarish; lateral expansion arising close to base; apical portion of phallosomal sclerite not distinctly tapered, flat, lateral margin narrowly angulate; apex rounded; proximal edge broadly concave, medially deeper. Struts attached to dorsal phallosomal sclerite; apically fused; basally mostly separate, moderately fused. Basal plate arm moderately robust; separate; diverging; in lateral view very slightly curved; bridge short; extension of basal plate small, marginally expanded onto arm.

*FEMALE*: Similar to male, except for the following. Larger than male, total length 20.59–21.91 (mean 21.41, Table 4.2).

*DISTRIBUTION*: Central America.

***Zelus umbraculoides* sp. nov.** Figs 4.4, 4.28.

*HOLOTYPE*: **PARAGUAY: Alto Parana**: Alto Parana, 12 Nov 1990 – 16 Nov 1990, G. Arriagada, 1;m (UCR\_ENT 00029367) (USNM).

*DIAGNOSIS*: The greenish body coloration, the area posterior to eye greatly elevated, somewhat punctate is diagnostic to this species and another closely related species, *Z. umbraculus*. It can be separated from the latter species by having the entire posterior pronotal lobe convex, whereas the lateral part is somewhat depressed in *Z. umbraculus*.

*DESCRIPTION*: *MALE*: Medium-sized; robust. **COLORATION**: Entire surface greenish brown; lateral surfaces lighter. **VESTITURE**: Sparsely setose. Similar to that in

*Z. umbraculus*. Abdomen with. **STRUCTURE: Head:** Stout. Postocular lobe relatively short; in dorsal view distinctly narrowing through anterior 1/2, posterior 1/2 constant, tube-like. Eye prominent; lateral margin much wider than postocular lobe; dorsal margin removed from postocular transverse groove, ventral margins attaining ventral surface of head in lateral view. *Labium:* Basiflagellomere diameter subequal to that of pedicel.

**Thorax:** Antero-lateral angle rounded, without projection; medial longitudinal sulcus evident only on posterior 1/2, deepening anterior to transverse sulcus of pronotum. Posterior pronotal lobe with rugulose surface; disc slightly elevated above humeral angle; humeral angle armed, with short tuberculate processes. Scutellum moderately long; apex angulate, slightly projected upward. *Legs:* Moderately robust. *Hemelytron:* Slightly surpassing apex of abdomen, not more than length of abdominal segment 7; quadrate cell moderately sized; Cu and M of cubital cell converging towards R.

*FEMALE:* Unknown.

ETYMOLOGY: The name indicates its close resemblance to *Z. umbraculoides*, another new species described in the current study.

DISTRIBUTION: South America.

PARATYPES: **BOLIVIA: La Paz:** Tres Esteros, Guanay, 15.4833°S 67.8833°W, 19 Aug 1989 – 25 Aug 1989, L. Pena, 1;m (UCR\_ENT 00026160) (USNM). **PERU: Madre de Dios: Tambopata Co.:** Rio Tambopata Reserve, 30 air km SW Pto. Maldonado, 12.74338°S 69.49339°W, 290 m, 16 Nov 1979 – 20 Nov 1979, J. B. Heppner, 1;m (UCR\_ENT 00009314) (USNM).

DISCUSSION: This species is rather similar to and shares a number of characters with *Z. umbraculus*: the proximal area of membrane dark brown; the area behind the eye strongly elevated; and the anterior pronotal lobe short.

***Zelus umbraculus* sp. nov.** Figs 4.4, 4.13, 4.28.

HOLOTYPE: **BRAZIL: Parana:** Caviuna, 23.2°S 51.36666°W, Aug 1947, A. Maller, 1;m (UCR\_ENT 00017040) (AMNH).

DIAGNOSIS: The greenish body coloration, the area posterior to eye greatly elevated, somewhat punduncate is diagnostic to this species and another closely related species, *Z. umbraculoides*. It can be separated from the latter species by having the lateral part of the posterior pronotal lobe depressed, while the entire lobe is conved in *Z. umbraculoides*.

DESCRIPTION: **MALE:** Large, total length 14.03–15.75 (mean 14.80, Table 4.2); robust. **COLORATION:** Entire surface greenish brown; lateral surfaces lighter. **VESTITURE:** Sparsely setose. Head with short, erect and some short spine-like setae dorsally, and short, recumbent and long, erect setae ventrally. Posterior pronotal lobe with sparse, scattered, erect and decumbent setae. Abdomen with short, recumbent and short to long, erect setae. **STRUCTURE: Head:** Cylindrical, LW = 1.98. Postocular lobe relatively short; in dorsal view distinctly narrowing through anterior 1/2, posterior 1/2 constant, tube-like. Eye prominent; lateral margin much wider than postocular lobe; dorsal margin removed from postocular transverse groove, ventral margins attaining ventral surface of head in lateral view. **Labium:** I: II: III = 1: 1.3: 0.3. Basiflagellomere diameter subequal to that of pedicel. **Thorax:** Antero-lateral angle rounded, without projection; medial longitudinal sulcus evident only on posterior 1/2, deepening anterior to transverse sulcus of pronotum. Posterior pronotal lobe with rugulose surface; disc distinctly elevated above humeral angle; humeral angle armed, with short tuberculate processes. Scutellum moderately long; apex blunt, slightly projected upward. **Legs:** Moderately robust. **Hemelytron:** Slightly surpassing apex of abdomen, not more than

length of abdominal segment 7; quadrate cell moderately sized; Cu and M of cubital cell converging towards R. **GENITALIA:** *Pygophore*: Rounded; not expanded laterally in dorsal view. Medial process cylindrical; base broad; moderately long; straight; apex in posterior view rounded, with small sharp lateral projections. *Paramere*: Cylindrical; moderately long, not reaching apex of medial process; directed posteriad; basally slightly constricted; not distinctly curved. *Phallus*: Dorsal phallosomal sclerite elongated; lateral expansion arising close to base; apical portion of phallosomal sclerite not distinctly tapered, slightly convex; apex rounded; proximal edge broadly concave. Struts attached to dorsal phallosomal sclerite; apically separate, connected by bridge; basally mostly separate, moderately fused. Basal plate arm moderately robust; separate; diverging; in lateral view very slightly curved; bridge short; extension of basal plate small, marginally expanded onto arm.

*FEMALE*: Unknown.

ETYMOLOGY: The name refers to the eye in the shape of an umbrella.

DISTRIBUTION: South America.

PARATYPES: **ECUADOR: Orellana**: Coca (on Rio Napo), 0.4183°S 76.9857°W, May 1965, L. E. Peña, 1;m (UCR\_ENT 00017041) (AMNH). **PERU: Lambayeque**: 94 mi E of Olmos, 5.98497°S 78.3751°W, 18 Jan 1955, E. I. Schlinger & E. S. Ross, 2;m (UCR\_ENT 00019692, UCR\_ENT 00019694) (CAS).

***Zelus aithaleos* sp. nov.** Figs 4.4, 4.14, 4.31.

HOLOTYPE: **PERU: Huanuco**: Aerro Puerto, Tingo Maria, 9.3°S 76.01666°W, 671 m, 22 Oct 1946, J. C. Pallister, 1;m (UCR\_ENT 00047314) (AMNH).

**DIAGNOSIS:** The postocular lobe relatively short, 1.66x of the length of anteocular lobe in male and 1.23x in female; the anterior pronotal lobe rather short; the strongly convex pronotum. The medial process basally curved.

**DESCRIPTION:** *MALE:* Medium-sized, total length 13.47 (n=1); slender.

**COLORATION:** Entirely dark, nearly black; very inconspicuous light colored, rather thin, medial longitudinal stripe on postocular lobe. Membrane of hemelytron semi-translucent. **VESTITURE:** Densely setose. Dorsum of anteocular lobe with moderately dense, short, recumbent and sparse, short, erect, spine-like setae. Dorsum of postocular lobe nearly glabrous; spine-like setae anteriorly between eyes; stripe of longitudinal whitish adpressed setae laterally. Ventral surface of head with moderately dense, recumbent setae, intermixed with erect setae. Scape nearly glabrous. Pronotum with dense, short, erect, stout, spine-like setae, also on lateral surfaces and pleura.; scutellum with dense, apically curved, stout setae. Legs with sparse setation. Sundew setae on fore femur sparse. Abdomen with moderately dense, short, semi-erect, fine setae. Ventral surface of pygophore with sparse, long, erect setae; postero-ventral rim with long, erect setae; Paramere apically with dense, short to long, erect setae.

**STRUCTURE: Head:** Cylindrical, L/W = 2.30. Postocular lobe short; in dorsal view anteriorly gradually narrowing, posterior portion constant, slightly narrower. Eye moderately sized; dorsal margin attaining postocular transverse groove, ventral margin removed from ventral surface of head in lateral view. *Labium:* I: II: III = 1: 1.7: 0.5. Basiflagellomere diameter slightly larger than that of pedicel. **Thorax:** Antero-lateral angle rounded, without projection; medial longitudinal sulcus evident throughout, deepening posteriorly. Posterior pronotal lobe with rugulose surface; disc distinctly elevated above humeral angle; humeral angle rounded, without projection. Scutellum

long; apex angulate, slightly projected upward. *Legs*: Very slender. *Hemelytron*: Greatly surpassing apex of abdomen by about 3x length of abdominal segment 7; quadrate cell large and broad; Cu and M of cubital cell subparallel. **GENITALIA**: *Pygophore*: Elongate ovoid; mid-lateral fold adjacent to paramere insertion; slightly expanded laterally near base of paramere in dorsal view. Medial process somewhat cone-shaped; long, nearly as long as paramere; posteriorly directed; basally slightly curved; apex in posterior view blunt, without modification. *Paramere*: Cylindrical; moderately long, not reaching apex of medial process; directed posteriad, slightly curved towards medial process; nearly straight; apical part slightly enlarged, depression along inner side. *Phallus*: Dorsal phalloshecal sclerite elongated; sub-medially slightly constricted; apical 1/3 of phalloshecal sclerite tapering to apex, strong convex; apex medially notched; proximal edge deeply concave. Struts attached to dorsal phalloshecal sclerite; apically separate, connected by bridge; basally separate. Basal plate arm extremely slender; separate; subparallel; bridge short; extension of basal plate well developed, only slightly expanded laterally.

*FEMALE*: Similar to male, except for the following. Larger than male, total length 13.87–17.61 (mean 16.27, Table 4.2). Occasional specimens with orange posterior pronotal lobe and mesopleuron. Setae on some specimens golden.

ETYMOLOGY: From Greek *aithales*, meaning evergreen.

DISTRIBUTION: South America.

PARATYPES: **BOLIVIA: La Paz**: Guanay, 15.4833°S 67.8833°W, Oct-Nov 1993, L. Pena, 2;f (UCR\_ENT 00009327–28) (USNM). **BRAZIL: Goias**: Annapolis, 16.3333°S 48.9667°W, 07 Feb 1936, 1;f (UCR\_ENT 00071251) (TAMU). **PARAGUAY: Guaira**:



Paso-Yobai, 25.72344°S 55.9969°W, 280 m, 28 Sep 1951, Foerster, 1;f (UCR\_ENT 00071252) (TAMU).

***Zelus bahiaensis* sp. nov.** Figs 4.4, 4.14, 4.32.

HOLOTYPE: **BRAZIL: Bahia:** Agua Preta, 14.58333°S 39.26666°W, No date provided, P. Silva, 1;m (UCR\_ENT 00071255) (TAMU).

DIAGNOSIS: Can be recognized by the following combination of characters: the anterior pronotal lobe dark brown and the posterior pronotal lobe orange; the 1A and Pcu not intersecting, short crossvein between them; the long and slender, cylindrical medial process; the medial process apically folded posteriad; the rather long paramere.

DESCRIPTION: *MALE*: Medium-sized, total length 12.35 (n=1); slender.

**COLORATION:** Much of body surface including head, anterior pronotal lobe, membrane, legs dark brown; very slender lighter colored medial longitudinal stripe on postocular lobe. Posterior pronotal lobe and corium orange. Pleura, abdomen reddish brown.

**VESTITURE:** Moderately setose. Dorsum of anteocular and anterior part of postocular with moderately dense, short, erect, spine-like setae, posterior part of postocular nearly glabrous; ventral surface of head with sparse, short, erect or recumbent setae. Pronotum with dense, short, erect, spine-like setae on dorsum and lateral surfaces, anterior lobe also intermixed with sparse, long, fine setae. Pleura with spine-like setae, sparse on metapleuron; intermixed with short to long, erect, fine and short, recumbent setae.; scutellum with spine-like setae and erect, fine setae. Legs with very sparse setation. Corium and clavus with short, recumbent setae. Abdomen with moderately dense, short, semi-erect, fine setae, intermixed with sparse, long setae. Bush of moderately long, erect setae flanking medial process on postero-ventral rim of pygophore; paramere

apically with sparse, short, erect setae. **STRUCTURE: Head:** Cylindrical, L/W = 2.27. Postocular lobe long; in dorsal view distinctly narrowing through anterior 2/3, posterior 1/3 constant, tube-like. Eye moderately sized; lateral margin much wider than postocular lobe; dorsal margin removed from postocular transverse groove, ventral margins attaining ventral surface of head in lateral view. *Labium:* I: II: III = 1: 1.8: 0.6. Basiflagellomere diameter slightly larger than that of pedicel. **Thorax:** Antero-lateral angle rounded, without projection; medial longitudinal sulcus evident throughout, deepening posteriorly. Posterior pronotal lobe with rugulose surface; disc distinctly elevated above humeral angle; humeral angle rounded, without projection. Scutellum moderately long; apex slightly pointed, not projected. *Legs:* Very slender. *Hemelytron:* Greatly surpassing apex of abdomen by about 3x length of abdominal segment 7; quadrate cell large and broad; Cu and M of cubital cell subparallel. **GENITALIA:** *Pygophore:* Ovoid; mid-lateral fold adjacent to paramere insertion; slightly expanded laterally near base of paramere in dorsal view. Medial process cylindrical; very slender; moderately long, nearly half length of paramere; posteriorly directed; basal 2/3 straight, apically curved; apex in posterior view blunt, folded posteriad, marginally narrower. *Paramere:* Cylindrical; long, surpassing medial process; directed posteriad; slightly curved ventrad; apical part very slightly enlarged. *Phallus:* Dorsal phallosclerite elongated; apical portion of phallosclerite not distinctly tapered, convex, laterally angulate; apex truncate, medially emarginate; proximal edge deeply concave. Struts attached to dorsal phallosclerite; apically separate, connected by bridge; basally mostly separate, moderately fused. Basal plate arm slender; separate; converging; in lateral view apically curved; bridge short; extension of basal plate expanded onto arm.

*FEMALE:* Unknown.

ETYMOLOGY: Named after the Brazilian state Bahia, where the holotype was collected.

DISTRIBUTION: South America. Known from a single locality in Brazil.

***Zelus championi* sp. nov.** Figs 4.4, 4.15, 4.31.

HOLOTYPE: **PANAMA: Chiriqui:** Bugaba, 8.4833°N 82.6167°W, 457 m, No date provided, G.C. Champion, 1;m (UCR\_ENT 00048759) (BMNH).

DIAGNOSIS: The black dorsal coloration and the abdomen brightly red is distinctive of this species. The features of the genitalia are rather close to those in other species in the *vagans* group, but the apex of the medial process is more strongly bent.

DESCRIPTION: *MALE*: Medium-sized, total length 10.85–12.29 (mean 11.79, Table 4.2); slender. **COLORATION**: Head, pronotum and hemelytron entirely black; abdomen brightly red; pygophore black. **VESTITURE**: Densely setose. Dorsal surface of head with short, spine-like setae, pubescence of remainder of surface consisting of erect and recumbent setae. Pronotum with short, spine-like setae dorsally and laterally. Abdomen with scattered, erect setae of varying lengths. **STRUCTURE: Head**: Cylindrical, L/W = 2.00. Postocular lobe short; in dorsal view narrowing till abrupt posterior constriction, very short behind constriction. Eye smallish; lateral margin only slightly wider, roughly on line with margin of postocular lobe; margins removed from dorsal and ventral surfaces of head in lateral view. *Labium*: I: II: III = 1: 1.4: 0.5. Basiflagellomere diameter larger than that of pedicel. **Thorax**: Antero-lateral angle rounded, without projection; medial longitudinal sulcus shallow near collar, deepening posteriorly. Posterior pronotal lobe with rugulose surface; disc distinctly elevated above humeral angle; humeral angle rounded, without projection. Scutellum short; apex blunt, not projected. *Legs*: Moderately

robust. *Hemelytron*: Greatly surpassing apex of abdomen by about 3x length of abdominal segment 7; quadrate cell large and broad; Cu and M of cubital cell subparallel. **GENITALIA:** *Pygophore*: Ovoid; mid-lateral fold adjacent to paramere insertion; slightly expanded laterally near base of paramere in dorsal view. Medial process somewhat cone-shaped; tapering to apex; moderately long; laterally compressed towards apex; posteriorly directed; straight; apex in posterior view pointed, without modification. *Paramere*: Cylindrical; moderately long, nearly reaching apex of medial process; directed posteriad; basally narrower; slightly curved ventrad; apical part not enlarged. *Phallus*: Dorsal phallosomal sclerite elongated; apical portion of phallosomal sclerite gradually tapering, slightly convex, laterally rounded, not forming angle; apex rounded, medially emarginate; proximal edge deeply concave. Struts attached to dorsal phallosomal sclerite; apically separate, connected by bridge; basally separate throughout. Basal plate arm slender; separate; converging; in lateral view very slightly curved; bridge moderately long; extension of basal plate small, marginally expanded onto arm.

*FEMALE*: Unknown.

DISTRIBUTION: Central America.

***Zelus errans* Fabricius, 1803** Figs 4.5, 4.14, 4.32.

*Zelus errans* Fabricius, 1803, p. 282, orig. descr.; Stål, 1868, p.108, descr., note and syn. (of *Zelus cursitans*); Stål, 1872, p.88, cat.; Wygodzinsky, 1949a, p. 49, checklist.

*Zelus cursitans* Fabricius, 1803, p. 284, orig. descr.; Stål, 1868, p. 108, syn. (= *Zelus errans*).

Identifications not verified:

*Zelus errans*, Walker, 1873, p. 135, cat.

*Zelus cursitans*, Blanchard, 1840, p. 101, descr.

DIAGNOSIS: Male can be recognized by the rather slender and moderately long medial process, much longer than that in a closely related species, *Z. vespiformis*.

DESCRIPTION: *MALE*: Medium-sized, total length 13.62–17.91 (mean 14.10, Table 4.2); slender. **COLORATION**: Many specimens with wasp-like habitus, with alternating black and yellow areas; anterior pronotal lobe usually dark brown, posterior lobe and proximal portion of corium yellowish; some specimens with nearly entire dorsal surface dark. **VESTITURE**: Densely setose. Head with dark, erect, spine-like setae dorsally and light, recumbent setae ventrally. Anterior pronotal lobe with short, dark, spine-like setae, confined to setal tracts; posterior pronotal lobe with short, spine-like setae dorsally, fine, recumbent and erect setae on lateral surfaces. Abdomen with sparse, short, semi-erect setae. **STRUCTURE: Head**: Cylindrical, L/W = 2.28. Postocular lobe long; in dorsal view distinctly narrowing through anterior 2/3, posterior 1/3 constant, tube-like. Eye prominent; lateral margin much wider than postocular lobe; dorsal margin removed from postocular transverse groove, ventral margins attaining ventral surface of head in lateral view. *Labium*: I: II: III = 1: 1.6: 0.4. Basiflagellomere diameter larger than that of pedicel. **Thorax**: Antero-lateral angle rounded, without projection; medial longitudinal sulcus evident only on posterior 1/2, deepening anterior to transverse sulcus of pronotum. Posterior pronotal lobe with smooth surface; disc distinctly elevated above humeral angle; humeral angle rounded, without projection. Scutellum long; apex angulate, not projected. *Legs*: Very slender. *Hemelytron*: Greatly surpassing apex of abdomen by about 3x length of abdominal segment 7; quadrate cell large and broad; Cu and M of

cubital cell subparallel. **GENITALIA:** *Pygophore*: Ovoid; mid-lateral fold adjacent to paramere insertion; not expanded laterally in dorsal view. Medial process cylindrical; very slender; moderately long; semi-erect; nearly straight; apex in posterior view blunt, slightly folded posteriad. *Paramere*: Cylindrical; long, surpassing medial process; directed posteriad, slightly curved towards medial process; slightly curved ventrad; apical part very slightly enlarged. *Phallus*: Dorsal phallothecal sclerite elongated; apical portion of phallothecal sclerite not distinctly tapered, convex, laterally indistinctly angulate; apex truncate, medially emarginate; proximal edge deeply concave. Struts attached to dorsal phallothecal sclerite; apically separate, connected by bridge; basally almost completely fused. Basal plate arm slender; separate; converging; in lateral view very slightly curved; bridge moderately long; extension of basal plate small, marginally expanded onto arm.

*FEMALE*: Similar to male, except for the following. Larger than male, total length 18.30–20.18 (mean 18.97, Table 4.2). Coloration pattern more variable than in male.

*DISTRIBUTION*: Southern South America.

***Zelus longipes* (Linnaeus, 1767)** Figs 4.5, 4.14, 4.33.

*HOLOTYPE*: The female holotype of *Zelus longipes* is deposited in the collection of the Linnaean Society, London, and bears the following labels: *longipes* / 65. The specimen is from the island of St. Thomas in the West Indies.

*Cimex longipes* Linnaeus, 1767, p. 724, orig. descr.; Grnelin, 1788, p. 2197, list

(*Reduvius*); Turton, 1806, p. 690, descr.

*Reduvius longipes*, Fabricius, 1775, p. 730, descr.; Fabricius, 1781, p. 378, descr.;

Fabricius, 1787, p. 309, list; Fabricius, 1794, p. 196, descr.

*Zelus longipes*, Fabricius, 1803, p. 283, descr.; Stål 1872, p. 88-89, cat. (subgenus *Zelus*); Uhler, 1886, p. 24, checklist; Lethierry and Severin, 1896, p. 152, cat.; Champion, 1898, p. 253, note; Kirkaldy, 1900a, p. 263, note; Fracker, 1913, p. 239, 240, key and list (subgenus *Zelus*); Barber, 1923, p. 27-28, note and syn.; Wygodzinsky, 1949a, p. 49, checklist; Barber, 1954, p. 13-14, list; Elkins, 1954, p. 44, 45, note and figure; Alayo, 1967, p. 5, 36-37, list and note.

*Reduvius rubidus* Le Peletier and Serville, 1825, p. 278, orig. descr.; Guerin-Meneville, 1857, p. 411-412, descr. and list (subgenus *Evagoras*).

*Evagoras rubidus*, Amyot and Serville, 1843, p. 368-369, descr. and syn. (of *Evagoras speciosus* Burm.).

*Euagoras rubidus*, Stål, 1862, p. 449, syn. (in part) (of *Z. longipes*).

*Zelus rubidus*, Stål, 1872, p. 89, cat. and descr. (subgenus *Zelus*); Uhler, 1886, p. 24, checklist; Lethierry and Severin, 1896, p. 153, cat.; Champion, 1898, p. 252-253, cat. and note; Fracker, 1913, p. 238, 240, key and list (subgenus *Zelus*) Barber, 1923, p. 27, syn. (*Z. longipes*); Bruner, 1926, p. 78, descr.; Wygodzinsky, 1949a, p. 49, checklist and syn. (= *Z. longipes*); Alayo, 1967, p. 36-37, note.

*Reduvius phalangium* Fabricius, 1794, p. 1966, orig. descr.; Zirnsen, 1964, p. 338, list; Hart, 1986, p. 543, syn.

*Zelus phalangium*, Fabricius, 1803, p. 283, descr.; Stål, 1872, p. 92, cat.; Lethierry and Severin, 1896, p. 153, cat.; Fracker, 1913, p. 240, descr. and list; Wygodzinsky, 1949a, p. 50, checklist.

*Diplodus phalangium*, Uhler, 1886, p. 24, checklist.

*Zelus bilobus* Say, 1832, p. 12, orig. descr.; LeConte, 1859, p. 306, descr.; Stål, 1872, p. 88, cat. (subgenus *Zelus*); Uhler, 1876, p. 61, list; Uhler, 1886, p. 24, checklist;

Lethierry and Severin, 1896, p. 151, cat.; Fracker, 1913, p. 239, 240, key and list (subgenus *Zelus*); Van Duzee, 1916, p. 30, checklist (s .g. *Zelus*); Van Duzee, 1917, p. 259, cat. ( subgenus *Zelus*); Blatchley, 1926, p. 568, 569, key and descr. (subgenus *Zelus*); Readio, 1927, p. 169-170, key, descr. and note; Wygodzinsky, 1949a, p. 48, checklist; Hart, 1986, p. 543, syn.

*Euagoras speciosus* Burmeister, 1835, p. 227, orig. descr.; Herrich-Schaeffer, 1848, p. 45, Tab. CCLXIV. fig. 817, descr. and fig; Hart, 1986, p. 543, syn.

*Evagoras speciosus*, Amyot and Serville, 1843, p. 368, syn. (= *Evagoras rubidus* Le P. and Serv.).

*Zelus aeciosus*, Stål, 1862, p. 449, syn. (as variety of *Z. longipes*) Stål , 1872, p. 89, cat. (subgenus *Zelus*); Berg, 1879, p. 151, note; Uhler, 1886, p. 24, checklist; Lethierry and Severin, 1896, p. 153, cat.; Kirkaldy, 1909, p. 32, list and syn.; Wygodzinsky, 1949a, p. 50, checklist.

*Zelus speciosus* var. *stolli* Lethierry and Severin, 1896, p. 152, *nomen nudum*; Champion, 1898, p. 253, syn. (= *Zelus rubidus*). *Euagoras tricolor* Herrich-Schaeffer, 1848, p. 45-46, Tab. CCLXIV, fig. 818, orig. descr. and fig.; S t a l , 1862, p. 450, syn. ( as variety of *Zelus longipes*); S t a l , 1872, p. 89, syn. (as variety of *Zelus speciosus*); Champion, 1898, p. 253, syn. (= *Zelus rubidus*); Wygodzinsky, 1949a, p. 50, syn. (of *Zelus speciosus*).

*Zelus mactans* Stål , 1861, p. 148, orig. descr.; Stål, 1872, p. 88, cat. (subgenus *Zelus*); Uhler, 1886, p. 24, checklist; Lethierry and Severin, 1896, p. 152, cat.; Fracker, 1913, p. 239, 240, key and list (subgenus *Zelus*); Barber, 1923, p. 28, note; Wygodzinsky, 1949a, p. 49, checklist; Alayo, 1967, p. 36, key and note.

Identifications not verified:



*Zelus longipes*, Blanchard, 1840, p. 101, descr.; Stål, 1862, p. 449-450, descr.; Uhler, 1878, p. 427, list; Cotton, 1917, p. 170-173, note; Wolcott, 1950 (1948), p. 212, list and note; Elkins, 1951, p. 410, list; Guagliumi, 1953, p. 16, note; Simmonds, 1956, p. 232, note.

*Euagoras longipes*, Walker, 1873, p. 117-118, cat.

*Euagoras rubidus*, Walker, 1873, p. 118, cat.

*Evagoras rubidus*, Walker, 1873, p. 117, syn. (= *Euagoras longipes*).

*Zelus rubidus*, Ballou, 1913, p. 65, note; Jones, 1914, p. 462, note; Osborne and Drake, 1915, p. 531, list; Cotton, 1917, p. 173, note; Ritchie, 1917, p. 94, note; Gibson, 1919, p. 276, list; Dash, 1920, p. 31, note; Fracker and Bruner, 1924, p. 170, list; Hawaiian Sugar Planters' Association, 1924, p. 23, note; Gowdey, 1925, p. 19, note; Gowdey, 1927, p. 16-17, note; Martorell, 1939, p. 189, list.

*Zelus bilobus*, Stål, 1862, p. 449, list (as variety of *Z. longipes*); Champion, 1898, p. 253, note; Van Duzee, 1909, p. 176, list; Torre-Bueno and Engelhardt, 1910, p. 150, list; Barber, 1914, p. 505, list; Dozier, 1917, p. 542, note; Dozier, 1920, p. 357, note; Miller, 1929, p. 462, note; Creighton 1936a7 p. 94, note; Creighton, 1936b, p. 382, note; Elliott, 1938, p. 39, key and list; Elkins, 1951, p. 410, list; Sibley, 1951., p. 92, list; Oliver, 1964, p. 316, note; Whitcomb and Bell, 1964, p. 22, list; Davis, 1969, p. 81, fig. and note (sic *Zellus bilobatus*).

*Diplodus mactans*, Walker, 1873, p. 125, cat.

*Zelus mactans*, Fracker and Bruner, 1924, p. 170, list; Bruner, 1926, p. 79, descr.

*Velia agavis* Blasquez, 1870, p. 289, 290, fig. 14, orig. descr.; Champion, 1898, p. 253, syn. (of *Z. rubidus*); Kirkaldy, 1909, p. 32, syn. (as variety of *Z. speciosus*); Fracker, 1913, p. 240, syn. (= *Z. rubidus*).

DIAGNOSIS: The black and red coloration is distinctive of this species. The male can be recognized by the long paramere and the apex of the medial process slightly folded posteriad.

DESCRIPTION: *MALE*: Medium-sized, total length 13.62–17.91 (15.77, Table 4.2); slender. **COLORATION**: Orangish red and brownish black; pattern variable; most of dorsal surface brownish black; orangish red usually on head, part or entire anterior pronotal lobe, lateral margins of posterior pronotal lobe, proximal and distal parts of corium; occasional specimens with nearly completely dark dorsum. Ventral and lateral surfaces usually orangish red; black stripe along anterior margin of abdominal segment, lacking in some specimens, sometimes also whitish exudation next to black stripe and on pleura and lateral surface of pronotum. Scape, pedicel and legs with or without bands. **VESTITURE**: Densely setose. Antecular lobe with short to moderate, erect setae; postocular lobe with short to long, erect setae. Anterior pronotal lobe with short to long, erect setae, confined to setal tracts dorsally. Abdomen with short to moderately long, erect setae. **STRUCTURE: Head**: Cylindrical, L/W = 2.52. Postocular lobe moderately long; in dorsal view anteriorly gradually narrowing, posterior portion constant, slightly narrower. Eye smallish; lateral margin only slightly wider, roughly on line with margin of postocular lobe; margins removed from dorsal and ventral surfaces of head in lateral view. *Labium*: I: II: III = 1: 1.5: 0.3. Basiflagellomere diameter larger than that of pedicel. **Thorax**: Antero-lateral angle rounded, without projection; medial longitudinal sulcus evident throughout, deepening posteriorly. Posterior pronotal lobe with finely rugulose surface; disc distinctly elevated above humeral angle; humeral angle rounded, without projection. Scutellum moderately long; apex blunt, not projected. *Legs*: Slender. *Hemelytron*: Surpassing apex of abdomen by about twice length of abdominal segment

7; quadrate cell large and broad; Cu and M of cubital cell subparallel. **GENITALIA:**  
*Pygophore:* Rounded; mid-lateral fold adjacent to paramere insertion; not expanded laterally in dorsal view. Medial process cylindrical; slender; moderately long; semi-erect; nearly straight; apex in posterior view rounded, slightly folded posteriad. *Paramere:* Cylindrical; long, surpassing medial process; directed posteriad; nearly straight; apical part not enlarged. *Phallus:* Dorsal phallosomal sclerite somewhat squarish; lateral expansion arising close to base; apical portion of phallosomal sclerite not distinctly tapered, slightly convex, laterally angulate; apex truncate, medially emarginate; proximal edge broadly concave. Struts attached to dorsal phallosomal sclerite; apically separate, not connected by bridge; basally separate throughout. Basal plate arm moderately robust; separate; diverging; in lateral view very slightly curved; bridge long; extension of basal plate small, marginally expanded onto arm.

*FEMALE:* Similar to male, except for the following. Larger than male, total length 15.19–18.36 (mean 17.39, Table 4.2).

**DISTRIBUTION:** Southern USA, much of Mexico, Central America, Northern South America, Southern South America and the Caribbean.

***Zelus means* Fabricius, 1803** Figs 4.5, 4.31.

**LECTOTYPE:** The female lectotype is deposited at the ZMUC and bears the following label: Type / *Z. means* in Am. mer. Schmidt. (**new designation**)

*Zelus means* Fabricius, 1803, p. 282. orig. descr.; Stål, 1868, p. 107, descr.; Stål, 1872, p. 89, cat.; Lethierry and Severin, 1896, p. 162., cat.; Champion, 1898, p. 254, note; Wygodzinsky, 1949a, p. 49, checklist.

*Eccagoras trimaculicollis*- Stål 1855, p. 189, orig. descr. (**syn. nov.**).

*Zelus trimaculicollis* Stål, 1866, p. 298, descr.; Stål, 1872, p. 89, cat.; Lethierry and Severin, 1896, p. 153, cat.; Champion, 1898, p. 254, note; Wygodzinsky, 1949a, p. 50, checklist.

*Zelus trimaculatus* Champion, 1898, p. 254, orig. descr. (**syn. nov.**); Wygodzinsky, 1949a, p. 50, checklist.

Identifications not verified:

*Zelus means*, Walker, 1873, p. 134, cat.

*Euagoras trimaculicollis*, Walker, 1873, p. 118, cat.

**DIAGNOSIS:** The posterior pronotal lobe usually with the medial area brown and lateral areas reddish is diagnostic to this species. This is a pattern not found in the female of other species of the *vagans* group.

**DESCRIPTION:** *MALE:* Large, total length 16.94–19.31 (mean 18.29, Table 4.2); slender. **COLORATION:** Reddish, orangish, mixed with black; pattern variable.

**VESTITURE:** Densely setose. Head with short recumbent setae and some scattered longer setae. Anterior pronotal lobe with erect spine-like setae, short to moderate in length; posterior pronotal lobe with short, erect, spine-like setae. Abdomen with short, recumbent and short to moderately long, erect setae. **STRUCTURE: Head:** Stout. Postocular lobe long; in dorsal view anteriorly gradually narrowing, posterior portion constant, slightly narrower. Eye smallish; lateral margin only slightly wider, roughly on line with margin of postocular lobe; margins removed from dorsal and ventral surfaces of head in lateral view. *Labium:* I: II: III = 1: 1.5: 0.4. Basiflagellomere diameter larger than that of pedicel. **Thorax:** Antero-lateral angle rounded, without projection; medial longitudinal sulcus evident throughout, deepening posteriorly. Posterior pronotal lobe with rugulose surface; disc distinctly elevated above humeral angle; humeral angle

rounded, without projection. Scutellum moderately long; apex blunt, not projected. *Legs*: Moderately robust. *Hemelytron*: Surpassing apex of abdomen by about twice length of abdominal segment 7; quadrate cell large and broad; Cu and M of cubital cell subparallel.

DISTRIBUTION: Southern Central America, South America.

***Zelus fuliginatus* sp. nov.** Figs 4.4, 4.15, 4.31.

HOLOTYPE: **COLOMBIA: Quindio**: Salento, 4.6375°N 75.57028°W, 1895 m, 14 Jul 1939, Richter, 1;m (UCR\_ENT 00007997) (USNM).

DIAGNOSIS: The unique coloration pattern: entire surface of body (except for abdomen) black, abdomen yellowish; the presence of long, spine-like setae on head, lateral surface of anterior pronotal lobe, pleura and scutellum (only short setae in other species); the rather short postocular lobe; the Sc not reaching apex of cubital cell. The male can be separated from other species of the *vagans* group by the medial process apically tapered, somewhat pointed.

DESCRIPTION: *MALE*: Medium-sized, total length 12.08–13.76 (mean 12.92, Table 4.2); slender. **COLORATION**: Entire surface of body, including antenna, labium and legs, black, except for yellowish abdominal segments 2–7 and very slender, medial longitudinal stripe on postocular lobe. **VESTITURE**: Densely setose. Antecular with dense, short, spine-like setae, intermixed with short, recumbent, fine setae; dorsum of postocular with moderately dense, short to long, spine-like setae; ventral surface of head with sparse, long setae, varying from fine to spine-like, also with recumbent setae. Pronotum with dense, short, spine-like setae over entire surface; lateral surface of anterior pronotal lobe and pleura with both short and long, spine-like setae.; scutellum

with dense, short to long, spine-like setae. Legs with sparse setation. Corium and clavus with dense, recumbent, stout setae. Abdomen with moderately dense, short to long, semi-erect setae. **STRUCTURE: Head:** Cylindrical, L/W = 1.96. Postocular lobe short; in dorsal view anteriorly gradually narrowing, posterior portion constant, slightly narrower. Eye moderately sized; lateral margin only slightly wider, roughly on line with margin of postocular lobe; margins removed from dorsal and ventral surfaces of head in lateral view. *Labium:* I: II: III = 1: 1.5: 0.4. Basiflagellomere diameter larger than that of pedicel. **Thorax:** Antero-lateral angle rounded, without projection; medial longitudinal sulcus evident throughout, deepening posteriorly. Disc distinctly elevated above humeral angle; humeral angle rounded, without projection. Scutellum long; apex angulate, not projected. *Legs:* Moderately robust. *Hemelytron:* Greatly surpassing apex of abdomen by about 3x length of abdominal segment 7; quadrate cell large and broad; Cu and M of cubital cell subparallel. **GENITALIA: Pygophore:** Elongate ovoid; mid-lateral fold adjacent to paramere insertion; slightly expanded laterally near base of paramere in dorsal view. Medial process somewhat cone-shaped; tapering to apex; long; posteriorly directed; basally slightly curved; apex in posterior view blunt. *Paramere:* Cylindrical, apically compressed; moderately long, nearly reaching apex of medial process; directed posteriad; basally constricted; not distinctly curved; apical part enlarged. *Phallus:* Dorsal phallothecal sclerite elongated; apical 1/3 of phallothecal sclerite tapering to apex, strongly convex, laterally rounded, not forming angle; apex with small medial emargination; proximal edge broadly concave. Struts attached to dorsal phallothecal sclerite; apically separate, connected by bridge. Basal plate arm moderately robust; separate; subparallel; in lateral view very slightly curved; bridge short; extension of basal plate expanded onto arm.

*FEMALE*: Similar to male, except for the following. Larger than male, total length 17.68–18.13 (mean 17.91, Table 4.2).

ETYMOLOGY: The species epithet means 'soot' or painted black, referring to the black dorsal coloration of this species.

DISTRIBUTION: Northern South America.

***Zelus gracilipes* sp. nov.** Figs 4.5, 4.14, 4.31.

HOLOTYPE: **BOLIVIA: La Paz**: Tumupasa, 14.15°S 67.9167°W, Dec 1921–22, Mulford Bio. Expl, 1;m (UCR\_ENT 00007998) (USNM).

DIAGNOSIS: The posterior pronotal lobe orangish brown; the legs entirely dark, without bands. The male can be recognized the nearly straight medial process; the apex the paramere somewhat truncate; and the basal arm of the dorsal phallosomal sclerite with dorsal elevation.

DESCRIPTION: *MALE*: Large, total length 15.43–16.74 (mean 16.09, Table 4.2); slender. **COLORATION**: Head, anterior pronotal lobe, hemelytron, and legs dark brown to brownish black; very inconspicuous light colored, rather thin, medial longitudinal stripe on postocular lobe. Ventral surface of head yellowish in some specimens. Ventral surface of abdomen in some specimens reddish brown. Posterior pronotal lobe and mesopleuron orange or reddish brown. Setae on corium golden. Abdominal segments 2–5 reddish brown in some specimens. Variation minimal between specimens.

**VESTITURE**: Densely setose. Dorsum of antecolular and anterior part of postocular with moderately dense, short, erect, spine-like setae; rest with sparse, short, erect or recumbent setae; posterior part of postocular nearly glabrous. Pronotum with dense, short, erect, spine-like setae on dorsal and lateral surfaces. Pleura with mixed spine-like

and fine setae; scutellum with dense, short to long, semi-erect to decumbent setae. Legs with sparse setae; sundew setae on profemur sparse and randomly arranged. Corium and clavus with dense, recumbent, stout setae. Abdomen with moderately dense, short, semi-erect, fine setae. Apically with moderately long, erect setae. **STRUCTURE: Head:** Cylindrical, L/W = 2.28. Postocular lobe in dorsal view anteriorly gradually narrowing, posterior portion constant, slightly narrower. Eye prominent; lateral margin much wider than postocular lobe; dorsal margin removed from postocular transverse groove, ventral margins attaining ventral surface of head in lateral view. *Labium:* I: II: III = 1: 1.5: 0.4. Basiflagellomere diameter slightly larger than that of pedicel. **Thorax:** Antero-lateral angle rounded, without projection; medial longitudinal sulcus evident throughout, deepening posteriorly. Disc distinctly elevated above humeral angle; humeral angle rounded, without projection. Scutellum moderately long; apex angulate, not projected. *Legs:* Very slender. *Hemelytron:* Greatly surpassing apex of abdomen by about 3x length of abdominal segment 7; quadrate cell large and broad; Cu and M of cubital cell subparallel. **GENITALIA: Pygophore:** Ovoid; mid-lateral fold adjacent to paramere insertion; slightly expanded laterally near base of paramere in dorsal view. Medial process somewhat cone-shaped; moderately long; posteriorly directed, in less than 45-degree with body axis; nearly straight; apex in posterior view blunt. *Paramere:* Cylindrical; long, nearly reaching apex of medial process; directed toward medial process; curved ventrad, extremity slightly recurved; apical part not enlarged. *Phallus:* Dorsal phallothecal sclerite elongated; apical 1/3 of phallothecal sclerite tapering to apex, strong convex, laterally rounded, not forming angle; apex with small medial emargination; proximal edge broadly concave. Struts attached to dorsal phallothecal sclerite; apically separate, connected by bridge; basally fused in part. Basal plate arm



slender; separate; subparallel; in lateral view very slightly curved; bridge moderately long; extension of basal plate small and confined to apex of basal plate arm.

*FEMALE*: Similar to male, except for the following. Larger than male, total length 19.62–20.74 (mean 20.06, Table 4.2). Posterior lobe reddish brown.

ETYMOLOGY: From Latin *gracilis*, meaning slender.

DISTRIBUTION: South America.

PARATYPES: **BOLIVIA: Cochabamba**: Chapare, 16.5°S 65.5°W, Zischka, 1;f (UCR\_ENT 00071194) (TAMU). Rio Negro, Jan, W. M. Mann, 1;m (UCR\_ENT 00009296) (USNM). **BRAZIL: Goiás**: Campinas, 16.66785°S 49.29149°W, 1934, T. Borgmeier, 1;f (UCR\_ENT 00009297) (USNM). **Rondonia**: 62 km S Ariquemes, Fazenda Rancho Grande, 10.3°S 62.86666°W, 300 m, 03 Jul 1996 – 15 Jul 1996, J. E. Eger, 1;f (UCR\_ENT 00009450) (USNM); 04–16 Nov 1997, J. E. Eger, 1;m (UCR\_ENT 00009499) (USNM). 62 km SW of Ariquemes, near Fzda. Rancho Grande, 10.32921°S 63.46881°W, 04 – 16 Nov 1997, J. E. Eger, 2;m (UCR\_ENT 00026166–67) (USNM). **ECUADOR: Napo**: Puerto Misahuali, 1.0345°S 77.66366°W, 541 m, 06 – 19 Sep 1998, J. E. Eger, 2;m (UCR\_ENT 00009449, UCR\_ENT 00009492) (USNM).

***Zelus vagans* Fabricius, 1803** Figs 4.5, 4.15, 4.31.

HOLOTYPE: Habitat in America meridionali, No date provided, Dom. Smidt, 1;m (UCR\_ENT 00075107) (ZMUC).

*Zelus vagans* Fabricius, 1803, p. 284, orig. descr.; Stål, 1868, p. 108, descr. and note;

Stål, 1872, p. 88, cat .; Lethierry and Severin, 1896, p. 153, cat.; Wygodzinsky,

1949a, p. 50, checklist.

Identifications not verified:

*Zelus vagans*, Walker, 1873, p. 134, cat.

**DIAGNOSIS:** The male can be easily identified by the unique coloration pattern that the posterior pronotal lobe medially dark and laterally orange. Distinguished among members of the *vagans* species group by the smaller size; the postocular lobe covered with recumbent setae. Paramere is similar to that in *gracilipes* in showing ventrally directed curvature, but it is shorter than in *gracilipes* and reaching to only about mid-point of medial process.

**DESCRIPTION:** *MALE:* Medium-sized, total length 11.29–14.71 (mean 13.71, Table 4.2); slender. **COLORATION:** Entire surface of head, antenna and labium dark brown; extremely slender medial longitudinal lighter stripe on postocular lobe. Anterior pronotal lobe dark brown. Medial longitudinal dark brown stripe on posterior pronotal lobe; rest of dorsal surface orange; lateral surface dark brown or orange. Scutellar disc dark brown, margins orange or brown. Sternites dark brown. Corium dark proximally dark brown, distally orange, proportions of brown and orange vary slightly among specimens, sometimes with rather small dark brown patch at very distal. Clavus orange. Membrane dark brown; veins same color as rest. Legs dark brown; profemur with or without band; meso- and metafemora each with two orange bands, apical band usually smaller. Abdominal segments 2–6 reddish, amount on segment 6 varies; segment 7 and pygophore dark brown. **VESTITURE:** Densely setose. Dorsum with short, erect, spine-like setae, dense on anteocular lobe, sparse on postocular lobe; dense, short, recumbent setae over entire dorsal surface of postocular lobe; ventral surface also with sparse, short to moderately long, erect, fine setae. Pronotum primarily with dense, short, erect, spine-like setae on dorsal and lateral surfaces; spine-like setae on pleura sparse, mainly with longer, erect, fine setae and short, recumbent setae.; scutellum with dense,

short to long, semi-erect to decumbent setae; spine-like setae sparse. Legs with sparse setae; sundew setae on profemur sparse and randomly arranged. Corium and clavus with dense, recumbent, stout setae. Abdomen with moderately dense, short, semi-erect, fine setae, interspersed with sparse, longer, erect setae; segment 7 in some specimens with setae covered with white wax-like exudation. Pygophore with short to long, semi-erect setae.; dense, moderately long, semi-erect setae nearly throughout dorsal, inner surface of paramere. **STRUCTURE: Head:** Cylindrical, L/W = 2.34. Postocular lobe in dorsal view anteriorly gradually narrowing, posterior portion constant, slightly narrower. Eye moderately sized; lateral margin only slightly wider, roughly on line with margin of postocular lobe; dorsal margin removed from postocular transverse groove, ventral margins attaining ventral surface of head in lateral view. *Labium:* I: II: III = 1: 1.5: 0.4. Basiflagellomere diameter slightly larger than that of pedicel. **Thorax:** Antero-lateral angle rounded, without projection; medial longitudinal sulcus evident throughout, deepening posteriorly. Disc distinctly elevated above humeral angle; humeral angle rounded, without projection. Scutellum moderately long; apex pointed, sometimes as short process, not projected. *Legs:* Very slender. *Hemelytron:* Greatly surpassing apex of abdomen by about 3x length of abdominal segment 7; quadrate cell large and broad; Cu and M of cubital cell subparallel. **GENITALIA:** *Pygophore:* Ovoid; mid-lateral fold adjacent to paramere insertion; not expanded laterally in dorsal view. Medial process somewhat cone-shaped; moderately long; posteriorly directed, in less than 45-degree with body axis; nearly straight; apex in posterior view blunt. *Paramere:* Cylindrical; moderately long, reaching about mid-point of medial process; directed posteriad, slightly curved towards medial process; slightly curved ventrad; apical part not enlarged. *Phallus:* Dorsal phalloshecal sclerite elongated; medial portion with dorsal paired hump;

apical portion of phallothecal sclerite gradually tapering, carinate medially, laterally angulate; apex with small medial emargination; proximal edge broadly concave. Struts attached to dorsal phallothecal sclerite; apically separate, connected by bridge; basally mostly separate, moderately fused. Basal plate arm slender; separate; subparallel; in lateral view nearly straight, very slightly curved; bridge moderately long; extension of basal plate small, marginally expanded onto arm.

*FEMALE*: Unknown.

*DISTRIBUTION*: South America. Widely spread.

***Zelus vespiformis* Hart, 1987** Figs 4.5, 4.14, 4.32.

*HOLOTYPE*: **PANAMA: Canal Zone**: Barro Colorado Island, Drayton Trail, 11 Nov 1930, H. F. Schwarz, 1;m (UCR\_ENT 00057794) (AMNH).

*Zelus vespiformis* Hart, 1987, p. 301, orig. descr., fig. and key.

*DIAGNOSIS*: The generally wasp-like coloration pattern can separate this species from most other species of the *Zelus*. The male can be recognized by the rather slender and short medial process, it being much shorter than that in *Z. errans*, the only species that may cause confusion.

*DESCRIPTION*: *MALE*: Medium-sized, total length 11.52–13.73 (mean 12.92, Table 4.2); very slender. **COLORATION**: Color pattern wasp-like, yellow and brown areas alternating. Head and anterior pronotal lobe dark brown to brownish black. Posterior pronotal lobe yellow to brownish orange; meso-pleuron yellow to brownish orange, posterior part sometimes dark brown; meta-pleuron dark brown. Legs yellow, with brown bands. Abdomen yellow to orangish brown, terminal segments (7, 8 and pygophore) dark brown to black. **VESTITURE**: Densely setose. Dorsal vestiture primarily consisting

of short, erect, spine-like setae; head ventrally with sparse, fine, short, erect or decumbent setae. Abdominal venter with short to long, fine erect setae. Sparse, short, erect setae on apex of paramere and postero-ventral rim of pygophore. Head dorsally with short, dense, spine-like setae; ventral setae recumbent. Scutellum with short, dense, recumbent to semierect setae, sometimes with spine-like setae. Abdomen with short, adpressed setae interspersed with unevenly lengthed, short to long, semierect or erect setae. Pygophore with sparse setae. **STRUCTURE: Head:** Cylindrical. Postocular lobe in dorsal view distinctly narrowing through anterior 2/3, posterior 1/3 constant, tube-like. Eye moderately sized; dorsal margin removed from postocular transverse groove, ventral margins attaining ventral surface of head in lateral view. *Labium:* I: II: III = 1: 2.4: 0.6. Basiflagellomere diameter larger than that of pedicel. **Thorax:** Antero-lateral angle rounded, without projection; medial longitudinal sulcus shallow near collar, deepening posteriorly. Posterior pronotal lobe with smooth surface; disc distinctly elevated above humeral angle; humeral angle rounded, without projection. Scutellum long; apex angulate, not projected. *Legs:* Very slender. *Hemelytron:* Greatly surpassing apex of abdomen by about 3x length of abdominal segment 7; quadrate cell large and broad; Cu and M of cubital cell subparallel. **GENITALIA: Pygophore:** Ovoid; mid-lateral fold adjacent to paramere insertion. Medial process cylindrical; very slender; short, about third length of exposed portion of parameres; posteriorly directed, in less than 45-degree with body axis; nearly straight; basally without protrusion; apex in posterior view blunt. *Paramere:* Cylindrical; moderately long, achieving apex of medial process; directed posteriad; slightly curved ventrad; apical part very slightly enlarged. *Phallus:* Dorsal phallosomal sclerite somewhat squarish; flat, laterally indistinctly angulate; apex truncate, medially emarginate; proximal edge deeply concave. Struts attached to dorsal

phallothecal sclerite; apically separate, connected by bridge; basally mostly separate, moderately fused. Basal plate arm moderately robust; separate; converging; in lateral view nearly straight, very slightly curved; bridge short; extension of basal plate expanded onto arm.

*FEMALE*: Similar to male, except for the following. Larger than male, total length 16.48–18.29 (mean 17.47, Table 4.2). Some specimens almost entirely dark brown, only with medial part of or entire posterior pronotal lobe, mesopleuron and mesosternum brownish orange or orange.

*DISTRIBUTION*: Southern South America, northern South America.

*PARATYPES*: **COLOMBIA: Meta**: Rio Guayeriba, a tributary of Rio Meta, 24 Jan 1948, Richter, 1;m (UCR\_ENT 00017877), 1;f (UCR\_ENT 00017879) (AMNH). **Valle del Cauca**: Cali District, 994 m, 07 Feb 1935, Severo Quintero, 1;m (UCR\_ENT 00017878), 1;f (UCR\_ENT 00017882) (AMNH).

***Zelus banksi* sp. nov.** Figs 4.6, 4.16, 4.34.

*HOLOTYPE*: **PANAMA: Canal Zone**: Barro Colodrado, 9.16666°N 79.83333°W, 25 Jun 1924, N. Banks, 1;m (UCR\_ENT 00057804) (AMNH).

*DIAGNOSIS*: The posterior pronotal lobe usually orangish brown; the rather long paramere, apex obliquely truncate; and the medial process nearly straight, curvature small.

*DESCRIPTION*: *MALE*: Medium-sized, total length 10.81–12.62 (mean 12.00, Table 4.2); slender. **COLORATION**: Head uniformly brown; postocular lobe with very faint longitudinal medial stripe. Anterior pronotal lobe and hemelytron brown; posterior lobe yellowish brown. Remainder of body surface mostly yellowish brown, parts of pleura

darker. Femora with two or three yellowish bands; tibiae with single band. **VESTITURE:** Sparsely setose. Short, recumbent setae on entire surface; very short, erect, spine-like setae on dorsum, denser on anterior lobe; few moderately long, erect, fine setae on ventral surface. Pronotum with sparse, recumbent setae and short, erect setae over dorsal surface; denser, long recumbent setae on lateral surface and pleura, intermixed with semierect or erect setae.; scutellum with sparse, semi-erect and recumbent setae. Legs with sparse setation on femora and moderately dense setation on tibiae. Corium and clavus with mix of sparse, short, recumbent and erect setae. Abdomen with moderately dense, short recumbent setae, intermixed with sparse, short to long, erect setae. Apical half of dorsal surface of paramere with moderately dense, medium-length, semi-erect setae. **STRUCTURE: Head:** Cylindrical, L/W = 2.25. Postocular lobe long; in dorsal view distinctly narrowing through anterior 2/3, posterior 1/3 constant, tube-like. Eye prominent; lateral margin much wider than postocular lobe; dorsal margin attaining postocular transverse groove, ventral margin removed from ventral surface of head in lateral view. *Labium:* I: II: III = 1: 2.1: 0.5. Basiflagellomere diameter larger than that of pedicel. **Thorax:** Antero-lateral angle bearing small projection; medial longitudinal sulcus evident throughout, deepening posteriorly. Posterior pronotal lobe with rugulose surface; disc distinctly elevated above humeral angle; humeral angle armed, with dentate or spinous process. Scutellum short; apex angulate, slightly projected upward in some specimens. *Legs:* Slender. *Hemelytron:* Slightly surpassing apex of abdomen, not more than length of abdominal segment 7; quadrate cell small; Cu and M of cubital cell subparallel. **GENITALIA: Pygophore:** Elongate ovoid; not expanded laterally in dorsal view. Medial process cylindrical; slender; moderately long, nearly as long as paramere; laterally compressed towards apex; anterior surface towards apex ridged; minute

spicules on posterior surface; semi-erect; very slightly curved at middle; apex in posterior view acute, with small hook-like projection. *Paramere*: Cylindrical; long, achieving apex of medial process; directed posteriad, slightly curved towards medial process; basally slightly narrower; nearly straight; apical part slightly enlarged, obliquely truncate.

*Phallus*: Dorsal phallothecal sclerite somewhat ovoid; sclerotization reduced (yet not absent) on dorsal surface close to proximal edge; apical portion of phallothecal sclerite gradually tapering, distinctly keeled medially, laterally indistinctly angulate; apex acute; proximal edge broadly concave. Struts attached to dorsal phallothecal sclerite; apically separate, connected by bridge; basally separate throughout. Basal plate arm robust; basally fused; in lateral view mid-portion curved; bridge extremely short; extension of basal plate expanded laterally onto arm, covering more than 1/2 of arm, curved.

*FEMALE*: Unknown.

ETYMOLOGY: Named after N. Banks, the collector of the type specimen.

DISTRIBUTION: Central America, South America. Panama, Costa Rica, Colombia.

PARATYPES: **COLOMBIA: Meta**: Rio Guayuriba, 4.01978°N 73.60807°W, 400 m, 06 Sep 1947, Richter, 1;m (UCR\_ENT 00071253) (TAMU). **Valle del Cauca**: Palmira, 3.5364°N 76.3036°W, 25 Aug 1939, F. J. Otoyá, 1;m (UCR\_ENT 00009559) (USNM). **COSTA RICA: Alajuela**: Higuito, San Mateo, 9.95°N 84.55°W, 254 m, 01 Jan 1700, Pablo Schild, 1;m (UCR\_ENT 00029366) (USNM). **COSTA RICA: Puntarenas**: Rancho Quemado, Pen. de Osa, 8.6791°N 83.56671°W, 200 m, Nov 1991, F. Quesada, 1;m (UCR\_ENT 00014431) (INBIO).



***Zelus chamaeleon* Stål, 1872** Figs 4.6, 4.16, 4.34.

LECTOTYPE: **COLOMBIA: Cundinamarca:** Bogota, No date provided, Lindig, 1;m  
(UCR\_ENT 00041001) (NHRS) (**new designation**)

*Zelus chamaeleon* Stål, 1872, p. 90–91 [orig. descr. and cat. (subgenus *Diplodus*)];

Lethierry and Severin, 1896, p. 151 [cat.]; Champion, 1898, p. 260 [note];

Wygodzinsky, 1949a, p. 48–49 [checklist].

DIAGNOSIS: The long, erect, fine setae on head, anterior pronotal lobe, pleura and sternites; the stout and short head and the nearly hemispherical postocular lobe; and. The short paramere, not exceeding medial process; the medial process short and triangular, apex as hook-like process, extending ventrally as transverse ridge; the apical surface of dorsal phallothecal sclerite medially with keel-like elevation. The femal with red color on parts of body.

DESCRIPTION: *MALE*: Medium-sized, total length 12.50–14.06 (mean 13.45, Table); robust. **COLORATION**: Usually entire surface of body black, some specimen with white posterior margin of posterior pronotal lobe, some with posterior pronotal lobe uniformly orangish brown. Scape with or without band. Profemur with single pale brown band, protibia without band; meso- and metafemora with two or three bands, tibiae with single band. **VESTITURE**: Sparsely setose. Dorsum of head with dense, short, stout, recumbent, black setae and sparse, long, fine, erect setae, as long as width of eye in dorsal view; ventral surface with moderately dense, short, recumbent, fine setae and spare, moderately long, erect setae. Moderately dense, short, stout, recumbent setae on pronotum; anterior lobe also with sparse, long, erect setae; scutelum with dense, short to long, semi-erect setae; pleura with short to long, semi-erect or erect setae; sternites with dense, long, erect setae. Corium and clavus with short, recumbent setae. Abdomen with

moderately dense, short, recumbent to sub-adpressed setae, intermixed with long, erect setae. With dense, short, adpressed setae, mixed with sparse, very long, moderately stout, semi-erect setae.; apical half with dense, moderately long, stout, semi-erect setae.

**STRUCTURE: Head:** Somewhat globular, L/W = 1.93. Postocular lobe short; in dorsal view narrowing till abrupt posterior constriction, very short behind constriction. Eye moderately sized; lateral margin much wider than postocular lobe; margins removed from dorsal and ventral surfaces of head in lateral view. *Labium:* I: II: III = 1: 1.6: 0.4. Basiflagellomere diameter slightly larger than that of pedicel. **Thorax:** Antero-lateral angle with inconspicuous subtuberculate projection; medial longitudinal sulcus evident only on posterior 1/2, deepening anterior to transverse sulcus of pronotum. Posterior pronotal lobe with rugulose surface; disc distinctly elevated above humeral angle; humeral angle armed, with spinous processes. Scutellum moderately long; apex angulate, slightly projected upward in some specimens. *Legs:* Slender. *Hemelytron:* Surpassing apex of abdomen by about twice length of abdominal segment 7; quadrate cell moderately large; Cu and M of cubital cell converging towards R. **GENITALIA:** *Pygophore:* Ovoid; mid-lateral fold adjacent to paramere insertion; expanded laterally near base of paramere in dorsal view. Medial process triangular; slender; short, shorter than paramere; erect; straight; apex in posterior view acute, with hook-like projection extending towards downward, ending as transverse bridge. *Paramere:* Cylindrical; short, not reaching apex of medial process; directed posteriad, slightly curved towards medial process; basally narrower; slightly curved ventrad; apical part enlarged. *Phallus:* Dorsal phallothecal sclerite shield-shaped; lateral ridge-like dorsad expansion continuous with basal arm; apical portion of phallothecal sclerite gradually tapering, convex, medially keeled; apex truncate; proximal edge deeply concave. Struts attached to dorsal

phallosheath sclerite; apically separate, connected by bridge; basally separate. Basal plate arm robust; separate; converging; in lateral view slightly curved; bridge short; extension of basal plate expanded onto arm.

*FEMALE*: Similar to male, except for the following. Larger than male, total length 13.45–15.02 (mean 14.39, Table 4.2). More variable than in male. Dorsum of postocular lobe always black; pale, slender, medial longitudinal stripe; anteocular lobe usually black, if with part of surface red, clypeus always black. Dorsum of anterior pronotal lobe almost always black, collar sometimes red, lateral surface black or mixed with red. Dorsal surface of posterior pronotal lobe of four major color patterns: entirely black, entirely red or orange, anterior portion red and posteriorly black, mostly black with medial red circular patch; last pattern most common (8 out of 14); lateral surface always red or orange (when dorsal surface is orange). Variable amounts of black and red on pleura. Corium and clavus brownish black or yellowish brown; membrane always dark brown. Abdomen segment usually red, anterior black stripe; entirely black in some specimens. Hemelytron slightly surpassing apex of abdomen.

**DISTRIBUTION**: South America. Known only from Colombia.

**PARALECTOTYPES**: **COLOMBIA: Cundinamarca**: Bogota, No date provided, Lindig, 3;u (UCR\_ENT 00041002, UCR\_ENT 00041003, UCR\_ENT 00041013) (NHRS)

### **New Designation.**

**DISCUSSION**: There is considerable amount of color variation in this species and more so in the female. Stål recognized delimited 7 color varieties to account for the major combinations of color forms. There appears to be no more variation between geographic areas than within each area, so there is no reason to continue the usage of these varietal names in the literature.

***Zelus cordazulus* sp. nov.** Figs 4.16, 4.34.

HOLOTYPE: **COLOMBIA: Antioquia:** Divisoria, Cordillera, 1300 m, May 1947, Unknown, 1;m (UCR\_ENT 00046973) (AMNH).

DIAGNOSIS: The nearly uniform brown dorsal coloration; the dorsum with short, erect, somewhat spine-like setae; and the posterior margin of the pronotum smoothly convex. The paramere short, broad; the apical part of medial process laterally compressed and ridged on the anterior surface; the postero-lateral rim of pygophore with lightly sclerotized expansion below paramere; and the basal plate arms separate, not fused. In female the dorsum nearly uniformly brown; the lateral and ventral surfaces yellowish; and the abdominal segment with single dark spot.

DESCRIPTION: *MALE*: Medium-sized, total length 14.80–15.07 (mean 14.94, Table 4.2); slender. **COLORATION**: Head dark brown; yellowish patch between eye and ocellus; yellow, medial, longitudinal stripe on postocular lobe; ventral surface pale brown, lighter than dorsum. Pronotum and scutellum dark brown. Inconspicuous bands on legs. **VESTITURE**: Sparsely setose. Dorsum with moderately dense, short, recumbent setae and sparse, short, erect, somewhat spine-like setae; ventral surface with moderately dense, short, recumbent setae and few moderately long, erect, fine setae. Pronotum with very sparse, short, erect setae over dorsal surface, some setae curved apically, appearing recumbent; moderately dense, short to moderately long, recumbent setae on lateral surface and pleura, intermixed with semi-erect or erect setae; scutellum with sparse, semi-erect and recumbent setae. Legs with sparse setation on femora and moderately dense setation on tibiae. Corium and clavus with short, recumbent setae. Abdomen with moderately dense, short recumbent setae, intermixed with sparse, short to long, erect setae. **STRUCTURE: Head**: Cylindrical, L/W = 2.23.

Postocular lobe long; in dorsal view distinctly narrowing through anterior 2/3, posterior 1/3 constant, tube-like. Eye prominent; lateral margin much wider than postocular lobe; dorsal margin attaining postocular transverse groove, ventral margin removed from ventral surface of head in lateral view. *Labium*: I: II: III = 1: 1.8: 0.3. Basiflagellomere diameter larger than that of pedicel. **Thorax**: Antero-lateral angle with inconspicuous subtuberculate projection; medial longitudinal sulcus evident throughout, deepening posteriorly. Posterior pronotal lobe with rugulose surface; disc distinctly elevated above humeral angle; humeral angle armed, with spinous processes. Scutellum moderately long; apex angulate, not projected. *Legs*: Slender. *Hemelytron*: Surpassing apex of abdomen by about length of abdominal segment 7; quadrate cell small and slender; Cu and M of cubital cell subparallel. **GENITALIA**: *Pygophore*: Elongate ovoid; lightly sclerotized expansion below paramere; not expanded laterally in dorsal view. Medial process cylindrical; slender; long, much longer than paramere; laterally compressed towards apex; anterior surface towards apex ridged; minute spicules on posterior surface; semi-erect; curved at middle; apex in posterior view acute, with small hook-like projection. *Paramere*: Cylindrical; short, not reaching medial process; directed posteriad; basally narrower; slightly curved ventrad; apical part very slightly enlarged. *Phallus*: Dorsal phallothecal sclerite shield-shaped; sclerotization reduced (yet not absent) on dorsal surface close to proximal edge; expansion of lateral margin at about mid-portion pronounced, covering lateral side of endosoma; apical portion of phallothecal sclerite gradually tapering, distinctly keeled medially, laterally flat, not forming angle; apex truncate; proximal edge broadly concave. Struts attached to dorsal phallothecal sclerite; apically separate, connected by bridge; basally separate. Basal plate arm moderately

robust; separate; converging; in lateral view slightly curved; bridge short; extension of basal plate expanded laterally onto arm, covering more than 1/2 of arm, curved.

*FEMALE*: Similar to male, except for the following. Larger than male, total length 15.56–18.20 (mean 16.82, Table 4.2). Dorsum nearly uniformly brown, lateral and ventral surfaces yellowish; single dark spot on each abdominal segment.

ETYMOLOGY: Named after the type locality "Cordillera" in Peru.

DISTRIBUTION: South America. Colombia, Peru.

PARATYPES: **PERU: Cusco**: S. Amer, Santa Isabel, Valley of River Ccosnipata, 13°S 71.3°W, 02 Jan 1952, F. Woytkowski, Paratype, 1;f (UCR\_ENT 00029354) (USNM). **Huanuco**: Divisoria, Cordillera Azul, 1300 m, May 1947, Ranile, Paratype, 1;f (UCR\_ENT 00026168), 1;m (UCR\_ENT 00009529) (USNM). **Ica**: Chanchamayo, 13.7°S 75.8°W, 1700, Unknown, 1;m (UCR\_ENT 00023701) (RMNH). **Loreto**: Divisoria, 1500 m, 1942, Weyrauch, 1;f (UCR\_ENT 00071256) (TAMU). **San Martin**: 15 kms SE of Moyobamba, 6.09796°S 76.8605°W, 890 m, 10 Aug 1947, F. Woytkowski, Paratype, 1;f (UCR\_ENT 00029355) (USNM).

DISCUSSION: This is one of the largest species in the *panamensis* group. Sexual dimorphism is not as pronounced as in other species of the same group and is limited to size difference. The female of *Z. cordazulus* is most similar to the females of *Z. gilboventris* and *Z. truxali*. The veins of the quadrate cell and proimal margin of the postcubital cell are not yellowish, distinguishing it from *Z. gilboventris*. The anterior pronotal lobe is brown and not yellowish, separating it from *Z. truxali*. Also, each abdominal segment has a dark spot, which is lacking in both *Z. gilboventris* and *Z. truxali*.

***Zelus filicauda* Bergroth, 1893** Figs 4.15, 4.34.

HOLOTYPE: **ECUADOR: Tungurahua:** 13 mi W. Mera, Napo-Pastaza, 1.4628°S 78.28538°W, 12 Feb 1955, E. I. Schlinger & E. S. Ross, 1;m (UCR\_ENT 00019043) (CAS).

*Zelus filicauda* Bergroth, 1893, p. 63, orig. descr.; Lethierry and Severin, 1896, p. 152, cat.; Wygodzinsky, 1949a, p. 49, checklist.

DIAGNOSIS: Recognized by the entire body dark brown, the posterior pronotal lobe slightly lighter and somewhat reddish, the legs without bands; the humeral angles projected into spinous process. Distinguished among species of the *panamensis* group by the strongly curved medial process.

DESCRIPTION: **MALE:** Medium-sized, total length 12.71 (n=1, Table 4.2); slender.

**COLORATION:** Nearly uniformly dark brown. Head dark brown; yellowish patch between eye and ocellus; inconspicuous, slender, medial yellow area on postocular lobe; ventral surface very slightly lighter than dorsal. Anterior pronotal lobe dark brown; posterior lobe slightly lighter than anterior lobe, somewhat reddish brown; remainder of body surface and legs dark reddish brown. **VESTITURE:** Sparsely setose. Head with moderately dense, short, recumbent on entire surface; dorsum also with short, spine-like setae, denser on anteocular lobe; ventral surface also with sparse, long, erect setae. Pronotum dorsal and lateral surfaces, pleura and sternites with short, decumbent setae and short to long, erect setae; recumbent setae dense on lateral surface of pronotum and pleuron; scutellum with sparse setation. Legs with sparse setation on femora and moderately dense setation on tibiae. Corium and clavus with sparse, short, recumbent setae. Abdomen with moderately dense, short recumbent setae, intermixed with sparse, short to long, erect setae. Apical half of dorsal surface of paramere with moderately

dense, medium-length, semi-erect setae. **STRUCTURE: Head:** Cylindrical, L/W = 2.03. Postocular lobe long; in dorsal view distinctly narrowing through anterior 2/3, posterior 1/3 constant, tube-like. Eye prominent; lateral margin much wider than postocular lobe; dorsal margin attaining postocular transverse groove, ventral margin removed from ventral surface of head in lateral view. *Labium:* I: II: III = 1: 1.7: 0.3. **Thorax:** Antero-lateral angle bearing small projection; medial longitudinal sulcus evident throughout, deepening posteriorly. Posterior pronotal lobe with rugulose surface; disc distinctly elevated above humeral angle; humeral angle armed, with spinous processes. Scutellum moderately long; apex angulate, slightly projected upward. *Legs:* Slender. *Hemelytron:* Slightly surpassing apex of abdomen, not more than length of abdominal segment 7; quadrate cell small and slender; Cu and M of cubital cell subparallel. **GENITALIA:** *Pygophore:* Elongate ovoid; lightly sclerotized expansion below paramere; not expanded laterally in dorsal view. Medial process cylindrical; slender; long, longer than paramere; laterally compressed towards apex; anterior surface towards apex ridged; minute spicules on posterior surface; posteriorly directed; curved at middle; apex in posterior view acute, with small hook-like projection. *Paramere:* Cylindrical; moderately long, not reaching medial process; directed posteriad; basally slightly constricted; curved ventrad; apical part very slightly enlarged, apex rounded, somewhat truncate. *Phallus:* Dorsal phallothecal sclerite shield-shaped; expansion of lateral margin at about mid-portion pronounced; apical portion of phallothecal sclerite gradually tapering, distinctly keeled medially, laterally flat, not forming angle; apex acute; proximal edge concave. Struts attached to dorsal phallothecal sclerite; apically separate, connected by bridge; basally separate throughout. Basal plate arm moderately robust; separate; converging; in lateral



view slightly curved; bridge extremely short; extension of basal plate expanded laterally onto arm, covering more than 1/2 of arm, curved.

*FEMALE*: Unknown.

*DISTRIBUTION*: South America. Known from Ecuador.

*DISCUSSION*: Among species of the same group, the medial process is most strongly curved in *Zelus filicauda*, making it easy to diagnose.

***Zelus gilboventris* sp. nov.** Figs 4.6, 4.16, 4.34.

*HOLOTYPE*: **BOLIVIA: Cochabamba**: Villa Tunari, Chapare, 16.91666°S 65.36667°W, 500 m, 09 Jan 1958, Wygodzinsky and Monros, 1;m (UCR\_ENT 00016769) (AMNH).

*DIAGNOSIS*: The posterior pronotal lobe usually orangish brown; the medial process rather long, much longer than paramere; and the anterior side of medial process keeled medially at apex. In female the dorsal surface nearly uniformly brown and the lateral and ventral surfaces yellowish; and the quadrate cell and proximal margin of postcubital cell yellowish.

*DESCRIPTION*: *MALE*: Medium-sized, total length 12.07–13.69 (mean 13.19, Table 4.2); slender. **COLORATION**: Brown. Head brown to dark brown; pale brown patch between eye and ocellus; medial stripe on postocular lobe. Pronotum either entirely dark brown or posterior pronotal lobe and scutellum orangish. Legs dark brown, with inconspicuous lighter-colored bands. Abdomen yellowish. **VESTITURE**: Sparsely setose. Head short, recumbent setae on entire surface; very short, erect, spine-like setae on dorsum, denser on anterior lobe; few moderately long, erect, fine setae on ventral surface. Pronotum with sparse, recumbent setae and short, erect setae over

dorsal surface; denser, recumbent setae on lateral surface and pleura, intermixed with short, erect setae.; scutellum with erect and recumbent setae. Legs with sparse setation on femora and moderately dense setation on tibiae. Corium and clavus with short, recumbent or erect setae. Abdomen with moderately dense, short recumbent setae, intermixed with sparse, short to long, erect setae. **STRUCTURE: Head:** Cylindrical, L/W = 2.48. Postocular lobe long; in dorsal view distinctly narrowing through anterior 2/3, posterior 1/3 constant, tube-like. Eye moderately sized; lateral margin much wider than postocular lobe; dorsal margin attaining postocular transverse groove, ventral margin removed from ventral surface of head in lateral view. *Labium:* I: II: III = 1: 1.6: 0.4. Basiflagellomere diameter larger than that of pedicel. **Thorax:** Antero-lateral angle bearing small, somewhat acute projection; medial longitudinal sulcus evident throughout, deepening posteriorly. Posterior pronotal lobe with rugulose surface; disc distinctly elevated above humeral angle; humeral angle armed, with dentate projection. Scutellum moderately long; apex angulate. *Legs:* Slender. *Hemelytron:* Slightly surpassing apex of abdomen, not more than length of abdominal segment 7; quadrate cell small, elongate; Cu and M of cubital cell subparallel. **GENITALIA: Pygophore:** Elongate ovoid; lightly sclerotized expansion below paramere; not expanded laterally in dorsal view. Medial process cylindrical; slender; long, much longer than paramere; laterally compressed towards apex; anterior surface towards apex ridged; minute spicules on posterior surface; semi-erect; very slightly curved at middle; apex in posterior view acute, with small hook-like projection. *Paramere:* Cylindrical; moderately long, reaching about mid-point of medial process; directed posteriad; not distinctly curved; apical part not enlarged. *Phallus:* Dorsal phallothecal sclerite shield-shaped; sclerotization reduced (yet not absent) on dorsal surface close to proximal edge; apical portion of phallothecal

sclerite gradually tapering, distinctly keeled medially, laterally flat, not forming angle; apex acute; proximal edge broadly concave. Struts attached to dorsal phallosomal sclerite; apically separate, connected by bridge; basally separate throughout. Basal plate arm robust; basally fused; in lateral view slightly curved; bridge extremely short; extension of basal plate expanded laterally onto arm, covering more than 1/2 of arm, curved.

*FEMALE*: Different from male as outlined below. Larger than male, total length 14.52–17.41 (mean 16.23, Table 4.2). Dorsal surface, including hemelytron, nearly uniformly pale brown; quadrate cell and proximal margin of postcubital cell yellowish; lateral and ventral surfaces yellowish; legs without bands or with inconspicuous bands. Basiflagellomere subequal in diameter to pedicel. Process on humeral angle spinous, long.

ETYMOLOGY: Species epithet from combining *gilvus* and *venter* to indicate the pale yellowish ventral surface of the body.

DISTRIBUTION: South America. Bolivia, Ecuador, Peru.

PARATYPES: **ECUADOR: Napo:** Jatun Sacha Biological Station, 20 km E of Puerto Napo, 450 m, 14 Jan 1989, E.A. Bergey and K.R. Hobson, 1;m (UCR\_ENT 00038447) (UCB). **PERU: Huanuco: Leoncio Prado Co.:** Tingo Maria, 9.3°S 75.9833°W, 671 m, 23 Nov 1940, J. C. Pallister, Allotype, 1;f (UCR\_ENT 00057801) (AMNH); 1946, J. C. Pallister, Paratype, 1;f (UCR\_ENT 00016999) (AMNH); 02 Nov 1946, J. C. Pallister, Paratype, 1;m (UCR\_ENT 00016997) (AMNH). Monzon valley, Tingo Maria, 9.27816°S 76.05562°W, 23 Sep 1954, E. I. Schlinger & E. S. Ross, Paratype, 1;f (UCR\_ENT 00019700) (CAS); 02 Nov 1954, E. I. Schlinger & E. S. Ross, Paratype, 1;f (UCR\_ENT 00019701) (CAS); 21 Nov 1954, E. I. Schlinger & E. S. Ross,

Paratype, 1;f (UCR\_ENT 00019702) (CAS). Tingo Maria (Town of), 9.3°S 75.9833°W, 671 m, 10 Aug 1960, D. A. Young, Paratype, 1;m (UCR\_ENT 00029356) (USNM). **Ica:** Chanchamayo, 13.7°S 75.8°W, 1700, Unknown, 1;m (UCR\_ENT 00023701) (RMNH). **Junin:** Satipo, 11.2667°S 74.6833°W, Jul 1940, P. Papraychi, 1;m (UCR\_ENT 00029357) (USNM). **unknown:** Pachitea, 9.41667°S 75.16667°W, 1700, Unknown, 2;m (UCR\_ENT 00023700, UCR\_ENT 00023702) (RMNH). Upper Rio Huallaga, 02 Jan 1928, H. Bassler, Paratype, 1;f (UCR\_ENT 00016998) (AMNH).

DISCUSSION: The rather long medial process can separate the male of this species easily from other closely related species. The whitish quadrate cell and proximal margin of the postcubital cell in the female is unique among all species of *Zelus*. The two sexes shows considerable size and coloration differences. They were associated primarily based on the presence of both sexes in the same series (Tingo Maria, Peru, see 'Paratypes' data).

***Zelus korystos* Hart, 1987** Figs 4.6, 4.15, 4.34.

HOLOTYPE: **TRINIDAD AND TOBAGO: Caroni:** Montserrado, 10.41666°N 61.35°W, 101 m, Jun 1929, Aug Busck, 1;m (UCR\_ENT 00008000) (USNM).

*Zelus korystos* Hart, 1986, p. 293, 303, figs. 25–27 [orig. descri. and fig.].

DIAGNOSIS: Recognized by the nearly uniformly dark brown dorsum; the abdomen light colored, pale yellowish brown; the postero-lateral rim with lightly sclerotized expansion between paramere and medial process; the medial process curved at middle; the anterior side of the medial process carinate; the apex of the medial process hook-like, the curvature of paramere small; the dorsal phallosheath sclerite with strong carination at apical part, the lateral expansion close to basal arm. Most similar to

*Zelus filicauda*, but the medial process is shorter and not as strongly curved and the paramere curvature small.

DESCRIPTION: *MALE*: Medium-sized, total length 10.42–11.55 (mean 10.98, Table 4.2); slender. **COLORATION**: Head dark brown; inconspicuous yellowish patch between eye and ocellus; medial, yellow stripe on postocular lobe; ventral surface yellowish brown, lighter than dorsum. Pronotum and scutellum dark brown. Abdomen yellowish brown. **VESTITURE**: Sparsely setose. Dorsum of head with moderately dense, short, recumbent setae and sparse, short, erect, somewhat spine-like setae; ventral surface with sparse, short, recumbent setae and few moderately long, erect, fine setae. Pronotum with very sparse, short, erect setae over dorsal surface, some setae curved apically, appearing recumbent; moderately dense, short to moderately long, recumbent setae on lateral surface and pleura, intermixed with semi-erect or erect setae.; scutellum with sparse, semi-erect and recumbent setae. Legs with sparse setation on femora and moderately dense setation on tibiae. Corium and clavus with mix of sparse, short, recumbent and erect setae. Abdomen with moderately dense, short, erect setae, intermixed with few, long, erect setae. Apical half of dorsal surface with moderately dense, medium-length, semi-erect setae. **STRUCTURE: Head**: Cylindrical, L/W = 2.27. Postocular lobe long; in dorsal view distinctly narrowing through anterior 2/3, posterior 1/3 constant, tube-like. Eye prominent; lateral margin much wider than postocular lobe; margins removed from dorsal and ventral surfaces of head in lateral view. *Labium*: I: II: III = 1: 2.0: 0.4. Basiflagellomere diameter larger than that of pedicel. **Thorax**: Antero-lateral angle bearing small, somewhat acute projection; medial longitudinal sulcus evident throughout, deepening posteriorly. Posterior pronotal lobe with rugulose surface; disc distinctly elevated above humeral angle; humeral angle armed, with spinous

processes. Scutellum moderately long; apex angulate, very slightly projected upward.

*Legs*: Slender. *Hemelytron*: Slightly surpassing apex of abdomen, not more than length of abdominal segment 7; quadrate cell small, elongate; Cu and M of cubital cell subparallel. **GENITALIA**: *Pygophore*: Elongate ovoid; lightly sclerotized expansion below paramere; not expanded laterally in dorsal view. Medial process cylindrical; slender; moderately long; laterally compressed towards apex; anterior surface towards apex ridged; minute spicules on posterior surface; posteriorly directed; curved at middle; apex in posterior view acute, with small hook-like projection. *Paramere*: Cylindrical; moderately long, not reaching medial process; directed posteriad; basally slightly narrower; slightly curved ventrad; apical part not enlarged. *Phallus*: Dorsal phalloshecal sclerite somewhat ovoid; sclerotization reduced (yet not absent) on dorsal surface close to proximal edge; expansion of lateral margin at about mid-portion small; apical portion of phalloshecal sclerite gradually tapering, distinctly keeled medially; apex acute; proximal edge concave. Struts attached to dorsal phalloshecal sclerite; apically separate, connected by bridge; basally separate. Basal plate arm robust; basally fused; in lateral view nearly straight, very slightly curved; bridge extremely short; extension of basal plate expanded laterally onto arm, covering more than 1/2 of arm, curved.

*FEMALE*: Unknown.

**DISTRIBUTION**: South America. Known from two disjunct areas: Trinidad and Guyana, and Ecuador.

**PARATYPES**: **GUYANA: Cuyuni-Mazaruni Region**: Bartica , or 'Kartabo-Bartica', 6.4°N 58.6166°W, 1 m, 4–8–1922, Unknown, 1;m (UCR\_ENT 00017230) (AMNH).

***Zelus nigromaculatus* Champion, 1898** Figs 4.6, 4.35.

HOLOTYPE: **PANAMA: Chiriqui:** Bugaba, 8.4833°N 82.6167°W, 457 m, No date provided, G.C. Champion, 1;m (UCR\_ENT 00048757) (BMNH).

*Zelus nigromaculatus* Champion, 1898, p. 261–262, Tab. XV, Fig. 26 [orig. descr. and fig.]; Wygodzinsky, 1949a, p. 49 [checklist].

DIAGNOSIS: The conspicuous black and yellow color pattern, resembling vespid wasp, the meso- and metafemora with at least three dark bands three yellow bands.

DESCRIPTION: **MALE:** Medium-sized; slender. **COLORATION:** Mixed yellow and dark brown; ventral surfaces mostly yellow, dorsal pattern variable; some specimens wasp-like. **VESTITURE:** Sparsely setose. Dorsum of head with moderately dense, short, recumbent setae and sparse, short, erect, somewhat spine-like setae; ventral surface with moderately dense, short, recumbent setae and few moderately long, erect, fine setae. Pronotum with sparse, short, erect setae on dorsal surface, some setae curved apically, appearing recumbent; moderately dense, short to moderately long, recumbent setae on lateral surface and pleura, intermixed with semi-erect or erect setae. Legs with sparse setation on femora and moderately dense setation on tibiae. Corium and clavus with short, recumbent setae. **STRUCTURE: Head:** Cylindrical. Postocular lobe long; in dorsal view distinctly narrowing through anterior 2/3, posterior 1/3 constant, tube-like. Eye prominent; lateral margin much wider than postocular lobe; dorsal margin attaining postocular transverse groove, ventral margin removed from ventral surface of head in lateral view. **Labium:** I: II: III = 1: 1.7: 0.4. Basiflagellomere diameter larger than that of pedicel. **Thorax:** Antero-lateral angle bearing small projection; medial longitudinal sulcus evident throughout, deepening posteriorly. Posterior pronotal lobe with rugulose surface; disc distinctly elevated above humeral angle; humeral angle armed, with spinous

processes. Scutellum moderately long; apex angulate, very slightly projected upward.

*Legs:* Slender. *Hemelytron:* Surpassing apex of abdomen by about length of abdominal segment 7; quadrate cell small and slender; Cu and M of cubital cell subparallel.

**GENITALIA:** *Pygophore:* Apex in posterior view rounded.

DISTRIBUTION: Southern Central America.

***Zelus panamensis* sp. nov.** Figs 4.6, 4.16, 4.35.

HOLOTYPE: **PANAMA: Canal Zone:** Alhajuelo, 05 Apr 1911, A. Busck, 1;m  
(UCR\_ENT 00008001) (USNM).

DIAGNOSIS: Recognized by the orangish or reddish head and the dark brown remainder of the body. The short, nearly straight medial process and the short paramere separate the male this species from all other species of the same species group. The yellowish or reddish ventral surface and the usually yellowish or reddish (blackish brown in some specimens) lateral surface distinguish the female of this species from others in the same group.

DESCRIPTION: *MALE:* Medium-sized, total length 11.25–12.90 (mean=11.96, Table 4.2); slender. **COLORATION:** Dark brown. Head orangish or reddish; remainder of body surface nearly uniformly dark brown; legs not banded or with inconspicuous bands.

**VESTITURE:** Sparsely setose. Entire surface of head with short, recumbent setae; sparse, short, erect, spine-like setae on dorsal surface, denser on anteocular lobe; few long, erect, fine setae on ventral surface. Pronotum with sparse, short, erect, spine-like setae on dorsum, very sparse on anterior lobe, setal tracts indistinct; lateral surface of pronotum and pleura with moderately long, semi-erect or recumbent setae; scutellum with moderately long, erect, spine-like setae. Legs with very sparse setation; sundew



setae on profemur very sparse. Corium and clavus with mix of short, recumbent or erect setae and long, erect, fine setae. Abdomen with moderately dense, short recumbent setae, intermixed with sparse, long, erect setae. **STRUCTURE: Head:** Cylindrical, L/W = 2.35. Postocular lobe long; in dorsal view distinctly narrowing through anterior 2/3, posterior 1/3 constant, tube-like. Eye prominent; lateral margin much wider than postocular lobe; dorsal margin attaining postocular transverse groove, ventral margin removed from ventral surface of head in lateral view. *Labium:* I: II: III = 1: 1.9: 0.4. Basiflagellomere diameter larger than that of pedicel. **Thorax:** Antero-lateral angle bearing small, somewhat acute projection; medial longitudinal sulcus evident throughout, deepening posteriorly. Posterior pronotal lobe with rugulose surface; disc distinctly elevated above humeral angle; humeral angle armed, with dentate projection. Scutellum moderately long; apex angulate, slightly projected upward. *Legs:* Slender. *Hemelytron:* Slightly surpassing apex of abdomen, not more than length of abdominal segment 7; quadrate cell small; Cu and M of cubital cell subparallel. **GENITALIA: Pygophore:** Elongate ovoid; lightly sclerotized expansion below paramere; not expanded laterally in dorsal view. Medial process cylindrical; slender; moderately long, about as long as paramere; laterally slightly compressed towards apex; minute spicules on posterior surface; semi-erect; very slightly curved at middle; apex in posterior view acute, with small hook-like projection. *Paramere:* Cylindrical; moderately long, not reaching medial process; directed posteriad; basally slightly narrower; slightly curved ventrad; apical part very slightly enlarged. *Phallus:* Dorsal phallothecal sclerite shield-shaped; sclerotization reduced (yet not absent) on dorsal surface close to proximal edge; expansion of lateral margin at about mid-portion pronounced, covering ventral surface of endosoma; apical portion of phallothecal sclerite gradually tapering, distinctly keeled medially, laterally

indistinctly angulate; apex acute; proximal edge broadly concave. Struts attached to dorsal phallothecal sclerite; apically separate, connected by bridge; basally separate throughout. Basal plate arm moderately robust; basally fused; in lateral view slightly curved; bridge extremely short; extension of basal plate expanded laterally onto arm, covering more than 1/2 of arm.

*FEMALE*: Similar to male, except for the following. Larger than male, total length 13.40–15.28 (mean 14.43, Table 4.2). Dorsal coloration similar to that in male; lateral surface of pronotum, pleura in some specimens dark brown; abdomen always orangish or reddish. Basiflagellomere subequal in diameter to pedicel. Process on humeral angle spinous, long.

*ETYMOLOGY*: Named after the country Panama, where the holotype was collected.

*DISTRIBUTION*: Central America, South America. Nicaragua, Costa Rica, Panama, Colombia, Ecuador.

*DISCUSSION*: The male of *Zelus panamensis* superficially shares a similar habitus with *Z. erythrocephalus*, *Z. russulumus* and *Z. paracephalus* in having a reddish head and a dark remainder of the body. This condition is also seen in certain specimens of *Z. banksi* sp. nov., *Z. truxali* sp. nov. and *Z. gilboventris* sp. nov., but apparently is not fixed in these species. Another coloration form showing a dark anterior pronotal lobe and an orangish brown posterior lobe is also observed in these latter species.

***Zelus truxali* sp. nov.** Figs 4.6, 4.16, 4.35.

*HOLOTYPE*: **PERU: Pasco**: Chontilla 22 km. SE of Iscozazin, 10.3357°S 75.11004°W, 20 Jul 1961, F. S. Truxal, 1;m (UCR\_ENT 00022668) (LACM).

DIAGNOSIS: The uniquely slender, recurved medial process can distinguish this species among the members of the *panamensis* species group. In female the anterior pronotal lobe yellowish and posterior lobe brown; the lateral and ventral surface of the body yellowish is unique among females of all species.

DESCRIPTION: *MALE*: Medium-sized, total length 11.59–12.25 (mean 11.91, Table 4.2); slender. **COLORATION**: Two major patterns recognized, one of predominantly brown to orangish brown, the other of dark brown to reddish brown. In former, posterior lobe lighter colored than anterior lobe, orangish brown; meso- and meta-femora with two minor bands. In latter, posterior pronotal lobe same color as anterior lobe, or only slightly lighter, somewhat reddish; legs not banded. In both patterns, medial longitudinal lighter colored stripe on postocular lobe. **VESTITURE**: Sparsely setose. Short, recumbent setae on entire surface of head; very short, erect, spine-like setae on dorsum, denser on anterior lobe; few moderately long, erect, fine setae on ventral surface. Pronotum with sparse, recumbent setae and short, erect setae over dorsal surface; denser, recumbent setae on lateral surface and pleura, intermixed with short, erect setae.; scutellum with sparse, semi-erect and recumbent setae. Legs with sparse setation on femora and moderately dense setation on tibiae. Corium and clavus with mix of sparse, short, recumbent and erect setae. Abdomen with moderately dense, short recumbent setae, intermixed with sparse, short to long, erect setae. **STRUCTURE: Head**: Cylindrical, L/W = 2.30. Postocular lobe long; in dorsal view distinctly narrowing through anterior 2/3, posterior 1/3 constant, tube-like. Eye moderately sized; lateral margin much wider than postocular lobe; dorsal margin attaining postocular transverse groove, ventral margin removed from ventral surface of head in lateral view. *Labium*: I: II: III = 1: 1.9: 0.4. Basiflagellomere diameter larger than that of pedicel. **Thorax**: Antero-lateral angle

bearing small, somewhat acute projection; medial longitudinal sulcus evident throughout, deepening posteriorly. Posterior pronotal lobe with rugulose surface; disc distinctly elevated above humeral angle; humeral angle armed, with dentate or spinous process. Scutellum moderately long; apex angulate, slightly projected upward in some specimens. *Legs*: Slender. *Hemelytron*: Slightly surpassing apex of abdomen, not more than length of abdominal segment 7; quadrate cell small; Cu and M of cubital cell subparallel. **GENITALIA**: *Pygophore*: Elongate ovoid; lightly sclerotized expansion below paramere; not expanded laterally in dorsal view. Medial process cylindrical; slender; moderately long, slightly longer than paramere; laterally slightly compressed towards apex; semi-erect; basally slightly curved, apex recurved; apex in posterior view acute, with small hook-like projection. *Paramere*: Cylindrical; moderately long, not reaching medial process; directed posteriad; slightly curved ventrad; apical part not enlarged. *Phallus*: Dorsal phallothecal sclerite shield-shaped; sclerotization reduced (yet not absent) on dorsal surface close to proximal edge; apical portion of phallothecal sclerite gradually tapering, distinctly keeled medially, laterally indistinctly angulate; apex truncate; proximal edge broadly concave. Struts apical portion missing; basally separate. Basal plate arm slender; separate; in lateral view slightly curved; bridge short; extension of basal plate expanded laterally onto arm, covering more than 1/2 of arm, curved.

*FEMALE*: Different from male as outlined below. Larger than male, total length 14.65–15.26 (mean 14.96, Table). Yellowish and brown; anterior pronotal lobe, lateral and ventral surfaces yellowish; posterior pronotal lobe and hemelytron brown; femora brown, with yellow bands, tibiae brown, without band. Basiflagellomere subequal in diameter to pedicel. Process on humeral angle spinous, long.

ETYMOLOGY: Named after F. S. Truxal, the collector of the type specimen.

DISTRIBUTION: South America. Ecuador, Peru, Boliva, Brazil.

PARATYPES: **BOLIVIA: Cochabamba:** Villa Tunari, Chapare, 16.91666°S 65.36667°W, 500 m, 09 Jan 1958, Wygodzinsky and Monros, 1;f (UCR\_ENT 00047331), 1;m (UCR\_ENT 00046974) (AMNH). **BRAZIL: Rondonia:** 62 km SW Ariqueemes, near Fzda. Rancho Grande, 10.3081°S 63.44383°W, 03 Dec 1996 – 15 Dec 1996, J. E. Eger, 1;m (UCR\_ENT 00009317) (USNM). **ECUADOR: Sucumbios:** Limoncocha, 0.43333°S 76.63333°W, 274 m, 23 Mar 1974 – 31 Mar 1974, Dodge Engleman, 1;m (UCR\_ENT 00015109) (AMNH). **PERU: Pasco:** Chontilla 22 km. SE of Iscozazin, 10.3357°S 75.11004°W, 20 Jul 1961, F. S. Truxal, Allotype, 1;f (UCR\_ENT 00022671), Paratype, 1;m (UCR\_ENT 00010797), 4;f (UCR\_ENT 00010798-UCR\_ENT 00010801) (LACM).

DISCUSSION: There are two distinct color forms in the male of this species, one with a orange-colored pronotum, and the other with completely dark dorsum. The available female specimens are from the same series as the males with an orange-colored posterior pronotal lobe. There are no female specimens known for the darker form of male. The recurved medial process is somewhat similar to that in *Z. auralanus*, but the two species can be easily distinguished by coloration and size.

***Zelus varius* (Herrich-Schaeffer, 1853)** Figs 4.16, 4.35.

*Euagoras varius* Herrich-Schaeffer, 1853, p. 122 [orig. descr.

NEOTYPE: **GUYANA: East Berbice-Corentyne:** Bartica, H.S. Parish, No date provided, J. R. de la Torre-Bueno, 1;m (UCR\_ENT 00069896) (KU) (**new designation**).

*Zelus varius*, Stål , 1872, p. 92 [cat . (subgenus *Diplodus*)]; Lethierry and Severin, 1896, p. 153 [cat.]; Wygodzinsky 1949a, p. 50 [checklist].

Identifications not verified:

*Diplodus varius*, Walker, 1873, p. 126 [cat].

**DIAGNOSIS:** The posterior margin of posterior pronotal lobe with expansion laterad to scutellum; the rather long, spinous process on humeral angle;. The smallish body size; the paramere short; the apical part of medial process compressed laterally, anterior side ridge-like; the apex of medial process re-expanded, not acute.

**DESCRIPTION:** *MALE:* Small, total length 10.11 (n=1, Table 4.2); slender.

**COLORATION:** Head uniformly brown; postocular lobe with very faint longitudinal medial stripe. Pronotum and scutellum pale brown, anterior lobe slightly darker. Very faint bands on legs. **VESTITURE:** Sparsely setose. Short, recumbent setae on entire surface of head; very short, erect, spine-like setae on dorsum, denser on anterior lobe; few moderately long, erect, fine setae on ventral surface. Pronotum with sparse, recumbent setae and short, erect setae over dorsal surface; denser, moderately long recumbent setae on lateral surface and pleura, intermixed with semierect or erect setae.; scutellum with sparse, semi-erect and recumbent setae. Legs with sparse setation on femora and moderately dense setation on tibiae. Corium and clavus with mix of sparse, short, recumbent and erect setae. Abdomen with moderately dense, short recumbent setae, intermixed with sparse, short to long, erect setae. **STRUCTURE: Head:** Cylindrical, L/W = 2.27. Postocular lobe long; in dorsal view distinctly narrowing through anterior 2/3, posterior 1/3 constant, tube-like. Dorsal margin attaining postocular transverse groove, ventral margin removed from ventral surface of head in lateral view. *Labium:* I: II: III = 1: 1.7: 0.4. Basiflagellomere diameter slightly larger than that of pedicel. **Thorax:** Antero-lateral angle with inconspicuous subtuberculate projection; medial longitudinal sulcus evident throughout, deepening posteriorly. Posterior pronotal lobe with rugulose surface; disc distinctly elevated above humeral angle; humeral angle

armed, with spinous processes. Scutellum moderately long; apex angulate, very slightly projected upward. *Legs*: Slender. *Hemelytron*: Surpassing apex of abdomen by about length of abdominal segment 7; quadrate cell small and slender; Cu and M of cubital cell subparallel. **GENITALIA**: *Pygophore*: Elongate ovoid; not expanded laterally in dorsal view. Medial process cylindrical; slender; long, much longer than paramere; laterally compressed towards apex; anterior surface towards apex ridged; minute spicules on posterior surface; semi-erect; curved at middle; apex in posterior view acute, with small hook-like projection, somewhat re-expanded laterally, resembling tail of humpback whale. *Paramere*: Cylindrical; short, not reaching medial process; directed posteriad; basally narrower; slightly curved ventrad; apical part very slightly enlarged. *Phallus*: Dorsal phallosheath sclerite elongated; sclerotization reduced (yet not absent) on dorsal surface close to proximal edge; apical portion of phallosheath sclerite gradually tapering, distinctly keeled medially, laterally flat, not forming angle; apex truncate; proximal edge broadly concave. Basal plate arm slender; separate; converging; in lateral view slightly curved; bridge short; extension of basal plate expanded laterally onto arm, covering more than 1/2 of arm, curved.

*FEMALE*: Similar to male, except for the following. Larger than male, total length 13.71–14.03 (mean 13.87, Table 4.2). Entire body nearly uniformly pale brown or dark brown.

**DISTRIBUTION**: South America. Guyana, Brazil.

**DISCUSSION**: The holotype and any specimens which might have been identified by Herrich-Schaeffer as being members of this species were reported destroyed during World War II. The original description is the the only description of *Zelus varius* in the literature. The following is a translation of this description. "Dirty yellow; head, anterior

part of the prothorax and coxae blood-red; membrane, antennae and legs brown; prothorax sulcate, posterior part of the disc unmarked; scutellum and membrane black." The color pattern of the 4 specimens from British Guiana agrees in the most part with this description but they are somewhat lighter than the insect described by Herrich-Schaeffer. One of the males from Guyana is designated as the neotype.

This species is clearly distinguishable from others of the genus and the group by the expansion laterad to scutellum of the posterior margin of the posterior pronotal lobe.

***Zelus xouthos* sp. nov.** Figs 4.6, 4.15, 4.35.

HOLOTYPE: **GUATEMALA: Izabal:** Cayuga, 15.5333°N 88.7°W, 25 m, May 1915, W. M. Schaus, 1;m (UCR\_ENT 00008003) (USNM).

DIAGNOSIS: The dorsal coloration somewhat reddish; the humeral angle elevated nearly to the level of and nearly continuous with pronotal disc. The paramere long, exceeding medial process, the apex somewhat obliquely truncate; and the medial process apically not compressed.

DESCRIPTION: *MALE*: Medium-sized, total length 12.59 (n=1, Table 4.2); slender. **COLORATION**: Entire surface brown, dorsum of head, posterior pronotal lobe, corium, clavus, apices of femora, parts of tibiae somewhat reddish. **VESTITURE**: Sparsely setose. Short, recumbent setae on dorsal surface of head, long recumbent setae on ventral surface; short, erect, spine-like setae on dorsum, denser on anterior lobe; few moderately long, erect, fine setae on ventral surface. Pronotum with sparse, recumbent setae and short, erect setae over dorsal surface; denser, moderately long recumbent setae on lateral surface and pleura, intermixed with semi-erect or erect setae.; scutellum with sparse, semi-erect and recumbent setae. Legs with sparse setation on femora and



moderately dense setation on tibiae. Corium and clavus with short, recumbent setae. Abdomen with moderately dense, short recumbent setae, intermixed with sparse, short to long, erect setae. **STRUCTURE: Head:** Cylindrical, L/W = 2.43. Postocular lobe long; in dorsal view distinctly narrowing through anterior 2/3, posterior 1/3 constant, tube-like. Eye prominent; lateral margin much wider than postocular lobe; dorsal margin attaining postocular transverse groove, ventral margin removed from ventral surface of head in lateral view. *Labium:* I: II: III = 1: 2.1: 0.4. Basiflagellomere diameter slightly larger than that of pedicel. **Thorax:** Antero-lateral angle with inconspicuous subtuberculate projection; medial longitudinal sulcus evident throughout, deepening posteriorly. Posterior pronotal lobe with rugulose surface; disc about same level as humeral angle; humeral angle armed, with spinous processes. Scutellum moderately long; apex angulate. *Legs:* Very slender. *Hemelytron:* Surpassing apex of abdomen by about length of abdominal segment 7; quadrate cell small and slender; Cu and M of cubital cell subparallel. **GENITALIA: Pygophore:** Ovoid; not expanded laterally in dorsal view. Medial process cylindrical; slender; moderately long, much longer than paremere; minute spicules on posterior surface; semi-erect; basally slightly curved; apex in posterior view acute, with small hook-like projection. *Paramere:* Cylindrical; moderately long, slightly exceeding medial process; directed posteriad; apical part appearing somewhat truncate dorsally. *Phallus:* Dorsal phallothecal sclerite elongated; medial, longitudinal sulcus on dorsal surface; apical portion of phallothecal sclerite gradually tapering, distinctly keeled medially, laterally flat, not forming angle; apex truncate; proximal edge broadly concave. Basal plate arm slender; separate; converging; in lateral view slightly curved; bridge short; extension of basal plate expanded laterally onto arm, covering more than 1/2 of arm.

*FEMALE*: Similar to male, except for the following. Larger than male, total length 14.69 (n=1, Table 4.2).

ETYMOLOGY: From Greek *xutho*, meaning yellowish brown, to refer to the yellowish coloration.

DISTRIBUTION: Central America. Guatemala.

PARATYPES: **GUATEMALA: Peten:** Tikal, 17.225°N 89.6133°W, 12 May 1956, T. H. Hubbell, 1;u (UCR\_ENT 00029352) (USNM).

DISCUSSION: This species appears to be the most divergent of this group. Although, three other species within the same geographical range of this species, *Z. janus*, *Z. exanguis*, *Z. ambulans*, also have an elevated humeral angle, their much greater size and features of the male genitalia should eliminate any confusion in recognizing *Z. xouthous*.

***Zelus auralanus* sp. nov.** Figs 4.7, 4.17, 4.37.

HOLOTYPE: **BRAZIL: Rio de Janeiro:** Vista Alegre, 06 Sep 1924, J. R. de la Torre-Bueno, 1;m (UCR\_ENT 00069892) (KU).

DIAGNOSIS: Can be readily recognized by the uniformly brown coloration; the darkened tibial apex; the humeral angle elevated to level of disc; the dorsal setae on head and pronotum appearing somewhat golden, shining when viewed under magnification. The paramere gradually enlarged; the medial process triangular and curved slightly posteriad in the middle, the apical hook-like process; the short, dorsad projection sub-medially on dorsal phallosclerite and the the lateral recurved, dorsad, sharp process.

DESCRIPTION: *MALE*: Medium-sized, total length 12.64–14.37 (mean 13.61, Table 4.2); slender. **COLORATION**: Nearly entire surface medium dark brown; apices of femora dark colored; abdomen light brown. **VESTITURE**: Densely setose. Body surface covered with short, adpressed to recumbent setae, dorsal setae on head and pronotum golden, shining; ventral surface of head and abdomen with longer, erect setae; sometimes setae covered with white waxy exudation. Dense, long, erect setae on paramere; bush of short, erect, spine-like setae on posterior surface of medial process. Corium and clavus with short, recumbent setae. **STRUCTURE: Head**: Cylindrical, L/W = 2.63. Postocular lobe long; in dorsal view anteriorly gradually narrowing, posterior portion constant, slightly narrower. Eye prominent; lateral margin much wider than postocular lobe; margins removed from dorsal and ventral surfaces of head in lateral view. *Labium*: I: II: III = 1: 2.0: 0.4. Basiflagellomere diameter slightly larger than that of pedicel. **Thorax**: Antero-lateral angle bearing small projection; medial longitudinal sulcus shallow near collar, deepening posteriorly. Posterior pronotal lobe with rugulose surface; disc about same level as humeral angle; humeral angle armed, with dentate or spinous process. Scutellum long; apex blunt, not projected. *Legs*: Slender. *Hemelytron*: Slightly surpassing apex of abdomen, not more than length of abdominal segment 7; quadrate cell small, relatively broad; Cu and M of cubital cell converging towards R. **GENITALIA**: *Pygophore*: Ovoid; slightly expanded laterally near base of paramere in dorsal view. Medial process triangular; slender; long; antero-posteriorly compressed; semi-erect; curved at middle; apex in posterior view acute, with small hook-like projection. *Paramere*: Cylindrical; moderately long, slightly exceeding medial process; directed posteriad, slightly curved towards medial process; basally narrower; curved ventrad; apical part very slightly enlarged. *Phallus*: Dorsal phallosomal sclerite somewhat

pundurate, medially strongly constricted; dorsad small sharp projection laterally at mid-portion; apical portion of phallothecal sclerite gradually tapering, lateral margin narrowly angulate, angulation ending anteriorly in sharp, dorsad projection; apex rounded, medially emarginate; proximal edge inversely V-shaped. Struts attached to dorsal phallothecal sclerite; apically separate, connected by bridge; basally almost completely fused. Basal plate arm moderately robust; separate; converging; in lateral view severely curved, nearly semi-circular; bridge short; extension of basal plate expanded onto arm.

*FEMALE*: Similar to male, except for the following. Larger than male, total length 17.21–18.32 (mean 17.85, Table 4.2). Eye moderate size, smaller than in male.

ETYMOLOGY: The species epithet indicates the somewhat reddish tone of the coloration.

DISTRIBUTION: South America. Known from Ecuador and Brazil.

PARATYPES: **BRAZIL: Mato Grosso:** Barra do Tapirape, 10.46666°S 50.51667°W, 26 Dec 1962, B. Malkin, 1;m (UCR\_ENT 00019695), 3;f (UCR\_ENT 00019696-UCR\_ENT 00019698) (CAS). **Rio Bran:** Vista Alegre, 06 Sep 1924, J. R. de la Torre-Bueno, 1;m (UCR\_ENT 00069894) (KU). **ECUADOR: Napo:** 30 km E of Pto Napo, 1.04256°S 77.60111°W, 410 m, 04 Mar 2005, Unknown, 1;m (UCR\_ENT 00072667) (UCR); 06 Mar 2005, Unknown, 1;f (UCR\_ENT 00072668) (UCR).

***Zelus casii* sp. nov.** Figs 4.7, 4.18, 4.37.

HOLOTYPE: **BRAZIL: Amapa:** Villa Amazonas, 0.03333°N 51.05°W, 29 May 1964, C. E. & E. S. Ross, 1;m (UCR\_ENT 00048228) (CAS).

**DIAGNOSIS:** Can be recognized by the uniform dark brown coloration; the extremely long postocular lobe; and the rather broad medial process, apex emarginate and bearing lateral ridge-like elevation.

**DESCRIPTION:** *MALE:* Medium-sized; slender. **COLORATION:** Entirely brown, somewhat reddish; apices of femora slightly darkened; ventral surface of head, parts of pleura, and abdomen pale brown. **VESTITURE:** Sparsely setose. Dorsal surface of head with dark, short, erect, spine-like setae, denser on anterior lobe, and moderately dense, short, recumbent setae; ventral surface with sparse, short, recumbent setae and few long, erect setae. Anterior pronotal lobe nearly glabrous, few short, spine-like setae; posterior lobe with short, erect, spine-like setae, some apically curved; pleura with short to moderately long, recumbent and semi-erect setae, some covered with white waxy exudation; scutellum with recumbent setae. Legs with sparse setation. Corium and clavus with short, recumbent setae. Abdomen with sparse, short, recumbent setae, intermixed with few longer setae. Dorsal, outer surface of enlarged part of paramere with dense, long, erect setae. **STRUCTURE: Head:** Elongated. Postocular lobe very long; in dorsal view anteriorly gradually narrowing, posterior portion constant, slightly narrower. Eye prominent; lateral margin much wider than postocular lobe; dorsal margin attaining postocular transverse groove, ventral margin removed from ventral surface of head in lateral view. **Thorax:** Antero-lateral angle with inconspicuous subtuberculate projection; medial longitudinal sulcus evident throughout, deepening posteriorly. Posterior pronotal lobe with rugulose surface; disc distinctly elevated above humeral angle; humeral angle armed, with dentate projection. Scutellum moderately long; apex angulate, slightly projected upward. *Legs:* Slender. *Hemelytron:* Slightly surpassing apex of abdomen, not more than length of abdominal segment 7; quadrate cell moderately sized; Cu and M of

cubital cell subparallel. **GENITALIA:** *Pygophore:* Ovoid; expanded laterally near base of paramere in dorsal view. Medial process expanded laterally; rather broad; moderately long; antero-posteriorly compressed; erect; curved at middle; apex in posterior view emarginate, subapical lateral, hook-like process; lateral elevations running from below base of medial process through middle, with short, stout, semierect setae. *Paramere:* Somewhat sickle-shaped; short, not reaching apex of medial process; basally constricted; strongly curved ventrad. *Phallus:* Dorsal phallothecal sclerite somewhat squarish; lateral longitudinal blade-like heavy sclerotization, pressed against and not separated from phallothecal sclerite; apical portion of phallothecal sclerite gradually tapering, slightly convex, laterally angulate, angulation ending anteriorly in sharp, dorsad projection; apex rounded, medially emarginate; proximal edge concave. Struts attached to dorsal phallothecal sclerite; apically separate, connected by bridge; basally separate. Basal plate arm moderately robust; basally fused; in lateral view strongly curved at midpoint; bridge extremely short; extension of basal plate expanded onto arm.

*FEMALE:* Unknown.

ETYMOLOGY: Named after Casi.

DISTRIBUTION: South America. A single specimen known from the State of Amazonas, Brazil.

DISCUSSION: Several characters of *Zelus casii* sp. nov. are highly unique among all species of *Zelus*. It has an extraordinarily long postocular lobe. The medial process is very broad, has lateral ridge-like elevations, and the apex is emarginate.

***Zelus erythrocephalus* Fabricius, 1803** Figs 4.7, 4.18, 4.36.

*Zelus erythrocephalus* Fabricius, 1803, p. 283 [orig. descr.]; Stål, 1872, p. 92 [cat. (subgenus *Diplodus*)]; Bergroth, 1893, p. 63 [note]; Lethierry and Severin, 1896, p. 152 [cat.]; Champion, 1898, p. 257 [note]; Wygodzinsky, 1949a, p. 49 [checklist]; Zimsen, 1964, p. 338 [list].

*Diplodus erythrocephalus* Stål, 1868, p. 283 [descr.] Identifications not verified:

*Euaqoras erythrocephalus* Burmeister, 1835, p. 227 [list].

*Diplodus erythrocephalus* Walker, 1873, p. 125 [cat.]; Van Duzee, 1901, p. 351 [note].

*Zelus erythrocephalus* Blanchard, 1840, p. 101 [cat. (*erythrocephalus* sic.)]; Brindley, 1931, p. 137, 151 [list and note].

DIAGNOSIS: The dorsal coloration nearly uniformly dark brown; the membrane with indistinct iridescence. Most similar to *Zelus paracephalus* sp. nov. and *Zelus russulumus* sp. nov; can be distinguished from both by the rather slender medial process.

DESCRIPTION: **MALE:** Medium-sized, total length 12.07–12.77 (mean 12.49; Table 4.2); slender. **COLORATION:** Head reddish brown, anterior to antennal insertion and posterior third of postocular lobe lighter. Rest of surface of body nearly uniformly blackish brown; area around humeral angle lighter, somewhat reddish. Membrane with blue, purple iridescence. **VESTITURE:** Moderately setose. Dark, moderately dense, short, erect, spine-like setae on dorsum of head, curved on postocular lobe; ventral surface with sparse, short, erect and recumbent setae, few long setae. Pronotal dorsum nearly glabrous, very sparse, short, erect, spine-like setae; lateral surface with sparse, erect to recumbent, spine-like setae; setal tracts on anterior lobe very reduced. Pleura with very sparse, spine-like setae and recumbent setae. Corium and clavus with sparse,

short, recumbent setae. Abdomen with sparse, short, erect setae, intermixed with few long setae. Pygophore with sparse, short to long, semi-erect setae.; Paramere apical 1/2 with dense, long setae, nearly as long as medial process. **STRUCTURE: Head:** Cylindrical, L/W = 2.29. Postocular lobe long; in dorsal view distinctly narrowing through anterior 2/3, posterior 1/3 constant, tube-like. Eye prominent; lateral margin much wider than postocular lobe; dorsal margin removed from postocular transverse groove, ventral margins attaining ventral surface of head in lateral view. *Labium*: I: II: III = 1: 2.0: 0.4. Basiflagellomere diameter larger than that of pedicel. **Thorax:** Antero-lateral angle bearing small projection; medial longitudinal sulcus shallow near collar, deepening posteriorly. Posterior pronotal lobe with rugulose surface; disc distinctly elevated above humeral angle; humeral angle armed, with dentate projection. Scutellum moderately long; apex angulate, very slightly projected upward. *Legs*: Very slender. *Hemelytron*: Surpassing apex of abdomen by about length of abdominal segment 7; quadrate cell small, relatively broad; Cu and M of cubital cell subparallel. **GENITALIA: Pygophore:** Ovoid; mid-lateral fold adjacent to paramere insertion inconspicuous; not expanded laterally in dorsal view. Medial process cylindrical; very slender; long; erect; straight; apex in posterior view acute, subapical hook-like lateral processes. *Paramere*: Cylindrical; long, surpassing medial process; curved ventrad at mid-point, apex recurved. *Phallus*: Dorsal phallothecal sclerite shield-shaped, sclerite absent laterad to basal arms; lateral longitudinal blade-like heavy sclerotization, elevated, surpassing apical margins; apical portion of phallothecal sclerite not distinctly tapered, flat, lateral margin narrowly angulate, angulation ending anteriorly in sharp, dorsad projection; apex with small medial emargination; proximal edge broadly concave. Struts attached to dorsal phallothecal sclerite; apically separate, connected by bridge; basally fused. Basal



plate arm robust; basally fused; in lateral view strongly curved at midpoint; bridge extremely short; extension of basal plate expanded onto arm.

*FEMALE*: Similar to male, except for the following. Larger than male, total length 16.85–19.06 (mean 17.92, Table 4.2). Spinous process on humeral angle long.

DISTRIBUTION: South America.

***Zelus kartabenoides* sp. nov.** Figs 4.7, 4.37.

HOLOTYPE: **ECUADOR: Sucumbios:** Dureno, 0.0444°N 76.6972°W, 150 m, 23 Sep 1977 – 30 Sep 1977, L. Pena, 1;m (UCR\_ENT 00009521) (USNM).

DIAGNOSIS: The lateral surface and posterior margin of posterior pronotal lobe, and scutellum yellowish. The paramere diameter even throughout, apex not enlarged, base slightly constricted; the medial process with ridge-like medial elevation through apical 1/2, smaller than in *Z. kartabensis*.

DESCRIPTION: *MALE*: Medium-sized; Coloration, vestiture and structure including genitalia very similar to *kartabensis* except for the following. Lateral surface and posterior margin of posterior pronotal lobe, and scutellum yellowish. Postero-lateral rim of pygophore in smaller angle with body long-axis in lateral view, nearly horizontal. Medial process more bent forward. Paramere diameter even throughout, apex not enlarged, base slightly narrower; apical 2/3 curved ventrad. Lateral arch-shaped protrusion on postero-dorsal rim more pronounced; proximal side of arch extending down as process. Struts apically diverging, V-shaped.

*FEMALE*: Unknown.

ETYMOLOGY: The specific epithet indicates that this species is rather similar to *Z. kartabensis*.

DISTRIBUTION: South America. Colombia, Peru.

***Zelus kartabensis* Haviland, 1931** Figs 4.7, 4.17, 4.37.

LECTOTYPE: **GUYANA:** Cuyuni-Mazaruni Region: Kartabo, British Guiana, Jun 1922, M.D. Haviland, 1;m (UCR\_ENT 00048761) (BMNH) (**new designation**).

*Zelus kartabensis* Haviland, 1931: 137, 148, 152 (checklist, fig. and orig. descr.

[subgenus *Diplodus*]); Wygodzinsky, 1949a: 49 (checklist) *Zelus pallidinervus*

Haviland, 1931: 137, 148, 153 (checklist, fig and orig. descr. [subgenus

*Diplodus*]); Wygodzinsky, 1949a: 50 (checklist) (**syn. nov.**).

DIAGNOSIS: The dorsal surface of posterior pronotal lobe uniformly dark brown.

The paramere gradually enlarged, somewhat club-shaped; the medial process with ridge-like medial elevation through apical 1/2.

DESCRIPTION: **MALE:** Medium-sized; slender. **COLORATION:** Dorsum of pronotum and hemelytron dark brown. Lateral surface of posterior pronotal lobe, parts of pleura, sometimes medial regions of abdominal venter yellowish. Head dorsal surface mostly yellowish to pale, sometimes brown stripes or areas more dominant; brown medial longitudinal stripes on anteocular lobe dorsal surface; brown areas on dorsal surface of postocular lobe, anteriorly broad, medially separated by yellowish stripe, narrowing and converging posteriorly; brown stripe between eye and antennal insertion; ventral surface entirely yellowish. Legs brown; meso or metafemora sub-basally, medially, or sub-apically with yellowish band(s); meso and metatibiae occasionally with inconspicuous medial yellow band; fore leg never banded. **VESTITURE:** Sparsely setose. Dorsum primarily consisting of moderately dense, short, erect or decumbent setae; short spine-like setae also on dorsum of head, more concentrated on anteocular

lobe, and on pronotum. Sundew setae on fore femur sparsely and randomly distributed. Microtrichia throughout posterior margin of membrane of hemelytron. Abdominal venter with short, decumbent setae, intermixed with sparse, moderately long, erect setae.

Setae on pygophore short to long, decumbent to erect; paramere apical 1/2 with dense, very long, almost as long as paramere, erect, apically curved setae, directed mediad.

**STRUCTURE: Head:** Cylindrical, L/W = 2.5. Eye moderately sized; margins removed from dorsal and ventral surfaces of head in lateral view. *Labium:* I: II: III = 1: 2.0: 0.4.

Basiflagellomere diameter larger than that of pedicel. **Thorax:** Antero-lateral angle rounded, sometimes bearing protuberance, never prominently acute; medial longitudinal sulcus shallow near collar, deepening posteriorly. Posterior pronotal lobe with rugulose surface; disc distinctly elevated above humeral angle; humeral angle armed, with short tuberculate processes. Scutellum long; apex angulate, slightly projected upward. *Legs:* Slender. *Hemelytron:* Surpassing apex of abdomen by about length of abdominal segment 7; quadrate cell small and slender; Cu and M of cubital cell subparallel.

**GENITALIA:** *Pygophore:* Ovoid; expanded near base of paramere in dorsal view, expansion oriented dorsad in lateral view. Medial process triangular; long; erect; nearly straight; apex in posterior view acute. *Paramere:* Somewhat sickle-shaped; moderately long, slightly exceeding medial process; curved ventrad; apical part enlarged. *Phallus:* Dorsal phallosclerite shield-shaped; sharp lateral transverse ridge-like expansions; convex; apex truncate or slightly rounded; proximal edge deeply concave. Struts weakly sclerotized to non-visible through apical 1/2; apically separate, not connected by bridge; basally almost completely fused. Basal plate arm moderately robust; separate; subparallel; bridge moderately long; extension of basal plate expanded onto arm.

*FEMALE*: Different from male as outlined below. Larger than male, total length 15.49–17.45 (mean 16.53, Table 4.2). Mostly yellowish to greenish. No dark dorsal makings of anteocular lobe; remainder of dark cranial markings less pronounced than in male. Posterior margin of posterior pronotal lobe and corium dark. Femora unbanded. Spine-like setae more conspicuous than in male. Basiflagellomere not swollen basally. Humeral angles nearly elevated to level of pronotal disc; lateral processes spinous.

*DISTRIBUTION*: South America. The Guianas, the Brazilian Amazonia and southern parts of Brazil.

***Zelus laticornis* (Herrich-Schäffer, 1853)** Figs 4.7, 4.17, 4.37.

*HOLOTYPE*: Destroyed.

*Euagoras laticornis* Herrich-Schaeffer, 1853, p. 123, Tab. CCCIX. Fig. C, [orig. descr. and fig.]

*Zelus laticornis* Stål, 1872, p. 92 [cat.]; Lethierry and Severin, 1896, p. 152 [cat.]; Wygodzinsky, 1949a, p. 49 [checklist].

*Zelus formosus* Haviland, 1931, p. 137, 151–152 [list and orig. descr. (subgenus *Diplodus*)] (**syn. nov.**); Wygodzinsky, 1949a, p. 49 [checklist].

*Zelus tristis* Haviland, 1931, p. 137, 154 [list and orig. descr. (subgenus *Diplodus*)] *Syn. Nov.*; Wygodzinsky, 1949a, p. 50, [checklist].

Identifications not verified:

*Darbanus laticornis* Walker, 1873, p. 127 [cat].

*DIAGNOSIS*: The strongly convex pronotum distinguishes this species from most other species of the genus. The male can be distinguished by the relatively small size (10.82, Table 4.2); the dorsum of the posterior pronotal lobe usually with lighter colored,

pale brown, medial stripe; the broad, pentagonal, apically angulate medial process; the short, blade-like process on dorsal phallothecal sclerite; and the ridge mesad to the blade-like process. In female the head, pronotum and corium usually orangish brown to reddish.

DESCRIPTION: *MALE*: Small, total length 9.94–11.44 (mean 10.82, Table 4.2); slender. **COLORATION**: Head mostly yellowish; some specimens with sub-medial stripes on anteocular lobe; variable brown areas on dorsal surface of postocular lobe, anteriorly broad, narrowing and fusing posteriorly, medially separated by yellowish stripe. Most common coloration of thorax: anterior pronotal lobe dark brown; posterior lobe dark brown, with medial and dorso-lateral yellowish or orange stripes; pleura brown, mixed with yellow parts. Proportion of dark brown and yellow on posterior pronotal lobe variable, some specimens entirely dark and some entirely yellowish or orange. Scutellum broadly medially yellowish, lateral parts dark brown, some specimens nearly entirely dark or yellowish. Hemelytron uniformly dark brown, corium in some specimens yellowish. Profemur and protibia dark brown, sometimes with single inconspicuous yellowish band; meso and metafemora dark brown, with two or three yellow bands, sometimes basal band rather broad; meso- and meta-tibiae usually dark brown with single yellow band. **VESTITURE**: Moderately setose. Body surface with mostly short, recumbent setae, erect setae sparse. **STRUCTURE: Head**: Cylindrical, L/W = 2.24. Postocular lobe long; in dorsal view anteriorly gradually narrowing, posterior portion constant, slightly narrower. Eye moderately sized; lateral margin much wider than postocular lobe; margins removed from dorsal and ventral surfaces of head in lateral view. *Labium*: I: II: III = 1: 1.8: 0.5. Basiflagellomere diameter slightly larger than that of pedicel. **Thorax**: Antero-lateral angle bearing small projection; medial longitudinal sulcus

evident only on posterior 1/2, deepening anterior to transverse sulcus of pronotum. Posterior pronotal lobe with rugulose surface; disc distinctly elevated above humeral angle; humeral angle armed, with dentate projection. Scutellum moderately long; apex angulate, slightly projected upward in some specimens. *Legs*: Moderately robust. *Hemelytron*: Slightly surpassing apex of abdomen, not more than length of abdominal segment 7; quadrate cell large and broad; Cu and M of cubital cell converging towards R. **GENITALIA**: *Pygophore*: Ovoid; slightly expanded laterally near base of paramere in dorsal view. Medial process pentagonal; moderately long; antero-posteriorly compressed; erect; straight; apex in posterior view angulate, subapical transverse hook-like bridge. *Paramere*: Cylindrical; short, not reaching apex of medial process; directed posteriad; basally slightly narrower; nearly straight; apical part not enlarged. *Phallus*: Dorsal phallothecal sclerite somewhat squarish; lateral small blade-like heavy sclerotization continuous from basal arm; apical portion of phallothecal sclerite not distinctly tapered, flat; apex truncate; proximal edge deeply concave. Struts attached to dorsal phallothecal sclerite; apically separate, connected by bridge; basally almost completely fused. Basal plate arm robust; separate; diverging; in lateral view severely curved, nearly semi-circular; bridge long; extension of basal plate expanded onto arm.

*FEMALE*: Different from male as outlined below. Larger than male, total length 12.38–14.14 (mean 13.67, Table 4.2). Head, dorsum of pronotum and corium reddish orange, entirety or portion of posterior pronotal lobe dark brown in some specimens; membrane dark brown; lateral surface of pronotum, pleura and abdomen yellowish, with dark stripes; legs reddish, with dark bands. Hemelytron attaining apex of abdomen.

**DISTRIBUTION**: Central and South America. Widely distributed in South America and only known from Panama in Central America.

DISCUSSION: The direction of the lateral margins of the medial process varies from converging to nearly parallel. *Zelus laticornis* is the only species that does not have processes or ridges mesad to the dorsal blade-like projection among the species with this latter structure. Sexual dimorphism is pronounced in this species. The male is usually brownish, with yellow or orange markings on pronotum and legs. The female is bright reddish orange and is possibly a mimic of species of the coreid bug *Hypselonotus*. Coloration of male is variable within this species, but there is a lack of geographical pattern. The colors and patterns are variable as much within any geographic area as between areas. The major variation in the males is in the dorsal coloration of the posterior pronotal lobe, the usual configuration being brownish-black with a light longitudinal medial stripe. Some specimens, however, may have this area entirely reddish-brown or brownish-black. Some males also have a yellowish-brown clavus and corium as opposed to the usual dark coloration of these areas. Females show limited coloration variation, with part of the pronotum sometimes dark colored. The original drawing of this species was only an outline drawing of the head and pronotum and is not useful for identification purposes. The verbal description, however, was obviously of a male of this species with the light medial area on the pronotum and scutellum, no other species having this character in either sex. The holotype was apparently destroyed during World War II. As this species is quite distinct, it is not felt necessary to designate a neotype.

***Zelus mattogrossensis* Wygodzinsky, 1947** Figs 4.7, 4.17, 4.36.

HOLOTYPE: **BRAZIL: Matto Grosso:** Chavantina, Jun 1947, J. C. M. Carvalho, 1;m (No USI assigned) (MNRJ).

*Zelus mattoqrossensis* Wygodzinsky, 1947, p. 431–434 [orig. descr. and fig.];

Wygodzinsky, 1948, p. 17 [cat.]; Wygodzinsky, 1949a, p. 49 [checklist];

Wygodzinsky, 1960, p. 308 [note].

**DIAGNOSIS:** Distinguished by the small size; the robust form, the humeral angle rounded, without projection; the profemur much longer than the metafemur (1.20x); the profemoral length being less than 20.0x the profemoral width (16.94x). The paramere base not distinctly constricted; the medial process slender, apex angulate and bearing subapical medial protrusion; the presence of blade-like process on dorsal phallosome and the process not extending beyond mid-point.

**DESCRIPTION:** *MALE:* Small, total length 9.18–10.49 (mean 9.85, Table 4.2); slender. **COLORATION:** Brown. Medial longitudinal stripe on postocular lobe, patch between eye and ocellus, and ventral surface of head light colored. Two yellow bands on scape and one on pedicel. Anterior pronotal lobe darker than posterior lobe. Lateral surface of pronotum and parts of pleura lighter colored. Femora and tibiae banded. **VESTITURE:** Moderately setose. Body surface with short, recumbent and erect setae; some longer setae on ventral surface of head and abdomen. Paramere with dense, moderately long, erect setae on dorsal surface. Corium and clavus with short, recumbent setae. **STRUCTURE: Head:** Cylindrical, L/W = 2.61. Postocular lobe long; in dorsal view anteriorly gradually narrowing, posterior portion constant, slightly narrower. Eye moderately sized; lateral margin only slightly wider, roughly on line with margin of postocular lobe; dorsal margin attaining postocular transverse groove, ventral margin removed from ventral surface of head in lateral view. *Labium:* I: II: III = 1: 1.8: 0.4. Basiflagellomere diameter larger than that of pedicel. **Thorax:** Antero-lateral angle bearing small projection; medial longitudinal sulcus shallow near collar, deepening



posteriorly. Posterior pronotal lobe with rugulose surface; disc distinctly elevated above humeral angle; humeral angle rounded, without projection. Scutellum moderately long; apex angulate, not projected. *Legs*: Moderately robust. *Hemelytron*: Slightly surpassing apex of abdomen, not more than length of abdominal segment 7; quadrate cell small, relatively broad; Cu and M of cubital cell converging towards R. **GENITALIA**:

*Pygophore*: Elongate ovoid; slightly expanded laterally near base of paramere in dorsal view. Medial process cylindrical; slender; moderately long; erect; straight; apex in posterior view angulate, subapical ridge-like medial elevation, not across. *Paramere*: Cylindrical; moderately long, slightly exceeding medial process; directed posteriad, slightly curved towards medial process; basally slightly constricted; nearly straight.

*Phallus*: Dorsal phallothecal sclerite somewhat petagonal in dorsal view; sharp blade-like heavy sclerotization originating from basal arms, directed apically, elevated above dorsal surface, extending to about mid-point of phallothecal sclerite; ridge mesad to process; apical portion of phallothecal sclerite gradually tapering, convex, laterally angulate; apex truncate; proximal edge inversely V-shaped. Struts attached to dorsal phallothecal sclerite; apically fused; basally separate. Basal plate arm robust; medially fused; in lateral view strongly curved at midpoint; bridge short; extension of basal plate expanded onto arm.

*FEMALE*: Similar to male, except for the following. Larger than male, total length 10.30–11.72 (mean 10.98, Table). Pale brown, anterior and posterior pronotal lobes same color, legs without bands or with very inconspicuous bands. Hemelytron attaining apex of abdomen.

DISTRIBUTION: South America.

***Zelus paracephalus* sp. nov.** Figs 4.7, 4.18, 4.36.

HOLOTYPE: **COLOMBIA: State unknown:** Rio Quamal, 400 m, 24 Jan 1948, Richter, 1;m (UCR\_ENT 00057803) (AMNH).

DIAGNOSIS: The dorsal coloration nearly uniformly dark brown; the membrane with indistinct iridescence. Most similar to *Z. erythrocephalus* and *Z. russulumus*; can be distinguished from both by the rather wide medial process.

DESCRIPTION: **MALE:** Medium-sized, total length 11.87–13.06 (mean 12.51, Table 4.2); slender. **COLORATION:** Head reddish brown, anterior to antennal insertion and posterior third of postocular lobe lighter. Rest of surface of body nearly uniformly blackish brown, area around humeral angle lighter, somewhat reddish. Membrane with blue, purple iridescence. **VESTITURE:** Sparsely setose. Dark, moderately dense, short, etc, spine-like setae on dorsum of head, more curved on postocular lobe; ventral surface with sparse, short, erect and recumbent setae, few long setae. Pronotal dorsum nearly glabrous, very sparse, short, erect and recumbent spine-like setae; lateral surface with sparse, erect to recumbent setae; setal tracts on anterior lobe very reduced. Pleura with sparse, erect setae and moderately dense, recumbent setae. Abdomen with sparse, short, semi-erect or recumbent setae, intermixed with few longer setae. Pygophore with sparse, short to long, semi-erect or erect setae.; Paramere apical half with dense, long setae, more than 1/2 length of medial process. **STRUCTURE: Head:** Cylindrical, L/W = 2.39. Postocular lobe long; in dorsal view distinctly narrowing through anterior 2/3, posterior 1/3 constant, tube-like. Eye prominent; lateral margin much wider than postocular lobe; dorsal margin removed from postocular transverse groove, ventral margins attaining ventral surface of head in lateral view. **Labium:** I: II: III = 1: 1.9: 0.3. Basiflagellomere diameter larger than that of pedicel. **Thorax:** Antero-lateral angle

bearing small projection; medial longitudinal sulcus shallow near collar, deepening posteriorly. Posterior pronotal lobe with rugulose surface; disc distinctly elevated above humeral angle; humeral angle armed, with dentate or spinous process. Scutellum moderately long; apex angulate, very slightly projected upward. *Legs*: Very slender. *Hemelytron*: Surpassing apex of abdomen by about length of abdominal segment 7; quadrate cell small, relatively broad; Cu and M of cubital cell subparallel. **GENITALIA**: *Pygophore*: Ovoid; mid-lateral fold adjacent to paramere insertion inconspicuous; not expanded laterally in dorsal view. Medial process expanded laterally; rather broad; long; antero-posteriorly compressed; erect; straight; apex in posterior view rounded, subapical transverse hook-like bridge. *Paramere*: Cylindrical; long, surpassing medial process; curved ventrad at mid-point, apex recurved. *Phallus*: Dorsal phallothecal sclerite shield-shaped, sclerite absent laterad to basal arms; lateral longitudinal blade-like heavy sclerotization, pressed against phallothecal sclerite, reaching apical margin; area between these raised; apical portion of phallothecal sclerite not distinctly tapered, flat, lateral margin narrowly angulate, angulation ending anteriorly in sharp, dorsad projection; apex with small medial emargination; proximal edge inversely V-shaped. Struts attached to dorsal phallothecal sclerite; apically separate, connected by bridge; basally separate. Basal plate arm robust; basally fused; in lateral view strongly curved at midpoint; bridge extremely short; extension of basal plate expanded onto arm.

*FEMALE*: Similar to male, except for the following. Larger than male, total length 15.02. Spinous process on humeral angle long.

ETYMOLOGY: The species epithet refers to the rather broad medial process.

DISTRIBUTION: South America.

PARATYPES: **BRAZIL: Rondonia:** 62 km SW of Ariquemes, near Fzda. Rancho Grande, 10.32921°S 63.46881°W, 30 Mar 1992 – 10 Apr 1992, J. E. Eger, 1;m (UCR\_ENT 00029302) (USNM). **COLOMBIA: Caqueta:** Valparaiso, Vda. Palastina Fca. La Ilusion, 1.18333°N 75.7°W, 225 m, 24 Jan 1997, G. Zambrano, 1;m (UCR\_ENT 00025329) (UNAB). **Meta:** San Martin: Reserva Natural El Caduceo, 3.66593°N 73.65773°W, 380 m, 21 Oct 2010 – 23 Oct 2010, G. Zhang & J. Avendaño, 1;m (UCR\_ENT 00004997) (UCR). **Vaupes:** Mitu, 1.1983°N 70.1733°W, 184 m, 06 Jul 1990 – 17 Jul 1990, L. E. Peña, 1;m (UCR\_ENT 00029305) (USNM). **ECUADOR: Orellana:** Reserva Etnica Waorani, 1 km S. Onkone Gare Camp, Transect Ent., 0.65713°S 76.453°W, 216 m, 10 Feb 1995, T. L. Erwin et al., 1;m (UCR\_ENT 00009475) (USNM); 26 Jun 1996, T. L. Erwin et al., 1;m (UCR\_ENT 00009479) (USNM); 02 Oct 1996, T. L. Erwin et al., 2;m (UCR\_ENT 00009476, UCR\_ENT 00009477) (USNM). **PERU: Ucayali:** Porvenir, Pulcal[ ]pa, 8.3825°S 74.5381°W, 158 m, Jul 1992, Unknown, 1;m (UCR\_ENT 00029304) (USNM).

***Zelus russulumus* sp. nov.** Figs 4.8, 4.18, 4.36.

HOLOTYPE: **BRAZIL: Amazonas:** Manacapuru, 1928, S.M. Klages, 1;m (UCR\_ENT 00069895) (KU).

DIAGNOSIS: The dorsal coloration nearly uniformly dark brown; the membrane with indistinct iridescence. Most similar to *Z. erythrocephalus* and *Z. paracephalus*; can be distinguished by the medial process of medium width, wider than in *Z. erythrocephalus*. and narrower than *Z. paracephalus*.

DESCRIPTION: **MALE:** Medium-sized, total length 12.21–13.94 (mean 13.14, Table 4.2); slender. **COLORATION:** Head reddish brown, anterior to antennal insertion and

posterior third of postocular lobe lighter. Rest of surface of body nearly uniformly blackish brown, area around humeral angle lighter, somewhat reddish. Membrane with blue, purple iridescence. **VESTITURE:** Sparsely setose. Dark, moderately dense, short, etc, spine-like setae on dorsum of head, some curved on postocular lobe; ventral surface with sparse, short, erect and recumbent setae, few long setae. Pronotal dorsum nearly glabrous, very sparse, short, erect and recumbent spine-like setae; lateral surface with sparse, erect to recumbent, spine-like setae; setal tracts on anterior lobe very reduced. Pleura with sparse, erect setae and moderately dense, recumbent setae. Abdomen with sparse, short, semi-erect or recumbent setae, intermixed with few longer setae. Pygophore with sparse, short to long, semi-erect or erect setae.; Paramere apical half with dense, long setae, nearly as long as medial process. **STRUCTURE: Head:** Cylindrical, L/W = 2.21. Postocular lobe long; in dorsal view distinctly narrowing through anterior 2/3, posterior 1/3 constant, tube-like. Eye prominent; lateral margin much wider than postocular lobe; dorsal margin removed from postocular transverse groove, ventral margins attaining ventral surface of head in lateral view. *Labium:* I: II: III = 1: 2.0: 0.5. Basiflagellomere diameter larger than that of pedicel. **Thorax:** Antero-lateral angle bearing small projection; medial longitudinal sulcus shallow near collar, deepening posteriorly. Posterior pronotal lobe with rugulose surface; disc distinctly elevated above humeral angle; humeral angle armed, with dentate or spinous process. Scutellum moderately long; apex angulate, very slightly projected upward. *Legs:* Very slender. *Hemelytron:* Surpassing apex of abdomen by about length of abdominal segment 7; quadrate cell small, relatively broad; Cu and M of cubital cell subparallel. **GENITALIA:** *Pygophore:* Ovoid; mid-lateral fold adjacent to paramere insertion inconspicuous; not expanded laterally in dorsal view. Medial process expanded laterally; broad; long;

antero-posteriorly compressed; erect; straight; apex in posterior view rounded, subapical transverse hook-like bridge. *Paramere*: Cylindrical; long, surpassing medial process; curved ventrad at mid-point, apex recurved. *Phallus*: Dorsal phallothecal sclerite shield-shaped, sclerite absent laterad to basal arms; lateral longitudinal blade-like heavy sclerotization, pressed against phallothecal sclerite, reaching apical margin; area between these raised; apical portion of phallothecal sclerite not distinctly tapered, slightly convex, lateral margin narrowly angulate, angulation ending anteriorly in sharp, dorsad projection; apex with small medial emargination; proximal edge broadly concave. Struts attached to dorsal phallothecal sclerite; apically separate, connected by bridge; basally separate throughout. Basal plate arm robust; basally fused; in lateral view strongly curved at midpoint; bridge extremely short; extension of basal plate expanded onto arm.

*FEMALE*: Similar to male, except for the following. Larger than male, total length 17.52–19.39 (mean 18.23, Table 4.2). Spinous process on humeral angle long.

ETYMOLOGY: Referring to the reddish brown area on the membrane in the female.

DISTRIBUTION: South America.

PARATYPES: **BRAZIL: Goias:** Campinas, 16.66785°S 49.29149°W, 2.1.936, Borgmeier and S. Lopes, 1;m (UCR\_ENT 00071254) (TAMU). **Rondonia:** 62 km S Ariquemes, Fazenda Rancho Grande, 10.29801°S 62.86806°W, 187 m, 06 Dec 1990 – 15 Dec 1990, D. A. Rider and J. E. Eger, 1;m (UCR\_ENT 00071241) (TAMU). 62 km S Ariquemes, Fazenda Rancho Grande, 10.3°S 62.86666°W, 300 m, 30 Mar 1992 – 10 Apr 1992, J. E. Eger, 2;m (UCR\_ENT 00009464, UCR\_ENT 00009465), 1;f (UCR\_ENT 00009467) (USNM); 03 Dec 1996 – 15 Dec 1996, J. E. Eger, 1;m (UCR\_ENT 00009466), 1;f (UCR\_ENT 00009468) (USNM); 04 Nov 1997 – 16 Nov 1997, J. E. Eger, 3;f (UCR\_ENT 00009469-UCR\_ENT 00009471) (USNM). 62 km S Ariquemes, RO

Fazenda Rancho Grande, 10.46581°S 63.0996°W, 25 Nov 1991, S.L. Heydon, 1;m (UCR\_ENT 00037215) (UCD). 62 km SW of Ariquemes, near Fzda. Rancho Grande, 10.32921°S 63.46881°W, 30 Mar 1992 – 10 Apr 1992, J. E. Eger, 2;m (UCR\_ENT 00029301, UCR\_ENT 00029303) (USNM). **BOLIVIA: Pando:** Cachuela Esperanza, 10.5375°S 65.5815°W, 01 Jan 1700, W. M. Mann, 1;f (UCR\_ENT 00029293) (USNM). **COLOMBIA: Vaupes:** Mitu, 1.1983°N 70.1733°W, 184 m, 06 Jul 1990 – 17 Jul 1990, L. E. Peña, 1;f (UCR\_ENT 00029306) (USNM). **ECUADOR: Napo:** Rio Blanco Ecological Reserve, 6 km E Puerto Misahuali, along Rio Napo, 1.05037°S 77.62705°W, 518 m, 07 Sep 1998, J. E. Eger, 1;f (UCR\_ENT 00009501) (USNM).

***Zelus versicolor* (Herrich-Schäffer, 1848)** Figs 4.8, 4.17, 4.36.

HOLOTYPE: Destroyed. See 'Discussion'.

*Euaqoras versicolor* Herrich-Schaeffer, 1848, p. 46-47, Tab. CCLXIV, fig. 820, orig. descr. and fig.; Herrich-Schaeffer, 1853, p. 92, cat.

*Zelus versicolor*, Stål, 1872, p. 92, cat. (subgenus *Diplodus*); Lethierry and Severin, 1896, p. 153, cat.; Wygodzinsky, 1949a, p. 50, checklist.

*Euaqoras nigrispinus* Herrich-Schaeffer, 1848, p. 47-48, Tab. CCLXII, fig. 816, orig. descr. and fig. (NEW SYNONYMY); Herrich-Schaeffer, 1853, p. 92, cat.

*Zelus nigrispinus*, Stål, 1872, p. 91, cat. (subgenus *Diplodus*); Lethierry and Severin, 1896, p. 152, cat.; Wygodzinsky, 1949a, p. 49, checklist.

*Zelus personatus* Berg, 1879, p. 150-151, orig. descr. (subgenus *Zelus*) (**syn. nov.**); Lethierry and Severin, 1896, p. 153, cat.; Wygodzinsky, 1949a, p. 50, checklist; Wygodzinsky, 1957, p. 264, 268-269, list and note.

Identifications not verified:

*Diplodus versicolor*, Stål, 1860, p. 75, cat.

*Zelus versicolor*, Stål, 1862, p. 451, note.

*Euaqoras versicolor*, Walker, 1873, p. 118, note.

*Diplodus niqrispinus*, Stål, 1860, p. 75, cat.; Stål, 1868, p. 109, note; Walker, 1873, p. 126, cat.

*Zelus niqrispinus*, Mayr, 1866, p. 139, cat.; Berg, 1879, p. 154.

**DIAGNOSIS:** The posterior pronotal lobe usually lighter than the anterior pronotal lobe, orangish or reddish brown; the paramere somewhat duck-shaped, basally constricted, curved towards medial process; the medial process triangular, apex hook-like, hook cleft in middle, creating two lateral projections; the dorsal phallosomal sclerite with submedial ridge-like dorsad projection continuous from basal arm; and the basal plate arms subparallel and strongly curved. In female the posterior pronotal lobe often bicolorous, anterior portion yellowish and posterior portion brown.

**DESCRIPTION:** *MALE:* Medium-sized, total length 11.59–12.94 (mean 12.26, Table 4.2); slender. **COLORATION:** Dark brown to brownish black. Head ventrally yellowish to pale brown, light color rarely dominant on dorsal surface; postocular lobe with light medial longitudinal line. Posterior pronotal lobe lighter colored than anterior lobe, sometimes reddish or orangish brown. Pleura with patches of brown and yellow colors. Fore femur, fore and mid tibiae not banded; mid femur occasionally with subapical or (and) basal short light colored band; hind femur sometimes with three short yellowish and three longer darker bands, light and dark bands alternate, but some individuals with just single subapical or basal light band; hind tibia sometimes slightly paler medially. Abdomen usually light colored. **VESTITURE:** Sparsely setose. Dorsum of head, entire surface of pronotum and pleura with short, spine-like setae and recumbent setae; ventral



surfaces of head and abdomen with short, recumbent and relatively long, erect setae. Setal tracts on anterior pronotal lobe indistinct. Dense, moderately long, erect setae on dorsal surface of paramere. Head pubescence sparse, of mostly recumbent setae intermixed with short sparse erect setae. Dorsal surface of anterior pronotal lobe covered densely with short, erect, somewhat stout setae; posterior lobe covered densely with short, erect, somewhat stout setae; scutellum with recumbent setae interspersed with short to long, sparse, semierect to erect setae. Corium and clavus with short, recumbent setae. Abdomen with short, recumbent setae intermixed with short to long, erect setae. Ventrally exposed surface of pygophore with dense, short to long, semierect to erect setae; parameres with dense long erect setae over enlarged surface, sparse and shorter ventrally. **STRUCTURE: Head:** Cylindrical, L/W = 2.37. Postocular lobe long; in dorsal view distinctly narrowing through anterior 2/3, posterior 1/3 constant, tube-like. Eye prominent; lateral margin much wider than postocular lobe; margins removed from dorsal and ventral surfaces of head in lateral view. *Labium:* I: II: III = 1: 2.0: 0.4. Basiflagellomere diameter slightly larger than that of pedicel. **Thorax:** Antero-lateral angle rounded, without projection; medial longitudinal sulcus shallow near collar, deepening posteriorly. Posterior pronotal lobe with rugulose surface; disc about same level as humeral angle; humeral angle armed, with dentate projection. Scutellum moderately long; apex angulate, slightly projected upward in some specimens. *Legs:* Slender. *Hemelytron:* Slightly surpassing apex of abdomen, not more than length of abdominal segment 7; quadrate cell small; Cu and M of cubital cell subparallel. **GENITALIA: Pygophore:** Ovoid; expanded laterally near base of paramere in dorsal view. Medial process triangular; long; antero-posteriorly compressed; erect; basally without protrusion; apex in posterior view acute, subapical transverse hook-like bridge,

sharp lateral process. *Paramere*: Somewhat sickle-shaped; moderately long, slightly exceeding medial process; directed toward medial process; basally constricted; slightly curved ventrad; apical part enlarged. *Phallus*: Dorsal phallosomal sclerite somewhat squarish; lateral small blade-like heavy sclerotization continuous from basal arm; apical portion of phallosomal sclerite not distinctly tapered, laterally indistinctly angulate, angulation anteriorly connected with membranous, dorsad expansion; apex rounded, medially emarginate; proximal edge broadly concave. Struts attached to dorsal phallosomal sclerite; apically separate, connected by bridge; basally mostly separate, moderately fused. Basal plate arm moderately robust; separate; subparallel; in lateral view severely curved, nearly semi-circular; bridge long; extension of basal plate expanded onto arm.

*FEMALE*: Similar to male, except for the following. Larger than male, total length 14.43–15.84 (mean 15.01, Table 4.2). Dorsum dark brown, a large number of specimens with anterior 1/2 of posterior pronotal lobe yellow and some also with entire anterior pronotal lobe yellow; lateral surface and abdomen yellowish. Hemelytron attaining apex of abdomen.

*DISTRIBUTION*: South America.

*DISCUSSION*: The type specimens of *Zelus versicolor* and *Zelus niqrispinus* were destroyed during World War II. The male holotype of *Zelus personatus* is deposited in the Universidad Nacional de La Plata, La Plata, Argentina, and bears the following labels: Typus / Misiones / *Zelus personatus* Berg / *Zelus personatus* Berg, Wygodzinsky det. / 1555. Sexual dimorphism in size and coloration is marked in this species. Association between the sexes is based on two lines of evidence: several series contain both sexes and Gil-Santana (2008) observed mating in the wild that led to viable eggs. It

was also based this observation that Gil-Santana synonymized *Zelus nigrispinus* (Herrich-Schäffer), originally described from female specimens with *Zelus versicolor*, originally described from male specimens. As may be seen by a comparison of the figures, the triangular medial process with the hooklike structure removed from the apex, the enlargement of the parameres, and the bladelike processes on the dorsal phallosomal sclerite definitely mark this species as a member of this group. The form of these structures may readily be used to separate the males of this species from those of other species. The posterior pronotal lobe being light-colored on the anterior 1/2 and dark-colored on the posterior 1/2 should separate the females from those of most species. The long erect setae on the dorsal surface of the posterior pronotal lobe will separate the females from those species with similar coloration. The original drawings from Herrich-Schaeffer (1848) are accurate and may be useful for identification purposes.

***Zelus fasciatus* Champion, 1899** Figs 4.8, 4.38.

HOLOTYPE: **PANAMA: Chiriqui:** Bugaba, 8.4833°N 82.6167°W, 457 m, No date provided, G.C. Champion, 1;f (UCR\_ENT 00048758) (BMNH).

*Zelus fasciatus* Champion, 1899, p. 257, Tab. XV. fig. 18, orig. descr. and fig.; Kuhlitz, 1902, p. 266, note; Wygodzinsky, 1949a, p. 49, checklist.

DIAGNOSIS: The rather unique coloration easily distinguishes this species from all other species in the genus.

DESCRIPTION: *MALE*: unknown.

*FEMALE*: Medium-sized, total length 14.92–15.56 (mean 15.25, Table 4.2); slender. **COLORATION**: Yellow and black. Yellow areas usually on posterior pronotal

lobe, corium, lateral surfaces and abdomen. **VESTITURE:** Sparsely setose. Antecular lobe with short, erect and recumbent setae; postocular lobe with short, erect and recumbent setae. Anterior pronotal lobe with short, inconspicuous, recumbent setae dorsally, some short to moderate, erect setae laterally; posterior pronotal lobe with short, inconspicuous, erect and recumbent setae. Abdomen with short to moderate long, erect setae and inconspicuous, short, recumbent setae. **STRUCTURE: Head:** Cylindrical, L/W = 2.46. Postocular lobe very long; in dorsal view distinctly narrowing through anterior 1/2, posterior 1/2 constant, tube-like. Eye moderately sized; lateral margin much wider than postocular lobe; margins removed from dorsal and ventral surfaces of head in lateral view. *Labium:* I: II: III = 1: 2.0: 0.3. **Thorax:** Antero-lateral angle rounded, without projection; medial longitudinal sulcus distinct throughout. Posterior pronotal lobe with finely rugulose surface; disc distinctly elevated above humeral angle; humeral angle armed, with spinous processes. Scutellum long; apex angulate. *Legs:* Slender. *Hemelytron:* Slightly surpassing apex of abdomen, not more than length of abdominal segment 7; quadrate cell moderately sized; Cu and M of cubital cell subparallel.

**DISTRIBUTION:** Southern Central America, northern South America.

**DISCUSSION:** This species is only known from female specimens. Despite the relatively large number of specimens found in collections, no male could be associated with *Z. fasciatus*. The features of vestiture, the rather long postocular region and the rounded posterior margin of the posterior pronotal lobe suggest *Z. fasciatus* possibly belongs to the *panamensis* group. Further, its distribution range in southern Central America and Northern South America coincides with that of many species in the *panamensis* group too.

***Zelus plagiatus* (Signoret, 1862)** Figs 4.8, 4.38.

HOLOTYPE: **PERU**, No date provided, Signoret, 1;f (UCR\_ENT 00075076)  
(NHMW).

*Diplodus plagiatus* Signoret, 1862, p. 584–585, orig. descr.

*Zelus plagiatus*, Stål, 1872, p. 92, cat.; Lethierry and Severin, 1896, p. 153, cat.;

Wygodzinsky, 1949a, p. 50, checklist.

Identifications not verified:

*Diplodus plagiatus*, Walker, 1873, p. 126, cat.

**DIAGNOSIS:** The yellow coloration with two black spots on hemelytron is most distinctive of this species.

**DESCRIPTION:** *MALE:* unknown.

*FEMALE:* Medium-sized, total length 13.20–15.43 (mean 14.32, Table 4.2); slender. **COLORATION:** Brightly colored. Yellow and black. Dorsal surface mostly yellow, black patch on distal area of corium, posterior part of posterior pronotal lobe black; legs mostly black, femoral base yellowish, single yellowish subapical band on metafemur. **VESTITURE:** Sparsely setose. Head with short, to moderate length, erect and recumbent setae, scattered. Anterior pronotal lobe with short, erect and recumbent setae; posterior pronotal lobe with short, erect setae. Abdomen with short to moderate length erect setae. **STRUCTURE: Head:** Elongated, L/W = 2.69. Postocular lobe very long; in dorsal view distinctly narrowing through anterior 1/2, posterior 1/2 constant, tube-like. Eye moderately sized; lateral margin much wider than postocular lobe; margins removed from dorsal and ventral surfaces of head in lateral view. *Labium:* I: II: III = 1: 2.1: 0.5. **Thorax:** Antero-lateral angle rounded, without projection; medial longitudinal sulcus shallow near collar, deepening posteriorly. Posterior pronotal lobe

with finely rugulose surface; disc distinctly elevated above humeral angle; humeral angle armed, with spinous processes. Scutellum long; apex angulate. *Legs*: Slender.

*Hemelytron*: Slightly surpassing apex of abdomen, not more than length of abdominal segment 7; quadrate cell moderately sized; Cu and M of cubital cell subparallel.

DISTRIBUTION: South America.

DISCUSSION: *Zelus plagiatus* resembles the female of *Z. versicolor* in coloration, but has the distal dark brow patch on the corium. This species has a rather large distribution range, but shows strikingly little variation in coloration.

***Zelus spehegeus* Fabricius, 1803** Figs 4.8, 4.38.

*Zelus spehegeus* Fabricius, 1803, p. 287, orig. descr.; Stål, 1872, p. 91, cat.; Lethierry and Severin, 1896, p. 153, cat.; Wygodzinsky, 1949a, p. 50, checklist.

*Diplodus spehegeus*, Stål, 1868, p. 109, descr.

Identifications not verified:

*Diplodus spehegeus*, Walker, 1873, p. 125, cat.

*Zelus spehegeus*, Haviland, 1931, p. 137, 153, list and note.

DIAGNOSIS: This species can be recognized by the posterior pronotal lobe bicolorous, anteriorly yellowish and posteriorly dark; the humeral angle with long spinous process.

DESCRIPTION: *MALE*: unknown.

*FEMALE*: Medium-sized, total length 14.18–14.95 (mean 14.57, Table 4.2); slender. **COLORATION**: Most of dorsal surface brown, anterior pronotal lobe yellowish.

**VESTITURE**: Sparsely setose. Head with inconspicuous, short, erect and recumbent setae, more dense dorsally, some lightly larger erect setae ventrally. Anterior pronotal

lobe with short, erect and recumbent setae; posterior pronotal lobe with short, erect and recumbent setae. Abdomen with short, erect and recumbent setae. **STRUCTURE:**  
**Head:** Cylindrical, L/W = 2.34. Postocular lobe very long; in dorsal view distinctly narrowing through anterior 1/2, posterior 1/2 constant, tube-like. Eye smallish; lateral margin only slightly wider, roughly on line with margin of postocular lobe; margins removed from dorsal and ventral surfaces of head in lateral view. *Labium:* I: II: III = 1: 2.3: 0.5. **Thorax:** Antero-lateral angle rounded, without projection; medial longitudinal sulcus shallow near collar, deepening posteriorly. Posterior pronotal lobe with finely rugulose surface; disc distinctly elevated above humeral angle; humeral angle armed, with spinous processes. Scutellum moderately long; apex angulate. *Legs:* Slender. *Hemelytron:* Slightly surpassing apex of abdomen, not more than length of abdominal segment 7; quadrate cell moderately sized; Cu and M of cubital cell subparallel.

DISTRIBUTION: South America.

DISCUSSION: *Zelus sphegeus* is only known from female specimens. The coloration pattern is close to that of several species in the *panamensis* group, such as *Z. gilboventris*, *Z. truxali* and *Z. cordazulus*.

## References

- Ables, J. R., 1978. Feeding behavior of an assassin bug, *Zelus renardii*. *Annals of the Entomological Society of America*, 71, 476-478.
- Ali, A. S. A. and Watson, T. F. 1978. Effect of temperature on development and survival of *Zelus renardii*. *Environmental Entomology*, 7, 889-890.
- Amyot, C. J. B. and Serville, J. G. A. 1843. Histoire naturelle des insectes. Hemipteres. Fain et Thunot, Paris. lxxi +675 + 6 p., 12 pl.
- Berg, Carlos. 1897. Hemiptera Argentina enumeravit speciesque novas descripsit. Pauli E. Coni, Bonariae. 316 p.
- Blatchley, W. S. 1926. *Heteroptera or True Bugs of Eastern North America*. The Nature Publishing Company, Indianapolis. 1116 p., 215 fig., 12 pl.
- Blanchard, E. 1840. Histoire naturelle des insectes. 111. Orthopteres, Neuropteres, Hemipteres, Hymenopteres, kpidopteres et Dipteres. P. Dmeril, Paris. 672 p., 155 pl.
- Brulle, A. 1836. Histoire naturelle des insects (Coleopteres, Orthopteres et Hemipteres). I.X. F. D. Pillot, Paris. 415 p., 56 pl.
- Burmeister, H. 1835. Handbuch der Entomologie. 11. Theod. Ehr. Friedr. Enslin, Berlin. ii + 400 + 4 p., 2 pl. Cisneros & Rosenheim 1998,
- Champion, G. C. 1898. Insecta. Rhynchota. Hemiptera-Heteroptera. 11. In *Biologia Centrali-Americana*. London. 466 p., 22 pl.
- Cogni, R., A., Freitas, V. L. and Amaral Filho, B. F. 2002. Influence of prey size on predation success by *Zelus longipes* L. (Het., Reduviidae). *Journal of Applied Entomology*, 126, 74-78.
- Cohen, A. C. and Tang, R. 1997. Relative prey weight influences handling time and biomass extraction in *Sinea confusa* and *Zelus renardii* (Heteroptera: Reduviidae). *Environmental Entomology*, 26, 559-565.
- Curkovic, T., Araya, J. E., Baena, M., Guerrero, M.A. 2004. Presencia de *Zelus renardii* Kolenati (Heteroptera: Reduviidae) en Chile (Presence of *Zelus renardii* Kolenati (Heteroptera: Reduviidae) in Chile). *Boletín de la S.E.A. Guerrero*, 34, 163-165.
- Davis, N. T. 1966. Contributions to morphology and phylogeny of Reduvidae (Hemiptera - Heteroptera). Part III. The male and female genitalia. . *Annals of the Entomological Society of America*, 59, 911-924.



- Davranoglou, L. R. 2011. *Zelus renardii* (Kolenati, 1856), a New World reduviid discovered in Europe (Hemiptera: Reduviidae: Harpactorinae). *Entomological Magazine*, 147, 157-162.
- Dallwitz, M.J. 1980. A general system for coding taxonomic descriptions. *Taxon*, 29, 41-46.
- Dallwitz, M.J., Paine, T.A. and Zurcher, E.J. 1999 onwards. User's guide to the DELTA Editor. <http://delta-intkey.com>
- Elkins, J. C. 1954. A new American Harpactorine genus. *Texas Reports on Biology and Medicine*. 12, 39-48.
- Fabricius, J. C. 1775. *Systema entomologiae*. Korte, Flensburgi et Lipsiae. 832 p. Hagen et al., 1999
- Fabricius, J. C. 1803. *Systema Rhyngotorum secundum ordines, genera, species, adjectis synonymis, locis observationibus, descriptionibus*. Apud Carolum Reichard, Brunsvigae. vi + 314p.
- Fracker, S. B. 1913. A systematic outline of the Reduviidae of North America. *Proceedings of the Iowa Academy of Sciences*, 19, 217-252.
- Hart, E. R. 1972. *A Systematic Revision of the Genus Zelus Fabricius (Hemiptera: Reduviidae)*. Ph.D dissertation. Texas A&M University.
- Hart, E. R. 1986. Genus *Zelus* Fabricius in the United States, Canada, and Northern Mexico (Hemiptera: Reduviidae). *Annals of the Entomological Society of America*, 79, 535-548.
- Hart, E. R. 1987. The genus *Zelus* Fabricius in the West Indies (Hemiptera: Reduviidae). *Annals of the Entomological Society of America*, 80, 293-305.
- Herrich-Schaeffer, G. A. W. 1848. *Die Wanzenartigen Insekten*. Vol. 8. C. H. Zeh'schen Buchhandlung, Nurnberg.
- Herrich-Schaeffer, G. A. W. 1853. *Die Wanzenartigen Insekten*. Vol. 9. C. H. Zeh'schen Buchhandlung, Nurnberg.
- Kirkaldy, G. W. 1900a. On the nomenclature of the genera of the Rhynchota, Heteroptera and Auchenorrhynchos Homoptera, *Entomologist*. 33, 25-28, 262-265
- Kirkaldy, G. W. 1900b. Bibliographical and nomenclatorial notes on the Rhynchota. No. 1. *Entomologist*. 33: 238-243.
- Kirkaldy, G. W. 1901. On the nomenclature of the genera of the Rhynchota, Heteroptera and Auchenorrhynchos Homoptera (cont.). *Entomologist*. 34: 176-179, 218-219.

- Kirkaldy, G. W. 1902. Hemiptera. 2 Fauna Hawaiiensis. Vol. 3. Pt. 2. Cambridge University Press, London. p. 93-174, pl. 4-5.
- Kirkaldy, G. W. 1903a. On the nomenclature of the genera of the Rhynchota, Heteroptera and Auchenorrhyncha Homoptera (cont.). *Entomologist*. 36: 213-216, 230-233.
- Kirkaldy, G. W. 1903b. Miscellanea Rhynchota No. 7. *The Entomologist. An illustrated Journal of Entomology*, 36, 179-181.
- Kirkaldy, G. W. 1910. Supplement to Hemiptera, pp. 531-599 In D. Sharp [ed.], *Fauna Hawaiiensis*. Cambridge University Press, Cambridge.
- Laporte, F. L. de. 1832. Essai d'une classification systematique de l'ordre des Hemipteres (Hemipteres-Heteropteres, Latr.). *Mag. 2001. Paris*. 1: 1-88 + suppl.
- Le Peletier, A. L. M. and Serville, J. G. A. 1825. Histoire naturelle entomologie. Encycloped. method. Vol. 10. Mme. Veuve Agasse, Paris. 832 p.
- Linnaeus, C. 1767. *Systema Naturae*. Vol. 1. Editio Duodecima. Lurentii Salvii, Holmiae. 824 p.
- Maldonado, J. 1990. Systematic catalogue of the Reduviidae of the World. *Caribbean Journal of Science*, Special publication No. 1, University of Puerto Rico, Mayagüez, Puerto Rico, 694 pp.
- McPherson, R. M., Smith, J. C. and Allen, W. A. 1982. Incidence of arthropod predators in different soybean cropping systems. *Environmental Entomology*, 11, 685-689.
- Perty, M. 1834. *Delectus animalium articulorum*. Autor, Munich. p. 125-224.
- Provancher, L. 1872. Description de plusieurs Hemipteres nouveaux. *Naturaliste Canada*, 4, 103-108.
- Readio, P. A. 1927. Studies on the biology of the Reduviidae of America north of Mexico. *University of Kansas Science Bulletin* 17, 5-291, 21 pl.
- Schuh, R. T. 2012. Integrating specimen databases and revisionary systematics. In: Blagoderov V, Smith VS. (Ed). No specimen left behind: mass digitization of natural history collections. *ZooKeys* 209, 255-267.
- Signoret, V. 1862. Description d'Hemipteres nouveaux de Jurimagnas et Moyabamba (Perou). *Annales de la Société Entomologique de France* 4, 579-588, pl. 15.
- Stål, C. 1860. Bidrag till Rio Janeior-traktens hemipter-fauna. I. K. Svenska Vetensk. Akad. 2(7): 1-84.

- Stål, C. 1861. *Miscellanea hemipterologica*. Ent. Zt. Stettin. 22: 129-153.
- Stål, C. 1862. *Hemiptera mexicana enumeravit speciesque novas descripsit* (continuation). Ent. Zt. Stettin. 23, 437-462.
- Stål, C. 1866. *Bidrag till Reduviidernas kaennedom*. Ofvers. K. Vetensk. Akad. Forhandl. 23, 235-302.
- Stål, C. 1872. *Enumeratio Reduviinom Americae*. In *Enumeratio Hemipterorum*. 11. I. K. Svenska Vetensk. Akad. 10, 66-128.
- Uhler, P. R. 1872a. A list of Hemiptera collected in eastern Colorado and northeastern New Mexico, by C. Thomas, during the expedition of 1869. In *U. S. geol. Surv. Wyoming*. p. 471-472.
- Uhler, P. R. 1872b. *Notices of the Hemiptera of the western territories of the United States, chiefly from the surveys of Dr. F. V.*
- Weirauch, C. 2008. Cladistic analysis of Reduviidae (Heteroptera: Cimicomorpha) based on morphological characters. *Systematic Entomology*, 33, 229-274.
- Wygodzinsky, P. 1949a. *Elenco sistematico do 10s Reduviiformes americanos*. *Monogr. Inst. Med. Regional*, 1, 1-102.
- Zimmermann, E. C. 1948. *Insects of Hawaii*. Volume 3, Heteroptera. Hawaii: University of Hawaii Press. 265 pp.
- Zayas, F. de. 1960. *Nueva especie de Reduvido Cubano*. *Mem. Soc. Cubana Hist. Nat.* 24, 125-127.



Figure 4.1. Habitus images of *Zelus minutus* Hart 1987, *Zelus prolixus* Stål, 1860, *Zelus rosulentus* **sp. nov.** and *Zelus tetracanthus* Stål, 1862, *Zelus ambulans* Stål, 1862, *Zelus antiguensis* **sp. nov.**, *Zelus exsanguis* Stål, 1862, *Zelus grandoculus* **sp. nov.**, *Zelus luridus* Stål, 1862 and *Zelus spatulosus* **sp. nov.**

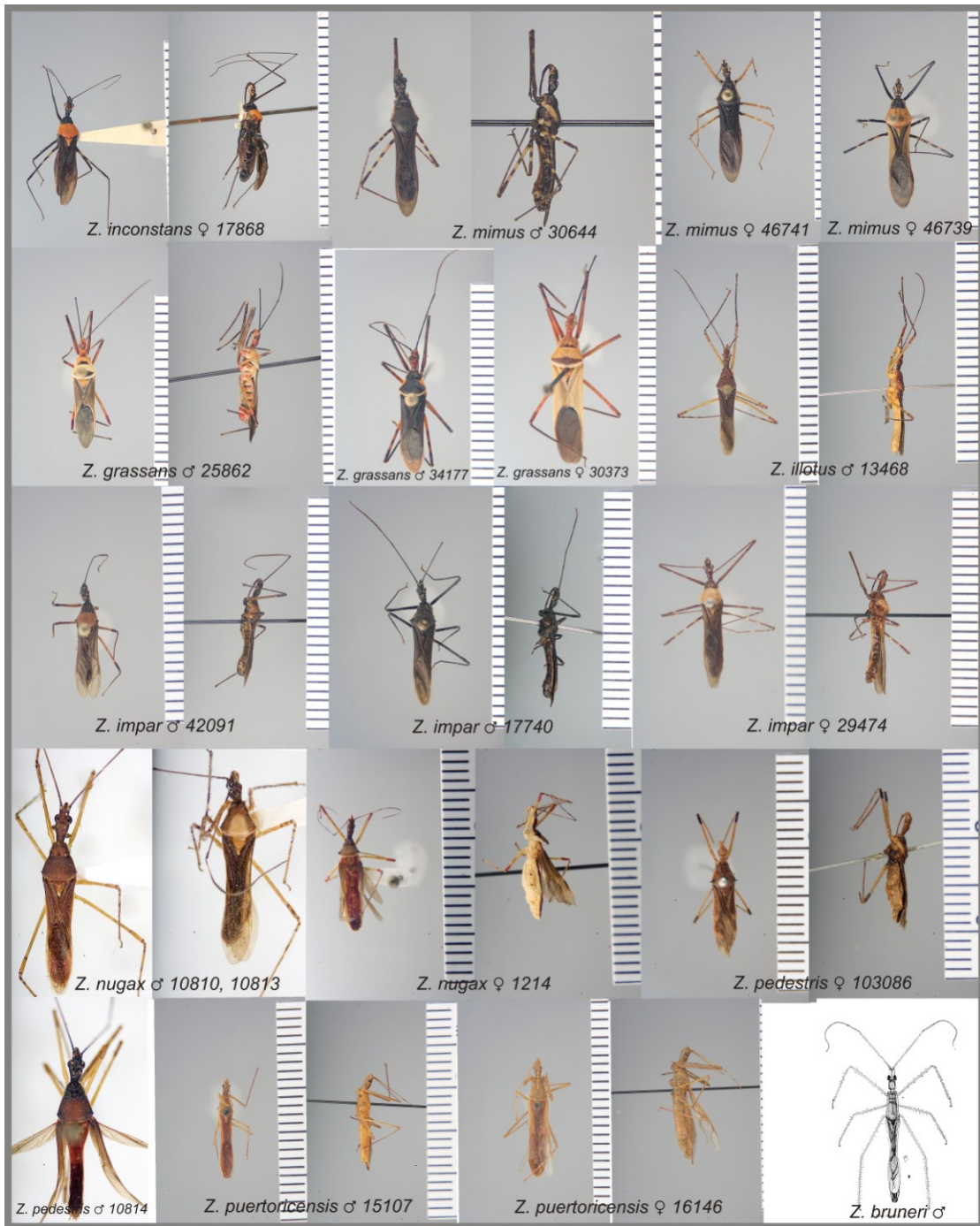

Figure 4.2. Habitus images of 1987, *Zelus inconstans* Champion, 1898, *Zelus mimus* Stål 1862, *Zelus grassans* Stål, 1862, *Zelus illotus* Berg, 1879, *Zelus impar* Kuhlitz, 1902, *Zelus nugax* Stål, 1862 and *Zelus pedestris* Fabricius, 1803, *Zelus puertoricensis* Hart and *Zelus bruneri* De Zayas, 1960.

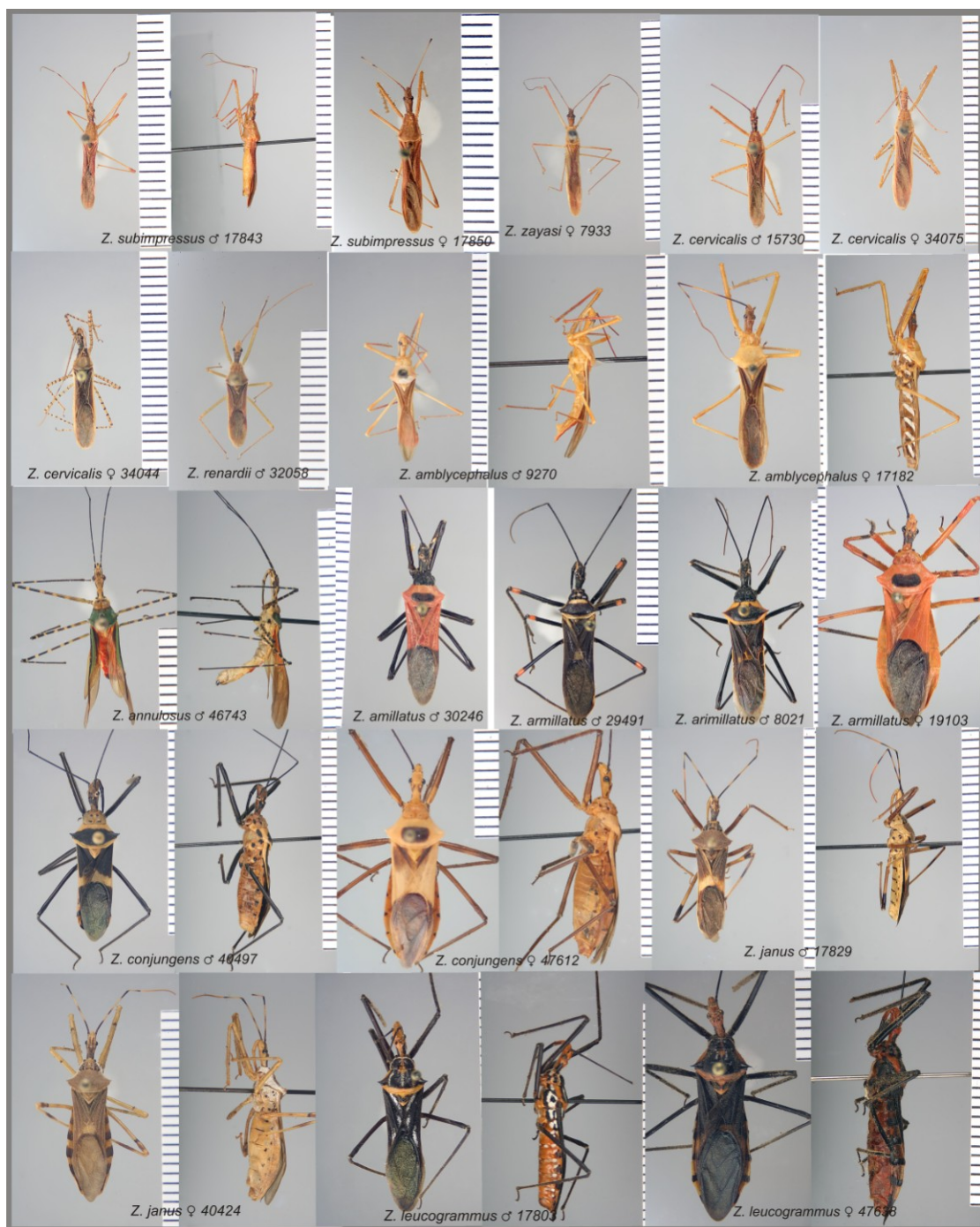

Figure 4.3. Habitus images of *Zelus subimpressus* Stål, 1872, *Zelus cervicalis* Stål, 1872 and *Zelus renardii* Kolenati, 1856, *Zelus amblycephalus* **sp. nov.**, *Zelus annulosus* (Stål, 1866), *Zelus armillatus* (Lepeletier & Serville, 1825), *Zelus conjungens* (Stål, 1860), *Zelus janus* Stål, 1862 and *Zelus leucogrammus* (Perty, 1833).

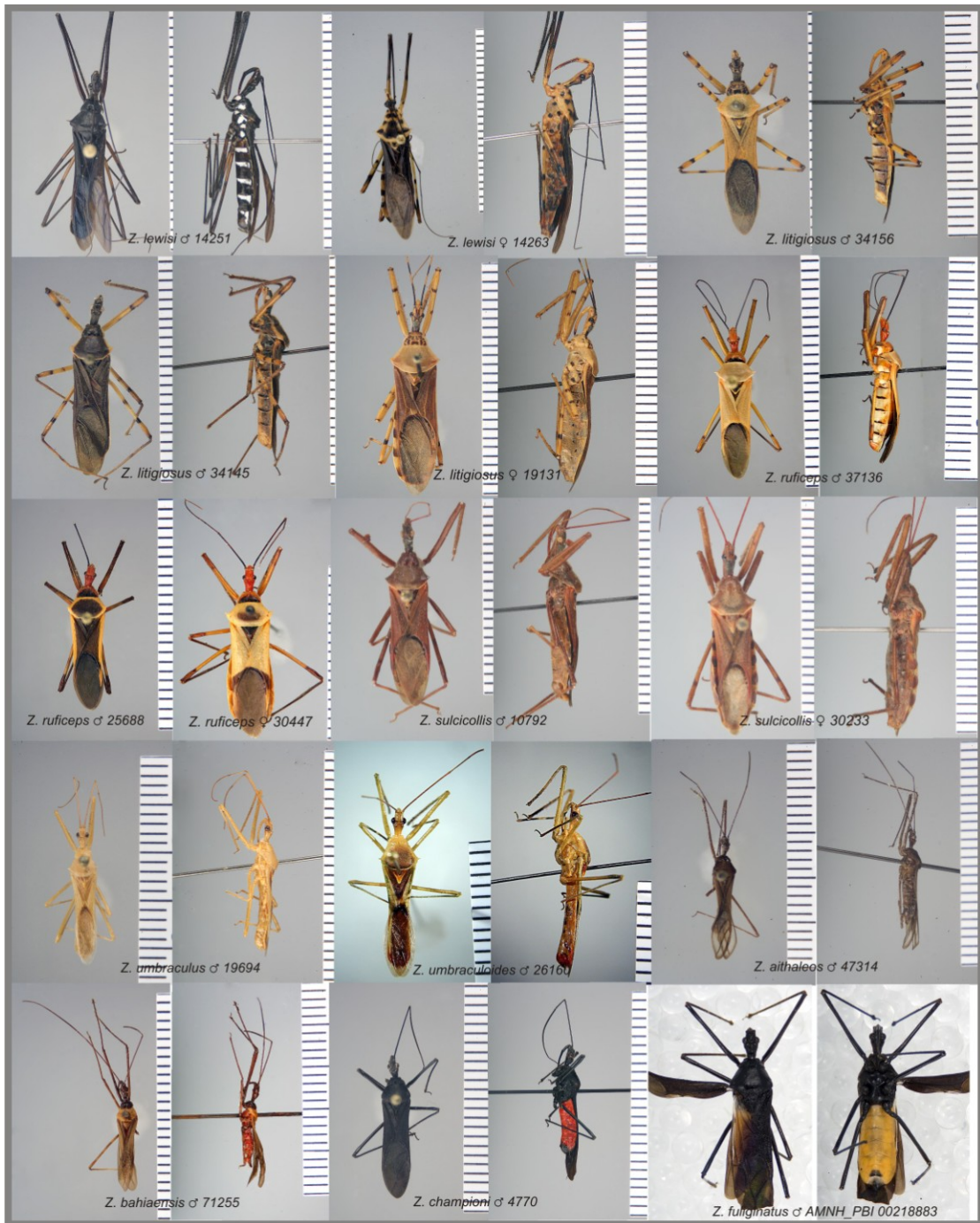

Figure 4.4. Habitus images of *Zelus lewisi* **sp. nov.**, *Zelus litigiosus* Stål, 1862, *Zelus ruficeps*, *Zelus sulcicollis* Champion, 1899, *Zelus umbraculoides* **sp. nov.**, *Zelus umbraculus* **sp. nov.**, *Zelus aithaleos* **sp. nov.**, *Zelus bahiaensis* **sp. nov.**, *Zelus champi* **sp. nov.** and 1803 and *Zelus fuliginatus* **sp. nov.**

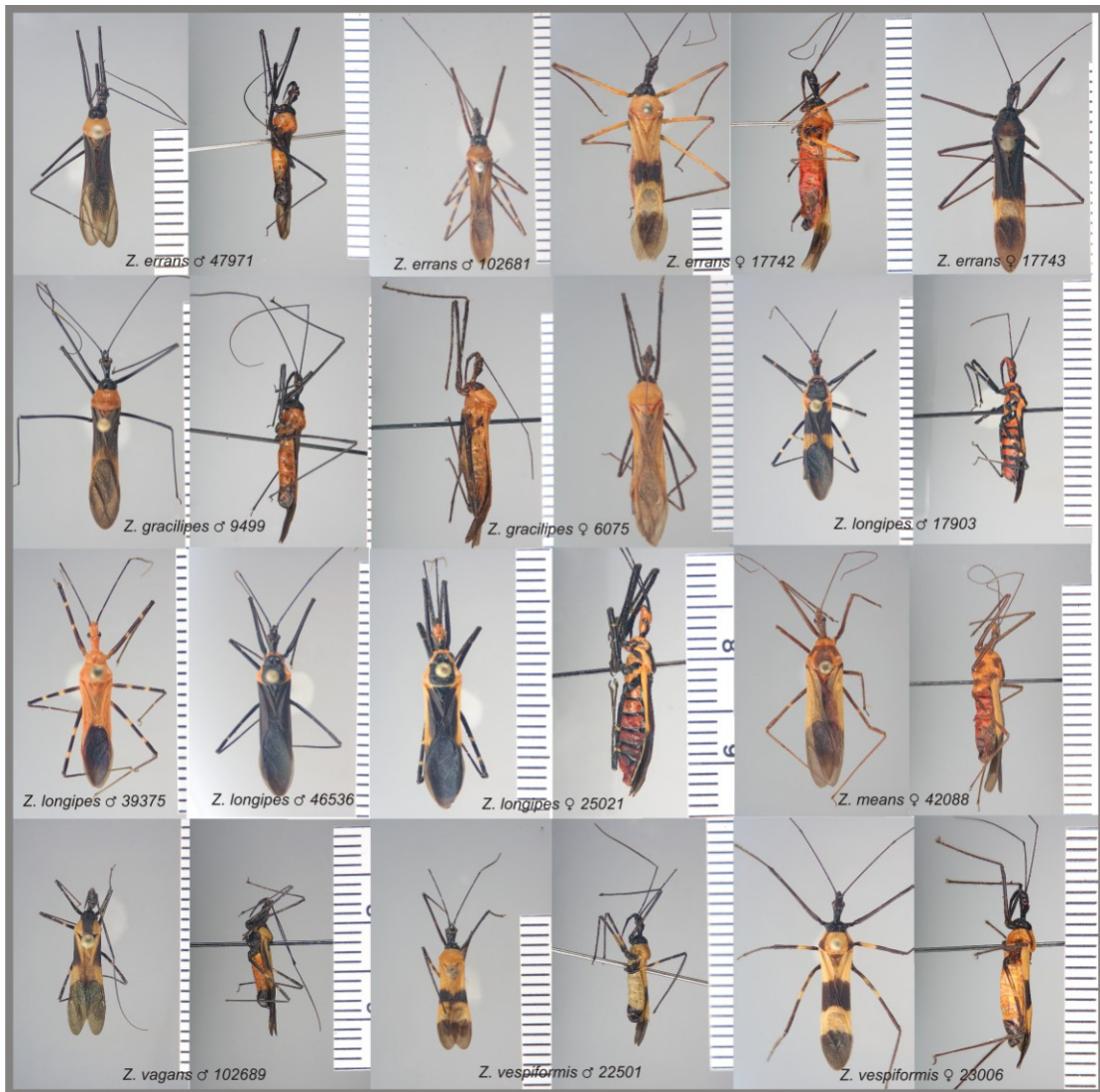

Figure 4.5. Habitus images of *Zelus errans* Fabricius, 1803, *Zelus gracilipes* **sp. nov.**, *Zelus longipes* (Linnaeus, 1767), *Zelus means* Fabricius, 1803, *Zelus vagans* Fabricius, 1803 and *Zelus vespiformis* Hart, 1987.



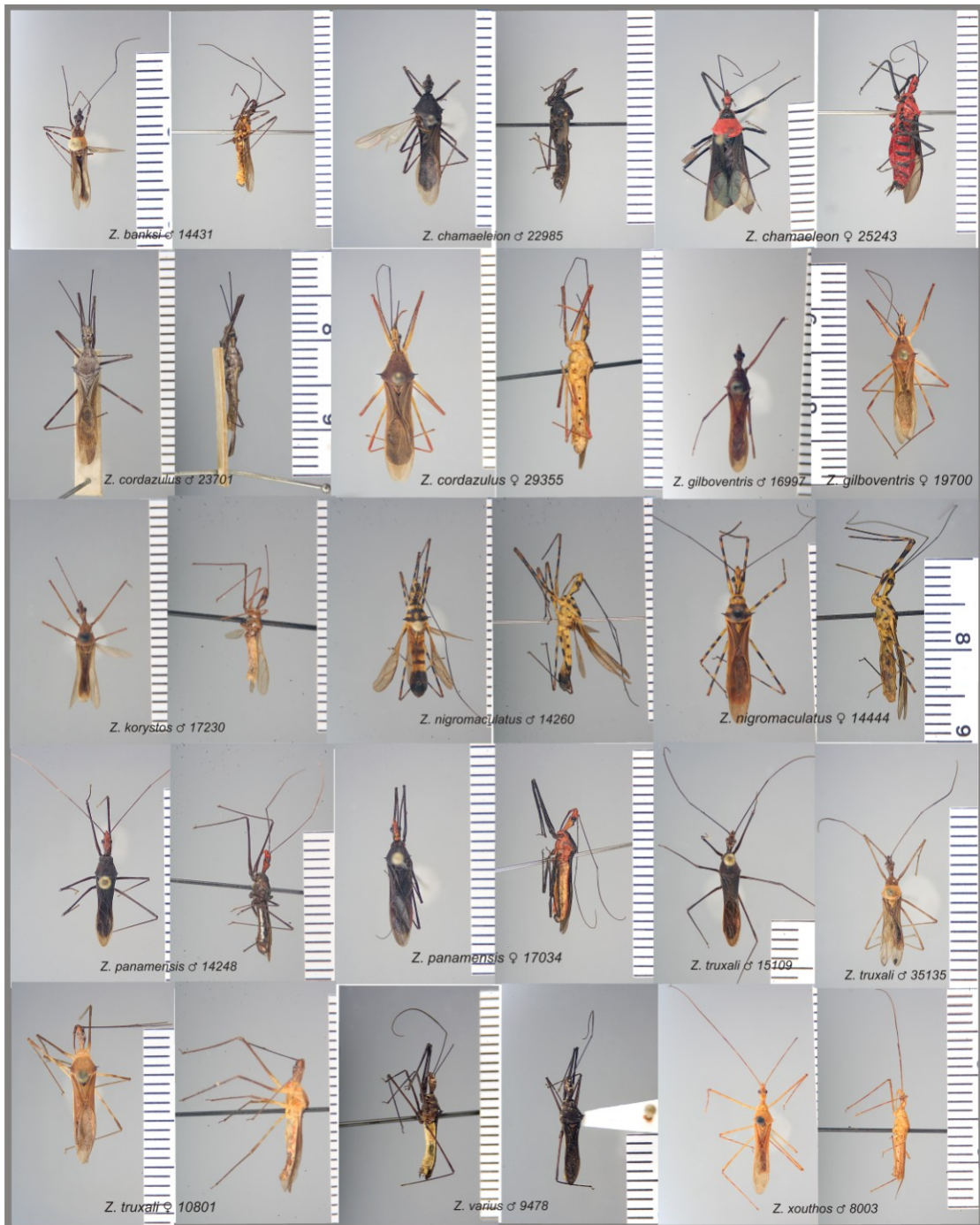

Figure 4.6. Habitus images of *Zelus banksi* **sp. nov.**, *Zelus chamaeleon* Stål, 1872, *Zelus cordazulus* **sp. nov.**, *Zelus filicauda* Bergroth, 1893, *Zelus gilboventris* **sp. nov.**, *Zelus korystos* Hart, 1987, *Zelus nigromaculatus* Champion, 1898, *Zelus panamensis* **sp. nov.**, *Zelus truxali* **sp. nov.**, *Zelus varius* (Herrich-Schaeffer, 1853) and *Zelus xouthos* **sp. nov.**

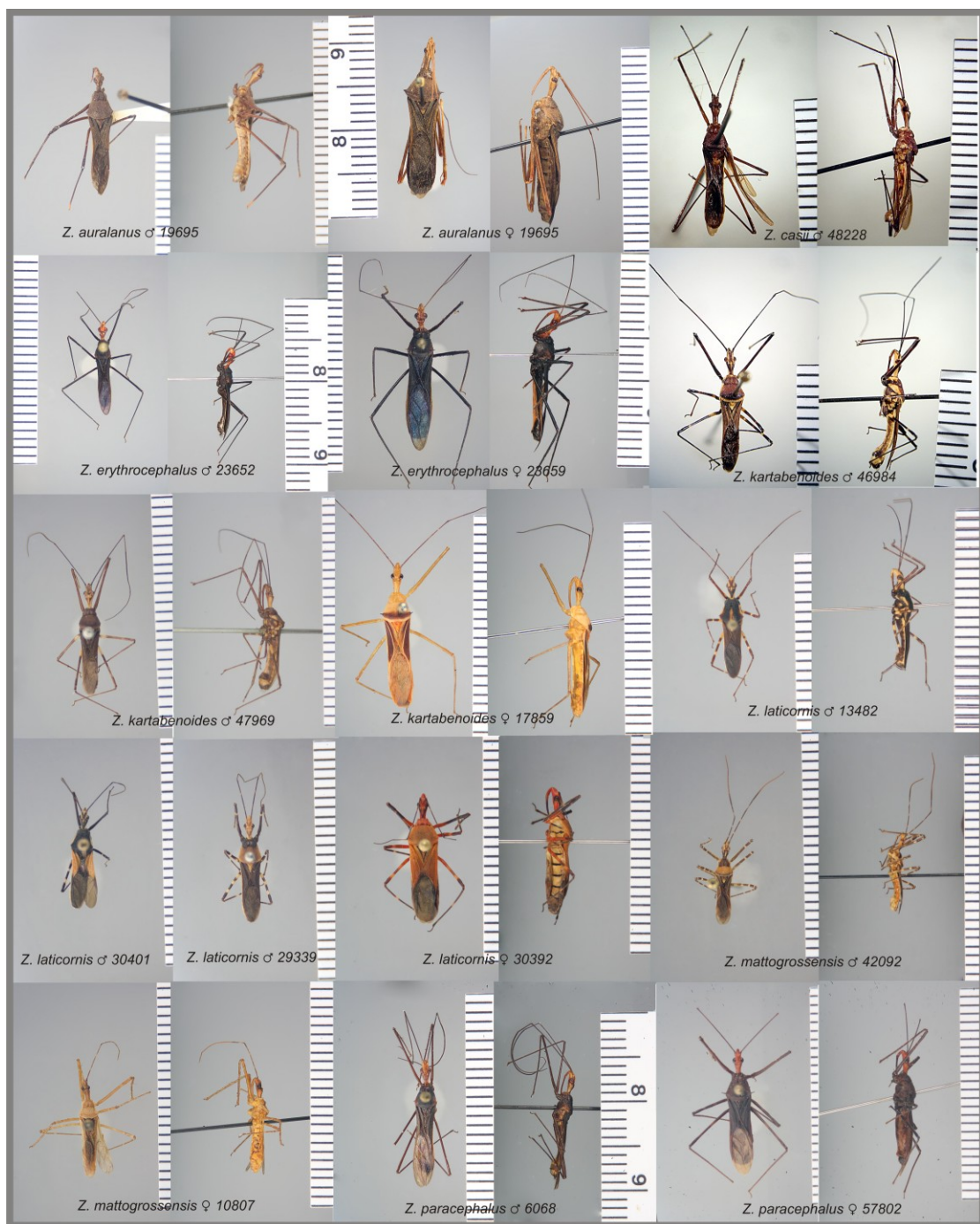

Figure 4.7. Habitus images of *Zelus auralanus* sp. nov., *Zelus casii* sp. nov., *Zelus erythrocephalus* Fabricius, 1803, *Zelus kartabenooides* sp. nov., *Zelus kartabensis* Haviland, 1931, *Zelus laticornis* (Herrich-Schäffer, 1853), *Zelus mattogrossensis* Wygodzinsky, 1947, *Zelus paracephalus* sp. nov.

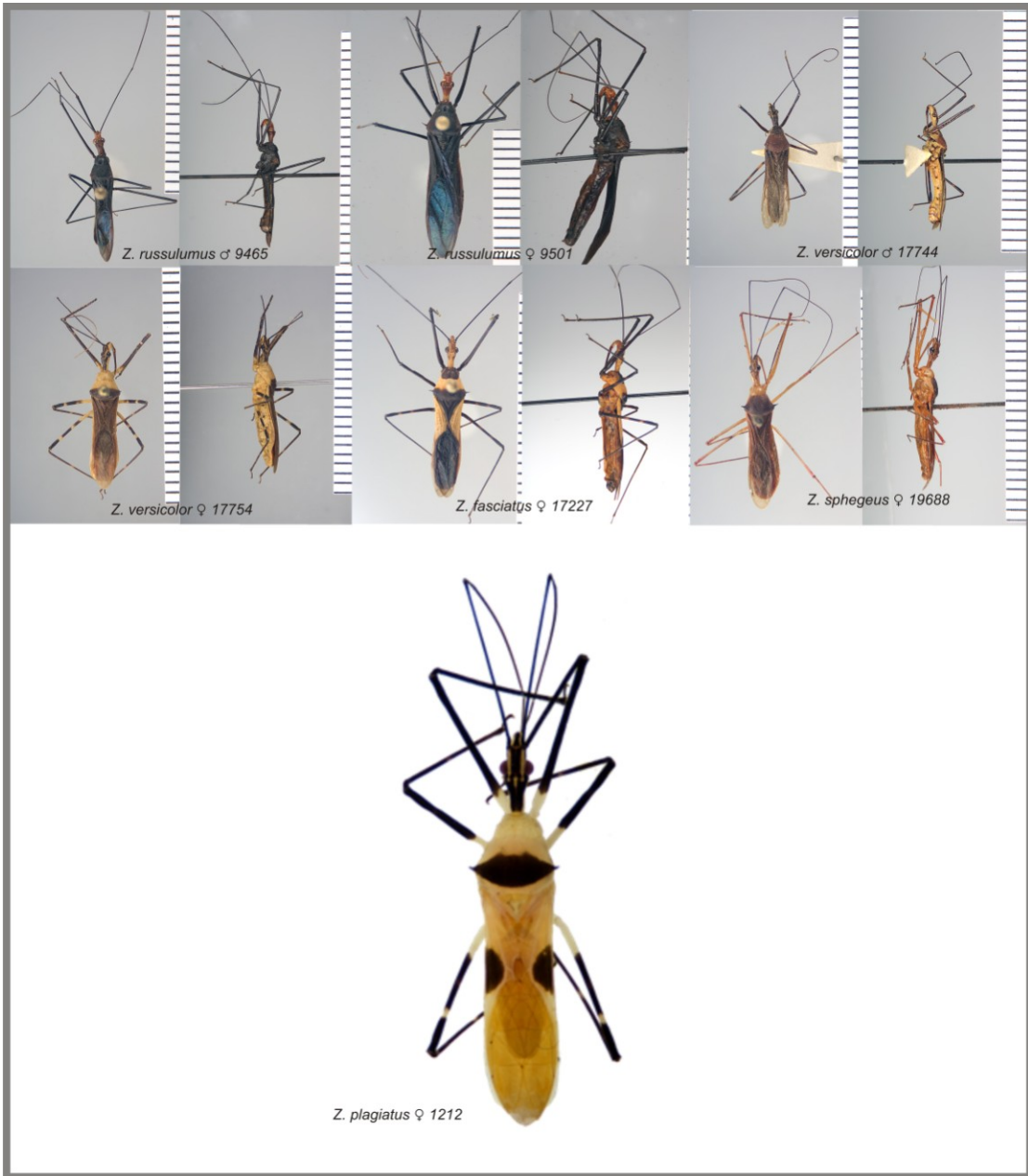

Figure 4.8. Habitus images of *Zelus russulumus* **sp. nov.**, *Zelus versicolor* (Herrich-Schäffer, 1848), *Zelus fasciatus* Champion, 1899, *Zelus plagiatus* (Signoret, 1862) and *Zelus spegeus* Fabricius, 1803

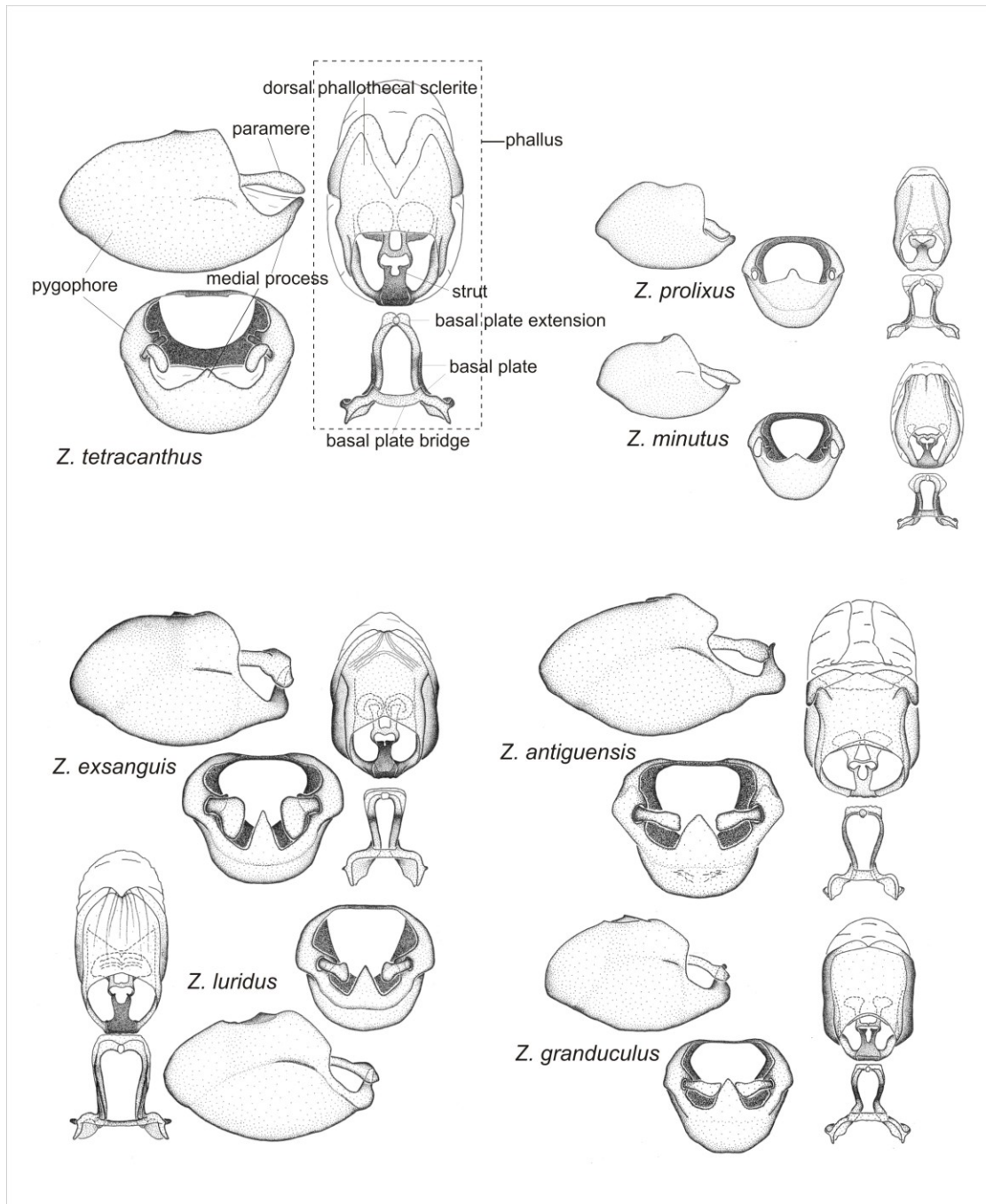

Figure 4.9. Illustrations of male genitalia of *Z. tetracanthus*, *Z. minutus*, *Z. prolixus*, *Z. exsanguis*, *Z. luridus*, *Z. antiquensis* and *Z. granduculus*, after Hart (1972).

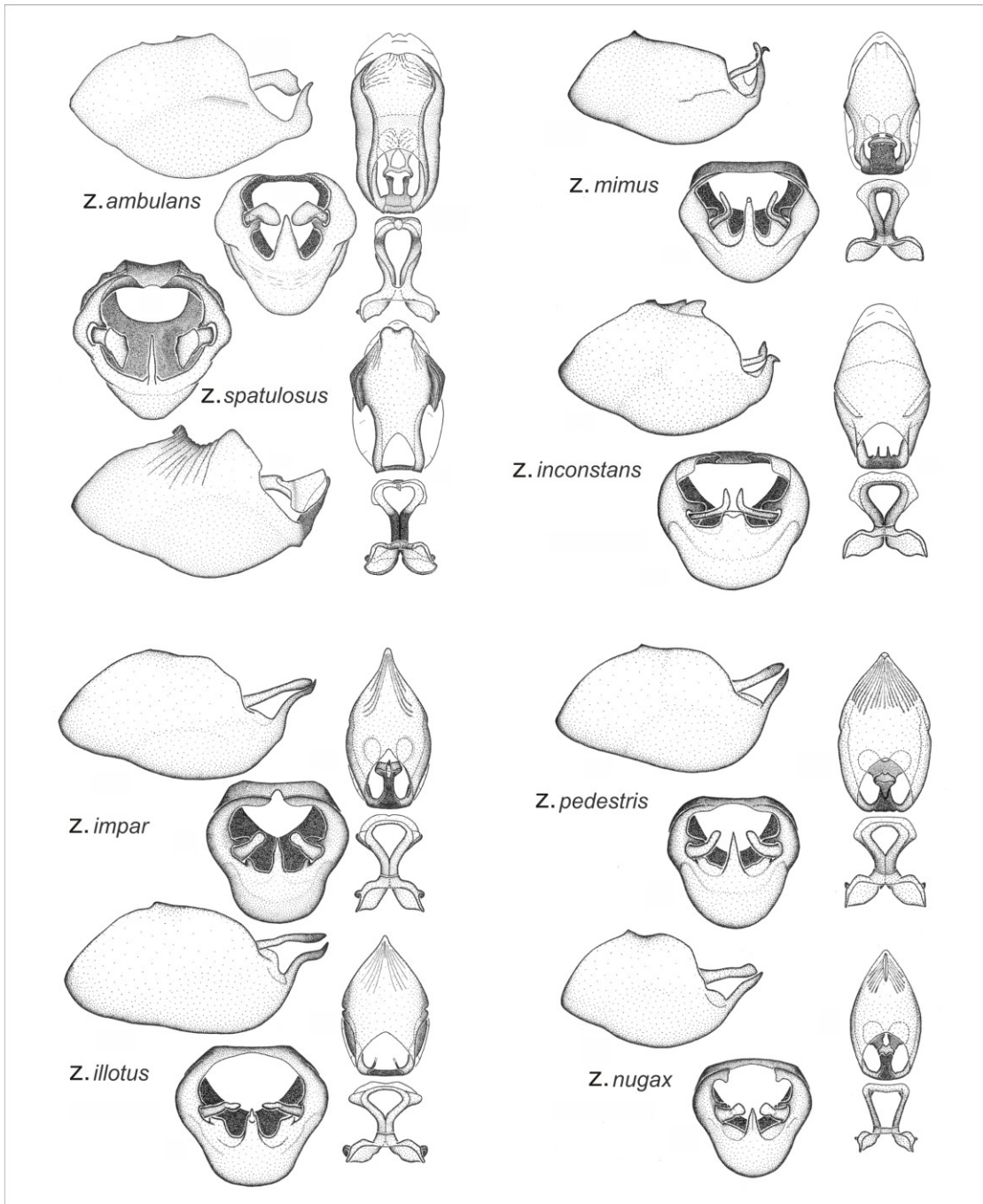

Figure 4.10. Illustrations of male genitalia of *Z. ambulans*, *Z. spatulosus*, *Z. mimus*, *Z. inconstans*, *Z. impar*, *Z. illotus*, *Z. pedestris* and *Z. nugax*, after Hart (1972).

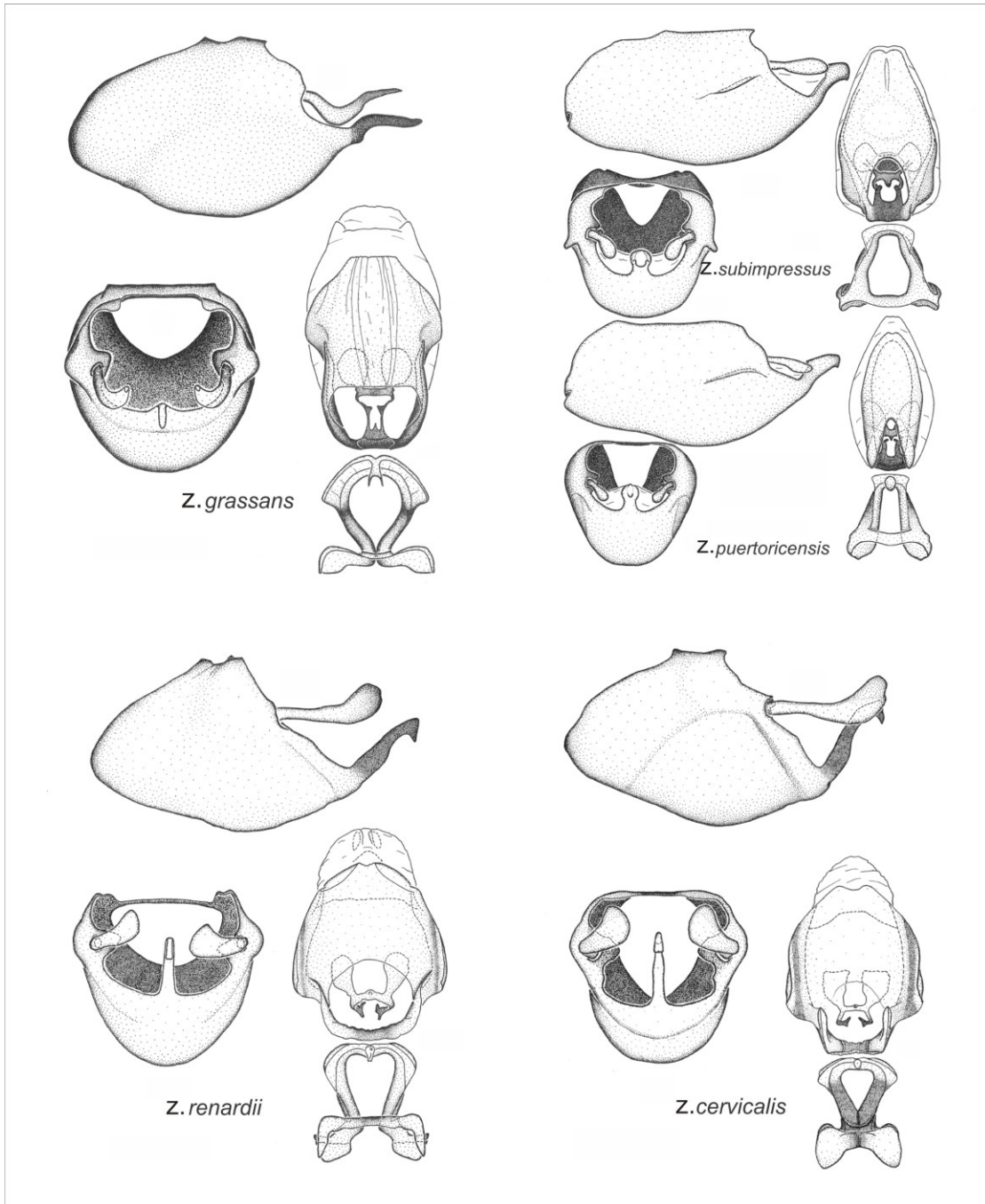

Figure 4.11. Illustrations of male genitalia of *Z. grassans*, *Z. puertoricensis*, *Z. subimpressus*, *Z. renardii* and *Z. cervicalis*, after Hart (1972).

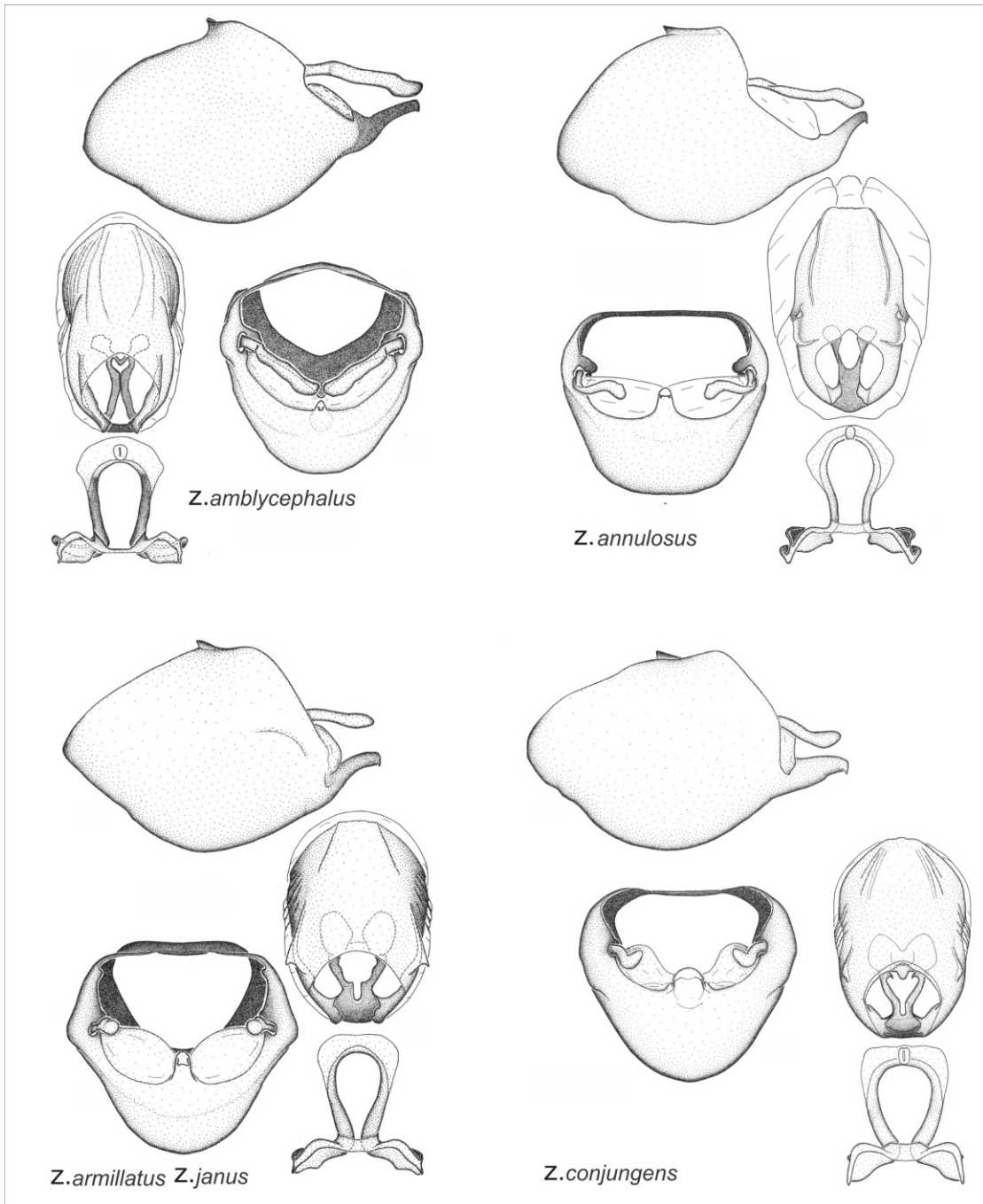

Figure 4.12. Illustrations of male genitalia of *Z. amblycephalus*, *Z. annulosus*, *Z. armillatus*, *Z. janus* and *Z. conjungens*, after Hart (1972).

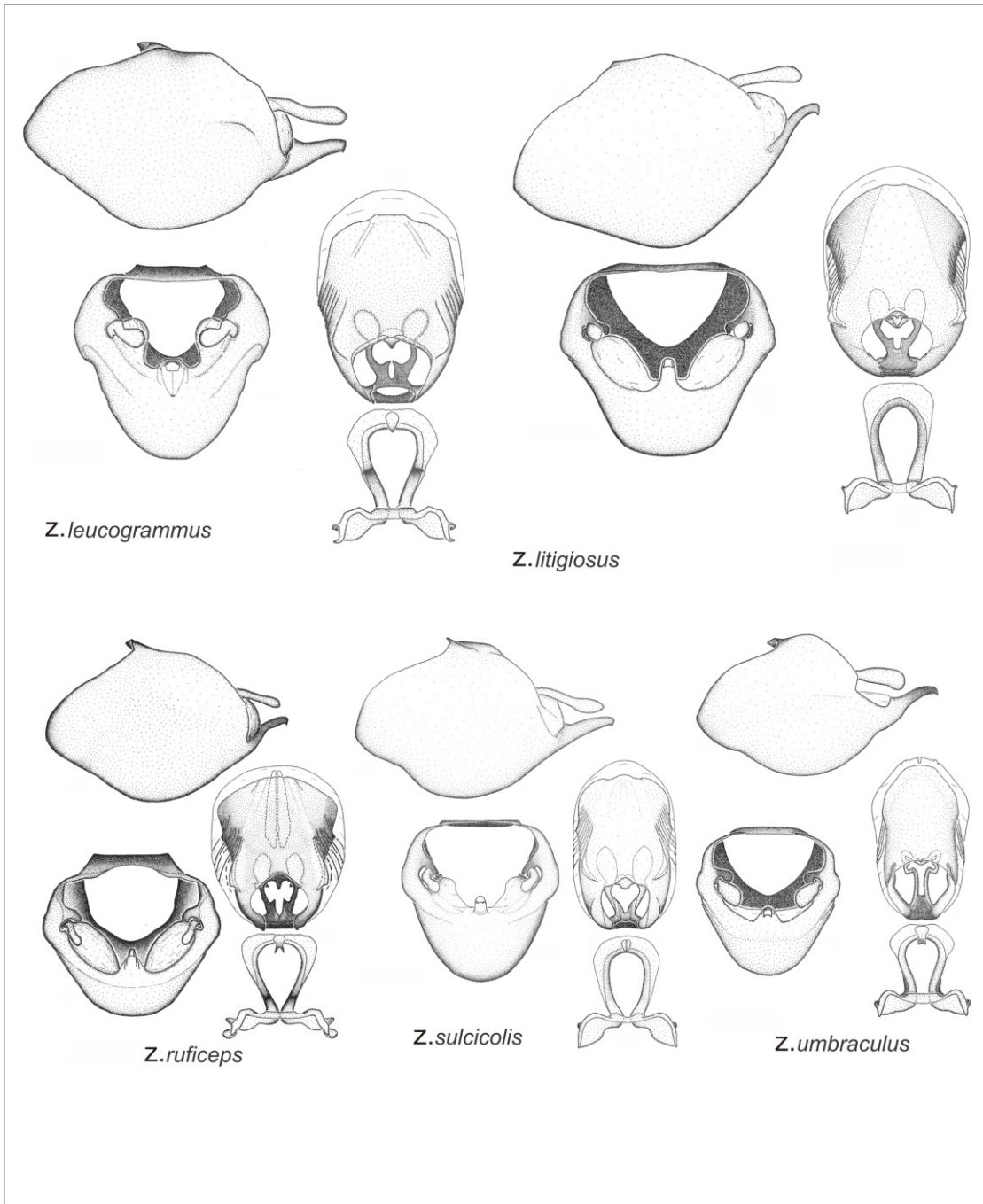

Figure 4.13. Illustrations of male genitalia of *Z. leucogrammus*, *Z. litigiosus*, *Z. ruficeps*, *Z. sulcicollis* and *Z. umbraculus*, after Hart (1972).



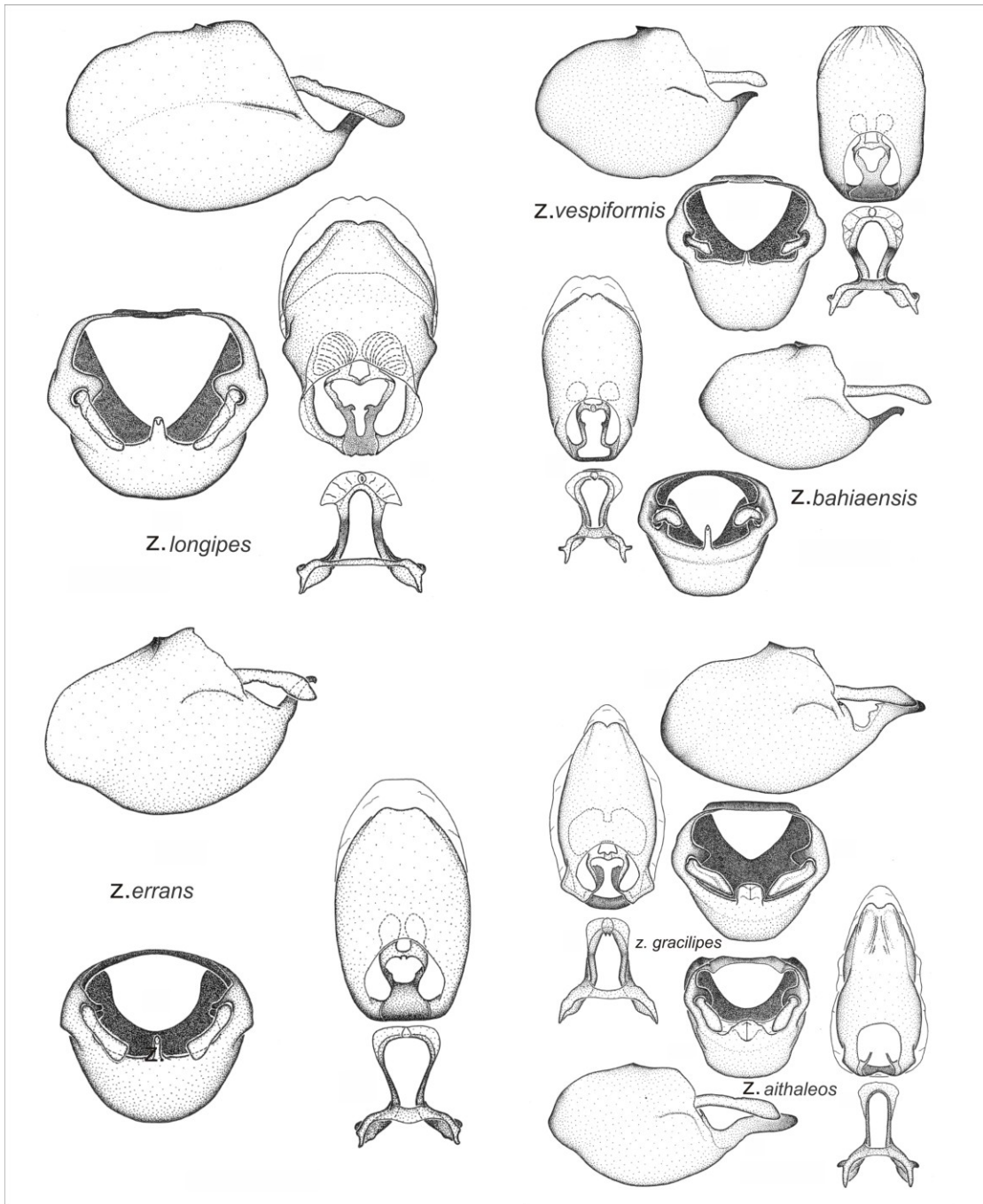

Figure 4.14. Illustrations of male genitalia of *Z. longipes*, *Z. vespiformis*, *Z. bahiaensis*, *Z. errans*, *Z. gracilipes* and *Z. aithaleos*, after Hart (1972).

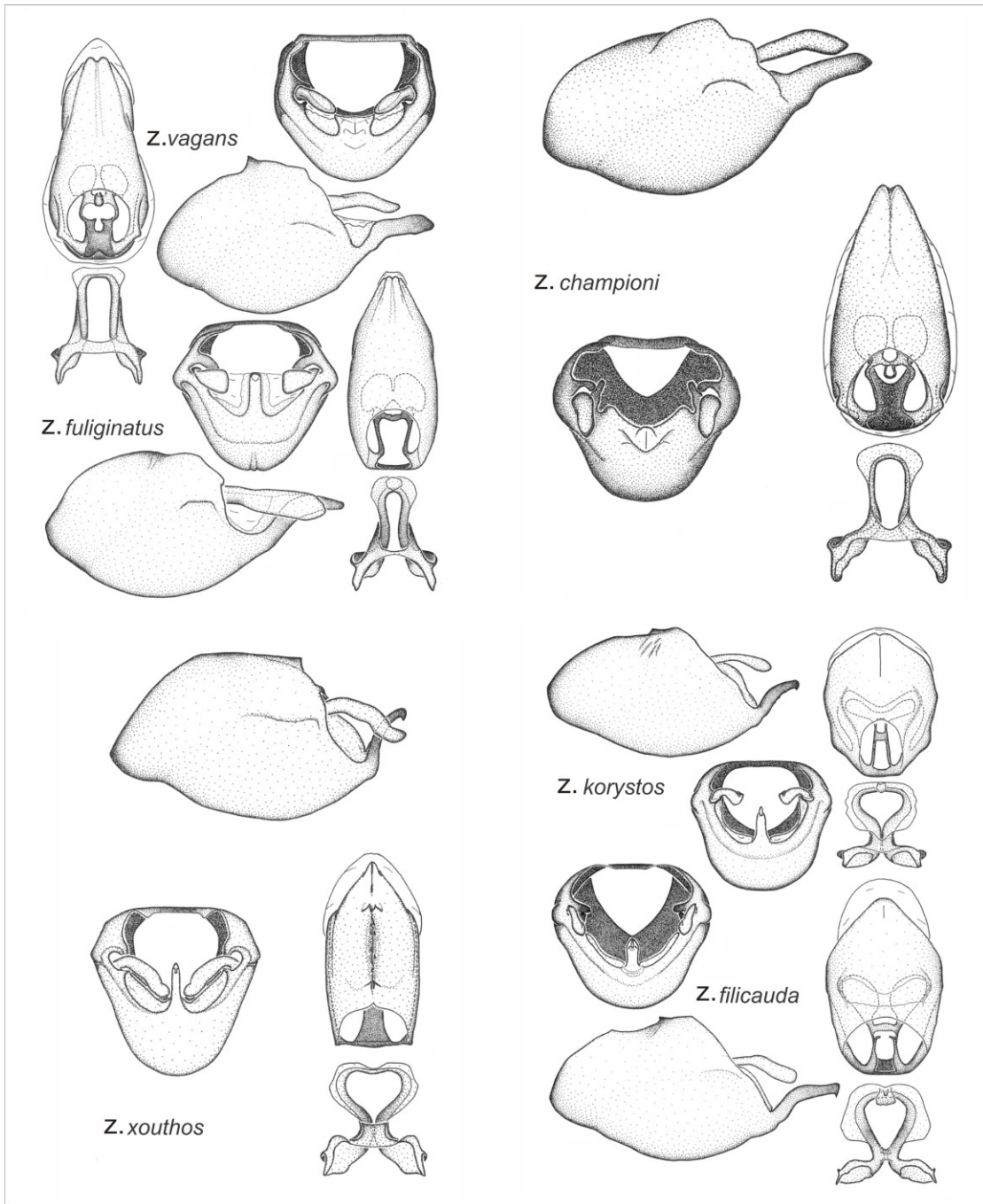

Figure 4.15. Illustrations of male genitalia of *Z. vagans*, *Z. fuliginatus*, *Z. championi*, *Z. xouthos*, *Z. korystos* and *Z. filicauda*, after Hart (1972).

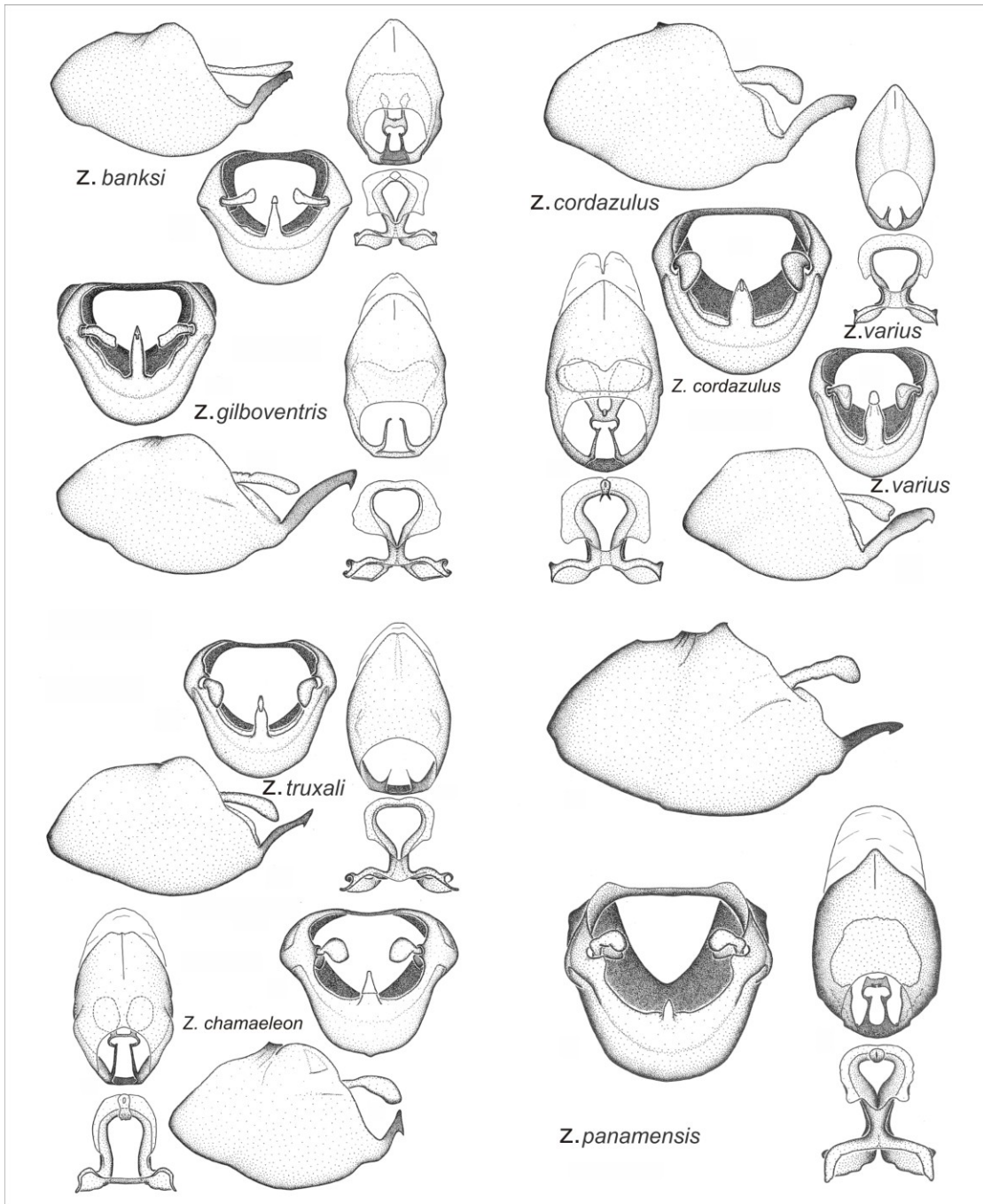

Figure 4.16. Illustrations of male genitalia of *Z. banksi*, *Z. gilboventris*, *Z. cordazulus*, *Z. varius*, *Z. truxali*, *Z. chamaeleon* and *Z. panamensis*, after Hart (1972).

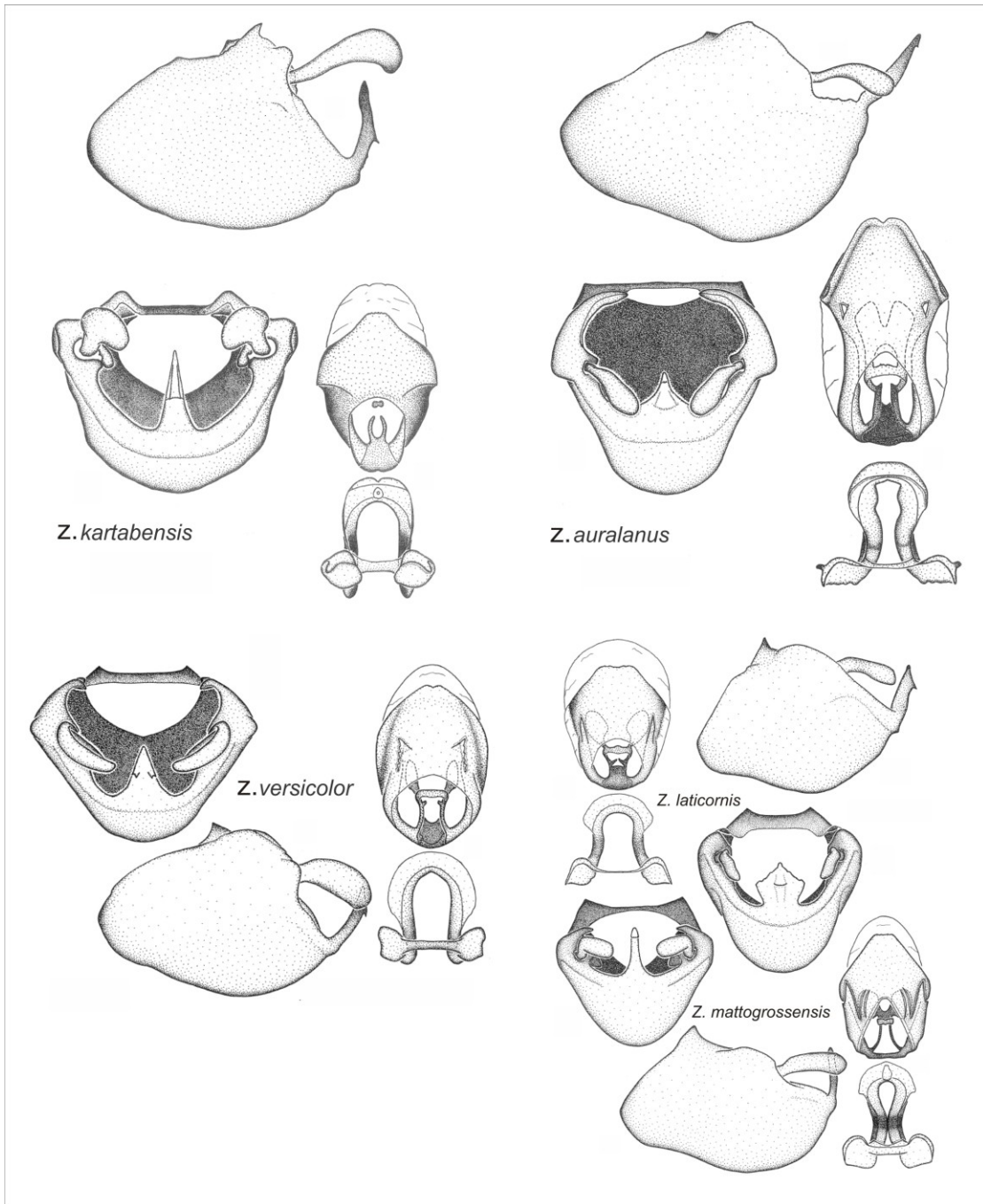

Figure 4.17. Illustrations of male genitalia of *Z. kartabensis*, *Z. auralanus*, *Z. versicolor*, *Z. laticornis* and *Z. mattogrossensis*, after Hart (1972)

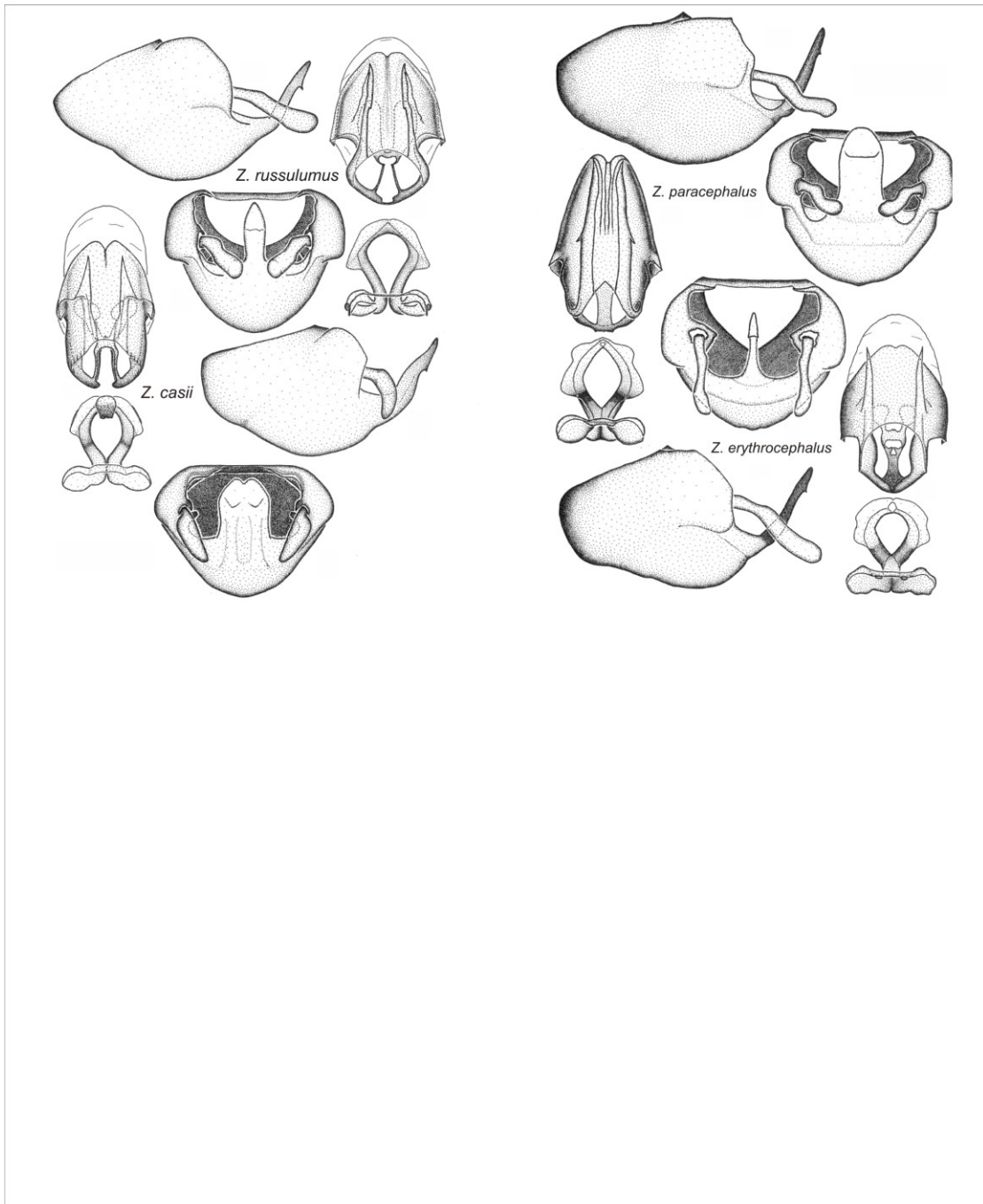

Figure 4.18. Illustrations of male genitalia of *Z. russulumus*, *Z. casii*, *Z. paracephalus*, and *Z. erythrocephalus*, after Hart (1972)

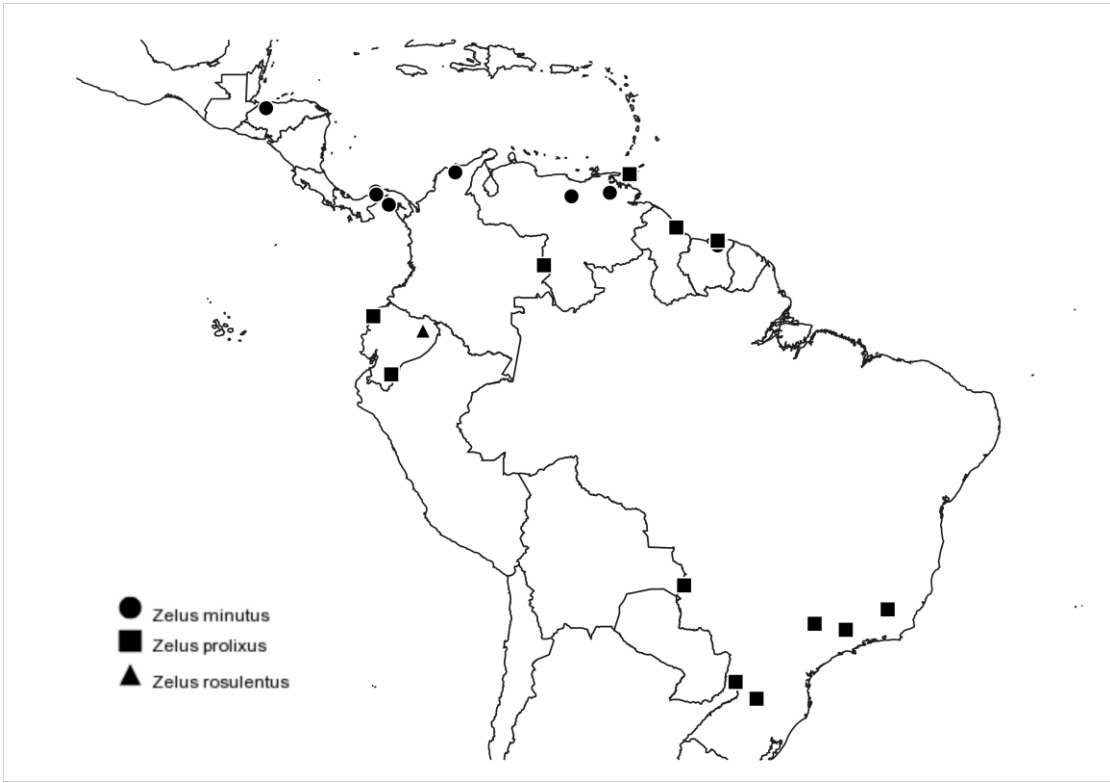

Figure 4.19. Distributions of *Z. minutus*, *Z. prolixus* and *Z. rosulentus*.

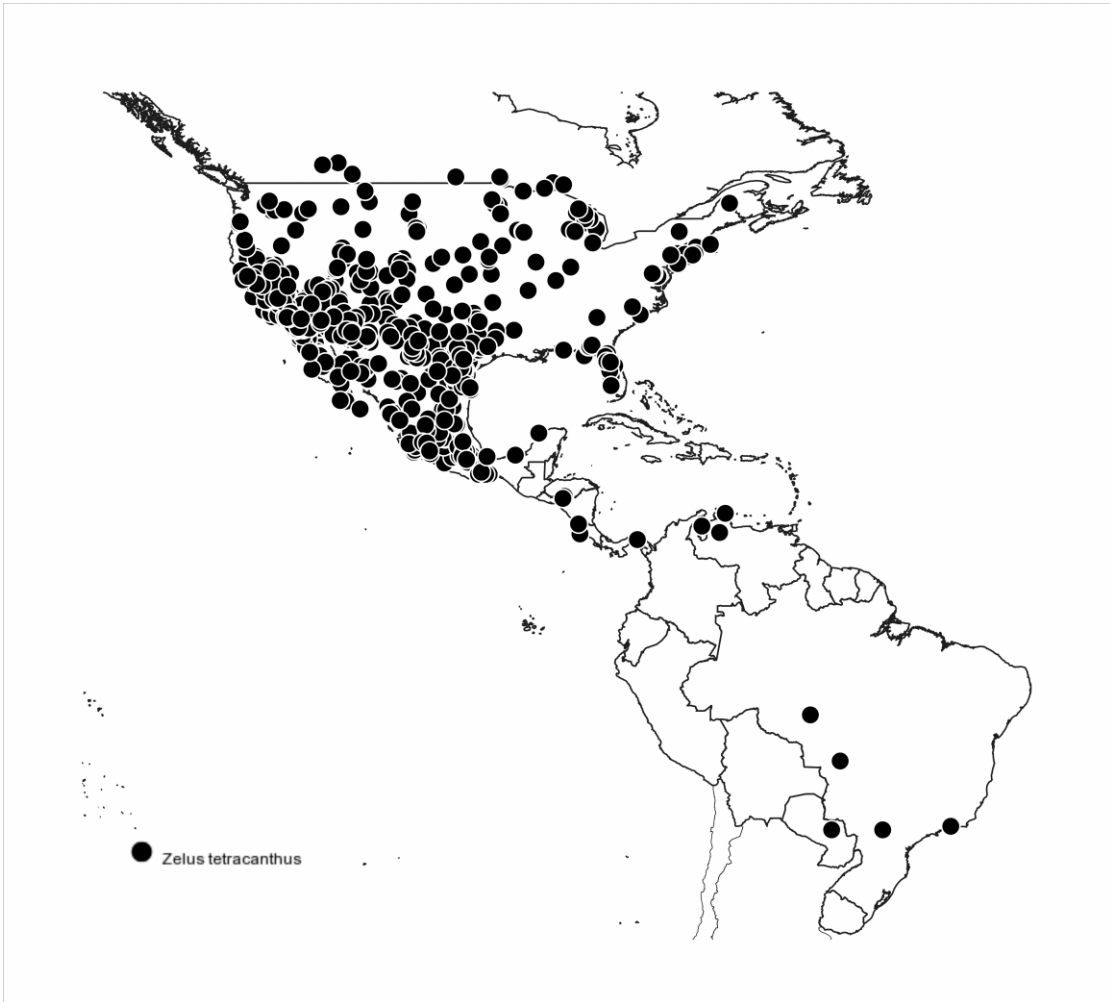

Figure 4.20. Distribution of *Z. tetracanthus*.

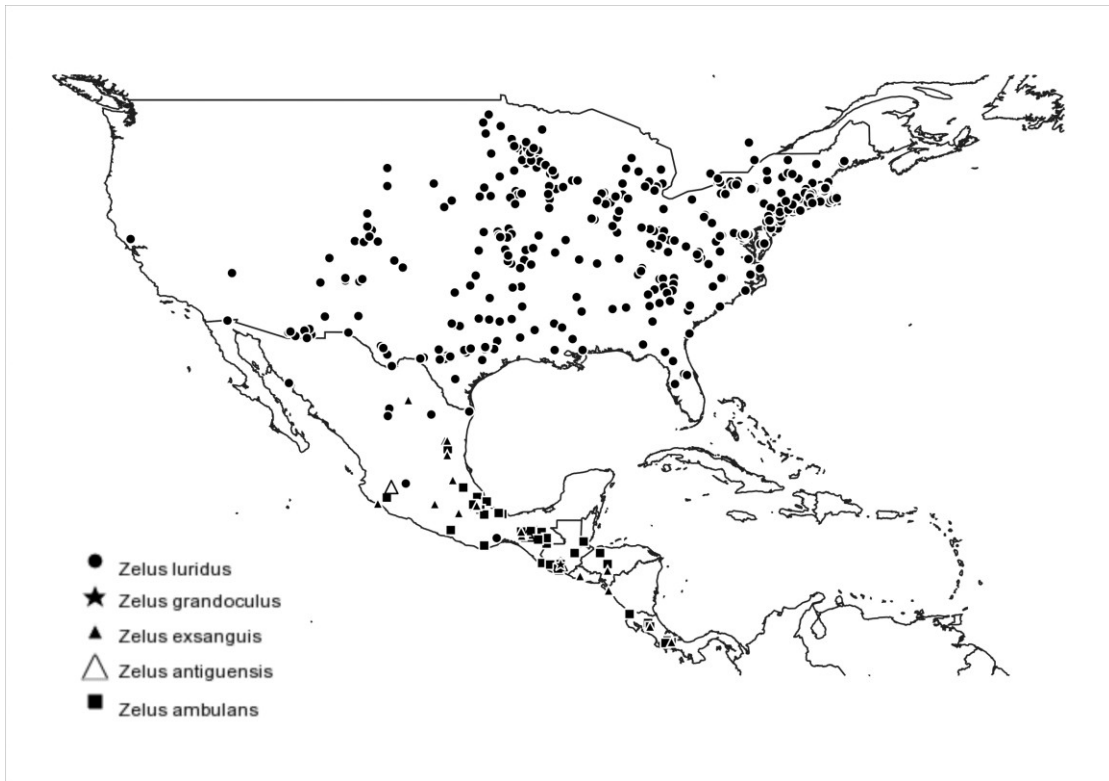

Figure 4.21. Distributions of *Z. luridus*, *Z. grandoculus*, *Z. antiguensis*, *Z. ambulans*.



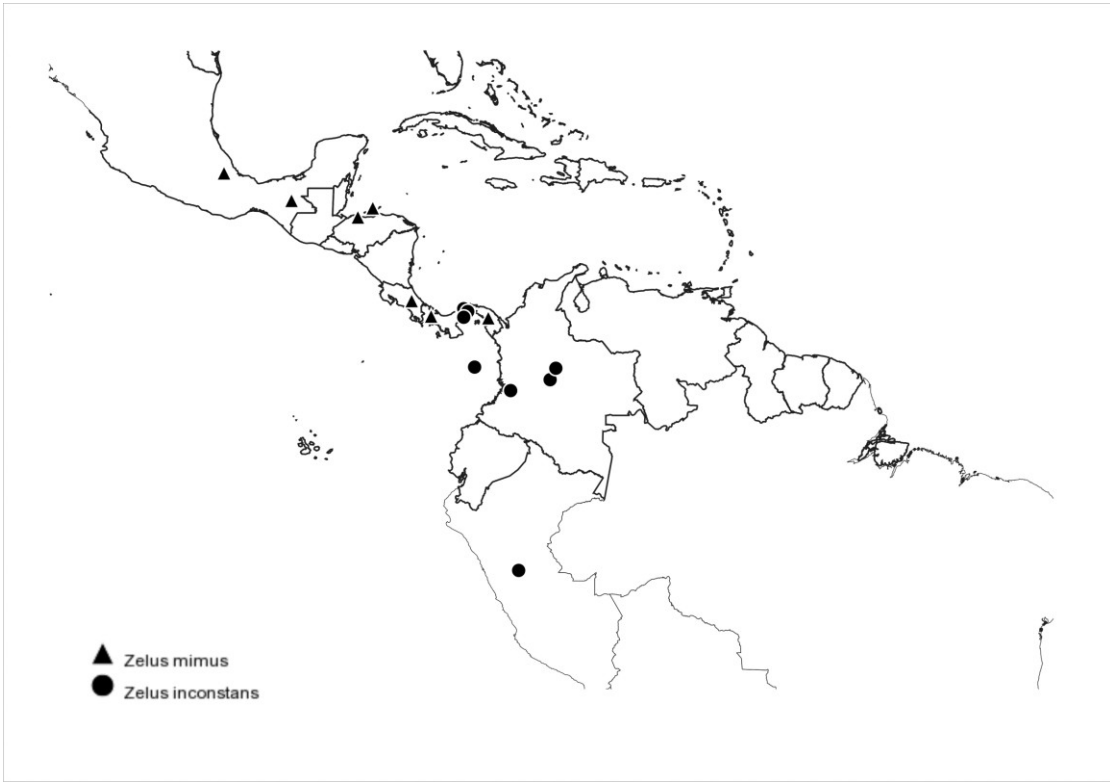

Figure 4.22. Distributions of *Z. mimus* and *Z. inconstans*.

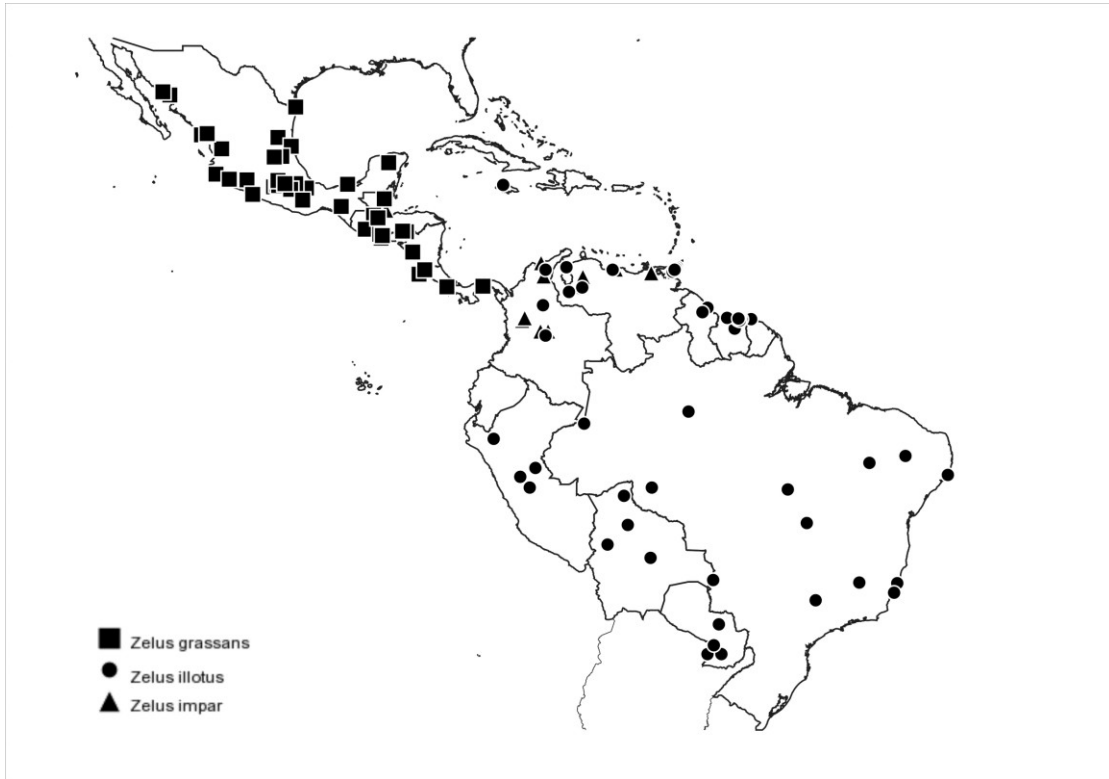

Figure 4.23. Distributions of *Z. grassans*, *Z. illotus* and *Z. impar*.

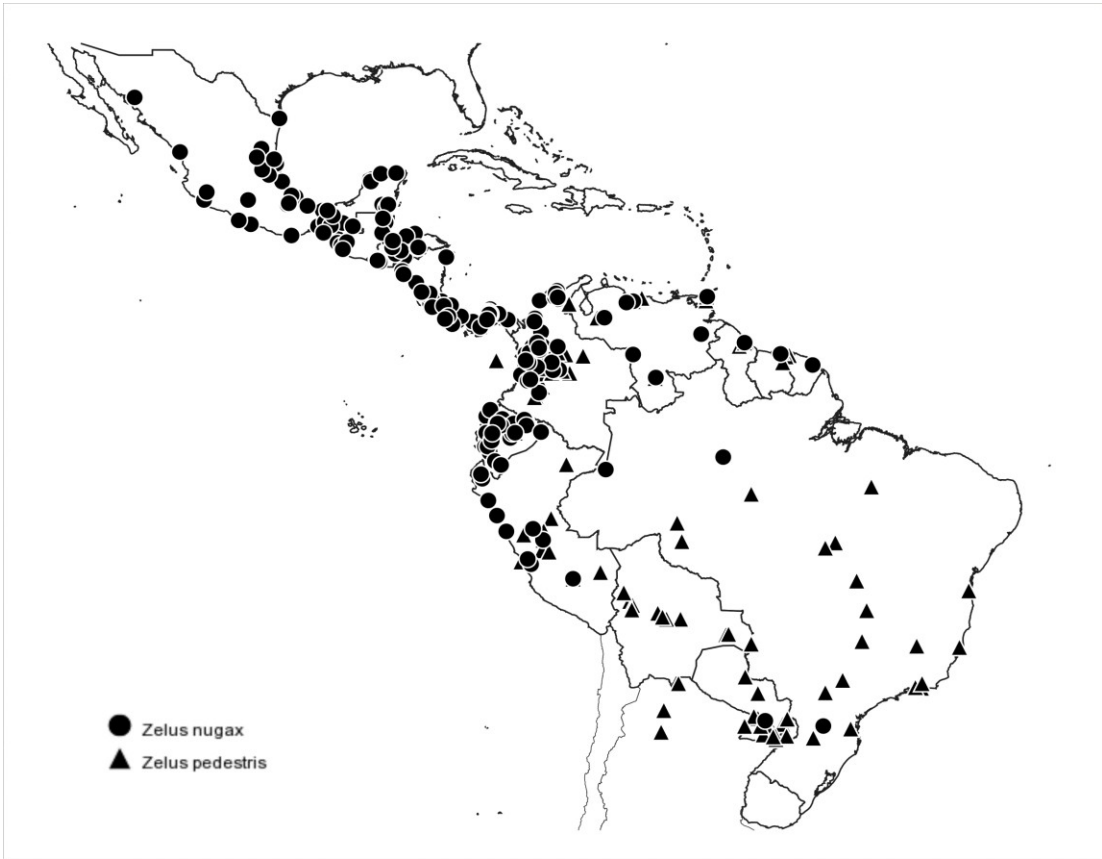

Figure 4.24. Distributions of *Z. nugax* and *Z. pedestris*.

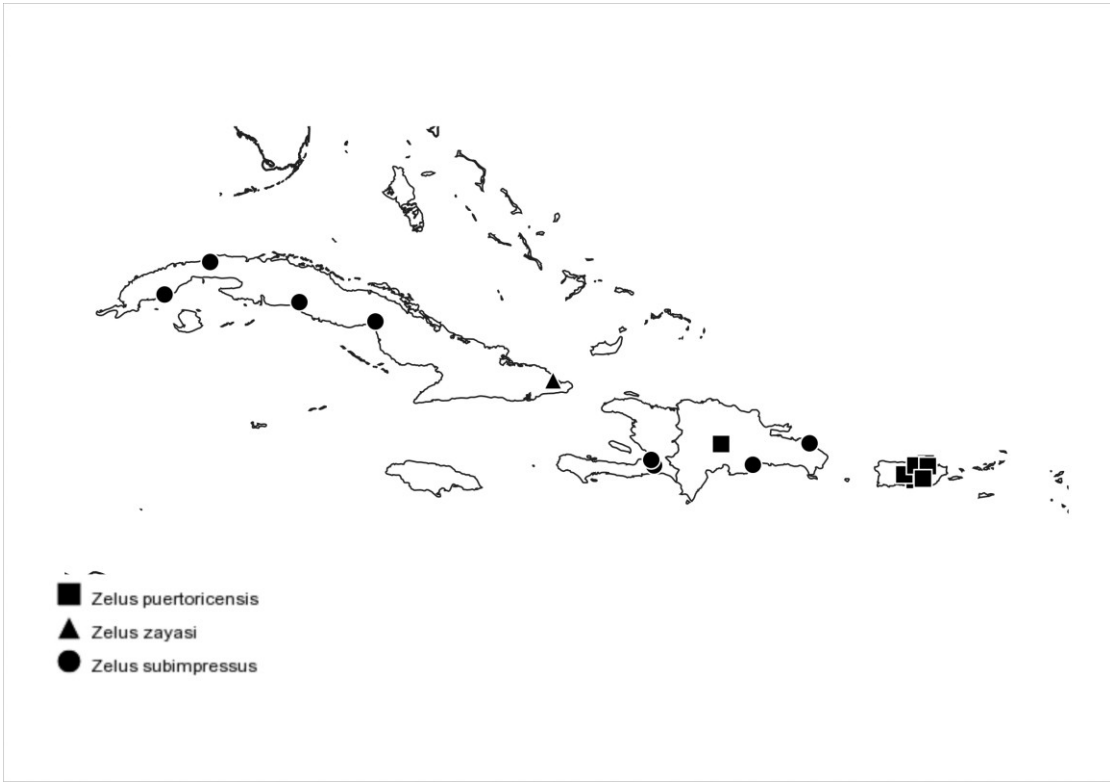

Figure 4.25. Distributions of *Z. puertoricensis*, *Z. subimpressus* and *Z. zayasi*.

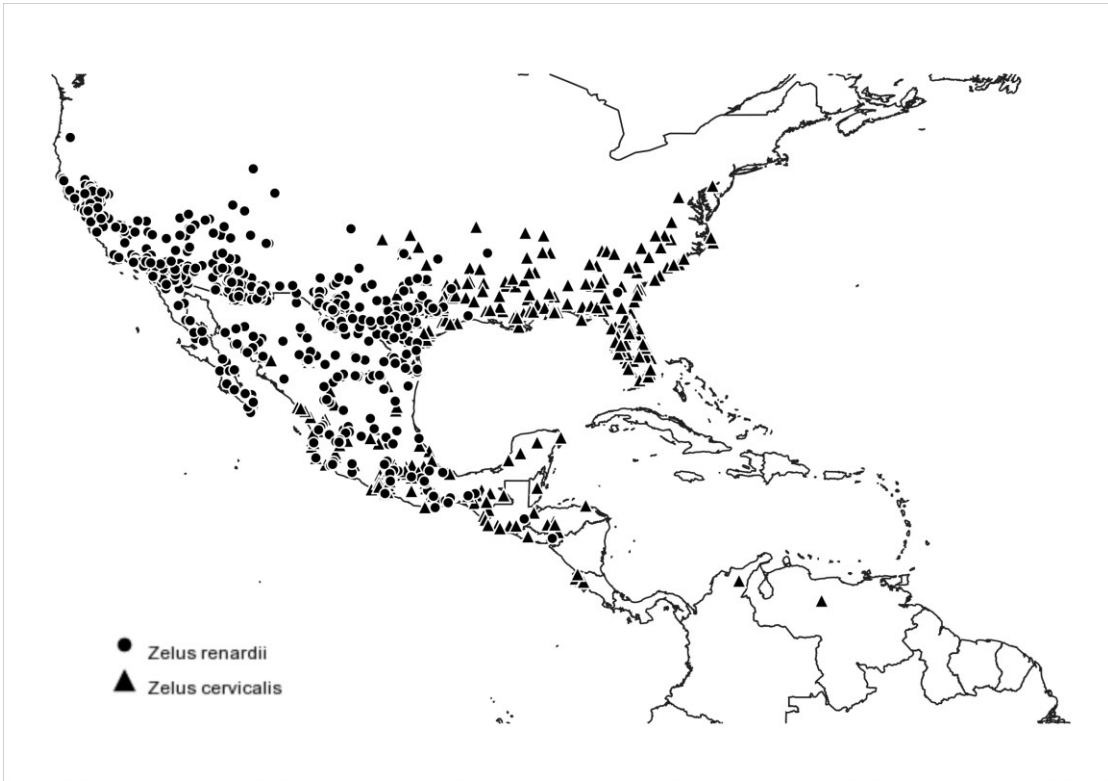

Figure 4.26. Distributions of *Z. cervicalis* and *Z. renardii*.

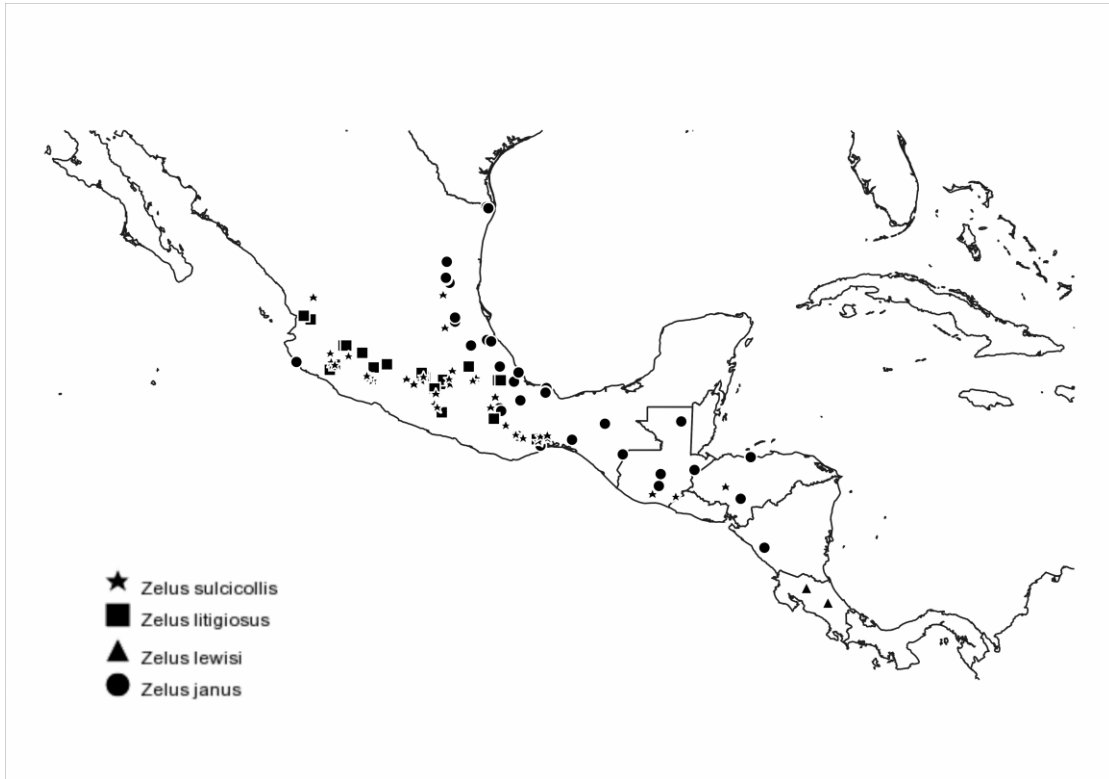

Figure 4.27. Distributions of *Z. sulcicollis*, *Z. litigosus*, *Z. lewisi* and *Z. janus*.



Figure 4.28. Distributions of *Z. umbraculoides*, *Z. umbraculus*, *Z. conjungens*, *Z. leucogrammus* and *Z. annulosus*.

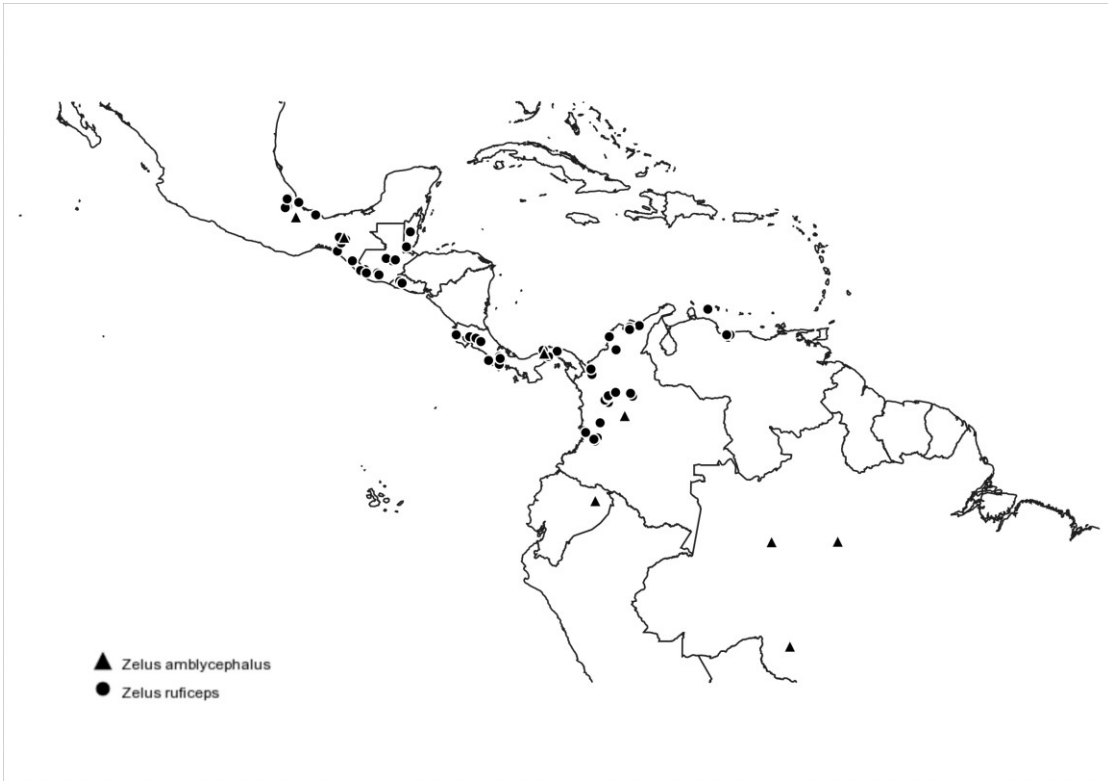

Figure 4.29. Distributions of *Z. ruficeps* and *Z. amblycephalus*.



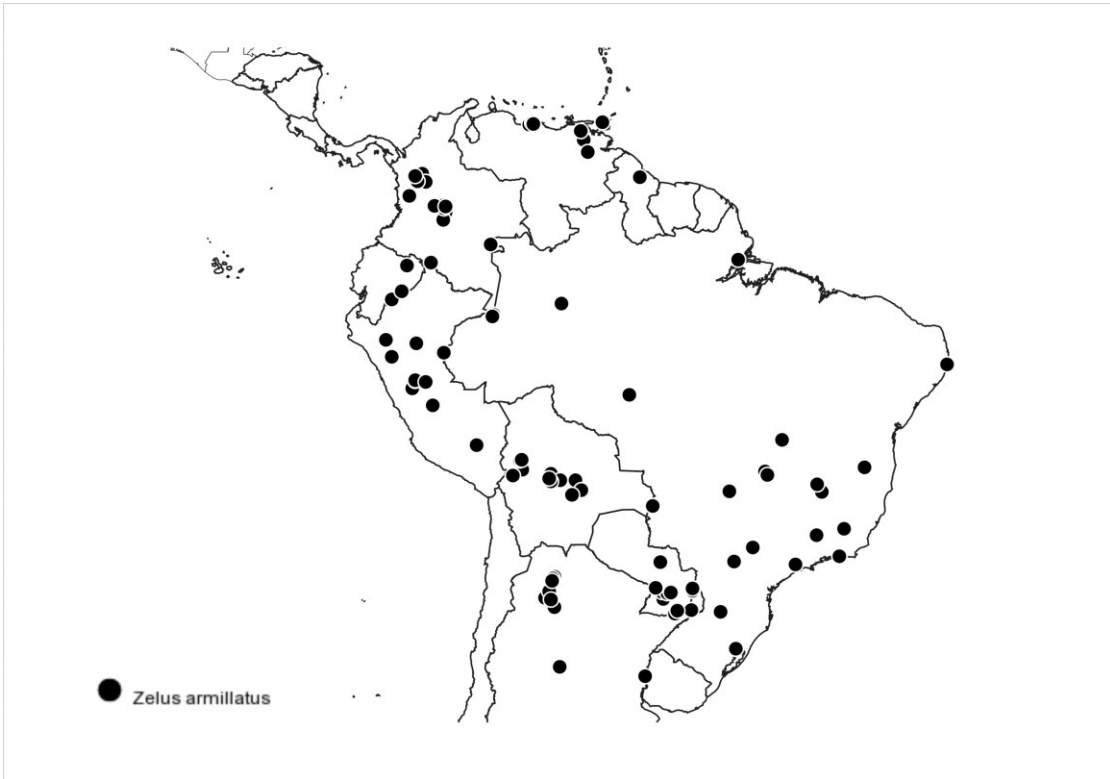

Figure 4.30. Distribution of *Z. armillatus*.

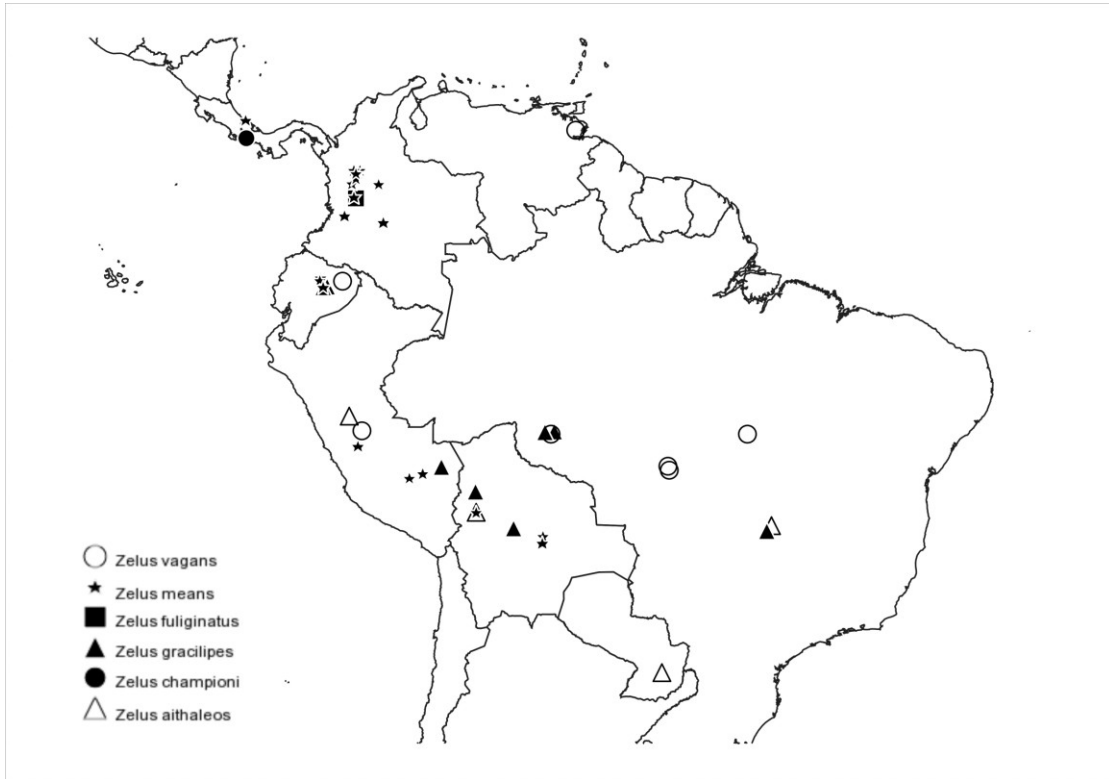

Figure 4.31. Distributions of *Z. vagans*, *Z. means*, *Z. gracilipes*, *Z. championi* and *Z. aithaleos*.



Figure 4.32. Distributions of *Z. bahiaensis*, *Z. errans* and *Z. vespiformis*.

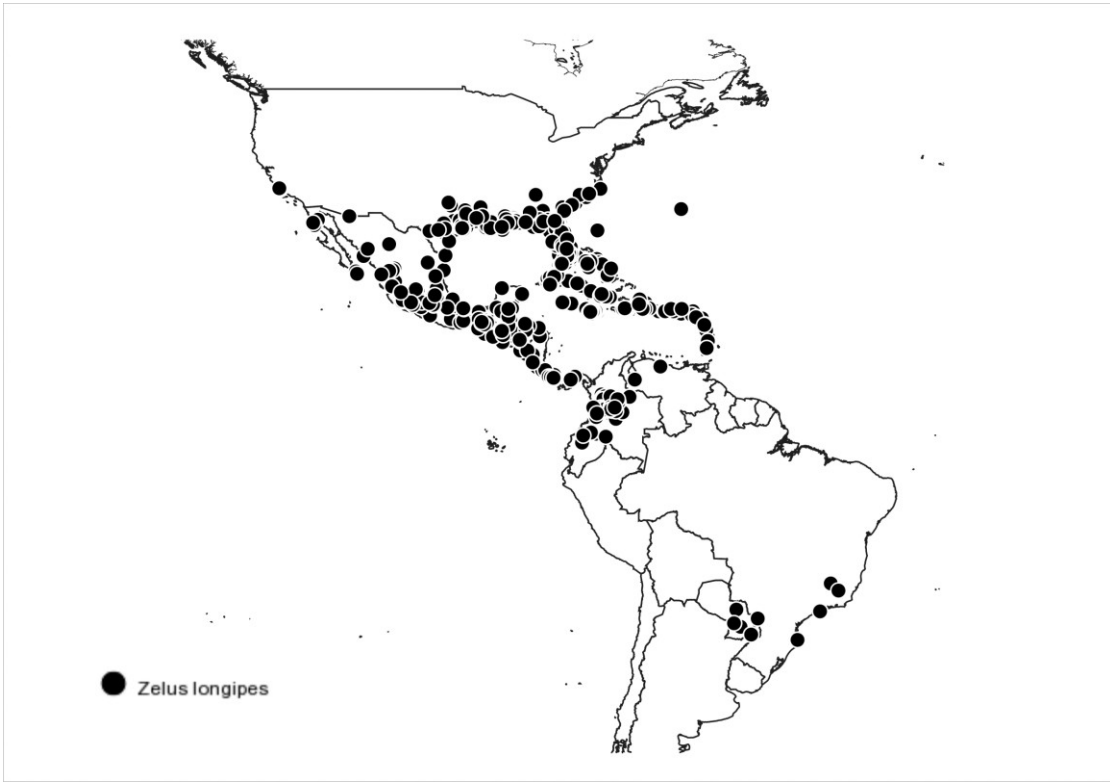

Figure 4.33. Distribution of *Z. longipes*.

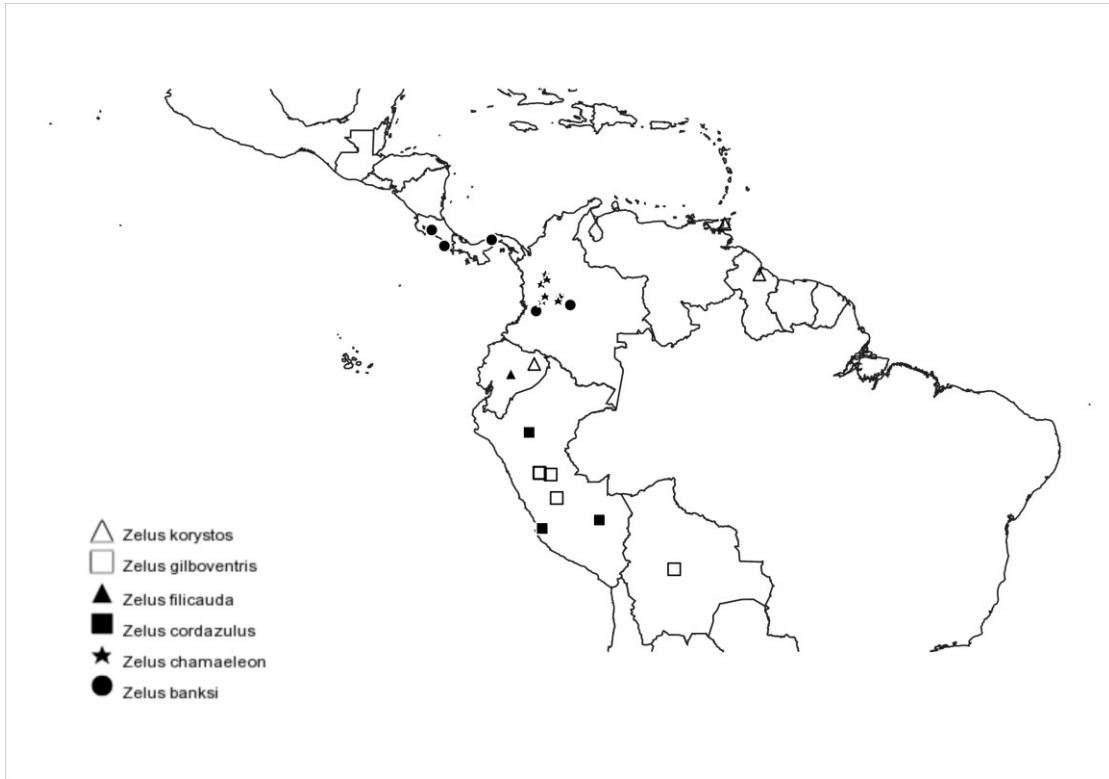

Figure 4.34. Distributions of *Z. korystos*, *Z. gilboventris*, *Z. filicauda*, *Z. cordazulus*, *Z. chamaeleon* and *Z. banksi*.

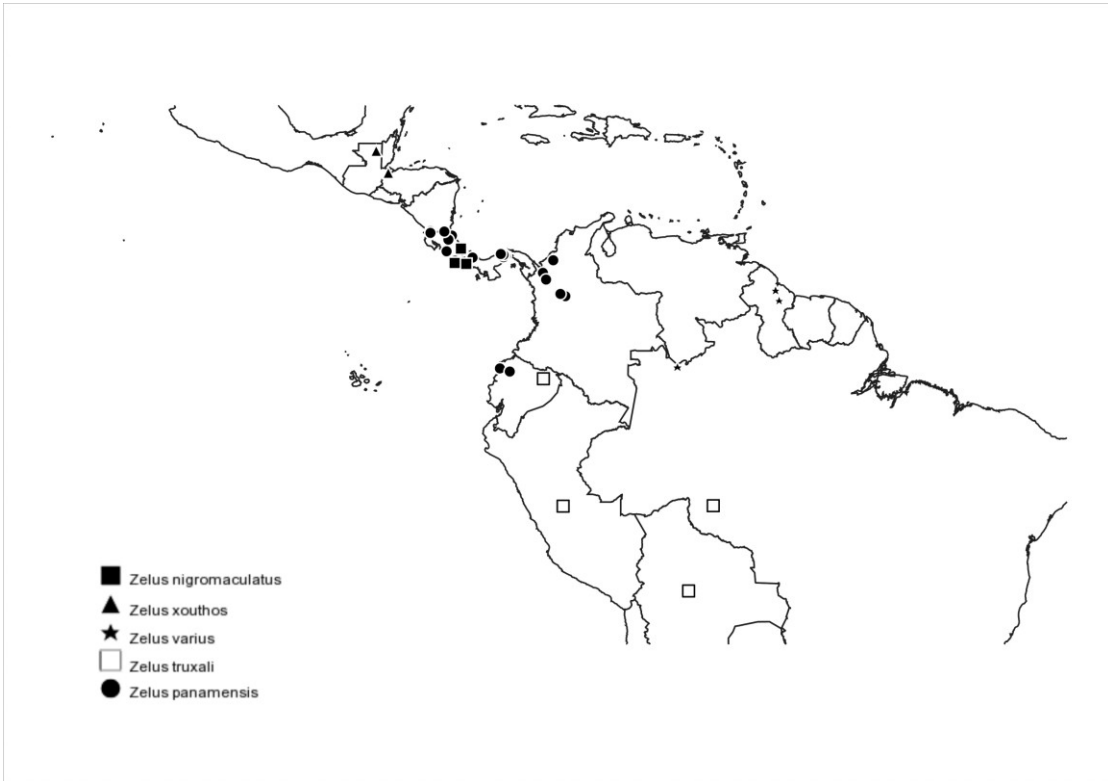

Figure 4.35. Distributions of *Z. nigromaculatus*, *Z. xouthos*, *Z. varius* and *Z. panamensis*.



Figure 4.36. Distributions of *Z. erythrocephalus*, *Z. versicolor*, *Z. mattogrossensis*, *Z. russulum* and *Z. paracephalus*.



Figure 4.37. Distributions of *Z. auralanus*, *Z. laticornis*, *Z. kartabenoides*, *Z. kartabensis* and *Z. casii*.



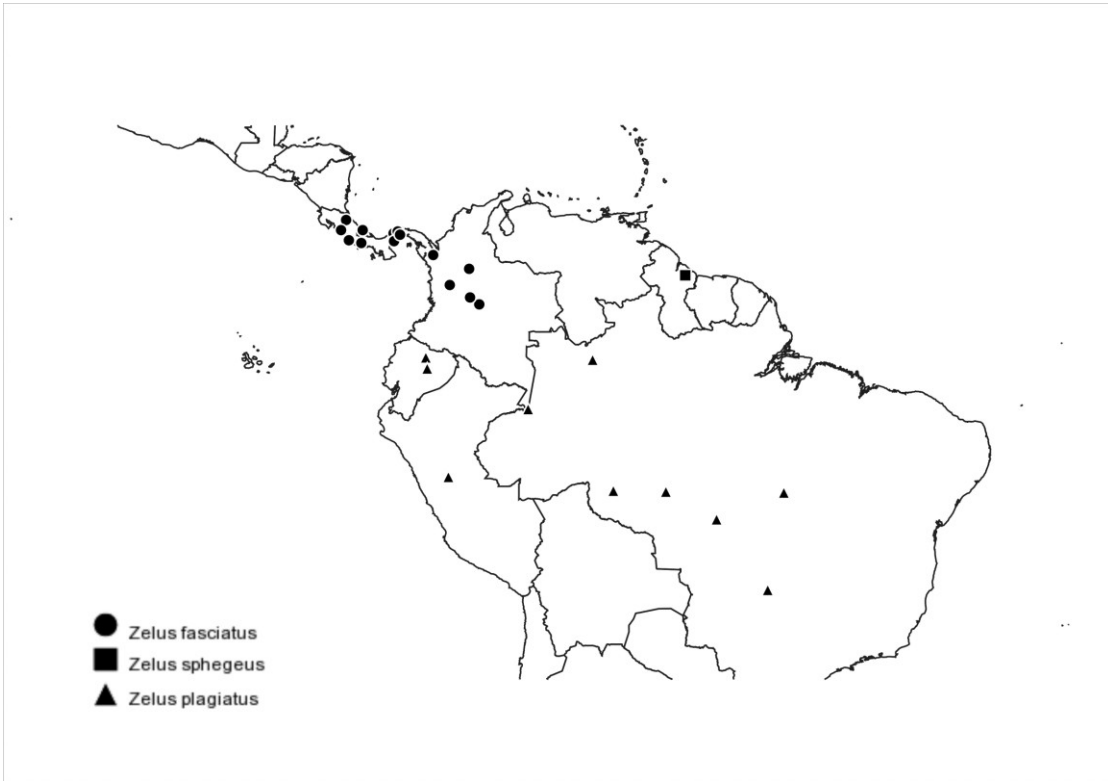

Figure 4.38. Distributions of *Z. fasciatus*, *Z. plagiatus* and *Z. sphegeus*.

Table 4.1. List of collections, acronyms and managers/curators in charge.

<b>Acrony</b>	<b>Museum/Collection</b>	<b>Manager/Curator</b>
AMNH	American Museum of Natural History, New York, USA	Ruth Salas / RT Schuh
CAS	California Academy of Sciences, USA	Norman D. Penny
CUIC	Cornell University Insect Collection, Ithaca, USA	Rick Hoebeke / Jim Liebherr
FMNH	Field Museum of Natural History, Chicago, USA	James Boone
FSCA	Florida State Collection of Arthropods, Florida Department of Agriculture, Gainesville, Florida	Susan Halbert / David Ziesk
ICN	Instituto de Ciencias Naturales, Universidad Nacional de Colombia, Bogota, Colombia	Carlos Sarmiento
IEXA	Instituto de Ecologia, Xalapa, Mexico	Luis Cervantes
INBIO	Instituto Nacional de Biodiversidad, Costa Rica	Jim Lewis
ISNB	Royal Institute of Natural Science of Belgium, Brussels, Belgium	Jerome Constant
KU	University of Kansas, Snow Entomological Museum, Lawrence, USA	Zachary H. Falin
LACM	Natural History Museum of Los Angeles County, California, USA	Weiping Xie / Bryan Brown
MEFLG	Museo Entomologico Francisco Luis Gallego, Colombia	John Albeiro Quiroz
MLP	Museo de La Plata	Maria Coscaron
NHMW	Natural History Museum of Vienna	Herbert Zettel
NHRS	Sweden Museum of Natural History	Gunvi Lindberg
RMNH	Nationaal Natuurhistorische Museum (formerly Rijksmuseum van Natuurlijke Historie), Leiden, Netherlands	Yvonne van Nierop / R. Vries
TAMU	Texas A&M University, College Station, USA	Edward G. Riley
UCB	University of California, Berkeley, USA	Cheryl Barr
UCD	University of California, Davis, USA	Steve Heydon
UCR	University of California, Riverside, USA	Doug Yanega
UMSP	University of Minnesota, St. Paul, USA	Philip J. Clausen
UNAB	Museo Entomologico, Facultad de Agronomia, Universidad Nacional de Colombia, Bogota, Colombia	Francisco Serna
UNAM	Universidad Autonoma de Mexico, Instituto de Biologia, Mexico	Harry Brailovsky
USNM	United States National Museum of Natural History, District of Columbia, USA	Tom Henry
ZMAN	Zoological Museum Amsterdam, Netherlands	Willem Hogenes
ZMUC	Copenhagen University Zoological Museum	Henrick Enghoff





<b>Z. cervicalis</b>																															
male	<b>Mean</b>	<b>11.77852</b>	<b>11.14</b>	<b>2.46</b>	<b>0.77</b>	<b>1.33</b>	<b>0.7</b>	<b>1.22</b>	<b>0.85</b>	<b>4.7</b>	<b>1.2</b>	<b>4.792</b>	<b>1.8</b>	<b>4.661</b>	<b>5.1</b>	<b>3.1</b>	<b>3.76</b>	<b>4.39</b>	<b>5.34</b>	<b>0.83</b>	<b>1.45</b>	<b>0.3</b>	<b>0.87</b>	<b>0.53</b>	<b>1.13</b>	<b>1.71</b>	<b>1.64</b>	<b>0.3</b>	<b>0.26</b>	<b>0.21</b>	
	SD	0.865492	0.847	0.19	0.06	0.14	0.08	0.16	0.14	0.55	0.1	0.608	0.154	0.428	0.43	0.4	0.67	0.45	0.45	0.11	0.18	0.1	0.07	0.06	0.11	0.2	0.3	0	0.02	0.08	
	Range	3.2607	2.741	0.5	0.17	0.42	0.25	0.47	0.43	1.77	0.2	1.535	0.406	1.376	1.34	1.18	2.4	1.37	1.44	0.34	0.56	0.1	0.21	0.19	0.31	0.53	0.86	0.1	0.06	0.28	
	Minimum	9.8146	9.529	2.19	0.7	1.11	0.58	0.97	0.66	3.63	1.1	3.908	1.69	3.836	4.29	2.31	2	3.53	4.71	0.6	1.21	0.2	0.77	0.43	0.98	1.47	1.12	0.2	0.23	0	
	Maximum	13.0753	12.27	2.69	0.87	1.53	0.83	1.44	1.1	5.4	1.3	5.442	2.097	5.212	5.64	3.5	4.4	4.9	6.15	0.94	1.77	0.4	0.98	0.62	1.3	2	1.98	0.4	0.3	0.28	
	Count	13	13	10	10	10	10	10	10	13	9	10	6	10	10	10	10	8	8	9	9	8	10	10	10	10	10	10	10	10	
female	<b>Mean</b>	<b>14.2537</b>	<b>13.89</b>	<b>2.86</b>	<b>0.94</b>	<b>1.55</b>	<b>0.81</b>	<b>1.56</b>	<b>1.11</b>	<b>5.52</b>	<b>1.4</b>	<b>4.678</b>	<b>1.606</b>	<b>5.461</b>	<b>5.93</b>	<b>3.8</b>	<b>4.66</b>	<b>5.31</b>	<b>6.32</b>	<b>0.98</b>	<b>1.79</b>	<b>0.4</b>	<b>0.96</b>	<b>0.61</b>	<b>1.39</b>	<b>2.2</b>	<b>2.34</b>	<b>0.3</b>	<b>0.35</b>	<b>0.26</b>	
	SD	0.717267	0.802	0.18	0.12	0.08	0.09	0.09	0.12	0.61	0.1	0.7	0.447	0.773	0.73	0.32	0.37	0.6	0.54	0.08	0.11	0.1	0.06	0.05	0.13	0.18	0.39	0	0.03	0.02	
	Range	2.3711	2.359	0.51	0.38	0.27	0.25	0.33	0.38	2	0.3	1.785	1.275	2.513	2.36	0.89	0.89	1.53	1.41	0.2	0.33	0.2	0.19	0.14	0.45	0.58	1.19	0.1	0.09	0.07	
	Minimum	12.8854	12.71	2.64	0.75	1.43	0.66	1.38	0.94	4.36	1.3	3.869	0.783	3.625	4.37	3.31	4.22	4.51	5.71	0.88	1.59	0.2	0.83	0.53	1.15	1.92	1.73	0.3	0.3	0.22	
	Maximum	15.2565	15.07	3.15	1.13	1.69	0.91	1.71	1.32	6.36	1.6	5.654	2.058	6.138	6.73	4.2	5.11	6.04	7.12	1.08	1.92	0.4	1.01	0.68	1.6	2.5	2.91	0.4	0.39	0.29	
	Count	10	10	10	10	10	10	9	10	9	7	6	10	10	9	9	9	9	9	10	10	10	10	10	10	10	10	10	9	9	
<b>chamaeleon</b>																															
male	<b>Mean</b>	<b>13.45</b>	<b>11.76</b>	<b>2.20</b>	<b>0.68</b>	<b>1.06</b>	<b>0.54</b>	<b>1.75</b>	<b>1.04</b>	<b>4.38</b>	<b>1.15</b>	<b>5.52</b>	-	<b>4.67</b>	<b>4.90</b>	<b>3.47</b>	<b>4.31</b>	<b>4.41</b>	<b>5.66</b>	<b>0.81</b>	<b>1.31</b>	<b>0.32</b>	<b>1.14</b>	<b>0.55</b>	<b>1.47</b>	<b>3.23</b>	<b>2.32</b>	<b>0.26</b>	<b>0.26</b>	<b>0.24</b>	
	SD	0.63	0.55	0.10	0.06	0.08	0.10	0.13	0.16	0.23	0.09	1.01	-	0.20	0.20	0.03	0.05	0.21	0.28	0.08	0.08	0.09	0.03	0.05	0.09	0.30	0.34	0.02	0.00	0.00	
	Range	1.57	1.52	0.21	0.15	0.18	0.26	0.33	0.42	0.45	0.16	1.97	-	0.40	0.40	0.04	0.07	0.43	0.56	0.18	0.18	0.19	0.07	0.12	0.25	0.78	0.84	0.03	0.00	0.00	
	Minimum	12.50	10.98	2.11	0.62	0.96	0.43	1.59	0.89	4.17	1.05	4.66	-	4.47	4.69	3.45	4.28	4.22	5.39	0.69	1.24	0.25	1.10	0.49	1.37	2.76	2.08	0.24	0.26	0.24	
	Maximum	14.06	12.49	2.32	0.77	1.14	0.69	1.91	1.31	4.62	1.21	6.63	-	4.87	5.09	3.49	4.35	4.64	5.95	0.87	1.42	0.44	1.18	0.61	1.62	3.54	2.92	0.27	0.26	0.24	
	Count	5	5	5	5	5	5	5	3	3	3	3	-	3	3	2	2	3	3	4	4	4	5	5	5	5	5	3	2	3	
male	<b>Mean</b>	<b>14.38782</b>	<b>13.69</b>	<b>2.37</b>	<b>0.72</b>	<b>1.19</b>	<b>0.58</b>	<b>1.97</b>	<b>1.09</b>	<b>4.57</b>	<b>1.2</b>	<b>3.827</b>	<b>1.657</b>	<b>4.705</b>	<b>4.42</b>	<b>3.67</b>	<b>4.65</b>	<b>4.48</b>	<b>6.17</b>	<b>1.06</b>	<b>1.48</b>	<b>0.4</b>	<b>1.19</b>	<b>0.66</b>	<b>1.7</b>	<b>3.8</b>	<b>3.41</b>	<b>0.3</b>	<b>0.36</b>	<b>0.29</b>	
	SD	0.652784	0.588	0.13	0.13	0.08	0.1	0.14	0.27	0.37	0	0.002	-	0.298	0.99	0.37	0.2	0.25	0.17	0.08	0.09	0.1	0.02	0.03	0.04	0.3	0.26	0	0.02	0.02	
	Range	1.5729	1.387	0.31	0.31	0.2	0.25	0.29	0.58	0.72	0.1	0.003	-	0.682	2.34	0.77	0.44	0.54	0.38	0.21	0.22	0.1	0.04	0.06	0.1	0.69	0.6	0	0.05	0.05	
	Minimum	13.4468	12.64	2.21	0.5	1.07	0.46	1.84	0.84	4.18	1.2	3.826	1.657	4.371	3.04	3.3	4.35	4.19	5.93	0.97	1.38	0.4	1.16	0.61	1.65	3.44	3.15	0.3	0.34	0.26	
	Maximum	15.0197	14.03	2.52	0.81	1.27	0.71	2.13	1.42	4.9	1.2	3.829	1.657	5.053	5.38	4.07	4.79	4.73	6.31	1.18	1.61	0.5	1.2	0.67	1.75	4.12	3.75	0.3	0.39	0.32	
	Count	5	5	5	5	5	5	5	4	2	2	1	4	4	4	4	4	4	4	5	5	5	5	5	5	5	5	5	4	4	4
<b>championi</b>																															
male	<b>Mean</b>	<b>15.3268</b>	<b>11.79</b>	<b>2.61</b>	<b>0.87</b>	<b>1.24</b>	<b>0.72</b>	<b>1.94</b>	<b>1.2</b>	<b>5.69</b>	<b>2.2</b>	<b>5.896</b>	<b>1.643</b>	<b>5.77</b>	<b>6.31</b>	<b>4.28</b>	<b>5.6</b>	<b>5.57</b>	<b>7.36</b>	<b>1.08</b>	<b>1.56</b>	<b>0.4</b>	<b>1.25</b>	<b>0.59</b>	<b>1.82</b>	<b>3.14</b>	<b>2.97</b>	<b>0.3</b>	<b>0.32</b>	<b>0.35</b>	
	SD	0.697642	0.528	0.09	0.03	0.06	0.1	0.18	0.26	0.16	1.8	0.694	0.059	0.267	0.22	0.16	0.09	0.31	0.32	0.12	0.04	0.1	0.04	0.06	0.07	0.07	0.23	0	0.02	0.02	
	Range	1.9622	1.436	0.25	0.08	0.14	0.27	0.49	0.64	0.39	4.5	1.883	0.132	0.645	0.48	0.42	0.23	0.77	0.73	0.31	0.11	0.2	0.1	0.13	0.2	0.19	0.65	0.1	0.05	0.03	
	Minimum	14.2151	10.85	2.5	0.83	1.18	0.59	1.66	1.02	5.48	1.4	4.998	1.582	5.332	6.08	4	5.5	5.19	6.89	0.92	1.49	0.3	1.2	0.51	1.72	3.03	2.67	0.3	0.3	0.33	
	Maximum	16.1773	12.29	2.75	0.91	1.32	0.86	2.15	1.66	5.87	5.9	6.88	1.715	5.977	6.56	4.42	5.73	5.95	7.63	1.23	1.6	0.5	1.31	0.64	1.92	3.22	3.32	0.3	0.35	0.36	
	Count	6	6	5	5	5	5	5	5	6	6	5	5	5	5	5	5	4	4	5	5	5	5	5	5	5	5	5	5	4	
<b>conjungens</b>																															
male	<b>Mean</b>	<b>18.34</b>	<b>17.35</b>	<b>3.46</b>	<b>1.15</b>	<b>1.78</b>	<b>1.11</b>	<b>2.49</b>	<b>1.38</b>	<b>7.06</b>	<b>2.42</b>	<b>5.73</b>	<b>1.76</b>	<b>7.28</b>	<b>7.51</b>	<b>5.42</b>	<b>6.05</b>	<b>6.80</b>	<b>7.84</b>	<b>1.40</b>	<b>1.93</b>	<b>0.59</b>	<b>1.51</b>	<b>0.86</b>	<b>2.46</b>	<b>5.20</b>	<b>3.72</b>	<b>0.53</b>	<b>0.53</b>	<b>0.45</b>	
	SD	1.04	1.25	0.17	0.13	0.08	0.11	0.17	0.19	0.85	0.24	0.89	0.58	0.52	0.66	0.41	0.53	0.52	0.77	0.09	0.23	0.09	0.10	0.06	0.19	0.53	0.39	0.04	0.04	0.06	
	Range	3.16	3.76	0.54	0.45	0.20	0.31	0.59	0.52	2.37	0.71	3.16	1.24	1.50	1.58	0.95	1.45	1.31	2.29	0.29	0.65	0.25	0.32	0.18	0.48	1.68	1.25	0.12	0.11	0.17	
	Minimum	16.64	15.07	3.22	0.99	1.68	0.92	2.21	1.07	5.82	2.07	4.26	0.91	6.41	6.79	5.02	5.29	6.12	6.77	1.22	1.59	0.42	1.37	0.74	2.21	4.30	3.06	0.47	0.47	0.38	
	Maximum	19.80	18.83	3.76	1.44	1.88	1.23	2.80	1.59	8.19	2.77	7.42	2.16	7.91	8.37	5.97	6.74	7.43	9.05	1.51	2.24	0.67	1.70	0.92	2.69	5.97	4.31	0.59	0.58	0.55	
	Count	11	11	8	8	8	8	8	8	9	9	9	4	7	7	7	7	7	6	8	8	8	8	8	8	8	8	7	7	7	
male	<b>Mean</b>	<b>21.68</b>	<b>21.25</b>	<b>3.86</b>	<b>1.32</b>	<b>1.99</b>	<b>1.24</b>	<b>2.99</b>	<b>1.47</b>	<b>7.68</b>	<b>2.42</b>	<b>5.89</b>	<b>2.04</b>	<b>8.01</b>	<b>8.33</b>	<b>5.85</b>	<b>6.82</b>	<b>7.73</b>	<b>8.75</b>	<b>1.63</b>	<b>2.29</b>	<b>0.72</b>	<b>1.67</b>	<b>0.99</b>	<b>2.87</b>	<b>6.55</b>	<b>5.80</b>	<b>0.68</b>	<b>0.75</b>	<b>0.51</b>	
	SD	0.69	0.62	0.29	0.11	0.22	0.10	0.24	0.14	0.48	0.18	0.36	0.24	0.53	0.61	0.55	0.38	0.52	0.30	0.11	0.11	0.08	0.06	0.06	0.10	0.36	0.55	0.04	0.14	0.02	
	Range	1.90	1.62	0.87	0.28	0.60	0.27	0.58	0.38	1.28	0.43																				









<b>Z. janus</b>																														
male	Mean	17.63	16.74	3.24	1.08	1.63	1.21	2.37	1.32	7.38	2.30	5.48	2.08	7.12	7.49	5.28	5.84	7.73	8.37	1.42	1.84	0.42	1.42	0.83	2.32	4.91	3.05	0.52	0.49	0.40
	SD	1.39	1.10	0.22	0.16	0.07	0.12	0.15	0.26	0.86	0.21	0.92	0.15	0.77	0.83	0.66	0.72	0.69	1.01	0.09	0.15	0.11	0.08	0.07	0.21	0.45	0.28	0.07	0.05	0.06
	Range	4.11	3.40	0.64	0.43	0.22	0.34	0.49	0.71	2.45	0.65	2.44	0.22	2.04	2.12	1.71	1.79	1.75	2.53	0.27	0.44	0.29	0.21	0.18	0.67	1.32	0.82	0.18	0.13	0.16
	Minimum	15.44	14.95	2.98	0.93	1.50	1.05	2.04	0.94	6.20	1.93	4.29	1.98	6.23	6.56	4.54	5.08	6.85	7.16	1.31	1.58	0.29	1.31	0.74	1.95	3.99	2.59	0.42	0.42	0.32
	Maximum	19.55	18.36	3.61	1.36	1.72	1.40	2.53	1.64	8.65	2.58	6.73	2.19	8.27	8.68	6.25	6.86	8.60	9.68	1.59	2.02	0.58	1.52	0.91	2.63	5.31	3.41	0.60	0.54	0.48
	Count	10	10	7	7	7	7	7	6	9	9	7	2	6	6	6	6	5	5	6	7	7	7	7	7	7	7	6	6	5
female	Mean	20.53	19.73	3.69	1.26	1.87	1.24	2.79	1.53	7.34	2.24	6.34	1.95	7.70	8.12	5.71	6.35	7.45	8.84	1.52	2.03	0.57	1.53	0.92	2.66	5.97	5.15	0.61	0.60	0.45
	SD	1.10	1.24	0.11	0.10	0.12	0.12	0.27	0.21	0.61	0.17	0.33	0.05	0.70	0.63	0.39	0.43	0.81	0.68	0.09	0.15	0.07	0.06	0.04	0.16	0.28	0.52	0.04	0.04	0.05
	Range	2.94	3.34	0.39	0.34	0.37	0.40	0.92	0.67	1.99	0.50	0.72	0.11	2.23	1.79	1.21	1.41	2.44	2.00	0.28	0.35	0.19	0.19	0.14	0.53	0.98	1.41	0.11	0.10	0.14
	Minimum	19.01	18.08	3.51	1.11	1.63	0.98	2.28	1.31	6.34	1.99	5.91	1.90	6.65	7.17	4.93	5.72	6.19	7.92	1.37	1.91	0.49	1.42	0.82	2.40	5.49	4.41	0.55	0.53	0.39
	Maximum	21.96	21.42	3.90	1.44	1.99	1.38	3.20	1.98	8.34	2.50	6.64	2.01	8.88	8.96	6.13	7.13	8.63	9.92	1.65	2.27	0.68	1.61	0.96	2.94	6.48	5.82	0.66	0.63	0.53
	Count	8	8	8	8	8	8	8	8	8	7	6	4	8	8	8	8	7	7	7	7	7	8	8	8	8	8	8	8	8
<b>Z. kartabenooides</b>																														
male	Mean	11.60	10.89	2.63	0.79	1.39	0.65	1.58	0.79	5.57	3.68	6.15	-	5.13	5.23	2.71	3.64	-	-	0.79	1.66	0.33	1.06	0.54	1.40	2.29	1.68	2.04	0.18	-
	SD	0.37	0.51	0.11	0.02	0.07	0.02	0.08	0.06	0.46	2.72	-	-	-	-	-	-	-	-	0.06	0.03	0.03	0.03	0.06	0.11	0.11	0.04	2.59	-	-
	Range	0.40	1.02	0.22	0.04	0.14	0.00	0.02	0.10	0.65	3.85	-	-	-	-	-	-	-	-	0.09	0.05	0.00	0.02	0.09	0.06	0.09	0.04	3.67	-	-
	Minimum	11.22	10.38	2.51	0.77	1.32	0.63	1.53	0.74	5.25	1.76	6.15	-	5.13	5.23	2.71	3.64	-	-	0.74	1.64	0.29	1.02	0.49	1.31	2.18	1.64	0.20	0.18	-
	Maximum	11.61	11.39	2.73	0.81	1.45	0.67	1.54	0.86	5.89	5.61	6.15	-	5.13	5.23	2.71	3.64	-	-	0.86	1.70	0.35	1.09	0.61	1.36	2.27	1.72	3.87	0.18	-
	Count	3	3	3	3	3	3	3	3	2	2	1	-	1	1	1	1	0	0	3	3	3	3	3	3	3	3	2	1	0
<b>Z. kartabensis</b>																														
male	Mean	11.94	11.34	2.76	0.72	1.34	0.62	1.51	0.81	6.32	1.83	6.32	2.11	5.48	6.30	3.68	4.97	4.87	6.12	0.91	1.78	0.43	1.09	0.57	1.31	2.32	1.72	0.24	0.23	0.21
	SD	0.83	1.03	0.16	-	0.06	0.04	-	-	0.64	0.07	0.26	0.10	0.73	0.48	0.76	0.45	0.61	1.06	0.12	0.16	0.02	0.08	0.04	0.15	0.14	0.08	0.06	0.07	0.02
	Range	1.70	2.07	0.23	0.00	0.09	0.05	0.00	0.00	1.41	0.13	0.51	0.14	1.04	0.68	1.08	0.63	0.86	1.49	0.17	0.23	0.03	0.11	0.06	0.21	0.20	0.11	0.08	0.11	0.03
	Minimum	10.97	10.27	2.65	0.72	1.30	0.59	1.51	0.81	5.57	1.76	6.02	2.04	4.97	5.96	3.14	4.66	4.44	5.37	0.82	1.66	0.42	1.04	0.54	1.20	2.22	1.67	0.20	0.18	0.19
	Maximum	12.67	12.34	2.88	0.72	1.39	0.64	1.51	0.81	6.97	1.89	6.53	2.18	6.00	6.63	4.22	5.29	5.30	6.87	1.00	1.89	0.44	1.15	0.60	1.41	2.41	1.78	0.27	0.28	0.22
	Count	4.00	4.00	2.00	1.00	2.00	2.00	1.00	1.00	4.00	3.00	3.00	2.00	2.00	2.00	2.00	2.00	2.00	2.00	2.00	2.00	2.00	2.00	2.00	2.00	2.00	2.00	2.00	2.00	2.00
female	Mean	16.52726	15.83	3.58	1.24	1.74	0.88	2.1	1.16	7.87	2.3	6.214	2.398	7.209	8.06	5.03	6.1	6.35	7.54	1.2	2.26	0.5	1.27	0.68	1.73	3.71	3.62	0.4	0.39	0.31
	SD	0.80	0.48	0.15	0.10	0.13	0.03	0.10	0.07	0.52	0.15	0.52	-	0.67	0.43	0.28	0.39	0.39	0.44	0.06	0.25	0.06	0.05	0.02	0.12	0.22	0.37	0.01	0.04	0.05
	Range	1.96	1.09	0.38	0.21	0.36	0.09	0.26	0.15	1.24	0.34	1.20	-	1.82	1.17	0.70	0.97	0.97	0.97	0.15	0.60	0.13	0.12	0.05	0.25	0.56	0.89	0.03	0.09	0.10
	Minimum	15.49	15.32	3.46	1.11	1.56	0.83	1.96	1.09	7.29	2.13	5.60	2.40	6.31	7.44	4.71	5.70	5.75	7.22	1.16	1.86	0.44	1.21	0.65	1.58	3.44	3.17	0.36	0.34	0.26
	Maximum	17.45	16.41	3.84	1.32	1.92	0.92	2.22	1.24	8.53	2.48	6.80	2.40	8.13	8.62	5.41	6.67	6.73	8.18	1.31	2.47	0.57	1.34	0.70	1.83	4.01	4.06	0.38	0.43	0.36
	Count	5	5	5	5	5	5	5	4	5	4	4	1	5	5	5	5	5	4	5	5	4	5	5	5	5	4	5	5	5
<b>Z. korystos</b>																														
male	Mean	10.98	10.48	2.46	0.63	1.33	0.62	1.34	0.86	5.57	1.32	6.90	-	5.40	5.84	4.09	4.94	5.22	6.17	0.80	1.60	0.36	1.09	0.53	1.12	2.57	1.30	0.17	0.16	0.16
	SD	0.80	0.52	0.15	0.15	0.16	0.09	0.20	0.08	0.26	-	-	-	0.23	0.28	0.10	0.09	0.33	0.04	0.05	0.15	0.09	0.06	0.07	0.18	0.09	0.17	0.01	0.02	0.00
	Range	1.13	0.92	0.28	0.27	0.30	0.17	0.39	0.16	0.50	-	-	-	0.45	0.55	0.14	0.13	0.47	0.05	0.08	0.30	0.18	0.11	0.14	0.31	0.16	0.35	0.01	0.02	0.01
	Minimum	10.42	9.88	2.35	0.46	1.15	0.53	1.12	0.77	5.37	1.32	6.90	-	5.14	5.55	4.02	4.88	4.99	6.14	0.75	1.44	0.27	1.02	0.48	0.92	2.50	1.11	0.17	0.15	0.16
	Maximum	11.55	10.80	2.63	0.72	1.44	0.69	1.52	0.93	5.87	1.32	6.90	-	5.59	6.11	4.16	5.01	5.45	6.19	0.83	1.74	0.45	1.13	0.61	1.23	2.67	1.46	0.18	0.17	0.16
	Count	2	3	3	3	3	3	3	3	3	1	1	0	3	3	2	2	2	2	3	3	3	3	3	3	3	3	3	2	2
<b>Z. laticornis</b>																														
male	Mean	10.82	10.69	2.39	0.73	1.25	0.58	1.62	0.62	4.34	1.32	4.05	1.62	3.97	4.39	3.01	3.82	3.60	4.61	0.83	1.49	0.38	1.07	0.62	1.38	2.51	1.76	0.20	0.24	0.21
	SD	0.52	0.49	0.16	0.10	0.04	0.05	0.13	0.15	0.23	0.05	0.46	0.26	0.30	0.37	0.29	0.36	0.56	0.30	0.06	0.07	0.09	0.07	0.02	0.09	0.21	0.10	0.02	0.03	0.03
	Range	1.49	1.36	0.34	0.23	0.11	0.12	0.31	0.35	0.60	0.14	1.05	0.60	0.75	0.88	0.71	0.85	1.50	0.62	0.13	0.19	0.23	0.16	0.06	0.21	0.50	0.24	0.04	0.06	0.06
	Minimum	9.94	9.79	2.20	0.61	1.21	0.50	1.52	0.48	4.05	1.24	3.43	1.40	3.63	4.04	2.51	3.40	2.73	4.33	0.79	1.37	0.27	0.99	0.58	1.26	2.30	1.66	0.17	0.21	0.19
	Maximum	11.44	11.16	2.54	0.84	1.32	0.62	1.83	0.83	4.66	1.38	4.48	2.00	4.39	4.92	3.22	4.25	4.22	4.95	0.92	1.56	0.50	1.15	0.64	1.47	2.80	1.90	0.22	0.27	0.25
	Count	8	8	5	5	5	5	5	4	7	7	6	4	5	5	5	5	5	5	4	5	5	5	5	5	5	4	5	5	5







<b>Z. pedestris</b>																														
male	Mean	10.60	10.16	2.29	0.67	1.19	0.60	1.28	0.95	4.49	1.14	5.53	1.55	4.22	4.55	3.22	3.87	4.11	5.04	0.71	1.47	0.27	0.97	0.46	1.24	2.17	1.26	0.19	0.20	0.17
	SD	0.72	0.65	0.08	0.05	0.09	0.07	0.06	0.21	0.51	0.09	0.20	0.10	0.42	0.28	0.28	0.39	0.61	0.69	0.05	0.10	0.05	0.06	0.03	0.07	0.11	0.05	0.02	0.02	0.03
	Range	1.77	1.76	0.19	0.12	0.18	0.19	0.14	0.52	1.69	0.29	0.52	0.26	1.05	0.59	0.67	0.94	1.49	1.51	0.14	0.24	0.11	0.16	0.09	0.19	0.25	0.10	0.05	0.04	0.08
	Minimum	9.63	9.30	2.19	0.61	1.09	0.52	1.22	0.70	3.51	1.00	5.23	1.40	3.78	4.29	3.00	3.58	3.40	4.40	0.66	1.36	0.19	0.90	0.40	1.15	2.03	1.22	0.17	0.18	0.14
	Maximum	11.40	11.05	2.38	0.72	1.27	0.71	1.35	1.22	5.20	1.28	5.75	1.66	4.83	4.88	3.67	4.52	4.89	5.91	0.80	1.61	0.30	1.06	0.50	1.34	2.28	1.32	0.21	0.22	0.22
	Count	8	8	5	5	5	5	5	5	8	8	7	5	5	5	5	5	4	4	5	5	5	5	5	5	5	4	5	5	4
female	Mean	13.09	12.51	2.65	0.86	1.36	0.68	1.62	1.09	5.08	1.35	4.40	1.19	4.59	4.91	3.70	4.76	4.70	5.59	0.88	1.62	0.32	1.02	0.50	1.35	2.80	2.05	0.26	0.27	0.23
	SD	0.68	0.91	0.09	0.05	0.08	0.05	0.15	0.25	0.33	0.07	0.36	0.39	0.60	0.30	0.48	0.83	0.35	0.32	0.04	0.15	0.08	0.05	0.01	0.08	0.26	0.29	0.02	0.03	0.02
	Range	1.48	2.36	0.23	0.10	0.21	0.11	0.37	0.54	0.89	0.16	0.87	0.68	1.54	0.74	1.31	1.96	0.86	0.76	0.09	0.37	0.20	0.12	0.03	0.22	0.67	0.72	0.04	0.07	0.06
	Minimum	12.15	11.10	2.55	0.81	1.27	0.63	1.44	0.85	4.59	1.27	4.02	0.96	3.57	4.58	2.99	4.27	4.30	5.21	0.82	1.48	0.21	0.97	0.48	1.26	2.52	1.57	0.24	0.21	0.20
	Maximum	13.63	13.46	2.78	0.92	1.48	0.74	1.80	1.38	5.47	1.43	4.89	1.64	5.11	5.32	4.29	6.23	5.16	5.98	0.91	1.85	0.41	1.09	0.52	1.48	3.19	2.29	0.28	0.29	0.26
	Count	5	5	5	5	5	5	5	5	5	5	5	3	5	5	5	5	5	5	5	5	5	5	5	5	5	5	5	5	5
<b>Z. plagiatus</b>																														
female	Mean	14.32	13.80	3.20	1.03	1.64	0.74	1.97	1.04	6.55	1.91	6.27	1.77	6.52	7.07	4.44	5.48	5.79	7.07	1.02	2.09	0.47	1.19	0.58	1.62	3.31	2.95	0.29	0.33	0.24
	SD	0.90	0.93	0.19	0.07	0.10	0.11	0.21	0.10	1.01	0.21	0.83	0.41	0.63	0.47	0.44	0.31	0.29	0.48	0.07	0.16	0.02	0.04	0.12	0.09	0.21	0.34	0.03	0.02	0.01
	Range	2.23	2.29	0.50	0.18	0.25	0.22	0.51	0.25	2.75	0.60	2.15	1.06	1.35	0.99	1.08	0.73	0.65	1.17	0.20	0.40	0.05	0.10	0.28	0.25	0.53	0.76	0.07	0.06	0.03
	Minimum	13.20	12.92	2.97	0.93	1.48	0.63	1.73	0.92	4.85	1.53	5.36	1.07	5.73	6.48	3.75	5.04	5.46	6.43	0.91	1.83	0.44	1.14	0.39	1.48	3.08	2.53	0.25	0.31	0.23
	Maximum	15.43	15.20	3.47	1.11	1.73	0.86	2.24	1.16	7.60	2.12	7.51	2.13	7.09	7.46	4.84	5.77	6.11	7.60	1.10	2.23	0.49	1.24	0.67	1.73	3.61	3.29	0.32	0.37	0.26
	Count	6	6	5	5	5	5	5	5	6	6	5	5	5	5	5	5	5	4	5	5	5	5	5	5	5	5	5	5	5
<b>Z. prolixus</b>																														
male	Mean	9.35	8.63	1.81	0.50	0.98	0.54	1.03	0.54	3.71	1.02	3.10	0.62	3.93	4.57	2.66	3.56	3.56	4.53	0.47	1.10	0.26	0.81	0.41	0.88	1.43	1.17	0.16	0.16	0.14
	SD	0.78	0.56	0.06	0.06	0.05	0.02	0.15	0.16	0.33	0.09	0.53	0.03	0.32	0.22	0.23	0.30	0.41	0.38	0.06	0.05	0.06	0.05	0.07	0.11	0.14	0.13	0.01	0.01	0.01
	Range	1.96	1.64	0.15	0.15	0.11	0.05	0.37	0.43	0.83	0.20	1.45	0.05	0.71	0.50	0.44	0.53	0.81	0.76	0.13	0.11	0.14	0.13	0.20	0.30	0.33	0.33	0.02	0.01	0.01
	Minimum	8.14	7.56	1.74	0.42	0.91	0.52	0.77	0.36	3.44	0.94	2.52	0.59	3.67	4.40	2.40	3.22	3.17	4.15	0.43	1.02	0.18	0.75	0.31	0.70	1.20	0.98	0.15	0.15	0.14
	Maximum	10.10	9.20	1.89	0.57	1.03	0.57	1.14	0.79	4.27	1.14	3.98	0.64	4.38	4.90	2.84	3.74	3.98	4.91	0.56	1.13	0.32	0.88	0.52	1.00	1.53	1.31	0.17	0.17	0.15
	Count	6	6	5	5	5	5	5	5	5	5	5	3	4	4	3	3	3	3	4	4	4	5	5	5	5	5	3	3	3
female	Mean	11.10	10.87	2.14	0.64	1.10	0.60	1.21	0.71	4.50	1.37	3.16	0.76	4.61	4.82	3.31	4.23	4.30	5.13	0.60	1.31	0.29	0.87	0.45	1.04	1.68	1.68	0.20	0.17	0.17
	SD	0.66	0.66	0.14	0.09	0.09	0.06	0.07	0.16	0.63	0.16	0.39	0.07	0.51	0.51	0.56	0.26	0.62	0.38	0.10	0.10	0.07	0.06	0.04	0.04	0.15	0.23	0.02	0.03	0.02
	Range	1.50	1.58	0.36	0.24	0.25	0.18	0.20	0.33	1.58	0.37	0.76	0.18	1.38	1.41	1.45	0.54	1.65	0.88	0.21	0.28	0.16	0.14	0.11	0.08	0.39	0.57	0.06	0.07	0.06
	Minimum	10.29	10.11	1.98	0.51	1.01	0.53	1.09	0.54	3.87	1.18	2.84	0.67	3.78	4.04	2.62	3.99	3.71	4.72	0.48	1.20	0.21	0.84	0.38	1.00	1.49	1.32	0.19	0.14	0.15
	Maximum	11.79	11.69	2.34	0.75	1.26	0.70	1.29	0.87	5.45	1.55	3.60	0.84	5.16	5.45	4.07	4.53	5.36	5.60	0.69	1.48	0.38	0.98	0.50	1.08	1.88	1.89	0.25	0.21	0.21
	Count	5	5	5	5	5	5	5	4	5	5	5	4	5	5	5	4	5	5	5	5	5	5	5	5	5	5	5	5	5
<b>Z. puertoricensis</b>																														
male	Mean	11.20	10.92	2.05	0.68	1.01	0.71	1.18	0.95	4.47	1.22	3.67	1.16	4.36	4.55	3.27	3.74	4.24	4.91	0.67	1.24	0.35	0.91	0.47	1.06	1.67	1.26	0.20	0.19	0.18
	SD	0.60	0.64	0.09	0.06	0.08	0.09	0.16	0.12	0.53	0.13	0.54	0.16	0.38	0.46	0.32	0.37	0.31	0.69	0.07	0.09	0.04	0.05	0.03	0.08	0.17	0.40	0.03	0.02	0.02
	Range	1.52	1.51	0.27	0.15	0.20	0.24	0.41	0.33	1.15	0.36	1.13	0.38	0.86	1.27	0.73	0.87	0.57	1.36	0.19	0.25	0.11	0.15	0.09	0.22	0.41	0.88	0.06	0.04	0.05
	Minimum	10.22	10.08	1.89	0.60	0.92	0.62	0.90	0.80	3.74	1.08	3.25	0.93	3.81	3.96	2.83	3.26	3.89	4.16	0.60	1.14	0.29	0.82	0.42	0.94	1.45	0.70	0.17	0.17	0.16
	Maximum	11.74	11.59	2.16	0.75	1.13	0.85	1.30	1.13	4.89	1.44	4.37	1.31	4.67	5.23	3.56	4.13	4.46	5.52	0.78	1.39	0.40	0.97	0.50	1.16	1.87	1.58	0.23	0.21	0.21
	Count	6	6	6	6	6	6	6	5	6	6	5	4	6	6	6	6	3	3	6	6	6	6	6	6	6	5	6	6	3
female	Mean	13.20	13.02	2.36	0.76	1.17	0.80	1.54	1.13	4.70	1.31	3.86	1.07	5.02	5.28	3.53	4.04	4.66	5.69	0.79	1.39	0.36	0.97	0.50	1.29	2.17	1.95	0.28	0.26	0.24
	SD	0.84	0.87	0.12	0.06	0.09	0.08	0.12	0.12	0.31	0.11	0.05	-	0.40	0.50	0.31	0.44	0.16	0.18	0.05	0.08	0.06	0.08	0.04	0.13	0.24	0.29	0.01	0.02	0.02
	Range	2.31	2.25	0.34	0.14	0.23	0.23	0.33	0.29	0.84	0.24	0.09	-	1.03	1.38	0.66	1.05	0.44	0.45	0.12	0.23	0.18	0.22	0.12	0.37	0.58	0.76	0.02	0.04	0.04
	Minimum	12.03	11.93	2.13	0.68	1.01	0.68	1.38	1.00	4.23	1.21	3.80	1.07	4.24	4.31	3.06	3.45	4.42	5.40	0.73	1.30	0.27	0.82	0.46	1.14	1.88	1.62	0.27	0.23	0.21
	Maximum	14.33	14.17	2.46	0.82	1.25	0.91	1.71	1.29	5.07	1.46	3.89	1.07	5.27	5.69	3.72	4.49	4.87	5.85	0.85	1.53	0.45	1.05	0.58	1.51	2.46	2.38	0.29	0.27	0.25
	Count	6																												











## CONCLUSION

The current dissertation research contributes to the knowledge of the diversity, taxonomy, systematics, morphology and evolution of Reduviidae, the assassin bugs, with a focus on two subfamilies, Peiratinae and Harpactorinae.

In the first chapter the systematics of the Malagasy *Bekilya* group was reviewed. The Madagascar endemic assassin bugs *Bekilya* Villiers and *Hovacoris* Villiers were described from macropterous male specimens with striking colour patterns, and are currently monotypic. *Mutillocoris* Villiers, with two species from Madagascar, was based on brachypterous female specimens that resemble female mutillid wasps. To investigate the validity of the three genera, recently collected specimens from Madagascar were studied with both morphological and molecular techniques. Morphology alone appeared to be of limited value for associating males with females, and immature stages with adults, because of drastic differences between the sexes and the life stages. However, the use of morphology in conjunction with molecular data resolved these associations and showed that species of *Mutillocoris* represent females of *Bekilya* and *Hovacoris*, which we transfer accordingly to these two genera and refer to them as the *Bekilya* group. The type species of *Mutillocoris* belongs in *Bekilya*, resulting in the synonymy of these two genera (*Mutillocoris* **syn. nov.**). The *Bekilya* group is diagnosed and several new species are described: *Bekilya mahafalya* **sp. nov.**, *Bekilya tenebra* **sp. nov.**, *Bekilya tuleara* **sp. nov.**, *Hovacoris bicolornotum* **sp. nov.**, *Hovacoris melanoceps* **sp. nov.** and *Hovacoris rufiventris* **sp. nov.** A total of ten species are recognized within the *Bekilya* group. The monophyly of *Bekilya*, *Hovacoris* and the *Bekilya* group is confirmed by morphological and molecular phylogenetic analyses.

In the second chapter a comparative morphological study of 'sticky glands' and associated cuticular structures was performed. For more than 50 years, specialized dermal glands that secrete sticky substances and specialized setae have been known from the legs of New World assassin bugs in the genus *Zelus* Fabricius (Reduviidae: Harpactorinae). The gland secretions and specialized 'sundew setae' are involved in enhancing predation success. We here refer to this predation strategy as 'sticky trap predation' and the specialized dermal glands as 'sticky glands'. To determine how widespread sticky trap predation is among Reduviidae, we investigated taxonomic distribution of sticky glands and sundew setae using compound light microscopical and scanning electron microscopical techniques and sampling 67 species of Reduviidae that represent 50 genera of Harpactorini. We found sticky glands in 12 genera of Harpactorini and thus show that sticky trap predation is much more widespread than previously suspected. The sticky glands vary in shape, size and density, but are always located in a dorsolateral position on the fore tibia. Sundew setae are present in all taxa with sticky glands with the exception of *Heza* that instead possesses unique lamellate setae. The sticky trap predation taxa are restricted to the New World, suggesting a New World origin of this unique predation strategy.

The third chapter has dealt with the molecular phylogenetics of Harpactorini, based on which the evolution of sticky trap predation was investigated. Much research has focused on the effects of key innovations on species diversification, whereas little has been done to investigate their role in morphological evolution. A phylogenetically informed study was here performed to demonstrate a correlation between a putative key innovation, the sticky trap predation strategy, and accelerated morphological diversification of the predatory fore leg in assassin bugs. Based on the first

comprehensive molecular phylogeny of Harpactorini we show that bugs exhibiting sticky trap predation have evolved more slender and longer fore femora than non-sticky bugs. Using phylogenetically independent contrast analyses we document correlated evolution between femoral thickness and length, thus providing support for the existence of a functional constraint on the fore femur (i.e., a certain thickness as a requirement for muscular mechanical strength) and a trade-off between femoral thickness and length. It is argued that the novel sticky trap predation strategy may allow sticky bugs to alleviate functional constraints on the fore femur and thus to attain a higher rate of fore leg evolution than other Harpactorini or Reduviidae. We also discuss the possibility that the sticky trap predation represents a case of adaptive radiation.

The last chapter is a taxonomic monograph. The New World harpactorine genus *Zelus* Fabricius, 1803 is revised based on 11,000 specimens. Seventy species are recognized and 24 described as new. Five species are removed from *Zelus*. Ten species groups are proposed primarily on the basis of male genitalic characters. Three species known from only female specimens are unplaced. Habitus images, illustrations of male genitalia and distribution maps are provided. Measurements of specimens were performed and are provided for nearly all valid species. It is also proposed that *Zelus* is closely related to three other New World genera: *Atopozelus* Elkins, *Ischnoclopius* Stål and an undescribed genus.