

UC Berkeley

Research Reports

Title

Effectiveness of Adaptive Traffic Control for Arterial Signal Management: Modeling Results

Permalink

<https://escholarship.org/uc/item/0p0827sf>

Authors

Skabardonis, Alexander
Gomes, Gabriel

Publication Date

2010-08-01

CALIFORNIA PATH PROGRAM
INSTITUTE OF TRANSPORTATION STUDIES
UNIVERSITY OF CALIFORNIA, BERKELEY

Effectiveness of Adaptive Traffic Control for Arterial Signal Management: Modeling Results

**Alexander Skabardonis
Gabriel Gomes**

**California PATH Research Report
UCB-ITS-PRR-2010-36**

This work was performed as part of the California PATH program of the University of California, in cooperation with the State of California Business, Transportation and Housing Agency, Department of Transportation, and the United States Department of Transportation, Federal Highway Administration.

The contents of this report reflect the views of the authors who are responsible for the facts and accuracy of the data presented herein. The contents do not necessarily reflect the official views or policies of the State of California. This publication does not constitute a standard, specification or regulation.

Final Report for Task Order 6322

August 2010

ISSN 1055-1425

CALIFORNIA PARTNERS FOR ADVANCED TRANSIT AND HIGHWAYS

TECHNICAL REPORT DOCUMENTATION PAGE

TR0003 (REV. 10/98)

1. REPORT NUMBER CA10-0823	2. GOVERNMENT ASSOCIATION NUMBER	3. RECIPIENT'S CATALOG NUMBER
4. TITLE AND SUBTITLE Effectiveness of Adaptive Traffic Control for Arterial Signal Management: Modeling Results		5. REPORT DATE August 2010
7. AUTHOR(S) Alexander Skabardonis, Gabriel Gomes		6. PERFORMING ORGANIZATION CODE
9. PERFORMING ORGANIZATION NAME AND ADDRESS California PATH University of California, Berkeley Richmond Field Station, Building 452 Richmond, CA 94804-4648		8. PERFORMING ORGANIZATION REPORT NO. UCB-ITS-PRR-2010-36
12. SPONSORING AGENCY AND ADDRESS California Department of Transportation Division of Research and Innovation, MS-83 1227 O Street; Sacramento CA 95814		10. WORK UNIT NUMBER
		11. CONTRACT OR GRANT NUMBER Contract 65A0208 Task Order 6322
		13. TYPE OF REPORT AND PERIOD COVERED Final Report October 2007-August 2010
15. SUPPLEMENTAL NOTES		14. SPONSORING AGENCY CODE

16. ABSTRACT

A number of adaptive control algorithms have been developed in the US and overseas. However, the practical implementation of adaptive control is limited especially in California. There is a need to develop adaptive control algorithms, evaluate their performance through a field test, and develop a deployment plan for possible Statewide application. The objectives of the study described in this report are a) identify and select the most promising of existing adaptive control algorithms for arterial streets, b) evaluate the performance of the selected algorithms through simulation, c) and develop a plan for field testing of the most promising algorithm(s) on a real-world arterial. Recommendations for deployment of adaptive control will then be developed based on the analysis of the simulation and field results.

This report summarizes the findings from the literature review and presents the study methodology. A section of the Pacific Coast Highway in the city of Lomita was selected as the test site for evaluation of adaptive signal control strategies. A methodology was developed to obtain a time-varying origin-destination (OD) matrix from the system loop detector data at the test site. The calibrated OD matrix was applied to a microscopic representation of the site created in PARAMICS. A plug-in for simulating signal control in PARAMICS was written to explicitly model pretimed, isolated actuated, coordinated actuated, traffic responsive, and critical intersection control, as well as adaptive strategies such as RHODES and TUC. The analysis of the simulation results shows that RHODES is the best control strategy at the selected arterial.

17. KEY WORDS Traffic signals, adaptive control, simulation, origin-destination matrix estimation	18. DISTRIBUTION STATEMENT No restrictions. This document is available to the public through the National Technical Information Service, Springfield, VA 22161
19. SECURITY CLASSIFICATION (of this report) Unclassified	20. NUMBER OF PAGES 92
	21. PRICE N/A

Reproduction of completed page authorized

DISCLAIMER STATEMENT

This document is disseminated in the interest of information exchange. The contents of this report reflect the views of the authors who are responsible for the facts and accuracy of the data presented herein. The contents do not necessarily reflect the official views or policies of the State of California or the Federal Highway Administration. This publication does not constitute a standard, specification or regulation. This report does not constitute an endorsement by the Department of any product described herein.

For individuals with sensory disabilities, this document is available in Braille, large print, audiocassette, or compact disk. To obtain a copy of this document in one of these alternate formats, please contact: the Division of Research and Innovation, MS-83, California Department of Transportation, P.O. Box 942873, Sacramento, CA 94273-0001.

ACKNOWLEDGEMENTS

This work was performed by the California PATH Program at the University of California at Berkeley, in cooperation with the State of California Business, Transportation and Housing Agency, Department of Transportation (Caltrans), Division of Research and Innovation (DRI) (Interagency Agreement #65A0161, Task Order 5322 and Interagency Agreement #65A0208, Task Order 6322). The contents of this report reflect the views of the authors, who are responsible for the facts and the accuracy of the data presented herein. The contents do not necessarily reflect the official views or policies of the State of California.

The authors thank Hamid Rifaat of Caltrans DRI for his support and advice during the project. Mr. Jorge Fuentes of Caltrans District 7 provided data for the selected test site and much on-site expertise. Ms. Gloria Gwynne of Caltrans DRI reviewed the final report. We also thank the project technical advisory committee members Fred Yazdan, Tam Nguyen, Ahmad Rastegarpour, Steve Hague, and Kai Leung of Caltrans for their comments and suggestions throughout the study. Dr. Muñoz helped to configure the CTNET system, gather the data, and select the final data set. Dr. Andy Chow and Eleni Christofa assisted with the preparation of the report. David Lucas, and Professors Larry Head and Pitu Mirchandani from the University of Arizona assisted with the development of the plug-in for simulation modeling of the RHODES adaptive signal control strategy.

ABSTRACT

A number of adaptive control algorithms have been developed in the US and overseas. However, the practical implementation of adaptive control is limited especially in California. There is a need to develop adaptive control algorithms, evaluate their performance through a field test, and develop a deployment plan for possible Statewide application. The objectives of the study described in this report are a) identify and select the most promising of existing adaptive control algorithms for arterial streets, b) evaluate the performance of the selected algorithms through simulation, c) and develop a plan for field testing of the most promising algorithm(s) on a real-world arterial. Recommendations for deployment of adaptive control will then be developed based on the analysis of the simulation and field results.

This report summarizes the findings from the literature review and presents the study methodology. A section of the Pacific Coast Highway in the city of Lomita was selected as the test site for evaluation of adaptive signal control strategies. A methodology was developed to obtain a time-varying origin-destination (OD) matrix from the system loop detector data at the test site. The calibrated OD matrix was applied to a microscopic representation of the site created in PARAMICS. A plug-in for simulating signal control in PARAMICS was written to explicitly model pre-timed, isolated actuated, coordinated actuated, traffic responsive, and critical intersection control, as well as adaptive strategies such as RHODES and TUC. The analysis of the simulation results shows that RHODES is the best control strategy at the selected arterial.

Keywords: Traffic signals, adaptive control, simulation, origin-destination matrix estimation

EXECUTIVE SUMMARY

Objectives and Methodology

A number of adaptive control algorithms have been developed in the US and overseas. However, the practical implementation of adaptive control is limited especially in California. There is a need to develop adaptive control algorithms, evaluate their performance through a field test, and develop a deployment plan for possible Statewide application. The objectives of the study described in this report are a) identify and select the most promising of existing adaptive control algorithms for arterial streets, b) evaluate the performance of the selected algorithms through simulation, c) and develop a plan for field testing of the most promising algorithm(s) on a real-world arterial. Recommendations for deployment of adaptive control will then be developed based on the analysis of the simulation and field results.

- A test site with seven signalized intersections was chosen for evaluation of adaptive signal control strategies. The selected test site is a section of the Pacific Coast Highway running through the city of Lomita, managed by Caltrans District 7. Over seventy days of loop detector data were collected for this site using the CTNet software. Additional data on geometrics and signal settings were collected from Caltrans staff and field visits to the site. A model of the test site was constructed in the PARAMICS microscopic simulation model to evaluate the effectiveness of control strategies prior to field implementation.
- A methodology was devised for synthesizing a time-varying OD matrix from the loop detector data. This procedure makes few assumptions on the availability of data, and allows the user to directly affect the resulting turning flows by manipulating the input parameters. The calibrated OD matrix was input to the PARAMICS model to simulate existing operating conditions at the test site.
- A signal control plug-in was written to model control strategies with PARAMICS. It simulates non-adaptive strategies such as pretimed, isolated actuated, coordinated actuated, traffic responsive, and critical intersection control, as well as adaptive strategies like RHODES and TUC. The plug-in can be applied to any PARAMICS network. The plugin is based on a control interface which allows it to communicate with arbitrary "black box" algorithms via standard *hold*, *force-off*, and *omit* messages. When connected to an external control algorithm, the plugin acts in much the same way as a real controller, providing safety and minimum phase timing guarantees.
- A total of twelve control strategies were tested through PARAMICS simulation. The control strategies tested included the RHODES and TUC adaptive strategies, plus traffic responsive plan selection, isolated and coordinated actuated control, and the fixed-time plans operating at the site. Additional model runs were also performed by testing the impacts of 5% and 10% uniform increases in traffic demands. Four replications of each scenario were performed in PARAMICS with different random number seeds, for a total of 144 model runs.

Findings

The major findings from the study can be summarized below:

- The pretimed TOD is clearly superior than any of the fixed-time plans operating throughout the day. This strategy is also robust for changes in traffic volumes. The results also show that Plan 8 is the best single timing plan for the test arterial.
- The RHODES adaptive signal control strategy outperforms the Traffic responsive and the TUC strategy in terms of the network travel time. RHODES also results in the highest average speeds, and minimum speed variability.
- Regarding the number of stops for the through traffic on the arterial, RHODES is slightly better than the pretimed signal timing plans.
- Overall, the simulation results show that the RHODES adaptive signal control strategy is the best in terms of both the overall system and arterial only traffic performance for all the demand levels tested at the selected site. The control strategies with pretimed plans had similar performance in terms of network delay.

Recommendations

It is recommended to perform a field test of the most promising strategy on the Lomita Avenue test site. The objective of this follow-up study is to verify in the field the effectiveness of adaptive control, document the technical and institutional issues related to field implementation, and develop guidelines for future deployment of adaptive control.

TABLE OF CONTENTS

TECHNICAL REPORT DOCUMENTATION PAGE	i
DISCLAIMER STATEMENT	ii
ACKNOWLEDGEMENTS	iii
EXECUTIVE SUMMARY	iv
TABLE OF CONTENTS	vi
LIST OF FIGURES.....	viii
LIST OF TABLES	viii
CHAPTER 1. INTRODUCTION	1
1.1 Problem Statement	1
1.2 Objectives of the Study	1
1.3 Organization of the Report	1
CHAPTER 2. BACKGROUND	2
2.1 Overview	2
2.2 Existing Adaptive Signal Control Systems	3
CHAPTER 3. METHODOLOGY.....	7
3.1 Development of Adaptive Control Strategies	7
3.2 Evaluation of the Proposed Adaptive Control Strategies.....	8
3.3 Simulation Modeling.....	9
3.4 Field Testing.....	10
CHAPTER 4. THE TEST SITE	12
4.1 Test Site Selection	12
4.2 Data Collection and Processing.....	13
CHAPTER 5. ORIGIN-DESTINATION MATRIX ESTIMATION	16
5.1 Introduction.....	16
5.2 Proposed O-D Estimation Procedure	17
5.3 Application on Lomita Avenue Test Site.....	23

CHAPTER 6. PARAMICS PLUG-IN FOR SIGNAL CONTROL.....	27
6.1 Signal Timing Plans and Time-of-Day Control (TOD).....	31
6.2 Actuated Signal Control (ASC)	32
6.3 Traffic Responsive Control (TRSP).....	35
6.4 Critical Intersection Control (CIC).....	37
6.5 Extensions—Adaptive Signal Control	39
CHAPTER 7. SIMULATION OF THE SELECTED STRATEGIES.....	41
7.1 Existing Conditions.....	41
7.2 Simulation Experiments	41
7.3 Analysis of the Simulation Results	42
CHAPTER 8. CONCLUSIONS	48
8.1 Summary of the Study Findings	48
8.2 Future Research: Field Testing of Adaptive Signal Control	48
REFERENCES	51
BIBLIOGRAPHY	53
APPENDIX A. RHODES IMPLEMENTATION IN PARAMICS SIMULATION MODEL	56

LIST OF FIGURES

Figure 3.1	Measuring the Benefits of Adaptive Signal Control	8
Figure 4.1	The Selected Test Site (Pacific Coast Highway, Lomita, CA).....	14
Figure 4.2	Test Site: Raw and Filtered Traffic Volumes.....	14
Figure 4.3	Test Site: Data Samples.....	14
Figure 4.4	Distribution of Average Volumes	15
Figure 5.1	Measured Arterial Flows	18
Figure 5.2	Numbering of Intersection Weights--Joining and Leaving Flows	19
Figure 5.3	Turning Flows	21
Figure 5.4	Narbonne Avenue: Arterial Flows (vph) and Intersection Weight	26
Figure 5.5	Narbonne Avenue: Estimated Flows (vph)	26
Figure 6.1	Typical Signalized Intersection Layout.....	27
Figure 6.2	PARAMICS Plug-In Main Input File (param_main.txt).....	29
Figure 6.3	Input File for Time-of-Day Control (param_tod.txt)	31
Figure 6.4	Dual-ring Controller	32
Figure 6.5	Interval Timing.....	34
Figure 6.6	Permitted Gap Function.....	34
Figure 6.7	Input File for Actuated Signal Control (param_asc.txt).....	35
Figure 6.8	Detector Locations for Traffic Responsive Control—Lomita Avenue	37
Figure 6.9	Input File for Traffic Responsive Control (param_trsp.txt)	37
Figure 6.10	Input File for Critical Intersection Control (param_cic.txt)	39
Figure 6.11	Plugin Structure	40
Figure 6.12	Detector Placement for RHODES Control Strategy—Narbonne Intersection	40
Figure 7.1	Average Travel Times—Fixed Time Plans	43
Figure 7.2	Average Travel Times—Traffic Responsive Plans	44
Figure 7.3	Average Network Speed—Fixed Time TOD and Traffic Responsive Plans	45
Figure 7.4	Average Network Speed—RHODES and TUC (Plan 9) Strategies	46
Figure 7.5	Number of Stops—Arterial	47

LIST OF TABLES

Table 2.1	Summary of Existing Adaptive Signal Control Systems.....	4
Table 5.1	Fixed Parameters for T Intersections.....	22
Table 5.2	Cross Streets and Tuned Parameter Values	24
Table 6.1	Column Headers for output_loop.txt	30
Table 6.2	Column Headers for output_control.txt.....	30
Table 7.1	Lomita Test Site—Time of Day Plans	41

CHAPTER 1

INTRODUCTION

1.1 Problem Statement

Optimal traffic signal control has been recognized as a very cost/effective strategy to improve the efficiency of existing transportation facilities. Synchronizing traffic signals along arterials or in a network, and optimizing the signal settings, result in smoother traffic flows, reducing idling and stopping. This, in turn, reduces fuel use, saves motorists travel time, diminishes wear and tear on vehicles, and cuts vehicular emissions (22). Furthermore, effective arterial control is an important step in developing a systematic integrated control of freeways and arterials for corridor management.

Most traffic control systems today are based on time-of-day schedules where the traffic signal settings (cycle length, green times, offsets) are set by time-of-day based on historical data on traffic demand (e.g., am peak hour turning movement counts). Some systems operate in a traffic responsive mode where the signal timing plans are selected based on observed volumes and occupancies. Traffic responsive systems find the best match between a plan that was developed based on design volume and occupancies values and observed values. There is no guarantee that a traffic responsive system will have a plan for the observed conditions. A truly traffic adaptive system will adjust the settings at traffic signals based on real-time data on traffic conditions, and can respond to unexpected or unplanned events, such as incidents, special events, weather, etc., since they adapt the timings based on observed traffic data. Similarly, adaptive systems will improve performance over time-of-day plans when the traffic patterns have a high degree of variability. Finally, adaptive systems will reduce the adverse effects of offset transition, preemption, and transit priority.

1.2 Objectives of the Study

Several adaptive control algorithms have been developed in the US and overseas. However, the practical implementation of adaptive control has been limited especially in California. There is a need to develop adaptive control algorithms, evaluate their performance through a field test, and develop a deployment plan for possible Statewide application. The objective of this study is to develop identify adaptive arterial signal control strategies, evaluate their effectiveness through simulation, and develop recommendations for field implementation.

1.3 Organization of the Report

This document is the final report for project performed under PATH Task Order 6322. The next Chapter summarizes the findings from the literature review on existing adaptive signal control systems, their features and operational experiences from their implementation. Chapter 3 presents the study methodology. Chapter 4 describes the selected test site and the data collection and processing. Chapter 5 presents the analytical procedure to develop an origin-destination matrix from detector data for input to the PARAMICS microscopic simulation model. Chapter 6 describes a plug-in developed for the PARAMICS model to simulate signal control strategies. Chapter 7 presents the results from the simulation testing of the selected adaptive signal control strategies. The last Chapter summarizes the study findings, and proposes follow-up research on field testing of adaptive signal control strategies.

CHAPTER 2

BACKGROUND

2.1 Overview

Traffic signals along arterials and networks operate as coordinated to provide progression to the major through movements. Most of the existing signal systems use fixed time timing plans prepared off-line based on historical data ("first generation" strategies). These plans are implemented either by time of day (TOD), e.g., am, midday and pm peak periods, or they are selected based on volume and occupancy data collected from system detectors located in key locations of the network. The system operator may also override the timings based on real-time surveillance data. Fixed-time plans, however, cannot deal with the variability of traffic patterns throughout the day, and they become outdated because of the traffic growth and changes in traffic patterns.

An increasing number of first generation control systems use traffic actuated controllers operating in coordination with a common background cycle length. These systems provide improved through progression by utilizing the spare green time in the signal cycle from the "early" termination of actuated phases. At the same time, they may reduce the total intersection delay by responding to the cycle-by-cycle fluctuations in traffic volumes. Simulation results and field studies have shown that coordinated actuated signals significantly improved the performance on the arterial at the expense of the cross-streets.

The "1.5 generation" control strategy first implemented in the city of Los Angeles ATSA system uses volume data from system detectors to update the approach volumes and update off-line the signal settings. The new plans are implemented by the system operator based on a comparison of the simulated performance from the new timings and the plan currently in operation. The verification and assessment of the timing plans prior to implementation ensures that the plans are operationally acceptable. This strategy reduces the effort to update timing plans, but still cannot respond to real-time changes in traffic patterns.

"On-line" control systems update the timing plans in real-time based on data from detectors located on each intersection approach. Such strategies fall into two major categories: timing plan update (e.g., "UTCS Second Generation", SCATS and SCOOT) that adjust the signal settings while maintaining a common cycle length, and adaptive control policies (OPAC, PROLYN) that continually optimize the timings at each intersection over a short time interval (rolling horizon).

In the UTCS second generation control, the timing plans are prepared on-line and implemented approximately every 15 minutes. This strategy, however, has produced mixed results compared to fixed-time plans and it is not currently operational. The SCATS (Sydney Coordinated Adaptive Traffic System) control system uses detector data at the intersection stopline to measure the degree of saturation (volume/capacity ratio). It then adjusts on-line the background fixed-time plans. The Splits-Cycle-Offsets-Optimization-Technique (SCOOT) method originally developed in England uses data from detectors located at the upstream end of each approach to estimate the size and shape of traffic platoons for each signal cycle, and adjusts the timings to minimize the delays and stops. Adaptive systems continually optimize the signal settings over a

short time interval (rolling horizon), without necessarily maintaining a common cycle length in the network. Most of these approaches evolved from control of isolated intersections (MOVA, OPAC and PRODYN) and are not widely deployed.

2.2 Existing Adaptive Signal Control Systems

A literature review was undertaken to identify the state-of-the-art adaptive control algorithms that are operational and implemented in real-life systems. Emphasis was placed on the latest information on existing algorithms through published sources and contacts with systems' developers and users. In addition to published sources¹, the Transportation Research Board (TRB) Traffic Signal Systems Committee website² includes several presentations on the characteristics of several adaptive traffic signal systems including system architecture, data requirements, communications requirements, local controller and central hardware requirements, installation operation and maintenance costs. Recently, a NCHRP Synthesis³ report summarizes the state-of-practice in adaptive control systems through review of literature and interviews with systems' developers and users. The characteristics of several adaptive signal control systems that have been implemented in the field are summarized in the Table 2.1.

There have been many studies where different adaptive control systems have been evaluated. Most of the field evaluation studies that have been conducted on adaptive systems have concentrated on addressing the ability of these systems to provide benefits in terms of reductions in travel times, intersection delays, and the number of stopped vehicles. These field evaluations have primarily used the "before" and "after" technique. Evaluation of SCOOT deployments has reported an average reduction of 12% in intersection delay over fixed time plans SCATS has been deployed in Oakland County Michigan. Reported improvements in travel times were 7%-32% during different times of the day and compared to previous conditions which consisted only time based control with little to no effort in maintaining signal timings. The UTOPIA system in Turin provides absolute priority to public transit vehicles and at the same time optimize the signal settings for the rest of the traffic stream. Reported benefits include a 20 percent increase in the average bus speeds without disbenefits to the rest of the traffic.

The Federal Highway Administration (FHWA) sponsored Adaptive Control System (ACS) prototypes - OPAC, RHODES, and RTACL were field tested in Reston, Virginia; Seattle, Washington, and Chicago, Ill, respectively. In general, there were many lessons learned from these deployments. Issues related to installation and operation of detection systems, communications, and controllers were significant challenges in each of the field tests. RTACL performed below expectations. OPAC did not improve network conditions and in some cases delay and travel time actually increased. Simulation tests of OPAC using the CORSIM simulation model were consistent with the field test results. RHODES showed no significant difference in arterial travel times, but the cycle times were significantly reduced in Seattle.

¹ Documents describing traffic control strategies and related issues are listed in the BIBLIOGRAPHY section of the report

² <http://www.signalsystems.org.vt.edu/documents.html>

³ NCHRP Synthesis 403, "Adaptive Traffic Control Systems: Domestic and Foreign State of Practice," Transportation Research Board, Washington DC, 2010.

Table 2.1 Summary of Existing Adaptive Signal Control Systems

System	Installations	Architecture	Detection	Controller	Communications
SCOOT	Over 200 worldwide	Centralized	Exit loops	NEMA (EPAC) or special	Once per second for hold, force-off omit and detector data
SCATS	Over 50 worldwide	Hierarchical (plan based)	Stop bar loops	2070 or special	Strategic control from central and local tactical control
OPAC	2	Decentralized	Exit loops	NEMA (with VS-PLUS firmware) and VME co-processor)	Once per cycle
RHODES	4	Decentralized	Fully actuated design	2070 (with NextPhase firmware and VME co-processor)	Peer-to-peer over IP, event based on upstream detections
BALANCE/MOTION* (Germany)		Central	Near Stop Bar	European	Once per second
INSYNC		Decentralized	Near Stop Bar	Existing(Insync Software)	Ethernet
ACS Lite		Decentralized	Stop bar loops Upstream	NEMA 2070	Serial or Ethernet
ATCS (Los Angeles)	1	Centralized	Fully actuated with system detectors for VOS	2070 with LADOT firmware	Once per second
TUC (Chania, Greece)	3	Central	System Loops for VOS	European	Once per second
UTOPIA (Torino, Italy)	1	Distributed	Fully actuated design	European	

* *BALANCE and MOTION are different systems with many similarities*

FHWA in cooperation with signal controller manufactures recently developed the Adaptive Control Software *Lite* (ACS Lite) (20), with the goal of providing a “widely deployable” system that automates monitoring of traffic signal performance and adjustment of signal timing. The Lite designation reflects a focus on reducing traditionally high installation and operations costs, which have been the primary impediment limiting the deployment of adaptive systems in the U.S. Field evaluations in four sites showed that signal timing adjustments by ACS Lite provided substantial reductions in vehicle delay, arterial travel time, vehicle stops, and fuel consumption.

Review of the most widely used ATCSs showed that various systems use similar strategies to cope with fluctuations in traffic demand. However, each tool is unique and without direct comparison it is difficult to compare the algorithms and adaptive logic of the various tools. Field implementations of various tools are even more unique than their logics, which makes direct field evaluations expensive and therefore impractical. For this reason, among others, very few studies in the literature provide evidence that the operational concepts of one particular ATCS are better than those of another.

In general, traffic engineers perceive traffic adaptive signal control systems to be systems that will improve traffic signal operational performance with decreased staff workload. While this perception indicates the desire of traffic engineers to provide better service to the public within the tightly constrained budgets that are available, the actual benefits and costs are still poorly understood and largely unquantified. Most of the cited benefits are based on limited data and do not relate to the geometric, traffic and control characteristics of the specific project areas (23). Other factors limiting the deployment of adaptive systems include a) agency capability and willingness to deploy adaptive systems, b) concerns over actual benefits, dependencies on site specific conditions, and loss of an engineer's control over the timing plans, c) lack of understanding, including complexity of the systems as well as not knowing the difference between adaptive and responsive or other off-line control operations, d) additional initial expense and maintenance costs, and e) immaturity of US systems and concern about difficulties associated with using foreign developed systems.

Responses from a recent survey of 45 public agencies that deploy adaptive traffic control systems (ATCSs) in the US and overseas indicate that ATCS agencies were mostly generally satisfied by their systems' ability to provide what was observed as "efficient operations". Negatives were mostly related to difficulties in learning how to operate the system and the hardware (primarily communications). Lessons learned can be summarized in four categories, which represent pre-deployment actions necessary for successful ATCS implementation: better local support from vendors; better planning for in-house operational and institutional support; preparation of the infrastructure (detection and communications); and detailed pre-installation evaluation to estimate operational benefits. Major reasons that prevent ATCSs from expansion include the high costs for system operation and maintenance (e.g., employing and training the staff). The following key findings were also reported:

- Handling daily and weekly fluctuations in traffic flows is the highest ranked reason for ATCS deployments. However, the benefits of ATCS are not easily observable in oversaturated traffic conditions. Although ATCS users find that their systems may delay the start of oversaturation and reduce its duration, they are not recognized as a solution for such traffic conditions. However, modifications of an ATCS to reduce oversaturation is often beyond the competence level of ATCS users; therefore, there is little data available to draw conclusions about ATCSs' performances in oversaturation.
- ATCS installation costs per intersection are approximately \$65,000 (higher than previously reported). Interestingly, results showed that ATCSs require less funding for physical maintenance than conventional traffic signals. This finding contradicts common belief present in the traffic signal community that maintenance of ATCS detectors and

communications is costly. On average, an ATCS installation takes approximately 18 months, from the time when funding is made available to the time an ATCS becomes fully operational. Most of the ATCSs that have been deployed during the last 20 years are still in operation. Agencies frequently expand their ATCSs and, in general, most are satisfied with their operations.

- Detection requirements for an ATCS are slightly higher than those for conventional traffic-actuated control systems. Most of the ATCS users are satisfied with the way their system handles minor detector malfunctions. Some ATCS users have difficulties with the handling of ATCS-specific hardware, although this is primarily an issue that could be resolved with better training of the technical staff. As perceived by most of the users, ATCS software is one of the components that need improvement. Interestingly, ATCS users do not find that ATCS communications cause many more problems than the communications of conventional traffic control systems. However, communications play a much more important role in ATCS deployments and for this reason need to be regularly maintained, which represents one of the major operational costs for ATCS users.
- There is a considerable need for expertise to ensure a successful ATCS implementation. Although many agencies implement ATCSs to reduce labor-intensive maintenance of signal timing plans, survey respondents indicated that ATCSs are only tools for traffic management and they need to be supervised and controlled by skilled engineering staff. Proper training and acquisition and retention of expertise within an agency were reported as the most important factors for alleviating institutional barriers for ATCS deployment. ATCS operations are often not perceived as being difficult; however, it appears that ATCS users are not often given the opportunity to learn how to fully operate their systems. Unlike conventional systems that are maintenance-intensive, ATCSs require more emphasis on the expertise necessary to operate their sophisticated operations. This switch in the type of labor (from maintenance to operations), which is needed to support proper ATCS operations, is often not recognized by an agency until the ATCS is already deployed. This inability to recognize the need for additional operational expertise in a timely manner can adversely affect the ATCS performance.
- There is a need for comprehensive evaluation studies that would show all of the costs and benefits of an ATCS deployment. This should include a detailed cost breakdown on system hardware (electronics), software, and labor (installation, maintenance, and operations), and analysis of the benefits (including investigation of the long-term operational savings resulting from long-term changes in traffic demand).

CHAPTER 3

METHODOLOGY

The research approach consists of theoretical development, simulation modeling, and field implementation and evaluation of the proposed strategies. The primary emphasis on this project is to produce and field test operational adaptive control algorithms. Emphasis therefore is given in the methodology to address the key issues in carrying out this project rather than describing a formulation of a proposed algorithm.

There are several issues to be addressed in developing adaptive control algorithms including but not limited to control philosophy, surveillance requirements, theoretical formulation, computational requirements, controller hardware & software requirements, communications requirements, and interfaces with other systems (e.g., freeway TMCs) for integrated corridor management or other local agencies' TMCs for multi-jurisdictional control. Key issues for the development and evaluation of adaptive control strategies are discussed in the following sections.

3.1 Development of Adaptive Control Strategies

The approach for developing an adaptive control algorithm is to select the most promising control strategy from the existing strategies identified in the literature and design and implement new functions and features that are required to meet the needs and requirements of the selected test sites that are representative of major arterials (including freeway-arterial corridors). Some key considerations include:

Control philosophy: The common assumption is that adaptive control continually changes the signal settings to match the measured (or predicted) traffic patterns in the network. However, this approach may not be beneficial on congested conditions because it may create spillbacks upstream from the critical intersection(s). Furthermore, coordination with adjacent metered ramps or congested off-ramps may necessitate overriding the blind adaptation to traffic patterns at the arterial. It is critical to understand the difference between “control” and “adapt” and design an algorithm that satisfies the objectives and constraints for the specific project area.

Compatibility with Caltrans & local agencies signal control practices: The development of improved control algorithms should take into consideration the existing operation of signal systems on California State highways and local major arterials. Most of the signals are equipped with 170 or 2070 signal controllers and stopline detection. Algorithms that are designed to operate with such hardware framework would be easier to implement than algorithms which require customized controllers or detection location (i.e., not compatible with the California MUTCD guidelines, for example Table 4D-101).

Surveillance requirements: The effectiveness of adaptive control depends on the availability and accuracy of the data on traffic conditions, i.e., size, shape and speed of traffic platoons approaching the intersection. The cost of installation and maintenance of conventional surveillance systems (loop detectors) is very high, particularly for systems that require multiple detection points upstream, which make the widespread deployment of such systems very

difficult. We will investigate the potential of new detector technologies and how they can work with the adaptive algorithms.

3.2 Evaluation of the Proposed Adaptive Control Strategies

The objective of the evaluation is to quantify the benefits of the adaptive control. It is important to differentiate between the benefits of the proposed control (with new hardware and software) against both a) the existing system with existing signal settings and b) existing system with optimal signal settings to estimate the true benefits of adaptive control (24). Figure 3.1 illustrates the proposed methodology.

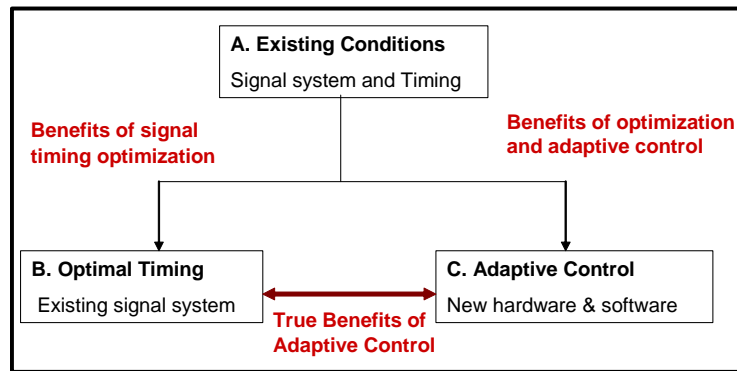

Figure 3.1 Measuring the Benefits of Adaptive Signal Control

- Comparison of (a) vs. (b) provides the benefits due to the optimal operation of the system with existing hardware and control strategy (e.g., TOD plans)
- Comparison of (a) vs. (c) provides the total benefits due to adaptive control from existing conditions
- Comparison of (b) vs. (c) provides the true benefits of adaptive control

The measures of effectiveness (MOEs) for the evaluation of the alternative strategies include travel times, delays and number of stops on arterial links and cross-streets. System measures may include VMT (veh-miles traveled), VHT (veh-hrs traveled), and cycle failures. Energy and environmental measures may include excess fuel consumption, and vehicle emissions (CO, HC and NO_x). These environmental measures are usually derived from the primary performance measures of travel times, delays and stops.

It is also important to consider the traffic impacts of the proposed strategy(ies) on each system component. For example, it is well known that signal coordination improves traffic performance on the arterial through links at the expense of cross-streets. Therefore, the evaluation plan will analyze the performance measures separately on

- arterial through links
 - travel time (speed)
 - delay

- number of stops (% vehicles stopped)
- cross-streets
 - queue length
 - delay
- total system
 - VMT
 - VHT
 - cycle failures
 - fuel consumption
 - emissions

3.3 Simulation Modeling

The performance of the existing and proposed control strategies will be first evaluated through simulation. Simulation provides several attractive attributes including the ability to evaluate system performance under a wide variety of traffic conditions. Simulation allows to vary many system characteristics including volumes, turning proportions, saturation flow rates (such as might change due to weather conditions), and events such as lane closures, preemptions, etc. However, it is important to realize that simulation generally does not support testing of operational issues such as detector errors. This can be approximated by testing the performance of the algorithm with less than ideal detector data, but still we cannot analyze the effects of *random* data losses. There are several important considerations in the evaluation of control strategies through simulation:

Model selection

A number of simulation tools are available to model signal operations on arterials and networks. Existing models can be classified into macroscopic and microscopic. Macroscopic models consider the average rates of flow in the network and use analytical relationships to model traffic flow. Microscopic models in contrast, simulate the movement and interactions of individual vehicles. Microsimulation has been selected for this project because the signal control strategies being considered often react to single vehicle events. For example, actuated signal operation monitors the advance detectors and may extend the green time if a vehicle is registered by an active approach detector. Such effects are difficult to reproduce in macroscopic simulation.

Among the various microscopic models available, PARAMICS was selected as the main tool for modeling control strategies because it has been used in a number of Caltrans sponsored projects, and of the research team's familiarity with its Application Programming Interface (API). The CORSIM model (10) also will be used in the study because it can directly model the RHODES and ACS Lite control strategies.

PARAMICS is a suite of simulation tools developed by Quadstone (19). PARAMICS Modeller is the core network building tool. It enables the user to display a map of the selected test site and overlay and edit the nodes and links that constitute the network model. All of the supply side elements of the network, including traffic signals, lanes, priority and permission rules, are defined in Modeller. PARAMICS Processor is a batch execution tool. It allows the user to define a sequence of simulation runs and execute them at a much faster speed than with Modeller.

PARAMICS Programmer is the API; it consists of a set of C-based functions that provide access to many of the internal variables of the PARAMICS model, and it is used to code signal control algorithms.

Calibration of baseline conditions

The first step in the simulation modeling of strategies is to calibrate the simulation model against field measurements to ensure that the simulation model replicates field conditions. Model calibration is a complex process given the numerous parameters in the microscopic simulation models. The model calibration will be carried out according to the guidelines developed by FHWA (8), which consist of the following three steps: a) calibration for capacity, b) route choice calibration, and c) overall system performance calibration.

Coding of the signal control strategies

The existing and proposed signal control algorithms will be coded in the simulation model. This is generally a complex process because it requires developing an interface through hardware in the loop or a plug-in between the simulator and the control software. Chapter 5 of the report describes the plug-in developed in the project to simulate a number of control strategies utilizing the PARAMICS model API.

Comparison of alternatives

This process involves comparisons of the model predicted MOEs under each control scenario to determine if statistically significant improvements are obtained. This in turn requires that several replications of the simulation need to be performed for each scenario and the results statistically analyzed. The number of replications depends on the conditions to be simulated and the performance measures to be analyzed. For example, the stochastic variability in the model results is much higher for link delays under heavy traffic volumes as opposed to system travel times under low volume conditions.

3.4 Field Testing

Field testing of the proposed algorithm on the selected sites involves the following steps;

- a) “Before” data collection on the selected performance measures
- b) Field implementation of the proposed algorithm
- c) “After” data collection on the selected performance measures

The methodology for field data collection will depend on the characteristics of the test site and the surveillance system capabilities. For example on systems equipped with cameras at the intersection, we can process the image to obtain estimates of delays and queue lengths through image processing. Floating cars equipped with GPS units may be also utilized to obtain estimates of arterial link travel times, delays and stops. The duration of the field tests will provide sufficient data to determine if statistically significant improvements have been obtained. At a minimum one week of “before” and “after” field data will be collected. This estimate will be revised as appropriate based on the sample measurements of the MOEs. We will carefully

monitor the traffic and other operating conditions throughout the field experiment to ensure that the measurements are not masked by external factors.

We will also compare the field results against the simulation results. Comparison of simulation and field test results are often difficult and misleading since simulation studies are generally conducted under well controlled conditions where performance measures are not collected until the system has reach a “steady state”. It is not possible to fully control field test conditions so the performance measures may be collected during periods of transition or when random events may be occurring on the network. However, field testing is the only true test of performance, but it should be recognized that field testing may not always produce findings that truly measure the capabilities of an adaptive system.

CHAPTER 4

THE TEST SITE

4.1 Test Site Selection

This research will field test proposed adaptive control algorithms on a real-world arterial. It is therefore important that suitable test sites are selected for the evaluation of the proposed algorithms. Criteria for test site selection include:

- Traffic volumes and patterns: The selected site should have both heavy traffic volumes and highly variable traffic patterns. There are no significant benefits from adaptive control if the arterial volumes follow a predictable traffic pattern throughout the day. Furthermore, if the traffic volumes are well below capacity then the variability in traffic patterns can be accommodated with conventional fixed-time or actuated control.
- Proximity to freeway: Location of the test arterial close to freeway that is part of a freeway-arterial corridor will permit development and testing of algorithms for integrated corridor control
- Existing signal system capabilities: signal hardware and software and communications that allow central or decentralized monitoring of the signal system and remote implementation of changes in signal settings.
- Data availability: Existing data on intersection geometrics, traffic volumes and patterns, and existing signal settings are required for the development and evaluation of the proposed algorithms through simulation. Also, existing data on traffic performance including travel times, delays and queue lengths
- Cooperation with Caltrans & local agency staff: Staff in charge of the system operation and maintenance willing to participate in the study, review the proposed algorithms and provide cooperation and support throughout the field test

The following sites were investigated based on discussions with Caltrans and local agencies' operations staff:

- 1) San Pablo Avenue (State Highway 123): San Pablo is located in the San Francisco bay Area and it is a parallel route to I-80 freeway. It is part of the East Bay Smart Corridor.
- 2) State Highway 17 and Bascom Avenue: This is part of the Silicon Valley Smart Corridor in San Jose.
- 3) Orange County Test Bed: There are several freeway-arterial corridors in the cities of Irvine and Anaheim
- 4) Pacific Coast Highway (PCH) in Southern California

The test site selected for the study is a stretch of the PCH running through the city of Lomita in Southern California (Figure 4.1). This stretch runs East-West, is relatively straight and flat, and contains 11 almost evenly spaced intersections, 7 of which are signalized. All of the signalized intersections are operated by 2070 controllers, most of them have protected left turns. The key considerations in choosing this site were its hardware (2070 controllers coordinated by a field

master), variability of traffic volumes, and availability of data. The test site is equipped with approach and stopline detectors at every signalized intersection. The measurements from these detectors can be remotely accessed via the Caltrans CTNET system.

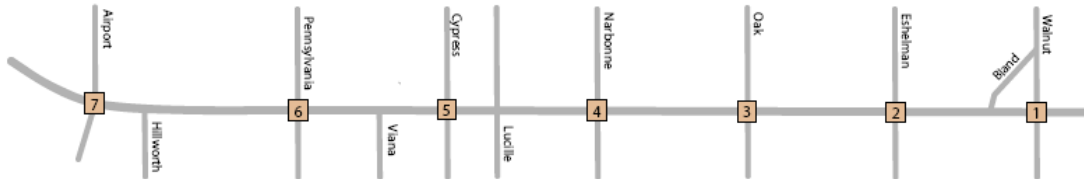

Figure 4.1 The Selected Test Site (Pacific Coast Highway, Lomita, CA)

4.2 Data Collection and Processing

Information on intersection geometrics, limited manual turning movement counts and signal settings (controller cards) were made available by Mr. Jorge Fuentes of Caltrans District 7. The research team made two field visits to the site to observe operating conditions and to gather supplemental data.

Traffic demands are defined in the PARAMICS model with a time-varying origin-destination (OD) table. To obtain an OD table for the study section, first we obtain detector data using CTNET and then we developed a procedure to estimate the OD table from the detector data (described in Chapter 4).

CTNET (2) is a map-based software developed by Caltrans. It is intended to facilitate the remote management, monitoring, and analysis of signal status and traffic sensor data at signalized intersections. CTNET uses Windows sockets and is based on the server/client paradigm. A server application resides on a computer in the Caltrans offices. It relays information from the field master controller to the various client programs requesting that information. The client side program receives signal and detector information once per second and displays it on a map. The transmitted information includes:

- Cabinet alarm state (preemption and flash).
- Phase (reds, yellows, greens, and PEDs).
- Phase calls (vehicle and PEDs).
- Detector presence.
- Volume and occupancy data (see Figure 4.2).

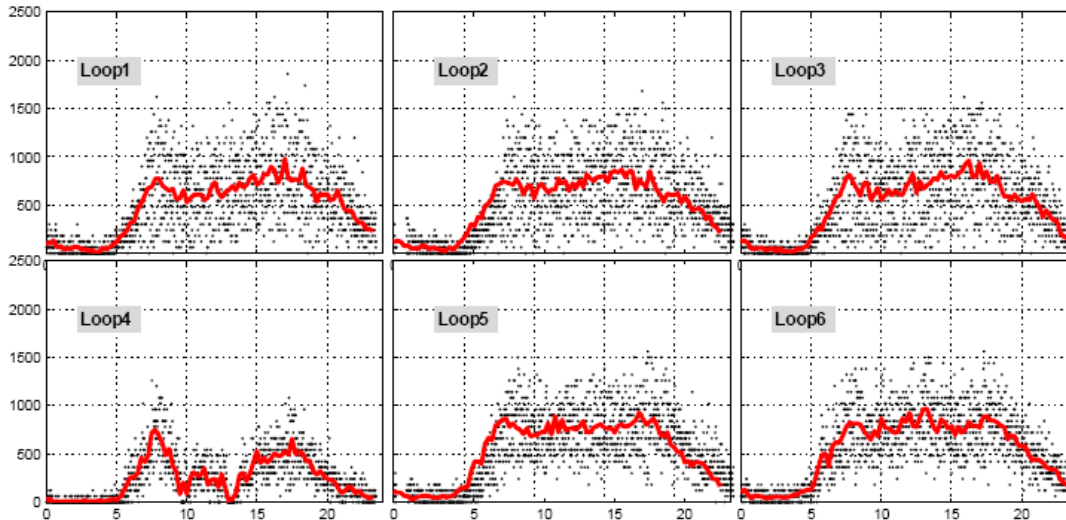

Figure 4.2 Test Site: Raw and Filtered Traffic Volumes

CTNET was used to collect 70 weekdays of data between March 2nd and June 29th 2006. The volume and occupancy data were saved in a Microsoft Access database. Each day contained 15-minute flows for each of the 37 mid-block detectors. These Access tables were converted to Excel spreadsheet form with the aid of the *AutoIt* scripting tool (12), a free software that can be used to automate a number of repetitive tasks.

The Excel tables were then loaded into the *Matlab* software and ranked according to the total flow accumulated over 24 hours. Several days were seen to have anomalously low total flows, due presumably to incidents or faulty detectors. About one third of the days were discarded on the basis of low volumes or too few samples (See Figure 4.3). From the remaining two thirds we selected the median day for the volumes to input into the PARAMICS model to simulate existing conditions (See Figure 4.4).

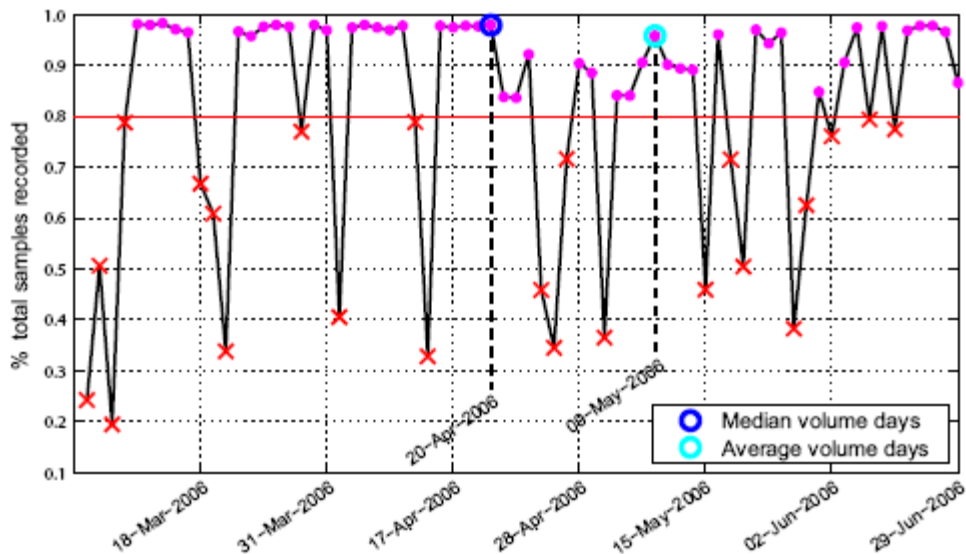

Figure 4.3 Test Site: Data Samples

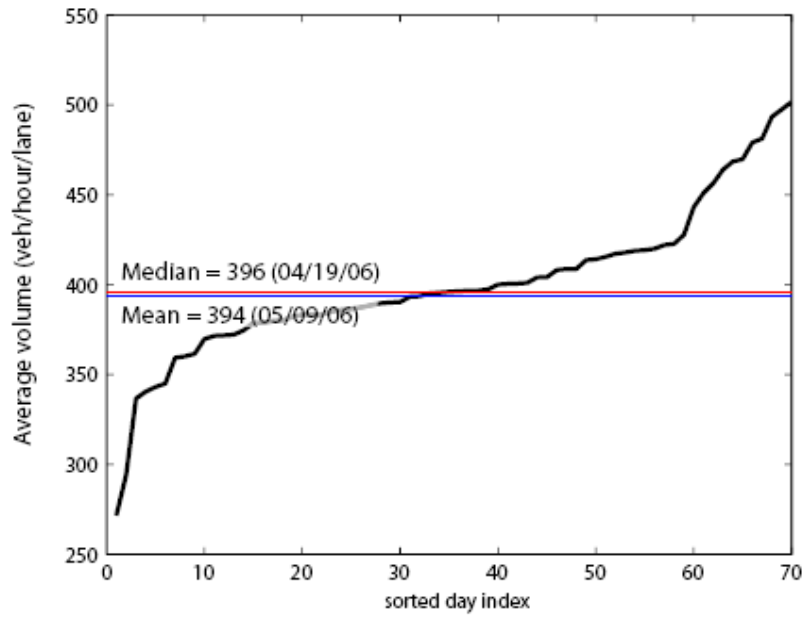

Figure 4.4 Distribution of Average Volumes

CHAPTER 5

ORIGIN-DESTINATION MATRIX ESTIMATION

Traffic demands are defined in the PARAMICS simulation model with a time varying origin-destination (OD) matrix. This Chapter describes the procedure developed in this study to obtain the OD matrix from detector measurements at the study site⁴.

5.1 Introduction

Most simulation models, both macroscopic and microscopic, require an OD matrix to define the traffic demand patterns on the study network. However, few simulation software include a procedure for estimating it. The traffic engineer in need of an OD matrix is often confronted with the decision of either using a simulation model that provides OD estimation, such as PARAMICS or implementing one of the algorithms found in the academic literature. Regarding the latter option there is a large number of techniques from which to choose, with varying degrees of sophistication and computational requirements. Most of these employ mathematical programming methods to find the OD matrix. The problem in most cases can be expressed as follows:

*minimize $J(OD, \text{additional data})$
such that the measured flows are reproduced, and individual OD flows are non-negative*

The additional data in the objective function is often a target OD matrix, assumed available from previous studies. The problem thus formulated is to find the matrix with non-negative elements which is closest to the target matrix, while reproducing the measurements. Several distance functions J have been considered, including maximum entropy (29), quadratic functions (3), and absolute value norms (21). The method of generalized least squares, applied to OD estimation by Cascetta in (3), has received particular attention due to its versatility and numerical robustness. Bell (1) later improved the method by enforcing non-negativity constraints. Another related line of research has developed algorithms which take explicit account of the stochastic nature of the problem (16, 17, 26).

The approaches mentioned thus far assume that the routing of traffic is known beforehand from a proportional assignment matrix. However several authors have noted that the two problems, OD estimation and traffic assignment, may be interrelated when the network is congested. In this situation, a user equilibrium assumption on the distribution of traffic is more appropriate (28,30).

A more recent development has been the use of time-series data for the estimation of either static or time-varying OD matrices. Cremer and Keller (6) first used sequences of traffic counts to estimate OD information for a single complex intersection. Nihan and Davis (18) then generalized the approach by noting that it falls within a larger family of parameter estimation techniques. Li and De Moor (14) improved upon the accuracy of (31) and (25). These works are of relevance to the present approach because they apply only to a strictly defined network configuration. An important improvement was provided by Li and De Moor in (15) when they

⁴ This Chapter was originally published in "A simple procedure for estimating origin-destination matrices for arterial corridors", by Gomez and Skabardonis, paper 08-1750, presented at the 87th Annual Meeting of the Transportation Research Board, Washington DC, January 2008.

allowed for some of the boundary flows to be unmeasured. Another interesting and promising line of research has been the use of automatic vehicle identification techniques for gathering partial vehicle trajectories (7, 13,31).

Aside from the academic approaches, the other alternative is to use a simulation model such as PARAMICS which includes an OD estimation module. The network coding effort notwithstanding, this approach is attractive because it allows the user to observe the resulting dynamic response of the network. These observations can then be used to adjust the parameters of the estimation algorithm, in an iterative process that may be manual or automated. The general approach adopted by the PARAMICS OD estimator combines an optimization based OD estimator with the microscopic network simulator, which includes a dynamic traffic assignment procedure. At every iteration, the user is allowed to adjust the *confidence weights* assigned to each detector measurement (link or turning flows). These weights in turn influence the distance from the measured values that the estimated values may take.

There is in principle no reason why any of the estimation techniques mentioned above could not be included in an iterative procedure. However it would be difficult for a model user to adjust the parameters of the estimator, since the relation between the inputs and the dynamic behavior is usually complicated. For example, it may not be clear how the entries in the target OD matrix should be adjusted in order to, say, shorten the queue in a particular left-turn pocket. In PARAMICS on the other hand, the user is allowed to adjust not only the target OD matrix, but also target turning and link flows. To shorten the queue, the user would simply increase the target turning flow exiting the queue without increasing the entering target flow. More generally, any adjustment to an aggregate quantity can be achieved through adjustments to the *turning flows*.

5.2 Proposed O-D Estimation Procedure

We present a mathematical program with a complete set of consistent turning flows, which are computed previously from the measurements. Because these flows are consistent, they can be imposed strictly upon the OD matrix search. Moreover the target OD matrix, which has traditionally been assumed available from surveys, is no longer needed. To compute the turning flows we describe a framework consisting of several steps. In the first step, the mid-block detector measurements are extended to the intersections. Then the boundary flows on each intersection are used to compute the total number of vehicles entering and exiting the main arterial in either direction. Third, the turning flows are computed from these values, and finally the OD matrix is found with an optimal search. This step-by-step approach is intended to split the larger problem into manageable parts, and thus allow for several levels of verification of the results.

We focus on a specific network topology, consisting of a single two-way arterial, intersected by a number of cross streets. The intersections may have three or four legs, as illustrated in Figure 4.1, and they may or may not be signalized. We will assume that at least some of the intersections (usually the signalized ones) are equipped with approach detectors located some distance upstream of the intersection, on both sides of the arterial. The measurements from these detectors constitute the primary source of data. Any additional counts or measurements, such as cross-street flows or queue length estimates, are considered as supplemental information that can

be used to tune the estimation parameters. As a matter of notation, we will assume that the arterial runs in the East-West direction, while the cross streets run North-South. The method is static, so the time index is omitted. The flow measurements are assumed aggregated over a sufficiently long period of time for the static assumption to hold.

The proposed procedure has four consecutive stages. Each stage is described in terms of its input and output data, and equations are suggested to relate the two. However, these equations are not expected to apply to all situations. They are one alternative derived from a set of assumptions. Another set of assumptions, perhaps better suited for a particular scenario, may lead to better equations. Our primary goal is to demonstrate a practical division of the OD estimation problem into smaller parts, where each part maybe solved either by making some assumptions or with additional information.

5.2.1 Stage 1: Data completion and extrapolation

This first stage gathers all of the data preprocessing steps. These steps may include data selection, data completion, and aggregation over lanes. The term ‘data selection’ refers to the often difficult task of choosing a data set with which to start the OD estimation procedure. This data set will preferably consist of measurements gathered on a single ‘normal’ day, but it may often be necessary to work with a composite data set, constructed from many different days. The selected data set may contain gaps in time, caused perhaps by brief communication failures, or space, due to missing or malfunctioning loops. These can be repaired with data reconstruction techniques such as those described in (4).

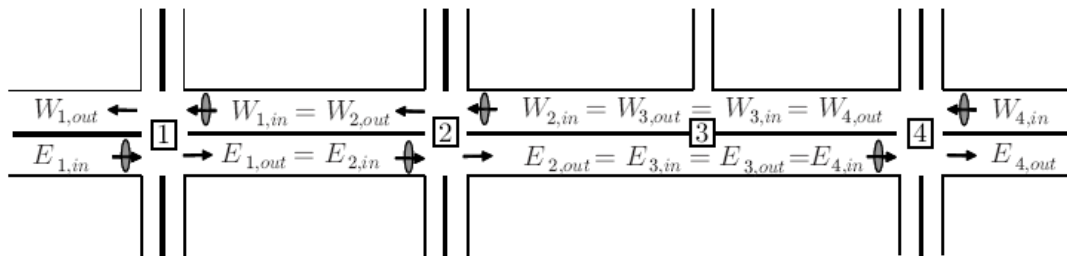

Figure 5.1 Measured Arterial Flows

The input to stage 2 is the flow entering and leaving each intersection along the arterial. The flows entering the arterial maybe measured, but the leaving flows are usually not. These maybe assumed equal to the flow entering the next downstream intersection as long as there is no intermediate source or sink, such as an unmeasured intersection or a large parking lot. This is illustrated in Figure 4.1, where $W_{2,out}=W_{1,in}$ and $E_{1,out}=E_{2,in}$. In the case that there is a significant source or sink, any supplemental information about its intensity should be considered in the computation of the exiting flows. Lacking additional information, the intervening unmeasured traffic sources must be considered as making no net contribution to the flow on the arterial. This is also shown in Figure 5.1 where $W_{4,out}$, $W_{3,in}$, and $W_{3,out}$ are all set equal to $W_{2,in}$.

5.2.2 Stage 2: Joining and leaving flows

Next we estimate the flow entering and exiting the arterial at each intersection, in each direction. Each intersection i is assigned an intersection weight η_i with larger intersection weights corresponding to larger cross street flows. The ends of the arterial are also assigned weights η_0 and η_{N+1} , where N is the number of intersections in the network (Figure 5.2).

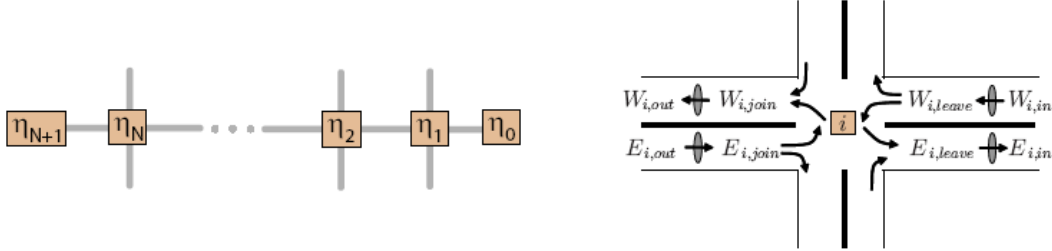

Figure 5.2 Numbering of Intersection Weights--Joining and Leaving Flows

The likelihood that a vehicle traveling along the arterial will turn at intersection i is defined as the ratio of the flow entering the intersection to the right and left turning flow. These likelihoods, computed for each intersection in the westbound and eastbound directions, are:

$$\alpha_{i,W} = \frac{W_{i,leave}}{W_{i,in}} \quad , \quad \alpha_{i,E} = \frac{E_{i,leave}}{E_{i,in}} \quad (1)$$

The notation is defined in Figure 5.2. We estimate the likelihoods $\alpha_{i,W}$ and $\alpha_{i,E}$ by taking the ratio of η_i to the sum of all downstream weights (i.e. all possible destinations).

$$\alpha_{i,W} = \max \left\{ \frac{\eta_i}{\sum_{j=i}^{N+1} \eta_j} , \frac{W_{i,in}}{W_{i,in} - W_{i,out}} \right\} \quad (2)$$

$$\alpha_{i,E} = \max \left\{ \frac{\eta_i}{\sum_{j=0}^i \eta_j} , \frac{E_{i,in}}{E_{i,in} - E_{i,out}} \right\} \quad (3)$$

The second terms in the max $\{ \}$ are needed to ensure positivity of the flows $W_{i,join}$ and $E_{i,join}$. The intersection weight η_i can be interpreted as a measure of the *attractiveness* of the intersection. The proportion of vehicles that turn equals the attractiveness of that intersection relative to the attractiveness of all downstream destinations.

The equations in the remainder of the paper apply equally to all intersections, so we will omit the intersection index in the presentation. Given the measured entering and leaving flows, Eqs. (4) and (5) express the conservation of vehicles on the arterial.

$$W_{in} - W_{leave} + W_{join} - W_{out} = 0 \quad (4)$$

$$E_{in} - E_{leave} + E_{join} - E_{out} = 0 \quad (5)$$

Combining the above, the leaving and joining flows are given by:

$$W_{leave} = \alpha_W W_{in} \quad (6)$$

$$E_{leave} = \alpha_E E_{in} \quad (7)$$

$$W_{join} = W_{out} - (1 - \alpha_W)W_{in} \quad (8)$$

$$E_{join} = E_{out} - (1 - \alpha_E)E_{in} \quad (9)$$

The task of this stage is to select the intersection weights η_i . The total number of parameters to tune is $N+2$, where as the number of degrees of freedom is $2N$ (W_{leave} and E_{leave} for each intersection). With the given assumptions we have therefore reduced the size of the problem from $2N$ variables per time slice to $N+2$ constant (but potentially time dependent) weights. This was achieved by imposing a strict relationship between the eastbound and westbound turning likelihoods. It should be noted that the estimated turning rates at each intersection depend on the weights of other intersections. Thus, the tuning of one intersection weight is not independent of the others. Also, the assumption of intersection weights, although very flexible, may not apply to some intersections. That is, their westbound and eastbound turning rates may not be related in the manner implied by Eqs. (2) and (3). In this case it is possible to assign independent weights to the eastbound and westbound directions.

The selection of intersection weights may be based on vehicle counts on the cross street, or, if a simulation model is available, on cross street queue lengths. Lacking any additional measurements from the cross streets, a simple classification into groups such as 'small', 'medium', and 'large', with corresponding weights of, for example, 1, 2, and 3, maybe suitable. This is demonstrated in the example of Section 5.3.

5.2.3 Stage 3: Turning movements

Once the overall level of cross street flow has been set, the next task is to fix the turning ratios. This is done by disaggregating the joining and leaving flows into north, south, east, and westbound portions. The notation is shown in Figure 5.3. The four left turning flows are directly tuned with four turning coefficients:

$$NW = \varphi_n W_{join} \quad (10)$$

$$SE = \varphi_s E_{join} \quad (11)$$

$$WS = \varphi_w W_{leave} \quad (12)$$

$$EN = \varphi_e E_{leave} \quad (13)$$

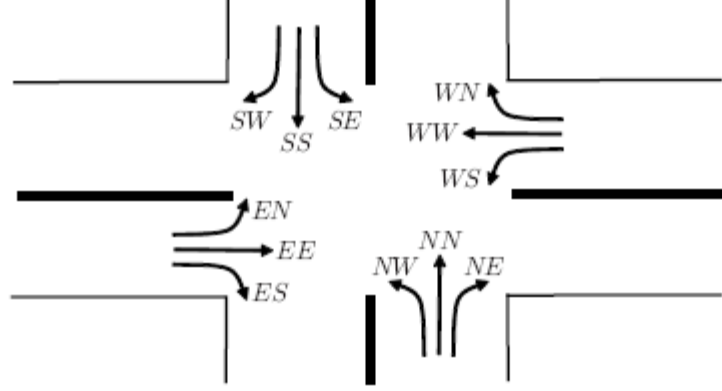

Figure 5.3 Turning Flows

Where ϕ_n , ϕ_s , ϕ_w , and ϕ_e range between 0 and 1. Lacking any additional information, all of these parameters should be set to the default value of 0.5. The right-turning flows are then computed directly from flow conservation equations:

$$SW = W_{join} - NW = (1 - \phi_n) W_{join} \quad (14)$$

$$NE = E_{join} - SE = (1 - \phi_s) E_{join} \quad (15)$$

$$WN = W_{leave} - WS = (1 - \phi_w) W_{leave} \quad (16)$$

$$ES = E_{leave} - EN = (1 - \phi_e) E_{leave} \quad (17)$$

Two additional parameters, γ_n and γ_s , are used to set the level of continuing flow on the cross streets:

$$NN = \gamma_n(NE + NW) = \gamma_n(1 - \phi_s)E_{join} + \gamma_n\phi_n W_{join} \quad (18)$$

$$SS = \gamma_s(SE + SW) = \gamma_s(1 - \phi_n)W_{join} + \gamma_s\phi_s E_{join} \quad (19)$$

Finally, continuing flows on the arterial are determined by α_W and α_E , which were fixed in stage 2.

$$WW = W_{in} - W_{leave} = (1 - \alpha_W)W_{leave} \quad (20)$$

$$EE = E_{in} - E_{leave} = (1 - \alpha_E)E_{leave} \quad (21)$$

The equations so far described can be gathered into a single matrix equation for ea intersection:

$$M = AU \quad (22)$$

where $U=[W_{in}, W_{out}, E_{in}, E_{out}]^T$, $M=[WN, WW, WS, SW, SS, SE, EN, EE, ES, NE, NN, NW]^T$ and

$$A = \begin{bmatrix} \alpha_W(1 - \phi_w) & 0 & 0 & 0 \\ \alpha_W(1 - \alpha_W) & 0 & 0 & 0 \\ \alpha_W \phi_w & 0 & 0 & 0 \\ (1 - \phi_n)(\alpha_W - 1) & 1 - \phi_n & 0 & 0 \\ \gamma_s(1 - \phi_n)(\alpha_W - 1) & \gamma_s(1 - \phi_n) & \gamma_s \phi_s(\alpha_E - 1) & \gamma_s \phi_s \\ 0 & 0 & \phi_s(\alpha_E - 1) & \phi_s \\ 0 & 0 & \phi_e \alpha_E & 0 \\ 0 & 0 & (1 - \alpha_E)\alpha_E & 0 \\ 0 & 0 & (1 - \phi_e)\alpha_E & 0 \\ 0 & 0 & (1 - \phi_s)(\alpha_E - 1) & 1 - \phi_s \\ \gamma_n \phi_n(\alpha_W - 1) & \gamma_n \phi_n & \gamma_n(1 - \phi_s)(\alpha_E - 1) & \gamma_n(1 - \phi_s) \\ \phi_n(\alpha_W - 1) & \phi_n & 0 & 0 \end{bmatrix}$$

We have defined seven tunable parameters for each intersection (η , ϕ_n , ϕ_s , ϕ_w , ϕ_e , γ_n , γ_s). These were assumed constant, since the general approach is static. However, different values of the parameters may be used for the morning versus the evening period, or even for every time slice. The numerical example of Section 5.3 describes an η that changes every 15 minutes.

The turning coefficients for three-legged (T) intersections are fixed to 0 or 1, according to Table 5.1. The only tunable parameter for these intersections is the intersection weight.

Table 5.1 Fixed Parameters for T Intersections

Configuration	ϕ_n	ϕ_s	ϕ_w	ϕ_e	γ_n	γ_s
T	1	0	1	0	0	0
L	0	1	0	1	0	0

5.2.4 Stage 4: OD matrix computation

The OD matrix is found by solving an optimization problem. Each turning flow calculated in the previous stage (12 for every 4-branch intersection and 6 for every 3-branch intersection) enters the problem in a separate equality constraint. Hence the total number of equality constraints is at most $12I$, where I is the number of intersections, whereas the number of OD pairs is $(2I+2)(2I+1)$. The problem is therefore underspecified for all values of $I > 1$.

It is important to note that the aggregate behavior of the network has been completely fixed by prescribing the turning flows. That is, all OD matrices in the feasible set have the same aggregate behavior, since the flows entering and exiting every link (and therefore the aggregate link densities) are the same. Any of the feasible OD matrices will therefore suffice, as long as we are only interested in matching aggregate quantities such as the total travel time.

In this context the choice of objective function is not very important. Some popular alternatives found in the literature include maximum entropy, minimum additional information, and least squares. In the numerical example we minimize the variance among the OD flows, defined in Eq. (24).

The optimization problem is stated in Eqs. (24)-(27). Barring U-turns, each OD pair has only a single connecting route. We can therefore define for each intersection $m \in [1 \dots I]$ and turning flow $n \in [1 \dots 12]$ a set U_{mn} of nodes that are upstream and a set D_{mn} of nodes that are

downstream of that flow. The sum of all OD pairs T_{ij} where $i \in U_{mn}$ and $j \in D_{mn}$ must then equal the turning flow f_{mn} calculated in the third stage (Eq.(26)). Also, each of the OD flows must be non-negative (Eq. (27)).

$$\text{minimize: } \sum_{ij \text{ pairs}} (T_{ij} - \bar{T})^2 \quad (24)$$

$$\text{subject to: } \bar{T} = \frac{1}{M} \sum_{ij \text{ pairs}} T_{ij} \quad (25)$$

$$\sum_{\substack{i \in U_{mn} \\ j \in D_{mn}}} T_{ij} = f_{mn} \quad \forall mn \text{ pairs} \quad (26)$$

$$T_{ij} \geq 0 \quad \forall ij \text{ pairs} \quad (27)$$

5.3 Application on the Selected Test Site

The OD estimation procedure was tested on the selected study section, a stretch of the Pacific Coast Highway in Lomita, California (Figure 4.1). This site includes a total of 11 intersections, seven of which are signalized (Table 5.2). Narbonne Avenue is the only cross street equipped with approach detectors.

Seventy week-days of loop detector data between March and June of 2006 were gathered. Each day contained 15-minute flows for each of the 37 mid-block detectors. The days were ranked according to the total flow accumulated over 24 hours. Many of the days were seen to have anomalously low total flows, due presumably to accidents or faulty detectors. About one third of the days were discarded on this basis. From the remaining two thirds we selected the median day (April 19th, 2006) for the experiment. In addition to the loop data, we made two field visits to gather supplemental information and observe traffic at each intersection for about 20 minutes during the afternoon peak period. We recorded approximate queue lengths on the arterial and cross streets, and made visual estimates of the turning coefficients described in Section 5.2.2. These observed turning coefficients provided a starting point for tuning the estimator.

The estimation algorithm was coded in the *Matlab* software and a microscopic model of the site was constructed in PARAMICS. The PARAMICS model was used to test candidate OD matrices and compare the simulated queue lengths with the field observations. Traffic signals control strategies in PARAMICS were simulated using the plug-in described in Chapter 6 of the report.

Table 5.2 lists the tuned parameter values. The weights for the ends of the arterial were set to $\eta_0 = \eta_{12} = 6$. Of the 61 tunable parameters (8 four-branch intersections + 3 three-branch intersection + 2 end weights), 32 were left at their default value, 3 of the parameters for Narbonne Ave. were calculated, while the remaining 26 were tuned by trial-and-error, with the aid of the microscopic simulator. Observing the progress of the microscopic model we were able to identify intersections where excessive queues formed and adjust the relevant turning flows without affecting the rest of the simulation. This is generally not possible with OD estimation techniques that do not directly tune the turning flows.

Table 5.2: Cross Streets and Tuned Parameter Values

Street Name	Index	Branches	Signalized	η	ϕ_n	ϕ_s	ϕ_w	ϕ_e	γ_n	γ_s
Walnut	1	4	✓	2.0	0.4	0.7	0.5	0.4	0.1	0.1
Bland	2	3	✗	0.2	0.0	1.0	0.0	1.0	0.0	0.0
Eshelman	3	4	✓	2.0	0.5	0.5	0.4	0.4	0.1	0.1
Oak	4	4	✓	1.0	0.5	0.5	0.5	0.5	0.0	0.0
Narbonne	5	4	✓	$\eta(k)$	0.5	0.5	0.2	0.2	0.5	0.5
Lucille	6	4	✗	0.2	0.5	0.5	0.5	0.5	0.0	0.0
Cypress	7	4	✓	1.0	0.5	0.5	0.5	0.5	0.0	0.0
Viana	8	3	✗	0.2	0.0	1.0	0.0	1.0	0.0	0.0
Pennsylvania	9	4	✓	1.0	0.5	0.5	0.2	0.2	0.0	0.0
Hillworth	10	3	✗	0.2	0.0	1.0	0.0	1.0	0.0	0.0
Airport	11	4	✓	1.0	0.5	0.5	0.5	0.5	0.0	0.0

Narbonne Ave. (Index=5 in Table 5.2) was the only intersection where additional measurements on the cross street were available. The total northbound and southbound flows approaching the intersection on Narbonne during time interval k are denoted $\hat{N}(k)$ and $\hat{S}(k)$. Using these measurements we were able to explicitly compute a time varying intersection weight ($\eta(k)$) and joining parameters (ϕ_n and ϕ_s) such that the computed flows matched the measured flows:

$$NN(k) + NE(k) + NW(k) = \hat{N}(k) \quad (28)$$

$$SS(k) + SE(k) + SW(k) = \hat{S}(k) \quad (29)$$

Replacing the terms on the left with their expressions from Sections 5.1.2 and also fixing $\gamma_n = \gamma_s = \gamma$

We find by adding Eqs.(28) & Eqs.(29) that $\eta(k)$ is a root of the following quadratic:

$$A(k) \eta(k)^2 + B(k) \eta(k) + C(k) = 0 \quad (30)$$

where:

$$A(k) = W_{in}(k) + E_{in}(k) - F(k) \quad (31)$$

$$B(k) = W_{in}(k) \eta_E + E_{in}(k) \eta_W - F(k)(\eta_W + \eta_E) \quad (32)$$

$$C(k) = -F(k) \eta_W \eta_E \quad (33)$$

$$F(k) = \frac{\hat{N}(k) + \hat{S}(k)}{1 + \gamma} + W_{in}(k) - W_{out}(k) + E_{in}(k) - E_{out}(k) \quad (34)$$

$$\eta_E = \sum_{j=0}^4 \eta_j = 11.4 \quad , \quad \eta_W = \sum_{j=6}^{12} \eta_j = 9.6 \quad (35)$$

The resulting time-varying intersection weight is shown in Figure 5.4. By requiring that the Eqs. (28) and Eqs. (29) hold separately, we find the following expression for $\phi_n(k)$ and $\phi_s(k)$:

$$\phi_n(k) = \frac{\hat{N}(k)}{\hat{N}(k) + \hat{S}(k)} \quad , \quad \phi_s(k) = \frac{\hat{S}(k)}{\hat{N}(k) + \hat{S}(k)} \quad (36)$$

However, instead of allowing ϕ_n and ϕ_s to change in time, we take these parameters to be constants equal to the mean of the values obtained with Eq. (36). The values thus computed are $\phi_n=0.51$ and $\phi_s=0.49$, practically identical to the default values.

Figure 5.4 shows the measured flows on the PCH approaching the Narbonne intersection. Observe that during the middle part of the day, between approximately 9:00am and 3:00pm, both W_{out} and E_{out} are larger than W_{in} and E_{in} , so there are more vehicles joining the PCH from Narbonne than leaving it during these hours. This is reflected in the result of the second stage, shown in Figure 4.5, where both W_{join} and E_{join} are larger than W_{leave} and E_{leave} between 9:00am and 3:00pm. The plots on the right side of Figure 5.5 compare the flow measured on Narbonne Avenue. With the estimated flows, the two lines in these plots would coincide perfectly had we allowed ϕ_n and ϕ_s to vary with time.

With regard to the optimization problem, several preprocessing steps were found to improve the performance of the solver. First, the problem contains several unused OD pairs which should be removed. These include diagonal elements in the OD matrix and OD pairs for which we expect zero flow. For example, in the Lomita network we do not expect any vehicles departing from the southern source on Walnut St. to use Bland St., since continuing on Walnut is clearly a better option. This is enforced in the example by eliminating the OD pair connecting Walnut South to Bland St. Second, some of the turning flows, which appear on the right hand side of Eq. (26), may be negligibly small. Because these flows represent the sum of a list of non-negative OD flows, it can be concluded that each of the OD flows are also very small and can therefore be discarded. Finally, there may be some OD pairs whose flow is given directly by a turning flow. This is the case for the WN and WS flows at the Walnut intersection. Making these simplifications, the size of the problem was reduced from 441 variables with 112 equality constraints to 222 variables with 50 equality constraints.

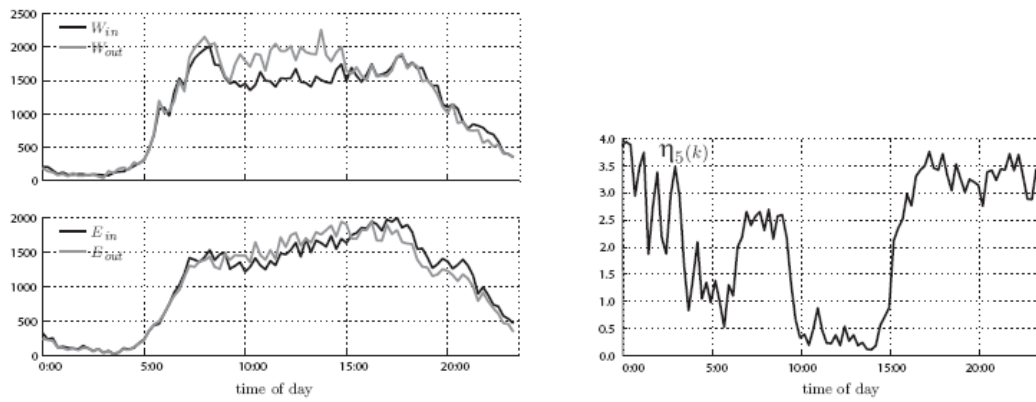

Figure 5.4 Narbonne Avenue: Arterial Flows (vph) and Intersection Weight

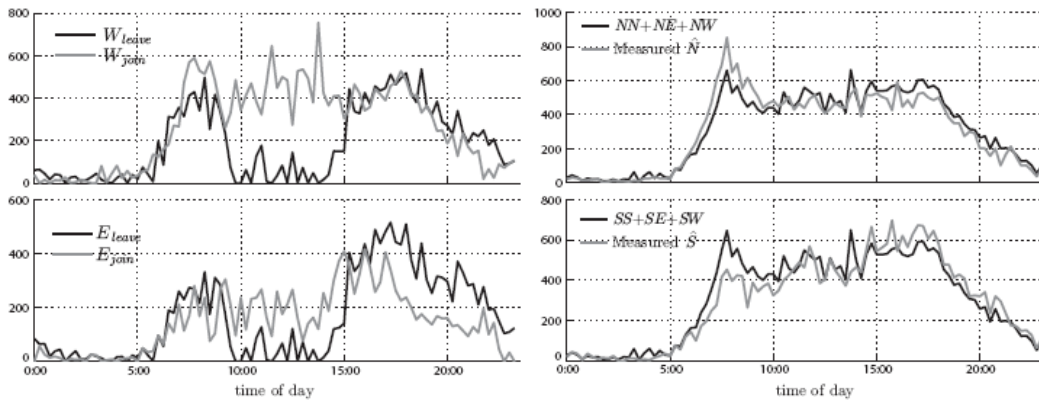

Figure 5.5 Narbonne Avenue: Estimated Flows (vph)

CHAPTER 6

PARAMICS PLUG-IN FOR SIGNAL CONTROL

In this Chapter we describe a plug-in we developed for the PARAMICS simulation model to explicitly simulate a number of signal control strategies including actuated signal control and traffic responsive control.⁵

The plug-in implements many of the strategies developed by the Urban Traffic Control System (UTCS) program (11, 27). The UTCS strategies are classified into three generations: the first generation consists of methods for selecting timing plans developed offline from a stored library. The second and third generations automatically generate new timing plans based on measured data. The strategies included in the first generation UTCS are pretimed (time-of-day), traffic responsive, and critical intersection control. These were first tested in downtown Washington D.C. in early 1970's and they have since become standard features in many NEMA and 170 type controllers. Some of the strategies included in the new plug-in were previously implemented in PARAMICS by researchers at the University of California at Irvine under a previous PATH study (9). Our plug-in can be thought of as extending the existing simulation application program interfaces (APIs) to include complex adaptive strategies such as RHODES and TUC.

Figure 6.1 shows a typical layout for an eight phase four-legged signalized intersection. Three-legged intersections are also supported. The eight through and left-turn phases are numbered according to the NEMA convention. Each of these can be equipped with a set of *approach* detectors, and/or a set of *stopline* detectors, depending on the implemented control strategy. It is assumed that the single-lane loop detector model of PARAMICS is used.

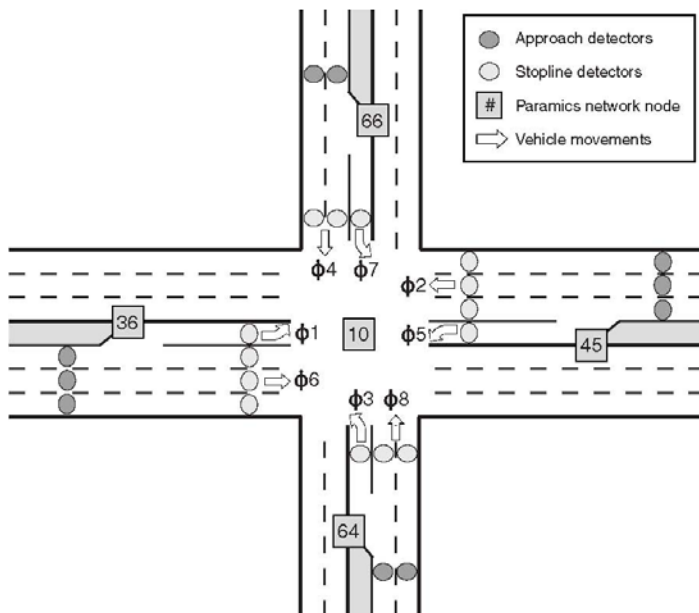

Figure 6.1 Typical Signalized Intersection Layout

⁵ This Chapter was originally published in "A PARAMICS Plugin for Actuated Signal Control and First Generation UTCS", by G. Gomes and A., Skabardonis, PATH Working paper, UCB-ITS-PWP-2006-8, July 2006.

The function of the approach detector in vehicle actuated control is to extend the green time and to count vehicles for calculating the initial green time. Approach detection is used in traffic responsive control to generate the traffic patterns, while in critical intersection control it is used to compute green demands. These detectors are typically located about 200 feet upstream from the intersection stopline.

Stopline detectors are usually placed at or within a few feet upstream of the intersection stopline, and are used in actuated signal control to place calls for service on particular phases. Related to the placement of stopline detectors, we have noticed a behavior in PARAMICS that can cause the plug-in to fail. Namely, vehicles wishing to turn left at an intersection which are unable to change lanes into the dedicated left-turn lane before reaching the stopline, will often change lanes from a standstill and move laterally onto the stopline detector. These vehicles, because they do not trigger the PARAMICS detector in the normal way, do not place a call for service. They also prevent other vehicles from going over the detector. The left turn phase is therefore always skipped, and an unboundedly long queue can form. To avoid this problem, we recommend placing the stopline detectors in the model a bit farther upstream.

The main input file for the plug-in is param_main.txt. This file provides geometric, output, and high level control information for the simulation. An example input file is provided in Figure 6.2. Each line in the file begins with a case-sensitive token, followed by information separated by blank spaces or tab characters. Comments can be inserted using the percentage symbol (%).

The first line in the file determines the control strategy. The accepted values for the controller token are:

```
TOD    .... time-of-day
ASC    .... actuated signal control
ASC    .... traffic responsive control
ASC    .... traffic responsive with critical intersection control
```

The output period token defines the aggregation period for the loop detector output file in seconds. This value does not affect the controller behavior in any way. If omitted, the output file will not be generated.

Traffic responsive and critical intersection control use smoothed measurements, as opposed to raw detector measurements. The smoothed data is generated with a first-order filter:

$$\begin{aligned} \text{vol}^s[k] &= (\tau) \text{vol}^s[k-1] + (1-\tau) \text{vol}^r[k] \\ \text{occ}^s[k] &= (\tau) \text{occ}^s[k-1] + (1-\tau) \text{occ}^r[k] \end{aligned}$$

where the superscripts s and r indicate smoothed and raw variables. Raw measurements are 1-minute average values. τ is a filter parameter related to the time constant T_c (defined as the time to reduce the filter error by 63%) by $\tau = e^{-\Delta t/T_c}$, where Δt is the simulation step size. The time constant T_c is defined by the user in seconds with the time constant token.

The rest of the file describes the signalized intersections. Each intersection begins with the node token, followed by the ID number for the PARAMICS network node. This number is the “node name” in PARAMICS Modeller. Although PARAMICS allows character strings for its node name, this plug-in requires a positive integer-valued node name. Also, the plug-in overrides all signal timing and priority settings defined in PARAMICS.

```

controller    ASC
outputperiod  60
timeconstant  30
%-----
node 10                               % Walnut St.
phase2nodes  45 36
phase4nodes  66 64

% phase#      1  2  3  4  5  6  7  8
protected    1  1  1  1  1  1  1  1
permissive   0  0  1  0  0  0  1  0

det 1 S n10_1_S_1
det 2 A n10_2_A_1 n10_2_A_2 n10_2_A_3
det 2 S n10_2_S_1 n10_2_S_2 n10_2_S_3
det 4 A n10_4_A_1
det 5 S n10_5_S_1
det 6 S n10_6_S_1 n10_6_S_2 n10_6_S_3
det 6 A n10_6_A_1 n10_6_A_2 n10_6_A_3
det 8 A n10_8_A_1

%-----
node 11                               % Eschelman St.
phase2nodes  46 48
phase4nodes  50 47

% phase#      1  2  3  4  5  6  7  8
protected    1  1  0  1  1  1  0  1
permissive   0  0  0  0  0  0  0  0

det 1 S n11_1_S_1
det 2 A n11_2_A_1 n11_2_A_2 n11_2_A_3
det 2 S n11_2_S_1 n11_2_S_2 n11_2_S_3
det 3 S n11_3_S_1
det 4 S n11_4_S_1
det 5 S n11_5_S_1
det 6 P n11_6_S_1 n11_6_S_2 n11_6_S_3
det 6 A n11_6_A_1 n11_6_A_2 n11_6_A_3
det 7 S n11_7_S_1
det 8 P n11_8_S_1

```

Figure 6.2 PARAMICS Plug-In Main Input File (param_main.txt)

The phase 2 nodes and phase 4 nodes tokens are used to orient the NEMA numbering scheme with respect to the intersection. The two numbers following phase 2 nodes and phase 4 nodes are respectively the *from* and *to* nodes for phases ϕ_2 and ϕ_4 . To illustrate, the nodes from the sample input file are shown in Figure 6.1. For three-legged intersections, *the from and to* node for either phase 2 nodes or phase 4 nodes should be set to -1.

The protected and permissive tokens define the basic signaling features of the intersection. They are followed by a sequence of eight 0/1 values corresponding to the eight vehicle phases. Protected phases are those that are directly controlled by the traffic signal. Permissive phases are left turns that are allowed to proceed without an exclusive left turn phase (green arrow) when the opposing through phase has the right-of-way. For example, setting ϕ_1 to permissive means that vehicles in that phase are allowed to turn left during the green interval of ϕ_2 . Only left-turn phases can be made permissive.

Loop detectors are assigned to phases using the det token. The syntax for this line is:

```
det [phase number 1-8] [detector type S|A] [list of detector names]
```

The detector names are those defined in PARAMICS Modeller. Phases are not required to have stopline or approach detectors. Furthermore, a single detector maybe associated with more than one phase.

Aggregated raw measurements from each of the loop detectors listed in param_main.txt are exported to output_loop.txt. This file contains a matrix with 7 columns and a row for every detector and aggregation interval. The column headers are given in Table 6.1 below.

Table 6.1 Column Headers for output_loop.txt

Column #	Value
1	Start time for the aggregation period
2	Node ID
3	phase ID
4	1=Approach ; 0=Stopline
5	Lane
6	Vehicle count [veh]
7	Occupancy $\in[0,1]$

The program also produces a log file called output_log.txt, which collects error and warning messages generated during the simulation. Cycle lengths and green times are exported to output_controldata.txt. The column headers for this file are given in Table 6.2

Table 6.2 Column Headers for output_control.txt

Column #	Value
1	Cycle start time
2	Intersection node number
3	Cycle length
4-11	Green time for phases 1 through 8

6.1 Signal Timing Plans and Time-of-Day Control (TOD)

Under TOD control, every intersection operates according to a predefined plan with fixed cycle length, green times (splits), offsets and phase sequences. PARAMICS offers an interface for creating preset plans, however we provide another here which is used by the traffic responsive controller described in section 6.4. The input file for TOD control is `param_tod.txt` (Figure 6.3). Each plans is defined by an integer following the plan token. The `todstart` and `todplan` tokens are used to set the times for switching between plans. For example, the sample input file will tell the controller to switch from plan1 to plan2 at $t = 300$ seconds, and back to plan1 at $t = 400$ seconds.

```

todstart    0 300 400
todplan     1  2  1
transdelay  80
%=====
plan 1
cyclelength 90
% .....
node 10
offset 0
%      phaseA  phaseB  green  yellow  red  clear
stage  1       5      15      3        3
stage  2       6      25      4        3
stage  3       7      15      3        3
stage  4       8      17      4        3
% .....
node 11
offset 0
%      phaseA  phaseB  green  yellow  red  clear
stage  1       5      22      4        3
stage  2       6      30      4        3
stage  4       8      25      4        3
%=====
plan 2
cyclelength 60
% .....
node 10
offset 0
%      phaseA  phaseB  green  yellow  red  clear
stage  1       5      10      3        3
stage  2       6      27      4        3
stage  3       7      10      3        3
stage  4       8      25      4        3
% .....
node 11
offset 0
%      phaseA  phaseB  green  yellow  red  clear
stage  1       5      17      4        3
stage  2       6      25      4        3
stage  4       8      35      4        3

```

Figure 6.3 Input File for Time-of-Day Control (`param_tod.txt`)

Traffic signal controllers do not change timing plans instantaneously. This would result in truncated green and red intervals, which would be dangerous for drivers and pedestrians. Instead, they transition in a gradual manner, with small adjustments to each consecutive cycle. Different

controller manufacturers employ different signal transition procedures. This plug-in does not attempt to reproduce those procedures, but instead inserts a delay between the decision to change plans and the realization of the change. A nominal delay value is defined by the user with `transdelay`. This nominal value is rounded up to an integer multiple of the current cycle length. In the example, `plan1` will actually be in effect from $t = 0$ to $t = 390 = 300 + \text{one plan1 cycle}$. `Plan2` will then be activated from $t = 390$ to $t = 520 = 400 + \text{two plan2 cycles}$.

Each network plan consists of a number of intersection-specific plans, which contain stage sequences and corresponding green, yellow, and red clearance times. It is left to the user to ensure that the phases combined in each stage are compatible. The start time for the intersection plan is shifted with respect to the master clock by `offset` seconds. The master clock rotates with cycle length `cycle length` in seconds. As in `param_main.txt`, each signalized intersection is identified by `node`. The sequence of stages is set with the `stage` token. The syntax for this line is:

stage [phase ID] [phase ID] [green sec] [yellow sec] [red clear sec]

In the case that a stage involves only one phase, the second phase ID should be set to zero. The sum of the green, yellow, and red clearance times for each intersection must not exceed the cycle length. All signals are set to red during the time remaining after the end of the last stage. Actual traffic controllers usually give this time to the major through movements. To mimic this behavior, it is recommended that an additional stage be added to fill in any leftover time.

6.2 Actuated Signal Control (ASC)

The plug-in implements a fully actuated eight-phase dual-ring traffic controller. Under actuated control each intersection operates locally, with no communication to adjacent intersections. The controller architecture has two levels: an upper level represented by a dual-ring controller (section 6.2.1) and a lower level that executes the individual phases (section 6.2.2).

6.2.1 The dual-ring controller

The objective of the dual-ring controller is to maintain safe conditions by allowing only compatible vehicle movements to enter the intersection at any time. Compatible movements or phases are those that a) belong to different rings, and b) are on the same side of the barriers (see Figure 6.4). Phases on the opposite sides of a barrier are in conflict, and therefore cannot be combined. For example, the only compatible options for ϕ_2 in Figure 6.4 are ϕ_5 and ϕ_6 .

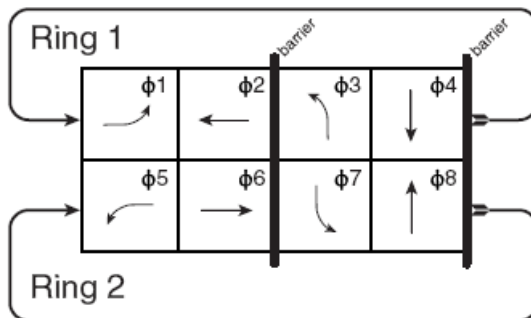

Figure 6.4 Dual-Ring Controller

The controller advances by initiating phases and, upon termination, selecting the next one to execute. The upcoming phase is found by searching the ring for the next protected phase which has either registered a vehicle presence or has been designated as a recall phase. Unprotected phases are always skipped. A recall phase cannot be skipped, even if no vehicle is registered by its stopline detectors. Recalls are typically applied to the through phases of major streets. They are also often used on cross streets lacking stopline detection. If no vehicle is registered on a non-recall phase, that phase maybe skipped.

Left turns can be either leading or lagging, depending on their position in the ring with respect to the opposing through phase. All of the left-turn phases in Figure 6.4 are leading. Phase ϕ_1 is made a lagging left turn by swapping its position with ϕ_2 .

All of these features are included in the plug-in. The main task of updating the active phases is implemented in two steps. First, whenever one of the two active phases terminates, the next service able phase in the ring is found with the NextPhase() function. This function is passed an active or inactive phase, and returns the next protected phase with a vehicle call or are call status. It returns the input phase if it is still active. It also returns the input phase if none of the other three phases in its ring require service. The pair of phases found with NextPhase() may not be compatible. The second step is to find the number of barriers crossed in each ring in the transition from the current phase to the NextPhase(). This number—0, 1, or 2—may not be the same for both rings. The following logic is then applied to adjust the selected pair of phases so that they remain compatible:

```

if( both rings jump the same number of barriers )
    - transition to NextPhase() on both rings
else
    if( one ring jumps zero barriers )
        - that ring transitions to NextPhase()
        - the other remains in its current phase
    else /* the only remaining case is one jumps one barrier, the other two */
        - the one that jumps one barrier goes to NextPhase().
        - the other goes to the compatible through phase.

```

6.2.2 Interval timing

The execution of a signal phase is illustrated in Figure 6.5. The dual-ring controller initiates the phase at “START”. This point is synchronized with the transition from green to yellow of the previous phase (“END”). The initial wait period is equal in length to the yellow and red clearance intervals of the previous phase. Thus, the transition from wait to green is simultaneous with the transition from red clearance to idle of the outgoing phase. The green interval is divided into two portions: the initial green interval and the extension interval. The duration of the initial green interval is calculated based on the maximum number of vehicles registered by the approach loops during the preceding red interval. Each detected vehicle increases the green period by add per vehicle. The result is limited by min green and max initial:

$$\text{initial green} = \min \left\{ \max \left\{ (\text{largest count}) \times \text{addpervehicle}, \text{mingreen} \right\}, \text{maxinitial} \right\}$$

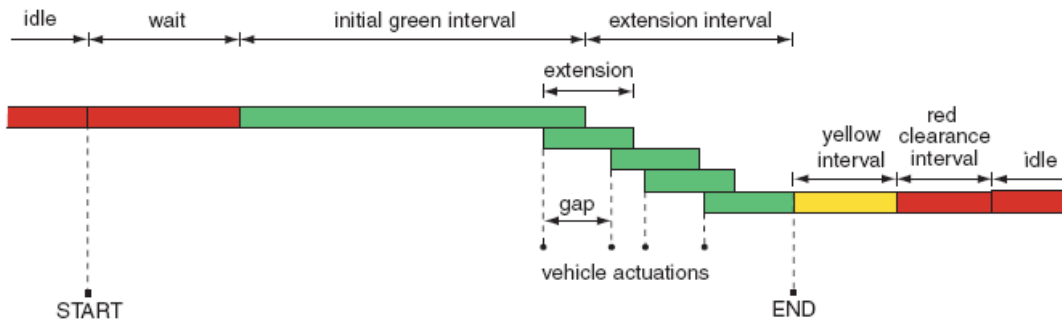

Figure 6.5 Interval Timing

During the green interval, vehicles detected by an approach loop are given extension seconds of green time to move through the intersection, without exceeding the maximum green duration of *maxgreen*. The green interval ends when the maximum green time is reached (*max out*), or when the time gap between consecutive vehicle actuations exceeds the largest permitted gap (*gap out*). The permitted gap is a function of time, as plotted in Figure 6.6. It starts at the *maxgap* value and begins to decrease after a vehicle is detected on a conflicting phase. The gap is reduced according to the controller parameters “reduce gap by” and “reduce every”, until it reaches its minimum value, *mingap*. The yellow and red clearance intervals have fixed durations of yellow time and red clearance time.

The parameters involved in the ASC algorithm are entered by the user in *param_asc.txt*. A sample input file is shown in Figure 6.7. The recall token is used to set the recall status of the phases to on (1) or off (0). Entries in the lag left line indicate whether left turns are lagging (0) or leading (1). The remaining parameters are defined in seconds.

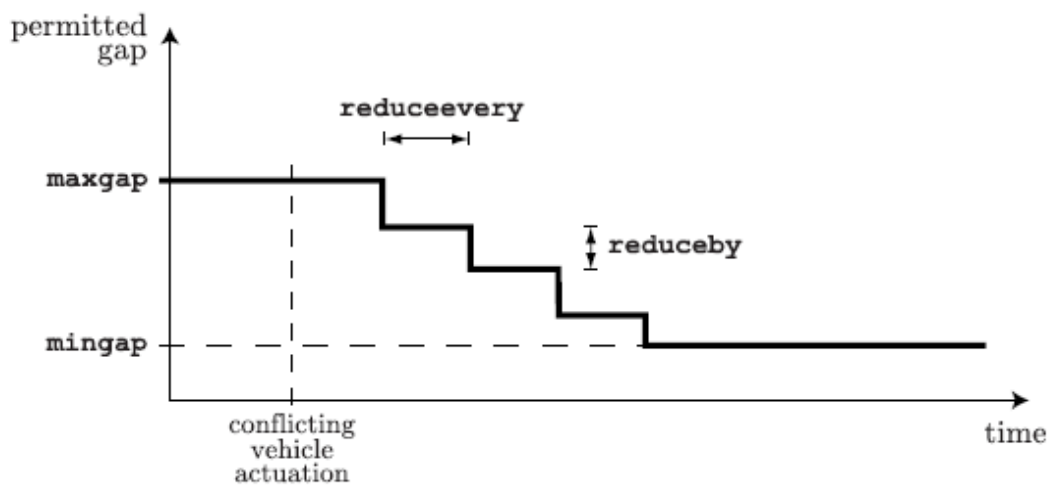

Figure 6.6 Permitted Gap Function

node 10								
% phase#	1	2	3	4	5	6	7	8
recall	0	1	0	0	0	1	0	0
lagleft	1	0	0	0	1	0	0	0
mingreen	10	20	10	40	10	20	10	40
addpervehicle	2.1	2.1	2.1	2.1	2.1	2.1	2.1	2.1
maxinitial	20	30	20	50	20	30	20	50
maxgreen	30	40	30	60	30	40	30	60
extension	2.5	3.5	2.5	3.5	2.5	3.5	2.5	3.5
maxgap	2.5	5.0	2.5	2.5	2.5	5.0	2.5	2.5
mingap	2.5	2.5	2.5	2.5	2.5	2.5	2.5	2.5
reducegapby	0.1	0.1	0.1	0.1	0.1	0.1	0.1	0.1
reduceevery	2.0	2.0	2.0	2.0	2.0	2.0	2.0	2.0
yellowtime	3.0	3.5	3.0	3.5	3.0	3.5	3.0	3.5
redcleartime	1.0	1.0	1.0	1.0	1.0	1.0	1.0	1.0
node 11								
% phase#	1	2	3	4	5	6	7	8
recall	0	1	0	0	0	1	0	0
lagleft	0	0	0	0	0	0	0	0
mingreen	10	20	0	40	10	20	0	40
addpervehicle	2.1	2.1	0	2.1	2.1	2.1	0	2.1
maxinitial	20	30	0	50	20	30	0	50
maxgreen	30	40	0	60	30	40	0	60
extension	2.5	3.5	0	3.5	2.5	3.5	0	3.5
maxgap	2.5	5.0	0	2.5	2.5	5.0	0	2.5
mingap	2.5	2.5	0	2.5	2.5	2.5	0	2.5
reducegapby	0.1	0.1	0	0.1	0.1	0.1	0	0.1
reduceevery	2.0	2.0	0	2.0	2.0	2.0	0	2.0
yellowtime	3.0	3.5	0	3.5	3.0	3.5	0	3.5
redcleartime	1.0	1.0	0	1.0	1.0	1.0	0	1.0

Figure 6.7 Input File for Actuated Signal Control (param_asc.txt)

6.3 Traffic Responsive Control (TRSP)

The two coordinated modes included in the first generation UTCS are time-of-day and traffic responsive control (TSRP). TOD is often sufficient for systems with predictable traffic volumes; TRSP is preferred if there are significant day-to-day fluctuations in demand. This is because TRSP can automatically respond to variations by selecting an appropriate signal timing plan for the measured traffic conditions.

Under TRSP control, flow and occupancy measurements from *system loops* are used to calculate a characteristic 'vpko' (volume plus K occupancy) value for each loop l :

$$vpko(l) = vol^s(l) + K \times occ^s(l)$$

Here, $vol^s(l)$ and $occ^s(l)$ are the smoothed volume and occupancy measurements for system loop l , and K is a system constant. The current state of the network is represented by the array of all $vpko(l)$ values. System loops are typically the approach loops on the main arterial.

The controller also stores a number of signal timing plans with associated $vpko$ signatures. The signature for the p -th plan consists of $vpko$ values for each of the system loops $vpko(p,l)$. The controller selects a timing plan from its library by comparing the stored signatures to the measured traffic signature, and finding the best match in terms of a weighted 1-norm:

$$\Delta(p) = \sum_l W(l) | vpko(l) - \overline{vpko}(p, l) | \quad \text{for each plan } p$$

$W(l)$ are loop-specific weighting factors. The plan with the smallest $\Delta(p)$ value is considered the best option for the current traffic condition. A transition to this plan will be initiated if the $\Delta(p)$ for the currently active plan is larger than a prescribed threshold. As with TOD control, the transition process is approximated with a user-defined delay interval.

The implementation of traffic responsive control on Lomita Avenue used the existing system detectors on the approaches of phases 2 and 6 on all intersections (Figure 6.8). Note that cross street approach system detectors exist only at the Narbonne intersection. The value of K was set to 10. A signature $vpko$ was given to each detector, and the detector signature were updated every 60 seconds. The minimum $\Delta(p)$ required to cause a change in the pretimed plans was set to 1, a relatively small value, so the system was fairly sensitive to errors.

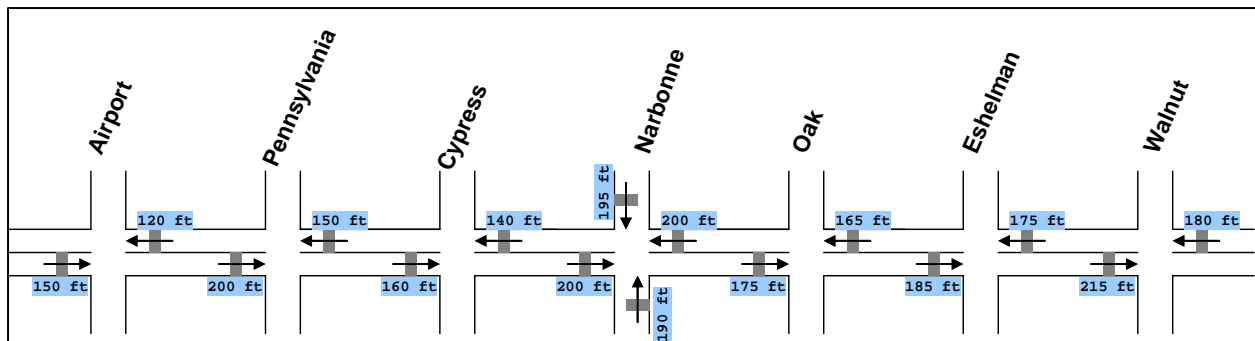

Figure 6.8 Detector Locations for Traffic Responsive Control –Lomita Avenue

Figure 6.9 shows the plug-in input file for TRSP control. The traffic responsive calculation is performed every update time seconds. $kweight$ is the value of K . The system loops and their respective weighting factors $W(l)$ are listed with the `det` token. The timing plans are given in `param_tod.txt`. The characteristic signatures for each of these plans are defined using `plan` and `sig`. The syntax for the `sig` line is:

sig [loop name] [signature flow [vph]] [signature occupancy ∈ (0,1)]

```

updatetime 900          % 15 minutes
minchange  1.0
kweight    20

% System loops .....
%--- Loop name      W
det  n10_2_A1      3.0
det  n10_2_A2      3.0
det  n10_6_A1      3.0
det  n10_6_A2      3.0
det  n11_2_A1      3.0
det  n11_2_A2      3.0
det  n11_6_A1      3.0
det  n11_6_A2      3.0

% Signatures .....
plan 1
%--- Loop name      Flow  Occ
sig  n10_2_A1      500  0.7
sig  n10_2_A2      500  0.7
sig  n10_6_A1      100  0.1
sig  n10_6_A2      100  0.1
sig  n11_2_A1      500  0.7
sig  n11_2_A2      500  0.7
sig  n11_6_A1      100  0.1
sig  n11_6_A2      100  0.1

plan 2
%--- Loop name      Flow  Occ
sig  n10_2_A1      100  0.1
sig  n10_2_A2      100  0.1
sig  n10_6_A1      500  0.7
sig  n10_6_A2      500  0.7
sig  n11_2_A1      100  0.1
sig  n11_2_A2      100  0.1
sig  n11_6_A1      500  0.7
sig  n11_6_A2      500  0.7

```

Figure 6.9 Input File for Traffic Responsive Control (param_trsp.txt)

6.4 Critical Intersection Control (CIC)

Critical intersection control is a feature of many implementations of the UTCS software which complements the TRSP strategy. This feature enables the controller to respond more quickly to short-term variations in demand, while preserving coordination on the major street, by automatically adjusting the green times of *critical intersections* based on local measurements. CIC requires that all of the approaches to the critical intersections be equipped with approach loops.

CIC calculates the total *green demand* for all phases in a critical intersection using volume and occupancy measurements from the approach loops. This amount is reduced by the minimum green duration to obtain the excess green demand for each stage. The actual green times are then calculated by distributing the available excess green time among all the stages, in proportion to their excess green demand.

The plug-in provides two options for computing the green demands. The first is used by Los Angeles Department of Transportation ATSAC system (25):

$$gd(l) = A (vol^s(l))^B + C (occ^s(l))^D$$

$gd(l)$ is the green demand measured by approach loop l . A , B , C , and D are user-defined coefficients. $vol^s(l)$ and $occ^s(l)$ are smoothed volumes and occupancies. The second is the standard UTCS formula appearing in the Traffic Control Systems Handbook (9):

$$gd(l) = K_1 occ^s(l) + K_2 vol^s(l) + K_3 vol^s(l) occ^s(l)$$

K_1 , K_2 , and K_3 are user-defined coefficients. The excess green demand for the stage $gd_e(s)$ is calculated as the largest of the green demands for the associated approach loops, reduced by the minimum green interval, and limited below by zero:

$$gd_e(s) = \max \left\{ \max_l \{ gd(l) \} - mingreen(s) ; 0 \right\}$$

The actual green times $g(s)$ are found by apportioning the available excess green time G_e to the stages:

$$g(s) = \frac{gd_e(s)}{\sum gd_e(s)} \times G_e + mingreen(s)$$

with $G_e = \text{cyclelength} - \sum_s \left(\text{mingreen}(s) + \text{yellowtime}(s) + \text{redcleartime}(s) \right)$

The parameters used by CIC are defined in `param_cic.txt`. A sample input file is shown in Figure 6.10. Update cycles defines the CIC update period as an integer multiple of the cycle length. The green demand formula is selected by setting `gdfunction` to `ATSAC` or `UTCS`. The coefficients in the green demand function are defined with `gdcoef` using the following format:

```
gdcoef [A] [B] [C] [D]           if gdfunction = ATSAC
gdcoef [K1] [K2] [K3]       if gdfunction = UTCS
```

Critical lists the node numbers for the critical intersections. Min green is an optional input, which can be used to redefine the minimum green time used by CIC. If set to zero, the minimum green time will be that of `param_tod.txt`. Otherwise min green(s) will be set to the largest of the entries for the phases combined in stage s . The cycle length, offset, yellow time, and red clear time are taken from `param_tod.txt`.

We applied CIC control to the Narbonne intersection only. This is the only intersection with system detectors on all approaches (Figure 6.8). We used the Los Angeles DOT ATSAC formula for calculation of green demands with the following parameter values: $A = 7.50$, B

=0.50, C = 0.33 and D = 1.00. The “updatecycles” was set to 1, meaning that the CIC adjustment was applied to every signal cycle.

```

updatecycles 1
gdfunction   ATSAC
gdcoef      7.5 0.5 0.33 1.0
critical    10 11

%-----  node  1    2    3    4    5    6    7    8
mingreen  10   0   12   0   7    0   12   0   7

```

Figure 6.10 Input File for Critical Intersection Control (param_cic.txt)

6.5 Extensions—Adaptive Signal Control

This section of the report focuses on some of the architectural aspects of the plugin that allow it to be connected to external “black box” control algorithms, such as RHODES and TUC. This architecture was designed to mimic the basic operation of a 170-type controller and its interaction with external control algorithms via *force-off*, *hold*, and *omit* messages.

Figure 6.11 is a schematic representation of the program structure assigned to each signalized intersection. The central component is the *signal manager*. The signal manager coordinates and passes information among the peripheral objects, which are the *lights*, the *detectors*, and the *controller*. The figure shows the information that is passed between the signal manager and each of the peripheral objects. An external signal control algorithm such as RHODES (whether isolated or coordinated), appears to the signal manager as a *controller* that translates detector and signal states (“all info” in the figure) into transition and flush requests. Transition requests are hold, force-off, and omit for each of the 8 phases. The controller can also request to flush or reset any of the vehicle counts maintained by the signal manager. The transition requests made by the controller are put through a series of consistency and safety checks (e.g. dual ring conditions, minimum green times) and either discarded or passed along to the lights as transition commands. The lights or phases in turn communicate their status to the signal manager, which decides based on detector information, controller requests, and signal states, which phases should be terminated.

This architecture captures the basic behavior of real 170-type controllers. Therefore, any control algorithm that is designed to operate using standard hold, force-off, and omit messages (such as RHODES) can be easily connected to the plugin and simulated in Paramics. In the case of RHODES, the connection was made using the Windows socket mechanism. In the case of TUC, we were provided by the developers with source code.

The implementation of RHODES required stop bar detector in addition to the existing system detectors. Figure 6.12 shows the detector placement at the Narbonne intersection for simulation of the RHODES strategy.

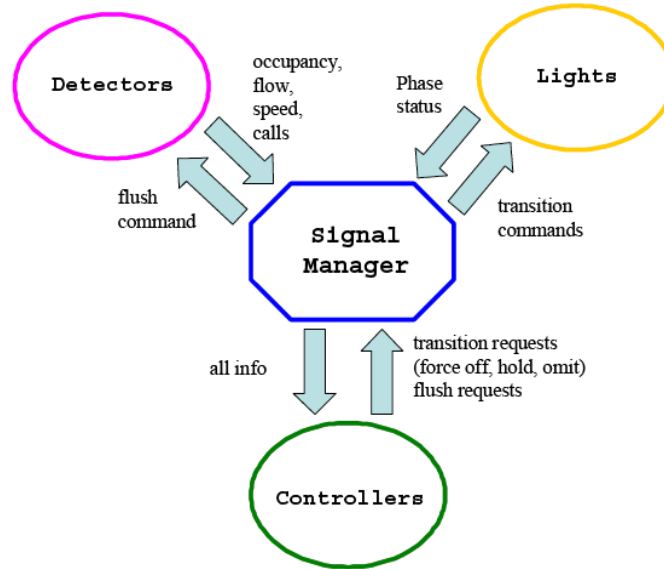

Figure 6.11 Plugin Architecture

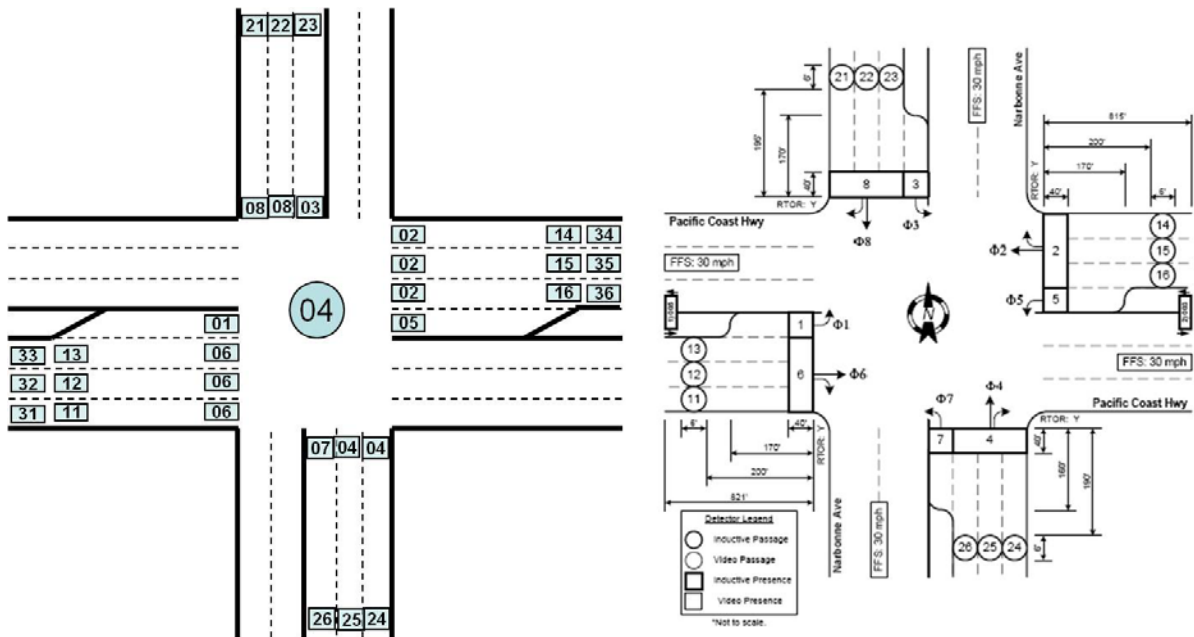

Figure 6.12 Detector Placement for RHODES Control Strategy—Narbonne Intersection

CHAPTER 7

SIMULATION OF THE SELECTED STRATEGIES

7.1 Existing Conditions

The selected test arterial (a portion of PCH in the city of Lomita) includes 7 signalized intersections. At the time of the data collection, the signals were operating as coordinated most of the day and as isolated fully actuated (“free”). Table 7.1 shows the timing plans in operation. Plan 9 with the longest cycle length is implemented during the am and pm peak periods. Information on the timing plan and controller settings were provided to the research team and verified in the field at the time of collecting the detector data with CTNET.

Table 7.1 Lomita Test Site: Time-of-Day Plans

Time	Plan ID	CYCLE LENGTH (sec)
0:00	0	Isolated Actuated (Free)
6:00	1	75 sec
7:00	9	110 sec
9:30	8	105 sec
15:00	9	110 sec
19:00	1	75 sec
21:00	0	Isolated Actuated (Free)

7.2 Simulation Experiments

The PARAMICS model with traffic demands determined from the O-D routine and the plug-in was used to simulate twelve control options on the test arterial. Each control strategy was simulated for the entire 24 hours and three demand levels: existing, 5% higher and 10% higher. Each experiment was 4 random seeds for a total of 144 model runs.

The control strategies tested are listed below:

1. Pretimed plan "1" all day
2. Pretimed plan "8" all day
3. Pretimed plan "9" all day
4. Pretimed TOD: This is the actual schedule as shown in Table 7.1
5. Isolated actuated: fully actuated (“free”) operation all day
6. Coordinated actuated: with pretimed TOD plans
7. Traffic responsive plan selection
8. Traffic responsive plan selection with critical intersection control--CIC
9. RHODES
10. TUC over pretimed plan 1: TUC strategy adjusts on line the settings of the fixed-time plan 1
11. TUC over pretimed plan 8: same as #10 but for fixed-time plan 8
12. TUC over pretimed plan 9: same as #10 but for fixed-time plan 9

It was not possible to simulate *ACS Lite* because we never received the software source code from FHWA despite repeated requests. Also, the review of the simulation results indicates that PARAMICS does not accurately model the strategies #6 (coordinated actuated) and #8 (traffic responsive with CIC), so these results were not further analyzed.

7.3 Analysis of the Simulation Results

The average travel time for the entire network for the pretimed plans is shown in Figure 7.1 for the entire day. Strategy #4 (pretimed TOD) is clearly superior than any of the fixed-time plans operating throughout the day, especially plan 1. Plan 1 results in high delays during the peak periods because its short cycle results in oversaturated movements during the peak periods. This is particularly true for the increased demand levels; a 10% increase in the demand volumes causes an increase of 15% in travel time. Strategy #4 is also robust for changes in traffic volumes; a 10% increase in demand causes only 3.5% increase in travel time. The results also show that Plan 8 is the best single timing plan for the test arterial.

Figure 7.2 shows the average travel time for the entire network for the traffic responsive and adaptive strategies. Of the best in terms of performance TUC strategy is shown (#12 TUC with plan 9). The RHODES control strategy is the best; it outperforms Strategy #7 (Traffic responsive) and TUC by 16% and 29% in travel time respectively. It can be seen in Figure 7.2 that TUC does not perform well in the pm peak period especially under conditions of increased traffic demand. Also, the traffic responsive plan selection does not work well in the midday and off-peak traffic conditions.

Figure 7.3 compares Strategies #4 and #7 in terms of average travel speeds in the network. It is shown again that Strategy #7 performs poorly in the off-peak evening hours. Figure 7.4 shows the average speeds under the RHODES and TUC adaptive strategies. The speeds are on the average 24% higher than TUC and remain within 5 mph throughout most of the day (6 am to 7 pm). Average speeds under TUC in contract vary widely from 10 to 24 mph for the same time interval.

The number of stops on the arterial for both eastbound and westbound direction are shown in Figure 7.5. RHODES is slightly better than the pretimed strategies #2 (plan 8) and #3 (plan 9). Both strategies #2 and #3 employ a long cycle length which favors the through traffic on the arterial.

Overall, the simulation results show that the RHODES adaptive signal control strategy is the best in terms of both the overall system and arterial only traffic performance for all the demand levels tested at the selected site. The pretimed strategies #2, #3 and #4 had similar performance in terms of network delay.

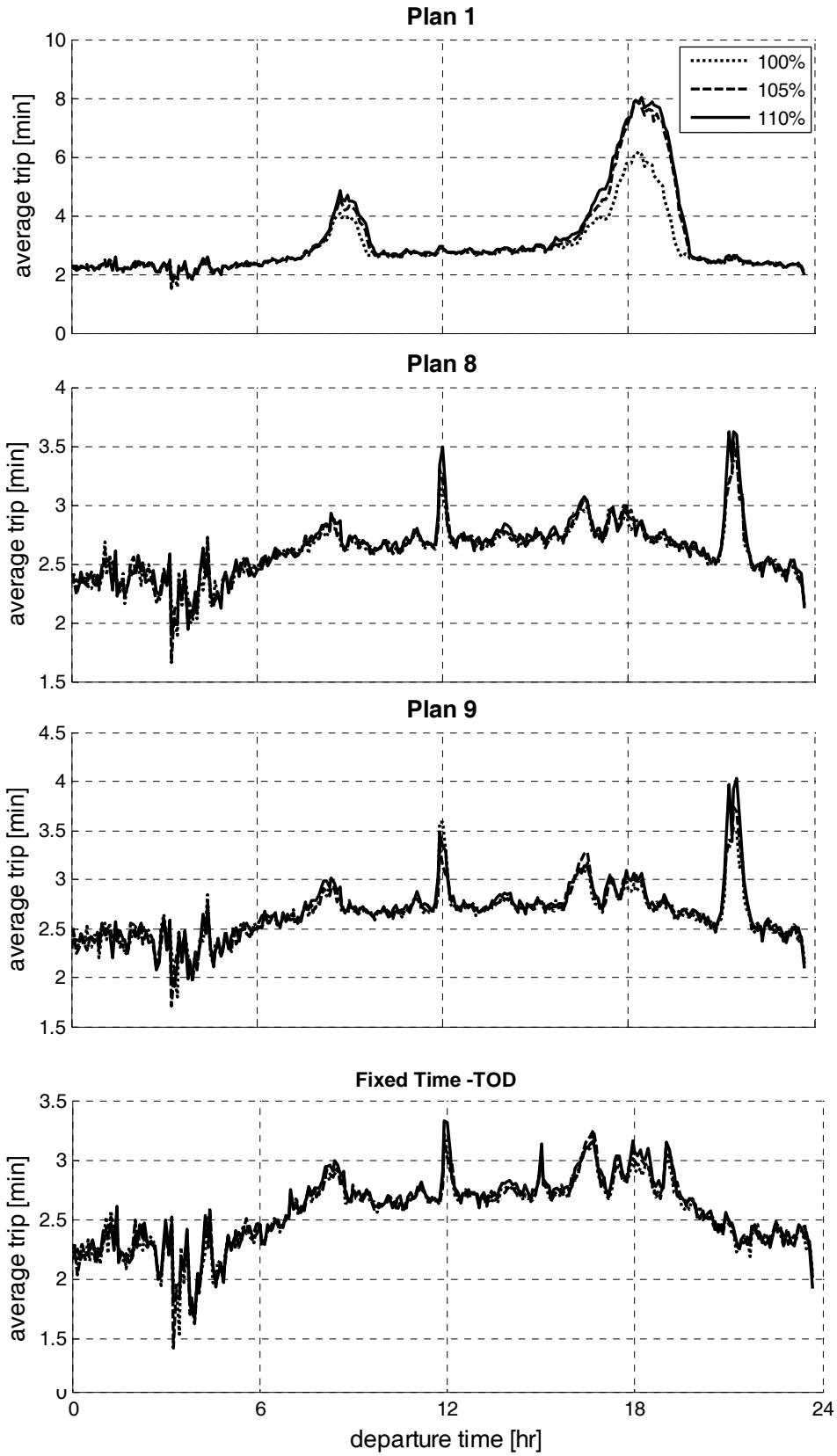

Figure 7.1 Average Travel Times-Fixed Time Plans

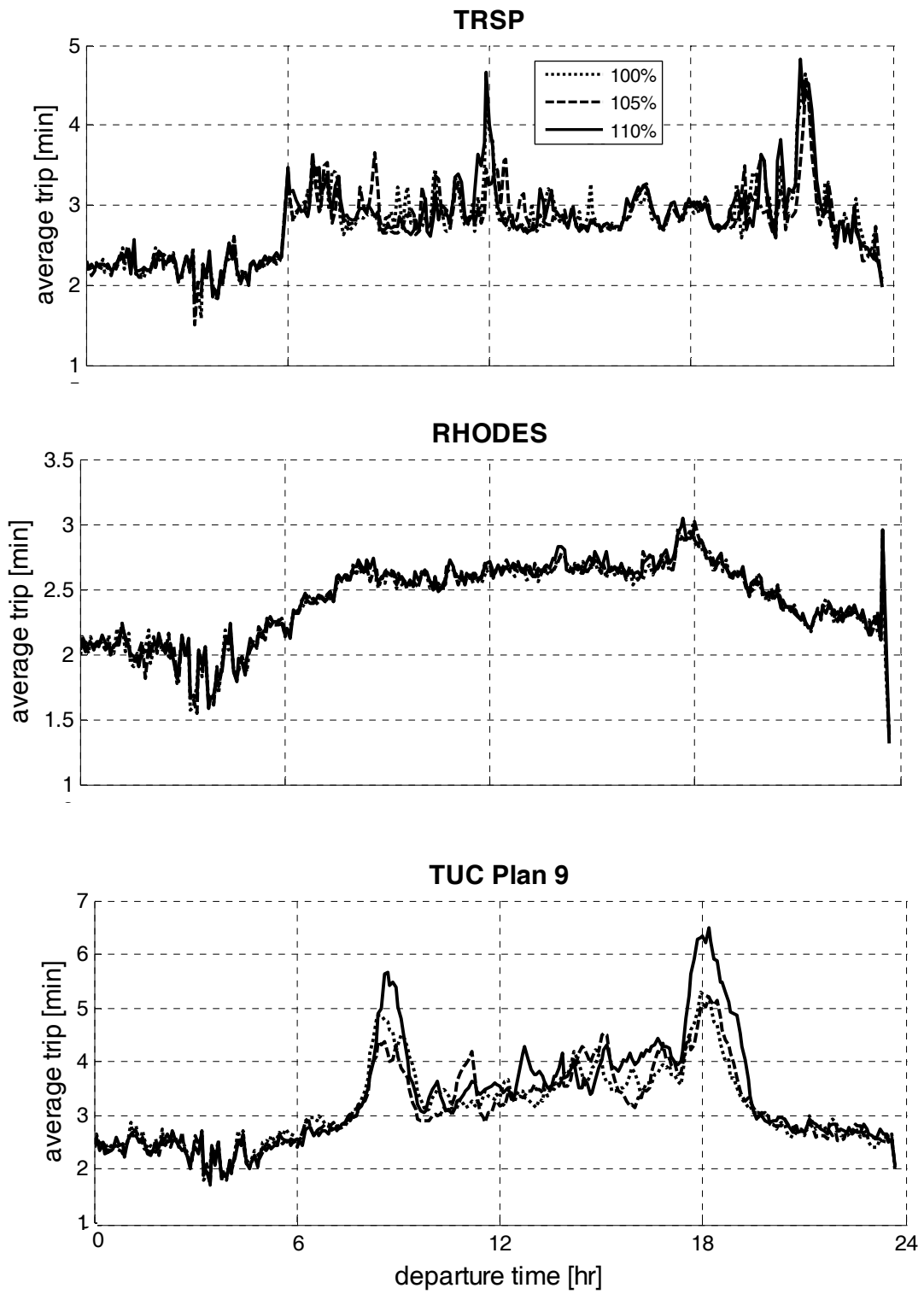

Figure 7.2 Average Travel Times-Traffic Responsive Plans

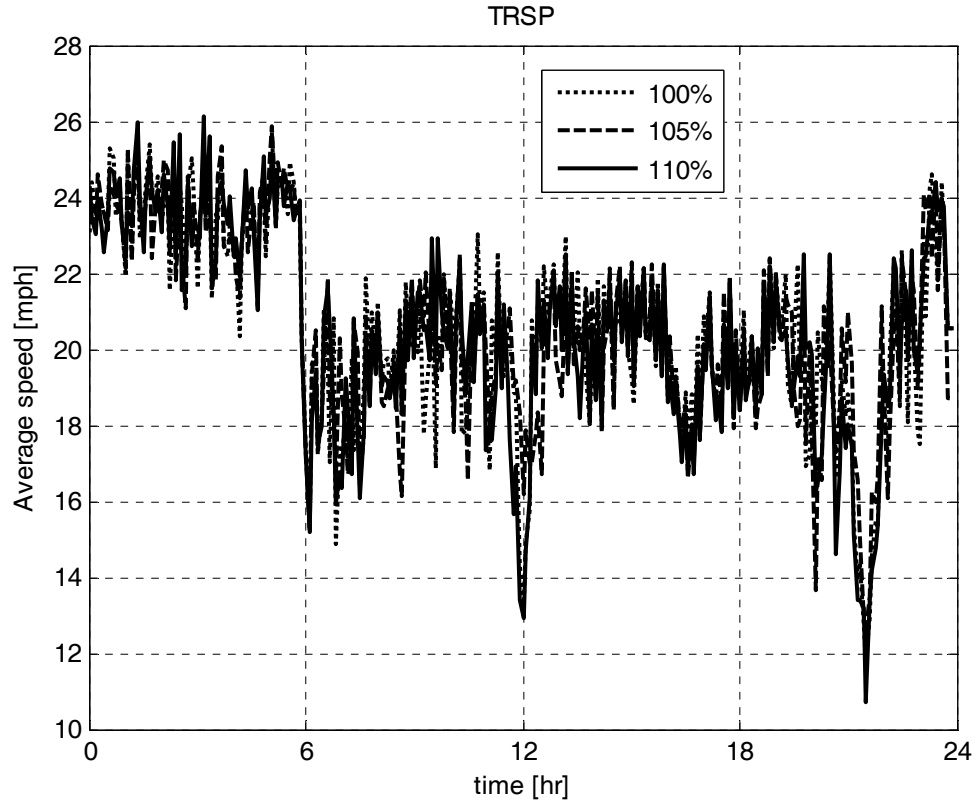
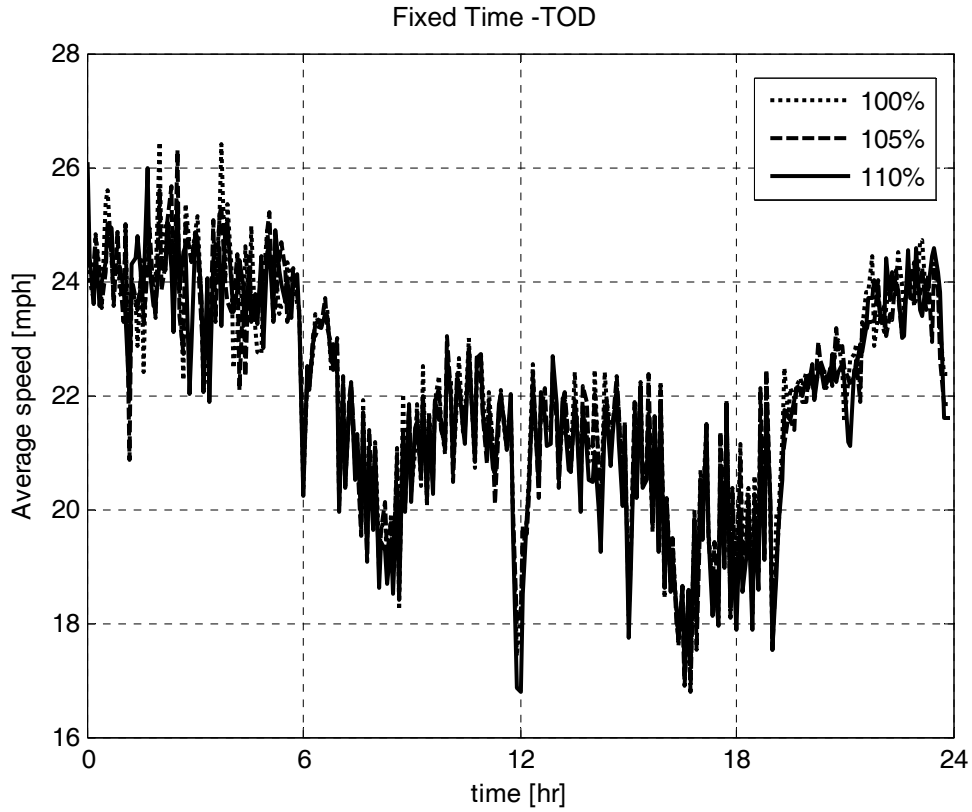

Figure 7.3 Average Network Speed: Fixed Time TOD and Traffic Responsive Plans

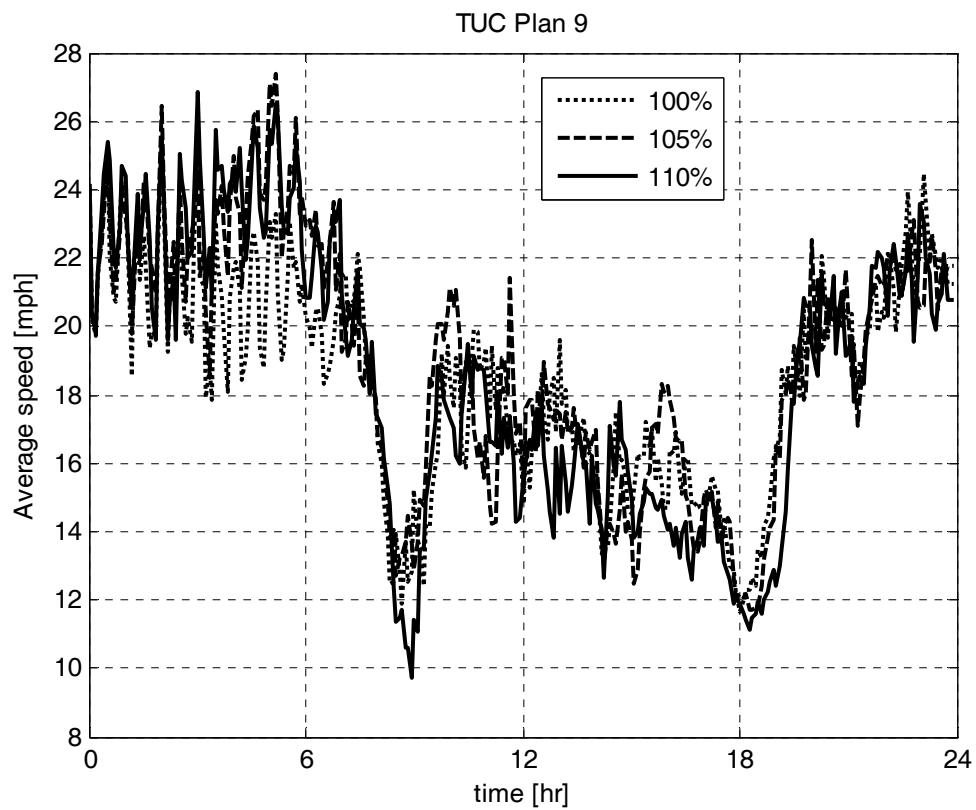
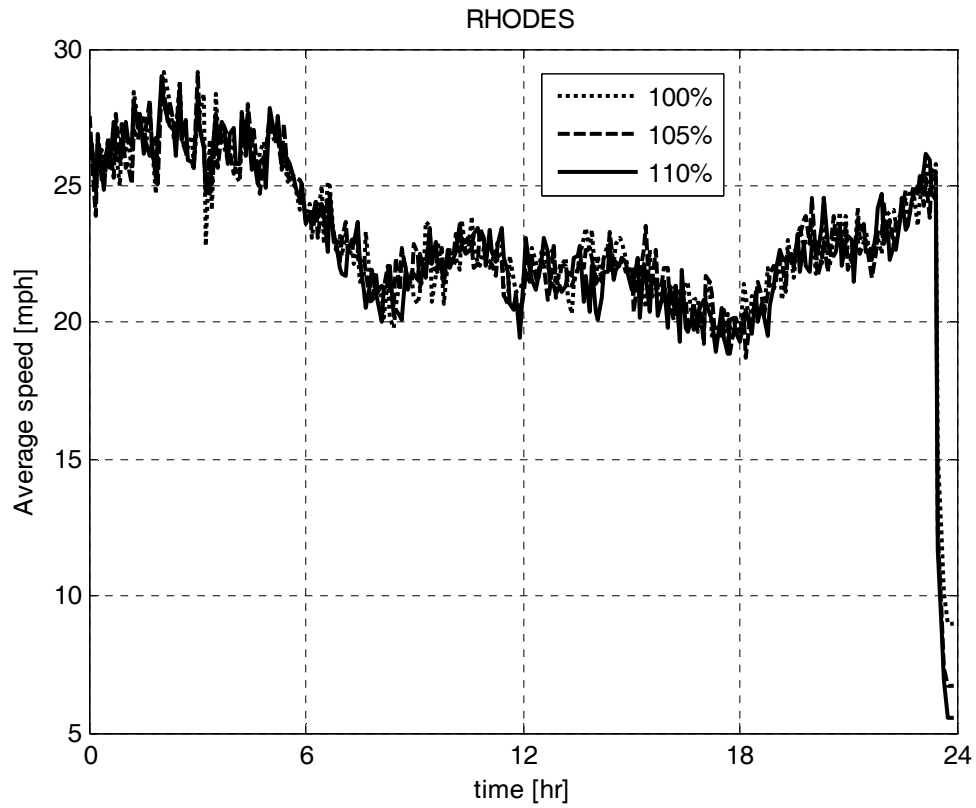

Figure 7.4 Average Network Speed: RHODES and TUC (Plan 9) Strategies

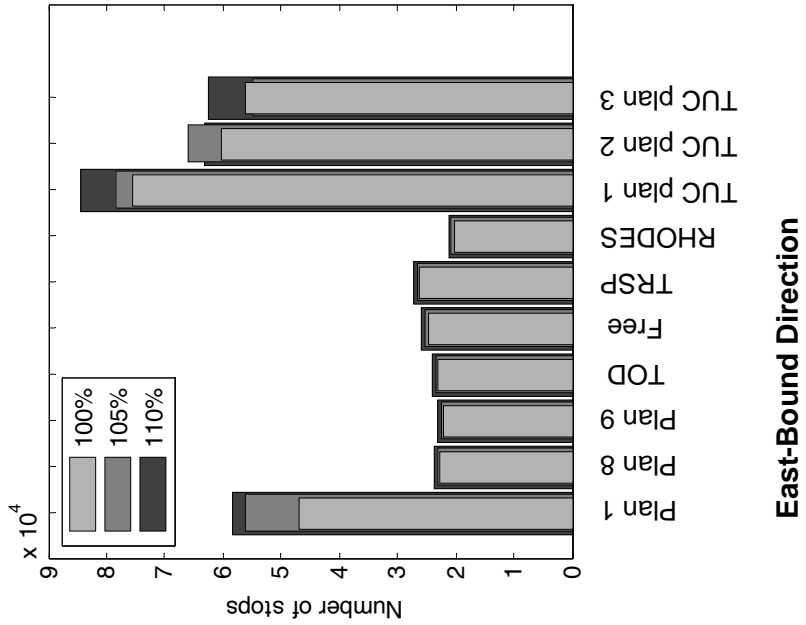
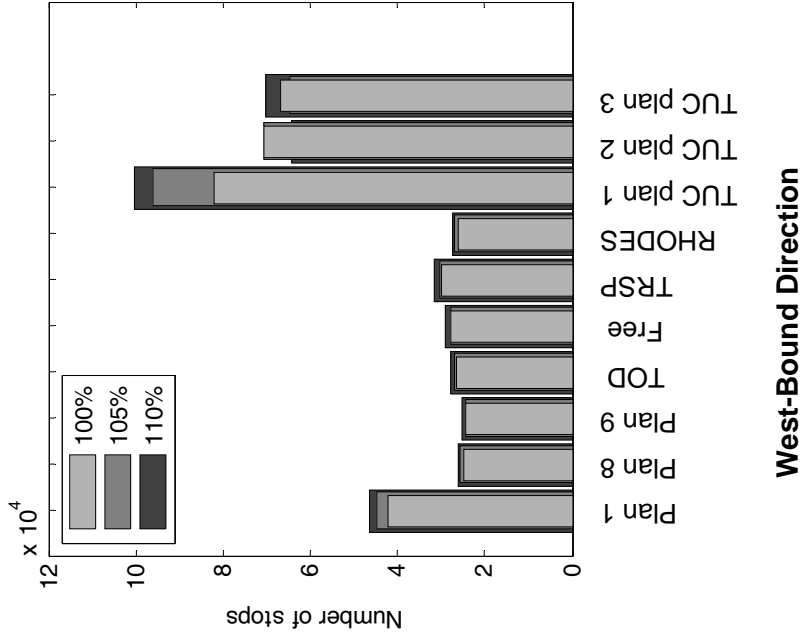

Figure 7.5 Number of Stops on Arterial

CHAPTER 8

CONCLUSIONS

8.1 Summary of the Study Findings

The objectives of the study described in this report are a) identify and select the most promising of existing adaptive control algorithms for arterial streets, b) evaluate the performance of the selected algorithms through simulation, c) and develop a plan for field testing of the most promising algorithm(s) on a real-world arterial. Recommendations for deployment of adaptive control will then be developed based on the analysis of the simulation and field results. The major study findings are:

- A test site was chosen for evaluation of adaptive signal control strategies. The selected test site is a section of the Pacific Coast Highway running through the city of Lomita, managed by Caltrans District 7. It includes seven signalized intersections. Over seventy days of loop detector data were collected for this site using the CTNet software. Additional data on geometrics and signal settings were collected from Caltrans staff and field visits to the site.
- A methodology was devised for synthesizing a time-varying OD matrix from the loop detector data. The calibrated OD matrix was input to the PARAMICS model to simulate existing operating conditions at the test site.
- A signal control plug-in was written to model control strategies with PARAMICS. It simulates non-adaptive strategies such as pretimed, isolated actuated, coordinated actuated, traffic responsive, and critical intersection control, as well as adaptive strategies such as RHODES and TUC. The plug-in is not limited to the Lomita site, it can be applied to any PARAMICS network.
- A total of twelve control strategies were tested through PARAMICS simulation. The control strategies tested included the RHODES and TUC adaptive strategies, plus traffic responsive plan selection, isolated and coordinated actuated control, and the fixed-time plans operating at the site. Additional model runs were also performed by testing the impacts of 5% and 10% uniform increases in traffic demands. The simulation results show that the RHODES adaptive signal control strategy is the best in terms of both the overall system and arterial only traffic performance.

8.2 Future Research: Field Testing of Adaptive Signal Control

We propose to perform a field test of the most promising strategy on the Lomita Avenue test site starting in the Fall of 2010, subject to the approval of the research proposal.

The objective of this follow-up study is to conduct a field test of an adaptive signal control strategy and to create a set of guidelines for future deployment of adaptive controllers. The adaptive control strategy to be tested will be selected based on the simulation results conducted in this study. The end product of the proposed research will be:

1. An adaptive control algorithm for arterial streets.
2. Documentation of the field test.
3. A deployment plan for adaptive control.

The proposed research will provide the California Department of Transportation (Caltrans) with the control strategies, guidelines and tools for implementation and evaluation of adaptive signal control on arterial highways. Effective arterial control addresses the Department's productivity goal and it is an important step in developing a systematic integrated control of freeways and arterials for corridor management. The proposed research will be performed in six tasks that are described below:

Task 0. Update Simulations: First we plan to update the simulation results based on any new information regarding operating conditions at the selected test site. Examples include updates of input traffic volumes and turning movements. Also, updated simulations of selected strategies (e.g., traffic responsive plan selection with critical intersection control) will be performed to investigate if better results can be obtained.

Task 1. Develop and Document Improved Strategy: The selected strategy for field tests will be the outcome of the simulation tests of Task 0. At the project kick-off meeting with Caltrans staff will present the proposed algorithm and establish plans, procedures and responsibilities for the field implementation and evaluation. The selected strategy will be refined and tested through simulation as appropriate to account for any changes recommended as part of the discussions with Caltrans staff. We will prepare a technical memorandum describing the selected adaptive control algorithm for field implementation.

Task 2. Development of a Field Implementation Plan: A test plan for field implementation will be prepared in consultation with Caltrans staff. The test plan will specify the hardware and software requirements and level of effort required for field implementation of the selected adaptive control algorithm. The test plan will also specify the duration of the field experiment "before" and "after" the implementation of the adaptive control algorithm, and the method of data collection.

Also, we will determine the appropriate measures of performance (MOEs) by which the algorithm will be evaluated. It is proposed that the initial list of MOEs includes: arterial through traffic travel time, arterial link travel times, arterial link, cross-street and intersection delays, number of stops on the arterial links, and queue lengths on the arterial and cross-streets. System measures may include VMT (veh-miles traveled), VHT (veh-hrs traveled) and throughput, and cycle failures. Travel time reliability measures may include distribution of travel times, and the 90th percentile travel time under the different control scenarios. Energy and environmental measures may include excess fuel consumption, and air pollutant emissions (CO, HC and NO_x). These measures are usually derived from the primary performance measures of travel times, delays and stops.

Various data collection hardware will be considered in the design of a test plan. These include loop detectors, video-recordings, MeMS point detectors, and floating cars equipped with GPS locators. We will also attempt to record the phase information from the traffic signals, either through CTNet or by through the additional hardware/software required by the controller.

Task 3. Field Implementation and Testing: We will implement the proposed algorithm at the Lomita PCH site in cooperation with Caltrans staff. Field data on MOEs will be collected "before" and "after" the field implementation to evaluate the performance of the proposed algorithm, in accordance with the test plan developed in Task 2. We will carefully monitor the traffic and other operating conditions throughout the field experiment to ensure that the measurements are not masked by external factors. We expect to collect a minimum of one week of "before" and one week of "after" data.

Task 4. Analysis of the Field Evaluation Results: In this Task, we will analyze the field measurements to determine the impacts of the implemented control algorithm based on the changes in the MOEs. Statistical analyses will be performed to determine if any improvements in the MOEs (i.e. travel times, stops, and delays) are statistically significant. We will prepare a working paper describing the field data collected and the analysis of the results.

Task 5. Documentation and Dissemination: Following the field testing and the analysis, we will update the documentation and software for the selected algorithm as appropriate to reflect any changes that occurred as part of the field test.

Task 6. Potential Statewide Deployment Analysis: We will develop guidelines for deployment of adaptive control based on the findings from the field operational test. The issues to be addressed in the deployment plan include the system performance, costs (installation, operations and maintenance), system reliability, and integration with other traffic management systems. We also provide an assessment on how well the proposed adaptive system adapts to changing traffic conditions, how well they, if not stand-alone system, coexist with standard time-of-day signal control systems, and how effective they are in both arterial control and integrated corridor control. A final report will be prepared describing in detail the work performed and presenting the results. A workshop will be conducted to present the project findings and discuss future research and the feasibility of statewide deployment on corridor management based on the findings.

REFERENCES

1. Bell M. The estimation of origin-destination matrices by constrained generalized least squares. *Transportation Research Part B.*, 25(1), 1991.
2. California Department of Transportation (Caltrans), CTnet User Manual. Technical Report 1.43,
3. Cascetta E. Estimation of trip matrices from traffic counts and survey data: A generalized least squares estimator. *Transportation Research Part B.*, 18(4/5), 1984.
4. Chen C., Kwon J., Skabardonis A., and Varaiya P. Detecting errors and imputing missing data for single loop surveillance systems. *Transportation Research Record*, 1855, 2003.
5. Chu, L., H., Liu, M. McNally and W. Recker, "Development of the capability –enhanced PARAMICS simulation environment," *California PATH Research Report, UCB-ITS-PRR-2005-12*, April 2005.
6. Cremer M. and Keller H. Dynamic identification of flows from traffic counts at complex intersections. 8th *International Symposium on Transportation and Traffic Theory*. 1981.
7. Dixon M. and L. Rilett. Population origin-destination estimation using automatic vehicle identification and volume data. *Journal of Transportation Engineering*, 131(2), 2005.
8. Dowling, R., and A. Skabardonis, "Guidelines for Calibration of Traffic Simulation Models: Framework and Applications," *Transportation Research Record # 1876*, 2004.
9. Federal Highway Administration. *Traffic control systems handbook*. February 1996.
10. Federal Highway Administration, CORSIM Version 6.0 Users Manual, prepared by ITT Systems, US Department of Transportation, Washington DC, 2006.
11. Henry R.D., R.A. Ferlis, and J.L. Kay. Evaluation of UTCS control strategies. Technical Report FHWA-RD-76-150, JHK & Associates / Peat, Marwick, Mitchell & Co., August 1976.
12. <http://www.autoitscript.com/autoit3>
13. Kwon J. and Varaiya P. Real-time estimation of origin-destination matrices with partial trajectories from electronic toll collection tag data. *Transportation Research Record*.No.1923, 2005.
14. Li B. and De Moor B. Recursive estimation based on the equality-constrained optimization for intersection origin-destination matrices. *Transportation Research Part B.*, 33: 203-214,1999.
15. Li B. and De Moor B. Dynamic identification of origin-destination matrices in the presence of incomplete observations. *Transportation Research Part B.*,36: 37-57, 2002.
16. Lo H.P., Zhang N., and Lam W.H.K. Estimation of an origin-destination matrix with random link choice proportions: A statistical approach. *Transportation Research Part B.*, 30(4), 1996.
17. Maher M.J. Inferences on trip matrices from observations on link volumes: A Bayesian statistical approach. *Transportation Research Part B.*, 20:435-447,1983.
18. Nihan N. and Davis G. Recursive estimation of origin-destination matrices from input/output counts. *Transportation Research Part B.*, 21(2),1987.
19. Quadstone Ltd, "PARAMICS microscopic traffic simulation software. <http://Paramics-online.com>.

20. Shelby, et al, "Overview and Performance Evaluation of ACS Lite: Low-Cost Adaptive Signal Control System," paper 08-0334, presented at the 87th Annual Meeting of the Transportation Research Board, Washington DC, January 2008.
21. Sherali H. A linear programming approach for synthesizing origin-destination trip tables from link traffic volumes. *Transportation Research Part B.*, 28(3),1994.
22. Skabardonis A., "Evaluation of the Fuel Efficient Traffic Signal Management (FETSIM) Program: 1983-1993," Research Report UCB-ITS-RR-94-11, University of California, Berkeley, 1994.
23. Skabardonis A., "Benefits of Advanced Traffic Signal Systems," in *Measuring the Performance of ITS in Transportation Services*, David Gillen Editor, Kluwer Academic Publishers, 2003.
24. Skabardonis, A., "Assessing The Benefits Of Signal Hardware Improvements," Transportation Research Record No. 1554, 1996
25. Skabardonis, B. Gallagher, and K. Patel. Determining the capacity benefits of real-time signal control at an intersection. *California PATH Working Paper UCB-ITS-PWP-2000-25*, 2000.
26. Spiess H. A maximum likelihood model for estimating origin-destination matrices. *Transportation Research Part B.*, 21(5),1987.
27. UTCS-functional description-enhanced first generation software. Technical Report FHWA-TS-79-228, Honeywell, Inc., August 1979.
28. Wu J. A real-time origin-destination matrix updating algorithm for on-line applications. *Transportation Research Part B.*, 31(5), 1997.
29. Van Zuylen H. and Willumsen L. The most likely trip matrix estimated from traffic counts. *Transportation Research Part B.*, 14,1980.
30. Yang H. Heuristic algorithms for the bilevel origin destination matrix estimation problem. *Transportation Research Part B.*, 29(4),1995.
31. Zhou X. and Mahmassani H. Dynamic origin-destination demand estimation using automatic vehicle identification data. *IEEE Transactions on Intelligent Transportation Systems*, 7(1),2006.

BIBLIOGRAPHY

1. Bell, M.C., and R. D. Bretherton. 1986. Ageing of fixed-time traffic signal plans. Paper presented at the IEE 2nd International Conference on Road Traffic Control.
2. Martin, P.T., and L. M. Hockaday. 1995. SCOOT - an update. ITE Journal 65. p.44-48.
3. Hunt, P.B., D. I. Robertson, R. D. Bretherton, and R. I. Winton. 1981. SCOOT - a traffic responsive method of coordinating signals. Laboratory Report 1014. Transport and Road Research Lab, Crowthorne, Berkshire, U.K.
4. Hansen, B.G., P. T. Martin, and H. J. Perrin. 2000. SCOOT real-time adaptive control in a CORSIM simulation environment. Transportation Research Record 1727. National Research Council, Washington, D.C. p.27-31.
5. Lowrie, P.R. 1982. SCATS: The Sydney Co-ordinated Adaptive Traffic System. Paper presented at the IEE International conference on road traffic signaling at London, U.K.
6. Hu, K. 2000. LADOT's adaptive traffic control system. Workshop on Adaptive Signal Control Systems, 79th Annual Meeting, Transportation Research Board, Washington D. C..
7. Khoudour, L., J.B. Lesort, and J.L. Farges. 1991. PRODYN - Three years of trials in the ZELT Experimental Zone. Recherche - Transports - Securite, English Issue, no. 6. Special Traffic Management. p.89-98.
8. Mauro, V., and D. Di Taranto. 1990. UTOPIA. Paper presented at the 6th IFAC/IFIP/IFORS Symposium on Control and Communication in Transportation at Paris, France.
9. Head, K.L., P. B. Mirchandani, and D. Shepherd. 1992. A hierarchical framework for real-time traffic control. Transportation Research Record 1360. p.82-88.
10. Boillot, F., J. M. Blossville, J. B. Lesory, V. Motyka, M. Papageorgiou, and S. Sellam. 1992. Optimal signal control of urban traffic networks. Paper presented at the IEE Conference on Road Traffic Monitoring and Control at Stevenage, England. p.75-79.
11. Robertson, D.I. 1969. TRANSYT: A traffic network study tool. Laboratory Report 1014. Transport and Road Research Lab, Crowthorne, Berkshire, U.K.
12. Mazzamatti, M.V., D.V.V.F. Netto, L.M. Vilanova and S.H. Ming. 1998. Benefits gained by responsive and adaptive systems in São Paulo. Paper presented at the IEE Road Transport Information and Control, Conference Publication No. 454.
13. Taale, H., W. C. M. Francis and J. Dibbits. 1998. The second assessment of the SCOOT system in Nijmegen. Paper presented at the IEE Road Transport Information and Control, Conference Publication No. 454.
14. Quan, B.Y., J.C. Greenough, and W.L. Kelman. 1993. The Metropolitan Toronto SCOOT demonstration project. 72nd TRB Annual Meeting, Washington, D.C.
15. Peck, C., P.T.W. Gorton, D. Liren. 1990. The application of SCOOT in developing countries. 3rd International IEE Conference on Road Traffic Control, London, p.104-109.
16. Department of Transport, Hereford and Worcester County Council, and Transportation Planning Associates. 1986. Evaluation of Urban Traffic Control in Worcester. Available from TCC division D Tp, Tollgate House, Bristol. May.
17. Chandler, M.J.H., and D.J. Cook. 1985. Traffic control studies in London: SCOOT and bus detection, PTRC Annual Summer Meeting at Seminar M, P269. p.111-128.

18. Powell, R.J. 1985. SCOOT in Southampton. Paper presented at the PTRC Annual Summer Meeting at Seminar M, P269. p.97-110.
19. Coeymans-avaria, J.E., et. al. 1995. SCOOT in Santiago. Paper presented at the 23rd European Transport Forum. PTRC September 1995. P394. p.183-195.
20. Gartner, N.H. 1983. OPAC: A demand responsive strategy for traffic signal control. Transportation Research Record 906. National Research Council, Washington, D.C.
21. Head, K.L. 1995. An event-based short-term traffic flow prediction model. Transportation Research Record 1510. National Research Council, Washington, D.C. p.45-52.
22. Sen, S., and K. L. Head. 1997. Controlled Optimization of Phases at an Intersection. Transportation Science 31. p.5-17.
23. Dell'Olmo, P., and P. B. Mirchandani. 1996. A model for real-time traffic co-ordination using simulation based optimization. Advanced Methods in Transportation Analysis. (ed. L. Bianco and P. Toth) Springer-Verlag, Germany. p.525-546.
24. Dell'Olmo, P., and P. B. Mirchandani. 1995. REALBAND: An approach for real-time co-ordination of traffic flows on networks. Transportation Research Record 1494.
25. Mirchandani, P.B., K. L. Head, A. Knyazyan, and W. Wu. 2000. An approach towards the integration of bus priority, traffic adaptive signal control and bus information/scheduling system. 8th International Conference on Computer-Aided Scheduling of Public Transportation at Berlin, Germany.
26. Dr. William C. Taylor and Sorawit Narupiti, Incident Management FAST-TRAC Phase IIB Deliverables #20. The Model Analysis Report on the Benefits of SCATS in Alleviating the Impacts of Incidents EECS-ITSLAB-FT96- 112, 1995.
27. William C. Taylor and Ahmed S. Abdel-Rahim, *Incident Management Under SCAT Adaptive Control System FAST-TRAC Phase III Deliverable #11*. Final Report On Incident Management Under SCATS Adaptive Control System EECS-ITS LAB-FT98-084, 1998.
28. Hunt P.B. and Holland, T.R., *The effect of an incident in a SCOOT system - In simulation and on street*. Traffic Engineering and Control., February 1985. Volume 26. (No.2.).
29. Homes G. N. and D.R. Leonard, *A Study to identify the frequency and importance of incidents in causing congestion*. Proc. 20th PTRC Summer annual meeting: Traffic Management and Operations, September 1992: p. 153-156.
30. P.B. Hunt, D.I.R. and R.D. Bretherton., *The SCOOT on-line traffic signal optimization technique*. Traffic Engineering and Control, April 1982: p. 190-192.
31. Bretherton, R.D., and G.T. Bowen. 1990. Recent enhancements to SCOOT - SCOOT version 2.4. Paper presented at the 3rd IEE International Conference on Road Traffic Control.
32. Bretherton, R.D., and G.T. Bowen. 1998. SCOOT Version 4. Paper presented at the IEE Conference on Road Transport Information and Control at London.
33. Bretherton, R.D. Current developments in SCOOT: Version 3. Transportation Research Record 1554. National Research Council, Washington, D.C.
34. Bowen, G.T., and R.D. Bretherton. 1996. Latest developments in SCOOT - Version 3.1, 8th IEE International Conference on Road Traffic Monitoring and Control.
35. Hansen, B.G., and P. T. Martin. 1999. Online Testing of SCOOT using CORSIM: Development of a CORSIM Run-Time Extension. Working Paper, University of Utah.

36. Hounsell, N., Intelligent Bus Priority in London: Evaluation and Exploitation in INCOME, the 6th World Congress Conference, Turin, Italy, November 1999.
37. Siemens Traffic Controls Ltd., Peek Traffic Ltd. and TRL Ltd. Bus Priority in SCOOT, 2001, <http://www.scoot-utc.com/SCOOTFacilities/busprior.htm>, accessed June 12, 2002.
38. Robertson D.I., Research on the TRANSYT and SCOOT Methods of Signal Coordination. ITE Journal, Vol. 56, No. 1 1986, pp. 36 - 40.
39. Mirchandani P., Head L., Knyazyan A. and Wu W., An Approach Towards The Integration of Bus Priority, Traffic Adaptive Signal Control, and Bus Information/Scheduling System. the 8th International conference, computer-aided scheduling of public transport, Berlin, Germany, June 2000.
40. Head, K.L., Mirchandani P.B. and Shelby S., The RHODES Prototype: A Description and Some Results. Paper presented at the 77th Transportation Research Board Annual Meeting (Paper No. 981399), Washington D.C., 1998.
41. Stallard C., and L.E. Owen, Evaluating Adaptive Signal Control Using CORSIM, the proceedings of the 30th conference on winter simulation, Washington D.C., December 1998.
42. Fellendorf. M., Public Transport Priority Within SCATS - a Simulation Case Study in Dublin, 67th Annual Meeting of the institute of transportation engineers, Boston 1997.

APPENDIX A.

RHODES IMPLEMENTATION IN PARAMICS SIMULATION MODEL

**David Lucas
Pitu Mirchandani
Larry Head**

University of Arizona

APPENDIX A

TS09: Measure and Field Test the Effectiveness of Adaptive Traffic Control for Arterial Signal Management Phase I

Introduction

The purpose of this project was to evaluate the implementation process and performance benefits of installing an adaptive traffic control system along an arterial corridor. The RHODES Traffic Adaptive Signal Control System, developed by researchers at the University of Arizona, was selected for evaluation. In addition to simulation modeling of the selected system, field implementation would be undertaken to provide a comprehensive set of data for use in analyzing potential statewide or regional deployment plans for adaptive traffic control systems.

The project was divided into two distinct phases. During Phase I, RHODES would be interfaced with the Paramics microsimulation model and an initial configuration of the RHODES adaptive control system along the selected adaptive corridor would be completed. An evaluation of the effectiveness of the RHODES adaptive control along the corridor would be the focus of Phase II of the project.

Lomita Adaptive Corridor

The adaptive arterial corridor selected for this study is a 1.2 mile section of the Pacific Coast Highway (US1), in Lomita, California, shown in Figure 1. The corridor consists of seven signalized intersections, between Walnut Street to the east, and Airport Drive to the west. These intersections are closely spaced and the corridor has only one major crossing arterial, Narbonne Avenue, located near the corridor's midpoint. Five of the intersections have protected main street left-turn movements and use lead-lag phasing to improve progression along the corridor. Currently, the intersections are instrumented with inductive loop detectors consistent with coordinated semi-actuated control and the only interconnect is through legacy twisted-pair lines.

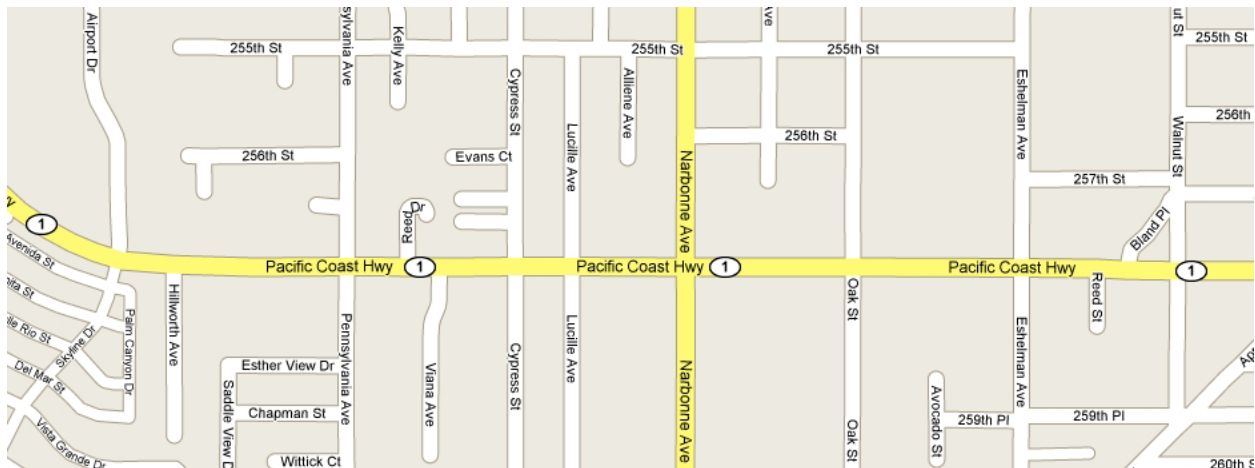

Figure 1 – Lomita Adaptive Corridor

APPENDIX A

RHODES Data Requirements

In order to configure RHODES on a corridor, a variety of data must be collected for each intersection and this data must then be converted into a format readable by RHODES. These data include static elements, such as intersection geometry, e.g., the number of lanes and whether turn pockets exist, as well as detector dimensions and placement. Variable parameters, such as signal timings and turn proportions, which may vary by time-of-day, must also be provided. A RHODES Configuration Report is then created for each intersection for documentation and review purposes, ensuring that all of the required data has been provided, translated and recorded properly. Copies of these documents for the Lomita Adaptive Corridor are included as an appendix to this report.

While a majority of the data required to configure RHODES on the Lomita corridor was available, some critical elements remained missing at the conclusion of Phase 1 of this project. These are indicated on the reports with question marks, dashed lines or default placeholder values. The missing data consist primarily of missing detector installations and turn proportions, both of which are critical to RHODES. In order to move forward and develop a working set of RHODES configuration files, default values for these parameters are currently being used until these data can be collected. These missing data will be discussed in more detail in a later section.

RHODES Simulation Interface

While reviewing the provided data to complete the initial RHODES configuration, the research team also began work on the development of a simulation model and corresponding RHODES interface. As part of previous work, the team had defined a client/server architecture governing communications between RHODES and three popular microscopic simulation models: AIMSUN, CORSIM and VISSIM. In this architecture, the RHODES algorithms for each controlled intersection would be contained within a separate RHODES Simulation Server that would be independent of the simulation model used. Separate RHODES Client components, which would be unique to each simulation model, would be responsible for exchanging data between the simulation models and RHODES, following specified formats and messaging protocols.

The Paramics microsimulation model was selected as the evaluation platform for this project. Since the RHODES Simulation Server is independent of the simulation model used, this component was already available for use. However, as no Paramics RHODES Client existed, one needed to be developed. In support of this effort, the project team provided detailed information about the specific data formats to be used, explained in detail below, along with source code to implement them. In addition, source code was provided for establishing the communications links between the Paramics RHODES Client and the RHODES Simulation Server.

Each second, the simulation client and RHODES Simulation Server exchange data over a TCP/IP network connection which may span multiple computers or be housed within a single

APPENDIX A

CPU. A set of configuration files are used to identify the locations of each component, offering flexibility in how the system is arranged. Since each simulation model is different, the makeup of the configuration file may also differ. As the Paramics RHODES client was not completed at the conclusion of Phase I of the project, the format used by the CORSIM RHODES Client is discussed here as an example.

The CORSIM Simulation Client uses a *CORSIM RHODES Client.cfg* file, which contains two sets of configuration parameters. The first is four YES/NO parameters which allow the user to display and/or log the content of the *Controller Status* and *RHODES Control* messages that are exchanged each second during the simulation run. The second set of parameters begins by specifying the number of RHODES intersections being simulated within the model. For each intersection, an entry provides the node number of the intersection, the two digit detector prefix (used to associate detectors with an intersection) and the networking information, consisting of the port number and IP address, of the RHODES Simulation Server responsible for operating that intersection. In the example shown in Figure 2, all components are housed locally on the same computer, but this is not a requirement.

```
DISPLAY_CONTROLLER_STATUS_MESSAGES      NO
LOG_CONTROLLER_STATUS_MESSAGES          NO
DISPLAY_RHODES_CONTROL_MESSAGES         NO
LOG_RHODES_CONTROL_MESSAGES             NO
7
001   01   12001  127.0.0.1
002   02   12002  127.0.0.1
003   03   12003  127.0.0.1
004   04   12004  127.0.0.1
005   05   12005  127.0.0.1
006   06   12006  127.0.0.1
007   07   12007  127.0.0.1
```

Figure 2 – *CORSIM RHODES Client.cfg* File Format

Each RHODES Simulation Server similarly requires a configuration file, *RHODES.ini*, which identifies the location of the main RHODES (Simulation) Input File containing all of the network and model parameters needed by RHODES. In addition, the same four YES/NO parameters are available to display and/or log the messages exchanged with the simulation client, as shown in Figure 3.

```
//-----
//  Filename:  RHODES.ini
//  Location:  PCH & Walnut Street, Lomita, California
//-----
SIMULATION_INPUT_FILE           ".\001 - PCH & Walnut Street\RHODES\001.rif"
DISPLAY_CONTROLLER_STATUS_MESSAGES  YES
LOG_CONTROLLER_STATUS_MESSAGES     YES
DISPLAY_RHODES_CONTROL_MESSAGES    YES
LOG RHODES CONTROL MESSAGES        YES
```

Figure 3 – *RHODES Simulation Server.cfg* File Format

With the simulation client and server configurations complete, the two components will now be able to exchange data and run the simulation model. While the details of the RHODES Input File referenced above will not be covered in this report, full documentation of its contents and

APPENDIX A

format is available in the *RHODES User's Guide*. Note that this input file is the same whether RHODES is configured for simulation or field implementation, so no duplication of effort is required when completing the RHODES configuration process for one platform or the other.

RHODES Operation

Each second, the RHODES Client and the RHODES Simulation Server communicate by exchanging packets of data. For each simulation model, there is a single simulation client which receives messages from each of the RHODES Simulation Servers, one for each controlled intersection. With multiple messages arriving each second, it is important that the simulation client be able to associate the messages with the correct intersection. Using the information included within the packet header and the simulation client configuration file, this can be easily done. Obviously, it is also important that the information exchanged be in the proper format so that it can be decoded properly. This information is encoded within two messages: *Controller Status* and *RHODES Control*.

RHODES relies upon data from its environment to guide its decision making. Specifically, RHODES relies on detector data to determine where queues exist and to identify future arrivals in order to create arrival vectors of current and future demand. RHODES also needs to know the existing signal status to maintain consistency between its internal traffic model and the actual intersection signal operation. Finally, a control parameter is used to change between different modes of operation. These data are contained within an 11-byte *Controller Status* message (refer to Figure 4) that is sent out each second from the simulation client to each RHODES simulation server.

The desired mode of operation may be either *Offline*, *Standby* or *Online*. RHODES begins operating in *Standby* mode, transitions to *Online* mode after receiving a command to do so and continues until receiving an *Offline* mode request, at which time the RHODES Simulation Server exits. The current signal operation supports eight phases, with the current signal status indicated by setting the appropriate green or yellow phases as on (1) or off (0). A red signal is indicated by setting both the green and yellow values for a phase to zero. RHODES supports a set of 64 detectors, which may be any combination of passage/advance and presence/stopbar detectors. A call on a particular detector is indicated by setting the appropriate bit to 1.

While in *Standby* mode, RHODES receives *Controller Status* messages every second and uses their data to update its internal model of the traffic network. Once RHODES is requested to switch to *Online* mode, it will perform the additional optimization step to determine the phase settings which should be implemented at the intersection to minimize delay. This information is contained within a 4-byte *RHODES Control* message (see Figure 5) which is sent by RHODES every second while operating in *Online* mode.

APPENDIX A

		Bits*									
		1	2	3	4	5	6	7	8		
Bytes	0	Desired Mode 00 = OFFLINE 01 = STANDBY 10 = ONLINE		UNUSED							
	1	Φ 1 Green 0 = OFF 1 = ON	Φ 2 Green 0 = OFF 1 = ON	Φ 3 Green 0 = OFF 1 = ON	Φ 4 Green 0 = OFF 1 = ON	Φ 5 Green 0 = OFF 1 = ON	Φ 6 Green 0 = OFF 1 = ON	Φ 7 Green 0 = OFF 1 = ON	Φ 8 Green 0 = OFF 1 = ON		
	2	Φ 1 Yellow 0 = OFF 1 = ON	Φ 2 Yellow 0 = OFF 1 = ON	Φ 3 Yellow 0 = OFF 1 = ON	Φ 4 Yellow 0 = OFF 1 = ON	Φ 5 Yellow 0 = OFF 1 = ON	Φ 6 Yellow 0 = OFF 1 = ON	Φ 7 Yellow 0 = OFF 1 = ON	Φ 8 Yellow 0 = OFF 1 = ON		
	3	Det 1 0 = OFF 1 = ON	Det 2 0 = OFF 1 = ON	Det 3 0 = OFF 1 = ON	Det 4 0 = OFF 1 = ON	Det 5 0 = OFF 1 = ON	Det 6 0 = OFF 1 = ON	Det 7 0 = OFF 1 = ON	Det 8 0 = OFF 1 = ON		
	4	Det 9 0 = OFF 1 = ON	Det 10 0 = OFF 1 = ON	Det 11 0 = OFF 1 = ON	Det 12 0 = OFF 1 = ON	Det 13 0 = OFF 1 = ON	Det 14 0 = OFF 1 = ON	Det 15 0 = OFF 1 = ON	Det 16 0 = OFF 1 = ON		
	5	Det 17 0 = OFF 1 = ON	Det 18 0 = OFF 1 = ON	Det 19 0 = OFF 1 = ON	Det 20 0 = OFF 1 = ON	Det 21 0 = OFF 1 = ON	Det 22 0 = OFF 1 = ON	Det 23 0 = OFF 1 = ON	Det 24 0 = OFF 1 = ON		
	6	Det 25 0 = OFF 1 = ON	Det 26 0 = OFF 1 = ON	Det 27 0 = OFF 1 = ON	Det 28 0 = OFF 1 = ON	Det 29 0 = OFF 1 = ON	Det 30 0 = OFF 1 = ON	Det 31 0 = OFF 1 = ON	Det 32 0 = OFF 1 = ON		
	7	Det 33 0 = OFF 1 = ON	Det 34 0 = OFF 1 = ON	Det 35 0 = OFF 1 = ON	Det 36 0 = OFF 1 = ON	Det 37 0 = OFF 1 = ON	Det 38 0 = OFF 1 = ON	Det 39 0 = OFF 1 = ON	Det 40 0 = OFF 1 = ON		
	8	Det 41 0 = OFF 1 = ON	Det 42 0 = OFF 1 = ON	Det 43 0 = OFF 1 = ON	Det 44 0 = OFF 1 = ON	Det 45 0 = OFF 1 = ON	Det 46 0 = OFF 1 = ON	Det 47 0 = OFF 1 = ON	Det 48 0 = OFF 1 = ON		
	9	Det 49 0 = OFF 1 = ON	Det 50 0 = OFF 1 = ON	Det 51 0 = OFF 1 = ON	Det 52 0 = OFF 1 = ON	Det 53 0 = OFF 1 = ON	Det 54 0 = OFF 1 = ON	Det 55 0 = OFF 1 = ON	Det 56 0 = OFF 1 = ON		
	10	Det 57 0 = OFF 1 = ON	Det 58 0 = OFF 1 = ON	Det 59 0 = OFF 1 = ON	Det 60 0 = OFF 1 = ON	Det 61 0 = OFF 1 = ON	Det 62 0 = OFF 1 = ON	Det 63 0 = OFF 1 = ON	Det 64 0 = OFF 1 = ON		

*Within each byte, bits are displayed from most to least significant bit when reading from left to right

Figure 4 – Controller Status Message Format

		Bits*								
		1	2	3	4	5	6	7	8	
Bytes	0	Current Mode 00 = OFFLINE 01 = STANDBY 10 = ONLINE		UNUSED						
	1	Φ 1 Hold 0 = OFF 1 = ON	Φ 2 Hold 0 = OFF 1 = ON	Φ 3 Hold 0 = OFF 1 = ON	Φ 4 Hold 0 = OFF 1 = ON	Φ 5 Hold 0 = OFF 1 = ON	Φ 6 Hold 0 = OFF 1 = ON	Φ 7 Hold 0 = OFF 1 = ON	Φ 8 Hold 0 = OFF 1 = ON	
	2	Φ 1 Force 0 = OFF 1 = ON	Φ 2 Force 0 = OFF 1 = ON	Φ 3 Force 0 = OFF 1 = ON	Φ 4 Force 0 = OFF 1 = ON	Φ 5 Force 0 = OFF 1 = ON	Φ 6 Force 0 = OFF 1 = ON	Φ 7 Force 0 = OFF 1 = ON	Φ 8 Force 0 = OFF 1 = ON	
	3	Φ 1 Omit 0 = OFF 1 = ON	Φ 2 Omit 0 = OFF 1 = ON	Φ 3 Omit 0 = OFF 1 = ON	Φ 4 Omit 0 = OFF 1 = ON	Φ 5 Omit 0 = OFF 1 = ON	Φ 6 Omit 0 = OFF 1 = ON	Φ 7 Omit 0 = OFF 1 = ON	Φ 8 Omit 0 = OFF 1 = ON	

*Within each byte, bits are displayed from most to least significant bit when reading from left to right

Figure 5 – RHODES Control Message Format

APPENDIX A

Issues

During Phase I, several issues were identified that need to be resolved during Phase II in order to complete the initial project objectives. Originally, this project was to involve the field installation of RHODES along the Lomita adaptive corridor. However, several issues were identified during the initial stages of Phase I that make field installation unlikely to occur:

- Many of the detectors required by RHODES are physically not in place. Specifically, stopbar detection is not installed on the PCH through movements, nor are passage/upstream detectors available for any of the side streets
- Four intersections (Eshelman, Narbonne, Cypress and Airport) have passage detection on only two of the three PCH lanes, leaving the rightmost lane uncovered in each case
- An interface between the ATSC 2070 software and RHODES remains to be developed, as the only 2070 software which currently supports RHODES is Siemens ITS' *NextPhase*
- A communications network interconnecting the seven intersections along the corridor is not in place and no plans currently exist for installing one or upgrading the copper infrastructure currently in use.

Notwithstanding these issues, the implementation and evaluation of RHODES along the Lomita corridor can proceed using the Paramics RHODES Client developed during Phase I. Though not currently operational, the Paramics client is nearly complete and will allow RHODES to control the Paramics model of the Lomita corridor that has been developed, once the remaining configuration data has been made available. A CORSIM model of the Lomita network has also been developed and could be used during the evaluation process to highlight operational differences between the two models. Also, as mentioned earlier, the RHODES configuration is the same for both simulation and field installations, so this effort will not need to be duplicated once field installation moves forward.

APPENDIX A

Appendix – RHODES Configuration Reports for Lomita, CA

Note that these reports are currently incomplete, reflecting the data that was made available at the end of Phase I of the project. During Phase II, missing data will be collected and used to update the model where appropriate.

RHODES™ Configuration Report

City, State: Lomita, California

Intersection ID: 001

Intersection Name: PCH & Walnut Street

2070 Software: **TBD**





RHODES Hardware: **TBD**

PREDICT Hardware: **TBD**

Initial Transition Time: 300 seconds

Maximum Peer Interval: 1) 5 sec

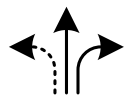
Phasing Structure and Parameters:

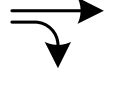
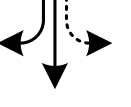
								a									b
2				1				3				4					
								Not Used									
DW				DW				DW				DW					
Min Max Amb Red				Min Max Amb Red				Min Max Amb Red				Min Max Amb Red					
10 60 3 2				4 8 3 2								5 19 3 2					
5				6				7				8					
								Not Used									
DW				DW				DW				DW					
Min Max Amb Red				Min Max Amb Red				Min Max Amb Red				Min Max Amb Red					
4 8 3 2				10 60 3 2								5 19 3 2					

APPENDIX A

Geometrics and Detector Assignments*:

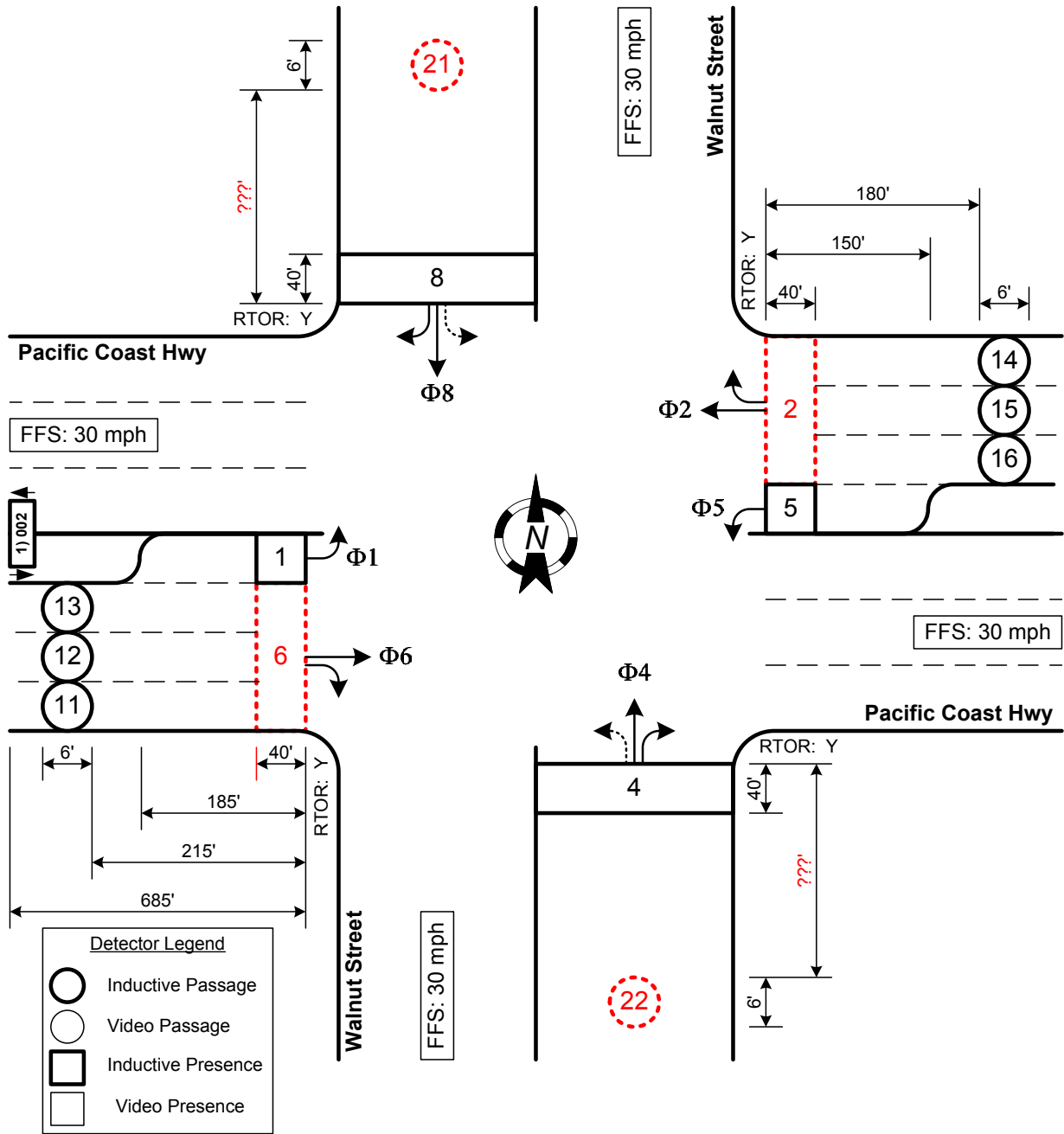

*Not to scale.

APPENDIX A

#	Conn/Pin	#	Conn/Pin	#	Conn/Pin	#	Conn/Pin	#	Conn/Pin	#	Conn/Pin

Simulated Det Volumes	Default	Plan 1	Plan 2	Plan 3	Plan 4	Plan 5	Plan 6	Plan 7	Plan 8

Detector Turn %	Default																							
	L	T	R	L	T	R	L	T	R	L	T	R	L	T	R	L	T	R	L	T	R	L	T	R
11	10	80	10																					
12	10	80	10																					
13	10	80	10																					
14	10	80	10																					
15	10	80	10																					
16	10	80	10																					
21	0	100	0																					
22	0	100	0																					

Movement Weights	1 - SB			2 - WB			3 - NB			4 - EB			Discharge Rates	1 - SB			2 - WB			3 - NB			4 - EB		
	L	T	R	L	T	R	L	T	R	L	T	R		L	T	R	L	T	R	L	T	R	L	T	R
Default	100	100	100	100	100	100	100	100	100	100	100	100	Default	25	40	16	25	120	16	25	40	16	25	120	16

Approach Turn %	1 - SB			2 - WB			3 - NB			4 - EB			Peer %	1 - WB											
	L	T	R	L	T	R	L	T	R	L	T	R		L	T	R	L	T	R	L	T	R	L	T	R
Default	0	100	0	10	80	10	10	80	10	10	80	10	Default	10	80	10									

RHODES™ Configuration Report

City, State: Lomita, California

Intersection ID: 002

Intersection Name: PCH & Eshelman Avenue

2070 Software: **TBD**





RHODES Hardware: **TBD**

PREDICT Hardware: **TBD**

Initial Transition Time: 300 seconds

Maximum Peer Interval: 1) 5 sec 2) 5 sec

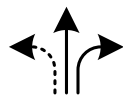
Phasing Structure and Parameters:

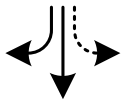
								a									b
1				2				3				4					
								Not Used									
DW				DW				DW				DW					
Min	Max	Amb	Red	Min	Max	Amb	Red	Min	Max	Amb	Red	Min	Max	Amb	Red		
6	13	3	2	10	50	3	2					5	22	3	2		
6				5				7				8					
								Not Used									
DW				DW				DW				DW					
Min	Max	Amb	Red	Min	Max	Amb	Red	Min	Max	Amb	Red	Min	Max	Amb	Red		
10	50	3	2	5	15	3	2					5	22	3	2		

APPENDIX A

Geometrics and Detector Assignments*:

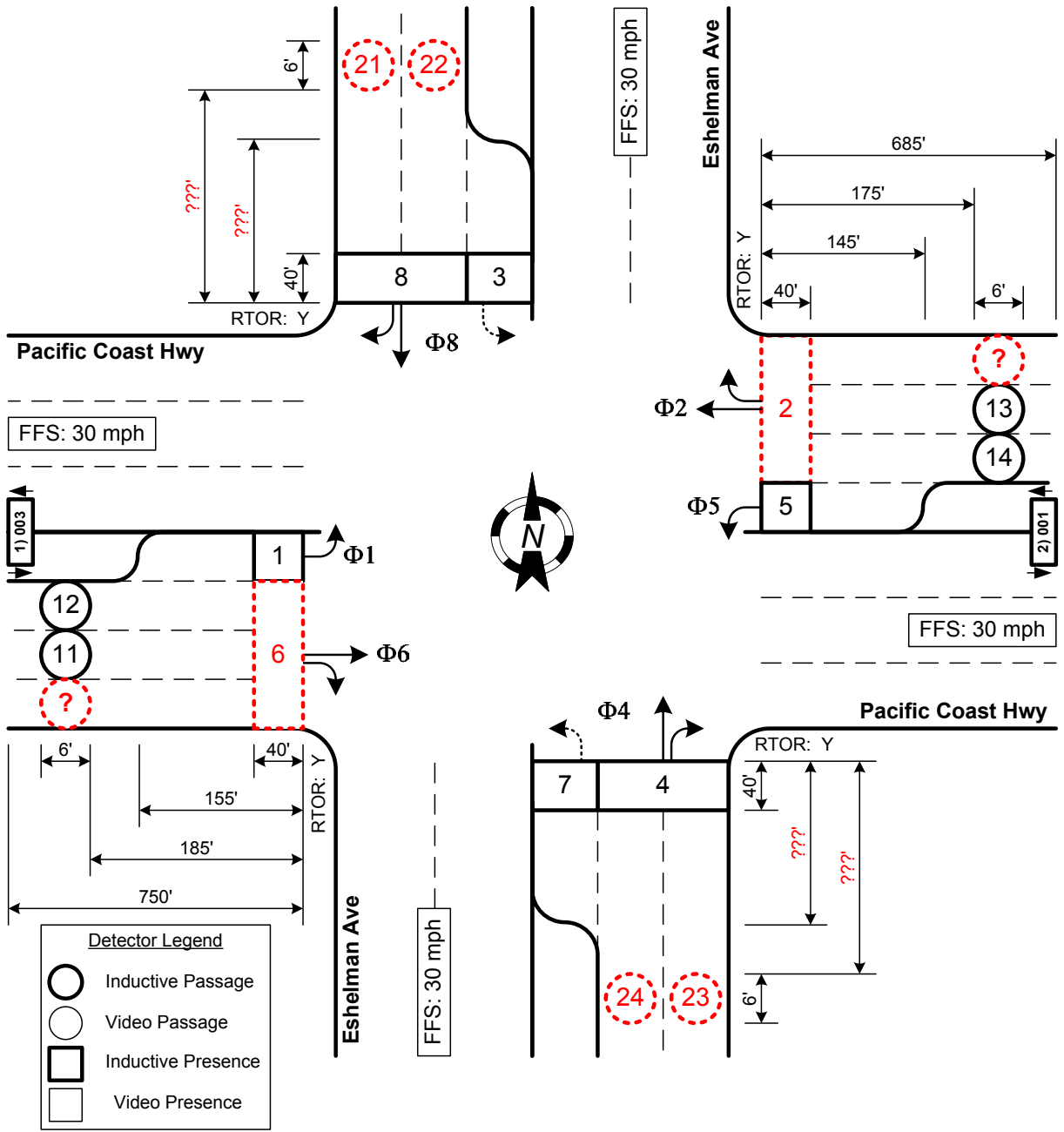

RHODES™ Configuration Report

City, State: Lomita, California

Intersection ID: 003

Intersection Name: PCH & Oak Street

2070 Software: **TBD**





RHODES Hardware: **TBD**

PREDICT Hardware: **TBD**

Initial Transition Time: 300 seconds

Maximum Peer Interval: 1) 5 sec 2) 5 sec

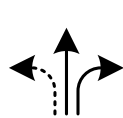
Phasing Structure and Parameters:

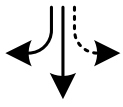
								a									b
2				1				3				4					
								Not Used									
DW				DW				DW				DW					
Min Max Amb Red				Min Max Amb Red				Min Max Amb Red				Min Max Amb Red					
10 50 3 2				5 8 3 2								5 20 3 2					
5				6				7				8					
								Not Used									
DW				DW				DW				DW					
Min Max Amb Red				Min Max Amb Red				Min Max Amb Red				Min Max Amb Red					
5 8 3 2				10 50 3 2								5 20 3 2					

APPENDIX A

Geometrics and Detector Assignments*:

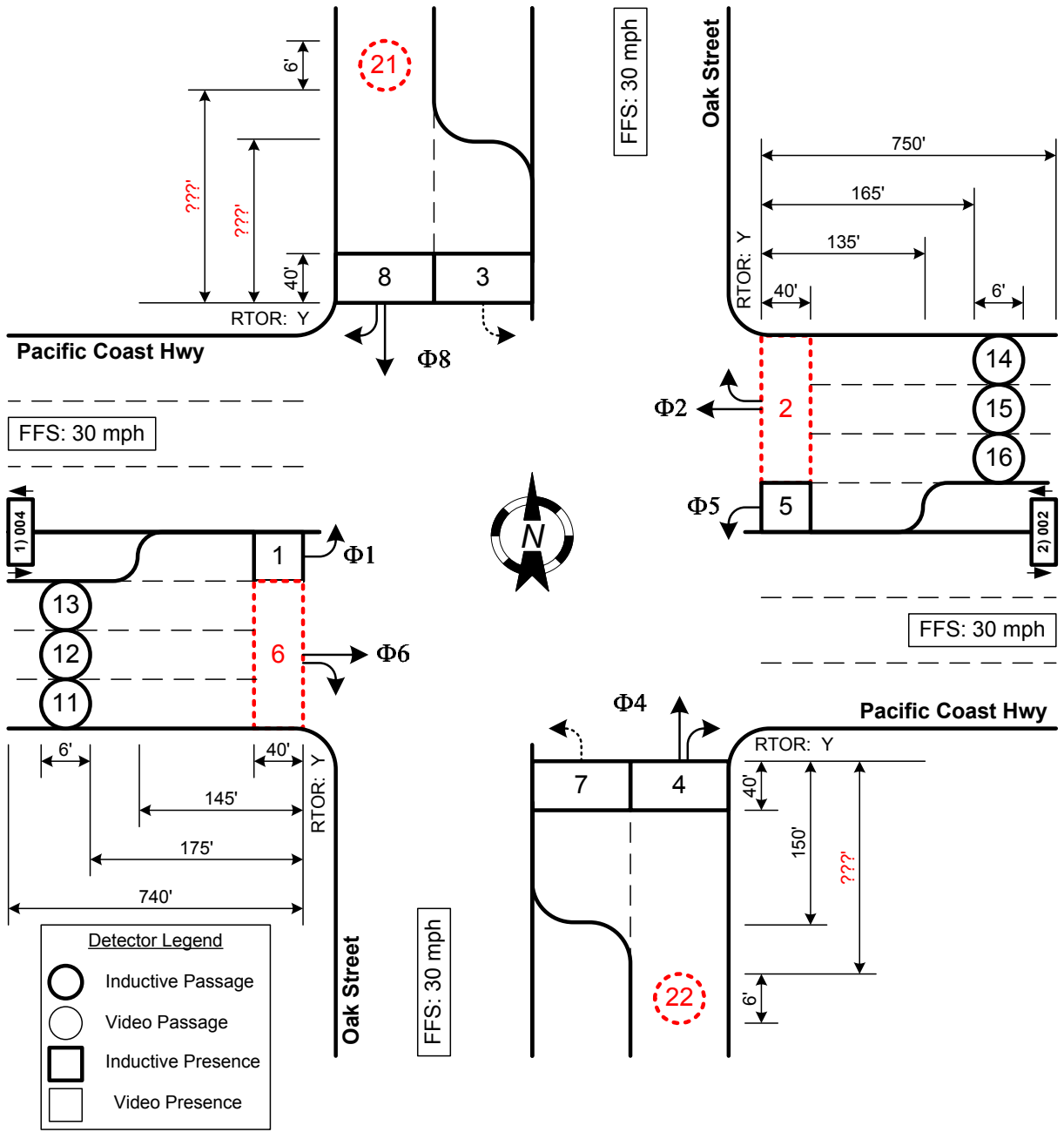

RHODES™ Configuration Report

City, State: Lomita, California

Intersection ID: 004

Intersection Name: PCH & Narbonne Avenue

2070 Software: **TBD**







RHODES Hardware: **TBD**

PREDICT Hardware: **TBD**

Initial Transition Time: 300 seconds

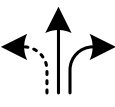
Maximum Peer Interval: 1) 5 sec 2) 5 sec

Phasing Structure and Parameters:

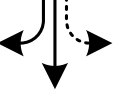
								a									b		
Wik	1				Wik	2				Wik	3				Wik	4			
																			
DW					DW					DW					DW				
Min	Max	Amb	Red	Min	Max	Amb	Red	Min	Max	Amb	Red	Min	Max	Amb	Red				
5	10	3	2	10	50	3	2	5	8	3	1	5	13	3	2				
Wik	6				Wik	5				Wik	7				Wik	8			
																			
DW					DW					DW					DW				
Min	Max	Amb	Red	Min	Max	Amb	Red	Min	Max	Amb	Red	Min	Max	Amb	Red				
10	50	3	2	5	10	3	2	5	10	3	1	5	13	3	2				

APPENDIX A

Geometrics and Detector Assignments*:

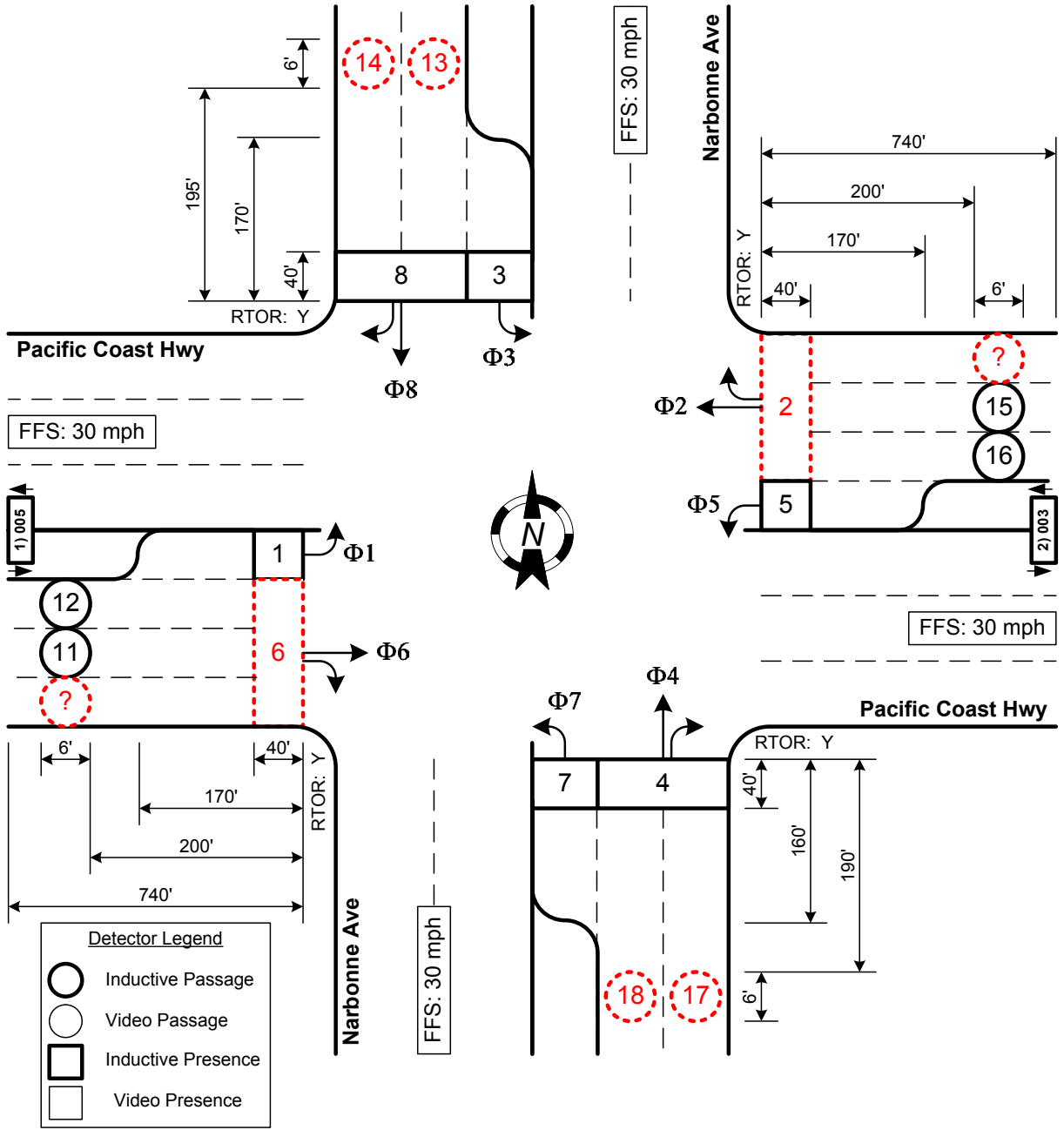

RHODES™ Configuration Report

City, State: Lomita, California

Intersection ID: 005

Intersection Name: PCH & Cypress Street

2070 Software: **TBD**

RHODES Hardware: **TBD**

PREDICT Hardware: **TBD**

Initial Transition Time: 300 seconds

Maximum Peer Interval: 1) 5 sec 2) 5 sec

Phasing Structure and Parameters:

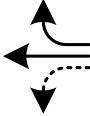
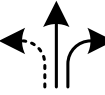
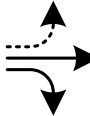
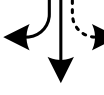
				a								b			
Wik	1			Wik	2			Wik	3			Wik	4		
	Not Used								Not Used						
DW															
Min	Max	Amb	Red	Min	Max	Amb	Red	Min	Max	Amb	Red	Min	Max	Amb	Red
				10	50	3	2					5	20	3	2
Wik	5			Wik	6			Wik	7			Wik	8		
	Not Used								Not Used						
DW															
Min	Max	Amb	Red	Min	Max	Amb	Red	Min	Max	Amb	Red	Min	Max	Amb	Red
				10	50	3	2					5	20	3	2

APPENDIX A

Geometrics and Detector Assignments*:

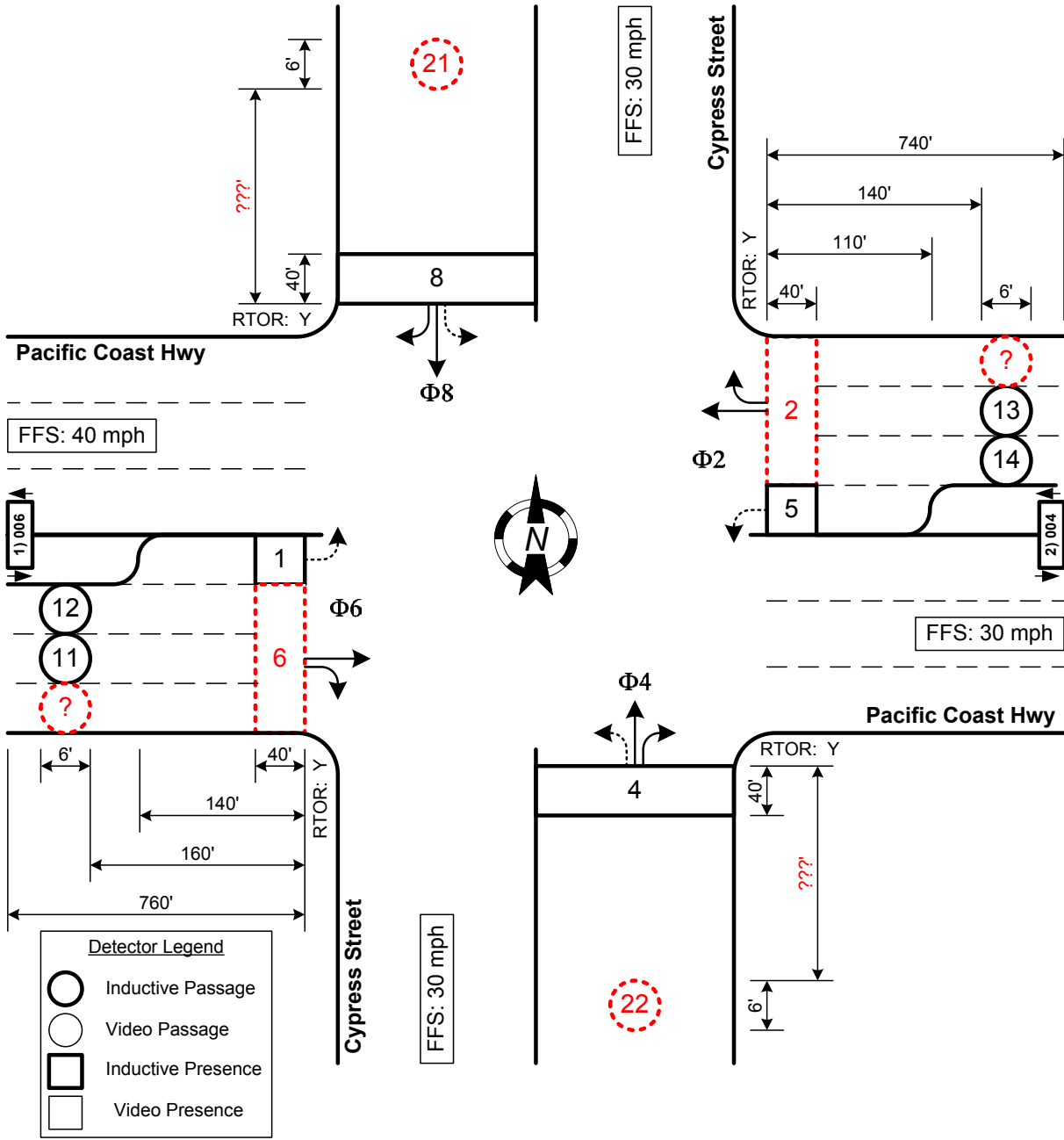

*Not to scale.

RHODES™ Configuration Report

City, State: Lomita, California

Intersection ID: 006

Intersection Name: PCH & Pennsylvania Avenue

2070 Software: **TBD**





RHODES Hardware: **TBD**

PREDICT Hardware: **TBD**

Initial Transition Time: 300 seconds

Maximum Peer Interval: 1) 5 sec 2) 5 sec

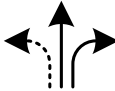
Phasing Structure and Parameters:

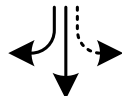
				a				b							
Wik	2			Wik	1			Wik	3			Wik	4		
									Not Used						
DW				DW				DW				DW			
Min	Max	Amb	Red	Min	Max	Amb	Red	Min	Max	Amb	Red	Min	Max	Amb	Red
10	50	3	2	5	8	3	2					5	20	3	2
Wik	5			Wik	6			Wik	7			Wik	8		
									Not Used						
DW				DW				DW				DW			
Min	Max	Amb	Red	Min	Max	Amb	Red	Min	Max	Amb	Red	Min	Max	Amb	Red
5	8	3	2	10	50	3	2					5	20	3	2

APPENDIX A

Geometrics and Detector Assignments*:

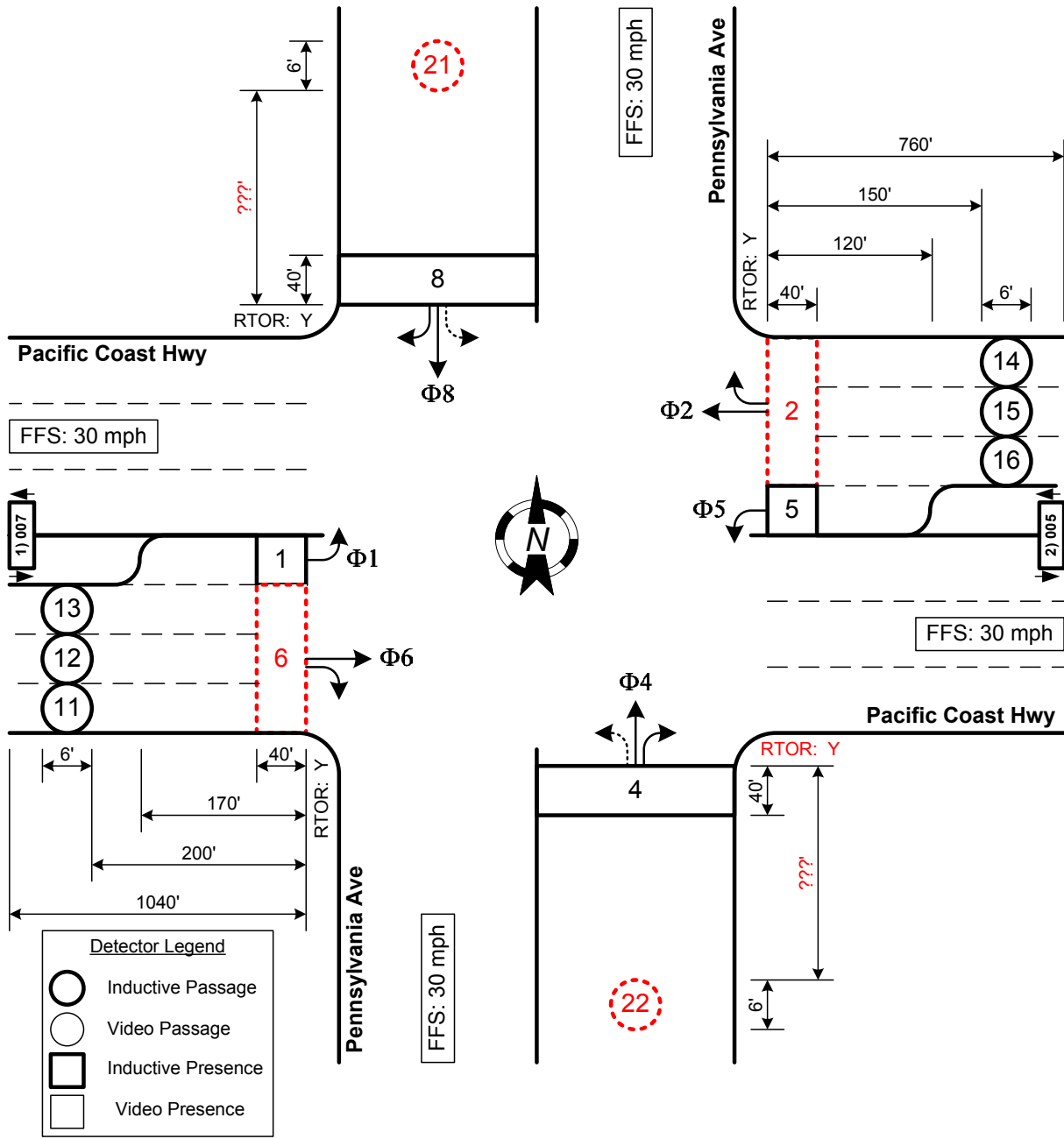

RHODES™ Configuration Report

City, State: Lomita, California

Intersection ID: 007

Intersection Name: PCH & Airport Drive

2070 Software: **TBD**



RHODES Hardware: **TBD**

PREDICT Hardware: **TBD**

Initial Transition Time: 300 seconds

Maximum Peer Interval: 1) 5 sec

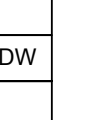
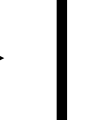
Phasing Structure and Parameters:

								a									b													
Wik	1				Wik					Wik	3				Wik															
	Not Used				DW					Not Used				DW	Not Used															
DW					Not Used															Not Used					Not Used					
Min	Max	Amb	Red	Min					Max	Amb	Red	Min	Max	Amb	Red	Min	Max	Amb	Red											
				10	50	4	2					5	40	3	2															
Wik	5				Wik					Wik	7				Wik															
					Not Used					DW					Not Used					DW	Not Used									
DW										Not Used															Not Used					Not Used
Min	Max	Amb	Red	Min	Max	Amb	Red	Min	Max					Amb	Red	Min	Max	Amb	Red											
				10	50	4	2	5	10	3	1	5	20	3	2															

APPENDIX A

Geometrics and Detector Assignments*:

