

# Lawrence Berkeley National Laboratory

## Recent Work

### Title

A Wide Band Slot-Coupled Beam Sensing Electrode for the Advanced Light Source

### Permalink

<https://escholarship.org/uc/item/0hj364z9>

### Authors

Hinkson, J.  
Rex, K.

### Publication Date

1991-05-01



# Lawrence Berkeley Laboratory

UNIVERSITY OF CALIFORNIA

## Accelerator & Fusion Research Division

Presented at the IEEE Particle Accelerator Conference,  
San Francisco, CA, May 6-9, 1991, and to be  
published in the Proceedings

### A Wide Band Slot-Coupled Beam Sensing Electrode for the Advanced Light Source

J. Hinkson and K. Rex

May 1991

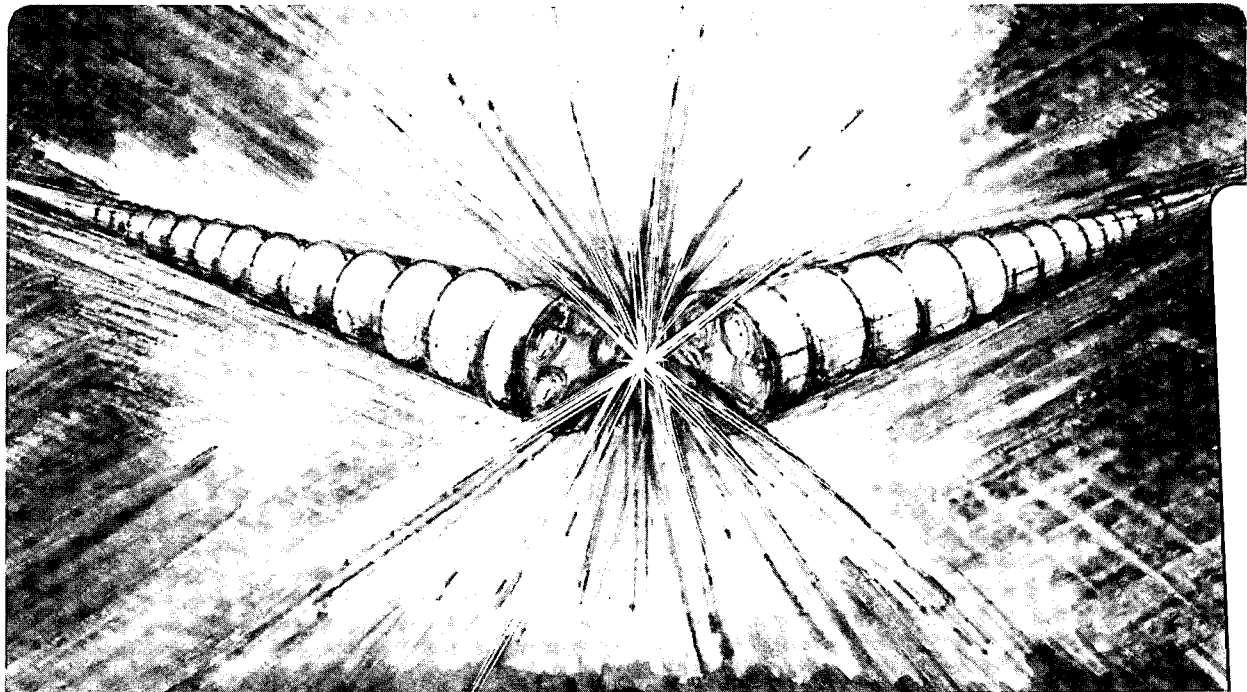

1 LOAN COPY 1  
1 Circulates 1  
1 for 4 weeks 1

Bldg. 50 Library.  
Copy 2

LBL-29907

## **DISCLAIMER**

This document was prepared as an account of work sponsored by the United States Government. While this document is believed to contain correct information, neither the United States Government nor any agency thereof, nor the Regents of the University of California, nor any of their employees, makes any warranty, express or implied, or assumes any legal responsibility for the accuracy, completeness, or usefulness of any information, apparatus, product, or process disclosed, or represents that its use would not infringe privately owned rights. Reference herein to any specific commercial product, process, or service by its trade name, trademark, manufacturer, or otherwise, does not necessarily constitute or imply its endorsement, recommendation, or favoring by the United States Government or any agency thereof, or the Regents of the University of California. The views and opinions of authors expressed herein do not necessarily state or reflect those of the United States Government or any agency thereof or the Regents of the University of California.

**A WIDE BAND SLOT-COUPLED BEAM SENSING ELECTRODE  
FOR THE ADVANCED LIGHT SOURCE\***

J. Hinkson and K. Rex

Accelerator and Fusion Research Division  
Lawrence Berkeley Laboratory  
University of California  
Berkeley, CA 94720

May 1991

Paper presented to the IEEE Particle Accelerator Conference, San Francisco, CA, May 6-9, 1991

# A WIDE BAND SLOT-COUPLED BEAM SENSING ELECTRODE FOR THE ADVANCED LIGHT SOURCE (ALS)\*

J. Hinkson, K. Rex

Accelerator and Fusion Research Division  
Lawrence Berkeley Laboratory  
University of California  
Berkeley, California 94720

## Abstract

Stripline electrodes (traveling wave electrodes, directional couplers) are commonly used in particle accelerators as beam pickups and kickers. The longitudinally symmetric stripline has a constant beam coupling impedance as a function of length and has a characteristic magnitude  $\sin(x)$  amplitude response in the frequency domain. An exponentially tapered stripline provides nearly constant coupling impedance vs. frequency and yields superior frequency-domain performance. In practice it is difficult to construct either of these devices for broad-band performance because of the transition from coaxial to stripline geometry. We report on the construction of an exponentially-tapered, slot-coupled "stripline" which was relatively easy to construct and has the desired frequency response.

## I. INTRODUCTION

Part of the ALS booster synchrotron beam diagnostics system includes three stripline assemblies; a kicker and two pickups. The kicker will be used to excite the beam during fractional betatron tune measurements. The pickups will be used in the tune measurements and as general purpose, broad-band beam diagnostics. We wished to use exponentially tapered striplines in the pickups because of their superior frequency domain performance. With prototypes we had trouble holding mechanical dimensions which were important for impedance reasons. We also had difficulty with the transition from coaxial to stripline geometry. To overcome these problems we developed a slot-coupled "stripline".

## II. THEORY

We show equations and calculations for ordinary striplines before discussing the slot-coupled stripline. Stripline pickups used in accelerators couple to the electromagnetic fields produced by the beam. Stripline kickers act reciprocally of course and produce fields that influence the beam. Figure 1 shows a typical stripline. The stripline electrode is held at the proper distance from the beam pipe wall by the center conductor of a coaxial vacuum feedthrough. In the case of stripline kickers feedthroughs are generally used on both ends. The down-stream feedthroughs in stripline pickups are often replaced with metal posts (shorts).

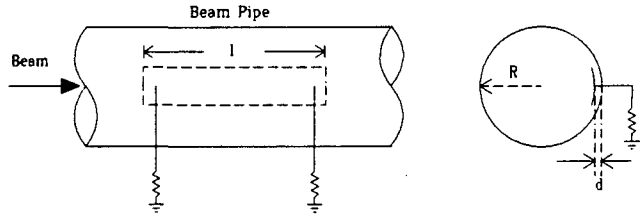

Fig. 1 Typical Stripline

The separation between the stripline and the wall is usually set at  $1/5$  the stripline width for 50 ohm self-impedance. In the following example the width is taken as 5 times the separation,  $d$ . The magnitude of the coupling impedance<sup>1</sup> of a longitudinally symmetric stripline to a relativistic beam in a round pipe (as a function of frequency) is:

$$Z_c = 60 \ln \frac{R}{R-d} \sin \frac{2\pi l}{\lambda} \quad (1)$$

where  $R$  is beam pipe radius,  $d$  is stripline-to-wall distance,  $l$  is stripline length, and  $\lambda$  is wavelength.

The calculated frequency response of a typical stripline is shown as a sine curve in figure 2. Here the electrode length is 150mm, the spacing is 2.54mm, the beam pipe radius is 30mm, and the width is 12.7mm.

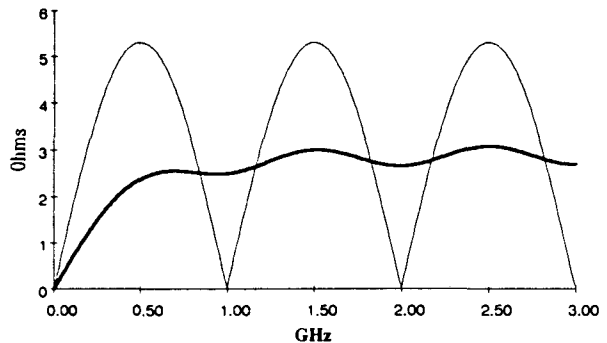

Fig. 2 Stripline Frequency Response: The dark line is the tapered stripline response. The lighter line is symmetrical (untapered) stripline response.

Linnecar<sup>2</sup> reported on the superior frequency domain performance of tapered striplines. These striplines have no nulls in their response but do have some ripple. The ripple may be minimized with proper design.

The coupling impedance<sup>2</sup> of an exponentially tapered stripline in a round pipe (as a function of frequency) is:

$$Z_c = \frac{K_{max} \omega l}{v} \sqrt{\frac{1 + \frac{1}{e^{2\alpha}} - \frac{2}{e^\alpha} \cos \frac{2\omega l}{v}}{\alpha^2 + \frac{4\omega^2 l^2}{v^2}}} \quad (2)$$

$$K_{max} = 60 \ln \frac{r1}{r1-h1} \quad (3)$$

$$K_{min} = 60 \ln \frac{r2}{r2-h2} \quad (4)$$

$$\alpha = \ln \frac{K_{max}}{K_{min}} \quad (5)$$

where  $K_{max}$  is stripline coupling at the wide end,  $K_{min}$  is coupling at the narrow end,  $r1$  is electrode radius at the wide end,  $r2$  is electrode radius at the narrow end,  $h1$  is electrode spacing at the wide end,  $h2$  is electrode spacing at the narrow end,  $v$  is beam velocity,  $l$  is electrode length,  $\omega$  is radian frequency, and  $\alpha$  is the attenuation constant.

If the stripline is untapered (e.g.,  $K_{min} = K_{max}$ , and  $\alpha = 0$ ), equation (2) yields approximately the same results as equation (1). The difference in this case is that equation (1) calculates coupling impedance as a function of pipe radius, and equation (2) uses the electrode radius.

The calculated frequency response of an exponentially tapered stripline is shown in figure 2 as the heavier line. Here the electrode length is 150mm, the maximum width is 12.7mm, the minimum width is 1mm, the maximum spacing is 2.54mm, and the beam pipe radius is 30mm. The attenuation constant,  $\alpha$ , is 2.668.

### III. THE SLOT-COUPLED PICKUP

We explored slot coupling between two coaxial transmission lines in order to evaluate different slot shapes. The linear slot behaved similarly to the untapered stripline. An exponentially tapered slot gave a frequency response similar to the figure 2 darker curve. A linearly tapered slot with a 7 to 1 width ratio had more ripple and a steeper low frequency skirt. A gaussian taper gave an interesting time domain result. When driven by a very fast voltage step, the coupled line output was a Gaussian voltage pulse.

In order to simulate beam coupling through a slot we built a structure similar to figure 3 and modeled the beam with a 3mm wire centered in the beam pipe. Slots cut in a removable thin-wall cylinder having the same diameter as the beam pipe defined

the coupling. An untapered slot behaved the same as an untapered stripline located at the beam pipe wall but with less coupling. The coupling of an untapered slot may be approximated by equation (2) ( $K_{max} = K_{min}$ ) multiplied by a coupling constant  $k$ :

$$k = \frac{a}{2\pi} \frac{b}{2\pi} \quad (6)$$

where angles  $a$  and  $b$  are defined by the aperture.

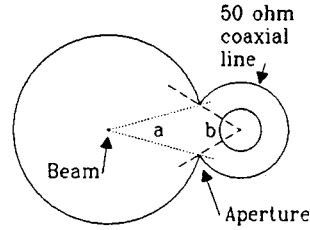

Fig. 3. Aperture Coupling

The coupling of a tapered slot is also approximated by equation (2) multiplied by the  $k$  factor. We calculate the performance of a tapered stripline at the wall and apply the  $k$  factor calculated for the widest aperture. The measured ripple is always less than equation (2) predicts.

### IV. BEAM PICKUP MECHANICAL DETAILS

Figure 4 shows a cut-away view of the slot-line pickup. The body of the pickup is machined from a single piece of aluminum. The beam aperture, nominally 63mm in diameter is drilled through the center of the cylindrical aluminum block. Four holes 32mm in diameter are drilled through the block 44mm off the center of the beam axis and 90 degrees apart. The four holes intersect the beam pipe hole forming 16mm apertures the full length of the block. Aluminum rods inserted into the four holes form 50 ohm coaxial lines. The rods are supported by the center conductors of type-N constant-impedance vacuum feedthroughs welded into removable end-flanges. Beam field coupling to the rods is defined by exponentially tapered slots in a thin-wall brass tube with a diameter slightly less than the beam aperture. The slots are 15mm across on the widest end, 2.5mm on the narrow end, and 150mm long.

The ends of the rods are tapered down to the feedthrough center conductor diameter to maintain 50 ohm impedance. On the vacuum side of the flanges where the feedthroughs are installed the flange is machined to form the impedance taper required to accommodate the tapered rod ends. The longitudinal position of the rods is important for impedance reasons. They are properly positioned by having a hole in one end of exact depth and a spring in the hole in the other end. With one end flange bolted to the body, the rods are fitted (spring loaded end first) onto the flange feedthrough center conductors. The other flange is then installed. The rod springs force them into proper longitudinal position. RF contact between the rods and the

feedthrough center-conductors is made with gold-plated RF "fingers" inside the holes.

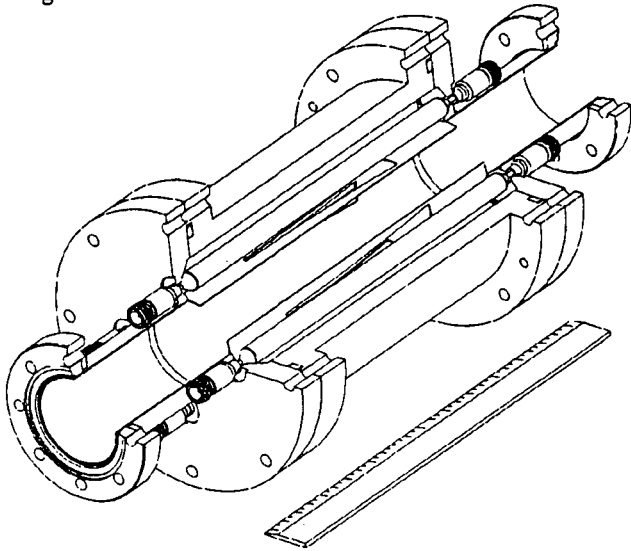

Fig. 4 Slot-coupled Pick Up

### V. BEAM KICKER MECHANICAL DETAILS

Everything about the kicker is identical to the pickups except for the slots and the external cable connections. We use rectangular slots 15mm wide and 150mm long in the kicker.

### VI. LABORATORY TESTS

We tested the pickups and kicker coaxial lines with a TDR to insure the internal connections were correct. Some impedance discontinuities were seen, the largest being a 40 ohm section in the feedthroughs. The influence of the tapered slot was seen as a 4 ohm increase in the line impedance at the slot location.

We tested the coupling characteristics of the pickups and kicker with a centered wire supported by tapered coaxial horns. The instruments we used were a 20GHz sampling scope, a 60ps gaussian pulser, a 300ps gaussian pulser, and a vector network analyzer. Figure 5 shows the frequency response of the four slotted couplers in one pickup. The nominal coupling is -44dB. The marker measurement in figure 5 indicates -47dB (-3dB down) at 500MHz. Figure 6 shows the response to a 60ps pulse. The coupled pulse amplitude corresponds to a coupling impedance of 0.6 ohm which agrees reasonably with equation (2) multiplied by the coupling factor. In figure 6 an echo pulse if any would occur 1ns after the prompt pulse. Unlike the symmetric stripline, the tapered coupler has no echo pulse.

We have no data on beam measurements to present here. The ALS injector is nearing completion, and we should have data soon.

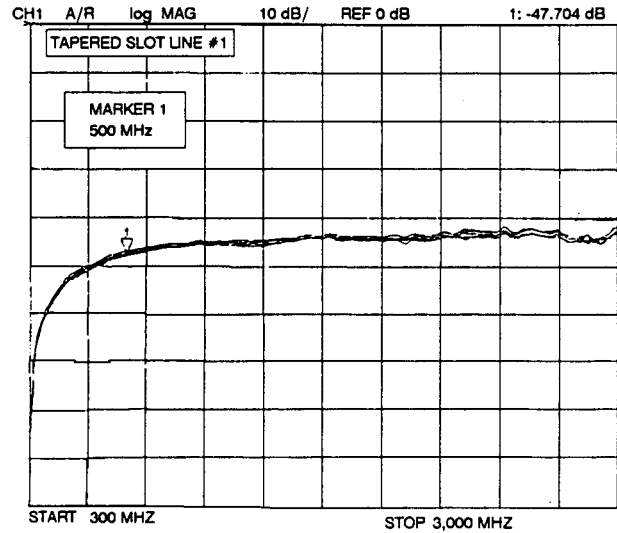

Fig. 5 Slot-Coupled Pickup Frequency Response

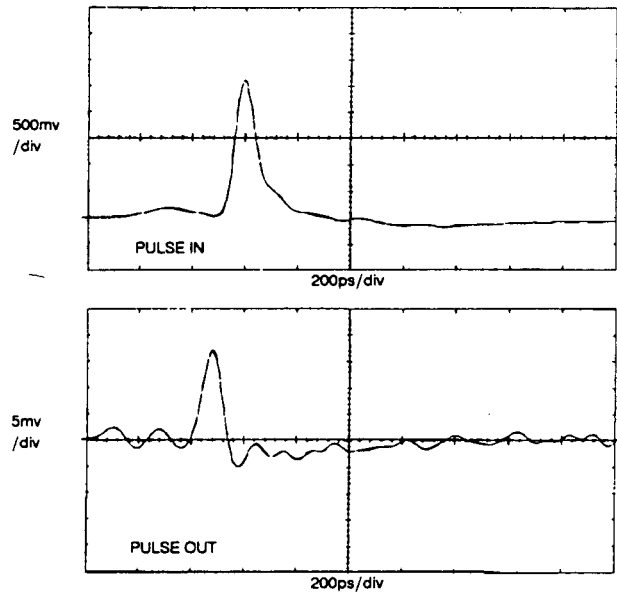

Fig. 6 Slot-Coupled Pickup Pulse Response

### VII. ACKNOWLEDGEMENT

\*This work was supported by the Director, Office of Energy Research, Office of Basic Energy Sciences, Materials Sciences Division of the U.S. Department of Energy, under Contract No. DE-AC03-76SF00098

### VIII. REFERENCES

- [1] R. Bossart and H. Rossi, "Test of Beam Position Monitors at Daresbury Nuclear Physics Laboratory", (1973)
- [2] T. Linnekar, "The High Frequency Longitudinal and Transverse Pickup Used in the SPS", European Organization for Nuclear Research, CERN-SPS/ARF/78-17, (1978)

LAWRENCE BERKELEY LABORATORY  
UNIVERSITY OF CALIFORNIA  
INFORMATION RESOURCES DEPARTMENT  
BERKELEY, CALIFORNIA 94720