

Lawrence Berkeley National Laboratory

Lawrence Berkeley National Laboratory

Title

High-performance commercial building systems

Permalink

<https://escholarship.org/uc/item/0f6772ck>

Author

Selkowitz, Stephen

Publication Date

2003-10-01

HP CBS

High Performance Commercial Building Systems

Final Report

October, 2003

LBNL- 53538

CEC Contract #400-99-012



Stephen Selkowitz

Building Technologies Department
Environmental Energy Technologies Division

Ernest Orlando Lawrence Berkeley Laboratory

Prepared By:

*Buildings Technologies Department
Lawrence Berkeley National Laboratory*

Stephen Selkowitz
B90R3110
1 Cyclotron Road
E. O. Lawrence Berkeley National Laboratory
Berkeley, CA 94720

CEC Contract No. 400-99-012

Prepared For:

California Energy Commission

CEC Contract No. 400-99-012

Martha Brook
Contract Manager

Nancy Jenkins,
PIER Buildings Program Manager

Terry Surles,
PIER Program Director

Robert L. Therkelsen
Executive Director

This report was prepared for the California Energy Commission under Contract No. 400-99-012 and is also published as CEC P500-03-097.

Legal Notice

This document was prepared as an account of work sponsored by the United States Government. While this document is believed to contain correct information, neither the United States Government nor any agency thereof, nor The Regents of the University of California, nor any of their employees, makes any warranty, express or implied, or assumes any legal responsibility for the accuracy, completeness, or usefulness of any information, apparatus, product, or process disclosed, or represents that its use would not infringe privately owned rights. Reference herein to any specific commercial product, process, or service by its trade name, trademark, manufacturer, or otherwise, does not necessarily constitute or imply its endorsement, recommendation, or favoring by the United States Government or any agency thereof, or The Regents of the University of California. The views and opinions of authors expressed herein do not necessarily state or reflect those of the United States Government or any agency thereof, or The Regents of the University of California.

This report was also published as a Lawrence Berkeley National Laboratory Report: LBNL-53538.

Acknowledgements

In a program of this magnitude there are many people who contributed to its success. We owe the many staff members, faculty, and students of the different institutions our thanks for the superb work and long hours they contributed. All of their names may not appear in this report, but their efforts are visible in the many papers, reports, presentations, and thesis that were the major output of this program.

The EETD leadership provided support in many ways. We thank Mark Levine, Marcy Beck, and Nancy Padgett.

Members of the Communications Department of EETD helped in preparing reports, presentations, handouts, and brochures. The help of Allan Chen, Julia Turner, Anthony Ma, Steve Goodman, Sondra Jarvis, and Ted Gartner is acknowledged.

Special thanks is given to the support staff from the Buildings Technologies Program at LBNL: JeShana Bishop, Rhoda Williams, Denise Ills, Catherine Ross, Pat Ross, and Danny Fuller. Norman Bourassa performed a wide range of duties, from original research to tracking deliverables.

We thank the following members of the Program Advisory Committee (PAC) for their advice and support. In a program designed to deal with real world problems their ideas were vital. The PAC members are:

Larsson, Nils	C2000 Canada
Stein, Jay	E-Source
Wagus, Carl	Am. Architectural Manufs. Assoc.
Lewis, Malcolm	Constructive Technologies
Bernheim, Anthony	SMWM Architects
MacLeamy, Patrick	HOK
Mix, Jerry	Wattstopper
Waldman, Jed	CA Dept of Health Services
Bocchicchio, Mike	UC Office of the President
Prindle, Bill	Alliance to Save Energy
Sachs, Harvey	ACEEE
Browning, Bill	Rocky Mountain Institute
Lupinacci, Jean	U.S. EPA
Goldstein, Dave	Natural Resources Defense Council
Smothers, Fred	Smother & Associates
Benney, Jim	NFRC Director of Education
Stewart, RK	Gensler Assoc
Angyal, Chuck	San Diego Gas & Electric

Ervin, Christine	US Green Buildings Council
Ginsberg, Mark	US Department of Energy
Higgins, Cathy	New Buildings Institute

In addition to the PAC, each element had a Technical Advisory Group (TAG) that provided us with additional advice, criticism, and suggestions. These members are listed in the element introduction section.

Finally, we acknowledge the support and contributions of the PIER Contract Manager, Martha Brook, and the Buildings Program team under the leadership of Nancy Jenkins.

Table of Contents

Preface	viii
Executive Summary	1
Abstract	13
1.0 Introduction	14
2.0 Element 2 Life-Cycle Tools	17
2.1. Web-Based Benchmarking--(Element 2, Project 2.1)	19
2.2. Prototype Performance Metrics Tracking Tool (Metracker)--(Element 2, Project 2.2)	24
2.3. Benchmarking Performance Assessment for Small Commercial Buildings-- (Element 2, Project 2.3)	28
2.4. Retrofit Tools--(Element 2, Project 2.4)	32
2.5. Improving Building Energy Performance Simulation with Software Interoperability--(Element 2, Project 2.5).....	34
3.0 Element 3 Lighting, Envelope, and Daylighting	40
3.1. Lighting Controls--(Element 3, Project 3.1)	42
3.2. Daylighting--(Element 3, Project 3.2)	48
3.3. Network Operations--(Element 3, Project 3.3).....	53
4.0 Element 4 Low Energy Cooling	58
4.1. Appraisal of System Configurations--(Element 4, Project 4.1)	60
4.2. Efficient Distribution Systems--(Element 4, project 4.2)	64
4.3. Model Development--(Element 4, project 4.3).....	70
5.0 Element 5 Integrated Commissioning and Diagnostics	76
5.1. Commissioning and Monitoring for New Construction--(Element 5, Project 5.1)	78
5.2. Fault Detection and Diagnostic Procedures (Element 5, Project 5.2)	85
5.3. Guide to the implementation of monitoring systems in existing buildings-- (Element 5, Project 5.3)	90
5.4. Integrated Commissioning and Diagnostics Develop and Test Hardware and Software for High -Information-Content Electrical Load Monitoring-- (Element 5, Project 5.4)	92
5.5. Occupant Feedback Methods for Diagnostic Systems (Element 5, Project 5.5)	95
5.6. Commissioning Persistence--(Element 5 Project 5.6).....	102
5.7. Develop Simulation-Assisted Commissioning—(Element 5, Project 5.7)	106
5.8. Develop Tune-up Procedures Based on Calibrated Simulations (Element 5, Project 5.8)	109
5.9. Semi-Automated, Component-Level Diagnostic Procedures--(Element 5, Project 5.9)	111

6.0	Indoor Environmental Quality (Element 6)	114
6.1.	Energy Modeling Phases I and II—(Element 6, Project 6.1)	117
7.0	Glossary	125
8.0	List of Attachments	128

List of Figures

Figure 1. Organizational Chart	14
Figure 2. Relationships Among Commercial Building Components	17
Figure 3. Whole Building Energy Use Intensity	20
Figure 4. Electricity Use Intensity	20
Figure 5. Histogram Of Whole Building Energy Use Intensity For A Particular Input Of Building Conditions, Location, And Energy Use.....	21
Figure 6. Building Comparisons	21
Figure 7. Sample Screen From The Cal-Arch Software	23
Figure 8. Sample Screenshot From Metracker	26
Figure 9. IFC Object Data Model	35
Figure 10. Computer Generated “See-Through” Of The Small Bank Building And It’s HVAC System And Equipment.....	36
Figure 11. IBECS Network Architecture.....	41
Figure 12. IBECS Ballast/Network Interface	43
Figure 13. IBECS Addressable Power Switch	44
Figure 14. Prototype Workstation Multisensor	44
Figure 15. IBECS RMS Current Monitor.....	45
Figure 16. Diffuse Light Conditions.....	49
Figure 17. Bright Sunlight Conditions	49
Figure 18. Venetian Blind System at LBNL.....	50
Figure 19. Labview "Virtual Instrument" Panel Used To Control The Operation Of The IBECS-Controlled Venetian Blinds.....	50
Figure 20. Control Panel For Eight Light Fixtures In Open Plan Office.	50
Figure 21. IBECS-Controlled Electric Lighting Fixtures.....	50
Figure 22. System Diagram Of The Proposed Communications	54
Figure 23. Displacement Ventilation.....	59
Figure 24. Natural Ventilation	59
Figure 25. Duct Leakage Impacts on Annual HVAC Operating Costs.....	67
Figure 26. Schematic Showing The Basic Two-Node Structure For Displacement Ventilation.....	71
Figure 27. Schematic Of The Implementation In Energyplus.....	72
Figure 28. Calculated Flow In The Proposed San Francisco Federal Building	73

Figure 29. The Role Of Performance Monitoring And Fault Detection And Diagnosis In Improving The Operation Of Building.....	77
Figure 30. Excerpt from the Functional Testing Guide: Relative Calibration Test.....	81
Figure 31. Excerpt from Selection and Installation of Control and Monitoring Points Chapter	82
Figure 32. Schematic Of Approach.....	85
Figure 33. . Schematic of Energy Information Systems	87
Figure 34. Screen Shot Of TIEMS Temperature Page.	97
Figure 35. Number Of Service Requests Submitted By Lead Users.	98
Figure 36. Labor Hours Comparison Between TIEMS And Phone.	99
Figure 37. Success Rate Of MORE By Action Code	100
Figure 38. Cooling Consumption in a Commissioned Building	103
Figure 39. Persistence of equipment and controls fixed during commissioning. Light gray boxes show measures that persisted and black boxes show measures that did not persist.....	104
Figure 40. Demonstration Of IEQ Equipment In Classroom.....	114
Figure 41. Source Energy Savings Estimates for Advanced Hybrid vs. HPAC.....	116
Figure 42. IEQ and Energy Monitoring Results.....	121

List of Tables

Table 1. Labor Hours Comparison Between TIEMS And Phone.....	98
--	----

Preface

This document summarizes the work performed by the Lawrence Berkeley National Laboratory's High-Performance Commercial Building Systems (HPCBS) program, a three-year public-private research initiative targeting substantial reductions in the energy costs of commercial buildings. This report is intended for a broad audience, and does not include detailed technical information. References and links are provided for those documents. Most of the documents are available on the HPCBS website:

<http://buildings.lbl.gov/hpcbs/>

This report contains an executive summary covering the entire program. There are twenty-three project summaries outlining the forty-two separate tasks covered by the HPCBS program. Each contains an introduction, approach, outcomes, and conclusions and recommendations. At the end of each task is a list of significant research products and a short summary of what is in those documents. A complete list of research products, including technical reports, guides, software, and web sites that contain additional information, is contained in the Appendix.

The Buildings Program Area within the Public Interest Energy Research (PIER) Program produced this document as part of a multi-project programmatic contract (#500-98-026). The Buildings Program includes new and existing buildings in both the residential and the non-residential sectors. The program seeks to decrease building energy use through research that will develop or improve energy-efficient technologies, strategies, tools, and building performance evaluation methods.

The Public Interest Energy Research (PIER) Program supports public interest energy research and development that will help improve the quality of life in California by bringing environmentally safe, affordable, and reliable energy services and products to the marketplace.

The PIER Program, managed by the California Energy Commission (Commission), annually awards up to \$62 million to conduct the most promising public interest energy research by partnering with Research, Development, and Demonstration (RD&D) organizations, including individuals, businesses, utilities, and public or private research institutions.

PIER funding efforts are focused on the following six RD&D program areas:

- Buildings End-Use Energy Efficiency
- Industrial/Agricultural/Water End-Use Energy Efficiency
- Renewable Energy
- Environmentally-Preferred Advanced Generation
- Energy-Related Environmental Research
- Strategic Energy Research.

For other reports produced within this contract or to obtain more information on the PIER Program, please visit www.energy.ca.gov/pier/buildings or contact the Commission's Publications Unit at 916-654-5200.

Executive Summary

PROGRAM OVERVIEW

This report summarizes key technical accomplishments resulting from the three year PIER-funded R&D program, “High Performance Commercial Building Systems” (HPCBS). The program targets the commercial building sector in California, an end-use sector that accounts for about one-third of all California electricity consumption and an even larger fraction of peak demand, at a cost of over \$10B/year. Commercial buildings also have a major impact on occupant health, comfort and productivity. Building design and operations practices that influence energy use are deeply engrained in a fragmented, risk-averse industry that is slow to change. Although California’s aggressive standards efforts have resulted in new buildings designed to use less energy than those constructed 20 years ago, the actual savings realized are still well below technical and economic potentials.

The broad goal of this program is to develop and deploy a set of energy-saving technologies, strategies, and techniques, and improve processes for designing, commissioning, and operating commercial buildings, while improving health, comfort, and performance of occupants, all in a manner consistent with sound economic investment practices. Results are to be broadly applicable to the commercial sector for different building sizes and types, e.g. offices and schools, for different classes of ownership, both public and private, and for owner-occupied as well as speculative buildings. The program aims to facilitate significant electricity use savings in the California commercial sector by 2015, while assuring that these savings are affordable and promote high quality indoor environments.

The five linked technical program elements contain 14 projects with 41 distinct R&D tasks. Collectively they form a comprehensive Research, Development, and Demonstration (RD&D) program with the potential to capture large savings in the commercial building sector, providing significant economic benefits to building owners and health and performance benefits to occupants. At the same time this program can strengthen the growing energy efficiency industry in California by providing new jobs and growth opportunities for companies providing the technology, systems, software, design, and building services to the commercial sector.

The broad objectives across all five program elements were:

- To develop and deploy an integrated set of tools and techniques to support the design and operation of energy-efficient commercial buildings;
- To develop open software specifications for a building data model that will support the interoperability of these tools throughout the building life-cycle.
- To create new technology options (hardware and controls) for substantially reducing controllable lighting, envelope, and cooling loads in buildings.
- To create and implement a new generation of diagnostic techniques so that commissioning and efficient building operations can be accomplished reliably and cost effectively and provide sustained energy savings
- To enhance the health, comfort and performance of building occupants

To provide the information technology infrastructure for owners to minimize their energy costs and manage their energy information in a manner that creates added value for their buildings as the commercial sector transitions to an era of deregulated utility markets, distributed generation, and changing business practices.

Our ultimate goal is for our R&D effort to have measurable market impact. This requires that the research tasks be carried out with a variety of connections to key market actors or trends so that they are recognized as relevant and useful and can be adopted by expected users. While some of this activity is directly integrated into our research tasks, the handoff from “market-connected R&D” to “field deployment” is still an art as well as a science and in many areas requires resources and a timeframe well beyond the scope of this PIER research program. The TAGs, PAC and other industry partners have assisted directly in this effort by reviewing and critiquing work to date, and by partnering in activities that advance results toward market impacts.

The goals, objectives and key accomplishments of each technical program element and projects are described in the sections that follow. For each project we then summarize the Task Approach, the Outcomes of each task, and our Conclusions and Recommendations. We also provide a list and short summary of each significant research product e.g. report, prototype, software, standard, etc.

SUMMARY OF RESULTS

Element 2: Life Cycle Tools

The Life Cycle Tools Program Element focuses on developing integrated information management technologies to improve commercial building performance. The technical goal for this program element is to develop and deploy an integrated set of building performance information management systems. These systems include software tools and analysis techniques, data definitions and schema (such as key performance metrics), and databases to assist in the evaluation of commercial building energy and non-energy performance issues.

Project 2.1 Web-Based Benchmarking

California commercial building owners have no easy way to determine how their building’s energy use compares to others. Recent research conducted in collaboration with the US EPA has shown that California buildings are different from the national building stock. This project developed a web-based benchmarking tool specification for design, and deployed it through workshops, papers, and conference presentations.

- The Cal-Arch tool is complete. It is a web-based benchmarking tool that incorporates California end-use data and is available on-line. It is available for public use and can be downloaded on the LBNL public web site.
- Cal-Arch is regularly used at the Pacific Energy Center in basic courses on energy in buildings, and can be used by energy managers, energy information system vendors, utilities, performance contractors, and researchers and analysts.
- The statistical analysis in this project led to enhancements and changes to the U.S. EPA-DOE Energy Star whole-building rating tool methodology.

- This research influenced CEC and EPA policy and the use of benchmarking during the energy crisis in California.

Project 2.2 Prototype Performance Metrics Tracking Tool (Metracker)

Metracker is a prototype computer tool designed to demonstrate the specification, tracking, and visualization of building performance objectives and their associated metrics across the complete life cycle of a building.

- A final Metracker prototype tool was developed for defining and tracking performance metrics across the building life cycle. This prototype is available for download from the HPCBS website.
- A report on Standardized Building Performance Metrics was written and widely distributed. This report increased exposure of performance metrics to key building industry participants.
- Commercialization and collaboration discussions were initiated and continue with several potential partners who are interested in either using Metracker in demonstration pilot projects, or modifying Metracker for use in their existing and evolving software toolboxes.

Project 2.3 Benchmarking Performance Assessment For Small Commercial Buildings

Until very recently benchmarking data have been the province of energy analysts and not those who operate businesses and pay energy bills. The intent of this project is to determine how a small sample of people involved in operating buildings can make use of benchmarked energy-consumption data.

- The West Contra Costa Unified School District, with 49 schools, was selected for investigation after consideration of small commercial buildings and a three-campus community college.
- Benchmarking metrics were developed with data provided by PG&E and shared with school officials and PG&E.
- Four Non-Intrusive Load Monitors (NILMs) and three electricity data loggers were installed in two schools and used to assess a lighting retrofit and night cooling.
- It was determined that there is a demand, on the part of officials of the targeted K-12 school district, for suitably packaged energy information. The investigators consider the school district to be typical in this respect and assert that there is a substantial market for well-priced and timely energy information.

Project 2.4 Retrofit Tools

In the early 1990s, the federal government supported the development of the Retrofit Energy Savings Estimation Method (RESEM) tool as a public-domain resource, both for benchmarking other tools and as an extensible code resource for other developers. An updated version was produced (RESEM-CA) that has features customized to California specifics with regard to commercial building stock types and equipment, weather, utility rates, and preferred retrofit strategies (Energy Conservation Opportunities).

- The RESEM-CA software tool was modernized, extended and validated. The results of the validation study confirm that RESEM-CA is a sufficiently accurate tool to be suitable for retrofit analysis.
- A design approach for linking external information using commercial object-oriented database technology was prototyped, and a set of data resources was developed.
- A market deployment strategy was articulated and some initial steps informally taken.

Project 2.5 Improving Building Energy Performance Simulation with Software Interoperability

The objective of this task is to develop an Industry Foundation Classes (IFC) data model extension that defines HVAC components in buildings in detail. The model provides a framework for seamless data exchange among software tools that support the design, selection, definition, installation, and operation of HVAC equipment and systems.

The IFC HVAC model extension was completed and integrated in the latest version of the IFC data model of buildings, IFC2x2.

- The IFC2x2 data model was released worldwide to the public in May 2003.
- Its potential use and benefits were demonstrated in a pilot exchange between a building energy simulation tool (EnergyPlus) and a duct design tool (MagiCAD) in September 2002. The demonstration showed that IFC-based data exchange can facilitate energy savings and improve the quality of design, simulation and analysis.

Element 3: Lighting, Envelope, and Daylighting

The overall technical goal of this program element is to develop an Integrated Building Equipment Communications System (IBECS) network that will allow appropriate automation of lighting and envelope systems to increase energy efficiency, improve building performance, and enhance occupant experience in the space. This network will provide a low-cost means for occupants to control local lighting and window systems, thereby improving occupant comfort, satisfaction and performance. A related goal of this program element is to improve existing lighting control components and accelerate development of new daylighting technologies that will allow daylighting to be more extensively applied to a larger proportion of building floor space.

Project 3.1 Lighting Controls

The objective of this task is to design, build, and test the IBECS networking system and control device interfaces, and develop working prototypes of advanced multi-functional sensors and power-metering devices that support the IBECS network.

- Key IBECS network components were developed. We successfully developed working prototypes of the ballast network interface, IBECS-enabled wall switch, advanced sensor, and lighting panel meter.
- We developed a fully-configured IBECS network that is installed in Building 90-3111 at LBNL.

- We established connections with ballast manufacturers. Two ballast manufacturers have indicated they intend to add IBECs technology to their new ballasts. In addition, we are negotiating with a manufacturer of digital lighting networking products to embed the IBECs ballast network interface in their network connector.
- We verified compliance with IEEE standards. The IEEE 1451 Standard on Sensors and Actuators has adopted for its reference protocol the same digital communications protocol (1-Wire™ communications protocol from Dallas Semiconductor) used by the IBECs system.

Project 3.2 Daylighting

The objective of this project is to design, build, and test the Integrated Building Environmental Communications System (IBECs) networking system and control device interfaces that enable local and global energy-efficient operation of building envelope systems such as motorized shades and switchable, variable transmittance electrochromic windows.

- We developed working prototypes of key IBECs network components. We developed control device interfaces for three window components: DC-motorized Venetian blinds or roller shades, AC-motorized blinds or shades, and electrochromic windows.
- The nation's first full-scale demonstration of electrochromic windows was conducted.
- Significant reductions in lighting energy use were achieved. Daily lighting energy use was 6-24% less when compared to a static 11% transmittance window and 3% less to 13% more compared to a 38%-window. Window brightness control and interior daylight levels were improved with dynamic window control.
- Demonstrated reliable operation of the controller through the IBECs network.
- Achieved control of motorized blinds through the IBECs network.
- Informed major shade and components manufacturers of the IBECs research. The LBNL demonstration has been showcased to numerous visitors.

Project 3.3 Network Operations

Integrated lighting controls can significantly improve building performance, increase energy efficiency, and enhance occupant comfort and satisfaction with the built environment. The objective of this project is to develop a framework to integrate the IBECs with the BACnet protocol and to demonstrate that IBECs can be used to commission, re-commission and maintain building lighting systems.

- We successfully developed a conceptual framework to unify not only IBECs and BACnet but also the DALI protocol that is finding increased acceptance in the lighting industry.
- We developed preliminary software for addressing and controlling certain types of lighting devices and tested the software in an IBECs demonstration network at LBNL's Building 90.

Element 4 Low Energy Cooling

Cooling energy use is second only to lighting energy use in commercial buildings. Cooling in commercial buildings accounts for 14% of California's peak electrical demand. Cooling system efficiency can be improved through the appropriate use of compressor-less cooling technologies and techniques for cooling occupied spaces more effectively, and by reducing distribution system losses.

Project 4.1 Appraisal of System Configurations

Low energy cooling techniques have the potential, either individually or in combination, to reduce energy consumption and/or peak demand in California climates. This project identified potentially synergistic combinations of existing compressor-less cooling technologies, energy-efficient methods of cooling spaces and energy-efficient distribution systems using computer simulation, and estimated the savings to be expected from the deployment of these systems.

- The performance of six low energy cooling systems has been simulated in all sixteen California climate zones using DOE-2. Significant savings relative to a conventional HVAC system are predicted (~20-60%, depending on system type, climate and building type).
- Evaporative pre-cooling is beneficial in all California climates.
- Radiant slab cooling can significantly reduce peak demand by smoothing and shifting cooling loads and can reduce energy consumption through greater use of water-side free cooling.

Project 4.2 Efficient Distribution Systems

Although not generally recognized by the building industry, thermal distribution systems (TDS) in large commercial buildings can suffer from thermal losses, such as those caused by duct air leakage and poor duct insulation. The overall goal of this project is to support the development of future recommendations to address duct performance in Title 24 by bridging the gaps in current duct thermal performance modeling capabilities, and by expanding our understanding of duct thermal performance in California large commercial buildings.

- Our review of current building simulation tools determined that the best approach for our short-term benefits analysis task is to build upon past research that used DOE-2 and TRNSYS sequentially to evaluate HVAC system performance. For long-term use, we suggested that EnergyPlus, which is based partly on DOE-2, be developed to include the TRNSYS component models that we used in our benefits analyses. To provide a foundation for achieving this goal, we documented duct-modeling principles and published the TRNSYS component models.
- Our analyses indicate that a leaky low-pressure variable-air-volume (VAV) reheat system (19% total duct leakage) in a California large commercial office building will use about 40 to 50% more fan energy annually than a tight system (about 5% leakage). Annual cooling plant energy also increases by about 7 to 10%, but reheat energy decreases (about 3 to 10%). In combination, the increase in total annual HVAC site energy is approximately 2 to 14%, which results in

HVAC system annual operating cost increases ranging from 9 to 18% (\$7,400 to \$9,500).

- Normalized by duct surface area, the increases in HVAC system annual operating costs are approximately 0.14 to 0.18 \$/ft² for the 19% leakage case. At a suggested duct sealing cost of about \$0.20/ft² of duct surface area, sealing leaky ducts in VAV systems has a simple payback period of about 1.5 years. We concluded that duct sealing should be cost effective for VAV systems in California large commercial buildings with 10% or more duct leakage.
- Our analyses also indicate that climate and building vintage differences do not cause significant variability in duct leakage impacts on fan energy use or on HVAC operating costs for leaky duct systems. This suggests that a single duct leakage threshold could be developed for use in the Title 24 prescriptive compliance approach and would not need to be climate or building age specific.
- We developed an Alternative Calculation Method (ACM) change proposal to include an overall metric for thermal distribution system efficiency in the reporting requirements for the 2005 Title 24 Standards. The new metric (HVAC Transport Efficiency) is the ratio between the energy expended to transport heating, cooling, and ventilation throughout a building and the total thermal energy delivered to the various conditioned zones in the building.

Project 4.3 Model Development

Current whole building analysis tools assume that all spaces within a building are well mixed and can be represented by a single temperature. Low energy cooling strategies typically produce significant temperature variations within a space. This project extends the simple mixed models to more realistic models appropriate to low energy cooling.

- Models were developed for mechanical and natural ventilation and wind-driven cross ventilation. These models were implemented in the Department of Energy's building thermal response simulation tool EnergyPlus.
- A flow regime characterization routine (FDM) was implemented, simplifying the use of the models. This routine decides between mixed and unmixed airflow patterns, depending on system geometry, indoor surface temperatures, and internal loads.
- The ability of EnergyPlus to model relatively lightweight low temperature radiant panels was investigated. The conclusion is that the conduction transfer function method is sufficiently accurate for energy calculation purposes.
- The implementation of these models in EnergyPlus will provide engineers and designers with the ability to assess the effectiveness of a number of low-energy cooling options, including natural ventilation and displacement ventilation.
- The models have been used to assess wind-driven ventilation for the new San Francisco Federal Building and for the design of the new Children's Museum in San Diego.

Element 5 Integrated Commissioning and Diagnostics

The building design and construction industry has become highly segmented and fee-restrained in recent years. In this highly competitive marketplace, owners seldom

receive fully functional building systems. It has been shown that these problems can be avoided if buildings are properly commissioned. It has been shown that buildings that are properly commissioned not only provide better comfort for the occupants; they are also easier to operate and cost less to operate.

Project 5.1 Commissioning and Monitoring for New Construction

The objective of this project is to assemble and develop a set of manual tools, test procedures, and guides to support the commissioning of heating, ventilation, and air conditioning (HVAC) systems.

- The Control System Design Guide (Design Guide) and Functional Testing (FT) Guide for Air Handling Systems was completed. The finished product is a MS Word document that is available for download at the HPCBS web site.
- The FT Guide assists users to better understand the purpose, instrumentation, test conditions, potential problems, and cost-effectiveness behind air handling system test procedures. It also describes the theory behind the tests as well as sample calculations for quantifying the energy implications of problems that commissioning can identify.
- The Design Guide provides methods and recommendations for the control system design process, monitoring and control point selection, and installation.
 - ▶ Initial feedback on the FT Guide has been positive as the industry recognizes the need for this type of educational material and the need to disseminate standardized procedures in the Commissioning Test Protocol Library (CTPL).

Project 5.2 Fault Detection and Diagnostic Procedures

The objective of this work is to evaluate and compare fault detection tools and techniques for building operators, engineers, and energy managers, and to evaluate and develop a consistent methodology for fan diagnostics.

- Diagnostic tools were reviewed and trend logging points from EMCS for use in different tools were compared. The scope of the diagnostics and types of problems found were also compared.
- A detailed set of recommendations for technical improvements and interface enhancements were prepared that will substantially improve the usability and performance of the tools.
- The Energy Information System report created a technology characterization framework that has been useful for the California Energy Commission in Demand Response research and other areas.
- This project successfully identified several tools out of the fan analysis toolkit that are good candidates to support diagnostics work on fan systems.

Project 5.3 Guide to the implementation of monitoring systems in existing buildings

Buildings consume approximately one-third of the energy used in the U.S. A considerable portion of this energy is wasted because of dysfunctional sensors and EMCS systems. The objective of this task is to enhance the data logging capability of existing Energy Management and Control Systems (EMCSs) and to develop technology that can be used to determine when specific sensors have drifted out of calibration.

- Three (3) Guides were written which will enable owners and building engineers to determine how their EMCS could be capable of being used as an energy data logger.
- The Sensor Fault Detection concept was developed and prototyped to enable detection of sensors that drift away from their calibration points.

Project 5.4 Develop And Test Hardware And Software For High-Information-Content Electrical Load Monitoring

The purpose of the NILM is to detect on and off switching of major HVAC loads in commercial buildings, track variable-speed drive loads, and detect operating faults from a centralized location at affordable cost. This information can be used to optimize operations, aid commissioning and diagnostics, or simply to provide the energy manager with short and long term Energy Use Intensity (EUI) information that is key to maintaining and improving plant efficiency.

- We developed a consistent analytic framework for NILM software, making it possible to link together a series of algorithms.
- We developed most of the algorithms needed for a complete system, including
 - ▶ An upgraded method for detecting changes in steady state loads and analyzing short-term start-up transients;
 - ▶ An arbitrator that allows both algorithms to run in parallel and that selects the method that produces the statistically favorable load identification;
 - ▶ A procedure to sort out overlapping loads;
 - ▶ A procedure to determine the statistically more likely set of loads running at a given time, as a means of establishing a start-up condition for the NILM and of preventing accumulation of load-detection errors; and
 - ▶ A procedure for detecting and tracking VSD loads via high-order harmonics.
- A market for the NILM has been identified but not exploited. Discussions with energy-service professionals revealed a number of energy-information providers for commercial buildings.

Project 5.5 Occupant Feedback Methods for Diagnostic Systems

The objective of this task is to develop and deploy web-based information technology to allow occupants of commercial buildings to get access to building operational data relevant to them, and to use information from occupants in a systematic way to improve building operations.

- We developed a web-based user interface for energy and maintenance systems called Tenant Interface for Energy and Maintenance Systems

- We designed an expert system called Maintenance and Operations Recommender (MORE). MORE uses information from computerized maintenance management systems (CMMS) and energy management and control systems (EMCS) to recommend what maintenance personnel should do in response to a maintenance service request or other event requiring a maintenance or control system action.
- We filed an invention disclosure for MORE with the Office of Technology Licensing at UC Berkeley.

Project 5.6 Commissioning Persistence

Substantial anecdotal evidence is available that procedures implemented when buildings (whether new or old) are commissioned are sometimes discontinued by operators. There was no previous systematic examination of even a small set of commissioned buildings to determine the extent or impact of this problem. The objectives of this project are to investigate the extent to which mechanical system performance in new and existing construction degrades over time and the reasons for this degradation.

- The initial study investigated persistence of savings from retrocommissioning in 10 buildings that ranged from about 100,000 ft² to about 400,000 ft² with an almost equal mix of single duct and dual duct systems. All but one included a mix of office, class and laboratory space; the other was a volleyball arena. The study found that the savings two years after commissioning were 83% of the initial savings.
- The initial persistence study for new buildings was summarized in a report on the Persistence of Benefits of New Building Commissioning. As a first study, this work began to address how well commissioning measures persist and the reasons for lack of persistence.
- A guide was also developed to inform building owners, managers, and operators about strategies for improving the persistence of building performance. This guide is a practical document; each persistence strategy is described in detail: why it is important, what is involved, who performs the work and what other resources are available.

Project 5.7 Develop Simulation-Assisted Commissioning Procedures

A variety of different approaches to detecting and diagnosing HVAC system faults have been investigated. The objective of this project is to develop methods for using whole-building simulation models to define the expected performance of buildings during commissioning. This includes development and testing of fault detection and diagnosis procedures. We compared simulated and actual performance functional test procedures that maximize the information gained in different modes of operation and minimize the uncertainty in predicting long term performance from short-term tests.

- We determined that both the detailed and the simplified whole-building simulation approaches evaluated are able to predict correct operation with sufficient accuracy to be useful for certain classes of diagnostics and functional testing.

- The ASHRAE Simplified Energy Analysis Procedure has been evaluated in two field tests. The simulation (1) served to identify multiple faults in building HVAC operation in each building; and (2) provided an accurate prediction of the savings that resulted from correcting the faults. The simulation-based functional test procedures using data from short-term tests were developed for terminal box reheat valve leakage, improper minimum terminal box airflow, improper minimum outside airflow, poor outside air damper quality, excessive maximum supply airflow, improper supply air static pressure, and improper building positive pressure. Functionality of the tests for improper minimum terminal box airflow, improper minimum outside airflow, and poor outside air damper quality was verified in field tests.

Project 5.8 Develop Tune-Up Procedures Based on Calibrated Simulations

Initial work on calibration and validation of building simulation programs dates to the 1980s. However, the early work was largely restricted to research projects that laboriously and expensively compared the predictions of a simulation program with monthly utility bills or with the performance of a heavily instrumented building. The objective of this project is to develop mechanisms to rapidly calibrate building simulations for use to evaluate the savings potential of building tune-ups.

- A methodology for the rapid calibration of cooling and heating energy consumption simulations for commercial buildings based on the use of “calibration signatures,” which characterize the difference between measured and simulated performance, was developed and presented in a manual.
- The ASHRAE Simplified Energy Analysis Procedure has been evaluated in two field tests and has served to identify multiple faults in building HVAC operation.

Project 5.9 Semi-Automated, Component-Level Diagnostic Procedures

HVAC systems often fail to operate correctly due to faulty or incorrectly installed equipment. The objective of this project is to implement and test component-level functional testing and performance monitoring procedures for HVAC systems.

- A library of HVAC component models and a toolbox of software procedures to support component-level, functional testing, and performance monitoring was developed and implemented.
- The software is available from the HPCBS website for control and equipment manufacturers to use as a starting point in the implementation of model-based fault detection procedures in products, and for others to use in developing tools for HVAC functional testing, performance monitoring, and fault detection.

Element 6: Indoor Environmental Quality

Energy efficiency and indoor environmental quality (IEQ) are key building design issues, but they are often considered to be at odds with each other when design, construction, and operation decisions are made. This study was conducted with the goal of quantifying and demonstrating technologies with the potential to simultaneously improve energy efficiency and IEQ in commercial buildings. Many building types could be considered for this demonstration; this study focuses on new modular or portable relocatable classrooms (RC) as the exemplary buildings.

Project 6.1 Energy Modeling Phases I And II

The objective of this project is to use building energy modeling tools to develop calibrated, comparative RC energy consumption projections for the climate zones in California, to compare the current standard RC designs to high performance, energy-efficient designs. A further objective is to use these calibrated models to develop cost-benefit analyses for the high-performance products.

- We demonstrated that through use of engineering solutions, a high performance RC could be developed that significantly reduces energy consumption while simultaneously providing ventilation supplied at the state building energy and occupational code-mandated rates.
- Using existing datasets, and then a newly calibrated input dataset, DOE-2 modeling was conducted to simulate energy consumption of the standard and high-performance RC HVAC systems. The outcome was energy usage projections from use of the two HVAC systems for 16 California climate zones.
- Statewide cost benefit analyses and savings predictions were made based on the calibrated DOE-2 simulations comparing the standard versus high-performance RCs.

Project 6.2 Field Study Evaluation of HVAC Options and Evaluation of VOC Source Control Measures

This study was conducted with the goal of quantifying and demonstrating technologies with the potential to simultaneously improve energy efficiency and IEQ in commercial buildings. This demonstration was conducted on relocatable classrooms, an important subset of the small commercial building stock in CA. HVAC system and building material selection were investigated.

- A major RC manufacturer, American Modular Systems (Manteca, CA) manufactured four RCs to our specifications with the Advanced Hybrid IDEC/hydronic gas heat high performance HVAC systems. They were sited in pairs at elementary schools at two participating school districts. The four RCs were monitored throughout the school year, with many parameters recorded at six-minute intervals.
- Laboratory testing yielded VOC and aldehyde source strength data for the major building materials used in the RCs and potential alternate materials. From this we specified wall, carpet and ceiling material alternates that were incorporated into the study alternate material RCs.

Results of the IEQ field study have been presented at a wide range of public and professional venues and are making their way into the popular and scientific literature. The results have stimulated the RC HVAC industry to accelerate in investing in development of new energy-efficient and IEQ-appropriate HVAC systems.

Abstract

Commercial buildings account for about one-third of all California electricity consumption, at an annual cost of \$10 billion. Although aggressive efforts by California to improve building design have led to significant increases in commercial building energy efficiency over the past 20 years, the savings are still well below technical and economic potential. The High Performance Commercial Building Systems (HPCBS) program, a three-year public-private research initiative, targets substantial reductions in the energy costs of commercial buildings. Under the leadership of scientists from the U.S. Department of Energy's Lawrence Berkeley National Laboratory, research, development, demonstration, and deployment was performed in 41 projects in five distinct areas of commercial building performance. Funding was provided by the California Energy Commission through its Public Interest Energy Research Program, along with the Department of Energy and private sector partners who provided in-kind assistance.

1.0 Introduction

The five linked technical program elements contain 14 projects with 41 distinct R&D tasks. Collectively they form a comprehensive Research, Development, and Demonstration (RD&D) program with the potential to capture large savings in the commercial building sector, providing significant economic benefits to building owners, and health and performance benefits to occupants. At the same time this program can strengthen the growing energy efficiency industry in California by providing new jobs and growth opportunities for companies providing the technology, systems, software, design, and building services to the commercial sector.

The program is organized as shown in Figure 1.

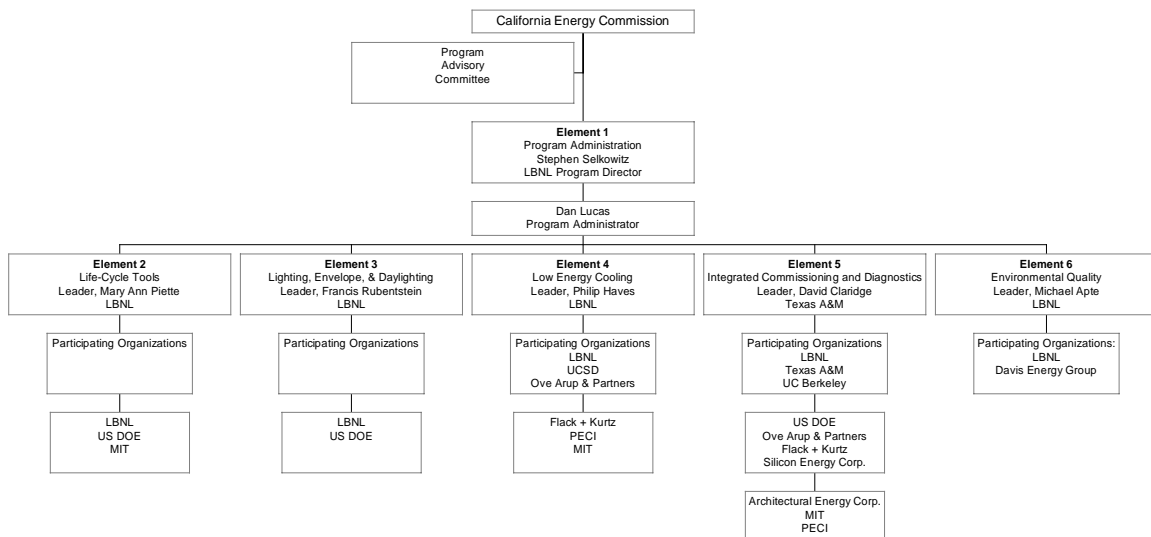

Figure 1. Organizational Chart

Element 1:

Administration

Element 2 Life-Cycle Tools (M. A. Piette, Lead)

- Project 2.1 Web-Based Benchmarking
(LBNL: M. A. Piette, S. Kinney)
- Project 2.2 Prototype Performance Metrics Tracking Tool (Metracker)
(LBNL: R. J. Hitchcock)
- Project 2.3 Benchmarking Performance Assessment for Small-Commercial Buildings (MIT: L. Norford)
- Project 2.4 Retrofit Tools
(LBNL: W. L. Carroll, R. J. Hitchcock, N. J. Bourassa)
- Project 2.5 Improving Building Energy Performance Simulation with Software Interoperability (LBNL: V. Bazjanac)

- Element 3 **Lighting, Envelope And Daylighting (F. M. Rubinstein, Lead)****
- Project 3.1 Lighting Controls (LBNL: F. Rubinstein, J. Galvin, D.DiBartolomeo;
Vistron: P. Pettler)
- Project 3.2 Daylighting (LBNL: E. Lee, D. DiBartolomeo, F. Rubinstein;
Vistron: P. Pettler)
- Project 3.3 Network Operations (LBNL: F. Rubinstein, J. Jennings; Vistron: P. Pettler)
- Element 4 **Low Energy Cooling (P. Haves, Lead)****
- Project 4.1 Appraisal of System Configurations (LBNL: N. Bourassa, P. Haves,
J. Huang, P. Xu)
- Project 4.2 Efficient Distribution Systems
(LBNL: C. P. Wray, N. Matson, M. Modera)
- Project 4.3 Model Development
(UC San Diego: P. Linden, G. Carrilho da Graça, LBNL: P. Haves)
- Element 5 **Integrated Commissioning and Diagnostics (D. Claridge, Lead)****
- Project 5.1 Commissioning and Monitoring for New Construction
- Project 5.2 Fault Detection and Diagnostic Procedures (LBNL: M. A. Piette)
- Project 5.3 Guide to the Implementation of Monitoring Systems in Existing
Buildings (Texas A & M: C. Culp)
- Project 5.4 Benchmarking Performance Assessment for Small Commercial
Buildings (MIT: L.K. Norford, K.D. Lee, S.B. Leeb)
- Project 5.5 Occupant Feedback Methods for Diagnostic Systems
(UC Berkeley: C. Federspiel)
- Project 5.6 Commissioning Persistence (Texas A&M: D. Claridge and W.D.
Turner; PECE: T. Haasl and H. Friedman)
- Project 5.7 Develop Simulation-Assisted Commissioning Procedures (LBNL: P.
Haves; Texas A&M: D. Claridge; Univ. of Nebraska: M. Liu)
- Project 5.8 Develop Tune-Up Procedures Based on Calibrated Simulations (Texas
A&M: D. Claridge; University of Nebraska: M. Liu)
- Project 5.9 Semi-Automated, Component-Level Diagnostic Procedures
(LBNL: P. Haves, P. Xu)
- Element 6 **Indoor Environmental Quality (M. G. Apte, Lead)****
- Project 6.1 Energy Modeling Phases I and II
(LBNL: M. Apte, W. Fisk, L Rainer, D. Shendell)
- Project 6.2 Field Study Evaluation of HVAC Options and Evaluation of VOC Source
Control Measures (M. Apte, W. Fisk, A. Hodgson, D. Shendell)

2.0 Element 2 Life-Cycle Tools

INTRODUCTION

The buildings industry is large, fragmented, and diverse. Commercial buildings range from residential-scale small businesses to large, complex mixed-use structures. Managers, owners, and others who decide whether or not to incorporate energy-efficient and other new technologies into their buildings are confronted with a complicated set of issues. Although the standard pressures of time, cost, and risk influence decision making in the commercial sector, more fundamental underlying obstacles to effective decisions include:

- Lack of an integrated buildings systems perspective, loss of information throughout the building's life cycle, and poor feedback between operations and design;
- An industry fee and financing structure that emphasizes short-term perspective and economic uncertainties;
- Lack of standard building performance metrics and benchmarking tools and techniques;
- Lack of standard methods for retrofit performance analysis; and
- Lack of standard methods for exchanging data among software programs.

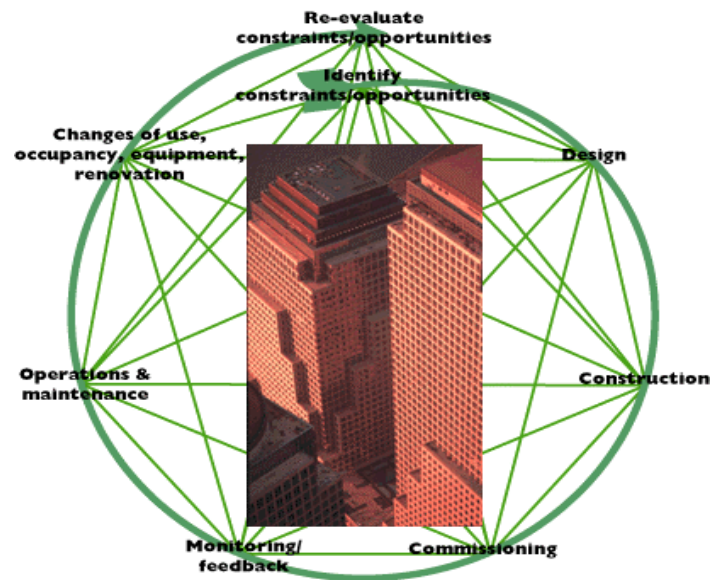

Figure 2. Relationships Among Commercial Building Components

OBJECTIVES

The Life Cycle Tools Program Element focuses on developing integrated information management technologies to improve commercial building performance. The technical goal for this program element is to develop and deploy an integrated set of building performance information management systems. These systems include software tools and analysis techniques, data definitions and schema (such as key performance metrics), and databases to assist in the evaluation of commercial building energy and non-energy performance issues.

- Develop and deploy benchmarking and performance metric tracking tools and techniques. A performance metric definition includes: name, specifier, and date of specification; benchmark value, type, unit of measurement, and source; and assessment value(s) and source.
- Evaluate and produce benchmarking data sets, data definitions, and primary performance metrics for use with an individual building over time or for comparison of a given building with others.
- Develop and deploy a retrofit tool designed to provide a ranked set of conservation measures. Use the tool results to provide a baseline for alternative Energy Service Companies (ESCO) analyses.
- Use the retrofit tool results for savings prediction and verification. Consistent pre- and post-retrofit analysis form the basis for predicted savings, and provide a baseline for verifying actual savings from monitored data.
- Develop an interoperable data schema for HVAC systems. Develop data schema using Industry Foundation Classes (IFCs). IFCs are a data schema for various types of building information established and with ongoing revisions by the International Alliance for Interoperability (IAI). Provide a method to allow EnergyPlus to use the HVAC IFCs.
- Track activities in related Program Elements to ensure that the information management aspects are being considered.

The economic goal of this program element is to reduce building energy costs by providing tools to decision-makers that help them take energy cost saving actions throughout the building life-cycle.

The overall economic goals were to:

- Ensure that the benchmarking and performance metrics tools are usable and robust, providing techniques and information tools that are of economic value to building owners and other decision makers.
- Ensure that the retrofit tool is of use to ESCOs and other retrofit market actors,
- Ensure that the HVAC data schemas are developed in a way to make them readily useful to the buildings software industry.

Project Team and Technical Advisory Group (TAG)

Element 2 was lead by Mary Ann Piette of the Lawrence Berkeley National Laboratory, with MIT as a subcontractor. Significant contributors to this element included:

- S. Kinney (LBNL)
- R. J. Hitchcock (LBNL)
- L. Norford (MIT)
- W. L. Carroll (LBNL)
- N. J. Bourassa (LBNL)
- V. Bazjanac (LBNL)

The Technical Advisory Group (TAG) included:

- Charles Eley (Eley Associates)
- Ann McCormick (Emcor Group, Newcomb Anderson)
- Robert Sonderegger (Silicon Energy)
- Ann Sprunt Crawley (DOE-FEMP)
- Jim Forrester (Marinsoft)
- Sam Cohen (Energy Solutions)
- Fried Augenbroe (Georgia Tech)
- John Kunz, CIFE (Stanford)
- Kirk McGraw (CERL)
- Alistair McGregor (Arup/SF)
- Shlomo Rosenfeld (HVAC design consultant)
- Alastair Watson (University of Leeds)

2.1. Web-Based Benchmarking--(Element 2, Project 2.1)

INTRODUCTION

Background and Overview

California commercial building owners have no easy way to determine how their building's energy use compares to others. Recent research conducted in collaboration with the US EPA has shown that California buildings are different from the national building stock. Benchmarking tools that use national data such as the U.S. DOE's Commercial Building Energy Consumption Survey (CBECS) need to be used with caution.

OBJECTIVES

- The objective of this task is to:
- Develop and deploy web-based benchmarking tools and techniques.
- Allow commercial building owners, managers, and operators access to relevant energy benchmarking tools and data sets.
- Evaluate differences between California and national building energy use data.

APPROACH

The approach consisted of the following:

- Develop a web-based benchmarking tool specification for design.
- Conduct SAS-based data analysis of CEUS to organize data for the web tool.
- Build the tool and deploy it through workshops, papers, and conference presentations.
- Evaluate various energy performance data issues. Key topics included school energy use, pool energy use, comparison with Energy Star benchmarking, office building energy use, and restaurant energy use.
- Revise web-based tool based on ongoing review, recommendations, and feedback.

OUTCOMES

Technical Outcomes

- The Cal-Arch tool was completed. It is a web-based benchmarking tool that incorporates California end-use data and is available on-line.
- Cal-Arch software asks the user for building type, ZIP code, floor area, annual energy consumption, and site/source preference data. The results are displayed as a histogram of the user's energy use intensity (EUI), as shown below. Additional information is provided to help interpret the results, explain the data sources, and compare with other benchmarking tools.
- Cal-Arch uses a distributional benchmarking method to query California Energy Use Survey (CEUS) data. With a simple query, Cal-Arch returns a distribution of energy use intensities, or energy use per square foot. No modeling or adjustments are used; hence, the distribution represents actual energy use in actual buildings. Summary statistics and explanatory information help users make valid comparisons.

Figure 3 and Figure 4 are examples from the Cal-Arch software that compares a building's electricity and whole building energy use intensity to selected buildings from the database. Links provide additional information as shown below.

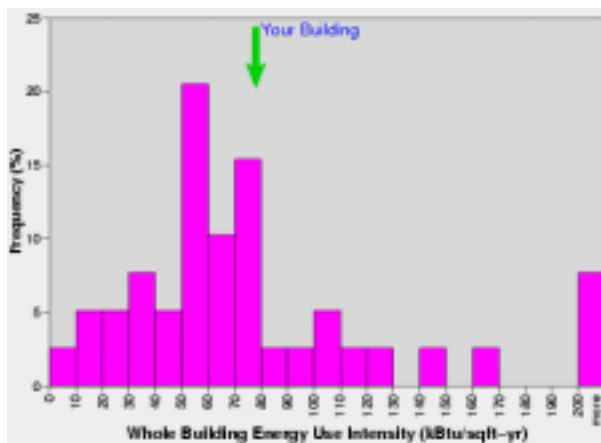

Figure 3. Whole Building Energy Use Intensity

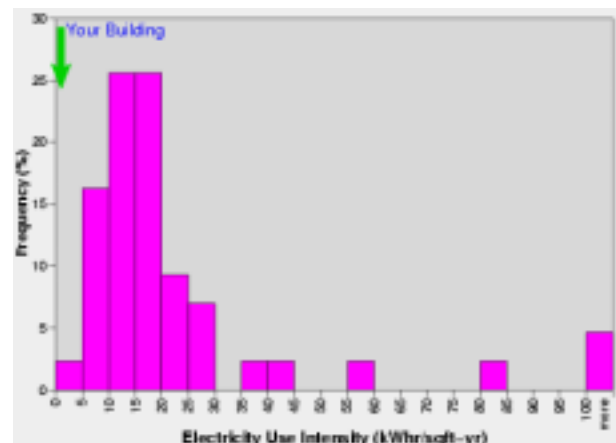

Figure 4. Electricity Use Intensity

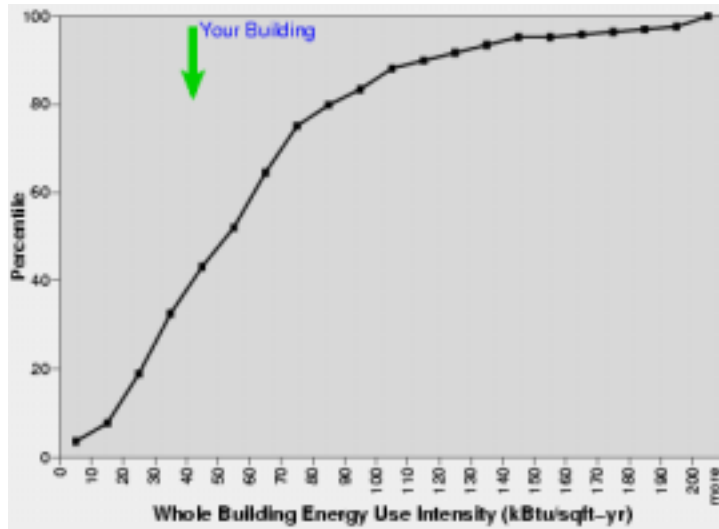

Figure 5. Histogram Of Whole Building Energy Use Intensity For A Particular Input Of Building Conditions, Location, And Energy Use.

LEGEND

Bar Color	Data Source	For further information:
	PGE	PG&E CEUS

Description of Comparison Buildings

For this field:	You entered:	Comparison Buildings
Building Type	Office/Professional	Office/Professional
Zip Code	94720	North Coast
Floor Area	100,000 ft2	
Filter by area?	No	Buildings of all sizes are shown
Site/Source	Site	Results are displayed as site energy use

Number of buildings on graphs:	Whole Bldg	Electric	Gas
	39	34	30

Continue to [Interpret Results](#) page for additional information about these results.
 Was this helpful? Please take our [SURVEY](#)

Figure 6. Building Comparisons

Figure 6 shows the buildings used in the comparisons, and shows how many buildings are included in the results.

Market Outcomes

- CEC and EPA policy influenced. This research influenced CEC and EPA policy and the use of benchmarking during the energy crisis in California.
- Cal-Arch is available to the public. It is available for public use and can be downloaded at the HPCBS website. It can be used by building owners and operators, and energy managers.
- Cal-Arch is used by professionals. Cal-Arch is regularly used at the Pacific Energy Center in basic courses on energy in buildings, and can be used by energy managers, energy information system vendors, utilities, performance contractors, and researchers and analysts.
- Updates and enhancements planned. Preliminary review of future CEUS was conducted to plan how the tool might be enhanced and updated.
- Enhancements to Energy Star Whole-Building Rating Tools. The statistical analysis in this project led to enhancements and changes to the US EPA-DOE Energy Star whole-building rating tool methodology.
- Cal-Arch was used in the Oakland Energy Partnership Program.

Significant Research Products

Cal-Arch Download

<http://poet.lbl.gov/cal-arch/>

The Cal-Arch software is available for use by the public at this site maintained by the Buildings Technologies Department of the Environmental Energy Technologies Division of the Lawrence Berkeley National Laboratory.

Development of a California Commercial Building Energy Benchmarking Database

S. Kinney and M. A. Piette

http://buildings.lbl.gov/cec/Pubs/E2_50676.pdf

This paper, presented at the ACEEE 2002 Summer Study on Energy Efficiency in Buildings, August 18-23, 2002, Pacific Grove, California, and published in the proceedings, discusses issues related to benchmarking commercial building energy use and the development of Cal-Arch, a building energy benchmarking database for California. Cal-Arch uses existing survey data from California's Commercial End Use Survey (CEUS), a largely underutilized wealth of information collected by California's major utilities. Benchmarking based on regional data can provide more relevant information for California buildings than national tools such as Energy Star. The tool can be accessed from poet.lbl.gov/cal-arch. A sample from the Cal-Arch software (Figure 7) shows how a particular building compares with similar buildings in the database output screen.

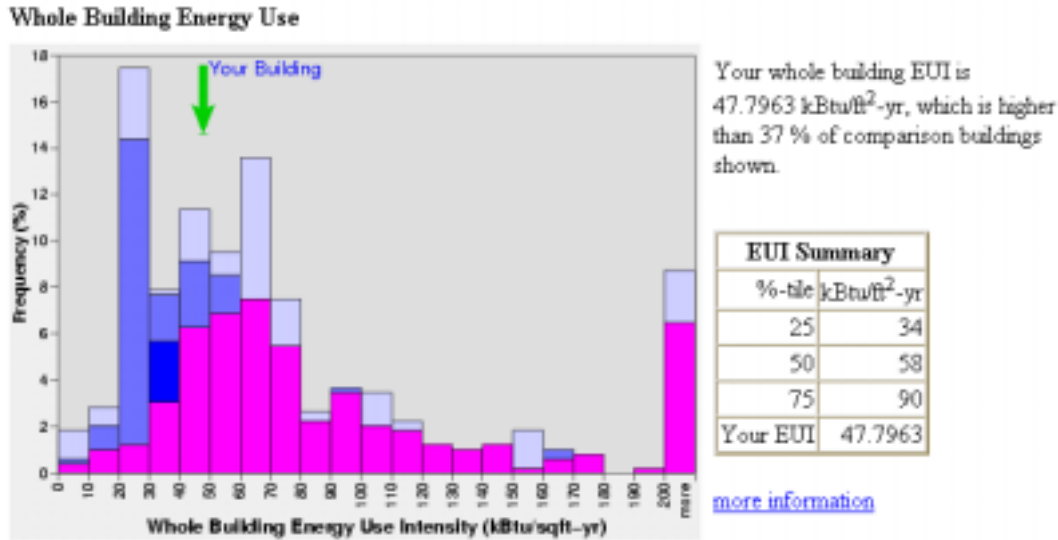

Figure 7. Sample Screen From The Cal-Arch Software

CONCLUSIONS AND RECOMMENDATIONS

Conclusions

This project successfully demonstrated that there is a need for and value in web-based benchmarking tools. A fundamental concept in energy analysis of commercial buildings is to understand how a building's energy use compares with others. Cal-Arch demonstrates that simple tools can be built that allows users to obtain this feedback.

Commercialization potential or commercialization initiated

Cal-Arch was designed to be a public product. The underlying data was collected with public funds, and that the tool and underlying data is not meant to be commercialized. Energy service companies (e.g. Silicon Energy) have seen the value in offering a benchmarking tool within their suite of software services, and special groups like schools and school energy stakeholder groups such as the Collaborative for High Performance Schools may also find energy benchmarking beneficial. Policy makers and government energy planners at both CEC and EPA used these analyses. LBNL also shared restaurant energy use data with European research collaborators.

Recommendations

The tool is currently in a simple form, and does not perform detailed normalizations for weather, occupancy, hours of use, or other confounding factors. It does, however, allow users to compare energy use of building of similar type in similar climates zones with similar size. Two workshops showed that this simple tool is easy to use and accessible to building owners, engineers, operators, energy managers and designers. LBNL has not conducted a more detailed analysis of the CEUS data because it is more than seven years old. We recommend that future work explore the use of the current CEUS to create and expand on the concepts initiated with Cal-Arch.

Proposed future work should include:

- Collaboration with California’s Collaborative for High Performance Schools (CHPS).
- Additional work with Energy Information Systems (EIS) companies.
- Future CEUS benchmarking.
- Collaboration on Energy Star.

BENEFITS TO CALIFORNIA

Energy benchmarking with Cal-Arch is a good starting point for building owners and managers to evaluate how their building’s energy-use intensity compares with other buildings in California. Simple energy-use intensity comparisons are an important initial step to assess energy savings potential. Cal-Arch provides a direct comparison with actual data from related California buildings.

2.2. Prototype Performance Metrics Tracking Tool (Metracker)--(Element 2, Project 2.2)

INTRODUCTION

Background and Overview

Buildings often do not perform as well in practice as expected during pre-design planning, nor as intended by design. Current building design, construction, and operation practices are devoid of quantitative feedback that could be used to detect and correct problems both in an individual building and in the building process itself. A key element in this situation is the lack of a standardized method for documenting and communicating information about the expected and actual performance of a building across its life cycle.

The overall objective of this task is to develop a prototype tool capable of demonstrating a standardized method of specifying, tracking, and visualizing building performance objectives and their associated metric data across the life cycle of a building. A preliminary prototype was developed by LBNL under funding support from the U.S. EPA.

OBJECTIVES

The overall objective of this task is to develop a prototype tool capable of demonstrating a standardized method of specifying, tracking, and visualizing building performance objectives and their associated metric data across the life cycle of a building. A preliminary prototype was developed by LBNL under funding support from the U.S. EPA.

APPROACH

- Elaborate an envisioned scenario for tracking performance metrics in a manner that improves and assures actual building performance across its life cycle.
- Develop a data model for building performance metrics that is consistent with the Industry Foundation Classes (IFC), developed by the International Alliance

for Interoperability (IAI), and is both robust and flexible enough to archive and exchange metric data in their many forms.

- Implement the data model in software to illustrate the key concepts of archiving, sharing, and tracking expected standard building energy performance metrics so that various participants can consistently interpret and apply them across the building life cycle.
- Explore related building performance frameworks that provide a larger context within which energy performance metrics fit.
- Relate this work to other ongoing efforts in the building performance metrics area.

OUTCOMES

Technical Outcomes

- A final Metracker prototype tool was developed for defining and tracking performance metrics across the building life cycle. Figure 8 shows a comparative graph of multiple performance metric data sets of Whole Building Energy Use. This prototype is available for download from the HPCBS website.
- A report on Standardized Building Performance Metrics was written and widely distributed. This report increased exposure of performance metrics to key building industry participants.

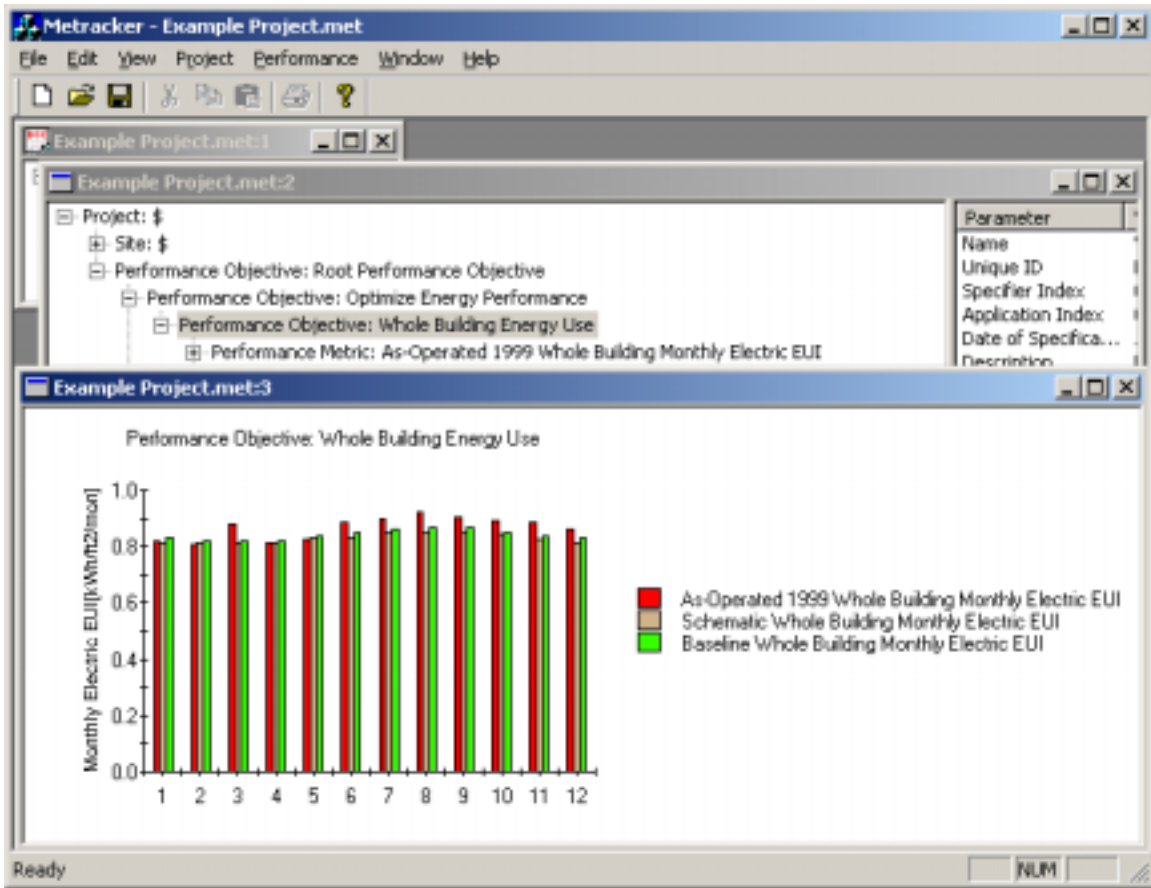

Figure 8. Sample Screenshot From Metracker

Market Outcomes

Commercialization and collaboration discussions were initiated and continue with several potential partners who are interested in either using Metracker in demonstration pilot projects, or modifying Metracker for use in their existing and evolving software toolboxes.

Significant Research Product

Metracker Prototype Software. Metracker is a prototype computer tool designed to demonstrate the specification, tracking, and visualization of building performance objectives and their associated metrics across the complete life cycle of a building. The underlying concept is that, to better assure the intended performance of a building, it is necessary to establish a baseline for expected performance and periodically compare actual performance to this baseline. This process requires a standardized yet flexible format for archiving performance data, and sharing these data between various software tools and their users across the building life cycle. Ideally, these performance data are archived with, and related to, other information about the building. To these ends, Metracker is based on the Industry Foundation Classes (IFC) data standard developed

by the International Alliance for Interoperability. The direct software download is available at: http://buildings.lbl.gov/hpcbs/Element_2/Metracker/metracker-reg.php

Standardized Building Performance Metrics Final Report (R.J. Hitchcock): This LBNL report gives a detailed description of the concepts underlying a data model for performance metrics and its use in tracking building performance across the project life cycle. The report also focuses on the issue of standardizing specific energy-related performance metrics to assure consistent application of these metrics within an individual project and across the diverse stock of building facilities. Several existing building performance frameworks are reviewed to provide a broader context within which these energy-related performance metrics can be defined. Specific sets of energy-related performance metrics are presented in a hierarchically organized format as candidates for standardization. The report concludes with a discussion of related work that further illustrates applications of this research that lead to market connections. This report is available for download from the HPCBS website at: http://buildings.lbl.gov/hpcbs/Element_2/pdf/Standardized_Metrics_Report.pdf

CONCLUSIONS AND RECOMMENDATIONS

Conclusions

The development of Metracker served several learning purposes including experimentation with the Performance Metrics data model, addressing software implementation issues on both the Windows and Internet-Browser platforms, and providing a demonstration platform for discussions with industry. This experience led to the following conclusions:

The data model must be kept simple at this point to allow straightforward implementation and demonstration.

Industry is beginning to recognize the benefits of performance metric tracking, but is not yet ready to embrace the more complex concepts behind the data model such as documenting design intent through relationships between expected performance targets and specific building elements selected to achieve these targets.

A web services implementation of Metracker would make the software much more accessible to pilot project team members and others interested in exploring its application, and would encapsulate the performance metric standards in reusable software modules.

Pilot demonstrations of performance metric tracking on real-world projects are required to better understand and apply the tracking process to real projects, and to raise the visibility and credibility of this process within the industry.

Commercialization potential or commercialization initiated

Commercialization and collaboration discussions have been initiated and continue with several potential partners including US GSA Region 9, Nexant in Boulder, CO, and Olof Granlund Oy of Finland. LBNL is currently working with US GSA Region 9 to explore the migration of Metracker to the web in support of GEMnet.

Contacts made through dissemination of the Standardized Building Performance Metrics report include technical committees of ASHRAE, the National Renewable

Energy Laboratory, the Athena Sustainable Materials Institute in Canada, and graduate students at the National University of Ireland Cork. Discussions with these contacts continue to identify common areas of interest that could lead to commercialization and/or further publication and dissemination of the concepts developed by this task.

Recommendations

It will be necessary to undertake pilot demonstrations of performance metric tracking on real-world projects such as one proposed by Nexant as part of their support of the Xcel Energy Recommissioning Program in Colorado.

Research should continue into the standardization of performance metrics both in their definition (e.g., name and units of measurement) and in their data manipulation (e.g., methods of collection, calculation, and comparison).

The Metracker software, or a derivative, should be migrated from a standalone Windows implementation to an Internet browser accessible implementation (i.e., web forms and web services) to support the above activities.

BENEFITS TO CALIFORNIA

The work to date that has been done under this standardized performance metrics tracking topic has been largely generic in nature. For example, the data model for building performance metrics was developed to support the archiving of any and all performance metric types (e.g., energy-efficiency; environmental impact; life-cycle economics; occupant health, comfort and productivity; and building functionality, adaptability, durability, and sustainability). The review of international efforts to develop building performance frameworks was likewise intended to be global and all encompassing in nature. Similarly, the Metracker prototype supports this flexible data model in a generic manner.

Specific benefits to California from this research have only begun to accrue from a focus on standardizing specific performance metric sets related to energy and environmental impact issues of critical interest to the state, and from commercialization efforts initiated with California-based facilities such as GSA Region 9 in San Francisco. These two activities will need to further progress to realize the potential benefits within California buildings.

2.3. Benchmarking Performance Assessment for Small Commercial Buildings-- (Element 2, Project 2.3)

INTRODUCTION

Background and Overview

The intent of this project is to determine how a small sample of people involved in operating buildings can make use of benchmarked energy-consumption data. To elaborate, until very recently benchmarking data have been the province of energy analysts and not those who operate businesses and pay energy bills. Examples of such data include the surveys of residential and commercial buildings performed by the U.S. Department of Energy's Energy Information Agency (EIA). As part of Element 2, other researchers (at LBNL) have developed a Web-based benchmarking tool, Cal-Arch, that

will permit a user to compare an energy-use intensity (EUI, annual energy consumption normalized by floor area) to the consumption of similar buildings. For this project, the focus is on building owners. Are they interested in benchmarks? How will they use them? Are they interested in sharing energy information with others in similar positions, as a means of comparing notes and determining further steps to control energy costs?

A second but still crucial element of this work is the application of advanced technology to obtain energy information at selected sites. To compare energy consumption at a particular building to an EUI-based benchmark requires nothing more than a year of energy bills. The user of a benchmarking tool then must assess why the EUI for the site in question differs from that of supposedly comparable buildings. Longer hours of operation? Special equipment? More widgets produced? Not yet able to afford an overdue lighting retrofit? End-use information can be used to pinpoint areas of relatively high energy consumption. However, in small non-residential buildings (retail, restaurants, schools), obtaining end-use information or even time-of-use whole-building information requires metering not typically installed. The cost of such metering is widely perceived by energy analysts to be a barrier. It is not clear that the additional information would in fact be effectively used, in ways that would generate savings that would provide a decent return on the metering investment.

MIT is developing a high-speed meter capable, at least in some cases, of disaggregating a measured electrical current into components that can be assigned to particular pieces of equipment. This Non-Intrusive Load Monitor (NILM) is intended to provide not only time-of-use information at the measurement point (whole building or a major portion of particular interest) but also provides some amount of information about equipment operation, including on/off cycling, an estimate of energy use, and detection and possibly diagnosis of equipment faults, at a cost less than traditional monitoring.

OBJECTIVES

- Evaluate alternative methods to provide energy bill payers with useful metrics that will encourage comparison of their energy use with that of others.
- Consider three sources of data: whole-building billing data, time-of-use data, and high-resolution data from prototype, centrally installed meters.

APPROACH

The following subtasks were performed:

- Identify a small group of bill-payers.
- Identify appropriate metrics for whole-building site energy usage.
- Install high-speed electric meters (non-intrusive load monitor, or NILM) at selected sites.
- Assess the usefulness of the data from the meters.
- The West Contra Costa Unified School District, with 49 schools, was selected for investigation after consideration of small commercial buildings and a three-campus community college.

OUTCOMES

Technical Outcomes

- Benchmarking metrics were developed with data provided by PG&E and shared with school officials and PG&E.
- Four NILMs and three electricity data loggers were installed in two schools and used to assess a lighting retrofit and night cooling. The data were also used to evaluate end-use loads such as identifying resistance heating within the whole building load shape. The NILM in its current form is too complex to be used in K-12 schools.

Market Outcomes

Identification of a demand, on the part of officials of the targeted K-12 school district, for suitably packaged energy information. The investigators consider the school district to be typical in this respect and assert that there is a substantial market for well-priced and timely energy information.

Significant Research Product

Presentations were made for school officials and for PG&E. Further, presentations were made at two Rebuild America workshops for school officials, in San Francisco and in Chico, in October 2002.

A detailed final report is available on LBNL's HPCBS website.

Tests of the NILM for detecting air-conditioner faults will be published in the ASHRAE literature when completed later in 2003.

As part of this project and others supported by CEC, NILM hardware and software were substantially advanced, to the point where it is feasible to work with a potential commercializer.

CONCLUSIONS AND RECOMMENDATIONS

Conclusions

This project showed that K-12 school districts can make good use of energy-consumption data but are not well suited in general to perform even rudimentary analyses needed to transform raw data into useful information. The benchmarking metrics developed as part of this project – whole-building site energy use (gas and electric) and cost, and data normalized by floor area and number of students – showed clear distinctions between elementary, middle and high schools and revealed the presence of outliers that deserved priority attention in school-modernization efforts. Data formats were shared with the data provider – PG&E – as a means of influencing how data are presented to customers. Energy data appeared to be more useful than EPA Energy Star rankings, which were computed for the schools and which were generally very high.

More detailed metering was useful in assessing the benefit of a lighting retrofit in one middle school. Due to the large number of loads on the electrical panel serving the retrofitted classroom, it was necessary to use conventional data logging to measure the reduction in power, rather than the NILM. A NILM on a panel serving three

classrooms at an elementary school was capable of detecting the use of roof-top packaged air conditioners. Data from the NILM (supplemented by submeters in the research phase but not necessary in practice) showed that ventilative cooling at night, previously explored by a school official, led to increased energy consumption on many nights due to extensive fan energy usage. The NILM appears to be a suitable meter for conducting trial-and-error experiments because it provides useful and rapid feedback of changes in energy use.

The NILM was also used in an off-site laboratory to test its ability to detect faults in roof-top air conditioners. These preliminary tests showed good results. For eventual commercial use in this application, the NILM would need to be reduced to an inexpensive single-board computer associated with a single air conditioner, or be shown to be effective in detecting faults in small clusters of air conditioners served from a single electrical distribution panel.

Commercialization Potential Or Commercialization Initiated

There are two products of commercial value in this work: a benchmarking tool and the high-speed power meter. A benchmarking tool for school districts would appear to be useful and valuable, if it can be used by school officials with an absolute minimum amount of data entry (see recommendation below). In lieu of a general-purpose tool, it may be better to develop a benchmarking tool just for K-12 schools, or at least have such a focus as a subset of a more general tool. Such a tool should have as much data as possible about the schools pre-entered and subsequently updated as necessary. Local utilities or energy-service companies could establish the necessary data bases. Energy-service companies are now selling services that process energy data to produce useful information to commercial customers, notably owners of large commercial buildings or large numbers of smaller buildings. Such companies might consider K-12 school districts as potential customers.

The second commercialization opportunity concerns the NILM. Commercialization is now being pursued with an energy service company, again with large-commercial buildings as an initial target.

Recommendations

It appears necessary to package energy information for school officials and their contractors, who have little time to process billing data or examine time-of-use energy plots. Any given district may employ someone with the skill and enthusiasm to do such work, but such situations may be an exception. NILM data may be more valuable to a service provider – perhaps a contractor that maintains roof-top units – than to a school district directly.

BENEFITS TO CALIFORNIA

As noted by an official in the targeted school district, there is a need for districts to monitor the energy impacts of new construction, major renovations, and energy-efficiency retrofits. The type of benchmarking comparisons developed for this task can aid in such energy tracking.

Performance monitoring of roof-top air conditioners, using service tools under development by the investigators of this task and by others, should reduce the costs for energy and equipment service associated with space cooling.

2.4. Retrofit Tools--(Element 2, Project 2.4)

INTRODUCTION

Background & Overview

Non-residential building retrofits offer an enormous potential for energy savings in existing buildings. Properly designed retrofit projects, in order to cost-effectively maximize this potential, require a quantitative analysis, usually in the form of a computerized tool. To this end, in the early 1990's the federal government supported the development of the Retrofit Energy Savings Estimation Method (RESEM) tool as a public-domain resource, both for benchmarking other tools and as an extensible code resource for other developers.

OBJECTIVES

- Develop an updated version, RESEM-CA that has features customized to California specifics with regard to commercial building stock types and equipment, weather, utility rates, and preferred retrofit strategies (Energy Conservation Opportunities). Like its federal predecessor, RESEM-CA is intended to be used for individual retrofit project analyses, as a benchmark for private sector, proprietary tools, and for state-wide savings potential analysis to identify preferred Energy Conservation Opportunity (ECO) strategies.

APPROACH

The approach to this task was the following:

- Improve and extend the capabilities of a previously existing retrofit analysis tool, based on a set of specifications developed to reflect California-specific needs and conditions. Validate the core simulation engine.
- Identify potential sources of information for prototypical buildings, ECOs, weather data, and utility rates, and design external database structures suitable for storing and linking this information into RESEM-CA analyses.
- Relate this work to other ongoing efforts in the ESCO and utility arena and articulate a commercialization strategy.

OUTCOMES

Technical Outcomes

- The RESEM-CA software tool was modernized, extended and validated according to plan.

The results of the validation study confirmed that RESEM-CA is a sufficiently accurate tool to be suitable for retrofit analysis.

- A design approach for linking external information using commercial object-oriented database technology was prototyped, and a set of data resources was developed.

Market Outcomes

A market deployment strategy was articulated and some initial steps informally taken.

The Technical Advisory Group provided valuable suggestions in strategizing how to explore outside interest in use of and possible adoption, sale, and support of the tool (or modules from it). More comments on possible ongoing market outreach efforts are discussed in the recommendations section.

Significant Research Products

RESEM-CA: Validation and Testing.

V. Pal, W. L. Carroll, and N. Bourasssa.

<http://buildings.lbl.gov/hpcbs/pubs/E2P22T2b-LBNL-52003.pdf>

This report documents the validation of RESEM-CA electrical and gas energy consumption calculations to determine the effectiveness of this tool for retrofit design and analysis. The analysis compares patterns of monthly and annual energy consumption as calculated by RESEM-CA and by DOE2.1E and tries to explore and/or explain the differences, if any. In most cases there is substantial agreement in the results of RESEM-CA and DOE2.1E. In cases where there are differences, there is potential to improve agreement with minor algorithmic changes without compromising the speed of the RESEM-CA tool that is necessary for extensive parametric retrofit analysis. A spreadsheet-based tool was developed to facilitate and document the results of the extensive comparison analysis.

RESEM-CA: The final software will be available at <http://eetd.lbl.gov/btp/resem.htm>.

CONCLUSIONS AND RECOMMENDATIONS

Conclusions

The RESEM-CA tool technical capabilities have been demonstrated to be able to quantitatively analyze the cost and energy impacts of different candidate ECO options and to identify the optimum ECO combination package for a project. This is its core intended function.

Commercialization potential or commercialization initiated

RESEM-CA could serve as a public-domain benchmark for other tools or for broad potential studies intended to develop general retrofit design guidelines by either public entities or utilities. In addition to providing the tool as a complete packaged single-entity executable program, making the various functionalities (e.g. core simulation engine, ECO identification and ranking, etc.) available as individual modules is do-able and advisable. The migration of RESEM-CA to the web services environment is an attractive possible approach to accomplishing that end. The recommendations immediately following also address this issue.

Recommendations

Identifying data sources (building prototypes, ECO characteristics, performance, and cost, weather, utility rate schedules) necessary for linking to RESEM-CA to complete a retrofit analysis is a challenging issue. While a number of sources were identified, they are scattered, in different formats, and may even be private. It may not be feasible to try, by some centralized entity, such as the CEC or a utility, to collect this information and package it for use. A better approach would be to publish the database schema developed for RESEM-CA, which are based on commercial object-oriented database software products that are widely used for this purpose. It is hoped that dissemination of these schema will motivate the owners of such data to develop databases based on the desired specifications and make them available for other RESEM-CA users, based on their potential commercial value to such users. If the use of the tool is desirable enough to create a market for the information in this specific form, user demand should stimulate this response.

Opportunities should be explored to integrate RESEM-CA with other tools. Specifically, two related synergistic ideas with respect to Cal-Arch are: (1) Cal-Arch could serve as the interface and mechanism for forming the abstract prototypical building templates that RESEM-CA needs from its core CEUS data. (2) RESEM-CA, on the other hand could produce in real time a quantitative prediction of the expected energy performance improvement and economic savings from the LCC-optimal ECO retrofit package for the building a user was benchmarking in Cal-Arch. Even further – RESEM-CA could also compare the improvements expected from the retrofit package for the specific building to the average and / or 90% range of expected improvements for the aggregated class of cohort buildings in the Cal-Arch database.

BENEFITS TO CALIFORNIA

There are tremendous economic, societal, and environmental benefits in making the California building stock as energy efficient as is feasible. Widespread use of RESEM-CA, or derivatives of it, have the potential of not only identifying significant energy savings through building retrofits, but realizing those benefits in the most cost-effective way, thus freeing energy conservation project capital for other, competing uses. Optimal retrofits guarantee that not a dollar more than should be spent on building retrofit activity will be spent on it. RESEM-CA provides the right quantitative information to make that possible.

2.5. Improving Building Energy Performance Simulation with Software Interoperability--(Element 2, Project 2.5)

INTRODUCTION

Background and Overview

Direct data exchange between two or more heating, ventilation, and air conditioning (HVAC) software tools is possible today only if such tools are integrated or the exchange mechanism (i.e. the interface between the tools) is dedicated. Direct exchange among market leading HVAC “stand-alone” tools used on the same industry project is currently not possible.

The same types of data are often formulated differently by different tools, which result in data format incompatibility. When data exchange is needed, the “exchange” amounts to manual or manually assisted data transformation and entry, a process that is repeated for each tool used in the project. This usually results in very costly errors, omissions, miscommunication and time delays, the investigation of few alternatives, high cost of tool deployment, and in general a very poor return on investment in the use of tools.

In an effort to provide a fundamental and universal solution to the problem of data exchange in the building industry, the International Alliance for Interoperability (IAI) developed an open, intelligent and comprehensive data model of buildings that covers the building life cycle: Industry Foundation Classes (IFC). The October 2000 “platform” release of the data model (IFC2x) included rudimentary HVAC definitions. These allowed only very basic definitions of a few mechanical equipment types and were not intended to support rich data exchange among HVAC tools.

OBJECTIVES

Develop an IFC data model extension that defines HVAC components in buildings in detail and provides a framework for seamless data exchange among software tools that support the design, selection, definition, installation and operation of HVAC equipment and systems.

The extension model targets data exchange among design tools such as HAP and Trace, energy performance simulation tools such as EnergyPlus and COMPLY-24, air-flow simulation tools such as COMIS and CONTAM, manufacturers’ databases, cost-estimating tools, performance metrics tools, facilities management tools, or any other tool that employs definitions of HVAC components. Figure 9 illustrates the range of industry tool types that can use the model.

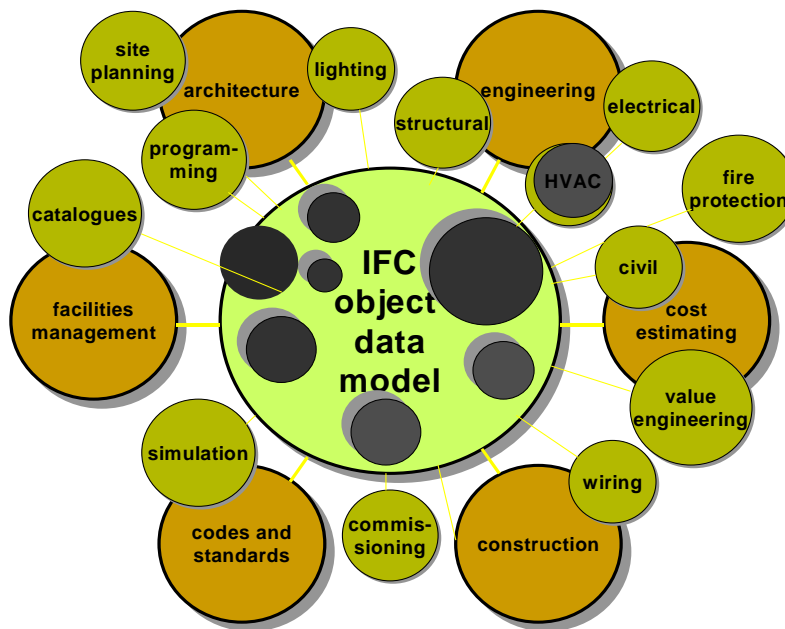

Figure 9. IFC Object Data Model

APPROACH

The work methodology followed the following steps:

- Based on EnergyPlus architecture, define an exhaustive spreadsheet of HVAC object/attribute/relationship sets.
- Have leading industry professionals and associations, such as ASHRAE, review the spreadsheet, adjust/correct and expand it.
- Translate the sets in the spreadsheet into EXPRESS object-oriented modeling language and formulate the corresponding IFC model extension.
- Integrate the extension schemata with the IFC core model, and make them an integral part of the new IFC2x2 release.

OUTCOMES

Technical Outcomes

- The IFC HVAC model extension was completed and integrated in the latest version of the IFC data model of buildings, IFC2x2.
 - ▶ The IFC2x2 data model was released worldwide to the public in May 2003.
 - ▶ Its potential use and benefits were demonstrated in a pilot exchange between a building energy simulation tool (EnergyPlus) and a duct design tool (MagiCAD) in September 2002. The demonstration showed that IFC based data exchange can facilitate energy savings and improve the quality of design, simulation and analysis. The image below is a computer generated “see-through” view of the small bank building and its HVAC system and equipment that was used as the subject in the pilot exchange of HVAC data.

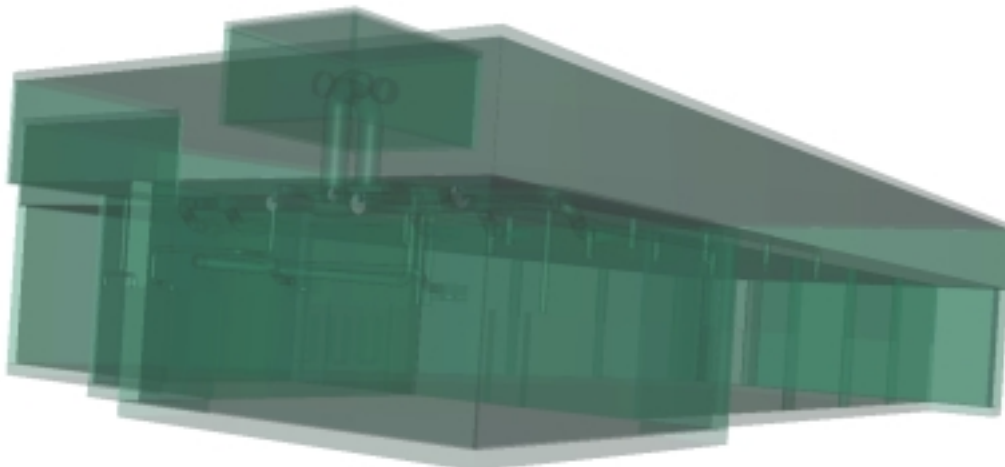

Figure 10. Computer Generated “See-Through” Of The Small Bank Building And It’s HVAC System And Equipment

- The developed extensions facilitate the seamless importing of information from upstream applications and databases (such as general definitions and performance specifications of HVAC equipment and furnishings) into energy performance simulation tools like EnergyPlus and COMPLY-24 when they become IFC-compatible. They also facilitate the seamless exporting of generated information to downstream tools, such as commissioning, performance metrics and facilities management tools.
- The IFC data model of buildings and its HVAC extension schemata constitute an agreed upon set of rules, regulations and protocols on how to exchange specific data among participating software tools. (IFC2x Platform is now an ISO/PAS standard; it is the only data model of buildings that is a recognized international standard.) The exchange of data that can be or need to be shared among IFC-compatible tools now can be “seamless” It takes place electronically without direct intervention and/or manipulation of exchanged data by the tool user(s). The seamless import/export of HVAC data eliminates the need to manually reenter the same data into each successive design, simulation and/or analysis tool used. In turn, this eliminates needless and costly repetition of tasks, minimizes opportunities for mistakes and misunderstandings, and expedites the productive use of tools. All of that leads to much more cost-effective use of tools like EnergyPlus and COMPLY-24, more in-depth investigation of more alternatives, and makes the return on investment in the use of tools for design, simulation and analysis potentially much higher than it is today.
- Objective not met: Development of a rich model of HVAC control systems. The developed controls schema is limited to the model of controls definitions in EnergyPlus. It was not possible to define a more comprehensive model, because (for market and proprietary reasons) it was not possible to forge agreement among market leaders in HVAC controls systems.

Market Outcomes

- The availability of the IFC HVAC extension spurred the creation of the IFC HVAC Implementers’ Round Table which includes a number of leading HVAC software developers working together in the implementation of the new extension in their tools. Examples of participating developers from different industry disciplines include cost estimation, HVAC manufacturing, design and simulation, and computer aided design (CAD).

Significant Research Products

Improving Building Energy Performance Simulation with Software Interoperability. V Bazjanac. Proceedings of Building Simulation 2003 Conference, Eindhoven.
<http://buildings.lbl.gov/hpcbs/Pubs.html>

This paper for the Building Simulation 2003 Conference in Eindhoven, The Netherlands (August 11-14, 2003) details the contents of the HVAC extension of the IFC model. It also describes the new functionality of the IFC data model achieved with the extension, and how to get involved with software implementation of the model.

EXPRESS Code of the IFC2x2 Integrated Data Model of Buildings
http://iaiweb.lbl.gov/bs8/documents/BS-8_Model/

This project has extended the Industrial Foundation Classes (IFC) schemata to support the modeling of heating, ventilation, and air conditioning components and systems in various IFC-compatible building energy performance simulation and HVAC design tools (such as EnergyPlus and HAP), as well as HVAC manufacturers' equipment. The extended HVAC schemata were integrated into the latest release of the IFC data model. The extension schemata are defined in EXPRESS file format in file BS8Express_15Jun02.zip.

CONCLUSIONS AND RECOMMENDATIONS

Conclusions

This project successfully completed HVAC definitions in the IFC universal data model of buildings. In addition, it provided IFC definitions for capturing time- dependent data and connections among equipment and parts. The September 2002 demonstration showed that the on-line exchange of data between design and simulation tools could dramatically speed up the design and significantly improve the accuracy of building energy performance simulation.

Commercialization Potential Or Commercialization Initiated

Software developers are now implementing these definitions in software and/or databases that need information about HVAC systems and/or equipment. The IFC HVAC interface to EnergyPlus, now in development, will enable direct HVAC data exchange with other HVAC design, simulation and analysis tools that are IFC-compatible. In addition, it will allow direct import of equipment data and specifications from HVAC manufacturers' databases that are IFC-compatible.

Recommendations

The work on the IFC data model, and specifically on its HVAC extensions, needs to continue. A comprehensive and detailed model of building (and HVAC) controls should be developed as soon as possible. It will standardize the definitions of such equipment and systems, enable seamless exchange of such data, and eventually result in better designed and deployed systems that will increase energy efficiency in buildings.

Support is needed to test IFC-compatible HVAC tools. IFC interfaces must be robust; they need to be extensively tested, and no program for such testing is in place yet. Additional support is also needed to deploy IFC-compatible HVAC tools. End users will need help to start using these tools, and no such support program is in place yet.

BENEFITS TO CALIFORNIA

The building industry is beginning to change its work process. This change is only going to escalate, and it will eventually have a profound impact on the economy (the building industry is the second largest sector of the U.S. economy). The new technology (i.e. a common comprehensive data model of buildings shared by intelligent interoperable tools) will have a similar impact on the energy sector of the building industry: By experimenting (with virtual buildings) before construction and operation, it will be possible to define truly optimal designs and/or selections that will save more energy in buildings than before.

Potential benefits for the California building industry include easier use of simulation tools, therefore more detailed energy studies during design projects. Savings of 5 – 10% whole building energy use could be achieved.

3.0 Element 3 Lighting, Envelope, and Daylighting

INTRODUCTION

Electric lighting is the largest single load in California commercial buildings, typically consuming nearly 40% of electric energy. Because of the State's Title 24 building code, California has led the nation in improving the efficiency of commercial building lighting. By replacing older fluorescent lighting systems with electronic ballasts and T-8 fluorescent lamps, ratepayers have saved over \$100 million in avoided energy costs. Despite these improvements in equipment efficiency, lighting energy is still squandered because it is not managed effectively. Previous research indicates that lighting controls have great potential to further reduce lighting energy consumption through a variety of strategies, including 1) use of photosensors to integrate daylight and electric light, 2) use of occupancy sensors and scheduling to reduce lighting of unoccupied spaces and 3) providing occupant control of local lighting that can reduce lighting energy consumption by 35% compared to an already efficient electronic ballast system. The daylighting strategies must be fully integrated with envelope design to avoid the risk that increased cooling loads from windows will reduce the apparent lighting energy savings. Furthermore both daylighting-envelope selections and lighting design solutions can enhance or exacerbate comfort and amenity in a space, thus influencing occupant performance and satisfaction with the space. The goal is to create a new generation of improved controls that provide the user with improved control of many of the indoor luminous and thermal environmental parameters in a manner that saves energy, manages electric load and enhances the indoor environment.

OBJECTIVES

The overall technical goal of this program element is to develop an integrated building equipment communications (IBECS) network that will allow appropriate automation of lighting and envelope systems to increase energy efficiency, improve building performance, and enhance occupant experience in the space.

This network will provide a low-cost means for occupants to control local lighting and window systems, thereby improving occupant comfort, satisfaction and performance. A related goal of this program element is to improve existing lighting control components and accelerate development of new daylighting technologies that will allow daylighting to be more extensively applied to a larger proportion of building floor space.

The technical objectives are:

- A cost-effective whole-building communications network that will enable building-wide management as well as occupant-based control of dimmable lighting and building envelope systems.
- A cost-effective, dynamic lighting and envelope system that will support commissioning, O&M, and diagnostics on a whole-building level and effectively achieve end-user and facility management objectives.
- Algorithms to aid commissioning of dynamic envelope and lighting components from a centralized control system.

- Whole-building diagnostics routines that will facilitate troubleshooting of dynamic envelope and lighting component failures from a centralized control system.
- Cost-effective daylighting systems and strategies that optimize daylight admission and minimize cooling load impacts using commercially-available and advanced fenestration technologies.

The economic goal of this element is to achieve lighting-related electricity consumption savings of 59% in new construction and 43% in major retrofits by 2015.

The specific cost objectives are:

- Added cost for the network interface shall be less than \$1 per control point, where a single point is defined as a single addressable device (i.e. individual ballast or sensor).
- Added cost of the microLAN bridge will add no more than \$0.25/point to the above costs (assuming the bridge addresses 200 devices).
- Reduce overall system costs and quantify the energy and non-energy benefits so that dynamic lighting and envelope systems are routinely specified.

IBECS network architecture configured to operate legacy 0-10 VDC analog ballasts and light switches, and to read connected sensors and meters (Figure 11.) We conceive of a future where the network interfaces would be built into building equipment products and “IBECS-ready” ballasts and switches would incorporate a network jack (similar to Ethernet). Providing network connectivity to lighting and other building equipment will bring about a complete change in how building energy systems are commissioned, operated and maintained.

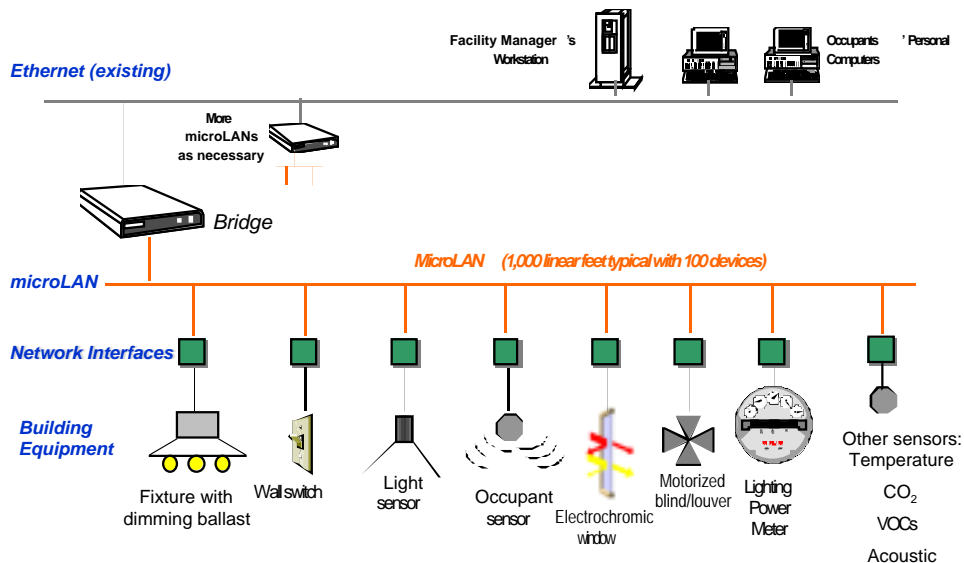

Figure 11. IBECS Network Architecture

Project Team and Technical Advisory Group (TAG)

Element 3 was lead by Francis Rubinstein of the Lawrence Berkeley National Laboratory, with Vistron as a subcontractor. Significant contributors to this element included:

- J. Galvin (LBNL)
- D. DiBartolomeo (LBNL)
- P. Pettler (Vistron)
- E. Lee (LBNL)
- J. Jennings (LBNL)

The Technical Advisory Group (TAG) included:

- Wayne Morrow (Starfield Controls)
- Rora Viela (WattStopper)
- Dale Tiller (University of Nebraska)
- Peter Sieck (AFG Industries (OCLI))
- Agrawal Anoop (Schott Donnelly LLC)
- Bryan Greer (SAGE Electrochromics)
- Mike Barford (MB Associates)

3.1. Lighting Controls--(Element 3, Project 3.1)

INTRODUCTION

Background and Overview

The types of lighting controls available today are insufficient to meet the control and energy management needs of the commercial building sector. Integrated controls are needed that enable local and global energy-efficient operation of building lighting systems and components.

OBJECTIVES

- Design, build, and test the Integrated Building Environmental Communications System (IBECS) networking system and control device interfaces.
- Develop working prototypes of advanced multi-functional sensors and power-metering devices that support the IBECS network.

APPROACH

- Develop IBECS ballast network interfaces that would allow control of 0-10 VDC dimming ballasts from the IBECS network.
- Design and fabricate an IBECS-enabled wall switch to fit in a standard wall box, provide bi-level switch control (Title 24 compliant) and be controllable (addressable) via IBECS.

- Create an IBECs-ready environmental sensor capable of measuring key environmental variables (occupancy, light level and temperature).
- Demonstrate the benefits of installing sub-meters at the branch circuit level for purposes of monitoring, verification and building code compliance, using inexpensive IBECs-ready meters.

OUTCOMES

Technical Outcomes

- Key IBECs network components were developed. We successfully developed working prototypes of the ballast network interface, IBECs-enabled wall switch, advanced sensor, and lighting panel meter.

LBNL produced an IBECs ballast/network interface (Figure 12) that incorporates a digital potentiometer to dim a 0-10 Volt ballast over the ballast control circuit. The microLAN is daisy-chained to the interface using the two RJ-45 network jacks. The cost of the interface to OEMs is estimated to be \$1.

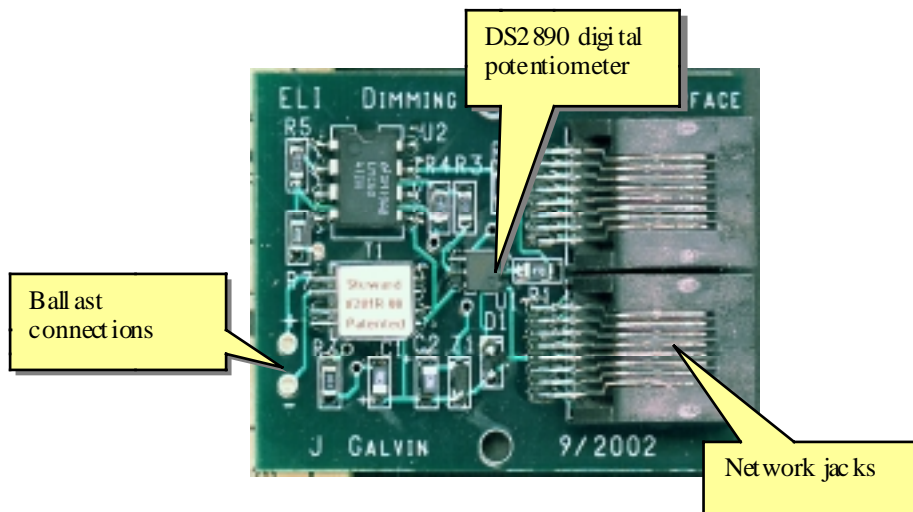

Figure 12. IBECs Ballast/Network Interface

The IBECs Addressable Power Switch, Figure 13, in a final product would be embedded in a standard wall switch. An IBECs-ready wall switch would function as a regular wall switch but would add the significant capability of allowing the wall switch load to be switched off remotely via IBECs.



Figure 13. IBECS Addressable Power Switch

Prototype workstation multisensor (Figure 14) designed to measure desktop illuminance, temperature and occupancy. This workspace multisensor measures the three key environmental variables and outputs this digital data onto the IBECS network. The Multisensor is designed to be mounted near the primary work area and plugs into a port adaptor that is attached to the serial port on the user's PC.



Figure 14. Prototype Workstation Multisensor

IBECS RMS Current Monitor showing split-core transformer in Figure 15 is shown opened for illustrative purposes. To install, the conductor carrying the current to be measured is placed in the transformer and the cover snapped shut. The black cable is standard Telco cable (4 conductor, RJ-11 terminator) and plugs into the IBECS network.



Figure 15. IBECS RMS Current Monitor

- Demonstration IBECS network was established at LBNL. To allow us to properly test these devices in a realistic field environment, we have developed a fully-configured IBECS network that is installed in Building 90-3111 at LBNL. The refined ballast network interfaces have been installed in the 7-office as well as the network cabling. The demonstration network employs a full range of IBECS-compatible technologies for lighting, automated blind systems, sensors and power measurement as developed under the CEC/PIER work. Occupants are able to control their overhead lights and motorized blinds via the internet.

Market Outcomes

- Established connections with ballast and controls manufacturers. Two ballast manufacturers have indicated they intend to add IBECS technology to their new ballasts. In addition, we are negotiating with a manufacturer of digital lighting networking products to embed the IBECS ballast network interface in their network connector. Finally, we are working with a California controls firm to embed the IBECS technology in their occupancy sensors and daylight control photosensors.
- Verified compliance with IEEE standards. The IEEE 1451 Standard on Sensors and Actuators has adopted for its reference protocol the same digital communications protocol (1-Wire™ communications protocol from Dallas Semiconductor) used by the IBECS system. Since IBECS components use the same protocol, IBECS actuators and sensors are already compliant with the IEEE 1451 Standard. IEEE 1451, which is being actively developed by and for the large sensor and measurement industry, is backed by the IEEE, a non-profit, technical professional association of more than 377,000 individual members in 150 countries.

- Completed installation of the IBECS demonstration network. The IBECS network build-out and systems testing serves as a demonstration site for potential industrial partners to evaluate the technology and its functionality. Outside parties will be able to observe the system performance in real-time using a secure web link.
- Developed work proposal for PG&E to fund demonstrations of the IBECS system and components as part of their Emerging Technologies Program. LBNL proposes to field test room-based lighting control systems based on the IBECS concept at selected PG&E offices. The prototype systems would allow individual users to select overhead light levels according to personal preference using a tailored computer control panel. An additional environmental monitoring suite for each room and/or workstation will be used for measuring and recording occupant preferences and environmental conditions. The prototype systems will provide a platform for PG&E to examine the suitability of digital lighting controls for implementing various demand responsive strategies including 1) tuning light according to lamp spectrum, 2) active load shedding and 3) daylight-linked control. Similar discussions are underway for programs with SCE. Utilities are key partners for market impacts since they influence new market choices by virtue of their publicly funded Savings by Design and retrofit program activities and because they have outreach programs to inform specifiers of the availability and performance of these new technologies.

Significant Research Products

IBECS Network/Ballast Interface. Rubinstein, F. M. and P. Pettler (2001). Final Report to Department of Energy, LBNL-49973.

This report describes the work performed to design, develop and demonstrate an IBECS network/ballast interface that is useful for economically controlling dimmable fluorescent lamps in commercial buildings.

Final Report on Internet Addressable Light Switch. Rubinstein, F.M. and P. Pettler (2001). LBNL-49974.

This report describes the work performed to develop and test a new switching system and communications network that is useful for economically switching lighting circuits in existing commercial buildings.

CONCLUSIONS AND RECOMMENDATIONS

Conclusions

- The development and successive refinement of the IBECS ballast network interface taught us that it is critical to protect the interface from electrical noise transmitted by the electronic ballast itself. Using standard opto-isolation methods, we were able to harden the interface from interference from the ballast.
- The advanced multi-sensor prototype worked satisfactorily and provided unparalleled capability for measuring temperature, light and occupancy all from one low-cost package.
- The IBECS power meter also operated satisfactorily.

Commercialization potential or commercialization initiated

As noted above, LBNL initiated contact with three ballast manufacturers regarding the integration of IBECS technology into their products. LBNL is working with one particular ballast manufacturer to produce several dozen dimming ballast prototypes that will embed the IBECS ballast network interface. The prototypes will be useable for field evaluations and early pilot installations of the IBECS technology for the Phase Next work.

Recommendations

From a global perspective, advance the adoption of digital lighting control systems by working with industry to embed IBECS technology into existing analog control and DALI products, and developing compelling demonstrations of digital control systems for evaluation by early adopters.

In the area of environmental sensors, the multi-sensor could be enhanced by others to form a very-low cost data acquisition for collecting data from workstations distributed over a wide geographical area. However, this enhancement should be carried out by an appropriate device manufacturer so that they can improve the accuracy and dynamic range of the light sensor.

The IBECS power meter needs to be adopted by a meter manufacturer who could refine the device so that it measures true RMS power rather than just electrical current. Furthermore, for power meters, it is advantageous to add a wireless transceiver to the meter so that it can operate wirelessly. LBNL was awarded DOE funding as a subcontractor to a California-based start-up company one of whose goals is to bring wireless technology to power meters and environmental sensing.

BENEFITS TO CALIFORNIA

Researchers established connections with ballast and controls manufacturers, several of which are based in California. The two ballast manufacturers that intend to add IBECS technology to their new ballasts are California companies as is the control company that is considering embedding the IBECS technology in their occupancy sensors and daylight control photosensors. Adding digital smarts to analog electronics product has been a mainstream business goal for companies in California and presents new business opportunities, markets and employment potentials for these ballast and control manufacturers.

IBECS enables integrated control of lighting and other systems in a building, thus making it possible to reduce demand when energy management is crucial. This will be increasingly important in California if buildings are to be able to respond cost effectively to emerging critical peak pricing strategies and other demand response programs. IBECS-based controls can also reduce lighting energy use throughout the year in all commercial buildings in California. According to CEC estimates, lighting energy in California commercial buildings consumed approximately 30 Twh in 2000. Assuming that IBECS technologies could eventually be installed in 20% of available stock, and assuming that the energy savings is approximately 40%, the savings potential to California businesses could be 2.4 Twh/yr or \$250 million in avoided energy costs.

By providing building occupants with more personalized control of their lighting environment, IBECS adds value to commercial buildings that go far beyond the energy cost savings. Facility management A number of California software developers could take advantage of the lack of developed environmental control software for buildings to produce new software products and services.

3.2. Daylighting--(Element 3, Project 3.2)

INTRODUCTION

Background and Overview

Daylighting can significantly reduce lighting energy use and its associated heat gains in commercial buildings. In combination with dynamic window systems that actively manage daylight and solar heat gains, these integrated systems can yield annual energy consumption and peak demand levels that are significantly lower than an opaque insulated wall in all U.S. climates while improving the quality and comfort of our workplace. To take full advantage of the potential of daylighting systems, a practical and effective networking system is needed that can control envelope components as well as integrate these components with other building equipment, particularly lighting.

OBJECTIVES

- Design, build, and test the Integrated Building Environmental Communications System (IBECS) networking system and control device interfaces that enable local and global energy-efficient operation of building envelope systems such as motorized shades and switchable, variable transmittance electrochromic windows. Synergistic work includes field tests of large-area electrochromic windows in full-scale applications.

APPROACH

- Design, fabricate, and test IBECS networking interfaces that allow control of motorized window shades such as Venetian blinds or roller shades from the IBECS network.
- Design, fabricate, and test IBECS network interfaces that allow control of 0-5 VDC electrochromic windows from the IBECS network.
- Test the reliability of the IBECS communications network operating in a realistic, uncontrolled office environment.
- Determine the energy-efficiency and qualitative benefits of large-area electrochromic (EC) windows in full scale applications.

OUTCOMES

Technical outcomes

- Developed working prototypes of key IBECS network components. We developed three components: DC-motorized Venetian blinds or roller shades, AC-motorized blinds or shades, and electrochromic windows. The nation's first

full-scale demonstration of electrochromic windows was conducted with further tests planned.



Figure 16. Diffuse Light Conditions



Figure 17. Bright Sunlight Conditions

Figures Figure 16 and Figure 17 show an interior view of test room B on a partly cloudy day. The electrochromic windows are in the clear state at 10:30 under diffuse light conditions (Figure 16). When sun enters the window, the electrochromic switches to its fully colored state by 10:50 (Figure 17).

- Achieved significant reductions in lighting energy use. Daily lighting energy use was 6-24% less when compared to a static 11% transmittance window and 3% less to 13% more compared to a 38%-window. Window brightness control and interior daylight levels were improved with dynamic window control. A new test facility has been built where additional, more comprehensive measurements of EC windows will be made this summer 2003.
- Demonstrated reliable operation of the controller through the IBECS network. During the hours of automated operation, no erroneous transmission values were set on the controller. Status was also monitored without error. Independent measurements of the control voltage generated by the DS2890 showed that it was correct for the command sent. Controller status read through the network always correlated properly with the measurement of control voltage from the controller.
- Achieved control of motorized blinds through the IBECS network. The IBECS interface enables one to control the tilt, raise and lower functions of motorized Venetian blinds via a One-Wire Dallas Semiconductor network from a virtual user LabView control panel installed on a PC. Three IBECS-controllable Venetian blinds were installed on west-facing windows in an open-plan occupied office at LBNL 90-3111 and have been reliably operational for over a year.



Figure 18. Venetian Blind System at LBNL.

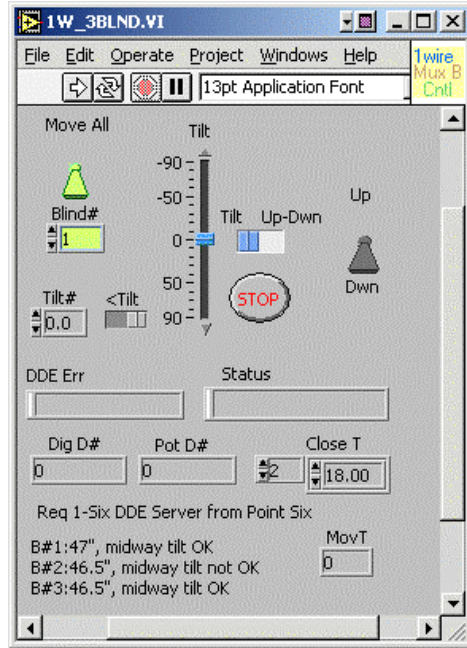

Figure 19. Labview "Virtual Instrument" Panel Used To Control The Operation Of The IBECS-Controlled Venetian Blinds.

- Established IBECS demonstration network to test these technologies. The components and network cabling were installed in the IBECS demonstration, and work is now progressing on developing control software that will implement the different lighting and window control strategies and simplify the commissioning process. (See Figure 20 and Figure 21.) The fixture is individually controlled to user settings. IBECS Venetian blinds are off to the left of this photo in Figure 21.

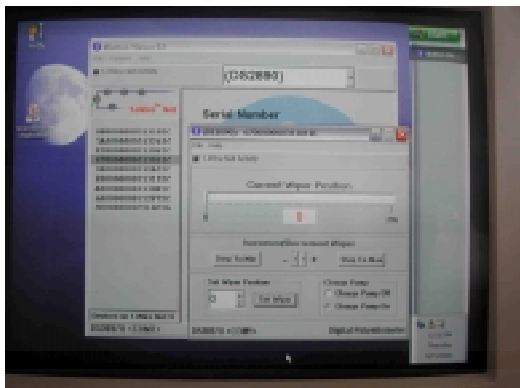

Figure 20. Control Panel For Eight Light Fixtures In Open Plan Office.



Figure 21. IBECS-Controlled Electric Lighting Fixtures.

In Figure 21, the fixture is individually controlled to user settings. IBECS Venetian Blinds are off to the left of this photo.

Market Outcomes

- Informed major shade and components manufacturers of the IBECS research. The IBECS concept is appropriate for the dynamic window industry and enables one to achieve a drastic cost reduction in per point networking costs. The solutions described above can be applied to all types of motorized window shading systems with some modifications to the interface between the motor and the shade ladders, tapes, or metal rungs. Detailed specifications of the interface are included in the deliverable report so that manufacturers can pursue development of this networking concept if it meets their business needs.
- Invited members of the building sector to view the IBECS demonstration network. The LBNL demonstration has been showcased to numerous visitors over the year and there is interest from one building owner, who is now in the process of designing a 160K m² (1.7M ft²) commercial building, to implement this IBECS concept with motorized shades and dimmable lighting.

Significant Research Products

Low-Cost Networking for Dynamic Window Systems. Lee, E.S., D.L. DiBartolomeo, F.M. Rubinstein, S.E. Selkowitz . 2003. LBNL Report 52198, Lawrence Berkeley National Laboratory, Berkeley, CA. Draft undergoing review.

US DOE and CEC Synergistic Task Reports:

Active Load Management with Advanced Window Wall Systems: Research and Industry Perspectives. Lee, E.S., S.E. Selkowitz, M.S. Levi, S.L. Blanc, E. McConahey, M. McClintock, P. Hakkarainen, N.L. Sbar, M.P. Myser. 2002. Proceedings from the ACEEE 2002 Summer Study on Energy Efficiency in Buildings: Teaming for Efficiency, August 18-23, 2002, Asilomar, Pacific Grove, CA. Washington, D.C.: American Council for an Energy-Efficient Economy. LBNL-50855, Lawrence Berkeley National Laboratory, Berkeley, CA. <http://eetd.lbl.gov/btp/papers/50855.pdf>

Application issues for large-area electrochromic windows in commercial buildings. Lee, E.S., D. L. DiBartolomeo. 2000. Solar Energy Materials & Solar Cells 71 (2002) 465–491. LBNL Report 45841, Lawrence Berkeley National Laboratory, Berkeley, CA. <http://eetd.lbl.gov/btp/papers/45841.pdf>

Electrochromic windows for commercial buildings: Monitored results from a full-scale testbed. Lee, E.S., D. L. DiBartolomeo, S. E Selkowitz. 2000. Presented at the ACEEE 2000 Conference and published in the Proceedings from the ACEEE 2000 Summer Study on Energy Efficiency in Buildings: Energy Efficiency in a Competitive Environment, August 20-25, 2000, Asilomar, Pacific Grove, CA. Washington, D.C.: American Council for an Energy-Efficient Economy. LBNL Report 45415, Lawrence Berkeley National Laboratory, Berkeley, CA. <http://eetd.lbl.gov/btp/papers/45415.pdf>

CONCLUSIONS AND RECOMMENDATIONS

Conclusions

The prototype network interfaces enable one to control and monitor the condition of various dynamic fenestration system and lighting systems from a variety of sources, including a user's personal computer. By creating a functional specification for an IBECS network interface and testing a prototype, the ability to construct such an interface was demonstrated and the cost-effective price per point better understood.

The IBECS concept is compelling because costs can be reduced if control integrated circuits (ICs) typically residing on a single device can be implemented upstream in software. This is the case for 0-10 V DC controllable electronic ballasts, where real-time operations of the device are not compromised by the speed of the network. The ballast controller, which typically group-controls numerous ballasts, can be eliminated with the IBECS system and replaced with software upstream at a higher level. With motorized shades and electrochromic windows, however, the complex details of actuation ("change tilt angle, check, change tilt angle, check...") are best realized at the local microLAN level, downstream of the IBECS network and next to the device so as to ensure proper real-time operations. The IBECS concept is still compelling for this class of devices. Global commands can be sent through the IBECS network to actuate individual devices ("go to tilt angle of 30°") and device status can be monitored over the IBECS network. Control algorithms that integrate window and lighting systems (and their respective environmental sensors and actuators) can also be implemented in software upstream of the microLAN.

Commercialization Potential or Commercialization Initiated

Most manufacturers expressed reservations with the IBECS concept. Some have already implemented the same type of solutions using a different chip set claiming the same per point costs. Others are unwilling to adopt a new protocol that has not yet been adopted by other industries or major control companies (see "Lighting Controls" above for information on the IEEE 1451 Standard on Sensors and Actuators). Some indicate that the concept is fundamentally sound but needs further investigation to see how such a system could work for their product line. The most compelling reason for adopting such a system is to enable systems integration with lighting and other building systems. Most window shade manufacturers provide products that do not actively integrate with other building systems via closed-loop control but are interested in learning the benefits and means to achieve such integration over the long term.

RECOMMENDATIONS

Continued work on the LBNL IBECS network in Building 90-3111 will provide useful data to manufacturers on the benefits of integrating their dynamic window products with other building systems using a low-cost open-protocol networking system like IBECS.

BENEFITS TO CALIFORNIA

IBECS networked window and lighting devices enable real-time optimization of solar heat gains versus daylighting, which yields the best performance in terms of energy-

efficiency and demand response during critical peak periods or grid overload. Since the window device is working in synchronization with the lighting system (as opposed to in isolation) to provide sufficient, not excessive controlled daylight, both cooling loads and lighting energy use are optimized in perimeter zones of commercial buildings.

Decreasing the per point cost for networking individual shades or switchable window systems also can provide building occupants and facility managers with options to improve satisfaction, comfort in their workplace. [JBT1]

3.3. Network Operations--(Element 3, Project 3.3)

INTRODUCTION

Background and Overview

Integrated lighting controls can significantly improve building performance, increase energy efficiency, and enhance occupant comfort and satisfaction with the built environment. However, the lack of agreement on communications protocols is a significant market barrier to widespread use of advanced controls. A working model is needed to describe how the various existing and proposed building control systems can be integrated.

OBJECTIVES

- Develop a framework to integrate the IBECS with the BACnet protocol and to demonstrate that IBECS can be used to commission, re-commission and maintain building lighting systems.
- A final objective was to demonstrate that IBECS can be used as a diagnostic tool to ascertain the operational performance of building lighting and dynamic envelope systems.

APPROACH

- The approach consisted of the following:
- Explore the usefulness of IBECS for implementing load shedding and other advanced lighting controls techniques by developing an interface between BACnet and IBECS.
- Demonstrate that IBECS can be used to commission, re-commission and maintain building lighting systems. Most of the effort on this task was devoted to developing Java-based programs that would allow us to control and communicate with 1-Wire devices on the IBECS demonstration network under development at LBNL's Building 90-3111 office suite.
- Demonstrate that IBECS can be used as a diagnostic tool to ascertain the operational performance of building lighting and dynamic envelope systems.

OUTCOMES

Technical Outcomes

- Developed conceptual framework for integrating building control systems. We successfully developed a conceptual framework to unify not only IBECS and

BACnet but also the DALI protocol that is finding increased acceptance in the lighting industry. Although it might seem that there is significant overlap between BACnet and IBECS, we found that BACnet was primarily concerned with software and communication between EMS systems while IBECS is primarily focused on the hardware and software aspects of the communications network close to the point of use (at the individual equipment level).

Figure 22 is the system diagram of the proposed communications framework consisting of an IBECS network and a DALI lighting network controlled by a networked IBECS/DALI bridge. Additional bridges can be added to the system to accommodate more equipment as the system grows. The IBECS bridges would communicate using the BACnet protocol and be separated from the building Ethernet with a firewall. As shown by the indicator on the left, the different protocols have overlapping degrees of influence on the overall communications system. IBECS, and the underlying IEEE P1451, govern most communications at the equipment level and the attached DALInet. At higher levels of the network, the influence of IBECS diminishes and is taken up by BACnet, which governs communications above the bridge.

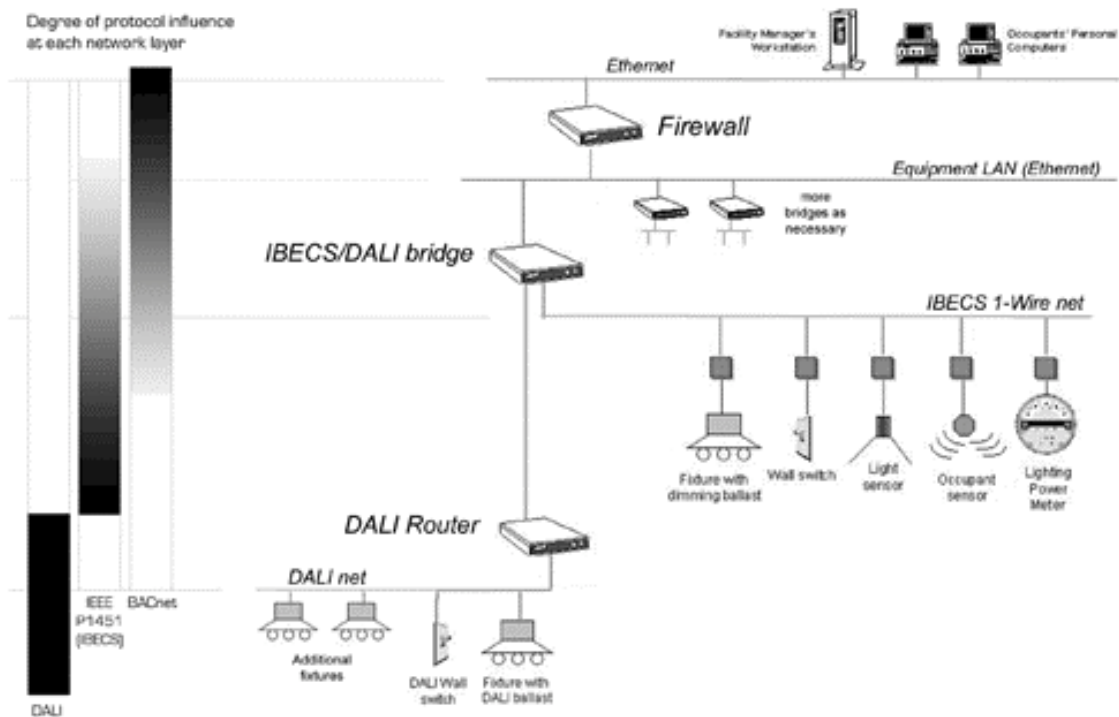

Figure 22. System Diagram Of The Proposed Communications

- Developed software to enable control of lighting devices over the IBECS network. We developed preliminary software for addressing and controlling certain types of lighting devices and are testing the software in an IBECS demonstration network at LBNL’s Building 90. Additionally, we can “discover” all three connected IBECS devices—the ballast/network interface (containing the

DS 2890 digital potentiometer), environmental sensor and the power demand monitor (both containing the DS2439 smart battery monitors). We have also completed simple “control panels” that provide a user-friendly method to examine the data from IBECs sensors and to push digital commands onto the digital potentiometer.

- Diagnostic software still must be developed. Because the demonstration network was only functional toward the end of this project, we were unable to develop significant software for use as a diagnostic tool. However, it is clear that good diagnostic software and network troubleshooting tools will be indispensable for control systems of the future. This work will be pursued through funding from Department of Energy’s Building Technologies Program.

Market Outcomes

- We established that IBECs is a useful intermediary between BACnet at a higher level and DALI at a lower level. One important future market outcome would be a bridge capable of running BACnet, IBECs (through IEEE P1451) and DALI protocols. We identified several companies that have the requisite capabilities to build such a product. It is our intent to further develop these commercialization opportunities through the Phase Next funding.
- We developed a work proposal for Southern California Edison to fund a demonstration of the IBECs system at CTAC. LBNL proposes to field test an integrated lighting and shading control system based on IBECs and DALI concepts at the Edison classroom model at CTAC. The prototype systems would combine automatic control of the overhead lighting system with rational operation of the electrochromic window system that is being tested at the classroom. Since SCE is heavily involved in a full range of market-related activities this project could facilitate further market interest in these emerging technologies.

Significant Research Products

Standardizing Communication Between Lighting Control Devices: A Role for IEEE P1451. Rubinstein, F., S. Treado and P. Pettler, 2003. Accepted for presentation at the IEEE Industry Applications Society Conference and Annual Meeting and for publication in the Proceedings of the IEEE-IAS Annual Conference and Meeting, October 12-15, 2003, Salt lake City, 2003.

The paper proposes a building equipment communications network based on a federation of existing standards and communications protocols. The proposed network concept provides a viable model for control manufacturers to provide advanced digital control of most building equipment.

CONCLUSIONS AND RECOMMENDATIONS

Conclusions

We learned that it will be necessary to accommodate not only BACnet but also DALI in a successful lighting control framework. This is because of the lighting industry’s recent significant interest and adoption of DALI as a de facto standard for operating digitally

addressable ballasts. To this end, the white paper that we developed for this task unifies BACnet, IBECS and DALI into a loose federation of overlapping protocols.

Commercialization Potential or Commercialization Initiated

We are working with a manufacturer of DALI-based networking products to add an IBECS network connection to their DALI router. This system would read the sensors on the IBECS connection to modify the output of the DALI ballasts connected to the router. Since DALI doesn't treat sensors, this system would demonstrate to the industry that IBECS can add useful sensing features that DALI lacks.

Recommendations

A framework for better lighting and building control will only be successful if equipment manufacturers believe that adopting it would add significant value to their products. Which protocols comprise the framework is, therefore, important. If one or more of the protocols already have an established commercial track record, then it is more likely that manufacturers in different product areas would embrace it. This bodes well for the proposed framework since most HVAC manufacturers produce systems that are BACnet compliant today and the influence of BACnet on lighting control products is also growing. Although most of the commercially available applications for IEEE P1451 are currently in the sensor and measurement industries rather than in building controls, more IEEE P1451-compliant products continue to emerge. And most ballast manufacturers are now producing DALI ballasts for the US market.

BENEFITS TO CALIFORNIA

California building owners, like most in the US, are sensitive to first cost and relatively risk averse. However the utility climate in California is different, with events of 2001 still in the mind of owners, with utility costs above national averages and with the advent of voluntary critical peak pricing tariffs. Adding the role of California companies in developing and promoting the internet and information technology solutions, makes California a more fertile ground than other states for introduction of an internet-based control system

A unified controls framework allows integration of a wide range of components. Each of these components thus need only conform to the requirements of the particular subset of the system to which it would belong. This would allow network connectivity for low-cost components that now are usually considered to be too inexpensive to incorporate such technologies, while at the same time accommodating powerful intelligent hierarchical control strategies.

Standard protocols provide for interoperability without constraining the internal design and operation of components and devices. As a result, manufacturers can differentiate their products based on whatever combination of price and performance they deem appropriate. Devices and systems can be designed and selected from a wide range of performance attributes to meet different goals as required for specific applications. Interoperability begets flexibility, which encourages design solutions tailored for optimum performance.

The benefits of an unified building communications framework pertain to the entire building industry, not solely to California. However, to realize the benefits of the

framework with require the development of software for controlling and communicating with building equipment devices. With its rich tradition of innovative software developers, California software vendors can be well-positioned to develop the requisite software and services.

4.0 Element 4 Low Energy Cooling

INTRODUCTION

Cooling energy use is second only to lighting energy use in commercial buildings. Cooling in commercial buildings accounts for 14% of California's peak electrical demand. Cooling system efficiency can be improved through the appropriate use of compressor-less cooling technologies and techniques for cooling occupied spaces more effectively and by reducing distribution system losses. The intent of this technical research element was to:

- Identify and evaluate appropriate combinations of low-energy cooling technologies, including more efficient distribution systems, and
- Develop the simulation models required both for this evaluation and for the design of such systems for individual buildings.

The Low Energy Cooling Element consists of three projects, two of which have been active for all three years of the program. The System Appraisal Project has produced an assessment of the potential of different low energy systems that indicates significant energy benefits from displacement ventilation/underfloor air distribution systems, particularly in combination with indirect evaporative cooling. It also indicates substantial peak load reductions and significant energy savings from radiant slab cooling. The Model Development Project has produced models of displacement ventilation and natural ventilation that capture the main differences from mixing ventilation, yet are computationally efficient enough for use in annual simulation. These models have been implemented in EnergyPlus.

The Efficient Distribution Systems Project uses computer simulation to assess the effects of air leakage from ducts in large commercial buildings. Recommendations are being developed to extend the 2005 and 2008 Title 24 Standards to include the requirement for reporting performance metrics relating to distribution system performance. This project started in Year 3, following the completion of a PIER II and DOE funded project that included a detailed characterization of the duct system in a large commercial building. That project confirmed earlier elementary predictions that duct leakage can significantly increase HVAC system energy consumption and peak demand in these types of buildings.

OBJECTIVES

The main technical goal is to reduce significantly the energy consumption and peak demand associated with the cooling of commercial buildings through the effective deployment of energy efficient technologies. Additional goals are to improve health and productivity through the use of space conditioning systems that can reduce energy consumption while improving indoor air or improving comfort. The aims of this program element are to develop, refine, prove and demonstrate low energy cooling technologies, including more efficient distribution systems, and to develop tools for the design, commissioning and operation of such systems.

The specific, technical objectives upon which this program element's success will be evaluated are:

- Identify complementary combinations of low energy cooling technologies that are compatible with current construction practices;
- Develop simulation models of these low energy cooling systems and verify their performance using measurements in real buildings;
- Use these models to assess the applicability of different low energy cooling systems, separately and in combination, to different California climates and building types;
- Develop simulation models of duct system performance that correctly treat leakage and insulation for use in design and in assessment studies;
- Use these models to assess the benefits of improved duct system performance in different California climates and commercial building types
- Prepare a case for extending Title 24 to duct system performance, based on this assessment.

The overall economic goal of this program element is to reduce the cost of designing low energy cooling systems so that it is comparable with the cost of designing conventional cooling systems, while ensuring that climate issues and the associated risk issues related to system performance are properly addressed.

The specific, economic objective is to establish the economic benefits, and approximate costs, of different types of low energy cooling system in different California climates and building types, allowing designers and other decision-makers to select cooling systems appropriately.

Displacement ventilation (Figure 23) and natural ventilation (Figure 24) each have significant potential to reduce cooling energy consumption in California.

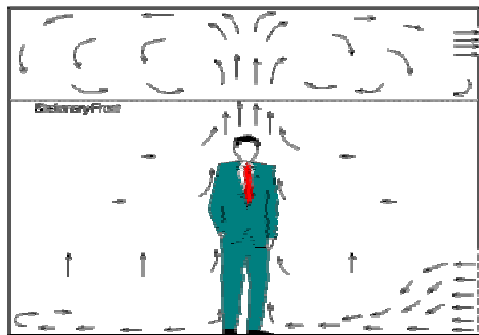

Figure 23. Displacement Ventilation



Figure 24. Natural Ventilation

Project Team and Technical Advisory Group (TAG)

Element 4 was lead by Philip Haves of the Lawrence Berkeley National Laboratory, with MIT as a subcontractor. Significant contributors to this element included:

- N. Bourassa (LBNL)
- P. Xu (LBNL)

- C. Wray (LBNL)
- N. Matson (LBNL)
- M. Modera (LBNL)
- P. Linden (UC San Diego)
- G. Carrilho da Graça (UC San Diego)

The Technical Advisory Group (TAG) included:

- Peter Alspach (Arup)
- Reginald Monteyne (Flack and Kurtz)
- Richard Bourne (Davis Energy Group)
- Michael Scofield (HVAC designer)
- Edward Arens (UC Berkeley Center for the Built Environment)
- Curtis Pedersen (University of Illinois)
- Andrew Persily (NIST)

4.1. Appraisal of System Configurations--(Element 4, Project 4.1)

INTRODUCTION

Background and Overview

There a number of low energy cooling techniques that have the potential, either individually or in combination, to reduce energy consumption and/or peak demand in California climates. Examples include:

- Natural ventilation
- Displacement ventilation
- Evaporative cooling
- Radiant cooling

There has been a lack of information for both designers and policymakers on the savings to be expected from deploying these techniques in commercial buildings in California.

OBJECTIVES

- Identify potentially synergistic combinations of existing compressor-less cooling technologies, energy-efficient methods of cooling spaces and energy-efficient distribution systems using computer simulation.
- Estimate the savings to be expected from the deployment of these systems

APPROACH

- Phase I of this project assessed the performance of selected systems that can be modeled with the DOE-2.1E simulation program. These included:
 - ▶ Air-side indirect and indirect/direct evaporative pre-cooling

- ▶ Cool beams
- ▶ Displacement ventilation
- All systems included a vapor compression chiller to ensure that the cooling load was met at all times, since DOE-2 does not treat under-capacity adequately.
- The modeling of displacement ventilation systems involved some significant approximations that have been overcome in Phase II through the use of EnergyPlus and the model of displacement ventilation developed in Project 3. Radiant slab systems were also modeled with EnergyPlus.
- Standalone systems, i.e., systems without chillers, have also been simulated, taking advantage of EnergyPlus's ability to predict the effects of inadequate capacity.
- Simulations have been performed for four populous climates, represented by Oakland, Sacramento, Pasadena and San Diego.

OUTCOMES

Technical Outcomes

- We predicted significant savings relative to a conventional HVAC system - 20-60%, depending on system type, climate and building type.
- DOE-2 simulations show that evaporative pre-cooling is beneficial in all California climates.
- The DOE-2 prediction of significant savings from the use of displacement ventilation has been confirmed by the EnergyPlus simulations, although the predicted magnitude of the energy savings is somewhat less (37% vs. 49% in the climate zone that includes San Jose, for example).
- Radiant slab cooling can significantly reduce peak demand by smoothing and shifting cooling loads and can reduce energy consumption through greater use of water-side free cooling.

Market Outcomes

- The dissemination of the work to date has led to some increase in industry knowledge of the energy and peak demand savings potential of low energy cooling technologies in commercial buildings for distinct California climate regions.

Significant Research Products

Low Energy Cooling System Appraisal Study

N. Bourassa, P. Haves, J. Huang, P. Xu

http://buildings.lbl.gov/hpcbs/pubs/E4P21T2a_LBNL-51837.pdf

An appraisal of the potential performance of different Low Energy Cooling (LEC) systems in non-residential buildings in California has been conducted using computer simulation. The report presents results from the first phase of the study, which addressed the systems that can be modeled with the DOE-2.1E simulation program, and from the second phase, in which additional systems were simulated using EnergyPlus.

Graphical comparisons of the performance of different systems in four populous climates, represented by Oakland, Sacramento, Pasadena and San Diego are presented and interpreted. Detailed results are presented in tabular form for the 16 California climate zones. The report documents the design and modeling assumptions used in the study and makes recommendations for further work.

A Computer Simulation Appraisal of Non-Residential Low Energy Cooling Systems in California (N. Bourassa, P. Haves and J. Huang), Proceedings of ACEEE Summer Study, Asilomar, CA, August 2002. http://buildings.lbl.gov/hpcbs/pubs/E4P21T1a2_LBNL-50677.pdf

The paper presents results from the first phase of the study of the potential performance of different Low Energy Cooling (LEC) systems in non-residential buildings in California, which addressed the systems that can be modeled, with the DOE-2.1E simulation program. Results are presented for four populous climates, represented by Oakland, Sacramento, Pasadena and San Diego. The greatest energy savings are obtained from a combination of displacement ventilation and air-side indirect/direct evaporative pre-cooling. Cool beam systems have the lowest peak demand but do not reduce energy consumption significantly because the reduction in fan energy is offset by a reduction in air-side free cooling. Overall, the results indicate significant opportunities for LEC technologies to reduce energy consumption and demand in non-residential new construction and retrofit.

The Integration of Engineering and Architecture: a Perspective on Natural Ventilation for the new San Francisco Federal Building (E. McConahey, P. Haves and T. Christ) Proceedings of ACEEE Summer Study, Asilomar, CA, August 2002. http://buildings.lbl.gov/hpcbs/pubs/E4P21T1a3_LBNL-51134.pdf

The paper describes the process of designing a large naturally ventilated office building for San Francisco and thereby illustrates a number of issues arising in the design of large, naturally ventilated office buildings. The paper describes the use of EnergyPlus to compare the performance of different natural ventilation strategies. The results indicate that, in the San Francisco climate, wind-driven ventilation provides sufficient nocturnal cooling to maintain comfortable conditions and that external chimneys do not provide significant additional ventilation at times when it would be beneficial.

CONCLUSIONS AND RECOMMENDATIONS

Conclusions

A number of low energy cooling systems have the potential to produce significant energy and demand savings in different regions of California. The savings depend on system type, climate and building type. Approximate guidance on system selection can be given based on generic simulations. However, in cases where more than one system appears to have significant savings potential, project-specific simulation assessment is called for to inform system selection and then support detailed design.

A number of problems were encountered in the use of EnergyPlus that significantly limited the number of systems that could be simulated in the course of the project. A major fraction of the resources (\$50k) that were allocated to the Phase II task were used identifying problems in EnergyPlus. Some of these problems are generic in that they

affect the simulation of conventional systems as well as low energy cooling systems; others are specific to low energy cooling systems. In each case, it is expected that the EnergyPlus development team will resolve these problems. However, it seems reasonable to expect that further problems will arise and need to be addressed before subsequent versions of EnergyPlus will be capable of simulating the full range of low energy cooling systems identified as having significant energy savings and/or peak demand reduction potential in California.

Commercialization Potential or Commercialization Initiated

Low energy cooling systems have significant potential in California, mainly for new construction but also for retrofit in certain circumstances. The results of research will remain in the public domain to allow the widest possible dissemination.

Recommendations

There are several recommendations from this project:

- Work with the EnergyPlus team to identify and resolve any remaining problems in the simulation of low energy cooling systems and to provide guidance to practitioners and others wishing to simulate these systems.
- Substantiate the conclusions of the generic simulation studies by a set of studies of real design projects, where the details that complicate system performance and system selection can be incorporated. Follow up by monitoring the operation of the buildings to compare actual performance with that anticipated in design, in an extension of the current Technical Support project. Include conventional design projects in the study for comparison purposes.
- Make designers and owners aware of the benefits of such systems by disseminating case study results.
- Use the lessons learned from the case studies of real projects to enhance the low energy cooling system models in EnergyPlus.
- Use these improved models to produce improved predictions of generic performance for use by designers and policy-makers.
- Provide design guides and simulation tools to support design (see Project 4.3).
- Recognize the benefits of low energy cooling systems in Title-24 and in related utility programs such as Savings by Design.
- Develop commissioning and operation and maintenance procedures to maximize the actual performance of low energy cooling systems.
- Dissemination of the final results, particularly if accompanied by a system selection guide for designers, would significantly increase this knowledge and would (1) inform Title 24 standards development efforts, and (2) provide building project decision-makers with insight into the relative merits of LEC technologies for specific CA climates.

BENEFITS TO CALIFORNIA

The benefits to California of low energy cooling systems include reduced utility costs from reduced energy consumption and, for some systems, reduced peak demand.

Additional benefits from reduced energy consumption include reduced emissions, both globally and locally. Potential savings for new buildings range from 20 to 60%, depending on location and building type. Potential savings for retrofit are more difficult to predict but could be significant. The benefits of demand reductions from load shifting and smoothing include reduced need for new generating capacity and improved security of the electricity supply.

4.2. Efficient Distribution Systems--(Element 4, project 4.2)

INTRODUCTION

Background and overview

Although not generally recognized by the building industry, thermal distribution systems (TDS) in large commercial buildings can suffer from thermal losses, such as those caused by duct air leakage and poor duct insulation. For example, our recent measurements in an existing large commercial building confirmed earlier elementary predictions that duct leakage can significantly increase heating, ventilation, and air conditioning (HVAC) system energy consumption: adding 15% duct leakage at operating conditions leads to an increase in fan power of about 25 to 35%.

Despite the potential for significant energy savings by reducing thermal losses from duct systems in large commercial buildings, California Title 24 has no provisions to credit energy efficient duct systems in these buildings. A substantial reason is the lack of readily available simulation tools to demonstrate the energy saving benefits associated with efficient duct systems in large commercial buildings. A related reason is that, although past efforts have identified substantial energy increases due to duct leakage in single large commercial buildings in Sacramento, the variability of these impacts for the various building vintages and various climates in California has not been established.

OBJECTIVES

- Identify a near-term whole-building energy simulation approach that can be used in the impacts analysis task of this project. A secondary purpose of the review is to provide a basis for recommending how to proceed with long-term development of an improved compliance tool for Title 24 that addresses duct thermal performance.
- Using the near-term approach identified in Task 1, assess the thermal performance impacts of duct improvements in California large commercial buildings, over a range of building vintages and climates.
- Develop an Alternative Calculation Method (ACM) change proposal to include an overall metric for thermal distribution system efficiency in the reporting requirements for the 2005 Title 24 Standards. Also, outline a duct performance package for the 2008 update of Title 24.

APPROACH

- We performed a literature review of 187 documents related to recent HVAC system modeling efforts to identify whole-building energy modeling approaches that we could use with little modification in near-term benefits analyses of duct

system performance in large commercial buildings. We supplemented the review through discussions with building simulation experts to assess new, unpublished, relevant work. We also developed recommendations for longer-term implementation of duct modeling in simulation environments such as EnergyPlus that facilitate innovative low-energy building design.

- We used the near-term simulation approach that we identified to assess the thermal performance impacts of duct improvements in California large commercial buildings. Specifically, we modeled the impacts of duct leakage on VAV system performance for a prototypical large commercial office building with various characteristics that represent three building vintages in three California climates with six different duct leakage configurations (54 cases).
- Using results from our past work, we developed a proposal to revise the Alternative Calculation Method (ACM) to include an overall metric for distribution system efficiency in the reporting requirements of the 2005 Title 24 Standards. Although an objective of the project was to also recommend a set of changes for the 2008 Title 24 Standards to further incorporate duct efficiency metrics and to make use of the new duct modeling capabilities, we did not carry out that work and instead focused our efforts on Tasks 1 and 2 described above.

OUTCOMES

Technical Outcomes

- ***Short-Term Modeling Approach.*** Our review of past HVAC system modeling efforts helped define a set of modeling principles that can be used to guide duct thermal performance modeling for large commercial buildings. Based on this review, we determined that the best approach for our benefits analysis task is to build upon past research that used DOE-2 and TRNSYS in a sequential method to evaluate HVAC system performance.

An advantage of this approach is that DOE-2 prototypical models for a large commercial California building are already available, as are the custom TRNSYS component models. Another advantage is that the duct leakage modeling approach and its results for a California building have already been validated, and no changes are required to the simulation tool to carry out our benefits analyses. No other whole-building modeling approach to assess duct system performance for large commercial buildings is currently as advanced as this approach.

- ***Long-Term Modeling Approach.*** Although DOE-2.1E Version 110 is the reference simulation tool for Title 24 compliance evaluations, its duct modeling limitations, convoluted structure, and the lack of government support for future development make it unsuitable as a platform for long-term modeling of duct thermal performance in large commercial buildings. Instead, we have suggested that EnergyPlus, which is based in part on DOE-2, be developed to include the TRNSYS component models that we identified for short-term use in our benefits analysis task.

Currently, EnergyPlus has no duct performance models, but we expect that the recommended enhancements could be applied in a relatively straightforward manner.

This approach carries with it a set of challenges that need to be met within approximately the next 18 months if EnergyPlus is to be used for duct thermal performance modeling in support of the 2008 Title 24 Standards: 1) an interface needs to be rapidly developed to facilitate use of the program in Title 24 compliance analyses, 2) the TRNSYS duct performance models need to be integrated into the program, 3) the program needs to be validated against measured data and certified as either an alternative or primary compliance analysis tool, and 4) utilities to convert DOE-2 input files for use in EnergyPlus are needed to help current DOE-2.1E users migrate to using EnergyPlus. Further collaborative efforts between DOE and the California Energy Commission would help ensure that these challenges can be met, and would likely lead to substantial energy reduction benefits in California and the rest of the U.S. over the long-term.

- ***Uniformity of Duct Leakage Impacts.*** Our analyses indicate that a leaky variable-air-volume (VAV) reheat system (19% total duct leakage) in a California large commercial office building will use about 40 to 50% more fan energy annually than a tight system (about 5% leakage). Annual cooling plant energy also increases by about 7 to 10%, but reheat energy decreases (about 3 to 10%). In combination, the increase in total annual HVAC site energy is approximately 2 to 14%, which results in HVAC system annual operating cost increases ranging from 9 to 18% (\$7,400 to \$9,500). These findings are consistent with past simulations of and measurements in Sacramento large office buildings.

Our simulations also indicate that climate and building vintage variations do not cause significant variability in duct leakage impacts on fan energy use or on operating cost for leaky duct systems. This means that a simple duct leakage threshold could be developed for use in the Title 24 prescriptive compliance approach and would not need to be climate or building age specific.

- ***Duct Sealing is Cost Effective.*** Figure 25 shows the range of increases in HVAC system annual operating costs due to duct leakage for the climates and building vintages that we considered, relative to a tight duct system (about 5% total leakage). Normalized by duct surface area, the increases in HVAC system annual operating costs are approximately 0.14 to 0.18 \$/ft² for the leaky (19%) case. The suggested duct sealing cost is about \$0.20/ft² of duct surface area. Therefore, sealing leaky ducts in VAV systems has a simple payback period of about one year. Even when lower leakage rates (e.g., 10% total) are assumed, duct sealing is still cost effective. This indicates that duct sealing should be considered for all VAV systems in California large commercial buildings.

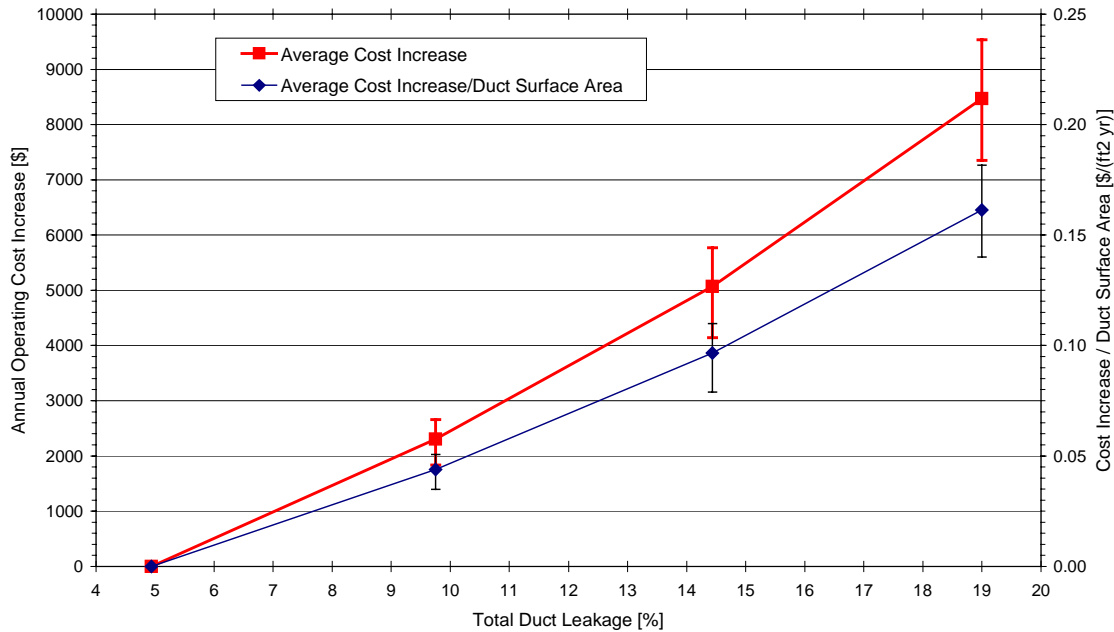

Figure 25. Duct Leakage Impacts on Annual HVAC Operating Costs

- HVAC Transport Efficiency Metric.** The California Energy Commission has already accepted the ACM change that we proposed for the 2005 Title 24 Standards. The change involves incorporating a new metric to address HVAC distribution system efficiency in large commercial buildings. The metric of interest, HVAC Transport Efficiency, characterizes the overall efficiency of the thermal distribution system as the ratio between the energy expended to transport heating, cooling, and ventilation throughout a building and the total thermal energy delivered to the various conditioned zones in the building. It will facilitate future comparisons of different system types using a common “yardstick”. Since the proposal is for a set of reporting changes, the ACM proposal should not require significant effort on the part of ACM providers to implement the changes in existing Title 24 non-residential compliance software.

Market Outcomes

- This project demonstrated to the building industry that duct leakage in commercial buildings is an important performance issue, and that there is value in reducing thermal losses associated with this leakage. The project also provided the basis for the development of standards that address thermal deficiencies in large commercial duct systems. As described in the “Conclusions and Recommendations” section that follows later, there are still several issues that need to be addressed to initiate strong market activity.
- We have already spoken with an ACM software provider about implementing the ACM change that we proposed in existing Title 24 compliance software. This implementation is expected to be straightforward, because existing software already calculates the

parameters needed to determine the proposed distribution system efficiency ratio.

- The work in this project supports the development of future compliance analysis tools for Title 24. It also provides a basis to support commercial activities related to duct sealing in large commercial buildings.

Significant Research Products

Duct Thermal Performance Models for Large Commercial Buildings. C.P. Wray, Lawrence Berkeley National Laboratory, July 2003.

This report reviews duct system modeling approaches and recommends an approach for benefits analyses in support of the 2008 Standards, as well as an approach that could be used by designers and for longer-term development of the Title 24 Standards. A significant element of this report is the publication of duct system modeling algorithms, embodied in the form of internally documented FORTRAN code. In the future, these algorithms could be added to simulation programs such as EnergyPlus.

Duct Leakage Impacts on VAV System Performance in California Large Commercial Buildings. C.P. Wray and N.E. Matson, Lawrence Berkeley National Laboratory, August 2003.

This report describes our assessment of the thermal performance impacts of improving duct systems in large commercial buildings, based on predictions obtained using the near-term simulation approach identified in the model review report.

Proposed Revisions to 2005 Title 24 Energy Efficiency Standards: Addition of HVAC Transport Efficiency Concept. M.P. Modera, October 2002.

This memorandum report describes the ACM change proposed for the 2005 Title 24 Standards. The reporting change outlined in this report involves a new metric to address HVAC distribution system efficiency in large commercial buildings.

CONCLUSIONS AND RECOMMENDATIONS

Conclusions

We concluded that the best approach for our benefits analysis task in this project is to build upon past research that used DOE-2 and TRNSYS to evaluate HVAC system performance.

Assuming that EnergyPlus could be certified as a compliance tool for use in support of the 2008 revisions to Title 24, we suggest that the long-term strategy should involve adding duct thermal performance models into EnergyPlus. This long-term approach focuses on EnergyPlus rather than on the current compliance version of DOE-2, because we expect that the recommended enhancements could be more easily applied and used in EnergyPlus for future analyses of innovative low-energy cooling designs. In particular, although EnergyPlus at this time has no capabilities to model duct system thermal losses, we expect that the TRNSYS HVAC system models could be incorporated into EnergyPlus to provide a more practical integrated tool for designers.

Our DOE-2/TRNSYS simulations indicate that a leaky VAV system (total leakage of about 19%) will use about 40 to 50% more fan energy annually than a tight system

(about 5% leakage). Annual cooling plant energy also increases by about 7 to 10%, but reheat energy decreases (about 3 to 10%). In combination, the increase in total annual HVAC site energy is approximately 2 to 14%, which results in HVAC system annual operating cost increases ranging from 9 to 18% (\$7,400 to \$9,500). The low increases in total energy correspond to cases with large reductions in natural-gas-based reheat energy consumption due to the added leakage; the reheat reductions tend to offset the large electrical-based fan and cooling plant energy increases due to the added leakage. However, because electrical energy costs much more than natural gas per unit of energy, even the low total energy increases still result in substantial cost increases.

Normalized by duct surface area, the increases in HVAC system annual operating costs are approximately 0.14 to 0.18 \$/ft² for the 19% leakage case. The suggested duct sealing cost is about \$0.20/ft² of duct surface area. Therefore, sealing leaky VAV systems has a simple payback period of about one year. Even for lower leakage rates (e.g., 10% total), duct sealing is still cost effective. Therefore, duct sealing is recommended for all VAV systems in California large commercial buildings.

Recommendations

Before duct performance in large commercial buildings can be accounted for in Title 24 nonresidential building energy standards, there are several issues that must be addressed and resolved. These include:

- Specifying reliable duct air leakage measurement techniques that can be practically applied in the large commercial building sector.
- Defining the duct leakage condition for the standard building used in Title 24 compliance simulations.
- Assuring consistency between simulated duct performance impacts and actual impacts.
- Developing compliance tests for the Alternative Calculation Method (ACM) Approval Manual (CEC 2001b) to evaluate duct performance simulations.

Additional steps will be required to further develop duct-modeling capabilities that address limitations in existing models and to initiate strong market activity related to duct system improvements. We recommend that these steps include:

- Implement duct models in user-friendly commercially-available software for building energy simulation, validate the implementations with case studies and demonstrations, and obtain certification for software use as a primary or alternative compliance tool in support of the Title 24 Nonresidential Standards.
- Develop methodologies to deal with airflows entering VAV boxes from ceiling return plenums (e.g., to model parallel fan-powered VAV boxes), to deal with duct surface heat transfer effects, and to deal with static pressure reset and supply air temperature reset strategies.

Transfer information to practitioners through publications, conferences, workshops, and other education programs.

BENEFITS TO CALIFORNIA

This project contributes to the PIER program objective of improving the energy cost and value of California's electricity in two ways. One is by developing analytical methods to show that well designed duct systems in large commercial buildings can save much of the energy used to move and condition air. The other is by making progress toward new requirements for commercial duct system efficiency in future revisions of Title 24. We expect that the new analytical capabilities and our assessment of the impacts of duct leakage on the thermal performance of HVAC systems will ultimately result in smaller capacity, more energy efficient building systems, which will also lower peak electrical demand from California's commercial building sector and improve the reliability and quality of California's electricity.

4.3. Model Development--(Element 4, project 4.3)

INTRODUCTION

Background and overview

Current whole building analysis tools assume that all spaces within a building are well mixed and can be represented by a single temperature. Low energy cooling strategies typically produce significant temperature variations within a space. This task extends the simple mixed models to more realistic models appropriate to low energy cooling.

OBJECTIVES

- Extend single temperature models to a two node approach that allows for simple, first order estimation of the effects of low energy cooling strategies on thermal comfort and overall building energy performance.
- Develop models for mechanical and natural displacement ventilation (with and without cooled ceilings), and cross-ventilation flows with recirculation regions.
- Implement these models in EnergyPlus.

APPROACH

- The simplified airflow pattern models were developed using a combination of scaled model experiments, computational fluid dynamics, scaling analysis, and approximate solutions of the Navier-Stokes equations. This combined approach resulted in simple insights into the mechanisms and system parameters that control the airflow pattern in these unmixed cases. First order precision is expected and considered acceptable in view of physical system complexity and other uncertainties that are common in building ventilation design, such as furniture geometry, building use, and outside weather conditions.

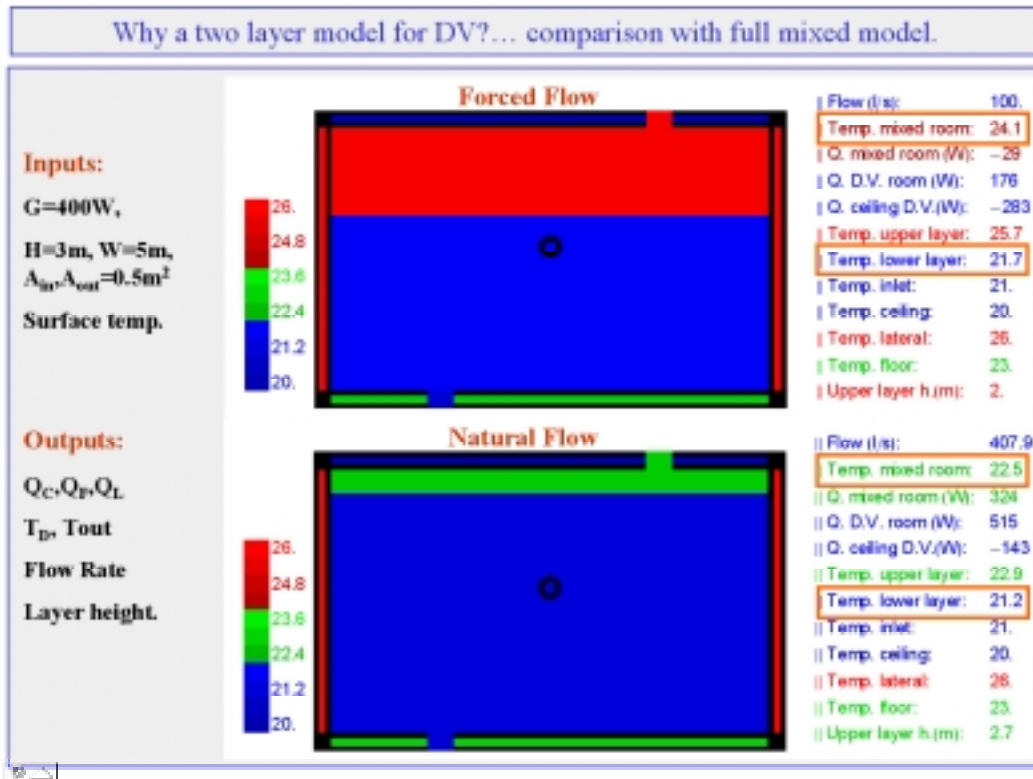

Figure 26. Schematic Showing The Basic Two-Node Structure For Displacement Ventilation.

OUTCOMES

Technical outcomes

- The research resulted in improved knowledge of the behavior of displacement ventilation and cross ventilation room airflow.
- Models were developed for mechanical and natural ventilation and wind-driven cross ventilation
- These models were implemented in the Department of Energy building thermal response simulation tool EnergyPlus. The implementation uses an embedded two node structure with minimal changes in the existing code structure. This extension to two nodes allows for greatly improved representation of the room airflow pattern and local temperatures ensuring correct heat fluxes between internal surfaces, airflow, and heat sources. The secondary node allows for improved modeling of thermal comfort both in displacement ventilation (modeling the cooler occupied zone) and in cross-ventilation or recirculating flows (modeling the typical accumulation of heat recirculation zones).
- A flow regime characterization routine (FDM) was implemented, simplifying the use of the models. This routine decides between mixed and unmixed airflow patterns, depending on system geometry, indoor surface temperatures, and internal loads. The interaction between vertical displacement flows and cooled ceilings is modeled in detail and the possibility of transition into mixed flow is considered in the flow characterization routine. Examples of the impact in the results produced by EnergyPlus for representative cases are presented.

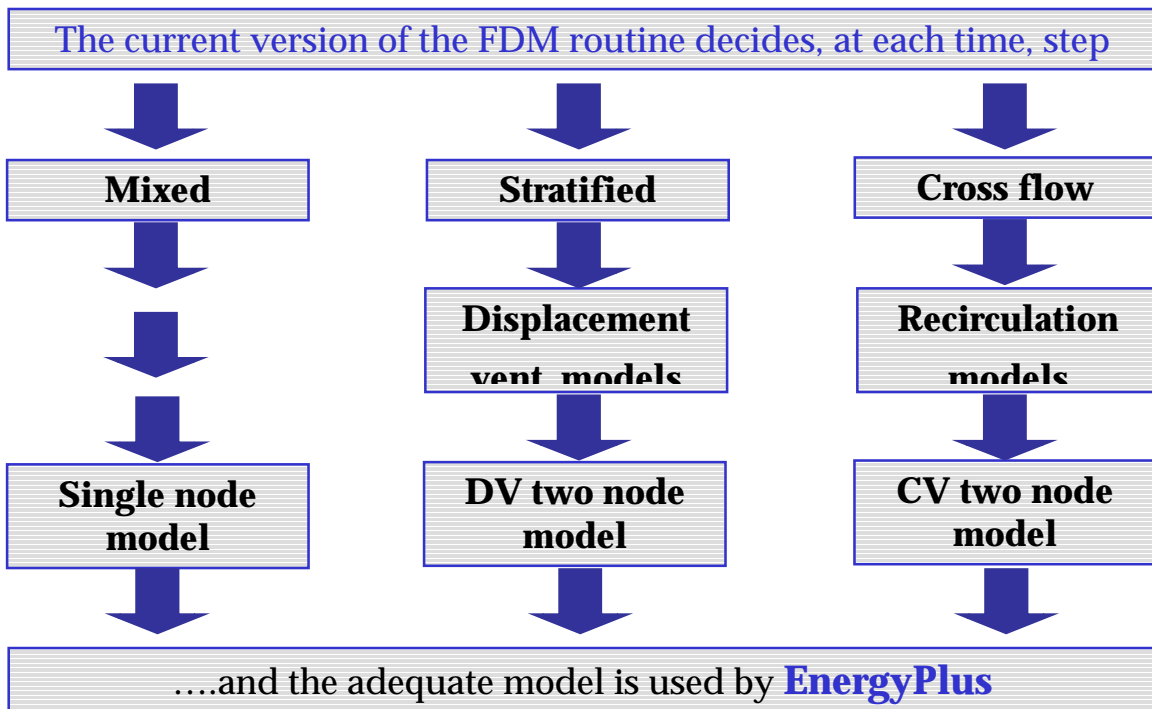

Figure 27. Schematic Of The Implementation In Energyplus.

- The ability of EnergyPlus to model relatively lightweight low temperature radiant panels using the extended conduction transfer function method already implemented in the program was investigated. Results showed that stable results could be obtained with constructions whose thermal capacity is small enough to have negligible effect on energy calculations. It is recommended that lightweight panels be modeled as a water layer sandwiched between two layers of quarter inch gypsum board.

Market Outcomes

- The implementation of these models in EnergyPlus will provide engineers and designers with the ability to assess the effectiveness of a number of low-energy cooling options, including natural ventilation and displacement ventilation.
- The models have been used to assess wind-driven ventilation for the new San Francisco Federal Building and for the design of the new Children’s Museum in San Diego. The calculated flow in the proposed San Francisco Federal Building, showing the wind-driven ceiling jet and the recirculating regions below can be seen in Figure 28.

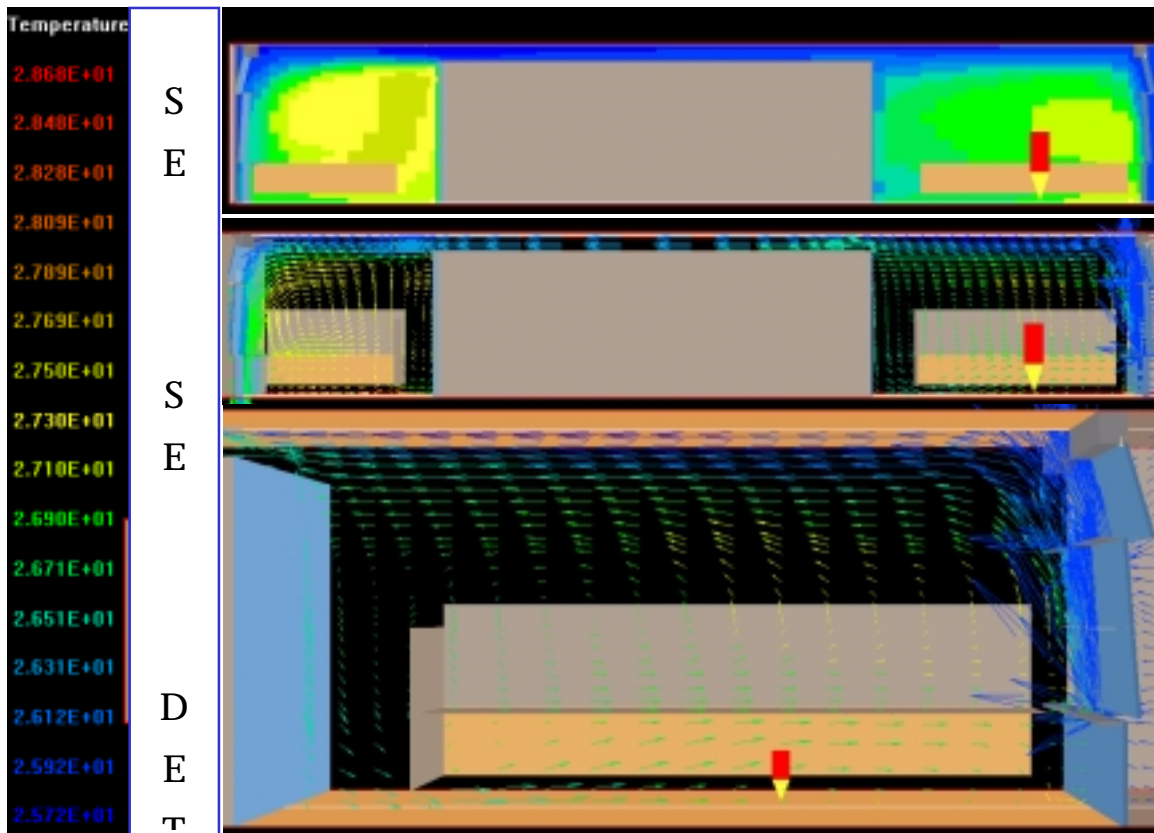

Figure 28. Calculated Flow In The Proposed San Francisco Federal Building

Significant Research Products

Carrilho da Graça, G., Haves, P. and Linden P.F.

The Model Implementation in EnergyPlus. simplified models that were developed have been implemented in the Department of Energy building thermal response simulation tool EnergyPlus for testing purposes and for use in Project 1 Appraisal of System Configurations, as described above. It is planned to include the models in the next public release of EnergyPlus, scheduled for August 15, 2003.

Simplified Models Of Wind-Driven Cross Ventilation And Displacement Ventilation.

Carrilho da Graça, G. PhD Thesis, University of California, San Diego. 2003

This thesis provides a comprehensive description of the model development work.

Defining A Global Room Surface Heat Transfer Coefficient.

Carrilho da Graça G., Linden P. F.. Presented and published in the proceedings of RoomVent 2003, Copenhagen, Denmark.

This paper presents a simple conceptual approach to room surface convective heat transfer for two room ventilation strategies: mixing and cross-ventilation. A global room heat transfer coefficient is defined, clearly quantifying the reduction in heat transfer due to the finite heat capacity and recirculations that occur in the ventilation flow, allowing for direct analytical comparison with perfect mixing ventilation systems. The approach

used in this study seeks to capture the dominant physical processes for these problems with first order precision and to develop simple analytical convective heat transfer models that show the correct system behavior trends.

Simplified Modeling Of Cross Ventilation Airflow. Carrilho da Graça G., Linden P. F. Published in ASHRAE Transactions V109 Pt.1, Atlanta, USA.

This paper describes a simplified approach to cross-ventilation based on scaling arguments, dimensional analysis and computation fluid dynamics calculations. Correlations are found between the internal flow and the inlet and outlet configurations and the room geometry. It is recognized that in many cases the airflow can be divided into a main jet between the inlet and the outlet and recirculation regions. The properties of these regions are determined, and the results applied to pollutant transfer both in a single space and between connected spaces. Heat transfer is also studied and presented in detail.

Use Of Simulation In The Design Of A Large, Naturally Ventilated Office Building. Haves, P. Carrilho da Graça, G., & Linden, P.F. 2003. Proc. Building Simulation, 2003, Eindhoven, The Netherlands.

Design And Testing Of A Control Strategy For A Large, Naturally Ventilated Office Building. Carrilho da Graça, G., Linden, P.F., McConahey, E. & Haves, P., 2003, Proc. Building Simulation, 2003, Eindhoven, The Netherlands.

These two papers deal with the simulation of the San Francisco Federal Building. The first paper discusses the use of EnergyPlus and computational fluid dynamics to determine the performance of the building. It was shown that the flow is primarily wind-driven, and that significant recirculation regions occur in the occupied parts of the building. The modified version of EnergyPlus was then used to develop and test the control strategy for the building.

CONCLUSIONS AND RECOMMENDATIONS

Conclusions

- Models have been developed for some of the main low-energy cooling strategies that are used in buildings. These include wind-driven and stack-driven natural ventilation, mechanical displacement ventilation, and the effects of night cooling.
- A flow decision maker was developed that determines when the ventilation produces mixed conditions
- These models have been implemented in EnergyPlus
- The implementation in EnergyPlus has been used successfully in connection with the new San Francisco Federal Building and the San Diego Childrens' Museum.

Commercialization potential or commercialization initiated

- The models will be included in Version 1.2 of EnergyPlus, which is scheduled for release in April 2004. EnergyPlus is free to the end-user and so the models will be accessible to all those who wish to use them.
- The models themselves will be available to other simulation program developers who wish to incorporate them in their programs. One candidate program is

DOE-2, which is widely used in California. However, further investigation would be required to determine the applicability of the models to programs that do not perform explicit heat balances on interior surfaces.

Recommendations

- The present implementation is a first step in the introduction of low energy cooling systems into energy codes. It currently has the status of a research tool. It needs significant further development and testing before it can be considered to be a validated tool for a wide range of building applications.
- A major barrier to the use of natural ventilation models in EnergyPlus is the link with the flow model COMIS. This link is very restrictive and difficult to use in practice.
- Further research is needed on linking different forms of ventilation, such as natural displacement ventilation in the presence of wind, chilled ceilings, and/or sun patches.
- There needs to be integration of the systems for hybrid buildings. Currently it is only possible to use EnergyPlus in the fully conditioned or fully naturally-ventilated modes.
- A simple and explicit user interface is needed for EnergyPlus that incorporates the required input and output information for low-energy cooling systems.
- The control of low-energy cooling systems is a major problem. This subject is crucial for the successful implementation of designs and is very poorly understood.

BENEFITS TO CALIFORNIA

The potential benefit of this project is that, for the first time, there is a tool that designers can use to estimate the savings of various low energy cooling strategies. Without such a tool, it has been impossible to persuade owners of the advantages to moving away from energy-inefficient HVAC systems towards more energy efficient cooling methods. This is particularly important for California, since there are many regions in the state with climate that is well-suited for low energy cooling applications. Facilitating the design of energy efficient cooling methods can lead to dramatic reductions in the energy used to cool and ventilate CA buildings

5.0 Element 5 Integrated Commissioning and Diagnostics

INTRODUCTION

The building design and construction industry has become highly segmented and fee-restrained in recent years. In this highly competitive marketplace, owners seldom receive fully functional building systems. A study by the Wisconsin Energy Center (1998) found that 81% of the owners surveyed encountered problems with new heating and air conditioning systems. Another study of 60 buildings by LBNL found that half were experiencing controls problems, 40% had HVAC equipment problems, 15% had missing equipment, and 25% had energy management systems, economizers, and/or variable speed drives which were not functioning properly.

It has been shown that these problems can be avoided if buildings are properly commissioned. While commissioning has many definitions, in this project, we consider commissioning to be “a set of services intended to ensure and document quality building system performance, facilitate building operation, yielding improved owner/occupant satisfaction.” This process enables buildings to operate according to design intent, i.e. as they were designed to operate. However, a clear statement of design intent is often lacking. Many buildings do not work because there are no detailed sequences for installing or operating the systems. Even more alarming, the designer is often unable to describe how the system is to work, leaving final installation and set-up to the controls contractor. It has been shown that buildings that are properly commissioned not only provide better comfort for the occupants; they are also easier to operate and cost less to operate.

The principle concern of the design engineer is to ensure that the heating and cooling systems installed in a building are capable of providing comfort to the occupants under all conditions that may be reasonably anticipated. This results in “safety factors” being added to the sizing of chillers, boilers, ducts, fans, pumps, etc. throughout the building to account for unusually hot/cold weather, changes in use, and equipment which doesn’t meet the catalog specification. Most large buildings must be designed so they can simultaneously provide heating and cooling which is required during at least part of the year. The principle concern of the operator is to provide comfort to the occupants and minimize the number of hot calls and cold calls. The usual result from this combination of oversized components, simultaneous heating and cooling capability, and the natural response of the operator to “turn up” the cooling in response to a hot call often result in recurring comfort problems and inefficient operation.

OBJECTIVES

The overall technical goal of this program element is to improve the energy performance of California commercial buildings by up to 20% over the next 10-20 years, while improving comfort. More specifically, the project intends to develop, refine, and make available the techniques, tools and other information needed to make:

- Commissioning of new commercial buildings normal practice in California within five years.
- Continuous commissioning or tuning of existing building systems widely practiced in California within five years; and

- Commissioning and continuous commissioning generally adopted within the commercial building sector in California within 10 years.

The specific, technical objectives are:

- Assemble and develop the functional tests needed for routine commissioning of new building systems;
- Develop diagnostic procedures needed by operators and service personnel to decipher test results and operate buildings efficiently;
- Assemble and create techniques suitable for use by HVAC engineers and operators to optimize energy performance of buildings; and
- Develop simulation-based test and optimization procedures.

The overall economic goal of this program element is to establish the economic benefits of commissioning and commissioning costs in California that will move commissioning into the mainstream of California practice.

The specific economic objective is to provide continuous commissioning or “optimization” procedures that demonstrate economic payback of 1-2 years and hence offer a powerful economic incentive for implementation.

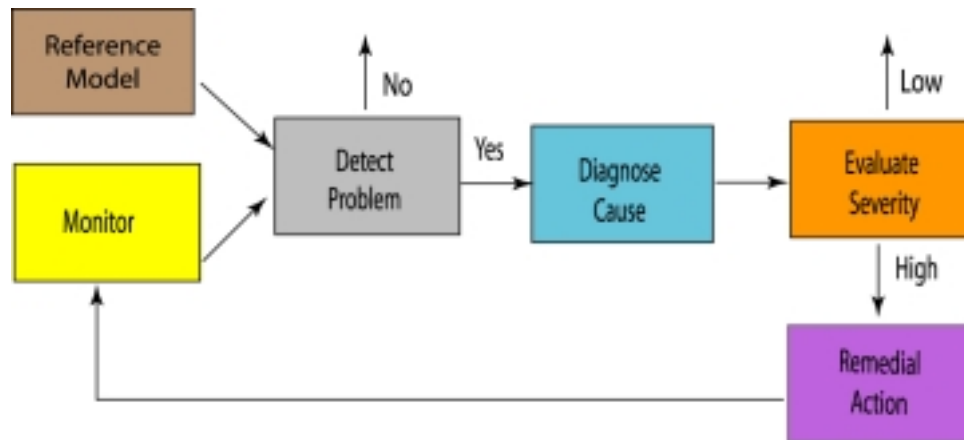

Figure 29. The Role Of Performance Monitoring And Fault Detection And Diagnosis In Improving The Operation Of Building

Project Team and Technical Advisory Group (TAG)

Element 5 was lead by David Claridge of the Texas A&M University. Work was also performed at LBNL, and at PECCI, MIT, UC Berkeley, University of Nebraska as subcontractors. Significant contributors to this element included:

- T. Haasl (PECCI)
- H. Friedman (PECCI)
- D. Sellars (PECCI)
- M. A. Piette (LBNL)
- C. Culp (Texas A&M)

- L Norford (MIT)
- K. D. Lee (MIT)
- S. B. Leeb (MIT)
- C. Federspiel (UC Berkeley)
- W. D. Turner (Texas A&M)
- P. Haves (LBNL)
- P. Xu (LBNL)
- M. Liu (University of Nebraska)

The Technical Advisory Group (TAG) included:

- Paul Tseng (CH2M-Hill)
- Robert Sonderegger (Silicon Energy)
- Debby Dodds (CH2M-Hill)
- David Hansen (DOE)
- Ken Gillespie (PG&E)
- Mark Hydeman (Taylor Engineering)
- John Williamson (Andover Controls)
- Jay Santos (Facility Dynamics)
- John House (Iowa Energy Center)
- Ryan Stroop (PG&E)
- Clay Nessler (Johnson Controls)
- Dru Crawley (DOE)
- Tim Salisbury (Johnson Controls Inc.)
- David Bornside (Siemens)

5.1. Commissioning and Monitoring for New Construction--(Element 5, Project 5.1)

INTRODUCTION

Background and Overview

Functional Test Guide and Test Procedures

Pacific Gas & Electric's Commissioning Test Protocol Library (CTPL) brings together most of the publicly available commercial building commissioning test procedures and is an important step in standardizing and increasing the cost-effectiveness of commissioning services. However, a test library provides information on how and what to test but does not provide information on why a test is important and other details about how to execute the test. For these reasons, the Functional Test Guide for Air Handlers (FT Guide) was developed. The FT Guide adds significantly to the robustness of the test library and along with the CTPL will provide direction toward

standardization and quality control, which continue to be overarching issues for the commissioning industry.

Control System Design Guide

Control systems are often the most problematic system in a building. A good design process that takes into account maintenance, operation, and commissioning of control systems can lead to a smoothly operating and efficient building. HVAC designers are the primary audience for the Control Systems Design Guide (Design Guide). The control design process it presents will assist HVAC designers in producing well-designed control systems that achieve efficient and robust operation. The spreadsheet examples for control valve schedules, damper schedules, and points lists can streamline the use of the control system design concepts set forth in the Design Guide by providing convenient starting points from which designers can build.

OBJECTIVES

- To assemble and develop a set of reference tools, test procedures, and guides to support the commissioning of heating, ventilation, and air conditioning (HVAC) systems
- Supply testing providers with practical information on how to improve their functional testing services
- Improve the accessibility and utilization of the CTPL by incorporating the library into an educational resource
- Make the CTPL, FT Guide and the Design Guide available to new and experienced commissioning providers in a single software package
- The control design processes that the Design Guide presents will assist HVAC designers in producing well-designed control systems that achieve efficient and robust operation

APPROACH

Development of the FT Guide included:

- Researching and developing educational material to help users better understand the purpose, instrumentation, test conditions, potential problems, and cost-effectiveness behind air handling system test procedures
- Identification and development of additional functional tests that were not publicly available in the CTPL
- Peer review by commissioning industry experts involved in building design, construction and operation.
- Development of software features that bring the CTPL and FT Guide to the user as a single package that allows the user to access the functional tests in the CTPL and edit the tests to fit their specific project.

Development of the Design Guide included:

- Researching information and developing educational material to help designers make intelligent decisions about control and monitoring point selection to improve efficiency and control over the life of the building.
- Peer review by commissioning and design industry experts involved in building design, construction and operation.

OUTCOMES

Technical Outcomes

- The Control System Design Guide and Functional Testing Guide for Air Handling Systems (CSDG&FTG) has been completed. The finished product is a MS Word document that is available for download at the HPCBS website.
- The CSDG&FTG was developed to support and facilitate the use of PG&E's Commissioning Test Protocol Library (CTPL). Links to the CTPL are provided throughout the guide, to assist users in accessing tests.

The FT Guide takes a practical approach to understanding the fundamentals of air handling systems as they relate to functional tests. The educational information included assists users in the following aspects of functional testing:

- ▶ Benefits
- ▶ Purpose
- ▶ Instrumentation
- ▶ Test conditions
- ▶ Time required to test
- ▶ Acceptance criteria
- ▶ Potential problems and cautions
- ▶ Common problems
- ▶ Theory behind the tests
- ▶ Example calculations for quantifying energy savings

The FT Guide is designed to assist users in selection of the appropriate level of testing for a given project. This information has been developed for the following air handler components:

- Outdoor Air Intake
- Fan Casing
- Economizer and Mixed Air
- Filtration
- Preheat
- Cooling
- Humidification

- Reheat
- Warm-Up
- Fans and Drives
- Distribution
- Terminal Equipment
- Return, Relief and Exhaust
- Scrubbers
- Management and Control of Smoke and Fire
- Integrated Operation and Control

Figure 30 is an excerpt from the FT Guide that shows an example of the supporting information to a newly developed functional test.

Functional Testing Supporting Information

Relative Calibration Functional Test Description

The Relative Calibration Test is an example of a fully developed test to supplement a gap identified in the Commissioning Test Protocol Library.

The purpose of the test is to ensure the relative accuracy of a group of sensors associated with a system or selected portion of a system where errors related to the calibration accuracy window of the sensors could cause energy to be wasted or operating data to be misinterpreted.

Functional Test 5: Relative Calibration

Functional Testing Benefits

Benefit	Comments
Energy Efficiency Related Benefits	1. Minimizes the potential for simultaneous heating and cooling due to the specific operating point of the system.
Other Benefits	1. Improves system operability by ensuring temperature differences that do not exist during calibration, a temperature rise across a zone that is inactive really will be an indicator of poor system performance. 2. Improves system performance by minimizing misrepresenting what is actually going on, either manually or automatically.

Relative Calibration Functional Test

Instructions: For each system included on the checklist, verify the items indicated using Yes for acceptable, No for unacceptable, or NA for Not Applicable. For unacceptable items, identify what is required to correct the problem in the comments area provided. Use numbers to refer to comments. Identify the responsible contractor, if known, for any items requiring further action.

Equipment Required:

1. Field thermometer of some sort.
2. Lab grade thermometer (Optional, but highly desirable)
3. Minute by minute trending of points to be tested (Optional)
4. Shortridge meter with temperature probe (Optional but if available can be used as the field thermometer)

Acceptance Criteria: This test places the system in a steady state operating mode and then adjusts the return air temperature sensor, the mixed air temperature sensor, the warm-up coil discharge temperature sensor and the air handling unit discharge temperature sensor so that they read the same value when subjected to the same operating condition. Acceptance criteria are as follows:

1. With the system in a steady state condition, all sensors read the same value relative to a baseline, within their accuracy tolerance prior to adjustment.
2. With the system in a steady state condition, all sensors read the same value after adjustment.

The test will be performed at two different temperature levels in an effort to provide consistent readings from these sensors under all normally encountered operating conditions.

Date(s) of Test: _____

Time(s) of Test: _____

Test Technician: _____

Functional Testing Field Tips

Item	Comments
Purpose of Test	The purpose of the test is to ensure the relative accuracy of a group of sensors associated with a system or selected portion of a system where errors related to the calibration accuracy window of the sensors could cause energy to be wasted or operating data to be misinterpreted.
Instrumentation Required	The fundamental test can be performed with the sensors that are being tested. How helpful to establish the baseline for comparison. Minute by minute trending or data logging is useful to document the test results. A Short probe makes checking the average mixed air parameter measured by the sensors undergo process can be assumed to be uniform at all system under test.
Test Conditions	The system needs to be placed in a steady state operating mode and then adjusts the return air temperature sensor, the mixed air temperature sensor, the warm-up coil discharge temperature sensor and the air handling unit discharge temperature sensor so that they read the same value when subjected to the same operating condition. Acceptance criteria are as follows:
Time Required to Test	Test times will vary from 15 minutes to an hour.

Hyperlink to sample procedure and test template

Item Number	Requirement	Initial and Date when Complete
Prerequisites		
1	Verify that all applicable prestart and start-up verification checks from the equipment manufacturer have been completed and that the system is fully functional.	
2	Verify that the sensors that are to be tested are certified and installed per the accuracy requirements of the specifications.	
3	Visually inspect the sensors that are to be tested to verify that they are installed in a manner that will allow them to measure the parameter intended and are free from influences due to mounting arrangement or configuration.	
4	Verify that the loads served by the system can tolerate the 15 to 60 minute period of operation with out active discharge temperature control that is required to perform this test.	
5	Target a day for the test when it is anticipated that the outdoor conditions will be in the mid 50°F range and suitable for operating on 100% outdoor air with out the need to heat or cool. This will allow calibration at two operating points. If the test cannot be scheduled for such a day prior to substantial completion, then proceed with the test in the full recirculation mode only.	
Preparation		
Relative Calibration Test		1

Figure 30. Excerpt from the Functional Testing Guide: Relative Calibration Test

The Control System Design Guide provides a toolbox of templates for improving control system design and specification. The spreadsheet examples for control valve schedules, damper schedules, and points lists for twelve system configurations will streamline the use of the control system design concepts set forth in the Design Guide by providing convenient starting points from which designers can build.

The following technical areas are covered in detail in the Design Guide:

- Control System Design Process: How and why to include system diagrams, points lists, specifications, floor plans, and standard details in your next project.
- Selection and Installation of Control and Monitoring Points: Recommendations for selecting and installing temperature, humidity, pressure, and flow sensor technologies guide both designers and commissioning providers through the ever-changing world of sensors. How to select points for a commissionable system is also covered.
- System Configurations: For each of the twelve system configurations presented, the following information is provided:
 - ▶ Description of function
 - ▶ Points list
 - ▶ Appropriate applications
 - ▶ Energy conservation control strategies

3.5.4. Pressure and Flow

Table 3.3 presents a variety of pressure measurement technologies for air and water. The capacitance, strain gauge, and piezoresistive technologies compete with each other since they offer accuracy at a reasonable cost in a variety of levels of quality. LVDTs compete with the lower cost versions of these technologies. For all of these devices, pressure transients in the air or water may cause erroneous readings. For example, pressure pulses from the pumps can be pressure measurements. A pressure pulse can also be created from a door slam at a diffuser location and near the duct static pressure measurement point, pressure pulses can cause the control loop to hunt.

Technology summary

Table 3.3 Pressure Measurement Technologies

Technology	Function	Advantages	Disadvantages
Velocity Probes	Measures pressure differential based on velocity through a tube across the pressure difference.	Can accurately and repeatedly measure to Reynolds and low Reynolds number flow velocity conditions and for low velocity conditions.	Highly sensitive to other technologies, causing the length critical size-flow in air flow through the tube - low flow could impact the accuracy of the report because the pressure drop through these would affect the flow and flow in the inducer and/or measure pressure differential.
Manometer	Measures the change in pressure by being directly connected to the process.	Highly accurate and reliable.	Highly sensitive to other technologies, causing the length critical size-flow in air flow through the tube - low flow could impact the accuracy of the report because the pressure drop through these would affect the flow and flow in the inducer and/or measure pressure differential.
Capacitance	Pressure changes in capacitance based on displacement in a capacitance is used to generate an output.	Highly accurate and reliable.	Highly sensitive to other technologies, causing the length critical size-flow in air flow through the tube - low flow could impact the accuracy of the report because the pressure drop through these would affect the flow and flow in the inducer and/or measure pressure differential.
Strain Gauge	The deflection of a strain gauge is used to generate an output.	Highly accurate and reliable.	Highly sensitive to other technologies, causing the length critical size-flow in air flow through the tube - low flow could impact the accuracy of the report because the pressure drop through these would affect the flow and flow in the inducer and/or measure pressure differential.
Piezoresistive	A pressure change causes a change in resistance.	Highly accurate and reliable.	Highly sensitive to other technologies, causing the length critical size-flow in air flow through the tube - low flow could impact the accuracy of the report because the pressure drop through these would affect the flow and flow in the inducer and/or measure pressure differential.
Linear Variable Differential Transducer (LVDT)	An electric output proportional to the displacement of a core in a magnetic field.	Highly accurate and reliable.	Highly sensitive to other technologies, causing the length critical size-flow in air flow through the tube - low flow could impact the accuracy of the report because the pressure drop through these would affect the flow and flow in the inducer and/or measure pressure differential.

Application details

3.5.1.1. Space temperature

Accuracy
± 0.1°F (± 0.1°C)

Location
Locate the sensor away from electronics and other heat sources. Avoid locations where air deflection may be significant. Also avoid exterior walls and ceilings that connect to plenums from duct infiltration and surface wall surface temperatures can affect the sensor reading. It may be necessary to completely insulate the sensing line or sensor the thermostat as an insulating pad. It is also important to make sure that small leaks of air caused by infiltration or pressure air flow is plenum-rated through the duct cavity and fitting the sensor are eliminated.

Calibration
Calibrate sensor if complete or partial replacement cable sensor and/or based on sensor drift specifications from the manufacturer. The accuracy of a lower quality thermostat may allow a drift of 1.0°F per year, which could add up over 5-10 years. If a sensor were used to control under control, it's probably worth going and taking a look. You may discover that the sensor is accurately reporting what it is seeing, but it's being influenced by a draft, infiltration or vent stack.

3.5.1.2. Duct temperature

Figure 31. Excerpt from Selection and Installation of Control and Monitoring Points Chapter

Market Outcomes

- Initial feedback on the CSDG&FTG has been positive as the industry recognizes the need for this type of educational material and the need to disseminate standardized procedures in the CTPL
- The response to the public download site has been very good, with commissioning providers and researchers interested in obtaining standardized functional tests and to understand how to plan for testing and act on the results. As of the end of August 2003, there have been over 125 downloads.
- Representatives from five major controls manufacturers - Johnson Controls, Siemens, Invensys, Honeywell, and Trane – have downloaded the guides.
- CD-ROM copies of the Guides were distributed at the National Conference of Building Commissioning in May 2003, (200 copies), and at BOMA's 2003 Office Building Show in Moscone Center, San Francisco, (60 copies). Additional copies are available through the PG&E Pacific Energy Center's Resource Library
- This tool has become an important framework for evaluating what additional commissioning testing material is needed for international development by the IEA Annex 40 research group. It is receiving international attention and influence commissioning firms throughout the world.

Significant Research Product

Control System Design Guide and Functional Testing Guide for Air Handling Systems.

D. Sellers, H. Friedman, T. Haasl, M. Piette, N. Bourassa

Public Download site: <http://buildings.lbl.gov/hpcbs/FTG>

The Control System Design Guide and Functional Testing Guide for Air Handling Systems was released to the public at the National Conference on Building Commissioning 2003.

CONCLUSIONS AND RECOMMENDATIONS

Conclusions

- Initial feedback on the FT Guide has been extremely positive as the industry recognizes the need for the educational material as well as the need to disseminate the standardized procedures in the CTPL. This resource is expected to become a mainstream tool for commissioning providers on the national level.
- Initial feedback on the Control System Design Guide has been extremely positive as the design and commissioning industry recognizes the need for improved control systems knowledge in an ever-changing controls industry.

Commercialization Potential or Commercialization Initiated

The functional test and control system design guide are intended to be placed in the public domain for common use by building engineers, designers, and commissioning agents. The deployment path is to make it available to engineering groups such as the California Commissioning Collaboration, IEA Annex 40, ASHRAE, the Building Commissioning Association, and other similar groups. Incorporation of the guidelines into common practices is equivalent to commercialization.

This project successfully demonstrated that there is a need for tools and reference materials that can help the growing building commissioning industry obtain standardized methods to test installed systems. Feedback also indicates that standardized processes for control system design are a valuable part of solid commissioning practice.

Two rounds of practitioner comments were implemented into the project development and all copies of the finished product include a feedback form that helps to direct further development efforts. Since the public release, over 300 copies have been distributed. The product is an educational resource as well as a document management tool and as practitioners use it, we expect to obtain feedback on how to expand its effectiveness.

Recommendations

The effectiveness of the Control System Design & FT Guides could be greatly enhanced with the provision of a training program based on the Guide. Two training tracks could be developed:

- Design practices training based on the Control System Design Guide with real-world examples of how the design process has been implemented and classroom activities in which the participants apply these concepts.
- Commissioning provider training would focus on describing good functional tests, how to use the FT Guide to improve functional testing and detailed technical examples regarding the most problematic air handling subsystem and system interactions. Training would also include a hands-on exercise using the FT Guide to create a test, and then performing the test on the systems at the training facility. As participants use it in real functional testing situations, feedback should be gathered to better understand its use.
- Gaps in publicly available functional test procedures should be gathered by surveying commissioning providers. Tests should be written to fill these gaps, and the tests incorporated into the FT Guide.

BENEFITS TO CALIFORNIA

- By improving the resources available to commissioning professionals, the FT Guide will strengthen the commissioning infrastructure and contribute to improving the quality and standardization of commissioning services. This is particularly important to California, because the state's commissioning industry is at a nascent stage and will benefit greatly from educational resources as well as standardization of services.
- Through a thorough functional testing process, commissioning providers have the opportunity to find and correct operational problems that lead to significant amounts of energy waste.
- By improving the practical application of controls resources available to designers, the Control System Design Guide will help improve building designs and specifications.
- The Design Guide identifies critical design decisions that drive the energy implications for the building life cycle. Promoting sound control design methods

up-front in the design process avoids noticeable problems, as well as hidden energy waste that often occurs undetected for the life of the building.

5.2. Fault Detection and Diagnostic Procedures (Element 5, Project 5.2)

INTRODUCTION

Background and Overview

This project includes two sets of activities, one set from LBNL and one set from UC Berkeley. These can be considered as: (1) EMCS and EIS tools, and (2) Fan Diagnostic tools. Numerous problems exist in obtaining access to and organizing data for diagnostic analysis. The building commissioning process often utilizes short term data in conjunction with engineering measurement protocols, analysis, and data visualization that allows practitioners to identify problems and implement the measures needed to optimize building operation and save energy. There is a lack of consistency in methods to accumulate data over time from many projects that could be helpful to the analysis task at hand for a particular building.

Objectives

- Evaluate current diagnostics tools and systems in order to help improve future implementations of diagnostic tools for both energy and peak demand analysis. The emphasis was on large buildings with Energy Management Control Systems.

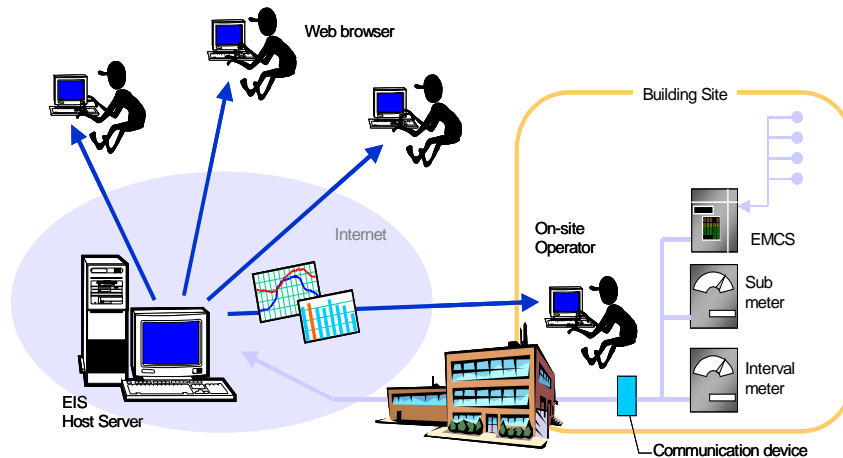

Figure 32. Schematic Of Approach

- The objective of the UCB Fan diagnostics project was to evaluate and develop a consistent methodology for fan diagnostics. These tools and protocols are intended to provide a convenient way to screen for problems in air handling units (AHUs) as well as support more in-depth studies when problems are found. The Center for Environmental Design Research (CEDR) at UC Berkeley developed diagnostic protocols and a software “toolkit” (UCB AHU Toolkit) to help practitioners identify and rectify problems for large built-up air handling units. The overall objective was to contribute to the development and demonstration of diagnostic methods for fan systems with a focus on finding

problems with significant energy impacts using short term monitoring techniques.

APPROACH

The LBNL project approach consisted of the following:

- Analyzing current diagnostic tool software (PACRAT, Whole Building Diagnostician, Enforma, etc.)
 - ▶ Develop categorization framework for diagnostic tools.
 - ▶ Review scope of HVAC systems analyzed, points utilized in diagnostics, data acquisition systems and data management, diagnostics techniques and models, problems and anomalies identified, etc.
 - ▶ Acquire and test tools (done for the majority of them).
 - ▶ Compare and contrast.
- Analyzing current Energy Information Systems
 - ▶ Develop categorization framework for energy information systems, web-based control systems and demand-response systems.
 - ▶ Review scope of current tools and systems focusing on systems in California.
 - ▶ Acquire and test tools and systems.
 - ▶ Compare and contrast.
 - ▶ Report on results in research papers and conferences.
- Conduct case study analysis of EIS to evaluate costs, benefits, and document use.

The approach of the UC Berkeley fan diagnostics project was to investigate the efficacy and utility of existing protocols by field-testing them. Specific tasks included:

- Identify out of the existing UCB AHU Toolkit, those tools and charts most appropriate for analyzing built-up fan systems.
- Populate the fan performance database with field-collected data.
- Refine and modify the protocols as necessary based on lessons learned during field-testing.
- Make recommendations for further development and implementation of the protocols and toolkit.

OUTCOMES

Technical Outcomes

- The diagnostics tools analysis provided a technical framework for comparing the scope of EMCS trend logs used in several diagnostic tools. The scope of the problems found in different tools were also compared.
- The EIS report was successful in creating a technology characterization framework that has been useful for the California Energy Commission in

Demand Response research and other areas. The EIS vendors have been extremely receptive about the value of the study because it provides an independent review of this significant emerging technology. Such technology will become more and more important in performance tracking and energy management in commercial buildings. A preliminary version of the report was presented at the National Conference on Building Commissioning.

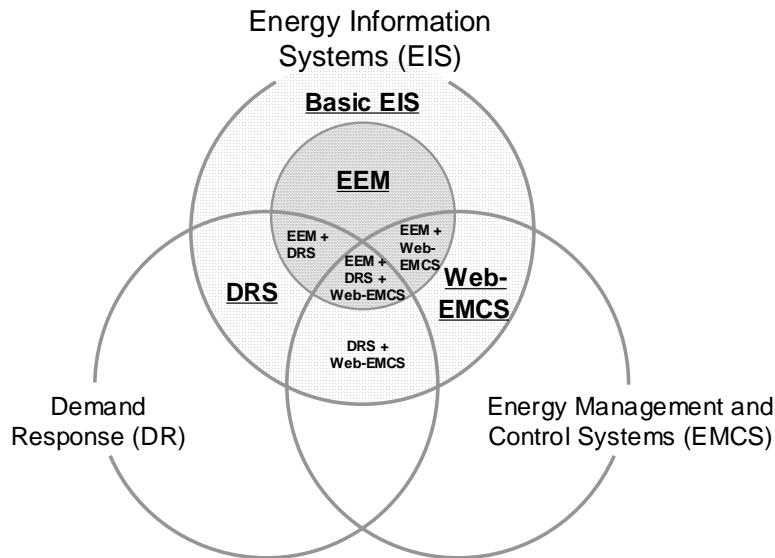

Figure 33. . Schematic of Energy Information Systems

The final few months of the project has included reviewing the costs and benefits of EIS, including a review of General Services Administration buildings, UC Santa Barbara, and buildings that have the Information Monitoring and Diagnostic Systems (IMDS). This paper will be presented at ICEBO, 2003.

The UCB project outcomes are as follows:

- This project successfully identified several tools out of the fan analysis toolkit that are good candidates to support diagnostics work on fan systems. These tools are all dedicated to analyzing VAV systems, which were the focus of study since the trends are for these systems to make up a significant fraction of the building stock (at least in California). The three buildings analyzed serve as the initial population for the fan performance-benchmarking portion of the toolkit. With only three buildings the usefulness is somewhat limited but it is clear that with further population of the database this tool could be very effective in supporting analyses.
- Among the significant improvements made in the protocols was the development of a revised method for estimating performance at a design-equivalent condition. Also, methods for measuring airflow using tracer gas techniques were further developed and their potential was demonstrated.
- Finally, a detailed set of recommendations for technical improvements and interface enhancements were prepared that will substantially improve the usability and performance of the tools.

Market Outcomes

- The diagnostics tools report serves as an example for what building owners can request in future analysis tools. It is cited in PECO's guide "Strategies for Improving Persistence of Commissioning Benefits," and is being broadly circulated to utility customers involved in retro-commissioning programs.
- This body of work establishes a benchmark for companies developing Energy Information Systems. It is being used in white papers from EIS developers such as Webgen (/www.webgensystems.com) and has received positive support and review from EIS companies throughout the U.S.
- The EIS and diagnostic tools guides are also being circulated to building operators and used for curriculum development for operators as an important element of a proposed National Science Foundation grant on education in community colleges for building technicians and operators.
- This research has been useful to CEC Demand Response planners to help evaluate new products for demand response and energy information systems.

Significant Research Products

Comparative Guide to Emerging Diagnostic Tools for Large Commercial HVAC Systems
(H Friedman and M. A. Piette).

<http://www-library.lbl.gov/docs/LBNL/486/29/PDF/LBNL-48629.pdf>

This guide compares emerging diagnostic software tools that aid detection and diagnosis of operational problems for large HVAC systems. We have evaluated tools for use with energy management control system (EMCS) or other monitoring data. The diagnostic tools summarize relevant performance metrics, display plots for manual analysis, and perform automated diagnostic procedures. There are two main purposes in writing this guide: 1) to help potential tool users gain an understanding of key diagnostic capabilities that could affect tool implementation with EMCS data, and 2) to provide tool developers with feedback by identifying important features and needs for future research.

Web-based Energy Information Systems for Energy Management and Demand Response in Commercial Buildings

(N. Motegi, M. A. Piette, S. Kinney, and K. Herter)

http://buildings.lbl.gov/hpcbs/pubs/E5P2T1b5_LBNL52510.pdf

Energy Information Systems (EIS) for buildings are becoming widespread in the U.S., with more companies offering EIS products every year. As a result, customers are often overwhelmed by the quickly expanding portfolio of EIS feature and application options, which have not been clearly identified for consumers. The object of this report is to provide a technical overview of currently available EIS products. This report focuses on web-based EIS products for large commercial buildings, which allow data access and control capabilities over the Internet. EIS products combine software, data acquisition hardware, and communication systems to collect, analyze and display building information to aid commercial building energy managers, facility managers, financial managers and electric utilities in reducing energy use and costs in buildings. Data types commonly processed by EIS include energy consumption data; building characteristics; building system data, such as heating, ventilation, and air-conditioning (HVAC) and

lighting data; weather data; energy price signals; and energy demand-response event information. This project involved an extensive review of research and trade literature to understand the motivation for EIS technology development. This study also gathered information on currently commercialized EIS. This review is not an exhaustive analysis of all EIS products; rather, it is a technical framework and review of current products on the market.

Development of Fan Diagnostic Methods and Protocols for Short Term Monitoring UCB Toolkit of Built-up Fan System Diagnostics. Webster, T., University of California, Berkeley and A. Barth, Nexant Energy Management Group. February 2003 (Download, 2.9 MB) <http://buildings.lbl.gov/hpcbs/Pubs.html> and <http://buildings.lbl.gov/hpcbs/pubs/E5P22T4d-UCBFanDiag-final.pdf>

Substantial progress was made in development of the fan diagnostic protocols. Experience in monitoring and analyzing three buildings facilitated a critical examination of the protocols. Changes were made where feasible, and a comprehensive list of changes and additions was developed that would improve the tools and protocols significantly. This experience emphasized the kind of iterative effort it takes to bring the development of tools like these to viability.

CONCLUSIONS AND RECOMMENDATIONS

Conclusions

The LBNL research has found that there is opportunity for advanced energy information systems and diagnostic tools in commercial buildings. Innovative energy managers and building operators have embraced such tools and demonstrated their usefulness to minimize energy use and energy costs, identify operational problems, improve comfort, reduce maintenance costs, and control peak demand. This technology is also important to become a platform for emerging advanced commissioning and diagnostic techniques and tools. One of the difficulties in the deployment of advanced diagnostic tools is the poor information infrastructure, issues which EIS and web-based control systems help address.

The UCB research on short term data monitoring (augmented by a few crucial additional parameters) has been reaffirmed as the right choice for these procedures. There are benefits to knowing the accuracy, placement, consistency and format of the data sets that argue strongly for use of short-term techniques versus BMS trended data (at least those that typically exist in the installed base). However, as demonstrated by this project, there is no inherent restriction against using BMS data in them. Once appropriate data sets are provided, using the toolkit is very easy. Accurate monitoring of airflow, fan static pressure, and fan speed are the only significant barriers to achieving a robust set of tools.

Commercialization Potential or Commercialization Initiated

This project has assessed and developed several important diagnostic systems, methods, and approaches. This research provides important background technical analysis for many current diagnostic tools developers and EIS companies, and is not intended to be directly commercialized as a product. Rather, this is analysis for the sake of other developers.

RECOMMENDATIONS

- There is a need for continuing development, evaluation, and demonstrations of advanced energy information systems and how they can be used to reduce energy use, peak demand, and energy costs in buildings.
- LBNL has an ongoing project that grew out of this one to evaluate automation in demand-responsive buildings using EIS and related technologies.
- LBNL also has a proposed project to develop a performance monitoring specification that builds on the findings of this project.
- Further development of the tools outlined in the recommendations would significantly enhance the analysis capability of the toolkit. Although the database contains only three fans as the result of this work, it was helpful in understanding performance issues, and demonstrated the potential of a fully populated database.

BENEFITS TO CALIFORNIA

The diagnostic tools review and fan diagnostic techniques contribute to the growing body of research to help reduce energy use in commercial buildings in California. The research products will help grow the market for diagnostic tools because potential users have a reference frame to compare current and future tools. Different building types, HVAC types, and EMCS types can be analyzed. Fans are one of the largest end-uses in many commercial buildings and are the target of the fan diagnostics techniques project.

The review of Energy Information Systems has been a starting point for new work in demand response targeted at the California electricity market to assist in reducing peak summertime loads.

5.3. Guide to the implementation of monitoring systems in existing buildings-- (Element 5, Project 5.3)

INTRODUCTION

Background and Overview

Buildings consume approximately one-third of the energy used in the U.S. A considerable portion of this energy is wasted because of dysfunctional sensors and EMCS systems. Operators often set controls to operate incorrectly because of inaccurate sensors. This usually adversely impacts comfort and energy use. Estimates on energy loss due to dysfunctional sensors exceed 5% of the energy used in buildings today (reference M. Piette).

OBJECTIVES

- Enhance the data logging capability of existing Energy Management and Control Systems (EMCSs) and to develop technology that can be used to determine when specific sensors have drifted out of calibration.

APPROACH

- Develop Guides that specify how specific existing systems can be used for logging of energy by monitoring data. This will encourage such upgrades.
- Develop technology that can detect and correct dysfunctional sensors.

OUTCOMES

Technical Outcomes

- Three (3) Guides were written which will enable owners and building engineers to determine how their EMCS could be capable of being used as an energy data logger. These Guides covered TAC-Americas, Andover Controls and Siemens systems. They can also be used as a general sensor selection guide with other manufacturers' systems.
- A Sensor Fault Detection concept was developed. The concept developed and prototyped enables detection of sensors that drift away from their calibration points. Real systems have noise, which can act like a sensor failure. This technique showed very acceptable performance in the presence of noise. Operators can be notified and sensor values can be dynamically recalibrated until a physical recalibration can be performed. The Extended Autoassociative Neural Network (E-AANN) concept resulted from this work.
- We also planned to research and prototype a characterization engine as the first part of the Sensor Fault concept. The intent was to be able to recognize specified sensor types in an EMCS database. This effort generated a specification but did not yield a useful concept. This task was dropped after approximately 3 months of a graduate student's work so that he could focus on the E-AANN concept.

Market Outcomes

The Data Logging Guides provide the tools needed to upgrade hundreds and probably thousands of EMCS systems to provide superior control based on use of monitored energy use. These guides are available on the HPCBS web site.

- Market deployment was not achieved for the E-AANN research. The intent of this research was to demonstrate a very effective concept on how to measure sensor failures in a wide range of applications – EMCS being the focus.

Significant Research Products

This research yielded an effective concept and demonstration of an Extended Autoassociative Neural Network (E-AANN). This was demonstrated on synthetic chiller data and could find drifts and offsets in sensor calibrations of less than ~2%. The E-AANN performed well with noise levels up to 10%.

Three Guides are now available through the CEC or HPCBS website. These are:

Data Logging Guide for Andover Controls Energy Management and Control Systems, Y. Sakurai and C. H. Culp, Energy System Laboratory, Texas A&M University.

Data Logging Guide for Siemens – EMCS, Y. Sakurai and C. H. Culp, Energy System Laboratory, Texas A&M University.

Data Logging Guide for TAC-Americas – EMCS, Y. Sakurai and C. H. Culp, Energy System Laboratory, Texas A&M University.

A report “***Extended AANN (E-AANN) for Sensor Diagnostics***”, M. Najafi, C. Culp and R. Langari has been issued.

CONCLUSIONS AND RECOMMENDATIONS

Conclusions

The results of the first phase research effort showed that EMCS systems can be brought up to a functional level that allows data logging of critical energy use. The Guides are available and can be used to provide the steps to perform these upgrades, impacting the system functionality and the specific sensors needed. No further work is recommended on the Guides.

The Sensor Fault Detection concept is a breakthrough in diagnosing sensor calibration issues. This technology requires non-orthogonal data, i.e., sensor values must have interdependencies. Most energy systems in buildings satisfy this requirement. Synthetic chiller data was used to test this concept since chillers represent a large portion of the energy use and are difficult to diagnose. This concept was tested at 1%, 5% and 10% noise levels. The AANN detected the drifting sensor values even in the 10% noise. In higher noise, it was found that a larger number of samples needed to be analyzed, effectively adding noise filtering.

Commercialization Potential or Commercialization Initiated

This concept is not ready for commercialization. The potential is quite high. Once fully developed and tested, the software “product” could be easily loaded into EMCSs and track, alert and correct sensor calibration drift and offset behavior.

Recommendations

Further work is strongly recommended as this technology may have far reaching impact. First, additional performance studies are needed to characterize the performance in a thorough manner. Second, a first cut at commercialization in a target EMCS could then be implemented.

BENEFITS TO CALIFORNIA

If implemented on all EMCS systems in California, the savings could exceed 2 to 5% of the energy used in these buildings.

5.4. Integrated Commissioning and Diagnostics Develop and Test Hardware and Software for High –Information-Content Electrical Load Monitoring--(Element 5, Project 5.4)

INTRODUCTION

Background and Overview

Improved operation of buildings depends on accessible and affordable information about the performance of energy-consuming equipment. Progress has been made in recent years in using energy-management systems to record data, and accessing data via

web-based systems for analysis and review. However, the cost of the required sensors has continued to be a stumbling block. In particular, electrical power at the component level is typically not measured, because such measurements are not needed for equipment control.

The purpose of the Non-Intrusive Load Monitor (NILM) is to detect on and off switching of major HVAC loads in commercial buildings, track variable-speed drive loads, and detect operating faults from a centralized location at affordable cost. This information can be used to optimize operations, aid commissioning and diagnostics, or simply to provide the energy manager with short and long term energy-use intensity (EUI) information that is key to maintaining and improving plant efficiency.

OBJECTIVES

- Develop and deploy high-speed electrical load monitoring capable of providing component-specific load information from a centralized location (motor-control center, HVAC service entrance, or whole building), thereby substantially reducing the cost of obtaining information.

APPROACH

- High-speed meters, known as Non-Intrusive Load Monitors or NILMs, were constructed and installed in one commercial office building in San Francisco, three municipal buildings in Los Angeles, and two schools in Contra Costa County. Development of NILM software relied heavily on data from the San Francisco office building.
- NILM algorithms were written to track constant-power and variable-speed-drive (VSD) loads.
- Algorithms were tested, converted to C++ code and installed in the office-building NILM, and tested again.
- NILM website output was upgraded to include load-tracking information.

OUTCOMES

Technical Outcomes

- Developed a working NILM that can detect and track constant-power and VSD loads.
- Developed a Web-based NILM display.
- Tested the NILM with data from a California office building.

Market Outcomes

- Several energy-service providers and two California electric utilities have expressed interest in the NILM. One energy-service company is primarily interested in detecting operating faults in large commercial buildings. One utility has focused on tracking loads in small commercial buildings.
- Building occupants can use the results of this research to provide feedback to facility managers in GSA Region 9 buildings through its incorporation in

GEMnet used in all Region 9 buildings. There are more than 150 buildings in Region 9 that add up to more than 20 million square feet of floor space.

Significant Research Product

Monitoring HVAC Equipment Electrical Loads from a Centralized Location - Methods and Field Test Results. Luo, D., L. K. Norford, S. R. Shaw, and S. B. Leeb. 2002 ASHRAE Transactions Vol. 108, Pt. 1.

Detection of HVAC Faults via Electrical Load Monitoring. Shaw, S. R., L. K. Norford, D. Luo, and S. B. Leeb. 2002. Int. J. of HVAC&R Research 8(1):13-40

Demonstration of Fault Detection and Diagnosis Methods for Air-Handling Units (ASHRAE 1020-RP). Norford, L.K., J. A. Wright, R. A. Buswell, D. Luo, C. Klaassen, and A. Suby. 2002. Int. J. of HVAC&R Research 8(1):41-72

Power Signature Analysis. Laughman, C., K. Lee, R. Cox, S. Shaw, S. Leeb, L. Norford, and P. Armstrong. 2003. IEEE Power and Energy Magazine, March/April, 56-63.

Electrical Load Information System based on Non-Intrusive Power Monitoring. Lee, K.D. 2003. Ph.D. thesis, Department of Mechanical Engineering, MIT, Cambridge, MA.

CONCLUSIONS AND RECOMMENDATIONS

Conclusions

The analytic framework for the NILM and the developed algorithms provide a foundation for further field testing and for code improvements. Previous approaches, both incomplete in scope, incompatible in structure, and largely implemented with off-line data, have been replaced with consistent code, implemented on-line. This makes it possible for the NILM to produce and display useful information, rather than simply computing and storing real and reactive powers at the fundamental and higher harmonics and making those data available for off-line analysis.

The NILM is now capable of tracking all HVAC loads except constant-speed chillers. Work to develop an approach for chillers is underway. For HVAC plants for which all loads except chillers can be tracked, a NILM at the electrical service entry can assign a load to chillers by subtracting off all other loads.

Tracking VSD loads via higher harmonics unique to VSDs represents a significant advance. The method estimates the power drawn by all VSD devices. A reasonable effort should be made in the future to determine whether it is possible to discern individual VSD loads.

This project has also documented a number of faults found with the NILM, artificially introduced (at the Iowa Energy Center's Energy Resource Station) or naturally occurring (in the San Francisco office building). These faults can be identified by analysis of the power data produced by the NILM, a viable approach for savvy building operators or managers with time for such activity or for energy service companies paid for just such work. Further research is needed to automate NILM-based fault detection.

Commercialization Potential or Commercialization Initiated

The NILM has attracted interest from energy-service companies that are potential users of the technology. However, only MIT currently develops and supports NILM

hardware and software, a barrier to its use. An MIT spin-off company is currently considering taking on the role of selling and supporting the NILM, with a market in industry and transportation as well as in buildings.

Recommendations

Hands-off testing of the NILM should be performed in several buildings. The past three years have been devoted to NILM development and have included very modest testing. This testing should be performed in conjunction with an assessment of the value of the NILM, either to building owners and managers directly or to energy service companies.

There is a need for feedback from building operators about desired NILM output: who should receive what kind of information. Service companies contacted by NILM researchers appear capable of using data in their existing format. Limited response from building operators will be sought prior to the conclusion of the project.

BENEFITS TO CALIFORNIA

Monitoring electricity consumption in sufficient detail to identify sources of unnecessary usage and faulty equipment operation benefits both the private and public sectors. The NILM has the potential to provide useful information at minimal cost, making use of computers already installed for building operation. However, there are no benefits specific to California.

5.5. Occupant Feedback Methods for Diagnostic Systems (Element 5, Project 5.5)

INTRODUCTION

Background and Overview

Building occupants possess a large amount of data that could be useful for building operations if it were available and if there were a systematic way to use it. The objective of this task is to develop and deploy web-based information technology to allow occupants of commercial buildings to get access to building operational data relevant to them, and to use information from occupants in a systematic way to improve building operations.

OBJECTIVES

- Develop web-based methods to acquire information from occupants.
- Develop web-based methods to provide information to occupants.
- Develop expert systems to make decisions and take actions based on occupant feedback, current control system information and historical information archived in building system databases.

APPROACH

- Develop a web-based user interface for building occupants.
- Deploy and test the effectiveness of the user interface.

- Develop an expert system that integrates data from occupants with sensor data to provide automated recommendations about how to solve problems in buildings.
- Evaluate the expert system using historical data

OUTCOMES

Technical Outcomes

- We developed a web-based user interface for energy and maintenance systems called Tenant Interface for Energy and Maintenance Systems in collaboration with General Services Administration Region 9. By allowing tenants access to information from the energy and maintenance systems and by giving them some control over these systems, energy and maintenance performance can be improved.
- We interviewed potential users and existing energy and maintenance databases to guide the design. We found that the feature most important to occupants is the ability to track service requests. We included several features from the interviews that should improve occupant satisfaction with maintenance and operations and simultaneously improve operational efficiency.
- We implemented TIEMS as part of the GSA Energy and Maintenance Network (GEMnet) (<https://www.gemnet9.com/gemnetportal/DesktopDefault.aspx>). Figure 34 shows a screen shot of the page that occupants can use to check indoor temperature.
- We tested TIEMS in two GSA buildings in Tucson.

Temperature
In this page you can view the temperature for your default thermostat or set a default thermostat.

- **Default Thermostat** provides the latest temperature of your default thermostat. Your default thermostat is stored in your [profile](#). In order to set a default thermostat follow the next steps.
- To **Set** a thermostat as the default in your profile or **Find** a thermostat in the building you need to:
 1. Select a **Floor**.
 2. Select the nearest **Thermostat** closest to you by reading the label on it.
 3. The **Temperature** information will be displayed. In order to select this thermostat as the default in your profile, click on the button.

Closest Thermostat (8E-14) Temperature Last modified: 12/16/2001 8:26:02 AM
71 ?F / 22?C (Last modified: 12/16/2001 8:26:02 AM)

Set or Find closest thermostat temperature

Step 1. Select Your Floor

Step 2. Select the nearest thermostat label

Step 3. After selecting the floor and thermostat, the temperature will be displayed below.

The temperature at thermostat label 4E-12 is 72°F / 23°C
It was last updated on: 5/1/2002 1:23:55 PM

Click on the button below to set 4E-12 as your default thermostat.

Figure 34. Screen Shot Of TIEMS Temperature Page.

Figure 35 shows service requests per month from occupants who used TIEMS and from those who did not. These data show that TIEMS does not affect the rate at which service requests are reported. The difference in the rate is not statistically significant.

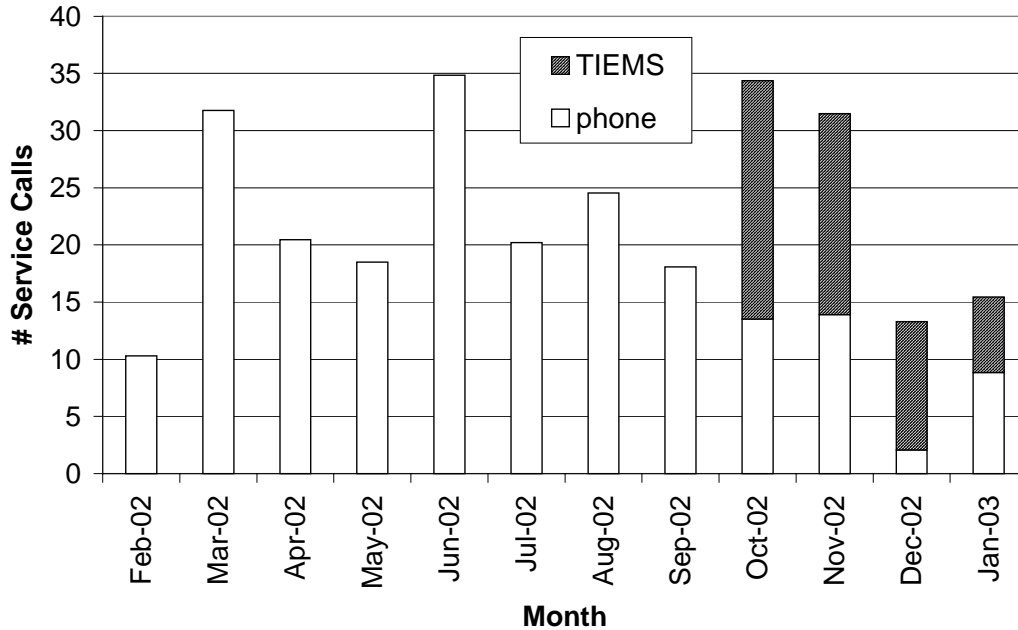

Figure 35. Number Of Service Requests Submitted By Lead Users.

- Table 1 shows the labor hours spent handling service requests reported through TIEMS and by phone. GSA personnel believe that less labor is required for problems reported through TIEMS than for problems reported by phone because the data quality with TIEMS is better. We found that on average maintenance personnel spent 7 less minutes handling service requests reported through TIEMS, but that the difference was not statistically significant. The sample size for TIEMS-reported problems was low, lowering the power of the test considerably. We deployed TIEMS throughout Region 9. There is a link to TIEMS (GSA calls it Tenant Web) on the GEMnet website.

Table 1. Labor Hours Comparison Between TIEMS And Phone.

	All workers				Removed contractors			
	<u>TIEMS, hours</u>	<u>Phone, hours</u>	<u>pu</u>	<u>pt</u>	<u>TIEMS, hours</u>	<u>Phone, hours</u>	<u>pu</u>	<u>pt</u>
All nonzero entries	1.207	1.233			1.040	1.033		
No entries < 0.5	1.398	1.568	0.398	0.205	1.071	1.193	0.552	0.32
Small entries set to 0.5	1.270	1.329			1.052	1.087		

- We designed an expert system called Maintenance and Operations Recommender (MORE). MORE uses information from computerized maintenance management systems (CMMS) and energy management and control systems (EMCS) to recommend what maintenance personnel should do in response to a maintenance service request or other event requiring a maintenance or control system action. MORE integrates text information from a CMMS database and sensor information from an EMCS to provide recommendations. Text is processed using information retrieval (IR) technology commonly used to retrieve information from large databases. MORE combines problem descriptors or codes and sensor data descriptors to estimate the best maintenance action to take. MORE uses reported maintenance actions to learn to improve its recommendations.
- We tested the ability of linear networks and neural networks to map computed descriptor similarities to computed action similarities. We found that the neural network performs significantly better than the linear network. Figure 36 shows frequency of occurrence of actions in the training and validation data sets. Figure 37 shows the success rate (fraction of the time that the recommendation is correct) as a function of action code when a neural network is used to map problem descriptors to action codes. In this data set, the only sensor data available were space temperatures. The three action codes with the highest success rate are also the most common.

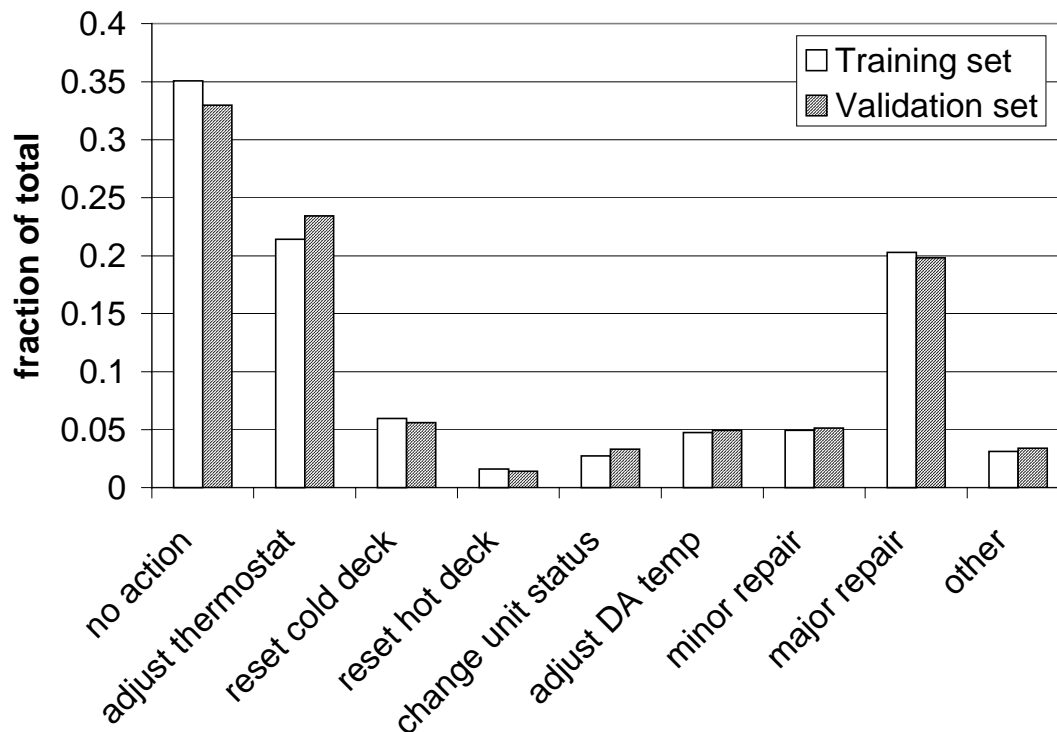

Figure 36. Labor Hours Comparison Between TIEMS And Phone.

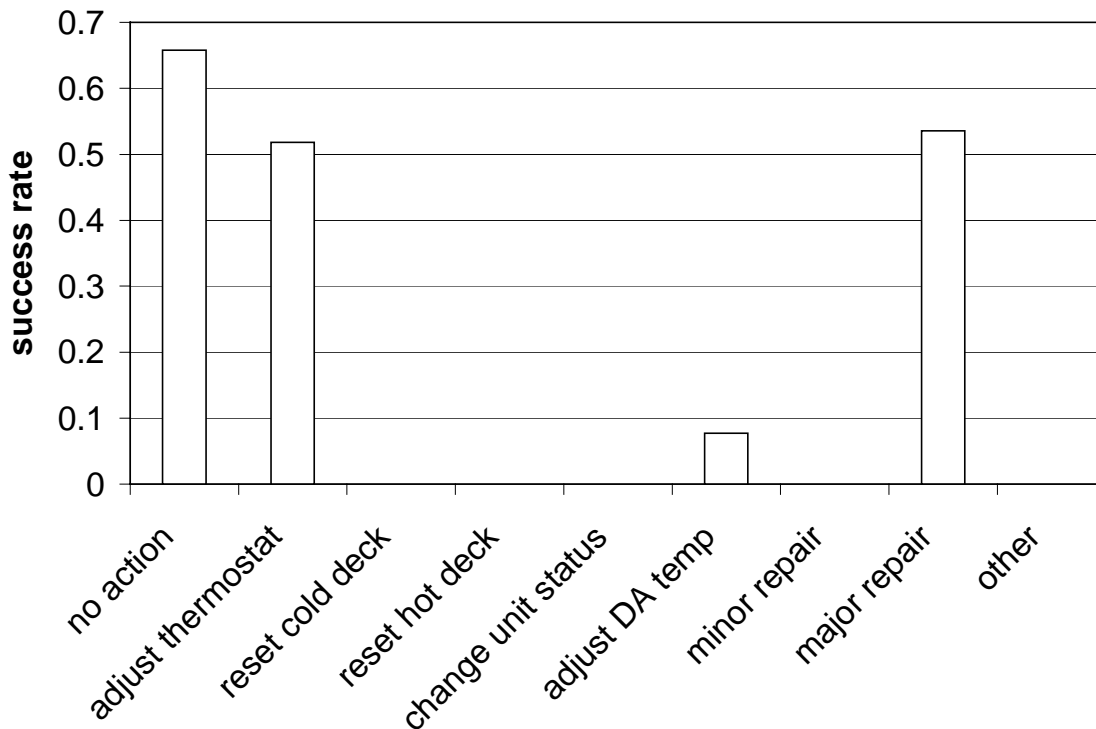

Figure 37. Success Rate Of MORE By Action Code

Market Outcomes

Building occupants can use the results of this research to provide feedback to facility managers. Work is continuing with the GSA for use in actual buildings. Testing is ongoing at one building that is part of the GEMnet multi-building monitoring system. After further testing, the commercialization potential will be evaluated.

Significant Research Products

We developed TIEMS, which is a web-based application that is now a working part of GEMnet, and MORE, which is an expert system algorithm for providing maintenance recommendations. We filed an invention disclosure for MORE with the Office of Technology Licensing at UC Berkeley. TIEMS is available at: <https://www.gemnet9.com/gemnetportal/DesktopDefault.aspx>.

Information Technology for Energy and Maintenance Management. Villafana, L. and C. C. Federspiel, 2003,” submitted to ICEBO 2003.

Design of an EMCS/CMMS User Interface for Building Occupants. Federspiel, C. C. and L. Villafana, 2003, ASHRAE Transactions, 109(2).

Design of a Maintenance and Operations Recommender. Federspiel, C. C. and L. Villafana, 2003, ASHRAE Transactions, 109(2).

CONCLUSIONS AND RECOMMENDATIONS

Conclusions

This project successfully demonstrated the benefit of providing a user interface for the energy and maintenance information technology infrastructure in buildings. We demonstrated that occupants and building operators like such an interface. We also showed the benefits of such an interface. The benefits include less workload on maintenance personnel because they don't have to answer the phone as often, improved quality of data, and improved ability to perform higher-level operations tasks such as tracking maintenance performance.

This project also demonstrated how information retrieval technology and artificial intelligence technology could be used to integrate occupant feedback data with sensor data in a way that is beneficial for operations and diagnostics. This new methodology for integrating these data sources leads to a new kind of diagnostic technology that systematically utilizes the database of diagnostic information that all maintenance databases contain. This technology has the potential to reduce the time required to solve operational problems by 1-2 hours per day per maintenance engineer.

Commercialization Potential or Commercialization Initiated

We wrote a business plan for commercialization of the technology developed under this task, and entered it in the UC Berkeley Business Plan competition. Our business plan made it to the semi-final round.

We contacted two companies that sell computer-based maintenance software, two companies that sell building control and/or diagnostics technology, and two government agencies. We interviewed representatives of each organization about the commercialization potential of the technology.

Our market research indicates that there are a number of established companies that are marketing web-based maintenance software. Many of them have some user interface that occupants could use to submit service requests. Although these products don't have the features of TIEMS, the fact that they already exist makes a business based on user interface technology alone unlikely to succeed. Our market research also indicates that although there is a lot of interest in MORE, it will be difficult to sell until its value to the end user can be quantitatively established.

Recommendations

Future work on TIEMS should include features designed to make it more interactive and more quickly adaptable to different operations. Some occupants still use the phone instead of TIEMS because TIEMS isn't sufficiently interactive. Additional features could include email forwarding of events and access to more information and more detail about responses to service requests. For example, TIEMS could tell occupants who has been assigned to solve their problem and how to contact them.

We need to test the MORE algorithm on data sets that have more sensor data. We also need to investigate ways to get better quality descriptions of actions taken by maintenance engineers, and we need to run a pilot field trial to see how the technology

will be perceived and used in practice. A final avenue of future investigation should involve developing criteria and methods for automating some actions.

BENEFITS TO CALIFORNIA

TIEMS is now available for use in Federal Region 9, which includes California. All Federal facilities in California may benefit directly from this project.

5.6. Commissioning Persistence--(Element 5 Project 5.6)

INTRODUCTION

Background and Overview

Substantial anecdotal evidence was available that procedures implemented when buildings (whether new or old) are commissioned are sometimes discontinued by operators. There was no previous systematic examination of even a small set of commissioned buildings to determine the extent or impact of this problem. Persistence is a critical issue for building owners as well as public good program managers who are currently supporting retro-commissioning services.

OBJECTIVES

The objectives of this task are to investigate:

- The extent to which mechanical system performance in new and existing construction degrades over time.
- The reasons for the observed degradation.

APPROACH

- Fourteen existing buildings that were commissioned at least two years ago and 10 buildings that were commissioned as new buildings at least two years ago were evaluated.
- Measured energy consumption data was analyzed for persistence of post-commissioning consumption levels.
- The commissioning reports, control algorithms, EMCS point measurements, and energy use data were examined to determine the persistence of selected items that were modified or fixed during commissioning.
- Operator, owner, and commissioning provider interviews were conducted to help determine reasons for persistence and methods of improving persistence
- Energy simulation software and utility data were used to estimate the effect of observed changes in control schedules for comparison with changes in measured consumption.
- A guide of strategies for improving persistence of building performance was developed.

OUTCOMES

Technical Outcomes

- A report on measures that persist and do not persist in existing buildings was prepared. This report also contained preliminary recommendations to improve persistence.

Examination of 20 building-years of heating and cooling consumption data from commissioned existing buildings found an overall increase in heating and cooling of 12.1% over two years. Almost 75% of this increase was caused by significant component failures and/or control changes that did not compromise comfort, but caused large changes in consumption. The remainder was due to control changes implemented by the operators. This data strongly suggests that follow-up commissioning is needed when consumption tracking shows that significant increases in consumption have occurred. These results have been summarized in two papers as well as the report.

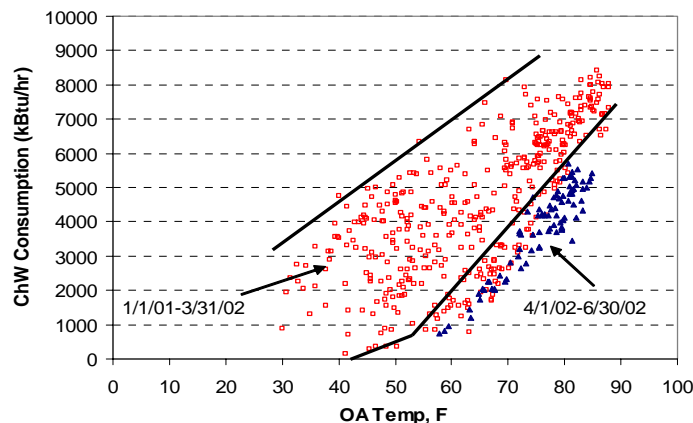

Figure 38. Cooling Consumption in a Commissioned Building

Figure 38 reflects cooling consumption in a commissioned building before and after correction of leaks in two control valves, failure of a pressure sensor, and some other problems that did not cause comfort problems but greatly increased cooling consumption. These problems all occurred after commissioning.

- A report titled Persistence of Benefits of New Building Commissioning was prepared. This report also contained preliminary recommendations for improvement.

The majority of the commissioning fixes that were studied persisted. Changes due to occupancy scheduling and cooling plant control strategies often did not persist. The persistence of commissioning benefits was found to be highly dependent on the working environment for building engineers and maintenance staff. Through this investigation, we identified three main reasons that benefits of commissioning did not persist: limited operator support and high operator turnover rates, poor information transfer from the commissioning process, and a lack of systems put in place to help operators track performance. Four methods

for improving persistence are proposed, focusing on operator training and system documentation.

BUILDING (year commissioned)	DOCUMENTS			CENTRAL PLANT			AIR HANDLING AND DISTRIBUTION							PREFUNCTIONAL TEST			OTHER								
	Commissioning report on site	Commissioning report used	Control sequences available	Chiller control	Cooling tower control	Boiler control	Hydronic control	Economizer control algorithm	Discharge air temperature reset	Simultaneous heating and cooling	VFD modulation	Dessicant cooling	Duct static pressure	Space temperature control	Terminal units	Piping and fitting problems	Valve modification	Wiring and instrumentation	Sensor placement or addition	Sensor error or failure	Scheduling	Skylight louver operation	Occupancy sensor		
California	Lab and Office 1 (1995)	no	-	yes																					
	Office Building 1 (1996)	no	-	yes																					
	Office Building 2 (1996)	no	-	no																					
	Office Building 3 (1994)	yes	yes	no																					
	Office Building 4 (1994)	no	-																						
Pacific Northwest	Office Building 5 (1997)	no	-	yes																					
	Medical Facility 1 (1998)	yes	yes	yes																					
	Medical Facility 2 (1998)	yes	yes	yes																					
	Lab and Office 2 (1997)	no	-	yes																					
	Lab and Office 3 (2000)	no	-	no																					

Figure 39. Persistence of equipment and controls fixed during commissioning. Light gray boxes show measures that persisted and black boxes show measures that did not persist.

- A manual titled Strategies for Improving Persistence of Building Performance was developed.

The manual describes each of the strategies for improving the persistence of building performance listed below in detail: why it is important, what is involved, who performs the work and what other resources are available.

 - ▶ Design review during commissioning to avoid design problems.
 - ▶ Documentation of building systems as a reference for how your systems are intended to work.
 - ▶ Enhanced training for building operators on how to effectively and efficiently operate buildings.
 - ▶ Benchmarking buildings to compare your energy use relative to buildings of similar location, size, occupancy, etc.
 - ▶ Tracking energy use to gauge your buildings progress over time.
 - ▶ Trending key system parameters to assess your system’s performance .
 - ▶ Ongoing commissioning activities to reapply commissioning tasks and ensure your building meets current needs.

Market Outcomes

- The California Commissioning Collaborative is utilizing the results of this study.
- The results have been widely reported and have led to additional studies now being conducted by LBNL.
- A proposal is now being written to develop methods for automatically detecting significant levels of commissioning degradation so the problems can be identified and rectified.

Significant Research Products

Report on Persistence of Benefits from New Building Commissioning and Strategies for Improving the Persistence of Building Performance.

H. Friedman, A. Potter, T. Haasl, D. Claridge

http://pier.lbl.gov/QuickPlace/cbprogram/PageLibrary882569EE0070157F.nsf/h_Toc/6B662D6EDDC321E688256C6000640C5D/?OpenDocument

Report of detailed examination of the commissioning measures implemented in 10 buildings and those still in place after three years. Examination of factors that appear to enhance persistence of measures.

Manual on Strategies for Improving Persistence of Building Performance.

H. Friedman, A. Potter, T. Haasl and D. Claridge, Posted on Quickplace

Detailed description of strategies to enhance the persistence of commissioning benefits.

Persistence of Savings Obtained from Continuous CommissioningSM.

Turner, W.D., Claridge, D.E., Deng, S., Cho, S., Liu, M., Hagge, T., Darnell, C., Jr., and Bruner, H., Jr., Proc. of 9th National Conference on Building Commissioning, Cherry Hill, NJ, May 9-11, 2001, pp. 20-1.1 - 20-1.13.

Quantitative examination of the persistence of energy savings from retrocommissioning conducted in 10 buildings. Found that in two years, savings were still 83% of original savings.

Is Commissioning Once Enough? Claridge, D.E., Turner, W.D., Liu, M., Deng, S., Wei, G., Culp, C., Chen, H. and Cho, S.Y., Solutions for Energy Security & Facility Management Challenges: Proc. of the 25th WEEC, Atlanta, GA, Oct. 9-11, 2002, pp. 29-36.

Analysis of commissioning savings in 10 buildings found that while savings had declined by \$200,000 over two years in 10 buildings, savings were still \$985,000. About three-fourths of the decrease was found to have occurred in two buildings that experienced component failures that did not compromise comfort. Concludes that energy consumption should be tracked to detect degradation of commissioning measures.

CONCLUSIONS AND RECOMMENDATION

Conclusions

This initial persistence study has attracted considerable interest from California utility program managers trying to assess the value of commissioning as well as commissioning stakeholders interested in ensuring the persistence of the benefits of

commissioning. However, this initial study had limited funding. The study involved only 10 buildings in California. Five of these facilities were commissioned as new construction at least two years ago and five were retro commissioned buildings. In the new buildings, there was a lack of utility data and documentation on how building occupancy, use, and conservation strategies changed since commissioning. In the existing buildings, the California demand crisis induced consumption and demand changes that were probably larger than the persistence changes that might have been observed. As a result, this study provided mainly qualitative information on the persistence of commissioning in California. The study of 10 buildings retro commissioned in Texas found that while savings had declined by \$200,000 over two years in 10 buildings, savings were still \$985,000. About three-fourths of the decrease was found to have occurred in two buildings that experienced component failures that did not compromise comfort. Concludes that energy consumption should be tracked to detect degradation of commissioning measures.

Commercialization Potential or Commercialization Initiated

This is not a product meant to be commercialized. However, it does point to the need for a tool to detect degradation and lead to correction of faults that occur.

Recommendations

More research is clearly needed, involving a larger population of buildings that have well-documented commissioning processes. Due to the complexity of measuring persistence, this research needs to be carefully planned for implementation retroactively, as well as with future commissioned buildings. The Commissioning Collaborative is interested in using their Commissioning Case Study Database as a means to collect the information necessary to study persistence in a standardized way. The CCC is looking for funding to develop an analytical framework for studying the persistence of commissioning benefits as well as to continue this initial persistence study with additional commissioned and retro commissioned buildings in California.

In parallel, we recommend developing a training curriculum and training facility managers throughout California on the persistence strategies set forth in the Guide on Strategies for Improving the Persistence of Building Performance.

BENEFITS TO CALIFORNIA

Improved persistence of commissioning benefits - this study has systematically documented for the first time the changes that occur in buildings following commissioning. Recognition of this fact and implementation of needed follow-up will improve the persistence of the benefits of commissioning and lead to lower energy consumption.

5.7. Develop Simulation-Assisted Commissioning—(Element 5, Project 5.7)

INTRODUCTION

Background and Overview

A variety of different approaches to detecting and diagnosing HVAC system faults have been investigated. These have generally been based on the use of extensive sensor data

from individual components or subsystems. Whole building simulation programs have not been used for this purpose. However, if the primary motivation for correcting a fault is based on energy efficiency, then a fault should exhibit a significant influence on energy consumption such that a whole building simulation program may be useful in detecting and diagnosing the fault.

OBJECTIVES

- The objective of this task is to develop methods for using whole-building simulation models to define the expected performance of buildings during commissioning. This includes development and testing of fault detection and diagnosis procedures based on the comparison of simulated and actual performance and simulation-based functional test procedures that maximize the information gained in different modes of operation and minimize the uncertainty in predicting long term performance from short-term tests.

APPROACH

- Evaluate the accuracy with which different simulation procedures can be expected to predict the actual performance of correctly operating large commercial buildings with built-up HVAC systems and central heating and cooling plants.
- Develop and test simulation-based functional test procedures that maximize the information gained in different modes of operation and minimize the uncertainty in predicting long term performance from short-term tests.

OUTCOMES

Technical Outcomes

- It was determined that both whole-building simulation approaches evaluated are able to predict correct operation with sufficient accuracy to be useful for certain classes of diagnostics and functional testing.
- The ASHRAE Simplified Energy Analysis Procedure has been evaluated in two field tests and has served to identify multiple faults in building HVAC operation. Initial results have been documented in a two reports and a paper.
- The simulation-based functional test procedures using data from short-term tests have been developed and tested and a report of the results is has been written.

Market Outcomes

This research remains in the development stages, so there have been no widespread market outcomes to date. However, the buildings that participated in this research project have realized substantial improvements in their operational efficiency. These research successes have been and are being publicized in several forums where building owners and operators have learned about the potential for improving ongoing building operations using these on-line simulations for performance monitoring and diagnostics.

Significant Research Products

Use Of Whole Building Simulation In On-Line Performance Assessment: Modeling And Implementation Issues.

Haves, P., Salsbury, T., Claridge, D., and Liu, M., Proc. of International Building Performance and Simulation Conference, Rio De Janeiro, Brazil, 2001.

http://buildings.lbl.gov/hpcbs/pubs/E5P23T1a1_LBNL-48284.pdf

Concludes that whole building simulation programs have the potential to act as reference models of correct operation for use in the performance assessment of real buildings. Additional sensors, over and above those usually installed in energy management and control systems may be required, as needed to provide the necessary input data. Some additions to component and control models are also needed to enable the simulations to adequately model real building performance. These changes to the models may also lead to additional use of calibrated simulations for predicting current performance from past performance.

Development of Whole-Building Fault Detection Methods.

Liu, M., Song, L. and Claridge, D.E.

<http://buildings.lbl.gov/hpcbs/pubs/E5P23T1c.pdf>

This report describes seven procedures developed for active testing of building faults using the building EMCS system. Field tests documenting use of three of the procedures are included.

CONCLUSIONS AND RECOMMENDATION

Conclusions

Whole building simulation programs have the potential to act as reference models of correct operation for use in the performance assessment of real buildings. Additional sensors, over and above those usually installed in energy management and control systems may be needed to provide the necessary input data. Some additions to component and control models are also needed to enable the simulations to adequately model real building performance.

Whole building simulation can effectively identify HVAC component problems and can be used to develop optimized HVAC operation and control schedules. In a field test, simulation identified metering and valve leakage problems successfully and indicated that building thermal energy consumption would be reduced by 23% by using the optimized operating schedules in the case study building. The measured energy savings are consistent with the simulated savings. In another field test, simulation identified re-heat valve leakage problems and later identified excessive airflow problems. This supports the need for ongoing evaluation from on-line fault detection.

Commercialization Potential or Commercialization Initiated

Further development of the techniques developed are currently being used as the basis for a proposal that will be submitted to the U.S. DOE for funding to carry this work forward and develop software suitable for testing by third parties. Multiple parties have expressed interest in serving as third party testers once software is developed.

It is intended that tools based on these techniques will be commercialized following the further technical developed required. Details of the commercialization potential will then be evaluated.

Recommendations

- Further development is needed to provide software suitable for use by commissioning agents and building operators.
- Use the test results noted above as the basis for a proposal for funding to carry this work forward and develop software suitable for testing by third parties.

BENEFITS TO CALIFORNIA

Further development and use of whole building simulation for fault detection will result in methods and tools to detect numerous inefficiencies in HVAC systems. The application of these methods and tools will lead to reduced energy and operating costs for buildings. These potential benefits apply to all commercial buildings, including those in California. The methods and tools are not specific to California.

5.8. Develop Tune-up Procedures Based on Calibrated Simulations (Element 5, Project 5.8)

INTRODUCTION

Background and Overview

Initial work on calibration and validation of building simulation programs dates to the 1980s. However, the early work was largely restricted to research projects that laboriously and expensively compared the predictions of a simulation program with monthly utility bills or with the performance of a heavily instrumented building. More recently, M.S. thesis level projects have calibrated building simulations to hourly and daily building consumption data. Earlier work developed preliminary techniques and undocumented software that show promise for speeding this process up by an order of magnitude and making it a practical tool in building tune-ups.

The calibration of a cooling and heating energy consumption simulation typically consists of closely matching the simulation results to measured consumption from utility bills or actual data. However, the calibration processes used to achieve agreement have generally been quite time-consuming. There would be tremendous value in having a procedure that can quickly and reliably calibrate simulations of large commercial buildings with built-up HVAC systems. Then, it would be practical to use a calibrated simulation for energy audits (to determine the potential savings from proposed retrofit measures), to explore the potential savings from changing building operational strategies or to track the building's performance over time in support of fault detection activities.

OBJECTIVE

- The objective of this task is to develop mechanisms to rapidly calibrate building simulations for use in evaluating the savings potential of building tune-ups.

APPROACH

- A methodology for the rapid calibration of cooling and heating energy consumption simulations for commercial buildings based on the use of “calibration signatures”, which characterize the difference between measured and simulated performance was developed and presented in a manual
- Fault detection and diagnosis procedures based on the comparison of simulated and actual performance were developed and tested in the field.

OUTCOMES

Technical Outcomes

- A methodology for the rapid calibration of cooling and heating energy consumption simulations for commercial buildings based on the use of “calibration signatures”, which characterize the difference between measured and simulated performance was developed and presented in a manual. The method is described and then its use is demonstrated in two illustrative examples and two real world case studies. The manual also contains characteristic calibration signatures suitable for use in calibrating energy simulations of large buildings with four different system types: single-duct variable-volume, single-duct constant-volume, dual-duct variable-volume and dual-duct constant-volume. Separate sets of calibration signatures are presented for each system type for the climates typified by Pasadena, Sacramento and Oakland, California.
- The ASHRAE Simplified Energy Analysis Procedure has been evaluated in two field tests and has served to identify multiple faults in building HVAC operation. Initial results have been documented in a report.

Market Outcomes

- The manual developed is available for use by simulation engineers. Numerous engineers have expressed interest in using the techniques developed.

Significant Research Products

Manual of Procedures for Calibrating Simulations of Building Systems.

Claridge, D.E., Bensouda, N., Lee, S.U. and Heinemeier, K., 2003.

<http://buildings.lbl.gov/hpcbs/pubs/E5P23T2b.pdf>

This manual provides a step-by-step procedure for rapid calibration of simulations. It includes characteristic signatures for three California climates and four major system types. Four examples of the application of the procedure are also included.

Potential of On-line Simulation for Fault Detection and Diagnosis in Large Commercial Buildings with Built-up HVAC Systems.

Liu, M., Claridge, D. and Song, L., submitted July, 2002.

<http://buildings.lbl.gov/hpcbs/pubs/E5P23T1b.pdf>

This study reviewed over a dozen simulation programs and determined that AirModel and EnergyPlus were most suitable for initial use in the on-line simulation applications.

Two case studies in which AirModel was used off-line to identify and diagnose system problems at the whole building level are presented. These cases studies illustrate the potential value of on-line simulation.

CONCLUSIONS AND RECOMMENDATION

Conclusions

The method for calibrating simulations using “calibration signatures” and “characteristic signatures” appears to substantially reduce the time required for calibration of whole-building simulations to measured consumption data. These calibrated simulations have in turn been shown to accurately predict the savings that result from optimizing building performance in two case studies.

Commercialization Potential or Commercialization Initiated

The methodology has been developed and made available to the engineering profession in the manual developed. A proposal to the Department of Energy is currently being written that would utilize this method as part of software that would be written to enhance persistence of commissioning savings in buildings.

The calibration methodology itself will be placed in the public domain. It is intended that tools based on this methodology will be commercialized following the further technical development required. Details of this commercialization will be elaborated in due course.

Recommendations

- The method should be tested by multiple practitioners and improved as necessary.
- Applications using the method for prediction of savings from retro-commissioning projects and for enhancing persistence should be developed and written.

BENEFITS TO CALIFORNIA

The techniques developed will enhance the new building and retro-commissioning processes leading to reduced energy and operating costs for buildings. These potential benefits apply to all commercial buildings, including those in California. The methods and tools are not specific to California.

5.9. Semi-Automated, Component-Level Diagnostic Procedures--(Element 5, Project 5.9)

INTRODUCTION

Background and Overview

HVAC systems often fail to operate correctly due to faulty or incorrectly installed equipment. A variety of different approaches to detecting and diagnosing these faults has been developed by a number of different researchers. However, there are no software implementations of diagnostic methods for a comprehensive range of HVAC

equipment that are available to control system vendors or other potential commercializers of diagnostic tools.

OBJECTIVE

- Implement and test component-level functional testing and performance monitoring procedures for HVAC systems.

APPROACH

The approach is to use models to predict the expected performance of particular items of HVAC equipment. A significant difference between the predicted and observed performance indicates the presence of a fault. Relevant operating data are then displayed so that the operator can confirm the presence of the fault and take steps to diagnose its cause so that it can be remedied.

OUTCOMES

Technical Outcomes

- A library of HVAC component models has been developed and testing has been performed using data from an experimental facility and real buildings.
- A toolbox of software procedures to support component-level, functional testing, and performance monitoring have been developed and implemented.
- A set of automated functional test procedures has been developed and limited testing performed in real buildings

Market Outcomes

- The software is available for control and equipment manufacturers to use as a starting point in the implementation of model-based fault detection procedures in products, and for others to use in developing tools for HVAC functional testing, performance monitoring, and fault detection. Discussions with controls and equipment manufacturers are ongoing and it is projected that at least one vendor will adopt and implement the results of this project

Significant Research Products

Library of Component Reference Models for Fault Detection,

Peng Xu and Philip Haves

<http://buildings.lbl.gov/hpcbs/pubs/E5P3T3a.pdf>

A library of component models for air handling unit components and chillers has been developed and implemented in the [SPARK](#) simulation program:

mixing box

heating and cooling coils, including control valves

VAV fan system

Gordon-Ng chiller model

Software Toolbox for Component-Level Model-Based Fault Detection Methods

Rodney Martin, Peng Xu, Moosung Kim and Philip Haves

<http://buildings.lbl.gov/hpcbs/pubs/E5P3T3b.pdf>

A toolbox of software procedures to support component-level functional testing and performance monitoring has been developed and implemented in C++. Procedures include:

- test signal generator
- transient analyzer
- comparator
- parameter estimator

CONCLUSIONS AND RECOMMENDATIONS

Conclusions

The results of the limited testing performed in the project indicate that model-based fault detection can detect a variety of faults in real systems.

Commercialization Potential or Commercialization Initiated

The software toolbox and model library have been discussed with two major HVAC equipment vendors and several HVAC control system vendors, who have asked to review the results of this project. The results of the project will be distributed to all the other significant controls vendors and to other possible implementers, including energy information system vendors.

Recommendations

Engage in a comprehensive test program to determine the detection thresholds that provide the best trade-off between sensitivity and false alarm rate in different applications. This information is required both to maximize the benefits of the technology in a particular installation and to estimate the benefits of widespread deployment.

- Extend the scope of the library beyond air handling units and chillers to include cooling towers, pumps and water distribution systems, and terminal boxes.
- Integrate the model library with the EnergyPlus HVAC component library so that a consistent set of models is used for design, commissioning and operation.

BENEFITS TO CALIFORNIA

Adoption of automated functional testing and performance monitoring methods would allow the detection and correction of faults in HVAC equipment. Benefits to California would include:

- Reduced energy, and operation and maintenance costs for owners and tenants.
- Reduced discomfort for building occupants.
- Increased ability to respond to 'extraordinary incidents' when building systems are operating correctly.

6.0 Indoor Environmental Quality (Element 6)

INTRODUCTION

Energy efficiency and indoor environmental quality (IEQ) are key building design issues, but they are often considered to be at odds with each other when design, construction, and operation decisions are made. The issues have become greater as government agencies and the building sector continue to seek improvement in energy efficiency. Designs achieving good IEQ can be expected to have beneficial effects with respect to occupant health, work performance and absenteeism, and therefore promoting their implementation is of benefit to society.



Figure 40. Demonstration Of IEQ Equipment In Classroom

This study was conducted with the goal of quantifying and demonstrating technologies with the potential to simultaneously improve energy efficiency and IEQ in commercial buildings. Many building types could be considered for this demonstration; this study focused on new relocatable (modular or portable) classrooms as the exemplary buildings. Relocatable classrooms (RCs) are particularly well suited for this demonstration because they are self-contained structures with dedicated HVAC systems and well-defined occupancies. Their study is relevant to California as an estimated 85,000 RCs are currently in place in California schools, and the numbers have been increasing at a rate of 3000 to 10,000 or more per year since 2001.

The HVAC system is a critical component of RC design from both energy and IEQ perspectives. Operating costs, electric demand, and other constraints influence HVAC design decisions such as equipment configuration, energy efficiency, and fuel source. The system also must be capable of providing adequate outdoor air ventilation. In this study we have compared the energy efficiency and building ventilation levels of RCs using a standard intermittently ventilating 10 SEER heat pump-based HVAC system (HPAC) and a continuously ventilating, and potentially more energy efficient Advanced Hybrid Indirect/Direct Evaporative Cooler (IDEC) with an integrated gas-fired hydronic heating system.

RC construction is an important factor both from the energy efficiency and IEQ perspectives. Construction permitting for RCs in California requires a certification from

the Division of the State Architect, including Title 24 energy efficiency compliance. The standard RCs marketed in California typically just meet the minimum energy efficiency codes. High performance RCs were designed and used in this study, utilizing lower building shell U-values, improved fenestration and lighting, and cool-roof coatings, as well as the IDEC HVAC system discussed above.

RC construction materials selection is also important from the IEQ perspective. Many materials commonly used in construction can emit volatile organic compounds (VOCs) and aldehydes that are either odorous or that have the potential to pose health hazards ranging from respiratory irritation to cancer. Careful selection of the interior finish materials in RCs for low VOC-emitting products can ensure lower concentrations. A component of this study has been to test a process for selecting alternate construction materials that have lower emissions of these compounds, and evaluate its benefits.

Another component of this element has been to use standard DOE-2 building energy modeling procedures to simulate the potential energy savings of the RCs employing the more efficient Advanced Hybrid IDEC system as compared to the HPAC units. Once internally validated, this model has been used to simulate potential RC energy savings in different California climate zones and cost-benefit analyzes have been conducted to identify cost savings potentials in these different climates.

OBJECTIVES

The overall technical goal of this program element is to demonstrate and stimulate the use of HVAC technologies and indoor pollutant source control technologies that save energy and simultaneously improve IEQ, providing a foundation for improvements in the health and learning of students.

The specific, technical objectives are:

- Quantify the energy savings, initial costs, and improvements in comfort, air quality, and noise attainable from implementation of selected HVAC and pollutant source control measures
- Develop new information on IEQ conditions in RCs
- Evaluate the accuracy of simulations of energy consumption in RCs and upgrade the simulation tools.
- Estimate the energy savings attainable from widespread implementation of the energy-efficient HVAC technologies in classrooms and similar buildings.
- Develop information that assists PG&E and other utilities in evaluating and marketing their programs related to energy efficient RCs.

The overall economic/cost goal of this program element is to evaluate the economic performance of the advanced HVAC technologies for RCs, considering incremental first costs and energy savings.

The specific, economic/cost objectives are:

- Quantify the incremental first costs for the advanced HVAC technologies
- Quantify the reduction in energy costs from use of the advanced HVAC technologies

- Calculate payback periods and present values for the advanced HVAC technologies.

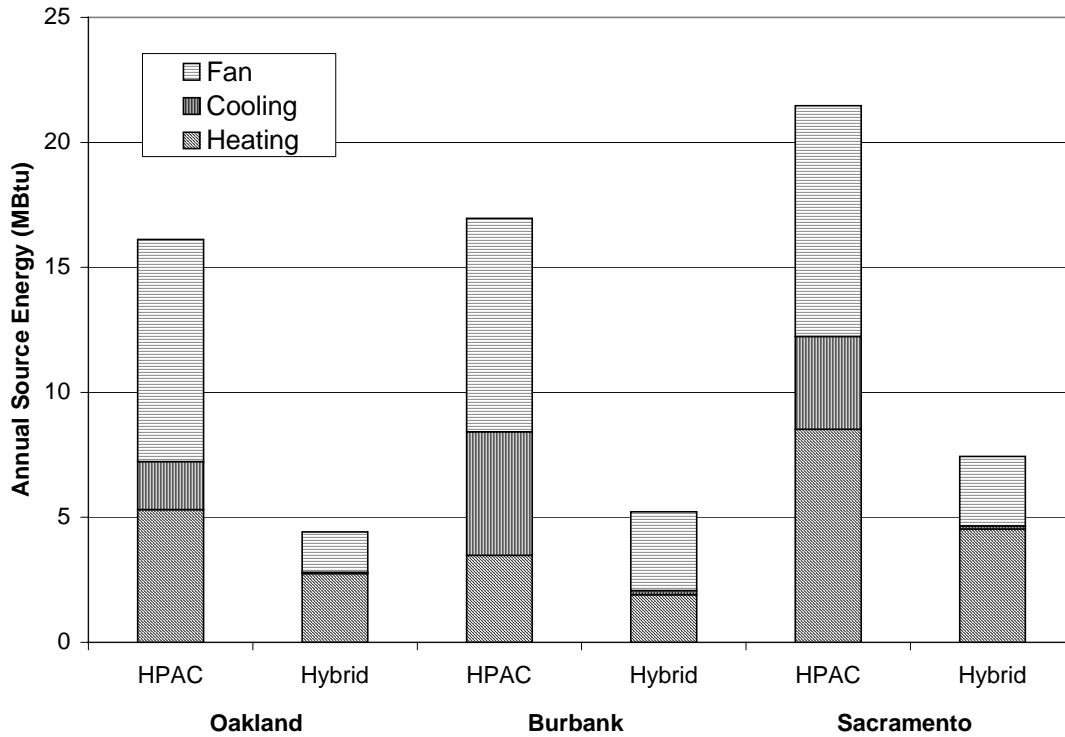

Figure 41. Source Energy Savings Estimates for Advanced Hybrid vs. HPAC

Project Team and Technical Advisory Group (TAG)

Element 6 was lead by Michael Apte of the Lawrence Berkeley National Laboratory, with Davis Energy Group as a subcontractor. Significant contributors to this element included:

- W. Fisk (LBNL)
- L Rainer (LBNL)
- D. Shendell (LBNL)
- A. Hodgson (LBNL)

The Technical Advisory Group (TAG) included:

- Jed Waldman Ph.D. (CDHS Indoor Air Branch)
- Glenn Friedman PE (Taylor Engineering)
- Maury Tiernan (Geary Pacific Corp.)
- Howard Chip Smith (California DSA)

- Maureen Lahif (UCB)
- Gregg Ander (SCE)
- Anthony Bernheim (Consultant)

6.1. Energy Modeling Phases I and II—(Element 6, Project 6.1)

INTRODUCTION

Background and Overview

California schools increasingly rely on relocatable classrooms to meet increased temporary or permanent class housing needs. As with all commercial buildings, the energy efficiency of RCs is very dependent on construction details and selection of lighting and space conditioning equipment. To date, scant data on usage and occupancy patterns have been available to apply to modeling of energy consumption of these structures. In this project such data were collected and applied across California climate zones to compare the energy usage and savings of two types of HVAC systems.

OBJECTIVES

- The objective of this project is to use building energy modeling tools to develop calibrated comparative RC energy consumption projections for the climate zones in California when using the current standard RC designs versus high performance, energy-efficient designs. A further objective is to use these calibrated models to develop cost-benefit analyses for the high-performance products.

APPROACH

The approach of this project has been to conduct preliminary DOE-2 energy simulations using the best available data on existing RC energy usage patterns, meteorological data, and standard and high-performance RC construction details, and then to refine these models based on field data collected over a year of monitoring (see Project 6.2).

The approach consisted of the following:

- Develop a preliminary DOE-2 input dataset for California RCs and specific design components related to the Advanced Hybrid system with two-stage evaporative cooling and gas hydronic heating.
- Conduct and report on a set of preliminary DOE-2 modeling runs to simulate standard and high-performance RC energy consumption in four California climate zones.
- Analyze energy consumption and usage pattern data collected in the field from Project 6.2 (Title: Field Study Evaluation of HVAC Options) in order to refine occupant energy usage pattern model inputs as well as to calibrate DOE-2 input assumptions so that model output matches real data.
- Conduct and report on a revised set of DOE-2 simulations using the calibrated models and field-derived updated inputs. Use these data to predict comparative energy consumption in 16 California climate zones.

- Conduct and report on state-wide cost benefit analyses and savings predictions based on the calibrated DOE-2 simulations comparing the standard versus high performance RCs.

OUTCOMES

Technical Outcomes

- A preliminary DOE-2 input set was developed for RC simulations and modeling runs were conducted to simulate standard and high-performance RC energy consumption in four California climate zones.
- Energy consumption and usage pattern field data were analyzed to refine occupant energy usage pattern model inputs as well as to calibrate DOE-2 input assumptions so that model output matches real data.
- Statewide cost benefit analyses and savings predictions were made based on the calibrated DOE-2 simulations comparing the standard versus high-performance RCs.

Market Outcomes

Data collection and modeling efforts results were reviewed by major manufacturers and distributors of RC HVAC equipment in CA. These results have stimulated efforts to develop new advanced HVAC technologies specifically for RCs by at least one manufacturer. This manufacturer has embarked on a collaboration with LBNL to reconfigure and redesign, and test a new generation of energy-efficient RC HVAC systems that both reduce energy consumption and ensure adequate ventilation.

Significant Research Products

Report on Initial Energy Simulations

M. Apte, W. Fisk and L. Rainer

<http://buildings.lbl.gov/hpcbs/pubs/E6p21T1b.pdf>

Report on Energy Savings Estimates and Cost Benefit Calculations for High Performance Relocatable Classrooms

L. Rainer, M. Apte, W. Fisk, and D. Shendell

<http://buildings.lbl.gov/hpcbs/pubs/E6p21T2a.pdf>

These papers provide valuable insight into the potential energy benefits of the high-performance relocatable classroom. We have learned that a significant potential exists within the predicted RC market to dramatically save on total source energy and electricity costs, and to make significant reductions in cooling and heating season peak loads.

CONCLUSIONS AND RECOMMENDATIONS

Conclusions

This project successfully demonstrated that through use of engineering solutions, a high performance RC could be developed that significantly reduces energy consumption while simultaneously providing ventilation supplied at the state building energy and occupational code-mandated rates. DOE-2 models were successfully calibrated to match real energy consumption after operational patterns were adjusted to match field observations. DOE-2 simulations based on these calibrations led to statewide energy predictions and cost savings forecasts for the case where such engineering solutions were to be implemented in new construction. One finding of note was that the standard 10 SEER HPAC system performance was significantly lower than its rating. The study observed a typical cooling Energy Efficiency Ratio (EER) of around 7.0 compared to the nominal rating of 9.25. Likewise, the 47°F-heating coefficient of performance (COP) was estimated at 1.9 rather than the nominal specification of 3.2. This large degradation is primarily due to much higher monitored strip heat energy and jacket losses during the winter months.

Based on the calibrated simulation results, assuming the current statewide distribution of RCs, the following “per unit” weighted average impacts from implementing the high performance RC Advanced Hybrid HVAC system were determined to be:

- 1,494 kWh saved (82% reduction).
- 5.9 kW winter peak electric load reduction (96% reduction).
- 3.3 kW summer peak electric load reduction (72% reduction).
- 26 therm gas increase.
- 13 Mbtu source energy savings (69% reduction).
- \$220 annual operating cost savings, ranging from \$159 to \$385 (82% reduction).

The statewide technical potential based on converting 4,000 new RCs to advanced hybrid systems is projected to:

- Save 5,975 MWh of electricity per year.
- Reduce winter peak electric load by 23.8 MW.
- Reduce summer peak electric load by 13.1 MW.
- Increase natural gas consumption by 1,025 Mbtu per year.
- Reduce source energy use by 50,931 Mbtu per year (69% reduction).
- Reduce school district annual operating costs by \$880,900.

The above potential is rather impressive and needs some explanation. The electricity reduction is based primarily on three factors; fuel switching to natural gas from electric strip heating,; using evaporative cooling in place of electrically-driven compressor cooling; and improved fan motor efficiency. Winter peak load is reduced by switching to natural gas from strip heating. Summer peak electric load reduction reflects the benefits of low-energy evaporative cooling. The assumptions for the statewide savings

were based on a modest estimate of 4,000 new RCs. These savings estimates are conservative when considering the retrofit potential for the enormous stock of existing RCs.

It should be noted that the actual savings on a daily basis during the field study did not typically reach the potential shown by these analyses. The difference has to do with the actual operation behavior of the teachers and the design of the system controls. Future effort could be focused on improving these controls as well as an effort to educate teachers on proper HVAC operation. Given the source energy savings potential it is recommended that further efforts be made to promote and commercialize hybrid low-energy HVAC systems for relocatable classrooms and other small commercial buildings.

Commercialization Potential or Commercialization Initiated

This project has served to stimulate industry to develop new technologies that provide improved ventilation control at current standards, and simultaneously are more energy efficient.

Recommendations

The results of the calibrated models developed in this project indicate that significant improvements are possible in both energy consumption and indoor air quality by careful selection of HVAC equipment.

Proposed future work should include:

- Expansion of such modeling to explore similar benefits in both traditional classroom construction as well as small commercial buildings. Similar improvements exist for these types of buildings.
- Application of the calibrated models to emerging HVAC technologies suitable for RCs and other small commercial buildings.

BENEFITS TO CALIFORNIA

The outcome of this work may lead to increased energy savings in CA schools. Simulations resulting from this study suggest that, on average, each advanced HVAC system installed in an RC can save school districts \$220/year. In addition to energy savings, improved IEQ resulting from better ventilation may lead to improved health and performance of CA students.

Field Study Evaluation of HVAC Options and Evaluation of VOC Source Control Measures--(Element 6, Project 6.2)

INTRODUCTION

Background and Overview

This study was conducted with the goal of quantifying and demonstrating technologies with the potential to simultaneously improve energy efficiency and IEQ in commercial buildings. This demonstration was conducted on relocatable classrooms, an important subset of the small commercial building stock in CA. HVAC system and building material selection were investigated.

OBJECTIVES

The objectives of these tasks were twofold. The first objective was to identify and then specify RC designs incorporating appropriate energy-efficient high-performance HVAC technologies, and IEQ-relevant materials, having the potential to both reduce RC energy usage and promote improvements in IEQ. The second object was to implement these designs into a set of actual new RCs, in collaboration with an RC manufacturer and school districts, and to site them in actual schools, monitoring them throughout a school year in order to evaluate their energy and IEQ characteristics. The expectation was that at the completion of data collection, it would be possible to be able to evaluate and compare the energy characteristics of standard vs. high performance HVAC systems, and the benefits of selection of IEQ-relevant building materials.

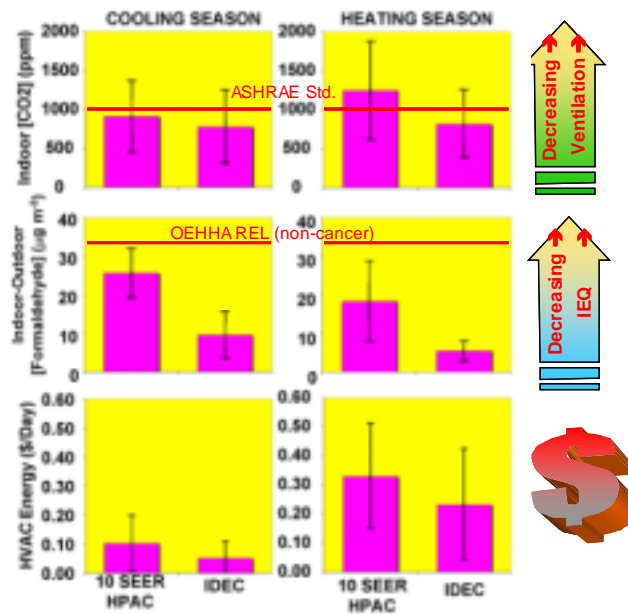

Figure 42. IEQ and Energy Monitoring Results

APPROACH

The approach consisted of the following:

- Identify a collaborating RC manufacturer and school districts.
- Identify and specify an appropriate high-performance HVAC option.
- Work with RC manufacturer to identify and then conduct VOC emissions testing from standard and alternative RC construction materials. Apply results to models to identify most effective alternative materials and their VOC concentration reduction potential.
- Design and construct four energy-efficient RCs(improved shell U-values, fenestration, lighting, cool roofs): each to have a standard and advanced HVAC system; two of four to utilize selected alternative lower-VOC emitting materials (and two with standard materials).

- Instrument RCs to monitor energy (separate energy use of HVAC, lighting, and total load; thermal conditions; meteorology), RC operational (window and door opening events, thermostat settings), and IEQ parameters (carbon dioxide, particles, VOC and aldehydes, temperature, humidity, thermal comfort, sound level).
- Site and commission two RCs side-by side at one elementary school within two school districts with distinct climate zones. Each school receives one standard material and one alternative material RC.
- Monitor energy, operational conditions, and IEQ continuously or weekly for eight to nine weeks during cooling and heating seasons, visiting and inspecting sites weekly.
- Alternate operation of two HVAC systems on a weekly basis, completely deactivating and sealing the non-operational system during its off-week periods.
- Analyze data and report on differences in energy use and IEQ conditions during alternate HVAC operation periods.
- Compare IEQ conditions between standard and alternative material RCs and these conditions against predicted conditions from source-based models.
- Widely present results of research to both scientific community and school facilities stakeholders.

OUTCOMES

Technical Outcomes

- RC designs for this study were evaluated and developed. A major RC manufacturer, American Modular Systems (Manteca, CA) manufactured four RCs to our specifications and sited them in pairs at elementary schools at two participating school districts, Cupertino Union SD and Modesto City Schools.
- All four RCs included the Advanced Hybrid IDEC/hydronic gas heat high performance HVAC systems.
http://buildings.lbl.gov/hpcbs/pubs/E6P22T1a_LBNL-49026.pdf.
- Laboratory testing yielded VOC and aldehyde source strength data for the major building materials used in the RCs and potential alternate materials. From this we specified wall, carpet and ceiling material alternates that were incorporated into the study alternate material RCs.
http://buildings.lbl.gov/hpcbs/pubs/E6P22T2a_LBNL-48490.pdf.
- Four RCs were monitored throughout the school year with many parameters at the 6-minute level. Intensive cooling monitoring occurred for eight to nine weeks during the summer/fall of 2001 and then heating season monitoring followed for nine to ten weeks in winter 2002. HVAC systems were alternated as planned.
- Following the monitoring, the data were cleaned and analyzed. Energy data were provided to DEG for completion of Project 6.1.

- IEQ and energy consumption data were analyzed and IEQ conditions were compared across HVAC modes using both summary statistics and more sophisticated multivariate models.

Market Outcomes

Results of the IEQ field study have been presented at a wide range of public and professional venues and are making their way into the popular and scientific literature.

In particular these results have been shared with stakeholders in the school facilities profession in California. They can be seen to have entered into high-level thinking of the state government school facilities planners as new energy and construction standards are being considered.

The results have stimulated the RC HVAC industry to accelerate in investing in development of new energy-efficient and IEQ-appropriate HVAC systems.

Significant Research Products

Simultaneous Energy Savings and IEQ Improvements in Relocatable Classrooms. M.G. Apte, D Dibartolomeo, T. Hotchi, A.T. Hodgson, S.M. Lee; S.M. Liff, L.I. Rainer, D.G. Shendell, D.P. Sullivan, and W.J. Fisk. 2003. Accepted for publication in ASHRAE IAQ Applications, ASHRAE, Atlanta, Georgia. LBNL-52690.

This paper is targeted for the HVAC stakeholder community, and provides an overview and summary of HPCBS Element 6.

Energy and Indoor Environmental Quality in Relocatable Classrooms. MG Apte, AT Hodgson, DG Shendell, D Dibartolomeo, T Hochi, S Kumar, SM Lee; SM Liff, LI Rainer, RC Schmidt, DP Sullivan, RC Diamond, WJ Fisk. (2002) Proceedings of Indoor Air, The Ninth International Conference on Indoor Air Quality and Climate, June 30-July 5, 2002, Monterey CA. Vol. 2, pp.62-69, Indoor Air 2002, Santa Cruz, CA. LBNL-49581 (Refereed).

This paper provides early results if the energy and IAQ study and is in the peer reviewed literature showing both IEQ benefits and energy savings during the cooling season monitoring.

Final Methodology for a Field Study of Indoor Environmental Quality and Energy Efficiency in New Relocatable Classrooms in Northern California. D.G. Shendell, D. Di Bartolomeo, W.J. Fisk, A.T. Hodgson, T. Hotchi, S.M. Lee, L.I. Rainer, D.P. Sullivan, and M.G. Apte. 2002., LBNL-51101, Lawrence Berkeley National Laboratory, University of California, Berkeley, CA 94720.

This report exhaustively covers the methods used to conduct the energy and IEQ field study

Comparison of Predicted and Derived Measures of Volatile Organic Compounds inside Four Relocatable Classrooms Due to Identified Interior Finish Sources.

A.T. Hodgson, D.G. Shendell, W.J. Fisk, and M.G. Apte (2003), LBNL-52520, Lawrence Berkeley National Laboratory, University of California, Berkeley, CA 94720.

This paper provides detailed results on the VOC measurement and modeling component of the energy and IAQ field study. Findings suggest that materials selection

can be used to reduce VOC sources but that given the standard materials used by the manufacturer in this study, supplying adequate ventilation is a more effective means to ensure low VOC concentrations. VOC concentrations were relatively low in most cases, although when ventilation was not at current guidelines, formaldehyde levels were found to be of some concern when compared to non-cancer reference chronic exposure level standards.

Indoor Environmental Quality and Energy Efficiency in New Relocatable Classrooms in Northern California. M. G. Apte, AT. Hodgson, L. I. Rainer, D. G. Shendell, D. Di Bartolomeo, W. J. Fisk, T. Hotchi, S. M. Lee, and D. P. Sullivan (2003, Lawrence Berkeley National Laboratory, University of California, Berkeley, CA 94720.

This paper provides detailed results including summary statistics, statistical analyses, and conclusions from the energy and IAQ field study. Basically, conclusions suggest that engineering solutions exist that can be used to simultaneously improve IEQ in RCs and save on energy expenditures.

CONCLUSIONS AND RECOMMENDATIONS

Conclusions

IEQ monitoring results indicate that important ventilation-relevant indoor carbon dioxide and health-relevant VOC concentration reductions were achieved while average classroom cooling and heating energy costs were simultaneously reduced by up to about 50% and 30%, respectively. This project successfully demonstrated that through careful design and implementation of technologies appropriately, it is readily possible to simultaneously achieve significant improvements in indoor environmental quality and reduce energy usage. Both energy savings and ventilation-related IEQ benefits are highly dependent on system operation behavior and we recommend that the HVAC controls of both system types should be re-designed to encourage appropriate HVAC utilization.

Recommendations

We recommend that in an attempt to further building stock improvements in energy and IEQ, efforts to implement “win-win” design strategies such as these should be considered during the design phase of commercial building construction and retrofit, and that a means to encourage such decisions be considered in building and energy codes as well as design practice guidelines. More research into the health, productivity, and performance benefits of improved IEQ in schools and other commercial building types should be supported in order to provide better estimates of the overall benefits of these strategies.

BENEFITS TO CALIFORNIA

If the above recommendations are enacted, they may result in improved energy efficiency in relocatable classrooms and other parts of the small commercial building stock, where applied. The benefit of continuous ventilation provided by the advanced HVAC system will be improved IAQ, with possible improvements in attendance, health and learning in schools and performance and productivity in office environments.

7.0 Glossary

<i>Term/Acronym</i>	<i>Definition</i>
A&E	Architects & Engineers
ACM	Alternate Calculation Method
AHU	Air Handling Unit
Arch	A web-based benchmarking tool for selected commercial building types developed by LBNL
ASTM	American Society for Testing Materials
BACnet	Building Automation Control network standard
CAD	Computer Aided Design
CBC	Commercial Buildings Council, an advisory group to LBNL that will serve as the PAC for this contract
CB ECS	Commercial Building Energy Consumption Survey, conducted by the Energy Information Administration (U.S. DOE)
CEDR	Center for Environmental Design Research, UC Berkeley
CEUS	Commercial End Use Survey, conducted by California utilities for the Commission
CHPS	Collaborative for High Performance Schools
CIEE	California Institute for Energy Efficiency
CMMS	Computerized Maintenance Management Systems
COP	Coefficient of Performance
CSGD&FTG	Control System Design Guide and Functional Testing Guide
CTPL	Commissioning Test Protocol Library
DOE	Department Of Energy
DOE2	A building energy simulation program developed by the U.S. DOE
DOE2.1E	A specific version of the DOE2 program
E-AANN	Extended Autoassociative Neural Network
EC	Electrochromic
ECM	Energy Conservation Measure
ECO	Energy Conservation Opportunities
EER	Energy Efficiency Ratio
EIA	Energy Information Administration
EIS	Energy Information Systems
EMCS	Energy Management Control system (same as EMS)

EMS	Energy Management System
Energy Star	An EPA brand name used in a labeling program to market energy efficient goods and services in the building industry
EnergyPlus	The next generation building energy simulation program developed by U.S. DOE, and others
EPA	U.S. Environmental Protection Agency
ESCO	Energy Service Company
EUI	Energy Use Intensity
EXPRESS	The data modeling language used to develop IFCs
FT	Functional Testing
HPAC	Heat Pump-based HVAC
HPCBS	High Performance Commercial Buildings Systems
HVAC	Heating, Ventilation and Air Conditioning
IAI	International Alliance of Interoperability
IAQ	Indoor Air Quality
IB ECS	Integrated Building Equipment Communication System
IC	Integrated circuit
IDEC	Indirect/Direct Evaporative Cooler
IEQ	Indoor Environmental Quality
IFC	Industry Foundation Classes
IMDS	Integrated Management and Diagnostic System
LEC	Low-energy Cooling
Metracker	A performance metrics tracking tool developed by LBNL with support from EPA
MORE	Maintenance and Operations Recommender
NILM	Non-Intrusive Load Monitoring
PAC	Program Advisory Committee for this PIER contract
PERC	Premium Efficient Relocatable Classroom - a PG&E energy efficiency program
PID	Proportional, Integral, Derivative
PIER	Public Interest Energy Research
RC	Relocatable Classrooms
RESEM	Retrofit Energy Savings Estimation Method
RH	Relative Humidity

TAG	Technical Advisory Group
TDS	Thermal Distribution System
TOU	Time Of Use electricity rate structure
VAV	Variable Air Volume
VOC	Volatile Organic Compound
VSD	Variable Speed Drive

8.0 List of Attachments

Element	Attachment #	Attachment Name	Contents	Product #
2	A-1	Commercial Building Energy Benchmarking	Development Of A California Commercial Building Energy Benchmarking Database	E2P2.1T1d
			School Energy Use Benchmarking and Monitoring	E2P2.1T3d
			Final benchmarking tool report	E2P2.1T1f
2	A-2	Building Performance Metrics	Standardized Building Performance Metrics Final Report & Software Specifications	E2P2.1T2d
			Metracker Software Download	E2P2.1T2e
2	A-3	Retrofit Energy Savings Estimation Method	RESEM-CA: Validation and Testing	E2P2.2T2b
			Resem-CA Software Download	E2P2.2T3
2	A-4	HVAC Interoperability	IFC HVAC	E2P2.3T1d
			Improving Building Energy Performance Simulation with Software Interoperability	E2P2.3T3b
3	A-5	Integrated Building Equipment Communications Systems (IBECS) Lighting Components	IBECS Network/Ballast Interface	E3P2.1T1d
			Final Report on Internet Addressable Light Switch.	E3P2.1T2d
			Low-Cost Networking for Dynamic Window Systems review.	E3P2.2T2c
3	A-6	Digital Lighting Network	Standardizing Communication Between Lighting Control Devices: a Role for IEEE P1451	E3P2.3T1a
4	A-7	Low Energy Cooling System Appraisals	Low Energy Cooling System Appraisal Study	E4P2.1T2a

Element	Attachment #	Attachment Name	Contents	Product #
4	A-8	Large Commercial Building Distribution Systems	Proposed Revisions to 2005 Title 24 Energy Efficiency Standards: Addition of HVAC Transport Efficiency Concept	E4P2.2T4a
			Duct Thermal Performance Models for Large Commercial Buildings, for 2008 Title 24 Standard	E4P2.2T1
			Benefits of Reducing Duct Leakage in Large Commercial Buildings	E4P2.2T2
			Code Change Proposal for Duct Sealing in Large Commercial Buildings, for 2008 Title 24 Standard	E4P2.2T3
4	A-9	Modeling Low Energy Cooling Systems	Model implementation in EnergyPlus	E4P2.3T1a
			Simplified Models Of Wind-Driven Cross Ventilation And Displacement Ventilation	E4P2.3T1b
			Simplified Modeling Of Cross Ventilation Airflow.	E4P2.3T2b
4	A-10	Low Energy Cooling System Design Case Studies	The Integration of Engineering and Architecture: a Perspective on Natural Ventilation for the new San Francisco Federal Building	E4P2.1T1a3
			Use Of Simulation In The Design of a Large, Naturally Ventilated Office Building.	E4P2.1T1a4
5	A-11	Control System Design Guide and Functional Testing Guide for Air Handling Systemsn	New construction design and commissioning reference guide, including validated functional tests, design calculation tools and software links to PG&E's Commissioning Test Protocol Library (CTPL).	E5P2.1T1d

Element	Attachment #	Attachment Name	Contents	Product #
5	A-12	Comparative Guide to Emerging Diagnostic Tools for Large Commercial HVAC Systems	Guide comparing emerging diagnostic software tools that aid detection and diagnosis of operational problems for large HVAC systems.	E5P2.2T1a
5	A-13	Web-based Energy Information Systems for Energy Management and Demand Response in Commercial Buildings	Report focusing on web-based EIS products for large commercial buildings.	E5P2T1b5
5	A-14	Development of Fan Diagnostic Methods and Protocols for Short Term Monitoring	Report on the development of fan diagnostic protocols. Includes report on the monitoring and analysis of three buildings using the protocols.	E5P2.2T1d
5	A-15	Turning EMCS into Monitoring Systems	Data Loggings Guide for Andover Controls Energy Management and Control Systems	E5P2.2T2a1
			Data Logging Guide for Siemens – EMCS	E5P2.2T2a2
			Data Logging Guide for TAC-Americas – EMCS	E5P2.2T2a3
5	A-16	Non-Intrusive Load Monitors (NILMs) used for Equipment Monitoring and Fault Detection	Monitoring HVAC Equipment Electrical Loads from a Centralized Location - Methods and Field Test Results	E5P2.2T3a

Element	Attachment #	Attachment Name	Contents	Product #
5	A-17	Occupant Feedback Methods for Building Diagnostic Systems	Detection of HVAC Faults via Electrical Load Monitoring	E5P2.2T3b
			Demonstration of Fault Detection and Diagnosis Methods for Air-Handling Units (ASHRAE 1020-RP)	E5P2.2T3c
			Power Signature Analysis	E5P2.2T3d
			Design of an EMCS/CMMS User Interface for Building Occupants.	E5P2.2T4b2
5	A-18	Commissioning Persistence	A Tenant Interface for Energy and Maintenance Systems.	E5P2.2T4c
			Report on Persistence of Benefits from New Building Commissioning	E5P2.2T5b
			Strategies for Improving the Persistence of Building Performance	
			Report on Strategies for Improving Persistence of Commissioning Benefits	E5P2.2T5c
5	A-19	Building Performance Assessment using On-Line Simulations	Persistence of Savings Obtained from Continuous Commissioning SM	E5P2.2T5a2
			Is Commissioning Once Enough?	E5P2.2T5b3
			Use Of Whole Building Simulation In On-Line Performance Assessment: Modeling And Implementation Issues	E5P2.3T1a1
			Potential of On-line Simulation for Fault Detection and Diagnosis in Large Commercial Buildings with Built-up HVAC Systems.	E5P2.3T1b
			Manual of Procedures for Calibrating Simulations of Building Systems	E5P2.3T2b

Element	Attachment #	Attachment Name	Contents	Product #
5	A-20	Component Level Model-based Fault Detection	Development of Whole-Building Fault Detection Methods	E5P2.3T3a
			Software Toolbox for Component-Level Model-Based Fault Detection Methods	E5P2.3T3c
6	A-21	Energy Savings And Cost Benefits For California Relocatable Classrooms	Report on Initial Energy Simulations	E6P2.1T1b
			Report on Energy Savings Estimates and Cost Benefit Calculations for High Performance Relocatable Classrooms	E6P2.1T2a
6	A-22	Energy and IEQ Field Studies	Final Methodology for a Field Study of Indoor Environmental Quality and Energy Efficiency in New Relocatable Classrooms in Northern California	E6P2.2T2e
			Simultaneous Energy Savings and IEQ Improvements in Relocatable Classrooms	E6P2.2T2c
			Energy and Indoor Environmental Quality in Relocatable Classrooms	E6P2.2T2d
			Indoor Environmental Quality and Energy Efficiency in New Relocatable Classrooms in Northern California	E6P2.1T2b