

UC Office of the President

Recent Work

Title

Transmembrane Domain Sequence Requirements for Activation of the p185c-neu Receptor Tyrosine Kinase

Permalink

<https://escholarship.org/uc/item/0f14n06v>

Authors

Chen, Lucinda I
Webster, Melanie K
Meyer, April N
et al.

Publication Date

1997-05-05

DOI

10.1083/jcb.137.3.619

Peer reviewed

Transmembrane Domain Sequence Requirements for Activation of the p185^{c-neu} Receptor Tyrosine Kinase

Lucinda I. Chen, Melanie K. Webster, April N. Meyer, and Daniel J. Donoghue

Department of Chemistry and Biochemistry and Center for Molecular Genetics, University of California, San Diego, La Jolla, California 92093-0367

Abstract. The receptor tyrosine kinase p185^{c-neu} can be constitutively activated by the transmembrane domain mutation Val⁶⁶⁴→Glu, found in the oncogenic mutant p185^{neu}. This mutation is predicted to allow intermolecular hydrogen bonding and receptor dimerization. Understanding the activation of p185^{c-neu} has assumed greater relevance with the recent observation that achondroplasia, the most common genetic form of human dwarfism, is caused by a similar transmembrane domain mutation that activates fibroblast growth factor receptor (FGFR) 3. We have isolated novel transforming derivatives of p185^{c-neu} using a large pool of degenerate oligonucleotides encoding variants of the transmembrane domain. Several of the transforming isolates identified were unusual in that they lacked a Glu at residue 664, and others were unique in that they contained multiple Glu residues within the transmembrane domain. The Glu residues in the transforming isolates often exhibited a spacing of seven residues or occurred in positions likely to represent the helical interface. However, the distinction between the sequences of the

transforming clones and the nontransforming clones did not suggest clear rules for predicting which specific sequences would result in receptor activation and transformation. To investigate these requirements further, entirely novel transmembrane sequences were constructed based on tandem repeats of simple heptad sequences. Activation was achieved by transmembrane sequences such as [VVVEVVA]_n or [VVVEVVV]_n, whereas activation was not achieved by a transmembrane domain consisting only of Val residues. In the context of these transmembrane domains, Glu or Gln were equally activating, while Lys, Ser, and Asp were not. Using transmembrane domains with two Glu residues, the spacing between these was systematically varied from two to eight residues, with only the heptad spacing resulting in receptor activation. These results are discussed in the context of activating mutations in the transmembrane domain of FGFR3 that are responsible for the human developmental syndromes achondroplasia and acanthosis nigricans with Crouzon Syndrome.

THE *neu* oncogene was initially isolated from a rat ethylnitrosourea-induced neuro/glioblastoma and encodes a receptor tyrosine kinase belonging to the epidermal growth factor receptor (EGFR)¹ family; the oncogenic mutant, referred to as p185^{neu}, is closely related to its wild-type cellular homologue, referred to as p185^{c-neu} (Shih et al., 1981; Schechter et al., 1984; Bargmann et al., 1986*a, b*; Dougall et al., 1994). Like other members of the EGFR family, p185^{c-neu} consists of an extracellular ligand-binding domain, a transmembrane domain, and an intra-

cellular tyrosine kinase domain (Drebin et al., 1984; Ullrich and Schlessinger, 1990). As for other receptor tyrosine kinases, ligand binding to the wild-type p185^{c-neu} receptor induces receptor dimerization, leading to tyrosine kinase activation and subsequent downstream signaling events (Peles et al., 1991; Dougall et al., 1994; Stein et al., 1994; for review see Heldin, 1995).

Activation of p185^{c-neu} arises from structural changes, such as the Val⁶⁶⁴→Glu mutation in the transmembrane domain (Bargmann et al., 1986*b*) or deletions in the extracellular juxtamembrane region (Siegel et al., 1994). Activated p185^{neu} resembles a ligand-stimulated receptor, as evidenced by its increased tyrosine phosphorylation of other proteins, as well as elevated levels of autophosphorylation (Bargmann and Weinberg, 1988*a*; Segatto et al., 1988; Stern et al., 1988; Weiner et al., 1989*a*; Peles et al., 1991; Ben-Levy et al., 1992; Cao et al., 1992; Qian et al., 1995). In addition, p185^{neu} is primarily found in an aggregated form while wild-type p185^{c-neu} is monomeric (Weiner et

Address all correspondence to Daniel J. Donoghue, Department of Chemistry and Biochemistry, and Center for Molecular Genetics, University of California, San Diego, La Jolla, California 92093-0367. Tel.: (619) 534-2167. Fax: (619) 534-7481.

1. *Abbreviations used in this paper:* BPV, bovine papilloma virus; ECL, enhanced chemiluminescence; EGFR, epidermal growth factor receptor; FGFR, fibroblast growth factor receptor; TCR α , T cell receptor α chain.

al., 1989b). The mutation Val⁶⁶⁴→Glu may facilitate dimerization by allowing intermolecular hydrogen bonding between the side chain of Glu⁶⁶⁴ in one receptor and the carbonyl oxygen of Ala⁶⁶¹ in another receptor, thereby stabilizing the interaction between the two α -helical transmembrane domains (Sternberg and Gullick, 1989). In the initial characterization of p185^{neu}, various mutations at Val⁶⁶⁴ were examined. Both Glu and Gln were found to be equally activating for transformation, with other potential hydrogen bond-forming residues such as Asp and Tyr exhibiting low activity (Bargmann and Weinberg, 1988b).

Prior mutagenesis studies have suggested that the primary structure in the vicinity of Glu⁶⁶⁴ must play a significant role in activation of p185^{neu}. For example, substitution of Glu at the neighboring positions 663 or 665 does not result in activation (Bargmann and Weinberg, 1988b). The importance of the subdomain surrounding Glu⁶⁶⁴ has been further examined by the mutations Val⁶⁶³→Gly and Gly⁶⁶⁵→Val, which both abolished transforming activity (Cao et al., 1992). This study also found that the lateral position and rotational orientation of Glu in the transmembrane domain did not correlate with transformation.

A subdomain containing a loosely defined sequence motif has been noted in the transmembrane domains of many other receptor tyrosine kinases (Sternberg and Gullick, 1990). This motif consists of a five-residue segment: position 0 (P0), corresponding to Ala⁶⁶¹ in p185^{c-neu}, exhibits a small side chain such as Gly, Ala, Ser, or Thr; position P3 displays an aliphatic side chain like Ala, Val, Leu, or Ile, but is occupied by Glu⁶⁶⁴ in activated p185^{neu}; and position P4 exhibits either Gly or Ala. The presence of this motif in many different receptor tyrosine kinases suggests an important role in facilitating ligand-induced receptor dimerization.

For many years, p185^{neu} represented the sole example of a receptor tyrosine kinase that is activated by mutation within its transmembrane domain. Recently, however, it has become clear that some human developmental abnormalities are due to transmembrane domain mutations in fibroblast growth factor receptor (FGFR) 3. Achondroplasia, the most common genetic form of human dwarfism, results from a single amino acid change in the transmembrane domain of FGFR3, Gly³⁸⁰→Arg (Rousseau et al., 1994; Shiang et al., 1994). As shown in work from this laboratory, this mutation results in constitutive activation of FGFR3, not unlike the constitutive activation of p185^{neu} by the mutation Val⁶⁶⁴→Glu (Webster and Donoghue, 1996). Achondroplasia is not the only developmental syndrome arising from transmembrane domain mutations in FGFR3, as Meyers et al. (1995) recently identified a novel substitution mutation in FGFR3 that is responsible for two distinct developmental syndromes: acanthosis nigricans in association with Crouzon Syndrome. The existence of these human developmental abnormalities arising from activating mutations in the transmembrane domain of a receptor tyrosine kinase suggests that the paradigm of receptor activation provided by p185^{neu} is relevant to human disease and well worth probing in molecular detail.

In this study, we have used pools of long oligonucleotides encoding the p185^{c-neu} transmembrane domain to target degeneracies to specific positions. This represents a powerful approach for the simultaneous mutation of mul-

iple residues, facilitating the isolation of transforming and nontransforming clones from a large pool of different mutants. In an effort to understand the differences between the transforming and nontransforming clones, we constructed completely novel transmembrane domains and demonstrated that some of these, such as a tandem repeat of [VVVEVVV]_n, are able to induce efficient receptor activation as evidenced by transformation of NIH3T3 cells. These results demonstrate that an apparently complex transmembrane domain can be substituted by simple sequences of repeated residues, provided that amino acids capable of hydrogen bonding, such as Glu or Gln, are included at appropriate positions. Significantly, receptor activation by the tandem repeats is accomplished without any specific sequence contribution from the native p185^{c-neu} transmembrane domain. The experiments described here provide a basis for understanding the role of the transmembrane domain in the activation of p185^{neu}, or for the activation of other receptor tyrosine kinases such as FGFR3.

Materials and Methods

Construction of Degenerate Pools and Additional Mutants

Oligonucleotides were synthesized encoding the p185^{c-neu} transmembrane domain with degenerate codons targeted to the presumptive α -helical positions designated "a," "d," and "e," shown in Fig. 1. In Pool 1, codons for Val, Ala, Gly, and Glu were targeted to each of these positions. In Pool 2, the codons for Val, Ala, or Gly, but not Glu, were targeted to these positions. The degenerate oligonucleotides were synthesized on an oligonucleotide synthesizer (Applied Biosystems Inc., Foster City, CA) and then amplified by PCR. The degenerate pools were ligated into a pSV2-derived vector encoding p185^{c-neu} (pSV2^{neu}NheI/SacI), replacing the wild-type transmembrane domain at silent *NheI* and *SacI* restriction sites (Webster and Donoghue, 1996). The *NheI* site corresponds to bases 1973–1978, and the *SacI* site corresponds to bases 2114–2119, in the published nucleotide sequence encoding p185^{c-neu} (Bargmann et al., 1986a).

The synthetic oligonucleotide sequence used to generate the degenerate pools is shown below. Silent restriction sites for *NheI* (GCTAGC) and *SacI* (GAGCTC) embedded within the sequence are shown in bold. Extra residues were added at both ends to facilitate restriction digestion of the PCR-amplified double-stranded product. The first and last triplet codons shown correspond to Ala⁶⁵³ (GCT of *NheI* site) and Leu⁷⁰¹ (CTC of *SacI* site), respectively, in the published amino acid sequence of p185^{c-neu} (Bargmann et al., 1986a): 5'-GCAGAGA.**GCT.AGC**.CCG.GTG.ACA.TTC.ATC.ATT.GXA.ACT.GTA.GXA.GXA.GTC.CTG.GXA.TTC.CTG.GXA.GXA.GTG.GTG.GXA.GTT.GGA.GXA.GXA.ATC.AAA.CGA.AGG.AGA.CAG.AAG.ATC.CGG.AAG.TAT.ACG.ATG.CGT.AGG.CTG.CTG.CAG.GAA.ACT.**GAG.CTC**.GTGGAGCC-3'. Degeneracies were encoded as follows: for Pool 1, X = A, G, C, or T; and for Pool 2, X = G, C, or T. The pools of single-stranded degenerate oligonucleotides were PCR amplified using standard conditions with the following primers: a sense strand primer, corresponding to the 5'-end of the degenerate oligonucleotide sequence shown above and spanning the *NheI* site, 5'-GCA-GAGAGCTAGCCCGGTGAC-3'; and an antisense strand primer, corresponding to the complement of the 3'-end of the degenerate oligonucleotide sequence shown above and spanning the *SacI* site, 5'-GGCTC-CACGAGCTCAGTTTCC-3'.

Additional mutants described in the text were constructed by synthesizing pairs of single-stranded oligonucleotides to create double-stranded DNA fragments with *NheI* and *SacI* cohesive overhangs, for ligation into pSV2^{neu}NheI/SacI (Webster and Donoghue, 1996).

Focus Assays

NIH3T3 cells were transfected using a modified calcium phosphate transfection protocol (Chen and Okayama, 1987), as described previously (Maher et al., 1993). Transfection frequencies were determined by cotransfect-

ing with 0.1 μg of pSV2 neo , and half of the cells were subsequently split into media containing G418 (Maher et al., 1993). For each DNA sample, the number of foci was normalized with respect to the number of Neo -resistant colonies and then expressed as a percentage of the transformation efficiency obtained with pSV2 $neuNT$, encoding p185 neu with the mutation Val⁶⁶⁴→Glu. All mutants were assayed at least three times in independent experiments for transformation efficiency.

Isolation of Transmembrane Domains from Degenerate Pools

At 9 d after transfection of degenerate Pool 1 into NIH3T3 cells, individual foci of transformed cells were expanded and RNA was isolated. cDNA was prepared using the following primer: 5'-ATACGCTTCACTAGAATTTCTTTG-3', complementary to bases 2323–2347 in the published nucleotide sequence encoding p185 neu (Bargmann et al., 1986a). This cDNA was used for PCR with primers described above, and the products digested with NheI and SacI. For the mutants designated DEG.1 through DEG.5, each recovered transmembrane domain was ligated into pSV2 neu NheI/SacI and sequenced, and its ability to activate p185 neu to a transforming phenotype was reconfirmed by transfection into NIH3T3 cells. This protocol ensured that transformation was due to a unique sequence, containing a single transmembrane domain, rather than a mixture of sequences. The nontransforming isolates, DEG.6 through DEG.10, were recovered in the same way but were negative for NIH3T3 transformation when assayed as individual clones.

Indirect Immunofluorescence

Transiently transfected Cos-1 cells (Chen and Okayama, 1987) were fixed in 3% paraformaldehyde/PBS for 10 min and then permeabilized in 0.5% Triton X-100/PBS for 5 min (Lee and Donoghue, 1992). Cells were incubated with mouse monoclonal antibody 7.16.4 to an extracellular epitope of p185 neu (c- neu [AB-4] clone 7.16.4 from Oncogene Science Inc., Manhasset, NY) followed by FITC-conjugated goat anti-mouse antiserum (Boehringer Mannheim Corp., Indianapolis, IN). To detect cell surface expression of p185 neu and derivatives, cells were fixed with paraformaldehyde and incubated without permeabilization, as described previously (Hannink and Donoghue, 1986; Lee and Donoghue, 1992).

For double-label experiments to detect both intracellular and cell surface expression, cells were fixed as described above and then treated with mouse mAb 7.16.4 (1:50 dilution) against an extracellular epitope of p185 neu , followed by FITC-conjugated goat anti-mouse antiserum (Boehringer Mannheim Corp.) at 1:1,500 dilution. The same cells were then permeabilized with 1% Triton X-100/PBS and treated with a rabbit polyclonal p185 neu C-18 antibody (Santa Cruz Biotechnology, Santa Cruz, CA) at 1:3,000 dilution, which was detected with rhodamine-conjugated goat anti-rabbit antiserum (Boehringer Mannheim Corp.) at 1:4,000 dilution.

Immunoprecipitation, In Vitro Kinase, and Dimerization Assays

Cos-1 cells were split at a density of $\sim 2 \times 10^5$ cells per 60-mm plate and transfected with 10 μg of DNA the next day (Chen and Okayama, 1987). After 2 d, the transfected cells were labeled for ~ 7 h with 100 μCi of [³⁵S]Cys and [³⁵S]Met each per ml in DME lacking Cys and Met. The cells were rinsed with TS buffer and lysed in 0.5 ml NP-40 lysis buffer (20 mM Tris, pH 7.5, 137 mM NaCl, 1% NP-40, 1 mM sodium orthovanadate, 5 mM EDTA, 10 $\mu\text{g}/\text{ml}$ aprotinin, 10% glycerol), and clarified lysates were prepared (Maher et al., 1993). Immunoprecipitation was carried out using mAb 7.16.4, and immune complexes were collected with protein A-Sepharose beads. After immunoprecipitation, the Sepharose beads were washed in NP-40 lysis buffer, and the samples were split in half. Samples for the kinase assay were washed twice in kinase buffer (20 mM Tris, pH 7.5, 10 mM MnCl₂, 5 mM MgCl₂), resuspended in 20 μl kinase buffer containing 10 μCi γ -[³²P]ATP, incubated at room temperature for 10 min, washed twice with NP-40 lysis buffer, and analyzed by 7.5% SDS-PAGE and autoradiography. The other half of the samples was analyzed by 7.5% SDS-PAGE, and the ³⁵S-labeled proteins were visualized by fluorography.

To examine dimerization, transfected cells were lysed in RIPA (10 mM sodium phosphate, pH 7.0, 1% Triton X-100, 0.1% SDS, 1% DOC, 150 mM NaCl, 2 mM EDTA, 50 mM NaF, 1% aprotinin, 1 mM sodium orthovanadate, 100 μM PMSF, and 10 mM iodoacetamide) and immunoprecipitated as described above. 2 \times nonreducing sample buffer (4% SDS, 10 mM

sodium phosphate, pH 7.0, 20% glycerol, 0.08% bromophenol blue) was added to the protein A-Sepharose beads and then boiled. For the reducing samples, an aliquot was removed and 2-mercaptoethanol was added to 0.7 M and DTT was added to 20 mM. Samples were boiled again and run on a 4–12% gradient gel. Proteins were then transferred to nitrocellulose, blotted with a rabbit polyclonal p185 neu C-18 antiserum, and detected by enhanced chemiluminescence (ECL).

To examine phosphotyrosine incorporation in immunoprecipitated receptors, reduced samples prepared as above were run on a 4–12% gradient gel, transferred to nitrocellulose, blotted with mouse antiphosphotyrosine mAb 4G10 (Upstate Biotechnology, Inc., Lake Placid, NY) and detected by ECL. The membrane was then reprobed with polyclonal p185 neu C-18 antiserum to examine receptor expression, which was again detected by ECL.

Results

Pools of Mutants with Degenerate Transmembrane Domains

The model proposed by Sternberg and Gullick (1989) postulated the transmembrane domain of p185 neu as an α -helical sequence in which Glu⁶⁶⁴ promotes activation by creating a hydrogen bond between two receptor molecules. To further characterize these interactions, we constructed pools of degenerate oligonucleotides that permitted variability in the transmembrane domain at positions P0, P3, and P4 in the Sternberg and Gullick notation, which are predicted to be of greatest structural importance based on a comparison of transmembrane domains from many growth factor receptors (Sternberg and Gullick, 1990). The repeating heptad motif present in interacting α -helical domains can also be designated (abcdefg)_n, in which the “a” and “d” positions are occupied by the residues at the interface where the two α -helical domains interact.

In degenerate Pool 1 (Fig. 1 B), we randomly targeted codons for Val, Ala, Gly, or Glu to heptad positions “a,” “d,” and “e.” This choice allowed us to examine the potential effects of multiple Glu residues targeted to a variety of positions. The pool of degenerate oligonucleotides was amplified by PCR and then ligated into a pSV2-derived vector encoding p185 neu (pSV2 neu NheI/SacI), replacing the wild-type transmembrane domain. The DNA was transfected into NIH3T3 cells, and the resulting foci were expanded. Subsequently, to recover individual transmembrane domains from foci of transformed cells, RNA was prepared from expanded cells and subjected to reverse transcriptase-PCR as described in Materials and Methods, and the resulting sequences were then subcloned as unique plasmids. Individual transmembrane domains recovered in this fashion were next ligated back into pSV2 neu NheI/SacI and reassayed for transformation of NIH3T3 cells. This ensured that transformation would be due to a unique sequence, rather than a mixture of transmembrane sequences.

The sequences of the transforming mutants isolated from this pool, designated DEG.1 through DEG.5 (Fig. 1 C), were completely distinct in comparison with other mutants previously described. Interestingly, none of the activated mutants except DEG.1 exhibited a Glu at residue 664. Moreover, all of these mutants, except for DEG.2, exhibited multiple Glu residues spaced at intervals of seven residues, or multiples of seven residues. These results were intriguing considering that Glu resi-

name	amino acid sequence				transformation		
A neu							
		heptad 1 cdefg	heptad 2 abcde	heptad 3 fghij	heptad 4 klmno		
		P0	P3				
p185c-neu	EQRASP	VTFII	ATV EG VL	LFLLLVV	VVGILL	KRRRQK	-
p185neu	EQRASP	VTFII	ATV EG VL	LFLLLVV	VVGILL	KRRRQK	++
	#650		#664			#686	
B Degenerate Pools							
	EQRASP	VTFII	*TV**VL	*FL**VV	*VG**I	KRRRQK	
Pool 1:	*	= Ala, Val, Gly or Glu					++
Pool 2:	*	= Ala, Val, Gly					-
C Transforming Isolates (from Pool 1)							
			#664				
p185neu	EQRASP	VTFII	ATV EG VL	LFLLLVV	VVGILL	KRRRQK	++
DEG.1	-----	-----	V-- EG --	G-- EA --	V-- EV --	-----	++
DEG.2	-----	-----	V-- GG --	E --VA--	A--AG--	-----	++
DEG.3	-----	-----	--L--	A-- AE --	G--VA--	A-- EE --	+
DEG.4	-----	-----	V--AV--	E --AA--	E --VV--	-----	++
DEG.5	-----	-----	E --GA--	E --GG--	V--VV--	-----	+
D Non-transforming Isolates (from Pool 1)							
			#664				
p185neu	EQRASP	VTFII	ATV EG VL	LFLLLVV	VVGILL	KRRRQK	++
DEG.6	-----	-----	V-- EG --	E --VV--	V-- EG --	-----	-
DEG.7	-----	-----	E --VV--	A-- VE --	E --CG--	-----	-
DEG.8	-----	-----	E --VG--	G--GA--	G-- EG --	-----	-
DEG.9	-----	-----	G-- EA --	V-- AE --	G--VV--	-----	-
DEG.10	-----	-----	G-- EG --	E -- EG --	G-- EG --	-----	-

Figure 1. Isolates recovered from pools with degenerate transmembrane domains. (A) The sequences of wild-type p185^{c-neu} and oncogenic p185^{neu} (with the mutation Val⁶⁶⁴→Glu) are shown. The locations of the presumptive heptad repeats of the transmembrane region are shown, along with the letters indicating the heptad positions. Vertical lines designate the probable borders of the transmembrane domain. The activating Glu residue of p185^{neu} is boldfaced. The five-residue sequence motif found in many receptor tyrosine kinase transmembrane domains (Sternberg and Gullick, 1990), referred to as P0-P4, corresponds to residues 661–665. The location of P0 and P3 are shown. (B) Oligonucleotides coding for degenerate transmembrane domains were synthesized, amplified, and cloned into pSV2^{neu}NheI/SacI as described in Materials and Methods. In the first pool of degenerate oligos, codons for either Ala, Val, Gly, or Glu were randomly targeted to the “a,” “d,” and “e” positions. In Pool 2, codons for Ala, Val, or Gly, but not Glu, were targeted to the same positions. Asterisks denote the positions at which these degeneracies were targeted. (C) Pool 1 was transfected into NIH3T3 cells; individual foci were expanded and used for PCR-mediated recovery of the unique transmembrane domain present in each focus. Each recovered transmembrane domain was ligated into pSV2^{neu}NheI/SacI to ensure that transformation was due to a unique transmembrane domain rather than a mixture of sequences. The sequences of these transforming isolates are shown, with dashes designating the residues that remained unchanged from the parent p185^{c-neu}. Glu residues are boldfaced. (D) For comparison, nontransforming isolates from Pool 1 were also characterized. The sequences of some of these isolates are shown. For A, C, and D, transformation by each isolate was quantitated as a percentage of p185^{neu}. Results represent the average values from three independent experiments, normalized by cotransfection with pSV2^{neo}, and presented as follows: –, 0–5% of p185^{neu}; +, 6–40% of p185^{neu}; ++, 41–100% of p185^{neu}. For B, transformation by DNA representing the entire pool was recorded as follows: –, 0 foci per 10 μg of DNA; ++, ~35 foci per 10 μg of DNA.

dues are rare in hydrophobic transmembrane domains. These transforming isolates provided clear evidence that multiple Glu residues do not disrupt the ability of the transmembrane domain to insert properly into the membrane.

Approximately 15 nontransforming mutants were also isolated from Pool 1, five of which, DEG.6 through DEG.10, are described in Fig. 1 D. The distinctions between the transforming and nontransforming isolates were not entirely obvious. Double-label indirect immunofluorescence was used to determine whether the lack of transforming activity of these mutants might reflect an abnormal subcellular localization. This was accomplished by using an antibody against an extracellular epitope to detect surface expression in cells before permeabilization, followed by a second antibody against the COOH terminus to detect intracellular expression in the same cell after permeabilization (Fig. 2). Fig. 2 B shows the immunofluorescence observed for control cells under identical conditions, with mock-transfected cells negative for both intracellular and surface staining (Fig. 2 B, A and B), whereas cells expressing p185^{neu} exhibit readily detectable staining both intracellularly and also at the cell surface (Fig. 2 B, C and D). As shown in Fig. 2 A, the mutants DEG.7, DEG.9, and DEG.10 were expressed intracellularly but failed to reach the cell surface (Fig. 2 A, D, H, and J), suggesting that their lack of biological activity might be due to aggregation or interaction with some component of the ER/Golgi. In contrast, the mutants DEG.6 and DEG.8 were expressed at the cell surface (Fig. 2 A, B and F), suggesting that their transmembrane domains fail to activate these receptors, despite localizing normally to the plasma membrane.

Importantly, no transforming mutants were isolated from degenerate Pool 2 (Fig. 1 B), in which Val, Ala, or Gly, but not Glu, were targeted to heptad positions “a,” “d,” and “e.” Clearly, the presence of Glu residues, which can potentially satisfy a requirement for hydrogen bonding, is a key element in receptor activation.

Design of Transmembrane Domains with Consensus Heptad Repeats

The transmembrane domains of the transforming mutants DEG.1–DEG.5 suggested that there are many allowed positions for Glu residues, yet the distinction between these sequences and those of the nontransforming mutants DEG.6–DEG.10 did not suggest clear rules for predicting which specific sequences will result in receptor activation and transformation. We therefore designed simple consensus repeats, containing a centrally located Glu residue, with most of the other residues substituted by Val, such as [VVVEVVA]_n, [VVVEVVG]_n, [VVVEVVV]_n, or [AVV-EGVL]_n (designated CONS.A, CONS.B, CONS.C, and CONS.D, respectively). Mutants were then constructed with the transmembrane domain composed entirely of these consensus sequences, repeated over the entire transmembrane domain of ~25 residues. Surprisingly, these constructs were transforming, with the CONS.A and CONS.D constructs exhibiting the greatest activity (Fig. 3 B). These results suggest that these simple repeating sequences contain all the information necessary for receptor activation. Evidently, there is little sequence specificity

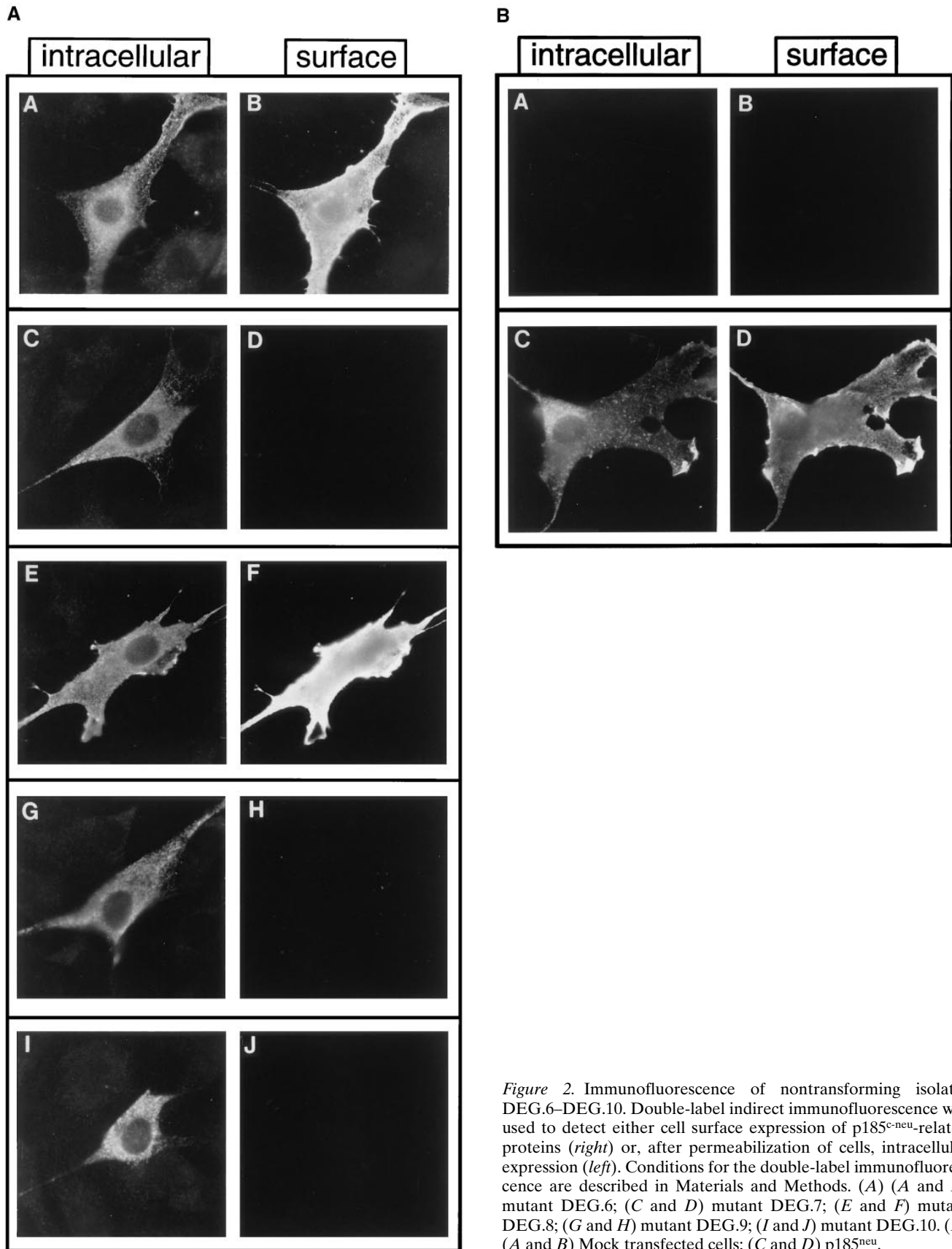

Figure 2. Immunofluorescence of nontransforming isolates DEG.6–DEG.10. Double-label indirect immunofluorescence was used to detect either cell surface expression of p185^{c-neu}-related proteins (*right*) or, after permeabilization of cells, intracellular expression (*left*). Conditions for the double-label immunofluorescence are described in Materials and Methods. (*A*) (*A* and *B*) mutant DEG.6; (*C* and *D*) mutant DEG.7; (*E* and *F*) mutant DEG.8; (*G* and *H*) mutant DEG.9; (*I* and *J*) mutant DEG.10. (*B*) (*A* and *B*) Mock transfected cells; (*C* and *D*) p185^{neu}.

name	amino acid sequence				transformation	surface expression		
A Neu	#650 ↓	heptad 1 cdefg	heptad 2 abcdefg	heptad 3 abcdefg	heptad 4 abcdef	#686 ↓		
Neu	EQRASP	VTFII	ATVVGVL	LFLILVV	VVGILI	KRRRQK	-	+
Neu (Glu ⁶⁶⁴)	-----	VTFII	ATV EG VL	LFLILVV	VVGILI	-----	++	+
			↑ #664					
B Consensus Sequences								
CONS.A	-----	v v v v A	v v v E v v A	v v v E v v A	v v v E v v	-----	++	+
CONS.B	-----	v v v v G	v v v E v v G	v v v E v v G	v v v E v v	-----	+	+
CONS.C	-----	v v v v v	v v v E v v v	v v v E v v v	v v v E v v	-----	+	+
CONS.D	-----	v v G v L	A v v E G v L	A v v E G v L	A v v E G v	-----	++	+
CONS.C ^{E→V}	-----	v v v v v	v v v v v v v	v v v v v v v	v v v v v v v	-----	-	+
C Derivatives of CONS.A								
CONS.A ^{E→K}	-----	v v v v A	v v v K v v A	v v v K v v A	v v v K v v	-----	-	+
CONS.A ^{E→Q}	-----	v v v v A	v v v Q v v A	v v v Q v v A	v v v Q v v	-----	++	+
CONS.A ^{E→S}	-----	v v v v A	v v v S v v A	v v v S v v A	v v v S v v	-----	-	+
CONS.A ^{E→D}	-----	v v v v A	v v v D v v A	v v v D v v A	v v v D v v	-----	-	-/+

CONS.A^{E→Q} is identical to CONS.A except that the Glu residues are substituted by Gln. Transformation by each isolate was quantitated as a percentage of p185^{neu}. Results represent the average values from three independent experiments, normalized by cotransfection with pSV2neo, and presented as -, +, or ++ as described in Fig. 1. Surface expression was determined by indirect immunofluorescence, as described in text.

necessary for constitutive activation within the p185^{neu} transmembrane domain itself.

It was also important to demonstrate that transformation was due to specific interactions involving Glu residues. Towards this end, we constructed a derivative of the CONS.C sequence in which the central Glu of each repeat was changed to Val. This mutant transmembrane domain, consisting entirely of Val residues, was designated CONS.C^{E→V}, and was completely devoid of transforming activity (Fig. 3 B).

Design of Derivative Transmembrane Domains Based on Consensus Heptad Repeats

We also tested whether other residues could substitute for Glu in the context of the CONS.A heptad repeat (Fig. 3 C). We replaced Glu with Lys, Gln, Ser, and Asp, creating the mutants CONS.A^{E→K}, CONS.A^{E→Q}, CONS.A^{E→S}, and CONS.A^{E→D}. These mutants were designed to test whether other hydrogen-bonding residues could substitute in place of Glu. Only substitution with Gln allowed significant transforming activity, whereas Lys, Ser, and Asp were unable to activate the receptor. The observation that Gln can substitute for Glu in the mutant CONS.A^{E→Q} is consistent with the original characterization of p185^{neu} showing that Val^{664→Glu} and Val^{664→Gln} were equally effective at activation (Bargmann and Weinberg, 1988b).

As shown in Fig. 4, A-L, indirect immunofluorescence demonstrated that most of the mutants exhibited cell surface expression. The ability of these altered receptors to reach the surface indicates that the mutant transmembrane domains did not interfere with the proper localization of the protein. The only exception was CONS.A^{E→D}, which exhibited little or no cell surface staining, even

though the protein is clearly being translated, as shown by the intracellular staining of permeabilized cells (Fig. 4, O). However, its reduced surface expression may be due to aggregation or interaction with another protein that is retained in the ER and/or Golgi, as discussed previously for some of the nontransforming mutants, DEG.7, DEG.9, and DEG.10.

Spacing and Number of Glu Residues

The design of the degenerate pools of transmembrane domains, as well as the design of the subsequent consensus repeat clones described above, assumed without any real evidence that there would exist a fundamental heptad structural motif resulting from the α -helical transmembrane domain. To directly examine this premise, we constructed a series of clones in which we varied the spacing between Glu residues. As the parental clone for this series, we chose a clone with two Glu residues spaced seven residues apart in a transmembrane domain composed otherwise of only Val residues, designated CONS.C^{2xE}. The spacing between the two Glu residues was then varied from two to eight residues, as shown in Fig. 5 A. The results of transformation assays with these clones revealed a dramatic effect of spacing, with the heptad spacing yielding significantly greater transforming activity than any of the other clones (Fig. 5 B). When cells expressing these constructs were examined by indirect immunofluorescence, all constructs exhibited cell surface expression (data not shown), indicating that the lack of transformation was not due to a defect in surface localization. This experiment provides compelling evidence for a basic heptad structural motif in the transmembrane domain of activated forms of p185^{c-neu}.

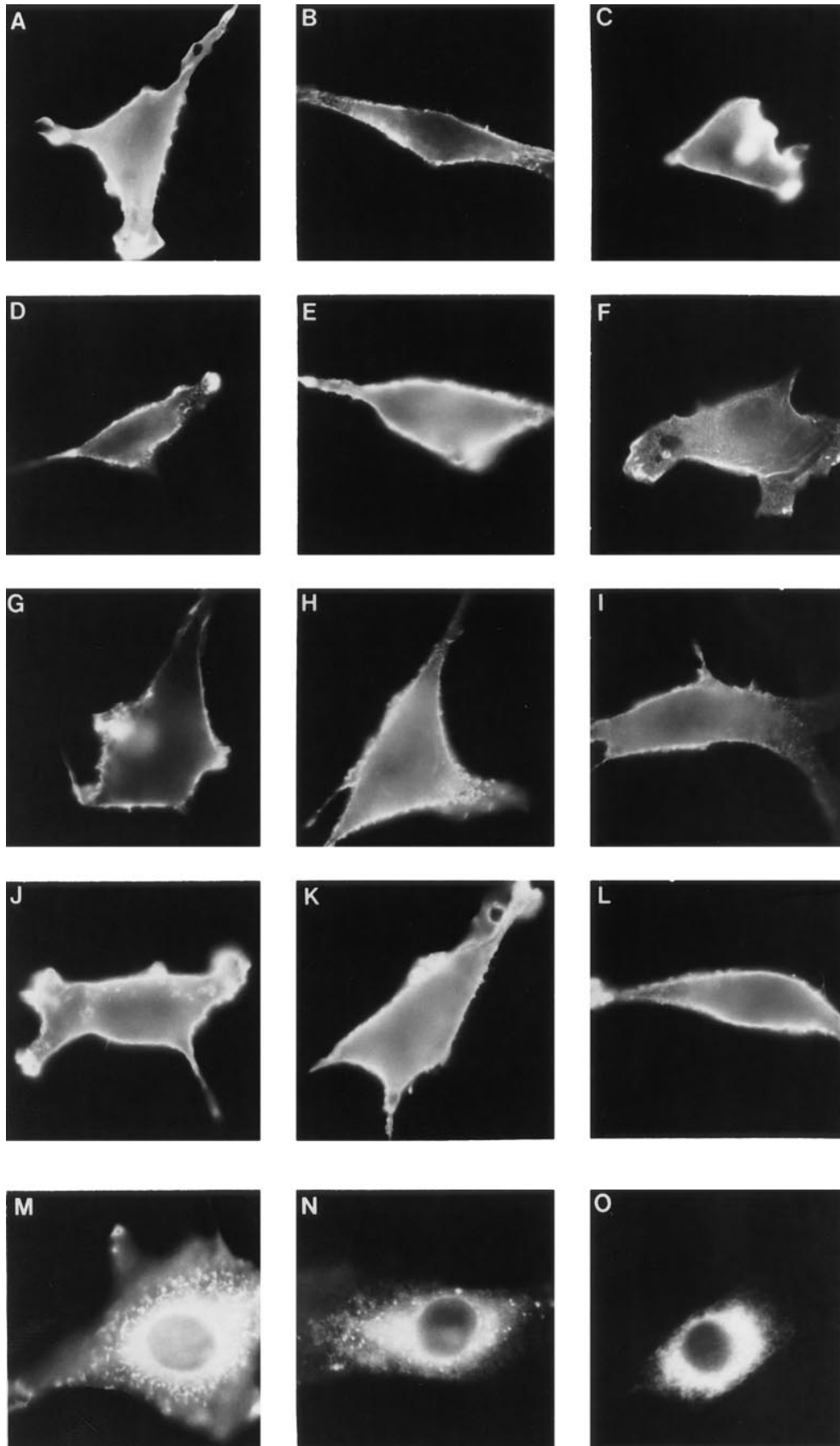

Figure 4. Indirect immunofluorescence of consensus mutants and derivatives. Indirect immunofluorescence using the monoclonal antibody 7.16.4 directed against the extracellular region of p185^{c-neu} and a fluorescein-conjugated goat anti-mouse secondary antibody revealed both cell surface and intracellular protein expression. A–L show nonpermeabilized cells to examine cell surface expression. (A) p185^{c-neu}; (B) p185^{neu}; (C) CONS.A; (D) CONS.B; (E) CONS.C; (F) CONS.D; (G) CONS.A^{E2}; (H) CONS.A^{E4}; (I) CONS.A^{E→K}; (J) CONS.A^{E→Q}; (K) CONS.A^{E→S}; (L) CONS.C^{E→V}. M–O show cells after permeabilization to examine intracellular expression. (M) p185^{c-neu}; (N) p185^{neu}; (O) CONS.A^{E→D}.

A	name		amino acid sequence			
diad	EQRASP	vvvvv	vvvEvvE	vvvvvvv	vvvvvv	KRRRQK
triad	-----	vvvvv	vvvEvvE	vvvvvvv	vvvvvv	-----
tetrad	-----	vvvvv	vvvEvvv	Evvvvvvv	vvvvvv	-----
pentad	-----	vvvvv	vvvEvvv	vEvvvvvv	vvvvvv	-----
hexad	-----	vvvvv	vvvEvvv	vvEvvvvv	vvvvvv	-----
heptad = CONS.C ^{2xE}	-----	vvvvv	vvvEvvv	vvvEvvv	vvvvvv	-----
octad	-----	vvvvv	vvvEvvv	vvvvEvv	vvvvvv	-----

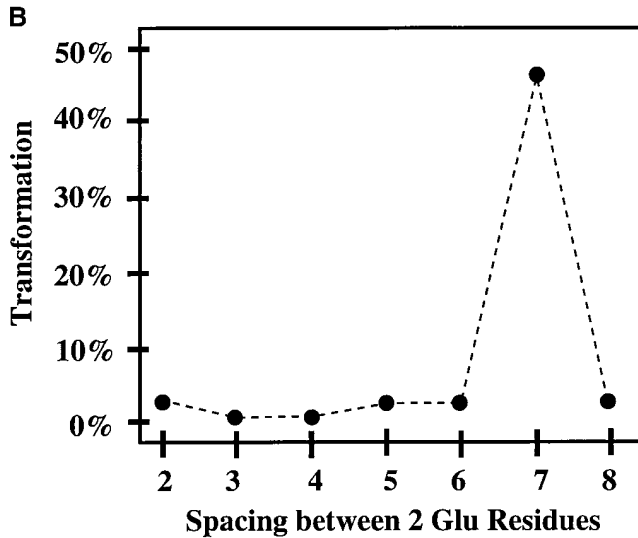

Figure 5. Importance of the spacing of Glu residues. (A) A series of clones, based on the mutant CONS.C^{2xE}, were constructed varying the spacing between two Glu residues, from a minimum spacing of two residues (diad mutant) to a maximum spacing of eight residues (octad mutant). (B) Transformation by each isolate shown in (A) was quantitated as a percentage of p185^{neu}. Numerical results of transformation assays are presented graphically and represent the average values from two independent experiments, normalized by cotransfection with pSV2neo.

Most of the transforming DEG mutants described earlier contained multiple Glu residues (Fig. 1 C), as did the transforming mutants CONS.A–CONS.D, which all contained three Glu residues (Fig. 3 B). The occurrence of multiple Glu residues is in contrast to p185^{neu}, which contains only a single Glu residue in the transmembrane domain at position 664. We therefore examined whether multiple Glu residues are in fact required for activity.

This issue was addressed through two different sets of mutants, one constructed in the background of CONS.A, [VVVEVVA], and another set in the background of CONS.C, [VVVEVVV]. These two sets of mutants yielded somewhat different results. As shown in Fig. 6 A, “single-Glu” derivatives of the CONS.A sequences were designed, each possessing only a single Glu residue located at different positions, and designated CONS.A^{E2}, CONS.A^{E3}, and CONS.A^{E4}. None of these mutants was transforming, indicating that within the context of the CONS.A heptad repeat, a single-Glu residue is not sufficient to provide activation. This result is in contrast to the single Glu⁶⁶⁴ residue that leads to activation of p185^{neu}, suggesting that there may be sequence information within the transmembrane domain, in addition to the Val⁶⁶⁴→Glu mutation, that stabilizes dimerization (Cao et al., 1992). We considered the possibility that these mutant proteins might fail to reach the cell surface and that this defect might explain their inactivity in transformation assays. However, all of the single-Glu proteins were expressed at the cell surface, as shown by indirect immunofluorescence in Fig. 4, G and H, for CONS.A^{E2} and CONS.A^{E4}.

Several mutants were also designed in the CONS.C background that had either one, two, three, or four Glu residues, designated CONS.C^{1xE}–CONS.C^{4xE}. The clone containing three Glu residues, CONS.C^{3xE}, is the original CONS.C clone. As shown in Fig. 6 B, the mutants with either two or four Glu residues, designated CONS.C^{2xE} and CONS.C^{4xE}, exhibited the greatest activity, almost twice as much as the mutant with three Glu residues. However, in this series of mutants, even the presence of a single Glu residue, as in CONS.C^{1xE}, led to significant transformation above background.

It is curious that a single Glu residue is activating in the mutant CONS.C^{1xE} (Fig. 6 B), but not in the very similar

	name	amino acid sequence		transformation			
A Derivatives of CONS.A							
CONS.A	EQRASP	vvvvA	vvvEvvvA	vvvEvvA	vvvEvv	KRRRQK	++
CONS.A ^{E2}	-----	vvvvA	vvvEvvvA	vvvvvvvA	vvvvvv	-----	-
CONS.A ^{E3}	-----	vvvvA	vvvvvvvA	vvvEvvvA	vvvvvv	-----	-
CONS.A ^{E4}	-----	vvvvA	vvvvvvvA	vvvvvvvA	vvvEvv	-----	-
B Derivatives of CONS.C							
CONS.C ^{1xE}	-----	vvvvv	vvvEvvv	vvvvvvv	vvvvvv	-----	+ (9%)
CONS.C ^{2xE}	-----	vvvvv	vvvEvvv	vvvEvvv	vvvvvv	-----	++ (45%)
CONS.C ^{3xE} = CONS.C	-----	vvvvv	vvvEvvv	vvvEvvv	vvvEvv	-----	+ (24%)
CONS.C ^{4xE}	-----	vEvvv	vvvEvvv	vvvEvvv	vvvEvv	-----	++ (43%)

Figure 6. Importance of the number of Glu residues. (A) Derivatives of CONS.A. Three derivatives were constructed, each having a single Glu residue. Depending upon the position of the Glu residue, these mutants were designated CONS.A^{E2}, CONS.A^{E3}, and CONS.A^{E4}. (B) Derivatives of CONS.C. Derivatives were constructed in the background of CONS.C having from one to four Glu residues. These clones are designated CONS.C^{1xE}, CONS.C^{2xE}, CONS.C^{3xE}, and CONS.C^{4xE}. Note that CONS.C^{3xE} is the parental CONS.C mutant presented in Fig. 3. Transformation by each isolate was quantitated as a percentage of p185^{neu}. Results represent the average values from three independent experiments, normalized by cotransfection with pSV2neo, and presented as -, +, or ++ as described in Fig. 1. For transformation results shown in B, numerical values are also shown in parentheses as the percentage of p185^{neu}.

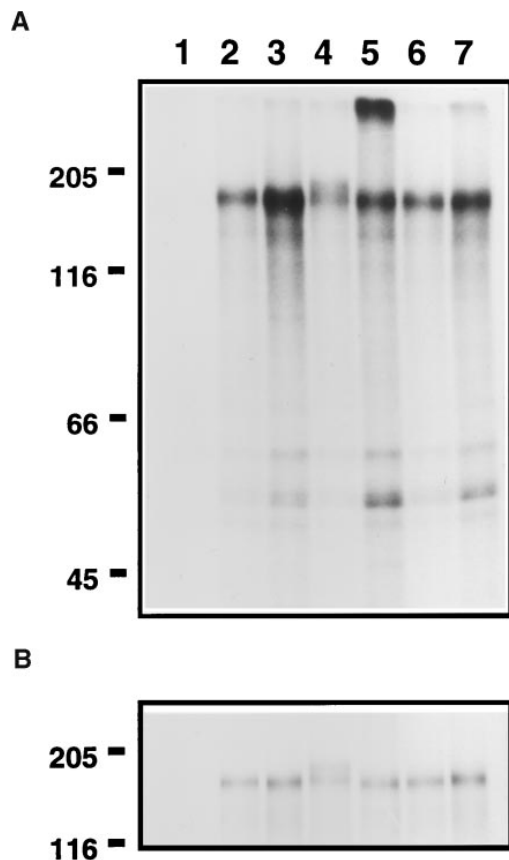

Figure 7. Immunoprecipitation/kinase assay of consensus mutants. Lysates from transfected cells, labeled metabolically with [³⁵S]Cys and [³⁵S]Met, were subjected to immunoprecipitation using monoclonal antibody 7.16.4, as described in Materials and Methods. (A) Kinase assay. Immunoprecipitated lysates were subjected to *in vitro* kinase reactions using γ -[³²P]ATP. ³²P-labeled proteins were detected by SDS-PAGE and autoradiography. Exposure time was 21 h. (B) Expression. To demonstrate equivalent levels of protein expression for different mutants, identical aliquots of immunoprecipitated lysates as used in A were analyzed by SDS-PAGE followed by fluorography to detect ³⁵S-labeled proteins. Exposure time was 3 d. The samples shown in lanes 2, 4, and 6 represent nontransforming clones, while the samples shown in lanes 3, 5, and 7 represent transforming derivatives. Lane 1, mock; lane 2, p185^{c-neu}; lane 3, p185^{neu}; lane 4, CONS.C^{E→V}; lane 5, CONS.C; lane 6, CONS.A^{E→S}; lane 7, CONS.A^{E→Q}.

mutant CONS.A^{E2} (Fig. 6 A). The active mutant has a background CONS.C motif of [VVVEVVV], whereas the inactive mutant has a background CONS.A motif of [VVV-EVVA]; these sequences differ only by the Val→Ala substitution in the last position of the repeat motif. This suggests that the ability of a single Glu residue to activate a particular transmembrane domain, as occurs in the case of p185^{neu}, may be critically dependent upon other specific details of the transmembrane domain that are not immediately obvious. These results may help to explain the negative results of earlier studies in which repositioning of the Glu⁶⁶⁴ residue to other locations in the transmembrane domain did not result in transformation (Cao et al., 1992).

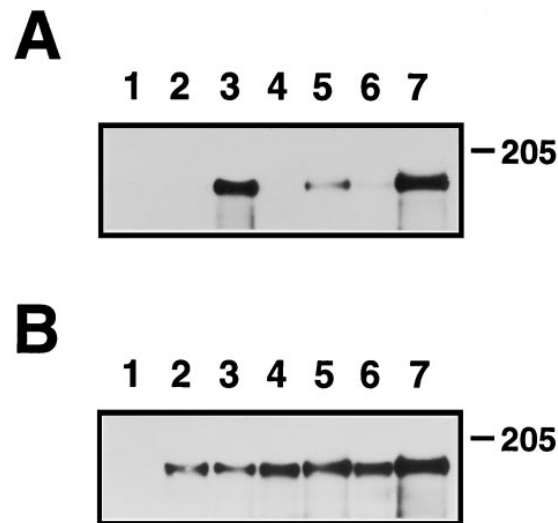
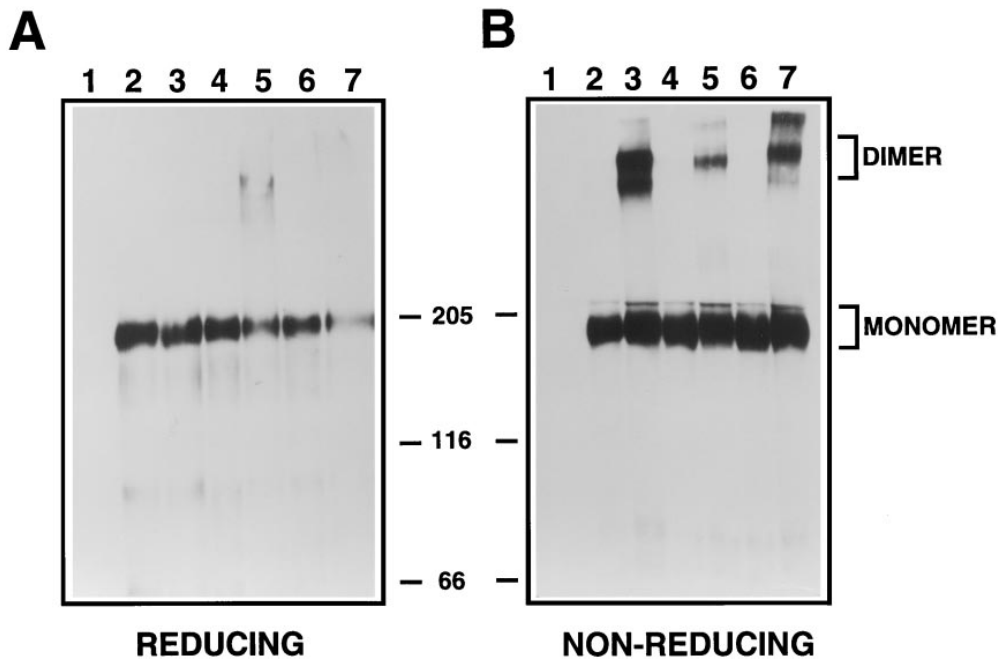

Figure 8. Detection of phosphotyrosine in immunoprecipitated receptors. Lysates were prepared from transfected cells and were subjected to immunoprecipitation using monoclonal antibody 7.16.4, as described in Materials and Methods. Immunoprecipitated lysates were analyzed on a 4–12% gradient gel under reducing conditions, transferred to nitrocellulose, probed with monoclonal phosphotyrosine antiserum 4G10 (A) or with polyclonal p185^{c-neu} C-18 antiserum (B), and specific proteins were detected by ECL. The samples shown in lanes 2, 4, and 6 represent nontransforming clones, while the samples shown in lanes 3, 5, and 7 represent transforming derivatives. A shows detection of phosphotyrosine, and B shows detection of receptor expression. Samples are: lane 1, mock; lane 2, p185^{c-neu}; lane 3, p185^{neu}; lane 4, CONS.C^{E→V}; lane 5, CONS.C; lane 6, CONS.A^{E→S}; lane 7, CONS.A^{E→Q}.

Kinase Activity of Mutants

Transformation by the *neu* oncogene is dependent upon p185^{neu} having a functional kinase domain, and p185^{neu} exhibits increased turnover, autophosphorylation, tyrosine phosphorylation of intracellular substrates, and activation of PLC- γ (Bargmann and Weinberg, 1988a; Stern et al., 1988; Weiner et al., 1989a,b; Peles et al., 1991; Cao et al., 1992; Brown et al., 1994). Moreover, transformation and SH2-dependent signaling by p185^{neu} requires intermolecular receptor association that is mediated by the transmembrane domain, as demonstrated by functional complementation between truncated kinase-active p185^{neu} and full-length kinase-inactive p185^{neu} (Qian et al., 1994, 1995). Another indication of receptor dimerization and aggregation is provided by measurement of ligand-binding using chimeras consisting of the ligand-binding domain of EGFR substituted into either p185^{c-neu} or p185^{neu}, the Val→Glu mutation in the transmembrane domain of such EGFR/*Neu* chimeras results in the conversion of low-affinity ligand-binding sites into high-affinity binding sites, consistent with an oligomerized state of the oncogenic receptor (Ben-Levy et al., 1992).

To confirm kinase activation of the mutants described here, selected mutants were examined for receptor activation using an immunoprecipitation/kinase assay of transfected Cos-1 cells. As shown in Fig. 7 A, p185^{neu} exhibited approximately threefold greater autophosphorylation than



B shows samples analyzed under nonreducing gel electrophoresis conditions. Samples are: Lane 1, mock; lane 2, p185^{c-neu}; lane 3, p185^{neu}; lane 4, CONS.C^{E→V}; lane 5, CONS.C; lane 6, CONS.A^{E→S}; lane 7, CONS.A^{E→Q}.

p185^{c-neu} (lanes 3 and 2, respectively). The mutants CONS.C^{E→V} and CONS.C were examined, as they represent an interesting pair of closely related mutants. The first of these is inactive in transformation assays, whereas the latter mutant is active. In the immunoprecipitation/kinase assay, the biologically active mutant CONS.C exhibited a similar increase in autophosphorylation compared with the inactive receptor CONS.C^{E→V} (lanes 5 and 4, respectively). We also examined another pair of closely related mutants, CONS.A^{E→S} and CONS.A^{E→Q}, where once again the first mutant is inactive in transformation assays, but the latter mutant is active. Once again, in the immunoprecipitation/kinase assay, the biologically active mutant CONS.A^{E→Q} exhibited an increase in autophosphorylation compared with the inactive mutant CONS.A^{E→S} (lanes 7 and 6, respectively). In this experiment, similar levels of protein expression were achieved for p185^{c-neu}, p185^{neu}, and the various mutants examined, as demonstrated by ³⁵S-metabolically labeled/immunoprecipitated proteins from the same lysates (Fig. 7 B). Thus, consistent with prior experimental results from other laboratories (Bargmann and Weinberg, 1988a; Stern et al., 1988; Weiner et al., 1989a,b; Cao et al., 1992), biologically active derivatives constructed in this work exhibited increased levels of kinase activity, as determined by receptor autophosphorylation in immunoprecipitation/kinase assays.

Immunoprecipitated samples were also examined for the presence of phosphotyrosine by immunoblotting. Fig. 8 A demonstrates that two transforming mutants, CONS.C (lane 5) and CONS.A^{E→Q} (lane 7), exhibit significant incorporation of phosphotyrosine into immunoprecipitated receptors, as did the positive control, p185^{neu} (lane 3). Little or no phosphotyrosine was associated with the nontransforming mutants, CONS.C^{E→V} (lane 4) and CONS.A^{E→S} (lane 6), or with the nontransforming control, p185^{c-neu} (lane 2). As a control for receptor expression

levels, **B** demonstrates approximately equivalent levels of receptor expression, determined by immunoblotting using polyclonal p185^{c-neu} C-18 antiserum.

These same mutants were also examined for receptor dimerization using gradient gel electrophoresis under non-reducing conditions (Weiner et al., 1989b; Burke et al., 1997). Fig. 9 B presents these results, while the same lysates were also analyzed under reducing conditions as a control, shown in A. Two transforming mutants, CONS.C (lane 5) and CONS.A^{E→Q} (lane 7), exhibited significant bands of dimeric receptors, as did the positive control, p185^{neu} (lane 3). Importantly, no dimerization was observed for the nontransforming mutants analyzed here, CONS.C^{E→V} (lane 4) and CONS.A^{E→S} (lane 6), or for the nontransforming control, p185^{c-neu} (lane 2). The ability to detect receptor dimerization for the transforming mutants, but not for the biologically inactive mutants, indicates that the consensus sequences described here promote receptor dimerization, and that in this respect they are similar to the parental transforming clone, p185^{neu}.

Discussion

Function of the Transmembrane Domain

The results presented here demonstrate that activation of p185^{c-neu} can be achieved by a transmembrane domain with very little sequence specificity. Glu residues in the appropriate positions of a simplified transmembrane domain, such as [VVVEVVV]_n, lead to receptor activation as demonstrated by biological transformation (Fig. 3), increased kinase activity (Fig. 7), increased incorporation of phosphotyrosine (Fig. 8), and receptor dimerization (Fig. 9). Receptor activation is conferred by as few as one or as many as four Glu residues within some of these repeats. Moreover, a periodic heptad spacing seems to be critical

Figure 9. Dimerization assay of consensus mutants. Lysates were prepared from transfected cells in RIPA containing 10 mM iodoacetamide and were subjected to immunoprecipitation using monoclonal antibody 7.16.4, as described in Materials and Methods. Immunoprecipitated lysates were analyzed on a 4–12% gradient gel and transferred to nitrocellulose, probed with a polyclonal p185^{c-neu} C-18 antiserum, and specific proteins were detected by ECL. The samples shown in lanes 2, 4, and 6 represent nontransforming clones, while the samples shown in lanes 3, 5, and 7 represent transforming derivatives. A shows samples analyzed under reducing gel electrophoresis conditions.

for activation; this was demonstrated by systematically varying the spacing between two Glu residues from two to eight, with only the heptad spacing resulting in activation (Fig. 5 B). Thus, an apparently complex system can be reduced to a repeated sequence motif. Furthermore, in these simplified transmembrane domains, Gln is able to substitute efficiently for Glu, as shown by the mutant CONS.A^{E→Q}. This is consistent with previous observations (Bargmann and Weinberg, 1988b) that Gln, but not Ser, Lys, or Asp, was able to substitute for Glu at position 664 in receptor activation (Fig. 3).

From the transforming isolates of degenerate Pool 1, it is clear that the location of Glu at position 664 is not critical for activation (Fig. 1), in contrast to prior results suggesting that the primary structure around Glu⁶⁶⁴ plays an important role. For instance, mutants with Glu663 or Glu665 were inactive (Bargmann and Weinberg, 1988b). More recently, Cao et al. (1992) analyzed the requirements for activation of the p185^{neu} transmembrane domain; all of their transforming mutants retained Glu at position 664, and a mutant (designated lil670VEG) with the motif VEG seven residues COOH-terminal, was nontransforming.

Our isolation of the transforming mutants DEG.2, DEG.3, DEG.4, and DEG.5, all of which lack a Glu at position 664, would suggest that there exists considerable flexibility with regard to the allowed placement of the Glu residue(s) that may mediate activation. The isolation of these transforming mutants also demonstrates that the construction of a degenerate pool of oligonucleotides encoding transmembrane domains provides a powerful approach to identifying and isolating those rare sequences that may allow receptor activation.

Our data show that activation of p185^{c-neu} can be mediated by Glu residues spaced seven amino acids apart in a repeating heptad. Analysis of the sequences of the isolates from Pool 1 (Fig. 1) is consistent with this proposal. Most of the transforming isolates contain Glu residues separated by multiples of seven amino acids. In the nontransforming isolate, DEG.6, which was expressed at the cell surface (in contrast to DEG.7 and DEG.10), there are Glu residues spaced seven amino acids apart, but there is also a Glu that does not follow that pattern. This may suggest that the presence of a Glu in a nonheptad motif may cause a disruption in the interaction between receptor molecules that prevents transforming ability, although it is difficult to infer absolute rules because of the other sequence variations exhibited by the DEG mutants.

The Val→Glu mutation that activates p185^{neu} is also activating when introduced into the corresponding position of the *Drosophila* EGFR homologue (DER), resulting in increased kinase activity (Wides et al., 1990). Although it was initially reported that the corresponding Val⁶²⁷→Glu mutation does not activate the human EGFR transmembrane domain (Kashles et al., 1988), a more recent study suggests that this mutation is activating (Beguinet et al., 1995). Additionally, a Val→Glu mutation at position 659 in c-erbB-2, the human *Neu* homologue that is overexpressed in many breast cancers, results in elevated tyrosine kinase activity (Segatto et al., 1988). These examples provide further evidence for activation of EGFR family members by appropriate introduction of a strongly polar residue in their transmembrane domains.

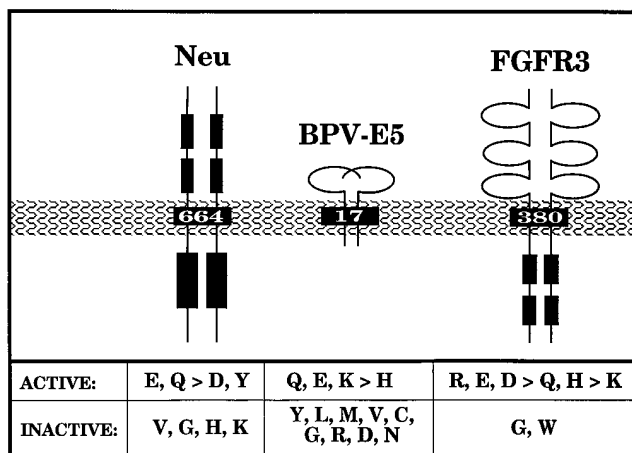

Figure 10. Oncoproteins and receptors activated by mutations in the transmembrane domain. Amino acids are shown that allow activation of p185^{c-neu} when substituted at residue 664, activation of BPV-E5 when substituted at residue 17, and activation of FGFR3 when substituted at residue 380, as discussed in the text. Those substitutions that allow activation in these three different systems share the property that they are strongly polar in an otherwise hydrophobic membrane environment, and thus share the ability to participate in hydrogen bond formation that may stabilize dimer formation.

The hydrophobic environment of the membrane creates an energetic need to shield polar side chains such as that of Glu (even if uncharged), which can be accomplished by appropriate hydrogen bonding. Previously, it was proposed that there may be a requirement for Ala⁶⁶¹ in p185^{neu} to allow hydrogen bonding between the Glu⁶⁶⁴ side chain of one receptor with the carbonyl oxygen of Ala⁶⁶¹ in the other. There is clearly no strict requirement for Ala at position 661, however, as shown by the fact that Val is tolerated at position 661 in many of the biologically active mutants described here. The presence of the branched side chain at Val⁶⁶¹, which might interfere with side chain-backbone hydrogen bonding, argues against this model but does not exclude it. More likely, however, would be a model of side chain-side chain hydrogen bonding between the Glu of one subunit with the corresponding Glu of the other subunit. The choice between these two models will require further biophysical characterization. While the results presented in this work are certainly consistent with a coiled-coil arrangement for the interacting transmembrane domains of p185^{neu}, other structural models cannot be excluded at the present time, such as one proposed for the homodimerizing transmembrane domain of glycoporphin A (Lemmon et al., 1992; Treutlein et al., 1992).

Relevance of p185^{neu} Activation to Other Systems

As summarized in Fig. 10, prior studies have demonstrated that substitutions at position 664 of p185^{neu} exhibit the following pattern of biological activity: Glu, Gln > Asp, Tyr > Val, Lys, Gly, His (Bargmann and Weinberg, 1988b). These results are generally consistent with a role of polar or hydrophilic residues in promoting activation, although the failure of Lys and His to allow for activation remains

to be explained. The E5 oncoprotein of bovine papilloma virus (BPV) provides another example of the importance of the transmembrane domain for activation, since this 44-residue integral membrane protein requires dimerization and disulfide bond formation for its biological activity (Horwitz et al., 1988, 1989; Goldstein et al., 1992). A key requirement of its hydrophobic transmembrane domain is the presence of Gln¹⁷, which appears to participate in interhelical hydrogen bonding and may be substituted by either Glu or Lys, and to a lesser extent by His (Meyer et al., 1994). Significantly, the transmembrane domain of E5 can be largely replaced by the membrane-spanning region from activated p185^{neu} (Meyer et al., 1994).

The transmembrane domain of the T cell receptor α chain (TCR α) also appears to play a key role in complex formation between TCR α and the CD3 γ chain, mediated by two basic residues in the TCR α transmembrane domain (Cosson et al., 1991). As another relevant example, the basic residues within the transmembrane domain of gp41 in human immunodeficiency virus type 1 (HIV-1) have been suggested to play a role in oligomerization of the HIV-1 envelope glycoprotein (Owens et al., 1994).

Transmembrane Domain Mutations in Human Developmental Syndromes

Transmembrane-mediated receptor activation clearly plays a fundamental role in several human developmental syndromes. Achondroplasia, the most common genetic form of human dwarfism, results from a single amino acid change in the transmembrane domain of FGFR3, Gly³⁸⁰→Arg (Rousseau et al., 1994; Shiang et al., 1994). This mutation results in constitutive activation of FGFR3, leading to abnormal development at the growth plate of long bones (Webster and Donoghue, 1996). As depicted in Fig. 10, we have previously demonstrated that mutations at residue 380 of FGFR3 exhibit the following pattern of activation: Arg, Glu, Asp > Gln, His \gg Lys (Webster and Donoghue, 1996). Recently, Meyers et al. (1995) characterized an autosomal dominant mutation in FGFR3 that is manifested as two distinct developmental syndromes presented together: first, acanthosis nigricans, a hyperplastic epithelial proliferation syndrome resulting in thickened hyperpigmented skin; and second, Crouzon Syndrome, characterized by craniosynostosis or premature fusion of the cranial sutures, resulting in cranial malformation and ocular proptosis. The mutation responsible for these developmental anomalies maps to the transmembrane domain of FGFR3 and, surprisingly, involves a single substitution mutation creating a Glu residue (Ala³⁹¹→Glu). Using FGFR3/Neu chimeras, we have recently demonstrated that the Ala³⁹¹→Glu mutation also leads to constitutive receptor activation (Webster, M.K., and D.J. Donoghue, unpublished data).

It is clear that transmembrane domains play a more substantial role than serving as structural elements for membrane anchoring. The examples discussed above underscore the importance of understanding the molecular details of activating mutations in the transmembrane domains of receptors. The principles elucidated here are likely to be generally relevant to understanding activation and signal transduction by other receptor tyrosine kinases in addition to p185^{neu}.

We thank Robert Weinberg (Massachusetts Institute of Technology, Cambridge, MA) for providing the pSV2^{neuN} and pSV2^{neuNT} plasmids. We thank Laura Castrejon for excellent editorial assistance, Brendan Galvin for excellent technical support and advice, and all lab members for their many valuable comments and suggestions concerning experimental design and preparation of the manuscript. We also thank David Stern and Chris Burke (Yale University, New Haven, CT) for advice about the dimerization assay.

This work was supported by grant CA 40573 from the National Institutes of Health, grant 1RB-0318 from the University of California Breast Cancer Research Program, and grants 3RT-0242 and 4FT-0193 (to M.K. Webster) from the University of California Tobacco Related Disease Research Program.

Received for publication 3 October 1996 and in revised form 18 February 1997.

References

- Bargmann, C.I., and R.A. Weinberg. 1988a. Increased tyrosine kinase activity associated with the protein encoded by the activated *neu* oncogene. *Proc. Natl. Acad. Sci. USA.* 85:5394–5398.
- Bargmann, C.I., and R.A. Weinberg. 1988b. Oncogenic activation of the *neu*-encoded receptor protein by point mutation and deletion. *EMBO (Eur. Mol. Biol. Organ.) J.* 7:2043–2052.
- Bargmann, C.I., M.-C. Hung, and R.A. Weinberg. 1986a. The *neu* oncogene encodes an epidermal growth factor receptor-related protein. *Nature (Lond.)* 319:226–230.
- Bargmann, C.I., M.-C. Hung, and R.A. Weinberg. 1986b. Multiple independent activations of the *neu* oncogene by a point mutation altering the transmembrane domain of p185. *Cell.* 45:649–657.
- Beguino, L., W.C. Vass, and M. Milos. 1995. SHC is constitutively activated by a transforming EGF receptor mutant with a point mutation in the transmembrane domain. *J. Cell Biochem.* 19A(Suppl.):11–11.
- Ben-Levy, R., E. Peles, R. Goldman-Michael, and Y. Yarden. 1992. An oncogenic point mutation confers high affinity ligand binding to the *neu* receptor. *J. Biol. Chem.* 267:17304–17313.
- Brown, V.I., N. Shah, R. Smith, M. Hellman, L. Jarett, Y. Mikami, E. Cohen, X. Qian, and M.I. Greene. 1994. Demonstration by two-color flow cytometry that tyrosine kinase activity is required for down-modulation of the oncogenic *neu* receptor. *DNA Cell Biol.* 13:193–209.
- Burke, C.L., M.A. Lemmon, B.A. Coren, D.M. Engelman, and D.F. Stern. 1997. Dimerization of the p185^{neu} transmembrane domain is necessary but not sufficient for transformation. *Oncogene.* 14:687–696.
- Cao, H., L. Bangalore, B.J. Bormann, and D.F. Stern. 1992. A subdomain in the transmembrane domain is necessary for p185^{neu} activation. *EMBO (Eur. Mol. Biol. Organ.) J.* 11:923–932.
- Chen, C., and H. Okayama. 1987. High-efficiency transformation of mammalian cells by plasmid DNA. *Mol. Cell. Biol.* 7:2745–2752.
- Cosson, P., S.P. Lankford, J.S. Bonifacio, and R.D. Klausner. 1991. Membrane protein association by potential intramembrane charge pairs. *Nature (Lond.)* 351:414–416.
- Dougall, W.C., X. Qian, and M.I. Greene. 1993. Interaction of the *neu*/p185 and EGF receptor tyrosine kinases: implications for cellular transformation and tumor therapy. *J. Cell Biochem.* 53:61–73.
- Dougall, W.D., X. Qian, N.C. Peterson, M.J. Miller, A. Samanta, and M.I. Greene. 1994. The *neu*-oncogene: signal transduction pathways, transformation mechanisms, and evolving therapies. *Oncogene.* 9:2109–2123.
- Drebin, J.A., D.F. Stern, V.C. Link, R.A. Weinberg, and M.I. Greene. 1984. Monoclonal antibodies identify a cell-surface antigen associated with an activated cellular oncogene. *Nature (Lond.)* 312:545–548.
- Goldstein, D.J., R. Kulke, D. DiMaio, and R. Schlegel. 1992. A glutamine residue in the membrane-associating domain of the bovine papillomavirus type 1 E5 oncoprotein mediates its binding to a transmembrane component of the vacuolar H⁺-ATPase. *J. Virol.* 66:405–413.
- Hannink, M., and D.J. Donoghue. 1986. Cell surface expression of membrane-anchored *v-sis* gene products: glycosylation is not required for cell surface transport. *J. Cell Biol.* 103:2311–2322.
- Heldin, C.H. 1995. Dimerization of cell surface receptors in signal transduction. *Cell.* 80:213–223.
- Horwitz, B.H., A.L. Burkhardt, R. Schlegel, and D. DiMaio. 1988. 44-amino-acid E5 transforming protein of bovine papillomavirus requires a hydrophobic core and specific carboxyl-terminal amino acids. *Mol. Cell. Biol.* 8:4071–4078.
- Horwitz, B.H., D.L. Weinstat, and D. DiMaio. 1989. Transforming activity of a 16-amino-acid segment of the bovine papillomavirus E5 protein linked to random sequences of hydrophobic amino acids. *J. Virol.* 63:4515–4519.
- Kashles, O., D. Szapary, F. Bellot, A. Ullrich, J. Schlessinger, and A. Schmidt. 1988. Ligand-induced stimulation of epidermal growth factor receptor mutants with altered transmembrane regions. *Proc. Natl. Acad. Sci. USA.* 85: 9567–9571.

- Lee, B.A., and D.J. Donoghue. 1992. Intracellular retention of membrane-anchored *v-sis* protein abrogates autocrine signal transduction. *J. Cell Biol.* 118:1057–1070.
- Lemmon, M.A., J.M. Flanagan, H.R. Treutlein, J. Zhang, and D.M. Engelman. 1992. Sequence specificity in the dimerization of transmembrane α -helices. *Biochemistry.* 31:12719–12725.
- Maher, D.W., L.M. Strawn, and D.J. Donoghue. 1993. Alanine mutagenesis of conserved residues in the platelet-derived growth factor family: identification of residues necessary for dimerization and transformation. *Oncogene.* 8: 533–541.
- Meyer, A.N., Y.-F. Xu, M.K. Webster, A.E. Smith, and D.J. Donoghue. 1994. Cellular transformation by a transmembrane peptide—structural requirements for the bovine papilloma virus E5 oncoprotein. *Proc. Natl. Acad. Sci. USA.* 91:4634–4638.
- Meyers, G.A., S.J. Orlow, I.R. Munro, K.A. Przylepa, and E.W. Jabs. 1995. Fibroblast growth factor receptor 3 (FGFR3) transmembrane mutation in Crouzon syndrome with acanthosis nigricans. *Nat. Genet.* 11:462–464.
- Owens, R.J., C. Burke, and J.K. Rose. 1994. Mutations in the membrane-spanning domain of the human immunodeficiency virus envelope glycoprotein that affect fusion activity. *J. Virol.* 68:570–574.
- Peles, E., R.B. Levy, E. Or, A. Ullrich, and Y. Yarden. 1991. Oncogenic forms of the *neu*/HER2 tyrosine kinase are permanently coupled to phospholipase C γ . *EMBO (Eur. Mol. Biol. Organ.) J.* 10:2077–2086.
- Qian, X., W.C. Dougall, M.E. Hellman, and M.I. Greene. 1994. Kinase-deficient *neu* proteins suppress epidermal growth factor receptor function and abolish cell transformation. *Oncogene.* 9:1507–1514.
- Qian, X., W.C. Dougall, Z. Fei, and M.I. Greene. 1995. Intermolecular association and trans-phosphorylation of different *neu*-kinase forms permit SH2-dependent signaling and oncogenic transformation. *Oncogene.* 10:211–219.
- Rousseau, F., J. Bonaventure, L. Legeai-Mallet, A. Pelet, J.-M. Rozet, P. Maroteaux, M. Le Merrer, and A. Munnich. 1994. Mutations in the gene encoding fibroblast growth factor receptor-3 in achondroplasia. *Nature (Lond.)*. 371: 252–254.
- Schechter, A.L., D.F. Stern, L. Vaidyanathan, S.J. Decker, J.A. Drebin, M.I. Greene, and R.A. Weinberg. 1984. The *neu* oncogene: an *erb-B*-related gene encoding a 185,000 M_r tumour antigen. *Nature (Lond.)*. 312:513–516.
- Segatto, O., C.R. King, J.H. Pierce, P.P. Di Fiore, and S.A. Aaronson. 1988. Different structural alterations upregulate in vitro tyrosine kinase activity and transforming potency of the *erbB-2* gene. *Mol. Cell. Biol.* 8:5570–5574.
- Shiang, R., L.M. Thompson, Y.-Z. Zhu, D.M. Church, T.J. Feilder, M. Bocian, S.T. Winokur, and J.J. Wasmuth. 1994. Mutations in the transmembrane domain of FGFR3 cause the most common genetic form of dwarfism, achondroplasia. *Cell.* 78:335–342.
- Shih, C., L.C. Padhy, M. Murray, and R.A. Weinberg. 1981. Transforming genes of carcinomas and neuroblastomas introduced into mouse fibroblasts. *Nature (Lond.)*. 290:261–264.
- Siegel, P.M., D.L. Dankort, W.R. Hardy, and W.J. Muller. 1994. Novel activating mutations in the *neu* proto-oncogene involved in induction of mammary tumors. *Mol. Cell. Biol.* 14:7068–7077.
- Stein, D., J. Wu, S.A.W. Fuqua, C. Roonprapunt, V. Yajnik, P. D'Eustachio, J.J. Moskow, A.M. Buchberg, C.K. Osborne, and B. Margolis. 1994. The SH2 domain protein GRB-7 is co-amplified, overexpressed and in a tight complex with HER2 in breast cancer. *EMBO (Eur. Mol. Biol. Organ.) J.* 13: 1331–1340.
- Stern, D.F., M.P. Kamps, and H. Cao. 1988. Oncogenic activation of p185^{neu} stimulates tyrosine phosphorylation in vivo. *Mol. Cell. Biol.* 8:3969–3973.
- Sternberg, M.J.E., and W.J. Gullick. 1989. *Neu* receptor dimerization. *Nature (Lond.)*. 339:587.
- Sternberg, M.J.E., and W.J. Gullick. 1990. A sequence motif in the transmembrane region of growth factor receptors with tyrosine kinase activity mediates dimerization. *Protein Eng.* 3:245–248.
- Treutlein, H.R., M.A. Lemmon, D.M. Engelman, and A.T. Brunger. 1992. The glycoporphin A transmembrane domain dimer: sequence-specific propensity for a right-handed supercoil of helices. *Biochemistry.* 31:12726–12733.
- Ullrich, A., and J. Schlessinger. 1990. Signal transduction by receptors with tyrosine kinase activity. *Cell.* 61:203–212.
- Webster, M.K., and D.J. Donoghue. 1996. Constitutive activation of fibroblast growth factor receptor 3 by the transmembrane domain point mutation found in achondroplasia. *EMBO (Eur. Mol. Biol. Organ.) J.* 15:520–527.
- Weiner, D.B., Y. Kokai, T. Wada, J.A. Cohen, W.V. Williams, and M.I. Greene. 1989a. Linkage of tyrosine kinase activity with transforming ability of the p185^{neu} oncoprotein. *Oncogene.* 4:1175–1183.
- Weiner, D.B., J. Liu, J.A. Cohen, W.V. Williams, and M.I. Greene. 1989b. A point mutation in the *neu* oncogene mimics ligand induction of receptor aggregation. *Nature (Lond.)*. 339:230–231.
- Wides, R.J., N.B. Zak, and B.-Z. Shilo. 1990. Enhancement of tyrosine kinase activity of the *Drosophila* epidermal growth factor receptor homolog by alterations of the transmembrane domain. *Eur. J. Biochem.* 189:637–645.