

# Lawrence Berkeley National Laboratory

## Recent Work

### Title

CHARGE FRACTIONS AND EXCITED-ATOM POPULATIONS OF 8-TO 100-keV DEUTERIUM BEAMS EMERGING FROM SOLID FILMS OF C, Mg, Nb, AND Au

### Permalink

<https://escholarship.org/uc/item/0dc2s7kb>

### Author

Berkner, Klaus H.

### Publication Date

1972-05-01

CHARGE FRACTIONS AND EXCITED-ATOM POPULATIONS  
OF 8- TO 100-keV DEUTERIUM BEAMS EMERGING FROM  
SOLID FILMS OF C, Mg, Nb, AND Au

Klaus H. Berkner, Isaac Bornstein, Robert V. Pyle,  
and J. Warren Stearns

March 1, 1972

AEC Contract No. W-7405-eng-48



**For Reference**

Not to be taken from this room

## **DISCLAIMER**

This document was prepared as an account of work sponsored by the United States Government. While this document is believed to contain correct information, neither the United States Government nor any agency thereof, nor the Regents of the University of California, nor any of their employees, makes any warranty, express or implied, or assumes any legal responsibility for the accuracy, completeness, or usefulness of any information, apparatus, product, or process disclosed, or represents that its use would not infringe privately owned rights. Reference herein to any specific commercial product, process, or service by its trade name, trademark, manufacturer, or otherwise, does not necessarily constitute or imply its endorsement, recommendation, or favoring by the United States Government or any agency thereof, or the Regents of the University of California. The views and opinions of authors expressed herein do not necessarily state or reflect those of the United States Government or any agency thereof or the Regents of the University of California.

CHARGE FRACTIONS AND EXCITED-ATOM POPULATIONS OF 8- TO 100-keV  
DEUTERIUM BEAMS EMERGING FROM SOLID FILMS OF C, Mg, Nb, AND Au\*

Klaus H. Berkner, Isaac Bornstein, Robert V. Pyle,  
and J. Warren Stearns

Lawrence Berkeley Laboratory

University of California

Berkeley, California 94720

1 March 1972

ABSTRACT

Charge-state fractions and yields of highly excited deuterium atoms produced by electron capture when 8- to 100 keV deuterons emerge from C, Mg, Nb, and Au surfaces deposited on thin carbon foils under high vacuum conditions are reported. Atoms with principal quantum number  $n = 6$  were detected with an optical technique; atoms in the levels  $n \approx 12$  to 18 were detected by ionizing them in a strong electric field. Changes with time after evaporation, presumably due to contamination of the surfaces, were observed. The experimental results are compared with available theoretical estimates. Solid and vapor targets are compared for Mg.

## I. INTRODUCTION

A large amount of experimental and theoretical work on charge transfer in gases and vapors has been reported in the literature. Very little quantitative data is available concerning electron capture by hydrogen ions at solid surfaces, although a great deal of beam-foil interaction work concerned with spectroscopy and other aspects of atomic physics is currently being published.<sup>1</sup>

In the present work we report measurements of the charge fractions and excited-atom populations of 8- to 100-keV deuterium beams emerging from freshly deposited solid films. The work of relevance to the present paper probably started with the experiments of Phillips,<sup>2</sup> who measured charge-state fractions of the beam issuing from a foil freshly coated with various materials under moderately good vacuum conditions (approximately  $10^{-6}$  Torr). Phillips showed that the fractions in various charge states changed with time after the material was deposited, all materials eventually giving about the same fractions, presumably due to surface contamination. In 1964, Sweetman et al.<sup>3</sup> measured the excited-state yield of 20- to 100-keV  $H^0$  atoms in the level  $n = 11$  from a carbon foil, and found that it exceeded the yield from a hydrogen gas target. It was this favorable yield of excited-state atoms that provided the motivation for the present study of foils as a charge-exchange medium.

The purpose of the present experiment was to repeat Phillips' charge-fraction measurements under better vacuum conditions and to simultaneously measure the yield of excited states in the neutral component. Since Phillips showed that only the exit surface of a foil

is important for electron capture, we used thin carbon foils as substrates and evaporated the materials to be studied on the exit surface under high vacuum conditions ( $< 10^{-8}$  Torr).

## II. THEORETICAL BACKGROUND

In the energy range of interest here, electron capture by protons colliding with single atoms has been described fairly well by theoretical treatments that give both the total capture cross sections and partial cross sections for capture into any substate. This is most straightforward for collisions with hydrogen atoms, but experience has shown that calculations, based on the first Born approximation, can be adjusted by empirically based recipes to yield good results for collisions with any atom.<sup>4</sup> Much of this work, with emphasis on capture into highly excited states, has been carried out by Hiskes.<sup>5</sup>

The theoretical situation is much worse for the case of electron capture from condensed materials, perhaps because of the greater difficulty of describing the interaction of the proton with a lattice rather than with a single atom, and perhaps because of the paucity of experimental results for comparison with predictions. Of the papers that have been published on this topic in recent times,<sup>6-10</sup> only three give semi-quantitative results.<sup>6-8</sup>

In the first paper, Yavlinskii, Trubnikov, and Elesin<sup>6</sup> have calculated the recombination that takes place at the surface of a metal foil (Debye shielding is assumed to prevent capture in the interior of the metal), treating the capture in the electron gas at the surface as a recombination process. The calculation was carried out in the two

limits that the proton speed,  $v_p$ , is much larger than or much smaller than the speed,  $v_0$ , of an electron at the Fermi surface. In terms of the conduction electron density within the metal,  $n_0$  ( $\text{cm}^{-3}$ ), and the kinetic energy of the proton,  $E_p$  (keV), they found that the fraction of the total beam emerging as protons is given in the two limits by

$$v_p \ll v_0: F^+ = \exp \left[ - \left( \frac{136}{E_p} \right)^{1/2} \left( \frac{n_0}{10^{22}} \right)^{1/6} \right], \quad (1)$$

$$v_p \gg v_0: F^+ = \exp \left[ - \frac{6.5}{E_p} \left( \frac{n_0}{10^{22}} \right)^{1/2} \right]. \quad (2)$$

The experiments reported to date fall approximately in the range  $1 < v_p/v_0 < 10$ . If we neglect the formation of negative ions, we see from the above expressions that the neutral fraction,  $F_0 = 1 - F^+$ , is predicted to be approximately unity at low energies, in agreement with experiment, and to drop off at high energy as  $1/E_p$ , which is much slower than is observed experimentally.<sup>2</sup>

In a later paper, Trubnikov and Yavlinskii considered the case of tunnel recombination near the surface of a metal foil.<sup>7</sup> The calculation was again carried out in two limits: The "fixed ion approximation" (essentially the assumption that  $v_p \ll v_0$ ) yields the result that almost all of the neutral atoms are produced in the  $n = 2$  and  $n = 3$  levels. Using time-dependent perturbation theory, they also calculated the neutral fraction produced in the ground state,  $F_1^0$ , and showed (for the spherically symmetric  $l = 0$  states) that the neutral fraction of the total beam in the excited level  $n$  is

$F_n^0 = F_1^0/n^3$  for  $v_p \gg v_0$ . The results of the latter calculation show that the neutral yield should decrease approximately as  $E_p^{-4}$  for energies above approximately 200 keV.

In principle, both processes described in Refs. 6 and 7 can be taking place. It will be seen later that neither process can, by itself, explain the experimental results. We also shall see that whereas a large change in the density of conduction electrons has a large effect on the predictions of the above theories, the experimental differences in the neutral fraction from, say, gold ( $n_0 \approx 6 \times 10^{22}$ ) and carbon ( $n_0 \approx 3 \times 10^{18}$ )<sup>11</sup> are minor. Therefore, some other mechanism must be operative in the case of semi-metals or insulators, and may also dominate the capture process in metals.

Recently, McLelland<sup>8</sup> has proposed a model that is applicable only when the conduction-electron density is low, as in semi-metals and insulators: Within the material, a fast proton produces a shower of positive-energy electrons, some of which have velocities close to that of the proton and thus are candidates for possible capture. As these are free electrons, an interaction via the lattice potential is required for the capture process to take place. After making plausible choices of the free-electron yield and energy-distribution function, McLelland calculated capture probabilities for a carbon target that are in order-of-magnitude agreement with experiment. The numerous assumptions required to obtain quantitative results limit the usefulness of these calculations; however, the general features of the model can be tested by comparing the calculated and experimental energy dependence. These calculations were carried out for proton energies



above 20 keV, and included a  $n^{-3}$  distribution over excited states.

There is, of course, the approach introduced by Bohr and Lindhard, considering a solid as a thick target of isolated atoms.<sup>12,10</sup> In this spirit we will compare equilibrium fractions from solid and gaseous magnesium targets in Sec. IV.

### III. APPARATUS AND PROCEDURE

A beam of deuterium ions from an electrostatic accelerator was momentum analyzed and entered the charge exchange and analysis chamber (Fig. 1). After collimation to a diameter of 1.57 mm, the beam, typically 1  $\mu$ A, passed through a 6-mm-diam self-supporting target foil.

The beam that emerged from the foil consisted of positive and negative deuterium ions and neutral atoms in various states of excitation. The two charged states were separated by electrostatic deflection and stopped in 2.25-cm-diam magnetically-guarded Faraday cups. The neutral component was detected by measuring the power of a 2.25-cm-diam pyroelectric detector,<sup>13</sup> or, at the lowest energies where the current and power were small, by measuring the current from a 2.25-cm-diam surface-barrier solid-state detector that was operated as an ion chamber. In either case, the neutral detectors were calibrated by switching the beam deflection voltage off, thereby putting the known charged components into the neutral detector. The outputs of the various detectors were amplified and integrated. A block diagram of the general electronic circuitry is shown in Fig. 2. A calibration of the detectors and measurement of the fractions in various charge states required about 30 sec, a time very much shorter than any

observed time constant associated with contamination of the foil surfaces.

The energy of the deuterons emerging from the foil was analyzed by electrostatic deflection into a Faraday cup masked by a plate with a 3-mm-wide slit.

Two methods were used to determine the fractions of the neutral beam that emerged in highly excited levels. The first was an optical method that had previously been used to determine yields from charge exchange in a magnesium vapor target and gave information about the population of the  $n = 6$  level.<sup>14</sup> The second was electric-field ionization of atoms in highly excited levels<sup>15</sup> ( $12 \leq n \leq 18$ ). These two methods will be described in greater detail further on in this section.

The target foil consisted of a 6-mm-diam, 5- to 10- $\mu\text{g}/\text{cm}^2$  carbon-foil substrate.<sup>16</sup> The energy loss in the substrate was usually 2 to 5 keV. The presence of deuterons whose energy had not been degraded by this amount was an indication that there were pinholes in the substrate. If this occurred, the foil was moved until the fraction of primary energy deuterons was less than  $10^{-4}$ .

Fresh material could be evaporated onto the substrate while the target chamber was maintained at high vacuum. To accomplish this, an electron-gun (e-gun) evaporator unit was mounted in a separately pumped vacuum chamber which was connected to the target chamber by means of an electrically operated valve. This valve, which was normally closed, was used as a shutter to control the amount of material deposited on the foil. The procedure was to outgas the material in the

evaporator and open the shutter to expose the foil while the beam was passing through it. When enough material had been deposited to degrade the energy of the emerging beam by several hundred eV, the shutter was closed and the charge fractions were measured. This procedure was repeated until the measured charge fractions no longer changed; this usually occurred after an energy loss of about 2 keV. Once equilibrium was attained a complete set of measurements was taken.

Every attempt was made to achieve a clean high vacuum. Metal gaskets were used everywhere except in three valves which had Viton O-rings. The chamber was baked with a quartz lamp mounted inside the vacuum system. The system was roughed out with  $N_2$  aspirators and sorption pumps, routinely maintained at low pressures ( $\sim 5 \times 10^{-8}$  Torr) by a VacIon pump, and during measurements involving evaporation was maintained at  $2 \times 10^{-9}$  Torr by a liquid-helium cryopump. When the shutter was opened, the pressure usually rose to as much as  $3 \times 10^{-8}$  Torr, but quickly pumped down again as soon as the shutter was closed.

Two Ti-getter pumps in the beam line and a small aperture (A in Fig. 1) isolated the high-vacuum chamber from the relatively high-pressure ( $10^{-5}$  to  $10^{-6}$  Torr) accelerator section. The foil substrates were introduced through a vacuum lock so that foils could be changed without bringing the entire system up to air.

In the optical method of detecting excited atoms, single photons from the  $4101\text{-}\text{\AA}$  transition (Balmer  $H_\delta$ ) from the  $n = 6$  level were counted. At first a monochromator was used to select the proper spectral line, but during most of the experiment we used a bandpass filter. To maximize the light focused on the photomultiplier, the

first lens of the system was in a re-entrant cavity in the analysis chamber, 5 cm from the beam line. An EMI type 6256S photomultiplier, cooled to  $-20^{\circ}\text{C}$  to eliminate background noise, was used to detect the photons.

The optical detection efficiency was measured each time the foil or energy was changed, and after each evaporation. This was accomplished by introducing nitrogen at four gas pressures from 2 to 9  $\mu\text{Torr}$  into the analysis chamber and counting photons from the  $\text{N}_2^+$  transition with the band head at  $3914 \text{ \AA}$  [0-0 band of the first negative band system of  $\text{N}_2^+$  ( $\text{B}^2\Sigma_u^+ - \text{X}^2\Sigma_g^-$ )], for which the yields produced by either proton or hydrogen-atom impact have been measured by several groups (see Appendix A). The pressure was measured with an ionization gauge which was calibrated with a Barocel capacitance manometer in the  $10^{-4}$  - to  $10^{-5}$ -Torr range. Following a scan with a monochromator to determine the band intensity as a function of wavelength, the light from this transition was selected with a second bandpass filter. The relative transmission of the filters, windows, and lenses for the  $\text{H}_\delta$  line and the  $\text{N}_2^+$  band, measured independently, was used to obtain the optical efficiency at  $4101 \text{ \AA}$ . The transmission measurements were confirmed by comparing ratios of  $\text{H}_\delta$  and 0-0 band  $\text{N}_2^+$  counts made simultaneously with the monochromator and filters. (In the process, we showed, by scanning the 0-0 band with a narrow slit, that  $\geq 95\%$  of the  $\text{N}_2^+$  light was passed by the slit used in the experiments. The difference in photon counting efficiencies, using the monochromator at the hydrogen and nitrogen wavelengths, was estimated to be 5%).<sup>14</sup>

The technique for obtaining the yield of atoms in the  $n = 6$

level from the measured counting rates is essentially the same as described in Ref. 14; however, additional information about the nitrogen excitation cross sections has become available and is included here. The way that these data are combined, the method of reducing data, and a brief description of error estimates are given in Appendix A. Additional information can be obtained from Ref. 14. The main sources of uncertainty in this method are the unknown population distribution of the substates of  $n = 6$  (we assume a statistical distribution here<sup>17</sup>) and the nitrogen excitation cross section. Our estimate of the latter is about  $\pm 30\%$  (see Appendix A); the total absolute standard error is estimated to be about  $\pm 40\%$ . However, the relative standard errors, based on repeatability, are estimated to be approximately  $\pm 15\%$ .

The polarization of the light from hydrogen decays and nitrogen excitation was checked and found to be small, less than 4% for 25- to 60-keV deuterons. (We have found previously that the polarization of the  $H_{\beta}$  radiation from electron capture in magnesium vapor targets is also negligible.<sup>14</sup>)

The excited-state measurements made with the electric-field-ionization technique were carried out with a high-voltage gap made of three 22-mm-diam, 8 line/cm, 96% transparent, tungsten mesh grids spaced 3 mm apart on the entrance side and 8 mm apart on the exit side. The pyroelectric detector, which in this case served as a magnetically shielded Faraday cup, was used to detect the ions produced in the gap. The center grid could be operated at voltages up to  $\pm 15$  kV, which is enough to ionize part of the  $n = 11$  level. For convenience, the maximum voltage was usually  $\pm 9$  kV, sufficient to ionize most of the

$n = 12$  level. The minimum useful voltage, and therefore the maximum measurable  $n$  level, was set by the electric field between the beam deflection plates, which varied with energy. Most of the results quoted later are for  $n$  values approximately between 12 and 18.

A plot of the ion current vs the square root of the gap voltage was made on an X-Y recorder. As described in Appendix B, the slope of the line obtained in this way is approximately proportional to the excited-state yield, and the absolute yield can be obtained from knowledge of the lifetimes of atoms in the electric field and absolute values of the field strength. The method of data analysis and uncertainty estimation is outlined in Appendix B. Standard errors based on reproducibility are estimated to be about  $\pm 15\%$ . The absolute standard error to be assigned to the measurements obtained with this technique is difficult to assess, because of our lack of knowledge about the  $n$ -dependence of the population of the levels at low energies (Appendix B). Our estimate is  $\pm 30\%$ .

#### IV. RESULTS

The experimental results are presented in two ways: graphs for carbon and magnesium, in order that the typical scatter in individual points and the comparison among various experiments will be apparent; and tabulations for all of the materials at several energies, obtained from smooth lines drawn through the experimental points. When material was evaporated onto the substrate, the results characteristic of that material were obtained. No appreciable temporal variations of either charge or excited-atom fractions occurred after evaporation under

normal data-collection conditions ( $\sim 2 \times 10^{-9}$  Torr). However, at a higher pressure,  $1 \times 10^{-8}$  Torr, temporal variations could be measured easily for low ion energies. By far the largest change occurred with a Mg surface. As an example, for deuterons with an exit energy of 8 keV, the excited-atom fraction increased at a rate of about 3%/minute following the evaporation, and the  $F^-$  fraction decreased at a somewhat slower rate (presumably due to contamination of the foil surface). In time (sometimes several hours at  $2 \times 10^{-9}$  Torr) all surfaces acquired the characteristics of a carbon foil prior to evaporation (a "dirty" carbon foil).

#### A. Total Neutral Fraction

The measured total (all n-values) yields of neutral deuterium atoms exiting from "dirty" C and fresh Mg surfaces are shown in Figs. 3 and 4; Table I contains the yields for all targets. Our estimated standard error in these measurements is  $\pm 5\%$ . The "dirty" surface results are seen to be in reasonable agreement with the earlier measurements by Phillips,<sup>2</sup> Wax and Bernstein,<sup>18</sup> and Berry et al.<sup>19</sup>

We could detect no significant difference in the neutral fraction between "dirty" or freshly evaporated carbon film. Gold is the only other material for which a comparison with a previous measurement (by Phillips) is possible; these results also agree within the estimated uncertainties.

Also shown in Fig. 4 are the thick-target Mg vapor results of Moses and Futch.<sup>20</sup>

#### B. Negative Fraction

The fraction of the incident beam that emerges as  $D^-$  ions is shown

for carbon and magnesium surfaces in Figs. 5 and 6. Averaged values for all of the materials are given in Table I. There is a small difference between yields from "clean" and "dirty" carbon surfaces below 40 keV. The "dirty" carbon data are in general agreement with the earlier data of Phillips. The curves for Nb and Au (not shown graphically) are very much like the carbon data, the yields from all of these being much smaller than from Mg at energies below about 30 keV. Our estimated standard error of these measurements is  $\pm 10\%$ . Our gold data agree very well with those of Phillips at energies of 50 keV and higher, but are about 30% lower than Phillips' data at lower energies. Also shown in Fig. 6 are the thick-target Mg vapor results of Moses and Futch.<sup>20</sup>

### C. Excited-Atom Fraction

The basic assumption in the analysis of the electric-field-ionization data is that the excited-atom population has an  $n^{-3}$  dependence on the principal quantum number (see Appendix B). The excited-atom results are therefore presented in the form  $n^3 F_n$ , where  $F_n$  is the ratio of the number of atoms in the principal quantum level  $n$  to the total number of particles in the beam (charged and neutral). In this presentation one can readily compare our optical measurements for the  $n = 6$  level, our field-ionization measurements for the levels  $n \approx 12$  to 18, and the field-ionization measurements of Sweetman et al.<sup>3</sup> for  $n = 11$ . The results are presented graphically for "dirty" C and fresh Mg surfaces in Figs. 7 and 8. For a comparison of the different foil materials we present the field-ionization results in Table II.

As discussed in the appendices, the standard errors are estimated



to be about  $\pm 40\%$  for the optical measurements and  $\pm 30\%$  for the field-ionization measurements. Only the relative standard errors, based on reproducibility, are shown in Figs. 7 and 8.

Also shown in Fig. 8 are the field-ionization results ( $n \approx 9$  to 15) for Mg vapor reported by Il'in et al.<sup>21</sup>

## V. DISCUSSION AND CONCLUSIONS

### A. The Neutral Fraction, $F^0$

Where our data overlap, they are in good agreement with those of Phillips;<sup>2</sup> our measurements were made at pressures several orders of magnitude lower than his.

Measured neutral yields from solid Mg and Au surfaces are shown in Fig. 9, together with theoretical predictions from Refs. 6 and 7 (negative ion formation is neglected). The calculated results, using the various theoretical approximations, bracket the experimental data and could be combined empirically to approximate the experimental curves.

The experimental neutral yield from carbon is not very different from the metallic yields (see Table I). Since carbon has a much lower free-electron density than the metals, the models of Refs. 5 and 6 cannot be applicable. As mentioned in Sec. II, the parameters in McLelland's electron-shower model for carbon<sup>8</sup> can be adjusted to give approximate agreement with experiment in the proton energy range from about 20 to 70 keV. However, it seems premature to consider this as verification of the correctness of the model.

In Fig. 4 we included, for comparison with the results for a solid Mg target, and experimental curve of  $F^0$  vs energy for a thick

magnesium-vapor target. One sees that the data from the two types of target are quite different. Nevertheless, in the energy range of the present experiment it is a fair working approximation to treat the solid targets as if they were thick gas targets. Discussion of some of the differences observed and expected for targets in the different phases, as related to stopping power, can be found in the literature.<sup>22</sup>

B. Negative Fraction,  $F^-$

Our results for  $F^-$  are in good agreement with the measurements of Phillips<sup>2</sup> for the two materials (Au and "dirty" surfaces) common to both experiments. We are not aware of any theoretical estimates with which to compare our results.

There is little difference in the negative fractions produced from C, Nb, Au, or "dirty" surfaces for the energy range covered in this experiment (see Table I). Mg, however, produces a significantly larger fraction of  $D^-$  below 50 keV. Vapor targets of low-ionization-potential materials (such as alkali or alkali-earth metals) are known to yield relatively large fractions of negative ions at low energies.<sup>23</sup> From Fig. 6 we see that  $F^-$  from a Mg surface exceeds that from a thick Mg-vapor target.

C. Excited-Atom Fractions

As the data in Figs. 7 and 8 indicate, both for "dirty" C and fresh Mg surfaces the excited-atom fractions obtained with the optical method exceed the field-ionization results. The difference in the results of the two methods is more pronounced for Mg, but even in this case the fractions agree within the estimated standard errors ( $\pm 40\%$  for optical and  $\pm 30\%$  for field ionization).

Since the optical results are for the level  $n = 6$  and those from field-ionization are for  $n \approx 12$  to  $18$ , the general agreement of the measurements supports our assumption of an  $n^{-3}$  scaling law for the population of the level  $n$ . The theories of both McLelland<sup>8</sup> and Trubnikov and Yavlinskii<sup>7</sup> predict this  $n^{-3}$  dependence at high energies; however, there is no quantitative agreement between either of these calculations and the experimental results.

As was the case for  $F^0$  and  $F^-$ , the energy dependence of the excited-atom fraction from solid Mg is quite different from that produced in a Mg-vapor target. This is demonstrated in Fig. 8, where we have indicated the field-ionization ( $n \approx 9$  to  $15$ ) results of Il'in et al.<sup>21</sup> for both the equilibrium (thick-target) yield and the optimum yield, which occurs at a lower target thickness.

For clean surfaces the excited-atom fractions exhibit a decrease both at the high- and low-energy end of our energy range. The fraction produced in "dirty" carbon, on the other hand, continues to increase with decreasing energy.

#### ACKNOWLEDGMENTS

We express our appreciation to V. J. Honey for help with the design and construction of much of the electronic apparatus, J. G. Conway for measurements of the optical transmission of our filters and lenses, and M. R. May for bringing G. J. McLelland's unpublished work to our attention.

APPENDICES

A. Analysis of the Optical Data

Neutral atoms emerging from the foil travel 1.28 cm before entering a region 1.5 cm long (along the beam line) that is imaged on the photomultiplier cathode. Some of the deuterium atoms that emerge from the foil in the  $n = 6$  level decay before they reach the region of observation, some of the remainder decay within the 1.5-cm region of observation. We can assume that repopulation from higher levels cascading is negligible (see Ref. 14). Only those atoms in the 6s, 6p, and 6d states make the  $4101-\text{\AA}$  transitions that are recorded. To deduce the number of  $n = 6$  atoms leaving the foil, we must make assumptions about the initial population distribution of angular momentum states, calculate the transition rates for the various states, and calibrate the overall optical efficiency of the system. Then from the observed photon counts, we calculate the number of atoms that were originally in the 6s, 6p, and 6d states; to these must be added the inferred number of atoms that were created in higher angular momentum states of the  $n = 6$  level. If we assume that the states of the  $n = 6$  level initially have a statistical  $(2\ell + 1)$  distribution,<sup>17</sup> we obtain the following expression for  $N(D_8)$ , the measured number of photons per incident beam particle:

$$N(D_8) = N_6^0 \sum_{\ell=0}^2 \frac{2\ell + 1}{36} \exp \left[ -v^{-1} x_1 A(6\ell) \right] \\ \times \frac{A(6\ell \rightarrow 2sp)}{A(6\ell)} \left\{ 1 - \exp \left[ -v^{-1} x_2 A(6\ell) \right] \right\},$$

where  $N_6^0$  is the fraction of the total incident beam that is in the level  $n = 6$  at the exit of the foil,  $x_1$  is the distance from the foil to the observation region,  $x_2$  is the length of the observation region,  $v$  is the speed of the atoms, and  $A(6\ell) \equiv \sum_{\ell'n'} A(6\ell \rightarrow n'\ell')$  is the transition probability for going to all possible states. Using the decay data in Table II of Ref. 14, we obtain

$$N_6 = N(D_8) \times 10^3 \times (46.8E^{-1/2} - 23.7E^{-1})^{-1} \epsilon^{-1},$$

where  $\epsilon$  is the efficiency for detecting a 4101-Å photon emitted in the observation region, and  $E$  is the deuteron energy in keV.

In the work of Ref. 14 it was sufficient to determine the optical efficiency at one energy. In the present experiment, however, there was considerable angular scattering of the beam by the foil, which depended on the beam energy, foil material, and foil thickness. This meant that whereas the photomultiplier, which viewed the beam near the exit of the foil, received light from the entire beam, the charge detectors received only that part of the beam that passed through the collimator D (Fig. 1). Consequently, the optical efficiency in this experiment is the number of detected photons per detected particle. The efficiency was determined for each measurement. As described in Sec. III, the method of obtaining  $\epsilon$  is straightforward and the result contains no large uncertainties other than those in the cross sections for excitation of the calibration band at 3914 Å by deuterons and deuterium atoms in  $N_2$  gas. (In the absence of any other information, we assume that the few negative deuterium ions have the same excitation cross sections as  $D^+$  ions.) Measurements of these cross sections

reported during the past 12 years<sup>24-33</sup> are shown in Figs. 10 and 11 for incident protons and hydrogen atoms, respectively. (It has been shown by Thomas et al. that hydrogen cross sections are the same as for deuterons of twice the energy.<sup>28</sup>) Overlaying the curves in Fig. 10 shows that all but one have the same shape, which we show in our average curve K. The position of this average curve was determined by obtaining a weighted geometric mean of the other data at 60 keV (curve H was not used in the average). These data points were weighted as the inverse square of the percentage errors quoted by the original authors. This gives an uncertainty in the  $H^+$  cross section of  $\pm 29\%$  for a 68% confidence interval.

To obtain the emission cross section for  $H^0$  impact we deduced an average energy dependence by overlaying the curves in Fig. 11. Since we know of only two absolute measurements in this case, the following procedure was used to determine the magnitude of the cross section: We used the average value calculated for  $H^+$  impact and related it to  $H^0$  impact by dividing it by the ratio of the 60-keV cross sections for the three groups who published data for both processes at this energy. This average ratio was 1.52, so the average curve for  $H^0$  impact is normalized to  $2.49 \times 10^{-17} \text{ cm}^2/\text{molecule}$  at 60 keV.

The uncertainty in the  $H^+$  cross section, using a 68% confidence interval, is  $\pm 29\%$ . To obtain the uncertainty in the  $H^0$  cross section, one folds into this the uncertainty in the ratio of cross sections ( $\pm 13\%$ ) and obtains  $\pm 31\%$ .

### B. Analysis of the Electric-Gap Data

A review of the technique of field ionization to measure the population of excited levels of hydrogen atoms can be found in Ref. 15. In the present experiment we used the method of Il'in et al.<sup>34</sup> to analyze the field-ionized proton current: The electric field required to destroy an excited level  $n$ , from the Bohr model of the atom, is  $E_n = bn^{-4}$ , and the population of highly excited states, from Born-approximation calculations of electron capture, is given by  $\alpha n^{-3}$ . Il'in et al. showed that these relations lead to an expression for the fraction of the atom beam which is field ionized:

$$I(E) = \frac{\alpha \sqrt{E}}{2 \sqrt{b}}, \quad (B1)$$

where  $E$  is the applied electric field. Thus, by plotting  $I$  vs  $\sqrt{E}$ , the constant  $\alpha$ , which characterizes the excited-state yield, can be obtained from the slope.

From the calculations of Bailey, Hiskes, and Riviere<sup>35</sup> we find that for a statistical distribution of substates and an ionization time of  $3 \times 10^{-10}$  sec (a typical time-of-flight through our gap),  $E_n = (4.3 \times 10^5)n^{-3.82}$  kV/cm. It can be shown that for our range of  $n$  there will be only a few percent difference in the results if we fit this to the classical expression  $E_n = bn^{-4}$ , with  $b = 6.8 \times 10^5$  kV/cm. (Il'in et al. used a value  $b = 6.2 \times 10^5$  kV/cm, which they deduced from their differential measurements.) Thus Eq. (B1) can be expressed as

$$I(E) = 6.1 \times 10^{-4} \alpha \sqrt{E(\text{kV/cm})}. \quad (B2)$$

We used this expression to determine  $\alpha$ .

To utilize Eq. (B2), we must relate the potential applied to the gap to the electric field. Since we use grids, the electric field in the gap is not uniform; hence we determined an equivalent electric field,  $E = cV$ , as follows. The ion current produced in the gap exhibited a threshold behavior because the electric field in the deflection plate region preionized the very highly excited states; therefore no field ionization occurred in the gap until the electric field there exceeded the deflection electric field. From this threshold we could relate the equivalent electric field in the gap to the electric field between the deflection plates, which was obtained from potential profiles in an electrolytic tank. In this way we determined that  $c = 4.8 \pm 0.7 \text{ cm}^{-1}$ .

The estimated uncertainty in the values of  $\alpha$  obtained in this way is made up of a random part, based on internal consistency, for which we estimate a 68% confidence interval of  $\pm 15\%$ , and a possible systematic error that enters through the constants  $b$  and  $c$ . By comparing our choice of  $b$  with that of Il'in et al. we assign it an uncertainty of  $\pm 15\%$ . Since both  $b$  and  $c$  appear in Eq. (B2) as square roots, the total systematic error in  $\alpha$  due to these constants is  $\pm 9\%$ .

There is an additional uncertainty due to the assumptions involved in the model. As previously mentioned, in this analysis we assume that the populations of various quantum levels vary as  $n^{-3}$ . Hiskes' calculations for charge exchange in gases<sup>5</sup> show that the exponent may be closer to  $-4$  than  $-3$  at low energies. We do not know whether this change in  $n$ -dependence also occurs for electron capture



in foils. To get an indication of how a change in n-dependence would affect our results, we considered three different functions for the population:  $n^{-3}$ ,  $n^{-3.5}$ , and  $n^{-4}$ . For these the analysis leading to Eq. (B1) yields the following dependences on the gap voltage:  $V^{0.5}$ ,  $V^{0.625}$ , and  $V^{0.75}$ . An investigation of our gap data shows that we can get an equally good fit for all three exponents over our voltage range. (On an  $I$  vs  $V^{1/2}$  plot the deviation from linearity for the  $V^{0.75}$  case is so slight that it might not be recognized from the data.) If we then use the different values obtained for  $\alpha$  to evaluate the population of  $n = 6$ , the results are in the ratio of 1:0.67:0.44.

FOOTNOTE AND REFERENCES

\* Work done under the auspices of the U. S. Atomic Energy Commission.

1. See, for example, Proceedings of the Second International Conference on Beam-Foil Spectroscopy, Lysekil, Sweden (1970), published in Nucl. Instr. Methods 90 (1970)
2. J. A. Phillips, Phys. Rev. 97, 494 (1955).
3. D. R. Sweetman, A. C. Riviere, and P. Hammond, in Culham Laboratory Progress Report CLM-PR-7, p. 47, 1964.
4. See, for example, the discussion in the paper by K. H. Berkner, R. V. Pyle, and J. W. Stearns, Phys. Rev. 178, 248 (1969).
5. J. R. Hiskes, Phys. Rev. 180, 146 (1969).
6. Yu. N. Yavlinskii, B. A. Trubnikov, and V. F. Elesin, Izv. Akad. Nauk SSSR Ser. Fiz. 30, 1917 (1966) [English transl.: Bull. Acad. Sci. Phys. Ser. 30, 1996 (1966)].
7. B. A. Trubnikov and Yu. N. Yavlinskii, Zh. Eksp. Teor. Fiz. 52, 1638 (1967) [English transl.: Soviet Phys.-JETP 25, 1089 (1967)].
8. G. J. McLelland, Production of Highly Excited Neutral Atoms by Charge Exchange in Solids, Ph. D. Thesis, School of Physics, University of Sydney, Sydney, Australia, 1968.
9. J. D. Garcia, Nucl. Instr. Methods 90, 295 (1970).
10. W. S. Bickel, K. Jensen, C. S. Newton, and E. Veje, Nucl. Instr. Methods 90, 309 (1970).
11. Charles Kittel, Introduction to Solid State Physics, 4th Ed. (John Wiley and Sons, New York, 1971).
12. N. Bohr and J. Lindhard, Kgl. Danske Videnskab. Selskab, Mat.-Fys. Medd. 28, No. 7 (1954).

13. K. H. Berkner, B. R. Myers, and R. V. Pyle, Rev. Sci. Instr. 39, 1204 (1968).
14. K. H. Berkner, W. S. Cooper III, S. N. Kaplan, and R. V. Pyle, Phys. Rev. 182, 103 (1969).
15. See, for example, A. C. Riviere, Ionization, Detachment and Dissociation by Electric and Magnetic Fields, in Method of Experimental Physics, B. Bederson and W. L. Fite, Eds. (Academic Press, New York, 1968), Vol. 7, Part A, Chap. 2.4.
16. Carbon is used as a substrate material because it is strong, low-Z, and easily and economically obtained. Our foils were purchased from Yissum Research Corporation, Hebrew University, Jerusalem, Israel.
17. The consequences and alternatives to choosing an initially statistical substate distribution are discussed in Ref. 14.
18. R. L. Wax and W. Bernstein, Rev. Sci. Instr. 38, 1612 (1967).
19. H. G. Berry, J. Bromander, and R. Buchta, Nucl. Instr. Methods 90, 269 (1970).
20. K. G. Moses and Archer H. Futch, Jr., Bull. Am. Phys. Soc. 11, 344 (1966), and private communication.
21. R. N. Il'in, V. A. Oparin, E. S. Solov'ev, and N. V. Fedorenko, Zh. Eksp. Teor. Fiz., Pis'ma Redakt. 2, 310 (1965) [JETP Letters 2, 197 (1965)].
22. See, for example, W. Meckbach and S. K. Allison, Phys. Rev. 132, 294 (1965).
23. See, for example, W. Gruebler, P. A. Schmelzbach, V. Koenig, and P. Marmier, Helv. Phys. Acta 72, 254 (1970).

24. J. L. Philpot and R. H. Hughes, Phys. Rev. 133, A107 (1964).
25. J. M. Robinson and H. B. Gilbody, Proc. Phys. Soc. (London) 92, 589 (1967).
26. M. Dufay, J. Desesquelles, M. Druetta, and M. Eidelsberg, Ann. Geophys. 22, 619 (1966).
27. D. A. Dahlberg, D. K. Anderson, and I. E. Dayton, Phys. Rev. 164, 20 (1967).
28. E. W. Thomas, G. D. Bent, and J. L. Edwards, Phys. Rev. 165, 32 (1968).
29. N. P. Carlton and T. R. Lawrence, Phys. Rev. 109, 1159 (1958).
30. H. A. B. Gardiner, W. R. Pendleton, Jr., J. J. Merrill, and D. J. Baker, Phys. Rev. 188, 257 (1969).
31. J. R. Sheridan and K. C. Clark, Phys. Rev. 140, A1033 (1965).
32. R. J. McNeal and D. C. Clark, J. Geophys. Res. 74, 5065 (1969).
33. W. F. Sheridan, O. Oldenberg, and N. P. Carlton, in Second International Conference on the Physics of Electronic and Atomic Collisions, Boulder, Colorado, 1961, p. 159.
34. R. N. Il'in, B. I. Kikiani, V. A. Oparin, E. S. Solov'ev, and N. V. Fedorenko, Zh. Eksp. Teor. Fiz. 47, 1235 (1964) [Soviet Phys.-JETP 20, 835 (1965)].
35. D. S. Bailey, J. R. Hiskes, and A. C. Riviere, Nucl. Fusion 5, 41 (1965).

Table I. Charge fractions for deuterium beams emerging from various surfaces. The estimated standard errors are  $\pm 5\%$  for  $F^0$  and  $\pm 10\%$  for  $F^-$ . The entries were obtained from smooth curves drawn through the data, as in Figs. 3 to 6.

Exit energy (keV)	"Dirty" C		C		Mg		Nb		Au	
	$F^0$	$F^-$	$F^0$	$F^-$	$F^0$	$F^-$	$F^0$	$F^-$	$F^0$	$F^-$
8	0.84	0.038	0.80	0.024	0.83	0.120	0.90	0.037	--- <sup>a</sup>	0.028 <sup>b</sup>
16	0.75	0.024	0.76	0.0185	0.82	0.090	0.85	0.030	---	0.027 <sup>b</sup>
30	0.64	0.016	0.67	0.0140	0.78	0.035	0.73	0.015	---	0.020 <sup>b</sup>
50	0.55	0.0112	0.56	0.0105	0.65	0.0143	0.55	0.0067	0.67	0.0120
70	0.50	0.0081	0.50	0.0081	0.53	0.0080	0.44	0.0046	0.59	0.0076
100	0.43	0.0053	0.44	0.0053	0.38	0.0042	0.38	0.0030	0.40	0.0037

<sup>a</sup>The large angular scattering in Au at low energies resulted in such low signals that no reliable  $F^0$  measurements were obtained.

<sup>b</sup>Derived from measured  $D^+$  and  $D^-$  currents and  $F^0$  from Phillips (Ref. 2).

Table II. Excited-atom yields, expressed as the product of  $n^3$  and  $F_n$  (the fraction of the total beam in the level  $n$ ), for deuterium beams emerging from various surfaces. These results are obtained using electric-field ionization of levels  $n \approx 12$  to 18. The relative standard errors, based on reproducibility, are  $\pm 15\%$  except at 8 keV, where they are  $\pm 30\%$ . The standard errors in the absolute values are estimated to be  $\pm 30\%$ , except at 8 keV, where they are  $\pm 45\%$ .

Exit energy (keV)	"Dirty" carbon	C	Mg	Nb	Au
8	1.27	0.85	0.51	0.40	0.52
16	1.09	1.09	0.69	0.54	0.52
30	0.86	0.86	0.90	0.74	0.57
50	0.71	0.71	0.90	0.88	0.59
70	0.63	0.63	0.80	0.82	0.62
100	0.55	0.55	0.64	0.63	0.59

FIGURE LEGENDS

- Fig. 1. Analysis chamber. Insert shows collimation: A, 1.32; B, 1.57; C, 2.72 mm diameter.
- Fig. 2. Block diagram of the electronics.
- Fig. 3. Neutral fractions from "dirty" surfaces. P, Ref. 2; WB, Ref. 18; BBB-1(C) and BBB-2(Al), Ref. 19; ●, present work (a representative standard error is shown). The H atom results of Refs. 2, 18, and 19 have been plotted at twice the H energy. The dashed line is drawn through our data.
- Fig. 4. Neutral fraction from a fresh Mg surface. The estimated standard error is shown at a representative point. The dashed line is drawn through our data. The solid line is the neutral fraction obtained from a thick Mg vapor target, Ref. 20.
- Fig. 5. Negative fraction from a carbon foil: ●, "dirty" carbon; ○, freshly evaporated carbon. The estimated standard error is shown at a representative point. The dashed lines are drawn through our data. The line labeled P represents the  $H^-$  results of Phillips (Ref. 2) for dirty surfaces, plotted at twice the  $H^-$  energy.
- Fig. 6. Negative fraction from a fresh Mg surface. The estimated standard error is shown at a representative point. A dashed line is drawn through the data. The solid line is the negative fraction obtained from a thick Mg vapor target, Ref. 20.

Fig. 7. Excited-atom results for "dirty" carbon surfaces, presented in the form  $n^3 F_n$ , where  $F_n$  is the ratio of the number of atoms in the principal quantum level  $n$  to the total number of particles in the beam (charged and neutral). Optical method (this work):  $\circ$ , filter;  $\square$ , monochromator. Field-ionization measurements:  $\bullet$ , present work; — Sweetman et al. (Ref. 3). The representative standard errors indicated are based on reproducibility only. The estimated standard errors in the absolute values are  $\pm 30\%$  for the field ionization and  $\pm 40\%$  for the optical results. The dashed line is drawn through our field-ionization data.

Fig. 8. Excited-atom results,  $n^3 F_n$ , for fresh Mg surfaces:  $\circ$ , filter;  $\bullet$ , field ionization. The representative standard errors indicated are based on reproducibility only. The estimated standard errors in the absolute values are  $\pm 30\%$  for the field ionization and  $\pm 40\%$  for the optical results. The dashed line is drawn through our field-ionization data. The solid lines are for Mg vapor targets: 1, thick target (Ref. 21); 2, target optimized for maximum excited-atom yield (Ref. 21).

Fig. 9. A comparison of measured neutral yields from solid Mg,  $\bullet$ , and Au,  $\circ$ , surfaces with theoretical predictions from Ref. 6 (YTE) and Ref. 7 (TY). The solid line, P, is Phillips' Au data (Ref. 2). Our experimental results with deuterium are plotted at half energy.



Fig. 10. Emission cross-section measurements of the 0-0 first negative band of  $N_2^+$  (3914 Å) produced by bombardment of  $N_2$  by  $H^+$ . Solid lines indicate absolute measurements, dashed lines indicate relative measurements. A, Ref. 24; B, Ref. 25; C, Ref. 26; D, Ref. 27; E, Ref. 28; F, Ref. 29; G, Ref. 30; H, Ref. 31; I, Ref. 32; J, Ref. 33; K, weighted average curve used in present experiment.

Fig. 11. Emission cross-section measurements of the 0-0 first negative band of  $N_2^+$  (3914 Å) produced by bombardment of  $N_2$  by  $H^0$ . Solid lines indicate absolute measurements, dashed lines indicate relative measurements. B, Ref. 25; D, Ref. 27; G, Ref. 30; I, Ref. 32; K, derived cross-section curve used in present experiment (see text).

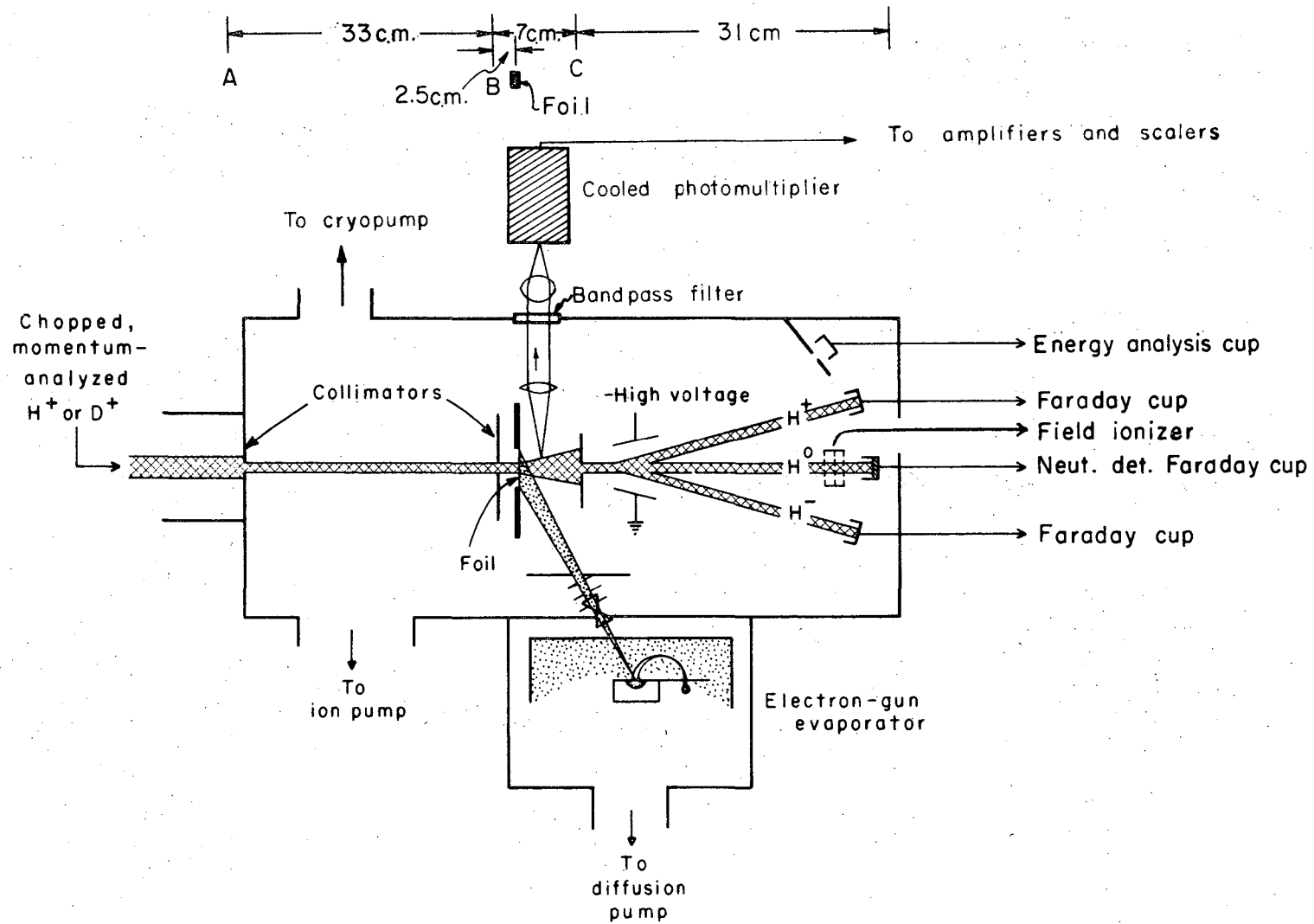
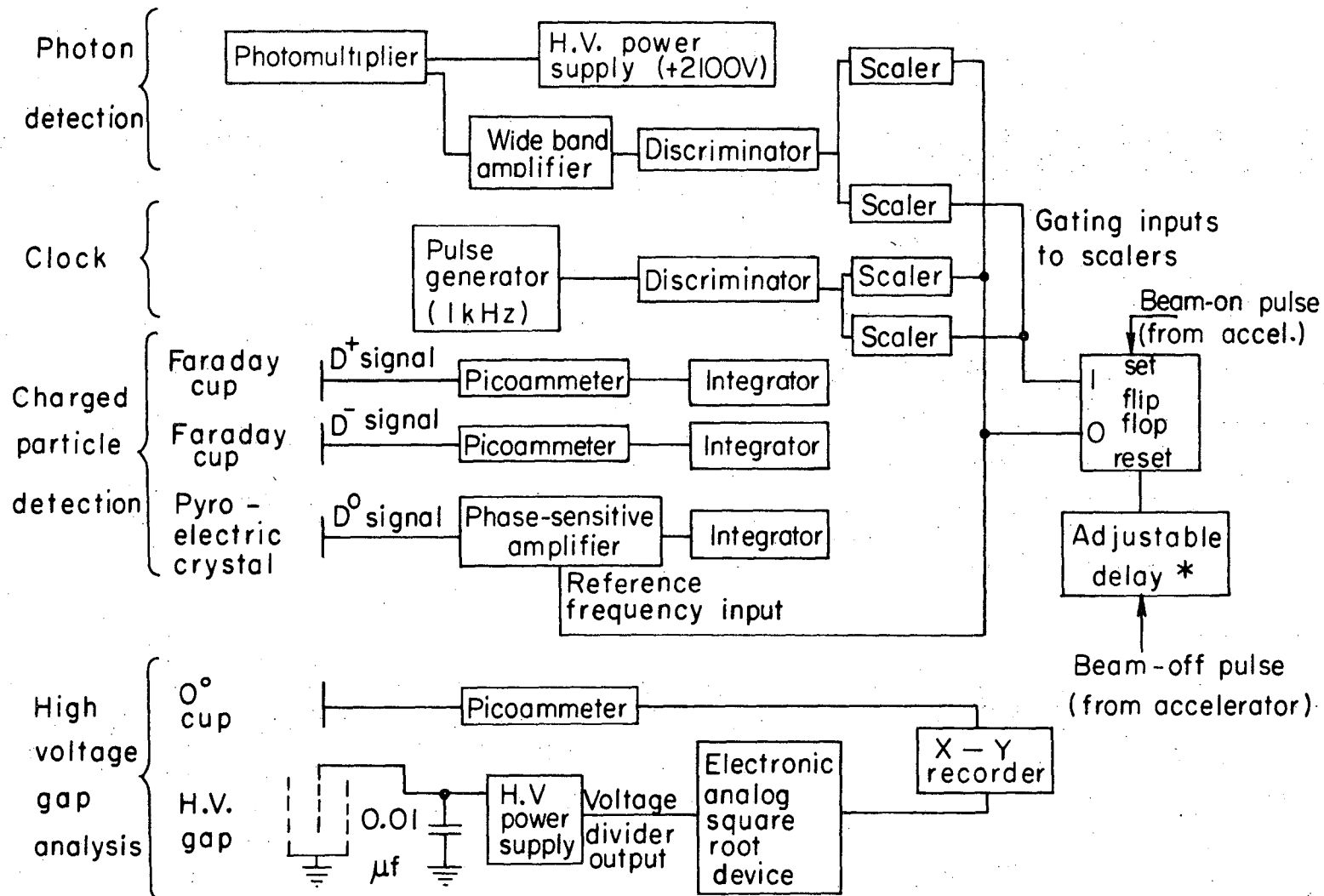

Fig. 1

XBL223 - 2510

000007000000



\*Delay adjusted until beam-gate covers entire beam-on period

XBL723 - 2511

Fig. 2

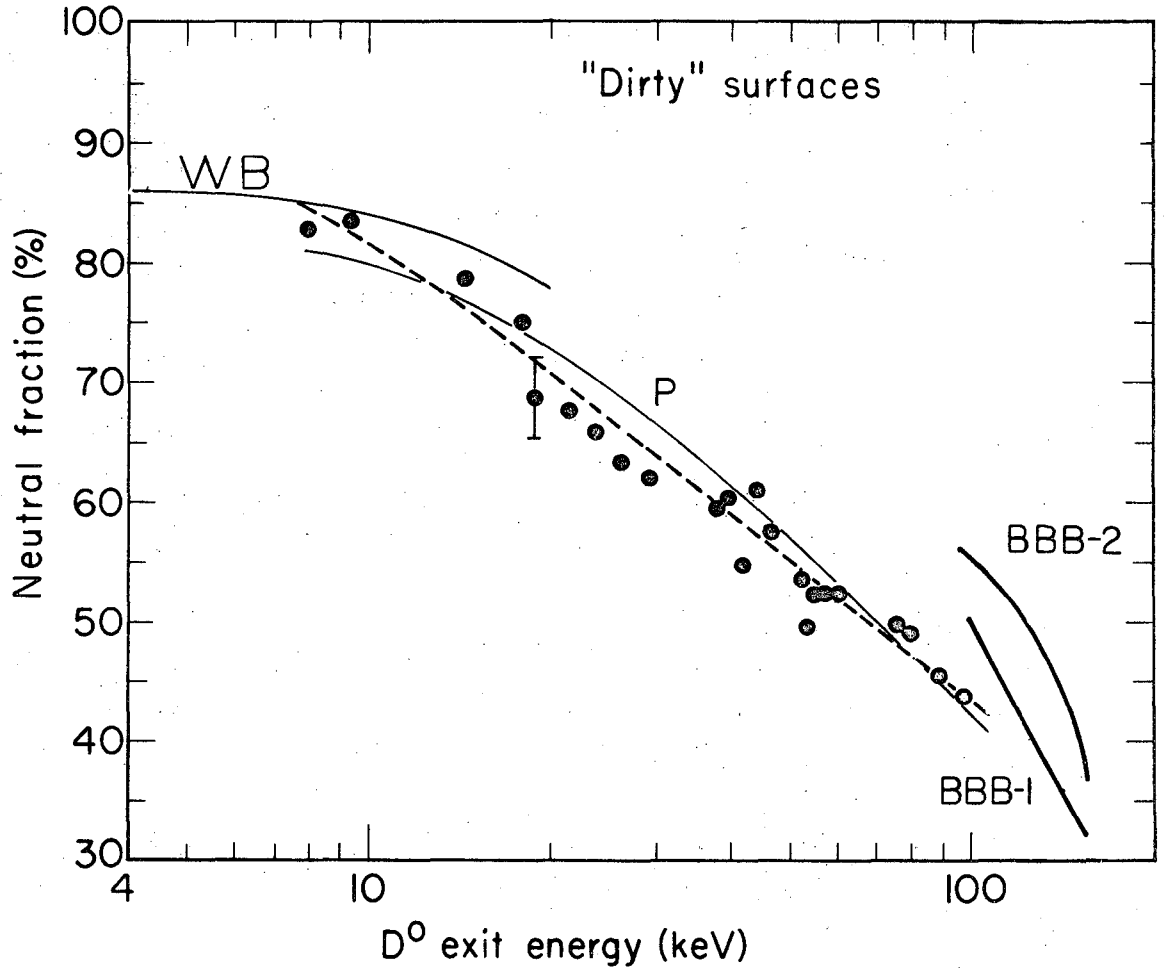

XBL723-2512

Fig. 3

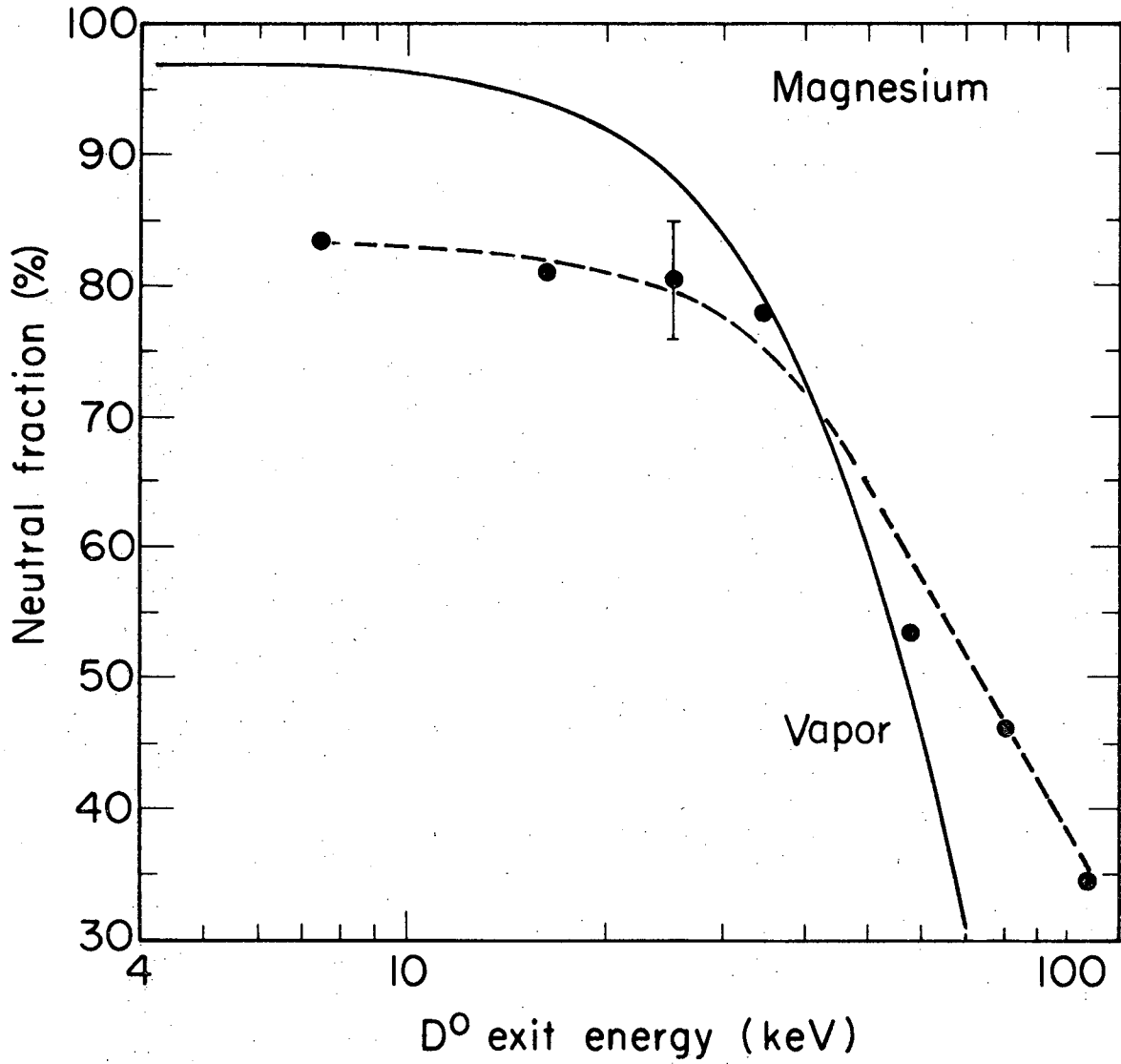

XBL723 - 2513

Fig. 4

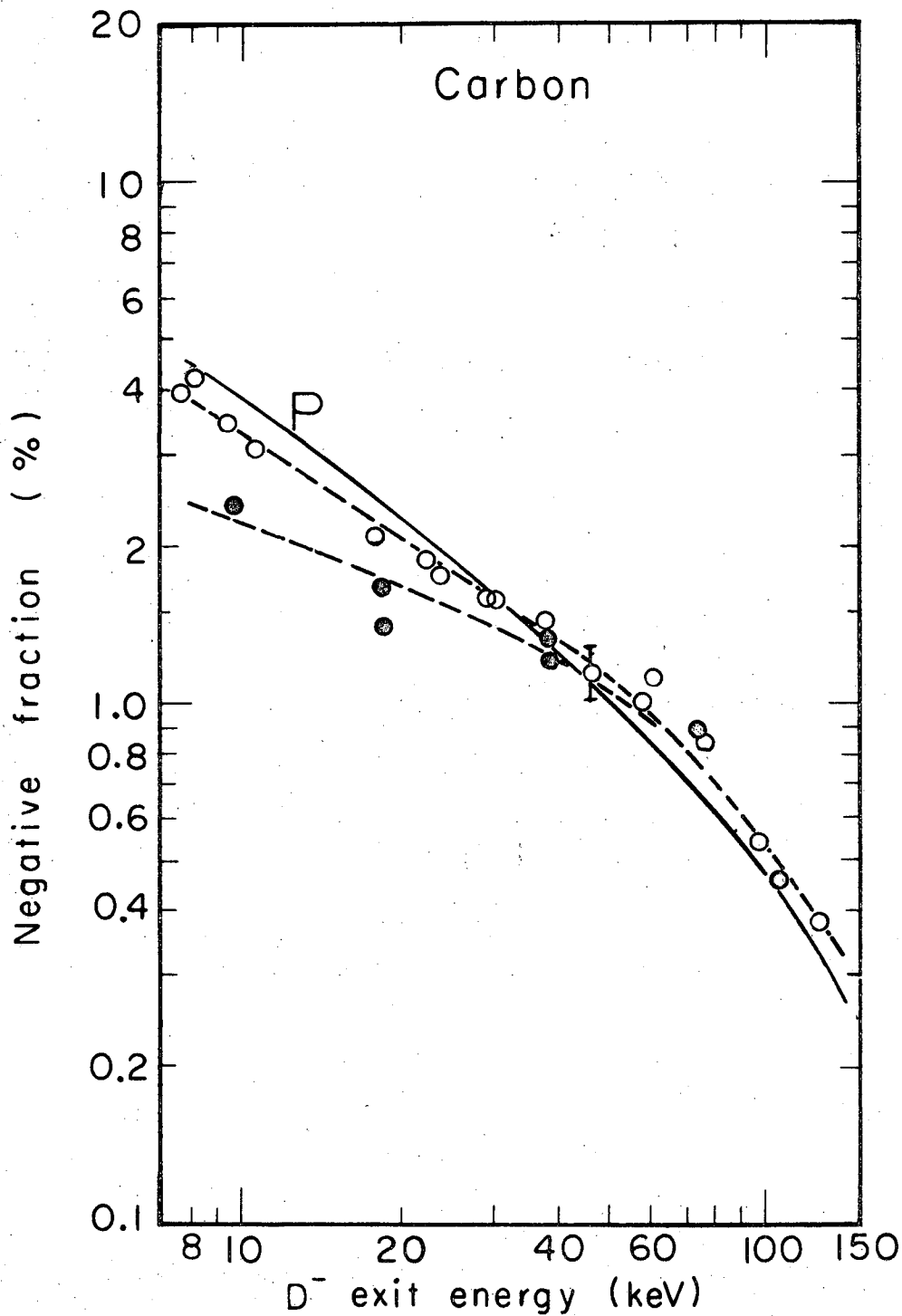

XBL723 - 2514

Fig. 5

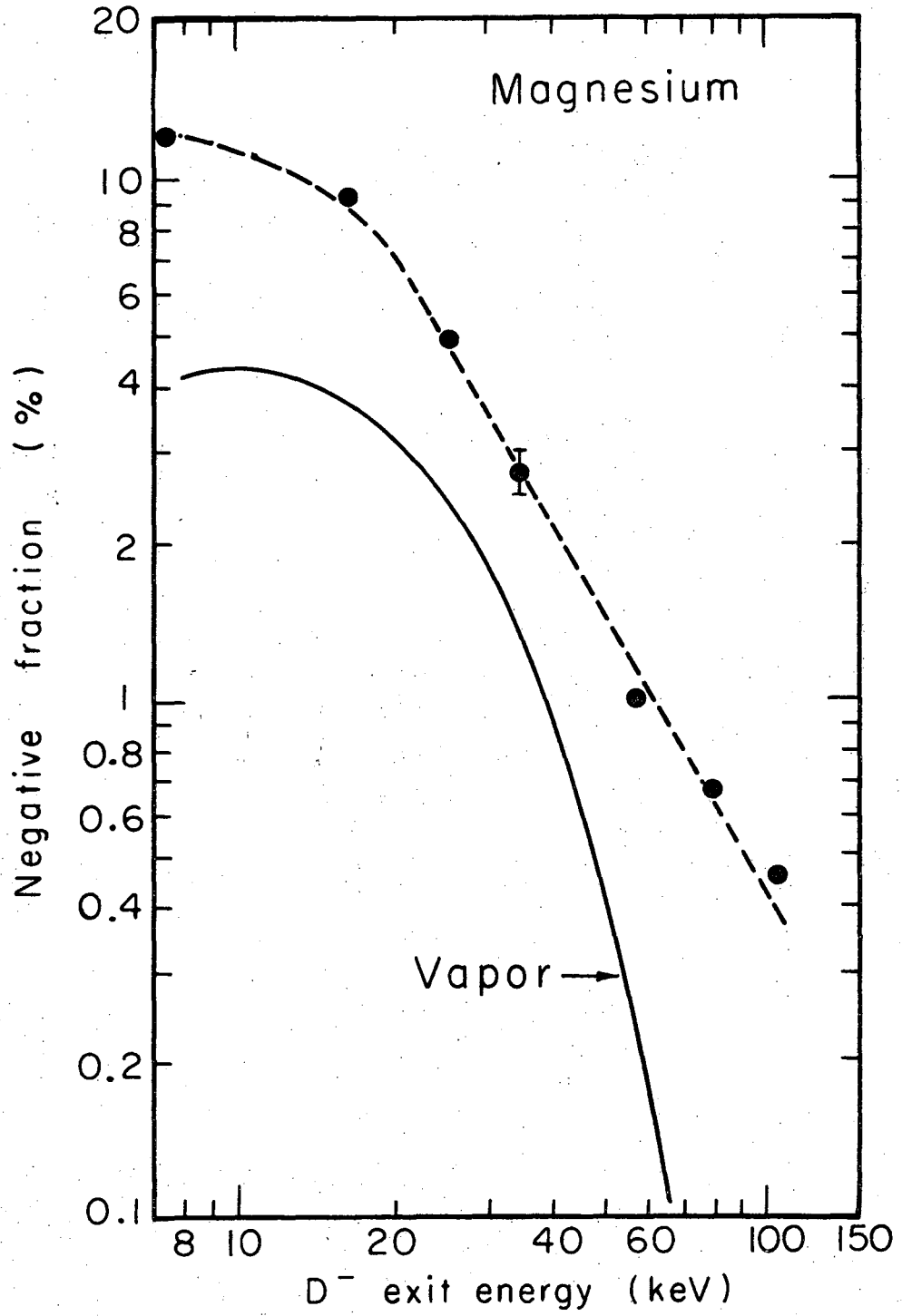

XBL723-2515

Fig. 6

00005703091

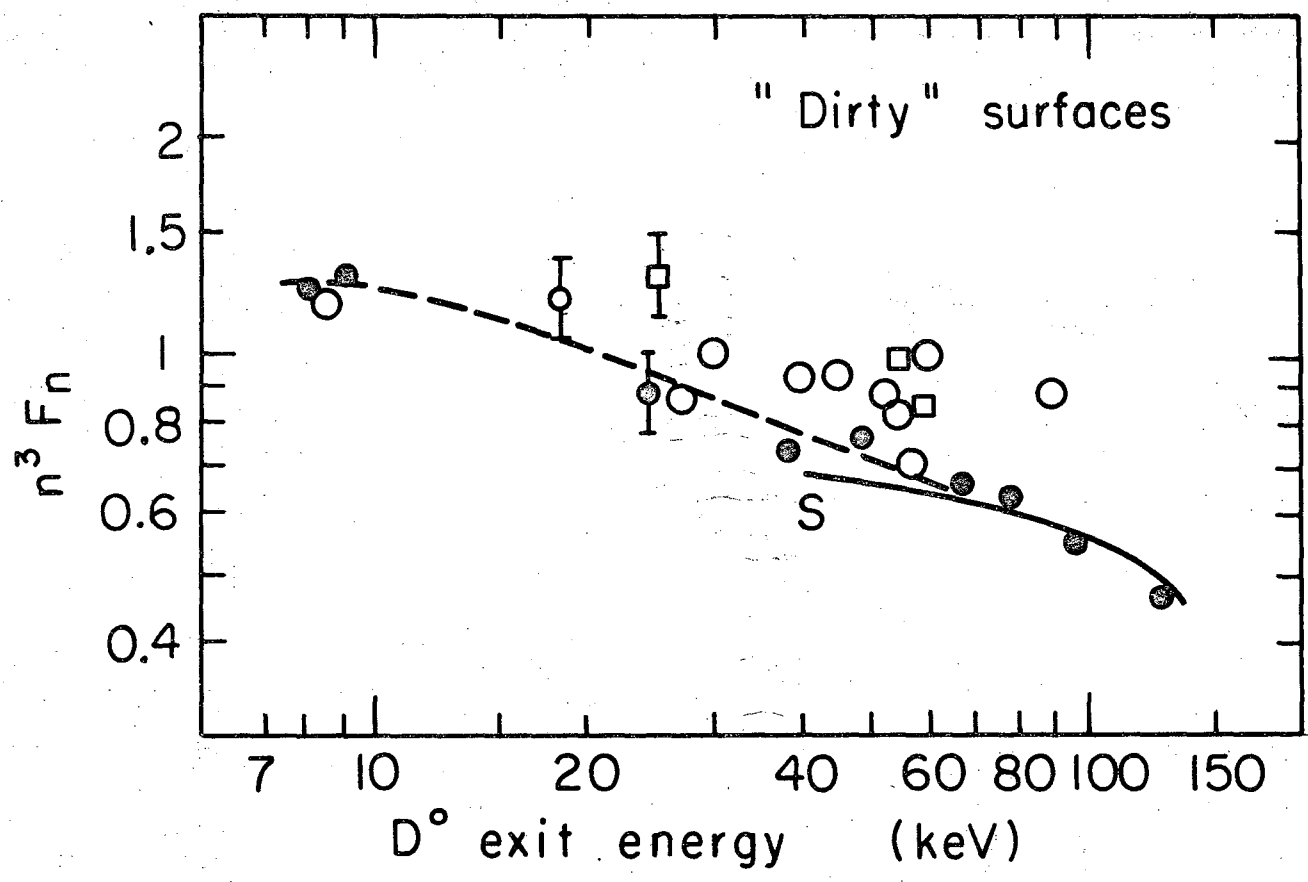

XBL723-2516

Fig. 7



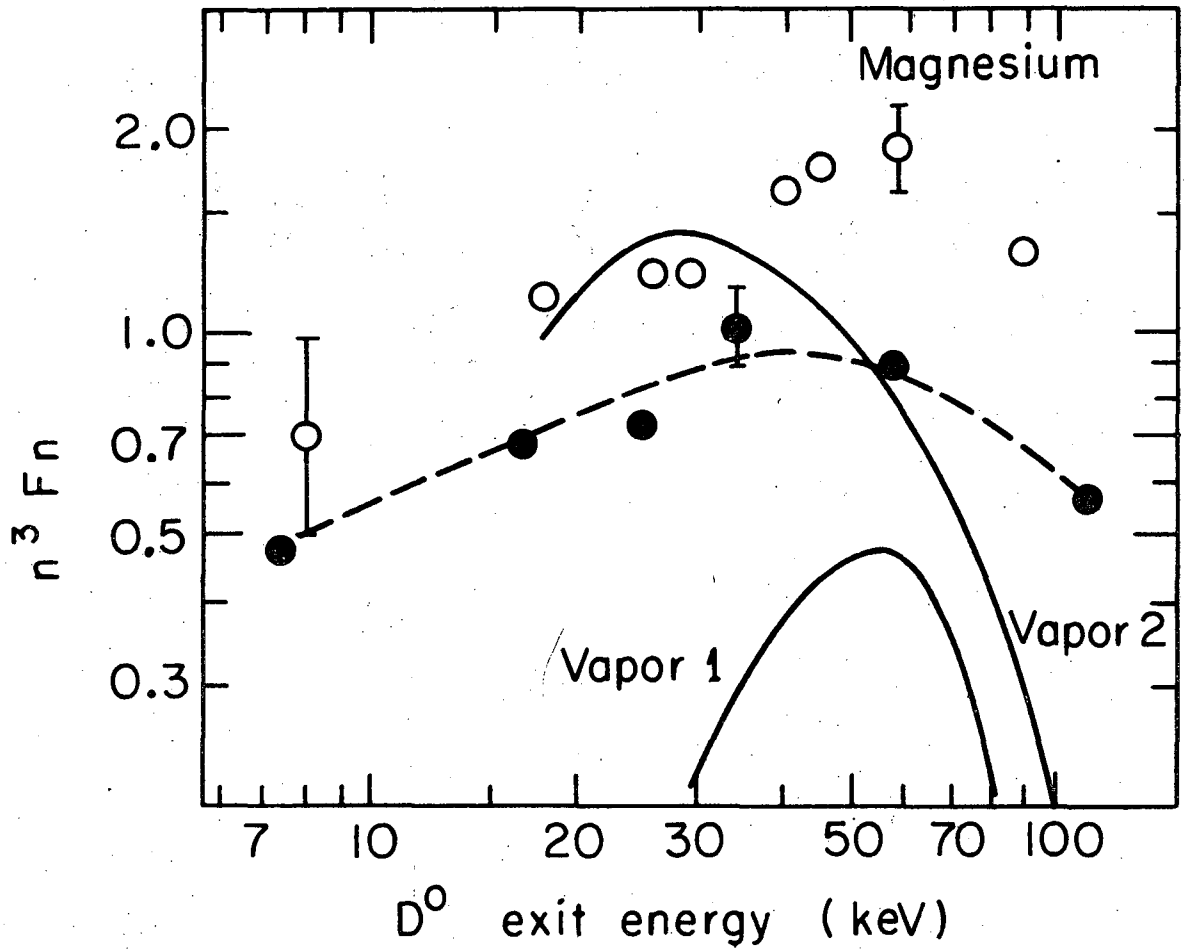

XBL723-2517

Fig. 8

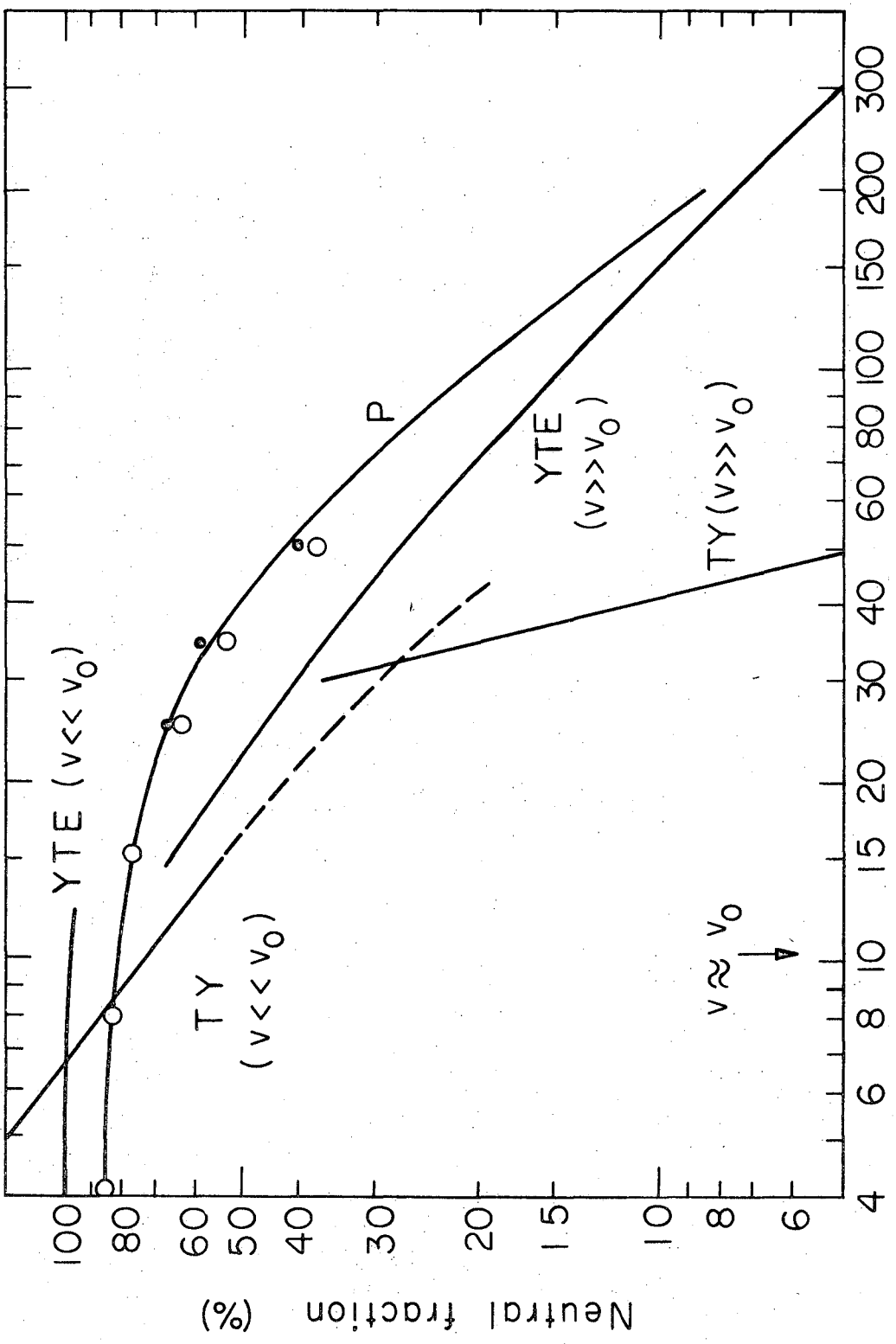

H energy (keV)

XBL 723-2518

Fig. 9

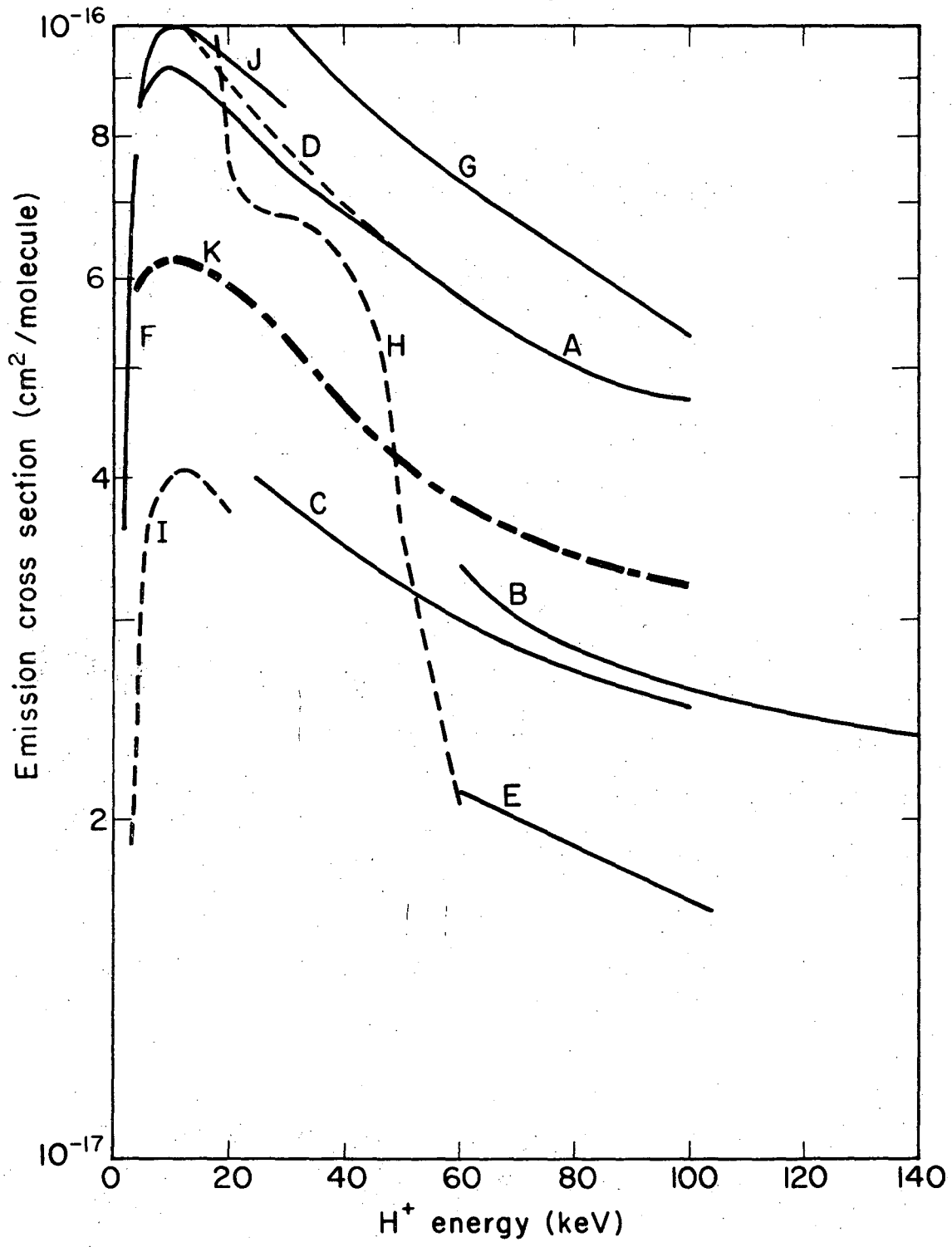

XBL 723 - 2519

Fig. 10

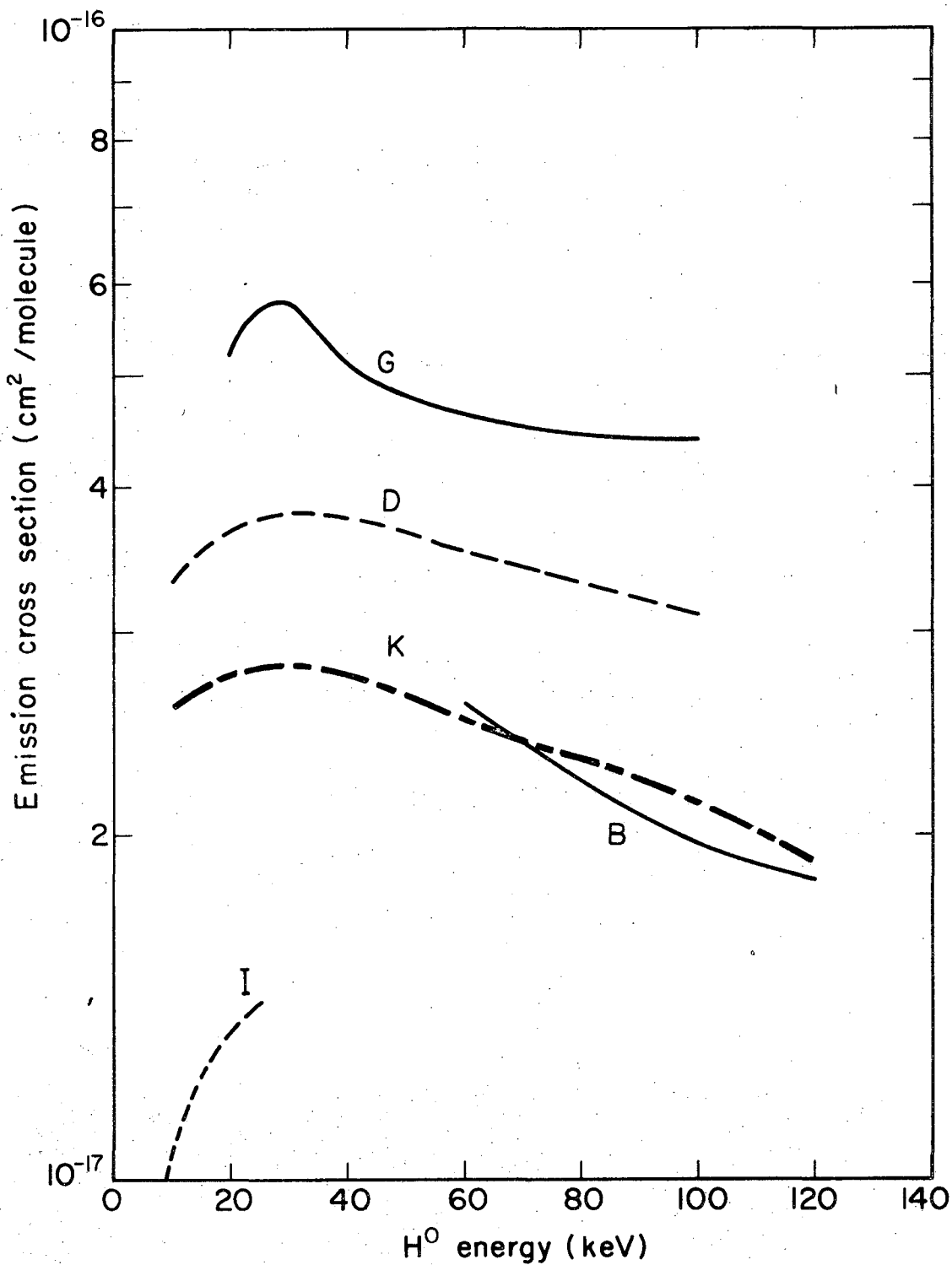

XBL723-2520

Fig. 11

LEGAL NOTICE

*This report was prepared as an account of work sponsored by the United States Government. Neither the United States nor the United States Atomic Energy Commission, nor any of their employees, nor any of their contractors, subcontractors, or their employees, makes any warranty, express or implied, or assumes any legal liability or responsibility for the accuracy, completeness or usefulness of any information, apparatus, product or process disclosed, or represents that its use would not infringe privately owned rights.*

TECHNICAL INFORMATION DIVISION  
LAWRENCE BERKELEY LABORATORY  
UNIVERSITY OF CALIFORNIA  
BERKELEY, CALIFORNIA 94720