

# UC Berkeley

## Research Reports

### Title

Augmented Speed Enforcement Project at UC Berkeley

### Permalink

<https://escholarship.org/uc/item/0526z6j5>

### Authors

Chan, Ching-Yao  
Gupta, Somak Datta  
Huang, Jihua  
et al.

### Publication Date

2013-10-01

1. Report No. <b>CA14-2146A</b>	2. Government Accession No.	3. Recipient's Catalog No.	
4. Title and Subtitle  Final Report for the California PATH augmented Speed Enforcement Project		5. Report Date  06-06-2013	
		6. Performing Organization Code	
7. Author(s)  Ching-Yao Chan, Somak Datta Gupta, Jihua Huang, David Nelson, Thang Lian		8. Performing Organization Report No.	
9. Performing Organization Name And Address  California Partners for Advanced Transportation Technology		10. Work Unit No. (TRAIS)	
		11. Contract or Grant No.  65A0356	
12. Sponsoring Agency Name and Address  California Department of Transportation Division of Research, Innovation and System Information P. O. Box 942873 Sacramento, CA 94273-0001		13. Type of Report and Period Covered  Final Report From 6/30/2010 to 06/30/2013	
		14. Sponsoring Agency Code	
15. Supplementary Notes			
16. Abstract  In this project, a speed alert and augmented enforcement system (aSE) was developed with a combination of sensing, image processing and recognition, wireless communication. The system includes a speed camera that captures speeding vehicles, and a changeable message sign that displays speeder's license plate number and measured speed, and a web page that allows police officers to monitor the incidence of violators traveling at excessive speeds. The aSE system was field tested for a work zone application on a rural highway. With data collected over multiple weeks, under a baseline scenario without the use of the aSE system and test cases with the system, it was shown that the system was effective in reducing the number of vehicles moving in excess of the speed limit.			
17. Key Words speed alert, speed enforcement, work zone, dedicated short range communication, wireless communication		18. Distribution Statement No restrictions. This document is available to the public through the National Technical Information Service, Springfield, VA 22161	
19. Security Classif. (of this report) <b>Unclassified</b>	20. Security Classif. (of this page) <b>none</b>	21. No. of Pages  <b>113</b>	22. Price  <b>N/A</b>

## **DISCLAIMER STATEMENT**

This document is disseminated in the interest of information exchange. The contents of this report reflect the views of the authors who are responsible for the facts and accuracy of the data presented herein. The contents do not necessarily reflect the official views or policies of the State of California or the Federal Highway Administration. This publication does not constitute a standard, specification or regulation. This report does not constitute an endorsement by the California Department of Transportation (Caltrans) of any product described herein.

For individuals with sensory disabilities, this document is available in braille, large print, audiocassette, or compact disk. To obtain a copy of this document in one of these alternate formats, please contact: the California Department of Transportation, Division of Research Innovation, and Systems Information, MS-83, P.O. Box 942873, Sacramento, CA 94273-0001.

# **Project Final Report**

## **Augmented Speed Enforcement Project at UC Berkeley**

California Partners for Advanced Transportation Technology Program (PATH)  
University of California at Berkeley

Ching-Yao Chan  
Somak Datta Gupta  
Jihua Huang  
Guan-Ling Chiu  
David Nelson  
Thang Lian

October 3, 2013

## Table of Contents

Table of Contents .....	4
Executive Summary.....	6
1. Introduction .....	8
2. PATH Augmented Speed Enforcement System.....	9
3. PATH aSE System Components and Sub-Systems.....	11
3.1 Speed Camera – Main Components and Sub-systems.....	11
3.1.1 License Plate Number Recognition (LPNR) Software.....	11
3.2 Changeable Message Sign .....	12
3.3 Wireless Communication Technology .....	12
3.3.1 Dedicated Short Range Communications (DSRC) .....	12
3.3.2 Cellular Communications .....	13
3.4 Web Server and Access by Browser from a Computer or Handheld Device.....	13
3.4.1 Portable devices .....	13
4. Field Tests and Data Collection in Los Banos, State Route 152 .....	17
4.1 Field Test Schedule and Scope .....	17
4.1.1 Work Zone Setup.....	17
4.1.2 Equipment Setup in the Field.....	19
4.1.3 Work Zone Setup and Practices .....	21
4.2 Data Collection and Analysis .....	23
4.2.1 Speed Distribution of Traffic Entering Work Zone, captured by Speed Camera	23
4.2.2 License Plate Number Recognition Results.....	24
4.2.3 Speed Data Measured by EVT-300 Radar at CMS Location .....	27
4.2.4 DSRC Communication .....	30
4.2.5 Cellular-Server Communication.....	33
4.2.6 iCone Data .....	36
5. Potential Enhancements for Future Design and Implementation.....	57
6. Concluding Remarks .....	58
Appendix A – Speed Distribution of Traffic Data, Measured by Speed Camera .....	60
Appendix B – Data Samples of License Plate Recognition.....	68

Appendix C – Speed Data Samples Measured by EVT-300 Radar .....79  
Appendix D – Data Samples of Cellular Transmission.....84  
Appendix E – DSRC Range Verification Testing Report .....96

## Executive Summary

This report describes an augmented Speed Enforcement (aSE) system that was developed, implemented and field tested by California Partners for Advanced Transportation Technology (PATH) of the University of California at Berkeley. The work was conducted under a project sponsored by USDOT with collaboration from California Department of Transportation (Caltrans), California Highway Patrol (CHP), and Western Transportation Institute (WTI) of Montana State University. The project was carried out with the goal of evaluating the effect of reducing traffic speed and minimizing hazards in a work zone in rural areas.

The main function of this aSE system is to communicate relevant speed, violation, and hazard information to the stakeholders in the work zone context: drivers, CHP officers, and workers. The system consists of two sub-systems, one provided by PATH and the other WTI. The two sub-systems can work jointly in an integrated manner as a whole but they can also be deployed and tested separately.

The PATH aSE system includes the integrated use of sensing, computing, and wireless communication technologies, including Dedicated Short Range Communication (DSRC) and cellular links. The PATH sub-system is intended for two main objectives:

- For the drivers, the system is aimed at providing an enhanced feedback, by capturing specific vehicle information. At the leading portion of a work zone, drivers of vehicles traveling above the speed limit are alerted in a timely manner by a changeable message sign. With the license plate number and measured speed displayed on a changeable message sign (CMS), the drivers are advised to reduce speed as they move through the work zone.
- For the CHP officers, the system is designed to provide alerts to their attention when there are vehicles traveling at excessive speeds. Information about vehicles traveling at excessive speeds is made accessible via a portable device by CHP officers who are stationed at the trailing section of the work zone and out of the sight of drivers. The system does not provide any automated functions of issuing citations but leave the enforcement duties in the hands of the officers, allowing the officers to perform the enforcement function, as deemed appropriate.

The PATH system was field tested in the summer of 2012. Over a period of 8 weeks, both WTI and PATH systems were deployed in conjunction with each other or separately to collect performance data. The field tests were carried out as Caltrans District 10 conducted field maintenance work on State Route 152. The work zone location rotated to different segments and spots along SR-152 on a day-to-day basis. Field testing and data collection spanned the months of May, June, and July of 2012. The four scenarios, baseline, PATH system only, WTI system only, and both systems, were tested for one week each and the cycle was repeated with a total of eight weeks of data collected.

Results from the field tests, as summarized in the data analysis section of this report, show that the system was indeed effective in reducing the number of speeding vehicles. Based on the iCones data that were placed throughout the work zone for the duration of the field tests, the percentage of vehicles traveling in excess of 65 mph was significantly reduced. For example, the summation of percentage of vehicles moving faster than 65-mph from all six iCones decreased from 60.23% in the baseline scenario to 54.13% in the scenario when the PATH aSE system was in place. This denotes a 10% reduction in vehicles travelling over 65mph in the work zone, relative to baseline conditions. Specifically, data at the 4<sup>th</sup> iCone, which captures

the most relevant effects of the PATH aSE system, shows a very significant 68% reduction in the percentage of vehicles travelling over 65mph. We also noticed an increase of approximately 6% in the percentage of vehicles travelling below 60mph at the 4<sup>th</sup> iCone. These reductions of higher speed vehicles and increase of lower speed vehicles are measured relative to the baseline condition. These results further highlight the effectiveness of the PATH aSE system.

The PATH system was demonstrated to operate according to design intents and specifications, even though it only represents a research prototype for initial field tests. The primary advantages that were observed for the current systems are as follows:

- All components and sub-systems are implemented with a concept of modular design to the fullest extent. This approach allows the replacement or substitution of elements whenever necessary. It also minimizes the potential drawback of components becoming obsolete or being limited to local operational constraints.
- All sub-components are acquired or procured to meet system requirements and state-of-the-art standards. They each, therefore, offer good performance.
- The system integration was significantly enhanced by technical support of component and sub-system providers. As a result, the PATH system could be fine-tuned and dynamically adjusted on site to meet various necessary adjustment requirements.
- The speed camera unit has a user-friendly touch-screen interface that enables the adjustments of speed thresholds and other operating parameters.
- The portable device tested in the field for CHP was an iPad, but it can be replaced with any other alternative device preferred by the stakeholders in actual deployment.

PATH also carried out additional field testing activities to support the utilization of Dedicated Short-Range Communication (DSRC) for the augmented speed enforcement (aSE) project. The main objective of this DSRC experiment is to identify the effective range up to which DSRC can support the requirements of the aSE project. Secondary objectives would be to verify the benefit and necessity of specialized antenna and cables in extending the range along with the utility of using a repeater. The tests were executed in a suburban and rural setting in the city of Petaluma, CA. The details of DSRC testing are provided in Appendix E.

In the point-to-point message transmission tests, no packets were lost at distances of 1.0 mile and 1.2 miles at transmit power of 23dB, the stated maximum of the DSRC radio unit. This testing in a suburban area proves the capability of our setup to work in harsher radio environment and still achieve a mile long range. During the testing in a rural setting, the transmitter and receiver were placed 1.1 miles apart and different transmit powers were tested. At this distance packets started getting dropped at 11dB transmit powers. And based on the results it is suggested that for the same setup at this distance a transmit power range of 17db-20dB is adequate, which would help to operate the radios with transmit powers comfortably below their stated maximum of 23dB. During the testing at Richmond Field Station we also proved a relay can be effectively used to transmit messages without any perceptible delay or loss of information.

In conclusion, the PATH aSE system developed and validated in this project have the potential to be deployed for a wide range of highway segments, either in rural or urban areas. At locations where speeding is a concern, the augmented speed enforcement can be used to provide timely and enhanced driver feedback, achieving the primary objective of reducing traffic speeds to avoid hazards. Significantly, enforcement duties remain in the hands of officers, and utilizing this system does not lead to legislative concerns in jurisdictions where automated functions are prohibited.



## 1. Introduction

With funding support from the Rural Safety Innovation Program (RSIP) of USDOT, the *augmented Speed Enforcement* (aSE) project is a joint effort between the California Department of Transportation (Caltrans), Western Transportation Institute at Montana State University (WTI), Partners for Advanced Transportation Technologies (PATH), and the Transportation Sustainability Research Center at the University of California, Berkeley (UCB). The California Highway Patrol (CHP) was a significant partner in this project.

The core research issue of this project was to investigate whether the deployment of an *augmented Speed Enforcement* (aSE) system could change driver behavior and reduce crash rates. This system differs from an *Automated Speed Enforcement* (ASE) system as the aSE system uses real time information about speed violators to support on-road enforcement actions by the California Highway Patrol (CHP). As a demonstrative case study in this project, the aSE system is developed and tested in an application for work zones in a rural setting.

The main function of this aSE system is to communicate relevant speed, violation, and hazard information to the stakeholders in the work zone context: the drivers, CHP officers, and workers. The system consists of two sub-systems, one provided by PATH and the other WTI. The two sub-systems can work jointly in an integrated manner as a whole but they can also be deployed and tested separately. This report is focused on the development and performance of the PATH sub-system while the description of the WTI system is given in a separate report.

The PATH sub-system is intended for two main objectives:

- For the drivers, the system is aimed at providing an enhanced feedback, by capturing specific vehicle information of vehicles traveling beyond the speed limit at the leading portion of a work zone. With the license plate number and measured speed displayed on a changeable message sign (CMS), the drivers are advised to reduce speed as they move through the work zone.
- For the CHP officers, the system is designed to provide alerts to their attention when there are vehicles traveling at excessive speeds. The officers may be positioned at the trailing end of a work zone, but they can receive and access the information about the violators. The system does not provide any automated functions of issuing citations but leave the evidence collection and enforcement duties in the hands of the officers.

Figure 1 depicts the primary components of the PATH sub-system, where it can be seen that the speed camera and CMS are located in the front portion of the work zone. The CHP officer is positioned at the tail end of the work zone, while he may also move to other locations within or outside of the work zone. The CHP officers receive alerts of speeding vehicles with an iPad that was used in the field test. The officer can decide whether or not to locate the vehicle and issue citations to the violators. The functional processes and the technologies involved will be explained in the next section.

The other separate sub-system is provided by WTI. Figure 2 shows an overall layout of the WTI sub-system. In the middle section of the work zone, a series of “smart cones” fitted with a light display (beacon) with a radar sensor that detect individual vehicle speed and synchronize the cone light display to “highlight” and follow any violating vehicle. This dynamic visual warning is intended to provide a visual warning to drivers violating the speed limit and to alert workers of a potential speeding hazard in the work zone. In addition, a local pager network was configured to automatically alert (vibration mode) those workers nearest the detected hazard.

Readers should refer to the separate report on the WTI system for further in-depth descriptions.

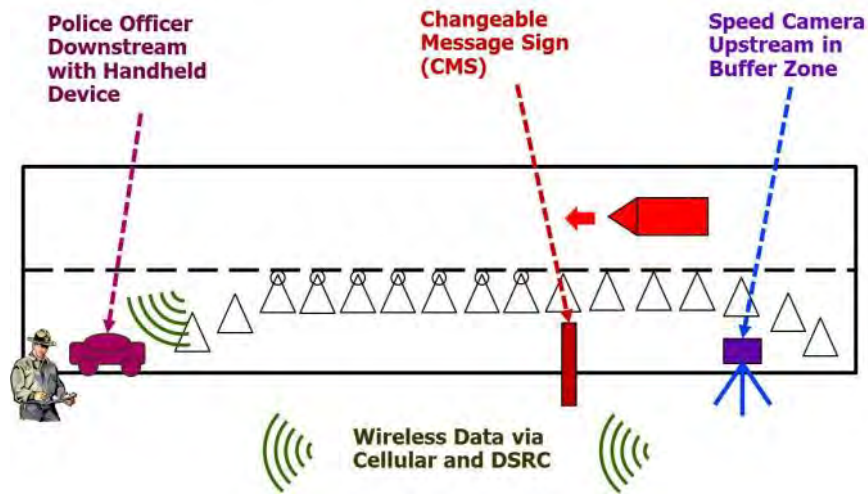


Figure 1. Augmented Speed Enforcement System – PATH Subsystem

## WTI Subsystem

Function: Portable work zone hazard detection system for driver and worker warning that can be integrated with existing work zone infrastructure.

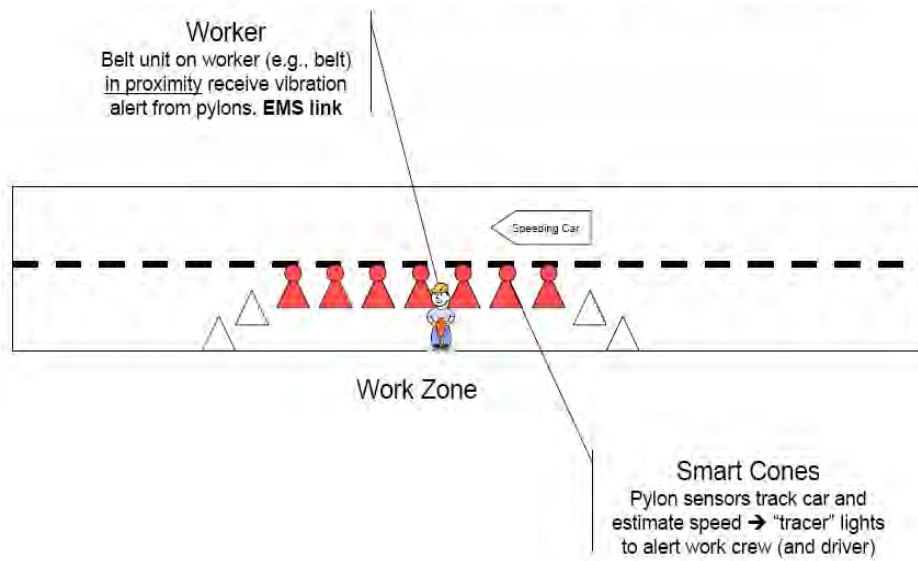


Figure 2. Augmented Speed Enforcement System – WTI Subsystem

## 2. PATH Augmented Speed Enforcement System

The sub-systems developed and implemented by California PATH includes (i) the speed camera, (ii) changeable message signs, (iii) portable device displays to CHP officers, (iv) associated wireless communication links through Dedicated Short-Range Communication (DSRC) and Cellular Network embedded in the subsystems, as well as (v) a data server located at PATH headquarters.

Referring to Figure 1, the above-described system performs its functions in the following

sequence:

- Speed camera system detects speeding target vehicles, captures photographs, and performs automatic license plate number recognition.
- The measured speed and license plate number are transmitted through a Dedicated Short Range Communication (DSRC) link and displayed on a downstream Changeable Message Sign (CMS), at a distance of 250-300 meters advising drivers to reduce speeds if they are over the speed threshold. Through this personalized message, drivers are encouraged to observe the lower speed limit as they pass through the work zone.
- The data, including speed, license plate numbers, and photographs, are also transmitted by a cellular connection to a back-end server and become accessible via any standard web browser by police officers stationed either at a downstream location, at a range of several hundred meters, or at a greater distance from the active work zone. The information is displayed to the officers on an iPad .
- The data are stored and archived at the local control computer within the speed camera system, as well as the back-end server. The back-end server allows remote monitoring and diagnosis of the operational status of the speed camera, and maintains archives of all captured and transmitted data.
- As implied by the functional sub-systems in (2) through (4) above, DSRC and cellular communication links are required to transmit specified data elements to CMS, police officers, and a central server.

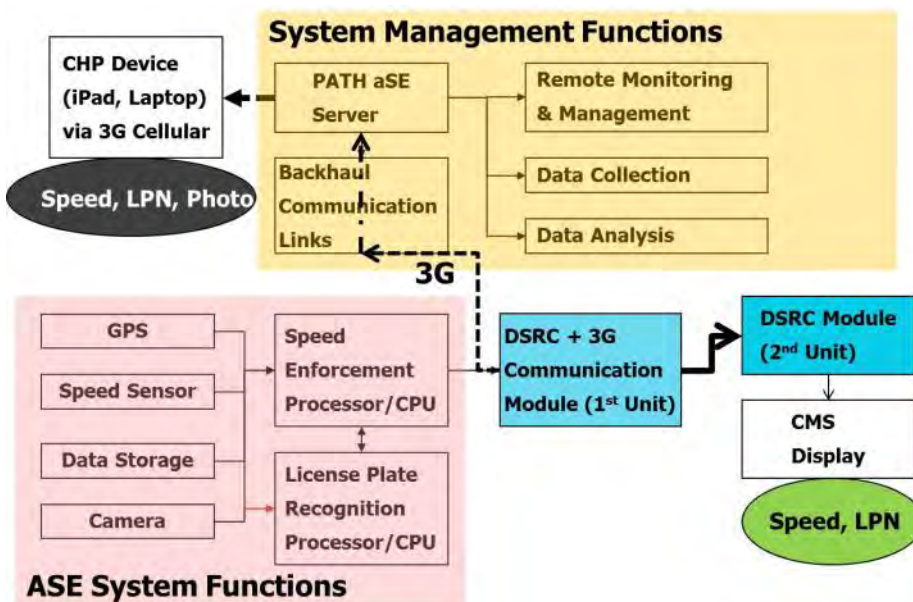


Figure 1. PATH Sub-system Functional Diagram

The overall system architecture for the developed aSE is depicted in Figure 3, with functional blocks identified. The lower left box contains a subsystem that resembles an Automated Speed Enforcement (ASE) camera system, which includes a speed sensor (radar), camera, and processor. Intentionally added to this project is a license plate recognition system that scans the photograph of the violator’s plates and outputs the plate number. The camera system is connected to a communication module (first unit), allowing data communication via Dedicated Short-Range Communication (DSRC) and cellular channels. The lower right box represents the Changeable Message Sign (CMS) with an associated DSRC communication module (second unit). The upper box contains the system management functions, implemented at a

back-end server where various data processing, system, and software management functions can be implemented. The upper left box designates a portable device with wireless connectivity to access the Internet and display violator information via a web browser to read violator information, including measured speed, license plate number, photograph, as well as time stamps of events.

### 3. PATH aSE System Components and Sub-Systems

This section provides a description of the system components adopted in the augmented speed enforcement project.

#### 3.1 Speed Camera – Main Components and Sub-systems

The speed camera system is placed within a protective weatherproof case. For this project, which is mainly intended for mobile setup, the unit is designed in a two-box configuration. During our field testing in Los Banos on SR-152, the unit was placed on a trailer to facilitate transporting the unit. See Figure 4 for the setup placement during these field tests. The location of the speed camera trailer is at the leading portion of the work zone where the lane-merging taper ends and the buffer zone begins.



**Figure 2. Placement of Speed Camera Trailer in Field Tests; At left, photo taken in traffic direction in front of the speed camera; At right, facing traffic behind the speed camera.**

##### 3.1.1 License Plate Number Recognition (LPNR) Software

The primary objective of our augmented speed enforcement system is to alert speeding drivers to slow down as they pass through the work zone area. One distinctive feature of our system is to provide personal enhanced feedback with the CMS displaying the speeding vehicle's license plate number. This design requires the speed camera unit to transmit real-time information of the detected violator to the CMS. This is accomplished by using automatic license plate number recognition software.<sup>1</sup>

The speed camera unit is embedded with LPNR (License Plate Number Recognition) software. LPNR is a widely used technology. The recognition needs to take place within a limited time frame to successfully transmit the information to a nearby CMS for timely display.

---

<sup>1</sup> [http://en.wikipedia.org/wiki/Automatic\\_number\\_plate\\_recognition](http://en.wikipedia.org/wiki/Automatic_number_plate_recognition)

## 3.2 Changeable Message Sign

The CMS was placed at a distance of approximately 250-300 meters downstream of the speed camera to provide enhanced feedback to the drivers. In a default mode, the CMS shows a message of “Work Zone Speed 55 MPH.” When a speeding vehicle was detected, the CMS displays a message of “License ABC123 XX MPH.” Examples of displayed messages are shown in Figure 5. The display was on the right was generated by one member of the field test team driving a rental vehicle to create a test case.



Figure 3. Display on Changeable Message Signs in Field Tests

The CMS is equipped with an Ethernet networking cable connection (RJ-45). This allows reception and transmission from the DSRC module into the CMS control unit. Only minor programming adjustments were made to accommodate the unit for the project. In the field test, the CMS trailer was fitted with a mounting fixture to house additional radar sensors to monitor the speeds of approaching vehicles. The collected radar data are discussed in Section 4.

## 3.3 Wireless Communication Technology

The system is implemented with two communication modules. One unit resides with the speed camera unit; a second unit is located on the CMS trailer and connected to the CMS controller. The first unit receives data from the speed camera and transmits the data through two different communication links: dedicated short range communication (DSRC) and cellular. The second unit receives data through the DSRC link and passes data to the CMS. To distinguish the two units, the first is called OBU (onboard unit) and the second is RSU (roadside unit).

### 3.3.1 Dedicated Short Range Communications (DSRC)

Dedicated Short Range Communications (DSRC) is a short-medium range wireless technology that supports time-critical road safety applications in roadside-to-vehicle and vehicle-to-vehicle communications. DSRC is also the key technology currently investigated by USDOT for research on Connected Vehicles<sup>2</sup> with a variety of Vehicle-to-Vehicle (V2V) and Vehicle-to-Infrastructure (V2I) applications. More in-depth descriptions of DSRC can be referenced from FCC.<sup>3</sup> Generally speaking, DSRC can achieve a high-speed data rate of up to 27 Mbps and 1,000 meters of transmission range. It needs only 20 milliseconds to complete transmission. To achieve timely displays on the CMS, we chose DSRC, the most appropriate and promising technology available to transmits vehicle speeds and license plate numbers from

<sup>2</sup> [http://www.its.dot.gov/connected\\_vehicle/connected\\_vehicle.htm](http://www.its.dot.gov/connected_vehicle/connected_vehicle.htm), accessed July 2013.

<sup>3</sup> [http://fjallfoss.fcc.gov/edocs\\_public/attachmatch/FCC-03-324A1.pdf](http://fjallfoss.fcc.gov/edocs_public/attachmatch/FCC-03-324A1.pdf), accessed July 2013.

the speed camera unit of the CMS.

### 3.3.2 Cellular Communications

For a cellular communication link successful to a range of several hundred meters, several kilometers, or even greater distances, the increasingly popular 3G/4G cellular communication technology, called High Speed Downlink Packet Access (HSDPA), is preferred because of its almost ubiquitous presence and because it has the capability to cover long distances. In our implementation, a cellular communication module is integrated within the first communication unit attached to the speed camera as the data transceiver.

For data transmission to the back-end server, the same cellular communication link is used. Field data is transmitted through the cellular backhaul link and archived for data analysis and management purposes. The back-office application was housed at a system server located at California PATH for the duration of this project.

## 3.4 Web Server and Access by Browser from a Computer or Handheld Device

We used an Ubuntu 11.10 (Oneiric) as the server, and Apache as our web server, chosen for its versatility and robustness. The programming software was C, Shell Scrip, PHP, Ajax and JavaScript. The deliberate use of reliable open source products ensured reduced costs, coupled with high code quality. The server is implemented with a number of software codes to enable and prepare received data for archiving purposes, as well as web access. The time, measured speed, and photographs of the speeding vehicles can be displayed on a web page. This web access feature allows CHP officers to monitor violators traveling at excessive speeds.

Fig. 6 shows the various stages of events on the web page. The first image shows the web page when it is accessed; the second shows what happens immediately following a new event. The event is shown in red immediately within a window of the first 180 seconds. The third image, shown in amber, is displayed in the period of 180-360 seconds after the event is recorded. The last image, depicted in yellow, indicates the event occurrence has happened between 300 to 600 seconds, beyond which it returns to the normal (uncolored) stage. Any new event occurring in between should take precedence, as only the latest event is highlighted. Also, the small thumbnail photos can be clicked on to view the higher resolution photo as shown in Fig. 7.

### 3.4.1 Portable devices

During the project's design phase, a conscious decision was made to avoid developing data display applications for each of the possible device that may be used by end users. Instead we chose to present our data via the Internet. Smartphone and tablets can then simply use their web browser to display the data. That means that either an Apple device, an Android-based device, or a Windows-based device can be used to view our aSE data. All that is needed is a URL, which can be implemented with authorization protection. This allowed us to make our data available via a variety of devices without having to develop specific applications for each class. This suited our aSE field test needs perfectly.

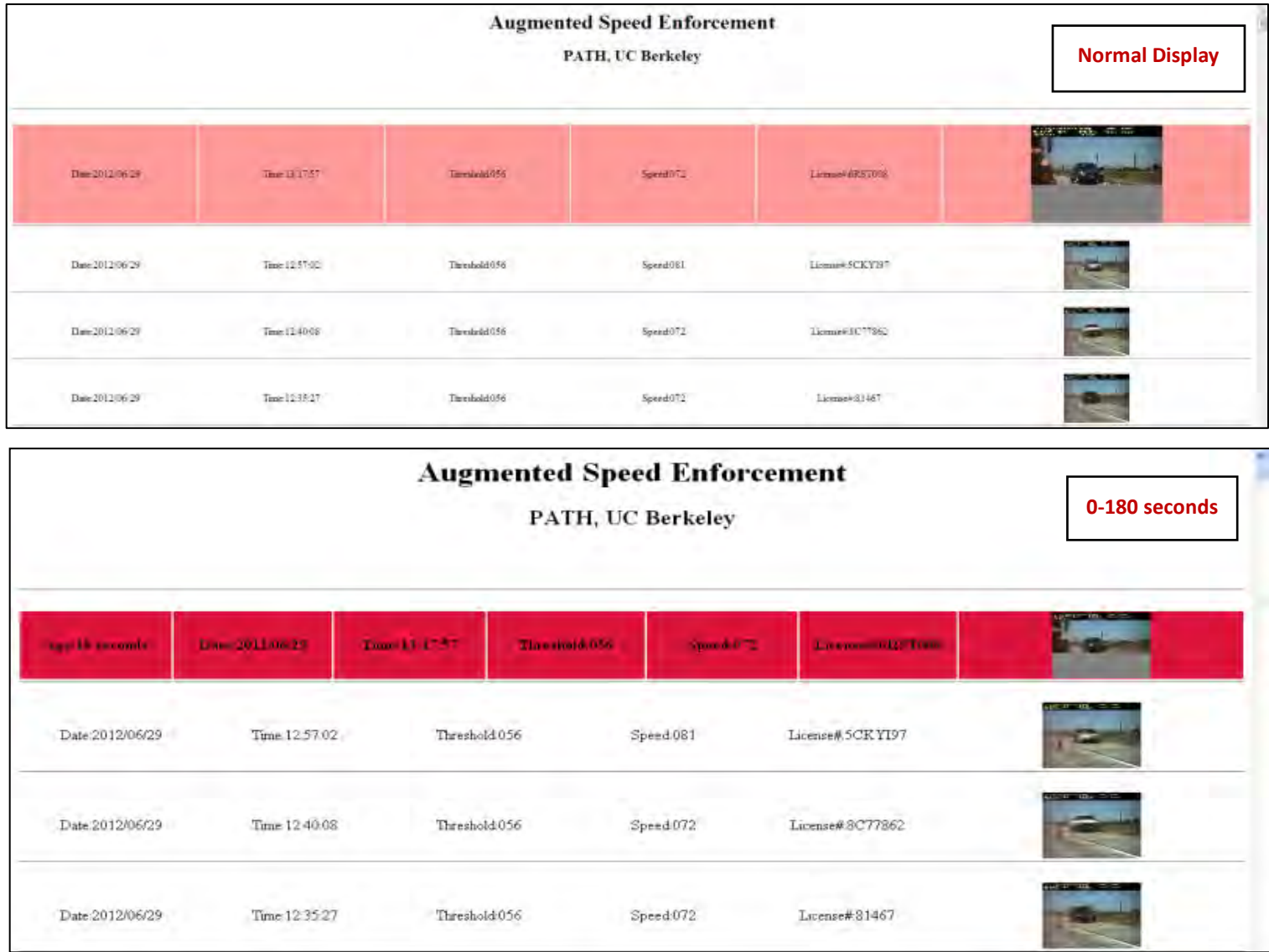






Figure 6a. Different stages of the aSE speed violator web page

### Augmented Speed Enforcement PATH, UC Berkeley

Age: 187 seconds	Date: 2012/06/29	Time: 13:17:57	Threshold: 056	Speed: 072	License#: 6RST008	
Date: 2012/06/29	Time: 12:57:02	Threshold: 056	Speed: 081	License#: 5CK Y197		
Date: 2012/06/29	Time: 12:40:08	Threshold: 056	Speed: 072	License#: 8C77862		
Date: 2012/06/29	Time: 12:35:27	Threshold: 056	Speed: 072	License#: 81467		

### Augmented Speed Enforcement PATH, UC Berkeley

300 -600 seconds





Age: 405 seconds	Date: 2012/06/29	Time: 13:17:57	Threshold: 056	Speed: 072	License#: 6RST008	
Date: 2012/06/29	Time: 12:57:02	Threshold: 056	Speed: 081	License#: 5CK Y197		
Date: 2012/06/29	Time: 12:40:08	Threshold: 056	Speed: 072	License#: 8C77862		
Date: 2012/06/29	Time: 12:35:27	Threshold: 056	Speed: 072	License#: 81467		

Figure 4b. Different stages of the aSE speed violator web page







Date:2012/06/28	Time:10:06:45	Threshold:056	Speed:072	Redacted	
Date:2012/06/28	Time:10:04:02	Threshold:056	Speed:077	License#:1290469	
Date:2012/06/28	Time:10:00:41	Threshold:056	Speed:077	License#:1290469	
Date:2012/06/28	Time:09:49:32	Threshold:056	Speed:071	Redacted	



Figure 5. The thumbnail photos can be clicked on to view the higher resolution photo

## 4. Field Tests and Data Collection in Los Banos, State Route 152

The PATH system was field tested in the summer of 2012. Over a period of 8 weeks, both WTI and PATH systems were deployed in conjunction with each other or separately to collect performance data. The field tests were carried out as Caltrans District 10 conducted field maintenance work on State Route 152. The work zone location rotated to different segments and spots along SR-152 on a day-to-day basis.

### 4.1 Field Test Schedule and Scope

Field testing and data collection spanned the months of May, June, and July of 2012. Testing weeks were broken down into baseline data collection, WTI drums/warning lights/pager system, PATH radar/camera/CMS system, and a combination of WTI and PATH systems. WTI and PATH each carried out four weeks of field tests, including individual and joint deployment. The table below lists the schedule and tasks the PATH team carried out on site.

**Table 1. Field Test Schedule and Types of System Setup**

Dates	System Setup	California PATH Tasks
May 11-12, 2012	<b>Mandatory Safety Training and Demo</b>	PATH Team Participation
May 13, 2012	<b>Pre-Field Test Preparation</b>	Move equipment to Los Banos
May 14-18	<b>WTI only</b>	Support WTI setup and deployment of iCones
May 21-24	<b>WTI &amp; PATH</b>	Responsible for PATH system setup, and Support deployment of iCones and WTI setup
May 29-June 1	<b>PATH only</b>	Responsible for PATH system setup, and Deployment of iCones
June 4-8	<b>Baseline only, Data Evaluation</b>	Responsible for iCones setup
June 11-15	<b>WTI Only</b>	Support WTI setup and deployment of iCones
June 18-22	<b>WTI &amp; PATH</b>	Responsible for PATH system setup, and Support deployment of iCones and WTI setup
June 25-29	<b>PATH Only</b>	Responsible for PATH system setup, and Deployment of iCones
July 9-13	<b>Baseline only, Data Evaluation</b>	Responsible for iCones setup

#### 4.1.1 Work Zone Setup

The diagram below (courtesy of Randy Woolley, Caltrans) provides an overall view of the work zone layout and WTI and PATH sub-system locations.

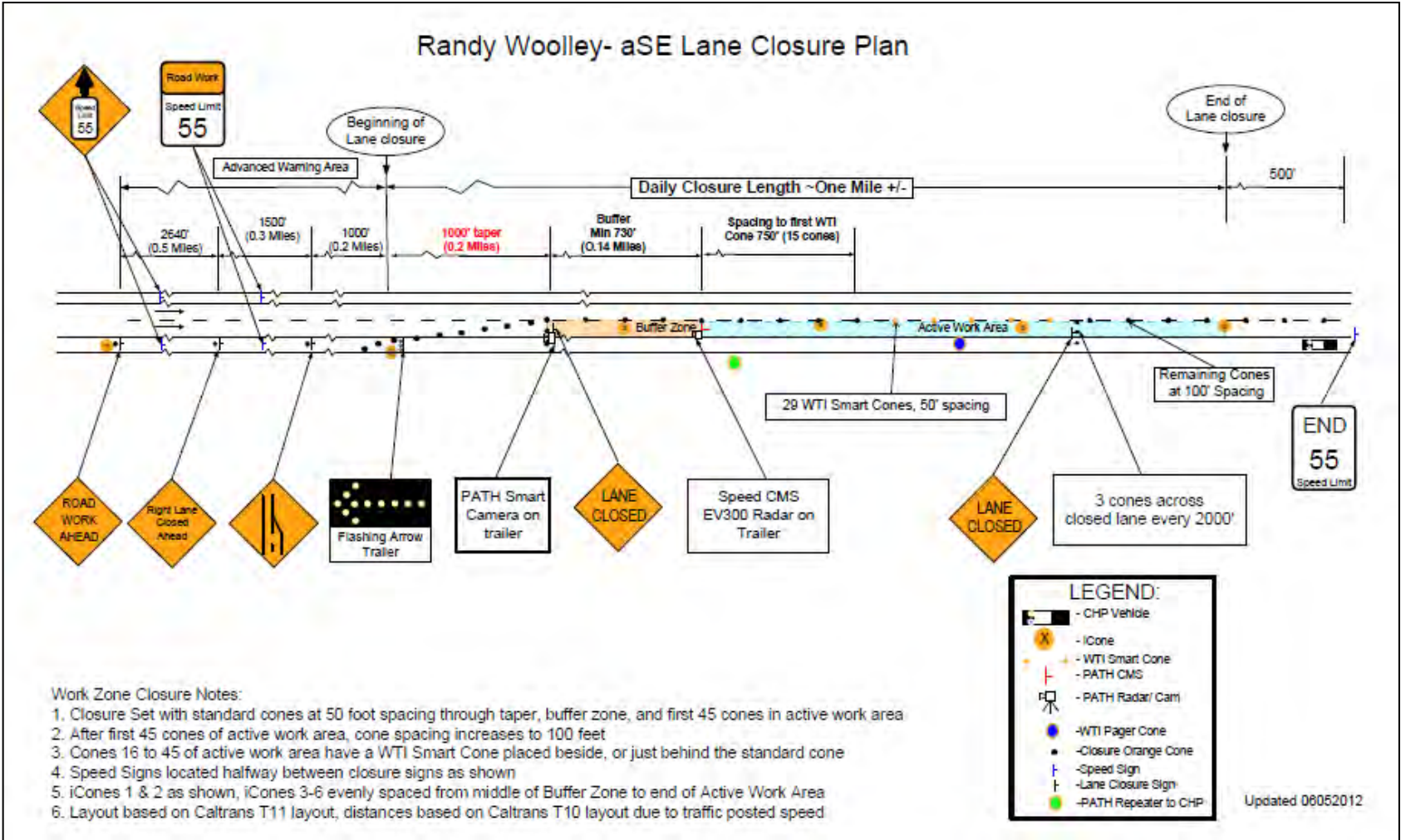


Figure 6. Work Zone Layout in Los Banos on State Route 152

Originally, the PATH speed camera was to be placed at the taper section of the leading part of the work zone, and the CMS at the beginning of the buffer zone. As per the suggestion of the CHP officer on site prior to the field tests, for safety considerations the speed camera was moved to the beginning of the buffer zone and the CMS to the end of the buffer zone as illustrated by Fig.8.

The test site was on a section of State Route 152 east of the town of Los Banos. The actual work zone was set up on a day-to-day basis. The work zone, including the leading taper and buffer zones, stretched for approximately one mile. All equipment was replaced once on site and removed at the end of the day for safe transport back to the Caltrans Los Banos yard.

#### 4.1.2 Equipment Setup in the Field



Figure 7. Placement of Speed Camera

As shown in Fig. 9, the PATH camera/license recognition trailer was placed at the terminus of the taper zone, just behind the lane closed warning sign. The speed camera system tested by PATH was flexibly designed to be either a fixed roadside unit or a mobile unit. The system is composed of two enclosure boxes with the camera/ radar equipment located in the upper steel enclosure and the battery/power connections in the lower stackable enclosure. For quick and safe deployment, the two enclosures can be separated and mounted on a small trailer more easily handled in the field. For this setup, the speed camera was situated at a height of 3-4 feet from the ground were maintained. Leveling legs were installed on the trailer to allow for quick leveling/deployment on a variety of road grades. The trailer suspension was a bit of a rough ride for some of the equipment, most notably during the off road driving necessary to get behind the lane closure. All sensitive calibrated equipment was removed from the trailer and transported in a protective case in the tow vehicle.

A changeable message sign (CMS) was located downstream from the camera in the buffer zone, as shown in Fig.10. The CMS trailer solar panel and batteries provided power for the EVT 300 radar units and data collection computers, as well as the DSRC and Wi-Fi equipment placed on the CMS trailer. An enclosure was installed on the CMS trailer to protect the equipment and

cabling during transport, and in the field. An antenna mast was added for the DSRC radios to enhance communications. Again, the more sensitive equipment was removed from the trailer for transit to and from the Caltrans maintenance yard and test site. EVT 300 radar antenna mounts were installed on both sides of the CMS trailer to allow for deployment on either side of the roadway. Data from the EVT radars was collected on laptops, which required power inverters. The radar data are discussed in detail in Sec. 4.2.3



**Figure 8. Placement of CMS**



**Figure 9. Setup of WTI Drums**

The WTI cones (drums), shown in Fig. 11, with active warning lights were placed downstream beyond the CMS trailer at a distance of 750 feet (or 225 meters) to ensure that the EVT 300 radars on the CMS trailer did not interfere with the WTI cone radar units. The iCone safety drums were deployed throughout the testing period to collect traffic speed data. iCones are

shaped as a bright orange traffic safety drum. They are equipped with backhaul communication links to upload the data when the devices are in operation and the communication links are available. As shown in the layout diagram, the first two iCones were placed by the Caltrans maintenance crew upstream of the taper and buffer zones during the lane closure setup. The remaining four iCones were placed downstream in the lane closure, spaced to ensure that the radar units in the different systems would not interfere with each other. Data was collected throughout the lane closure. Fig. 12 shows one of the iCones placed in the closed lane 4-6 feet from the active traffic lane. The iCone has a marker indicating the radar direction, which is placed at an angle of 10-30 degrees to the line of traffic. The iCones were used to capture speed data averaged using a two minute window and it also separately captured and reported high speed events. The iCone is not suitable for tracking individual vehicles.



**Figure 10. Placement of iCones**

#### **4.1.3 Work Zone Setup and Practices**

Prior to any field testing setup, all members of the research team of field participants were required to undergo safety training by the Caltrans Division of Maintenance, as per Caltrans Maintenance Manual Chapter 8, Protection of Workers. The training spelled out the rules and requirements for safe operation within a lane closure. This dictated how the setup and take down of equipment would be accomplished.

A full safety briefing was conducted by Caltrans at the Los Banos Maintenance with both research teams and CHP present. The focus was on procedures that are intended to keep the researchers, workers and the traveling public safe. All in attendance were required to sign a roster acknowledging that they participated. During the first safety briefing, at the recommendation of CHP, the location of the PATH camera trailer and CMS were moved so that the camera was located beyond and outside of the taper, and the CMS was moved an equivalent distance downstream to the end of the buffer.

Daily operations were carried out based on these safe practices and fine-tuned with cooperation from the Caltrans crew at the site. Data collection days started with a tailgate safety meeting at the yard in the morning to review the day's plan. The previous day's work was reviewed, safety

rules reiterated, the testing setup for that day confirmed, group leaders assigned, and radio sets handed out.

The Caltrans maintenance crew departed first with two iCone drums and their usual closure signs and cones. The testing for this project required a speed reduction down to 55 mph for the work zone. Speed reductions were not normally carried out along this stretch of rural roadway; if they were, extra signage had to be deployed. Once the closure cones and signage were in place, the crew made radio contact to confirm readiness for the equipment to be setup. The WTI truck would lead the group, followed by the CMS trailer and then the camera trailer. The remaining four iCones were in the pickup truck that towed the CMS sign.

Once all trucks/trailers were safely behind the closure and off the road, the PATH speed camera and CMS teams would begin reinstalling equipment on their trailers on the roadway shoulder, and not in the closed lane, while the shadow truck followed the WTI truck setting up the WTI drums. The WTI setup required three to four people. One driver with radio to communicate with the back of the truck, one to two people in the truck to remove/replace the drums, some of which were stacked on shelves 4-4.5 feet high, and one person to drop off/pick up the drums from the highway. The WTI drums have smaller lead acid batteries than those used in the iCones. They required rubber rings fabricated from old steel-belted truck tires be placed over the drums to prevent movement by high winds or blasts of air as big rigs passed in the open lane of traffic.



**Figure 11. Equipment Setup with Assistance of Caltrans Shadow Truck**

Once the shadow truck completed the WTI installation, the WTI truck would depart and the shadow truck would return to the taper, getting into position in front of the camera trailer location. The camera trailer, which was setup and switched on by that time, would be wheeled out by two to three people, where it would be aligned, leveled, and communications tested. A look out person was required at this stage, hence the third person. Once accomplished, the shadow truck would move to protect the CMS trailer, which was towed into position and dropped off. See Fig. 13 for a photograph taken at the site. Equipment had been reinstalled and made operational on the CMS trailer on the shoulder prior to the arrival of the shadow truck, in order to make the deployment process as safe and efficient as possible.

After the pickup truck was detached from the CMS trailer, it and the shadow truck would proceed down the closure to place the remaining four iCones for that day's data collection. Two people were needed to safely remove/replace the iCone drums from the back of the pickup.

The removal of the test equipment was a bit different from the setup. The takedown was accomplished starting at the end of the closure with the shadow truck backing up to protect research workers, as the pickup backed up, followed by the WTI truck driving forward against traffic in the closed lane. The group traveled slowly up the closure as the WTI team retrieved their drums; iCones were placed in the back of the pickup along the way. Once all WTI and iCones were removed from the closure, the shadow truck would setup in front of the CMS trailer and the pickup would back in, hook up to the CMS trailer, and move it off the road. This allowed the shadow truck to move in front of the camera/radar trailer, at which time workers moved the camera trailer off the road to safely remove sensitive equipment and hook up to the tow van.

With all trailers safely off the road the Caltrans maintenance crew could begin picking up the remaining closure cones and signs, as a standard operation. There were some adjustments to the placement and procedure as the lane closure moved down the road a greater distance from the Los Banos Caltrans yard. The Caltrans crew would contact the research team prior to having the lane closure complete to allow for greater travel time to that day's site.

Site-specific geography required that some adjustments be made positioning equipment as private driveways, service and access roads, and irrigation canals needed to be accounted for in the setup of equipment. Local environmental conditions also played a role. High winds and heat took a toll on both people and machines, alike. On certain days the Caltrans crew was kept busy righting cones and signs that had blown over. Several signs and stands needed to be repaired after one very windy day and the Caltrans crew commented that not being able to see approaching traffic, as you can with a mesh sign, made setup/take down more challenging and hazardous.

## **4.2 Data Collection and Analysis**

Several different types of data were collected for evaluation during the field tests:

- (1) The measured speed of passing vehicles was detected by the speed sensor at the speed camera unit; the data were aggregated into a daily inventory of speed distribution.
- (2) The recognized license plate numbers and associated photographs of speeding vehicles were archived and have been evaluated for accuracy.
- (3) The vehicle speed was measured by a radar sensor installed at the CMS location, which tracked the vehicles as they approach the CMS.
- (4) The data transmission between communication modules and backend server were logged to estimate transmission time lags.
- (5) The average speed of traffic at several locations along the work zone was measured by the iCones.

### **4.2.1 Speed Distribution of Traffic Entering Work Zone, captured by Speed Camera**

The speed camera unit is equipped with a speed sensor (radar), AGD-340. This sensor is on the compliance list of speed sensors published by the International Association of Chiefs of Police<sup>4</sup>,

---

<sup>4</sup> <http://www.theiacp.org/>



therefore it is recommended for use in enforcement systems. The speed camera records the speed of each detected vehicle, and collects all data points in a single date to compile a speed distribution list. The figure below shows one sample set of the speed distribution data from one day during the field test. The remaining data from other days during the field tests are given in Appendix A. Generally speaking, the average traffic speed recorded was in the range of 50-55 mph and the 85th percentile of the overall speed distribution was 55-60 mph. The 85<sup>th</sup> percentile speed is the speed which 15% of traffic is exceeding and 85% is below. Typically, The speed limit is commonly set at or below the 85th percentile speed<sup>5</sup> and in the USA the speed limit is typically set 8 to 12 mph (13 to 19 km/h) below that speed but uses the 85<sup>th</sup> percentile as a reference point<sup>6</sup>.

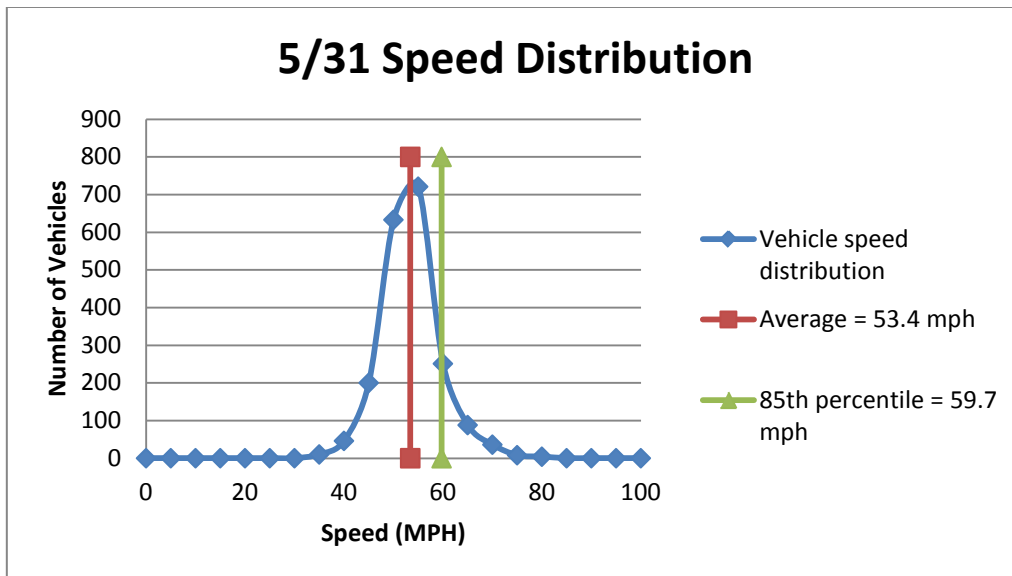


Figure 12. Speed Distribution of Daily Data Measured by Speed Camera

#### 4.2.2 License Plate Number Recognition Results

We evaluated the license plate recognition results by inspecting the archived photographs and corresponding recognition results. An example set of results are shown in Figures 15 and 16. This data set represents one hour of data collected in the field. Note that only the vehicles moving beyond the speed threshold (work zone speed limit at 55 mph) were photographed. Figure 15 shows the counts of five scenarios: totally correct recognition, missing characters, misread characters, or both, and no plate. On the top of the leftmost column, a percentage number was given to show the “accuracy” performance of the LPNR system was able to achieve. Figure 16 shows the number of misread or missed characters within the license plate numbers for each of the two cases. The vertical axis gives the reading of how frequently each case occurs, while a labeling within the bar chart gives a number of “AVG = x.x” at the top of the adjacent bars indicates how many character recognition errors were made in each case.

<sup>5</sup> [Speed Zoning Information. Institute of Transportation Engineers](#). 22 March 2004. Retrieved 2009-09-17.

<sup>6</sup> NCHRP Report #504, p. 88, [http://trb.org/publications/nchrp/nchrp\\_rpt\\_504.pdf](http://trb.org/publications/nchrp/nchrp_rpt_504.pdf). Retrieved 2009-09-16

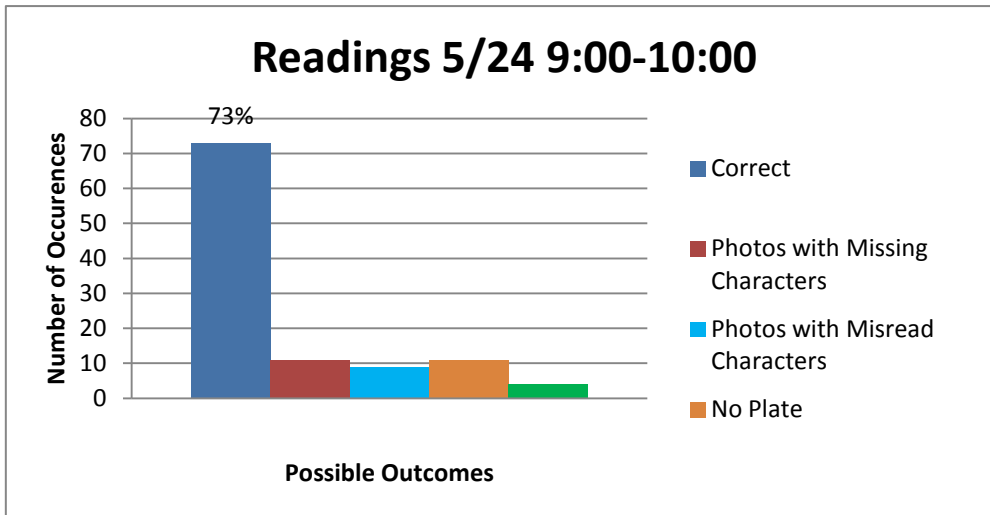


Figure 13. License Plate Number Recognition Results

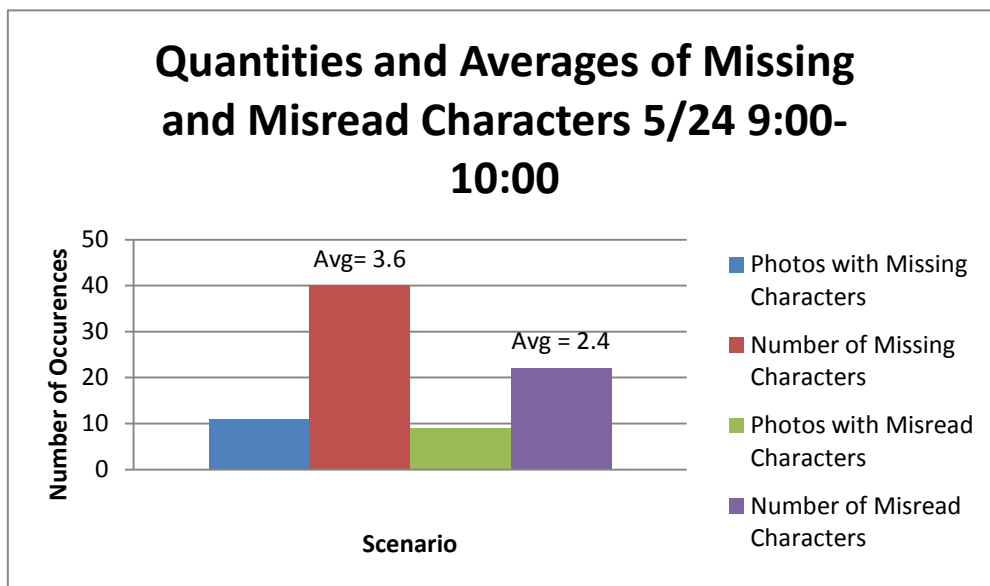


Figure 14. License Plate Number Recognition Results

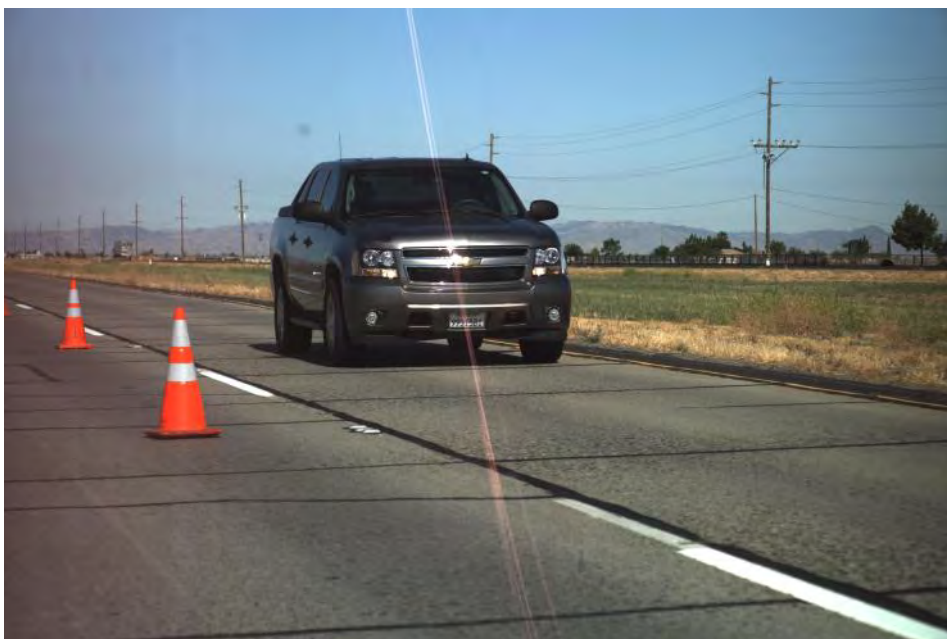
### Performance Factors

We learned from the analysis of these data that the performance levels of the license plate recognition software are strongly influenced by a number of factors. The following situations illustrate the frequently encountered problems:

- Clarity and resolution of photographs: Since the camera is auto-focus controlled, in almost all cases explored in this project, the photographs were clear and of high resolution. The clarity could be affected by the brightness of the operating environment and contrast setting of the camera.
- Information contained within or near the designated areas: In some cases, vehicles may have additional markings or labels containing characters that are in the vicinity of the license plates and also qualify as license plate numbers. A typical LPNR cannot distinguish a valid license plate from other markings in cases like these.
- Missing license plate numbers: Some vehicles do not have license plates on the front (more cases) or the back of their cars (fewer cases).

- Special characters on the plates: Some license plates include special characters or symbols that are not among the list of characters or symbols defined in the LNPR library.
- Shadow and lighting differences in the license plate areas: In some cases during field testing, shadows, shaded areas, or shiny spots on license plates obscured accurate readings, a result of the sun's angle and/or poor ambient lighting. This occurred frequently during our field testing. Fig.17 offers an example of a photograph that has strong sunshine reflections near the front of the vehicle and a shaded area near the license plate.

Some factors addressed above can be overcome by using special filters (for lighting issues) or extended character library (special symbols and characters). Certain factors, such as missing plates or confusing text labeling on vehicles near the plate locations or view obstruction, will leave a small portion of the plates unsuccessfully recognized.



**Figure 15. Sun Reflection and Shadow on License Plate**

### ***Summary of LPNR Data Analysis***

Archived photographs and the associated analysis results are too numerous to include in this report. To offer some perspectives of the achieved performance, two sets of data collected from two entire days are given in Appendix B. In general, the license recognition software sufficiently accomplished the intended function and supported the aSE system. The review of these data and analysis results reveal that:

- The LPNR software can achieve an accuracy of 70 percent or higher, out of all cases including vehicles that have no license plates, plates with special characters, and/or license plates with shadows.
- For the cases where there are some recognition errors, the LPNR software may, on average, misread or miss two to three numbers and characters.
- Lighting conditions or shadows on the license plate strongly affects the performance.
- When the deployment site is oriented in a direction directly facing or opposing the sun, the performance is dramatically different in different hours of the day. For example, the LPNR performance may gradually deteriorate as the day goes on, as is

illustrated in the data set of May 24 in Appendix B.

- On the other hand, when the orientation is not causing the sun to cast shadows or strong reflections on vehicle plates, the performance can be relatively consistent throughout the day, as illustrated by the data set of June 29 in Appendix B.

#### 4.2.3 Speed Data Measured by EVT-300 Radar at CMS Location

In addition to other speed measurement devices, we also installed a radar sensor at CMS locations to capture traffic movement. This monitoring is especially meaningful when drivers are approaching the CMS and witness the CMS displays. The picture below in Fig. 18 shows the placement of the radar on the trailer that hosts the CMS. The radar has a limited field of view of only 12 degrees; therefore its antenna is oriented to face the approaching traffic from a corner of the CMS trailer.

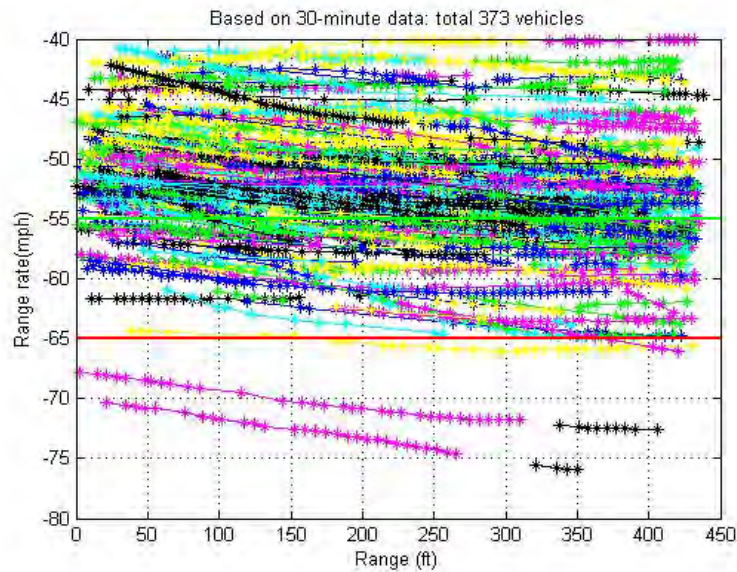


**Figure 16. Location of Radar Sensor on CMS Trailer**

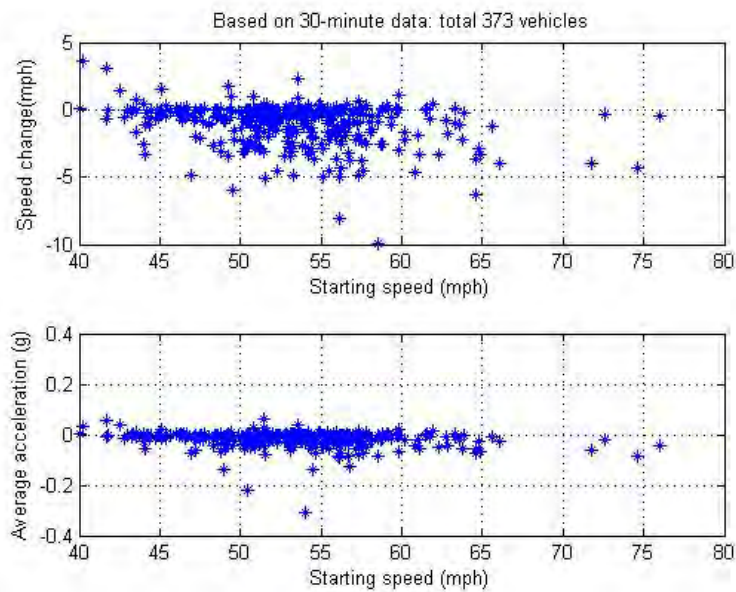
One sample set of 30-minute data is shown in Figure 19 with four subplots given:

- 1) Range rate versus range (speed plotted against distance), as shown in Figure 4(a). The used radar is EVT-300, which can track 7 targets at any instant with a sampling rate of 16 Hz. The data are plotted with the radar position at the origin, i.e. at distance zero, as the horizontal axis indicating the distance of the target away from the radar. The radar can detect target from a distance of 450 feet, so a target will be moving with the distance decreasing toward zero, from right to left in the chart. Each color line in the plot indicates the trace of a target approaching the radar. The range rate (speed), as indicated in the vertical axis, is shown as a negative number, because the target is closing the range to the radar. As can be seen in the bottom half of the chart, two distinct targets are moving toward the radar with decreasing speeds.
- 2) Distribution of speed change and deceleration plotted against starting speeds, as shown Figure 19(b). The same set of data from Figure 19(a) are regrouped by the starting speed of a target and shown in Figure 19(b). The starting speed is the speed of a detected target when it is first tracked by the radar, i.e. the first point of a colored line in Figure 19(a). The distribution is shown in a scattered point plot, in which each point represents a target from the previous plot. The speed change and deceleration were calculated based on the trajectory of a target during the period when it was tracked by the radar, i.e. the trace of a

colored line representing a target in Figure 19(a). The plot shows a great majority of the targets experience speed reduction and deceleration as observed by the radar.

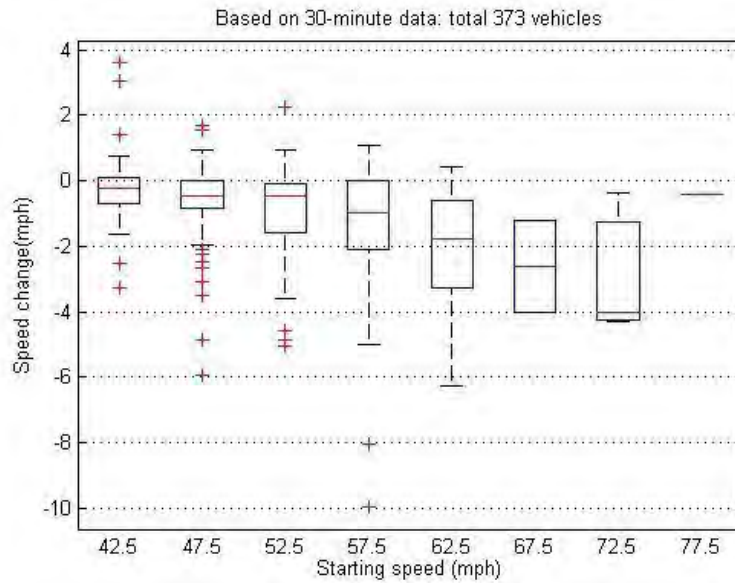


**Figure 19 (a): Range rate vs. Range (Speed vs. Distance) of Vehicles Approaching CMS**

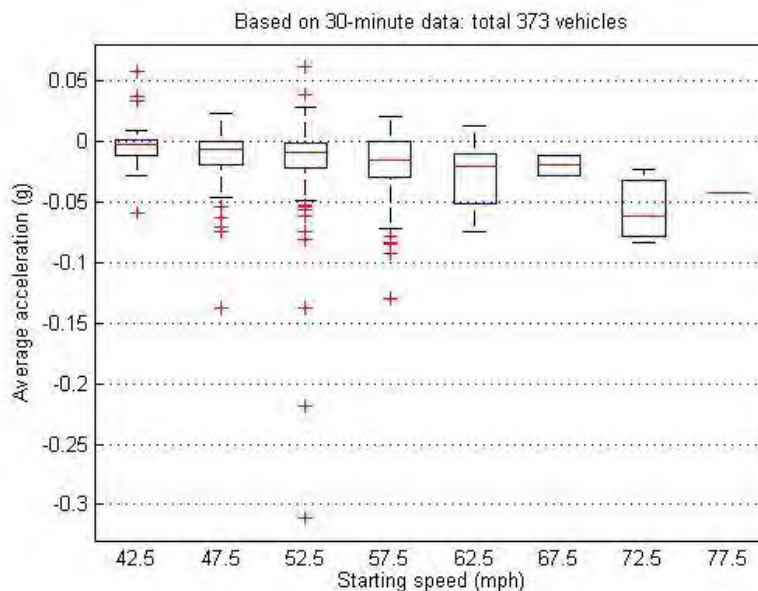


**Figure 19 (b): Distribution of Speed Change of Vehicles Approaching CMS**

- 3) Distribution of speed change, grouped by starting speeds, as shown Figure 19(c). The same set of data from Figure 19(a) are regrouped by the starting speed of a target and shown in Figure 19(c). The starting speed is the speed of a detected target when it is first tracked by the radar, i.e. the first point of a colored line in Figure 19(a). The distribution is shown in a box plot, in which the box shows the range of 25<sup>th</sup> to 75<sup>th</sup> percentile, and the end points of the line indicating the upper and lower range of data. As can be seen in Figure 19(c), a great majority of targets experience a negative speed change.
- 4) Distribution of deceleration, grouped by starting speeds, as shown Figure 19(d). This is a plot similar to the subplot immediately above, except that the values of deceleration are plotted. A negative acceleration or a deceleration, as a reflection of speed reduction, indicates that a great majority of targets slow down as they approach the radar at CMS.



**Figure 19 (c): Distribution of Speed Change of Vehicles Approaching CMS**



**Figure 19 (d): Distribution of Deceleration of Vehicles Approaching CMS**

The archived EVT-300 data and associated analysis results are too numerous to include in this report. To offer some perspective of the observations, several selected data sets are included in Appendix C. A review of these data and analysis results reveals that:

- A great majority of the vehicles show a reduction in vehicle speed while they are in the detection range of the radar.
- For the majority of the vehicles, the change in speed may be too small to be quantified as intentional speed reduction by drivers due to the CMS display. Nevertheless, there are still a meaningfully large number of speed reductions among all samples, which is consistent with data samples from other data sources.
- Anecdotally, the researchers were able to observe occasional brake lights of vehicles when they approach the CMS. This also matches the noticeable numbers of significant speed reductions in data.

#### 4.2.4 DSRC Communication

In the aSE project, DSRC devices work as message forwarders and receivers. A first DSRC module is responsible for forwarding messages from the speed camera to a second DSRC module located at the CMS trailer. The second DSRC module transfers the message as a CMS string, for the message to be displayed. For identification purposes, the first DSRC module is named as the OBU and the second as RSU, which are used in the following discussions. Thus, the routing can be divided into three parts, e.g., from speed camera to OBU, from OBU to RSU, and from RSU to CMS.

Fig. 20 shows the network topology and system architecture of the aSE project from the perspective of the communication and network/application management. The solid arrowed lines denote the wired connections, while the dotted arrows denote the over-the-air wireless connections or a data flow relationship between two entities. The notation  $x/y/z$  is used to describe the information exchange between two entities, where  $x$  denotes the user-level application/service used for exchanging data,  $y$  denotes the type of communication link, and  $z$  indicates whether the link is physically a wired or wireless link. The acronym “NR” denotes “Not Restricted”.

We analyzed transmission performances for different routing parts, where all results are measured and obtained from the field trials in Los Banos. Table 2 shows transmission latency of the three routing parts. As expected, in the first part, the speed camera is directly connected to the OBU using an Ethernet cable. Thus, the transmission latency between the OBU and speed camera is, on average, 0.321 milliseconds. And, in the second part, the DSRC achieves 0.694 milliseconds on average, transmitting a DSRC message from OBU to RSU. However, in the third part, due to a switch hub problem, the transmission latency is up to 94.497 milliseconds on average. This affected overall performance more significantly than in the first two parts.

**Table 2. Performances for Different Links**

	Camera<->OBU (ms)	OBU<->RSU (ms)	RSU<->CMS (ms)
Max	0.737	2.178	848.079
Min	0.273	0.66	1.567
Average	0.321	0.694	94.497

As shown Table 2, consequently, the routing device influenced the routing performance significantly. Under extremely high temperatures or rainy weather conditions, the routing device may be subject to malfunction or even failure. So, for future employment, the routing device needs to be capable of operating in harsh environments. In any case the current maximum delay in the RSU<->CMS link will cause the message to be displayed when the driver is closer to the CMS. Though this might still be within the limits of a driver’s reaction envelope, it is definitely an area for improvement. Alternatively, the distance to the CMS may need minor adjusting. In a production version of the aSE system, a network switch hub is not necessary and the RSU could be directly connected to the CMS. In such a configuration, the RSU <->CMS delay would be comparable with the Speed Camera<->OBU link.

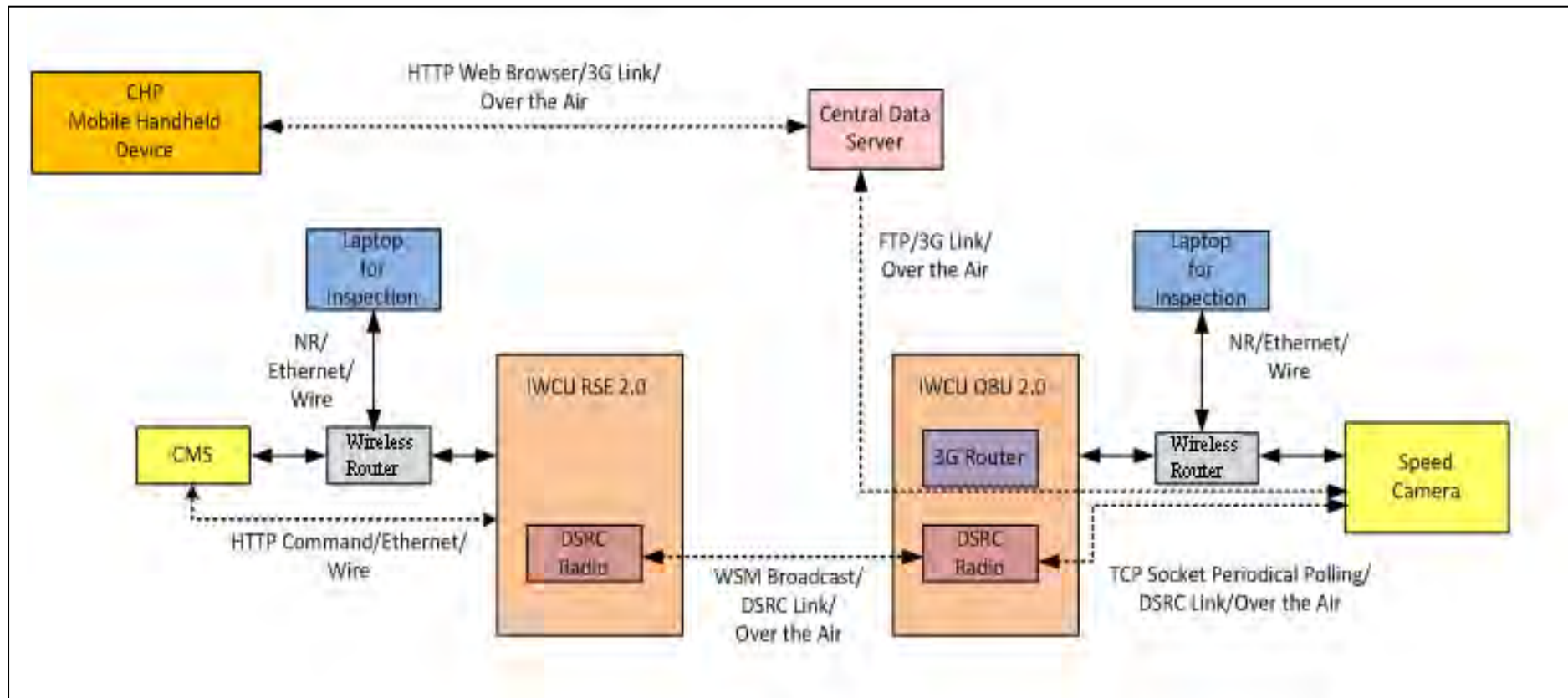


Figure 17. aSE Communication Network Topology and System Architecture



### Tests of an Alternative DSRC Communication Setup

During normal operations of the proposed system, violator information is transmitted to a secured server by cellular connection and is accessible from portable devices. Where no cellular connection is available, the alternative is to transmit the data from the speed camera to a relay station where a Wi-Fi access point (AP) is set up for the CHP to receive the data. Due to several drawbacks for this alternative configuration, it is not yet considered for deployment. While it may offer a solution in terms of achieving data transmission to the end user, the challenges for the alternative configuration include the following ones:

- The range limit of DSRC transmission from one unit to the other;
- The range limit of Wi-Fi access point;
- The officers will only be able to access data from the Wi-Fi network in stationary positions;
- For each relay DSRC module, repeater or Wi-Fi node, there needs to be a set up for power supply, which could be burdensome in field deployment scenarios.

The alternate architecture includes a relay and alternate mechanism for delivering violator information to the CHP officer. The following diagram shows the functional block diagram of the alternate architecture.

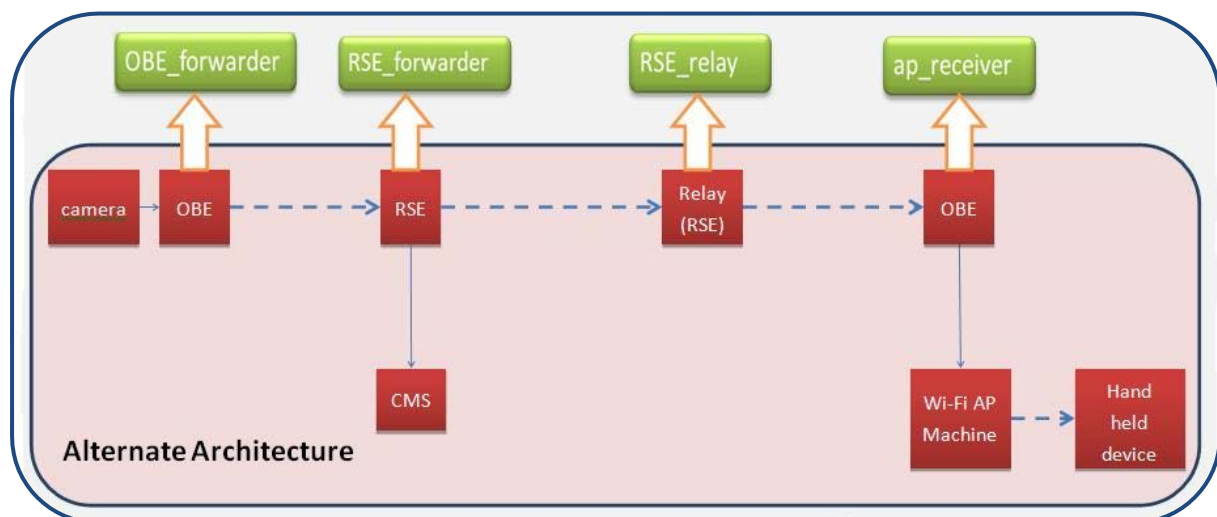


Figure 18. Data Flow Architecture of Alternative Communication Configuration

The uniqueness of this configuration is that it includes a DSRC relay which transmits violator information to a DSRC OBE, which receives the information before forwarding it to a Wi-Fi-enabled computer, which securely broadcasts the information via Wi-Fi to the Wi-Fi-enabled device used by the CHP officer.

This alternative system was developed and tested at UC Berkeley's Richmond Field Station. The terminal Wi-Fi system was built and tested. This was tested for potential interference issues inside the CHP cruiser during a visit to the Richmond Field Station by CHP officials. The system was demonstrated and no undue interference was observed during the test. The relay component worked satisfactorily when the relay was near the 350m mark from the speed camera. Beyond this distance, the resulting packet loss made the link unreliable and significantly less robust. This result implies that a single DSRC relay would not be sufficient to traverse the entire work zone and reach the CHP officer situated at least a mile downstream. Though theoretically multiple relays can be used, it poses significant practical difficulties in a

field deployment. First, powering the relays and their deployment in the work zone would be a major challenge for the work crew every day. Even a single relay would be a challenge to tend to in the field; the challenge will only be many times more if multiple relays are used. Secondly, the Wi-Fi base terminal delivery system will severely restrict the positioning of the CHP officer tying him to the range of the Wi-Fi AP.

#### 4.2.5 Cellular-Server Communication

The performance of the cellular-server link determines if this information link is capable of supporting the necessary function of delivering violator information, both in text and photographic formats.

This link was tested at PATH initially during the feasibility testing. The preliminary results showed that such cellular server communication would be possible to sustain in field tests. Since cellular coverage varies with location, we monitored the data transmission in the cellular-server link during field testing in Los Banos. We present one sample data set in this section, while additional data sets are included in Appendix C. For each set, the total number of uploads and the average upload latency is presented. A graphical representation of the upload latency, its Cumulative Distribution Function (CDF) and histogram are shown to offer clear insight into the distribution of the upload latency. The latency of the individual uploads on which this average is based is shown as a scatter plot in Fig. 22. The CDF in Fig. 23 helps to easily determine the generalized behavior of this particular set of upload times. For example it can be easily determined from Fig. 23 that for this set of data 70% of the upload time was below 30seconds. Similarly, the histogram of this upload data set as shown in Fig. 24 illustrates the frequency of the full range of upload times. From Fig. 24 it is seen that for this particular set the frequency of upload times over 15 seconds are sparse and relatively low.

#### Sample Data Set 1

- Total number of uploads: 100
- Average Latency for uploads without mismatch: 21.0233 seconds

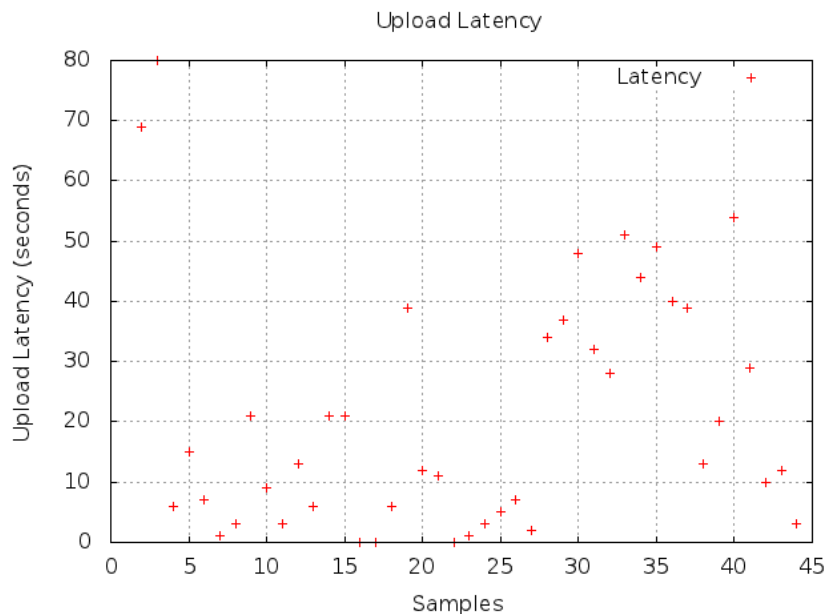
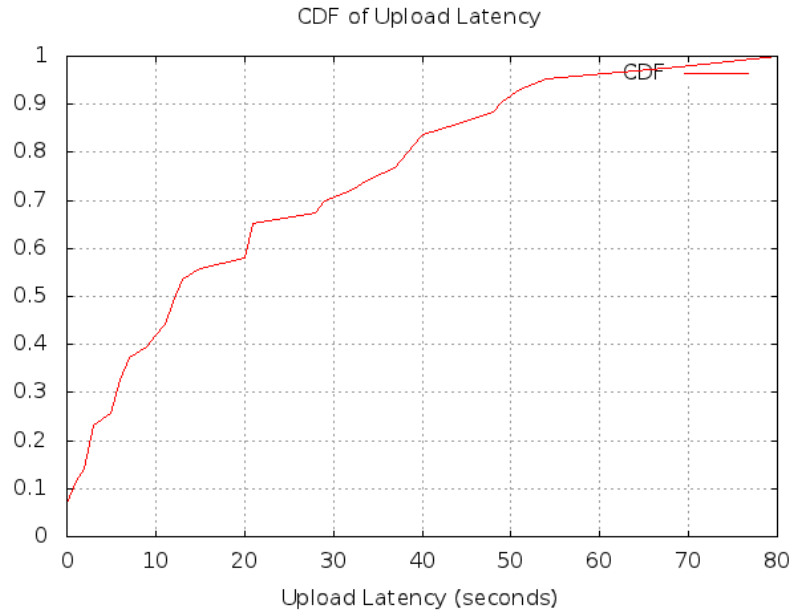
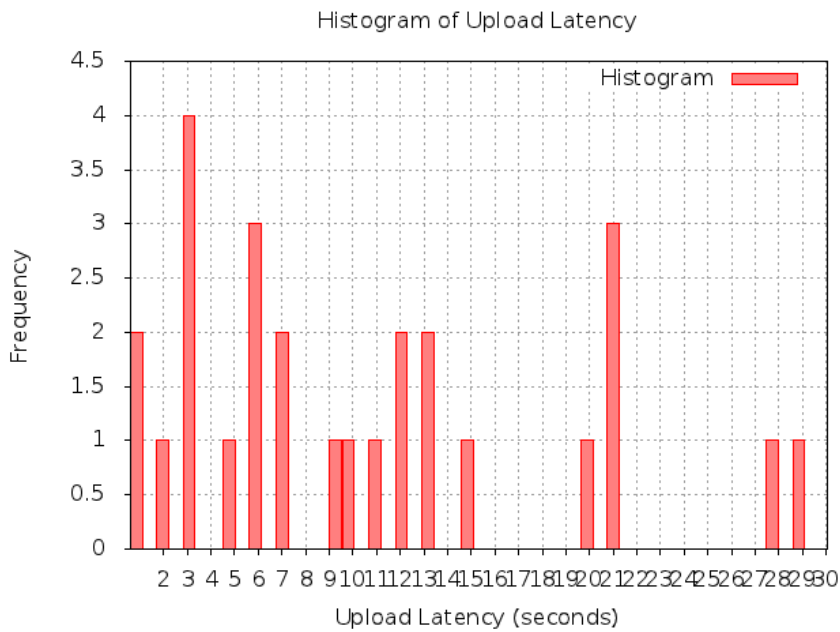


Figure 19. Distribution of upload latency



**Figure 20. Cumulative distribution of upload latency**



**Figure 21. Histogram of upload latency**

**Summary and analysis**

In the following table we summarize the data for both text and photo transmissions covering all representative scenarios. Of all these seven sets, we discard the fifth set while measuring the overall impact. The reason is the anomalous behavior of the system during that particular slot, due to malfunctioning of power supply. The issue affected only one data point, but the whole set is taken out of consideration in order to maintain uniformity.

**Table 3. Upload Latency Data Samples**

Text	Set 1	Set 2	Set 3	Set 4	Set 5	Set 6	Set 7
------	-------	-------	-------	-------	-------	-------	-------

E2E Latency(seconds)	<b>21.023</b>	<b>7.1714</b>	<b>7.6</b>	<b>6.579</b>	<b>188.29</b>	<b>7.3333</b>	<b>6.697</b>
Total	43	35	10	19	7	24	33
<b>Photo</b>							
E2E Latency(seconds)	<b>71.5</b>	<b>23.343</b>	<b>18.5</b>	<b>14.526</b>	<b>155.11</b>	<b>16.657</b>	<b>17.556</b>
Total	48	35	10	19	9	35	45

The data tabulated above is graphically represented in the chart below, which shows upload latency of the text and photo transmissions together for ready comparison.

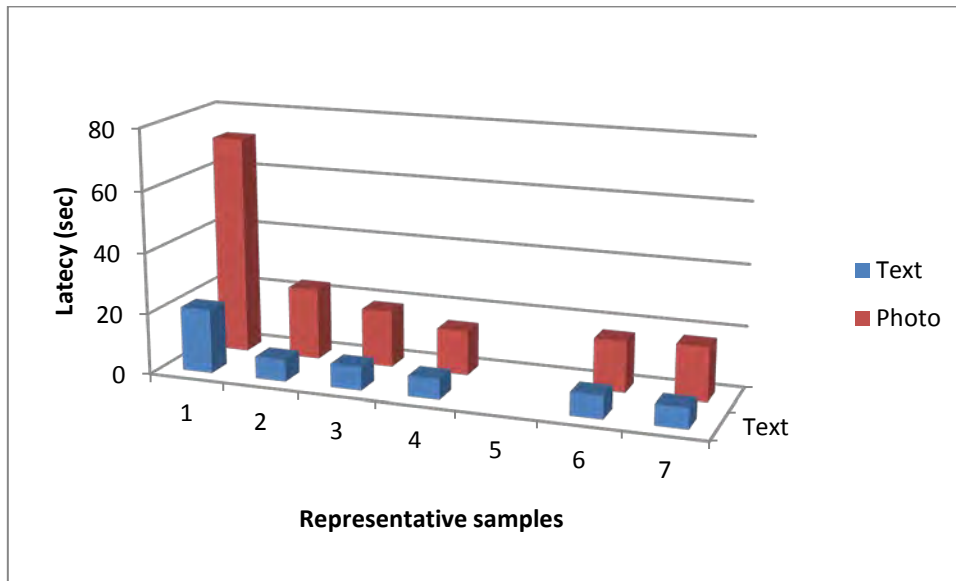


Figure 22. Upload Latency Distribution of Text Messages and Photographs

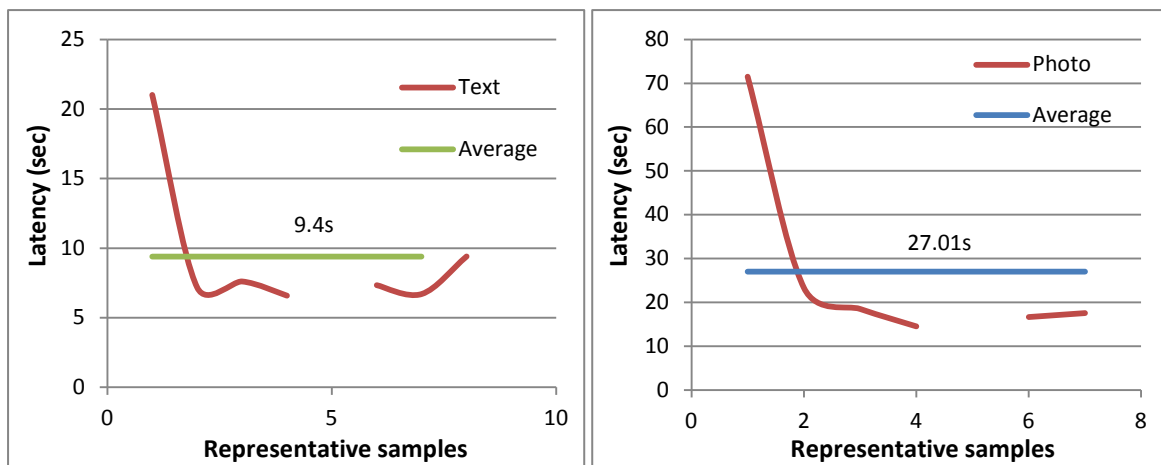


Figure 23. Average Upload Latency Distribution of Text Messages and Photographs

We also analyzed the individual behavior of the text and photo upload latency. We calculate the average upload latency for all the data and plot them along with the average latency of the individual data sets, as shown in the figure below. The resulting cumulative average for the text upload latency is found to be 9.4 seconds and that for the photos is 27.01 seconds. Both these values are well within the bounds necessary for effective use of the cellular-server data link to transfer photos and text. The data contained in the text is the more important part of the

information transferred, and we note that the average values of the upload latency for both text and photos are higher than most of the averages of the individual data sets. This implies that the actual performance of most of the uploads are lower than the cumulative average.

#### **4.2.6 iCone Data**

In this section we analyze the iCone data to identify the effectiveness of the aSE system. The field test was organized into weekly slots during which the WTI system was tested, followed by WTI-PATH joint deployment, then PATH only deployment, and finally baseline testing. This schedule was repeated twice, resulting in two sets of data, which we refer to as first set and second set. The iCone data is classified into four speed ranges: less than 60mph, 60-65mph, 65-70mph, and more than 70 mph. In order to measure effectiveness of the aSE system, we will analyze vehicle speeds along the work zone from the iCone data. One important measure of effectiveness will be the observance of the reduction in number of vehicles in the highest speed bin due to the deployment of the aSE system. During the test period the system encountered approximately 4000 vehicles per day in the time it was active.

Note, that except for an occasional wrong placement, iCones 1 and 2 were placed at the segment prior to entering the work zones, iCones 3 and 4 were placed at the first half of the work zone (where the PATH system is located), and iCones 5 and 6 were placed at the second half of the work zone (where the WTI system is located). Please refer to the diagram in Section 4.1 for the work zone layout.

**Table 4 Data Set #1, Distribution of Vehicle Speeds Measured by iCones**

<60 mph	60-65 mph	65-70 mph	>70 mph	<60 mph	60-65 mph	65-70 mph	>70 mph	<60 mph	60-65 mph	65-70 mph	>70 mph	<60 mph	60-65 mph	65-70 mph	>70 mph	<60 mph	60-65 mph	65-70 mph	>70 mph	<60 mph	60-65 mph	65-70 mph	>70 mph
<b>WTI 14-18 May</b>																							
40%	26%	21%	13%	81%	12%	5%	2%	89%	8%	3%	1%	92%	6%	2%	1%	93%	6%	1%	0%	93%	5%	1%	0%
<b>WTI&amp;PATH 21-24 May</b>																							
38%	25%	24%	12%	80%	13%	5%	2%	93%	5%	2%	0%	96%	3%	1%	0%	97%	3%	1%	0%	97%	2%	0%	0%
<b>PATH 30 May - 1 Jun</b>																							
33%	24%	24%	19%	79%	13%	5%	2%	89%	8%	3%	1%	93%	6%	1%	0%	93%	6%	1%	0%	93%	5%	1%	0%
<b>Baseline 4-8 Jun</b>																							
36%	24%	24%	16.43%	75%	16%	6%	2%	85%	10%	3%	1%	87%	9%	3%	1%	89%	8%	2%	0%	94%	5%	1%	0%
<b>Standard Deviation</b>																							
3.20%	0.89%	1.76%	2.88%	2.45%	1.92%	0.41%	0.20%	3.03%	2.09%	0.74%	0.23%	3.79%	2.72%	0.85%	0.23%	3.08%	2.31%	0.66%	0.14%	1.78%	1.36%	0.33%	0.14%
<b>cone 1</b>				<b>cone 2</b>				<b>cone 3</b>				<b>cone 4</b>				<b>cone 5</b>				<b>cone 6</b>			

In this table we present the percentage of vehicles in each of the four speed bins at each of the six iCones in the work zone for the different systems deployed as well as the baseline period during the first set of tests. This tabulation of the independent iCone data will help us further analyze trends and effects resulting from the deployments. These trends are in consonance with the effects indicated by radar at the CMS.

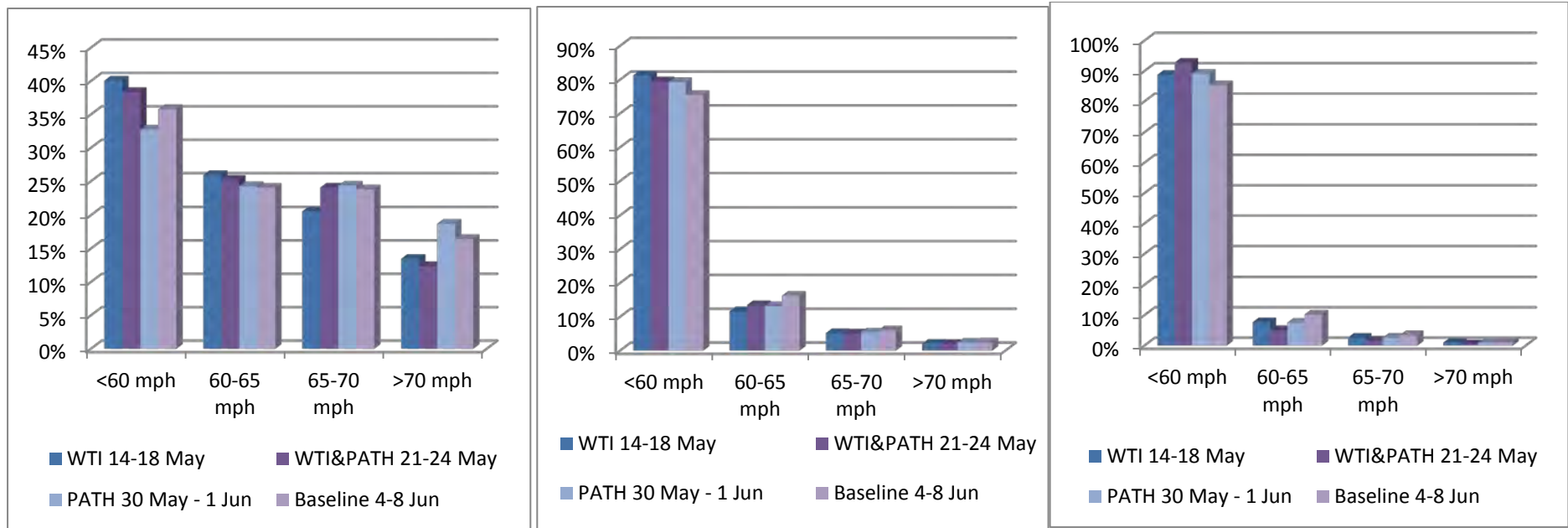


Figure 24. Speed Distribution, Measured by iCones

Cone 1

Cone 2

Cone 3

As a step towards identifying trends in the preceding and following three figures, we plot the percentage of cars in each speed bin at each cone for all four deployment scenarios. The obvious trend suggested by the data is the increase in the number of cars driving below 60mph as they proceed through the work zone. It also suggests potential effectiveness once any of the systems are deployed over the baseline system. It also points out the positive effect of the combined systems, especially from the second cone onwards.

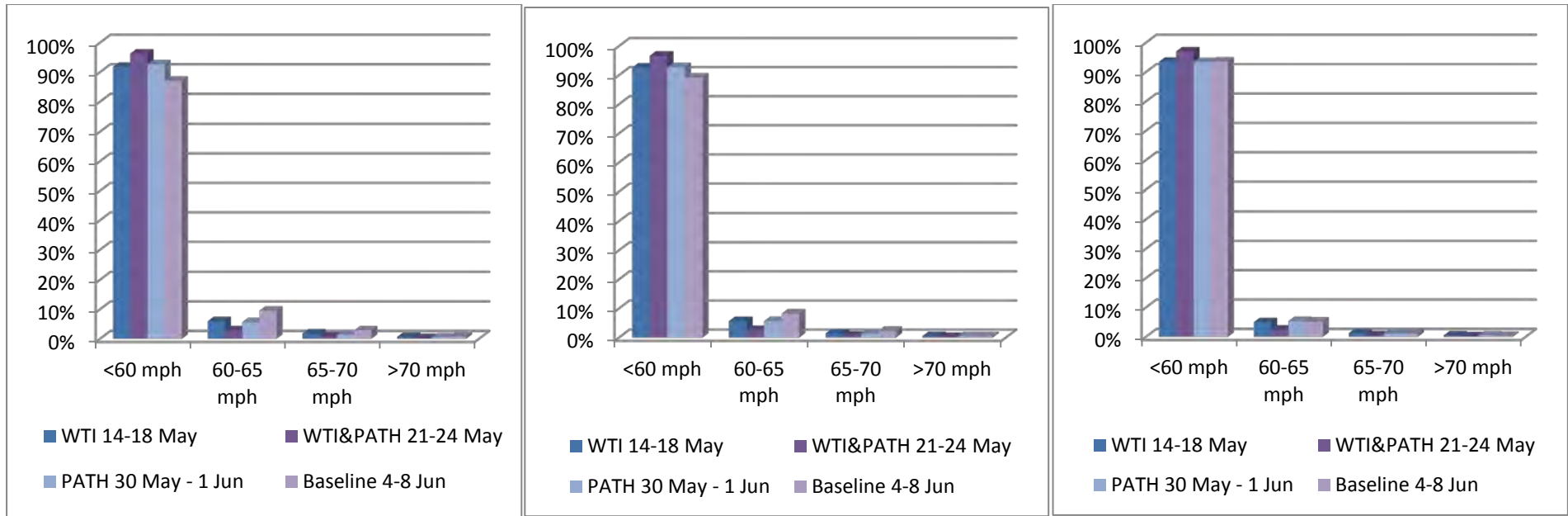


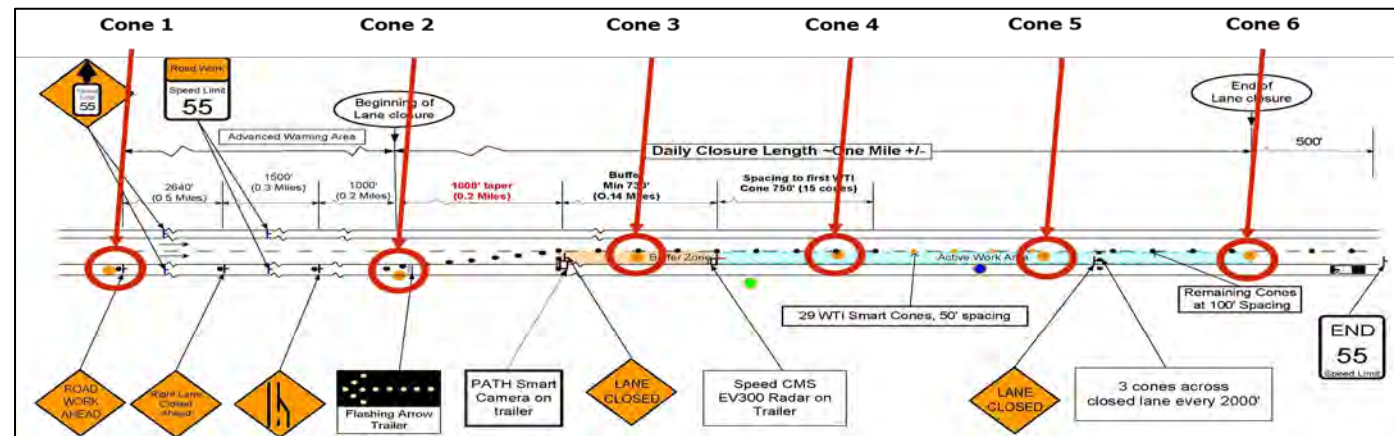
Figure 25. Speed Distribution, Measured by iCones

Cone 4

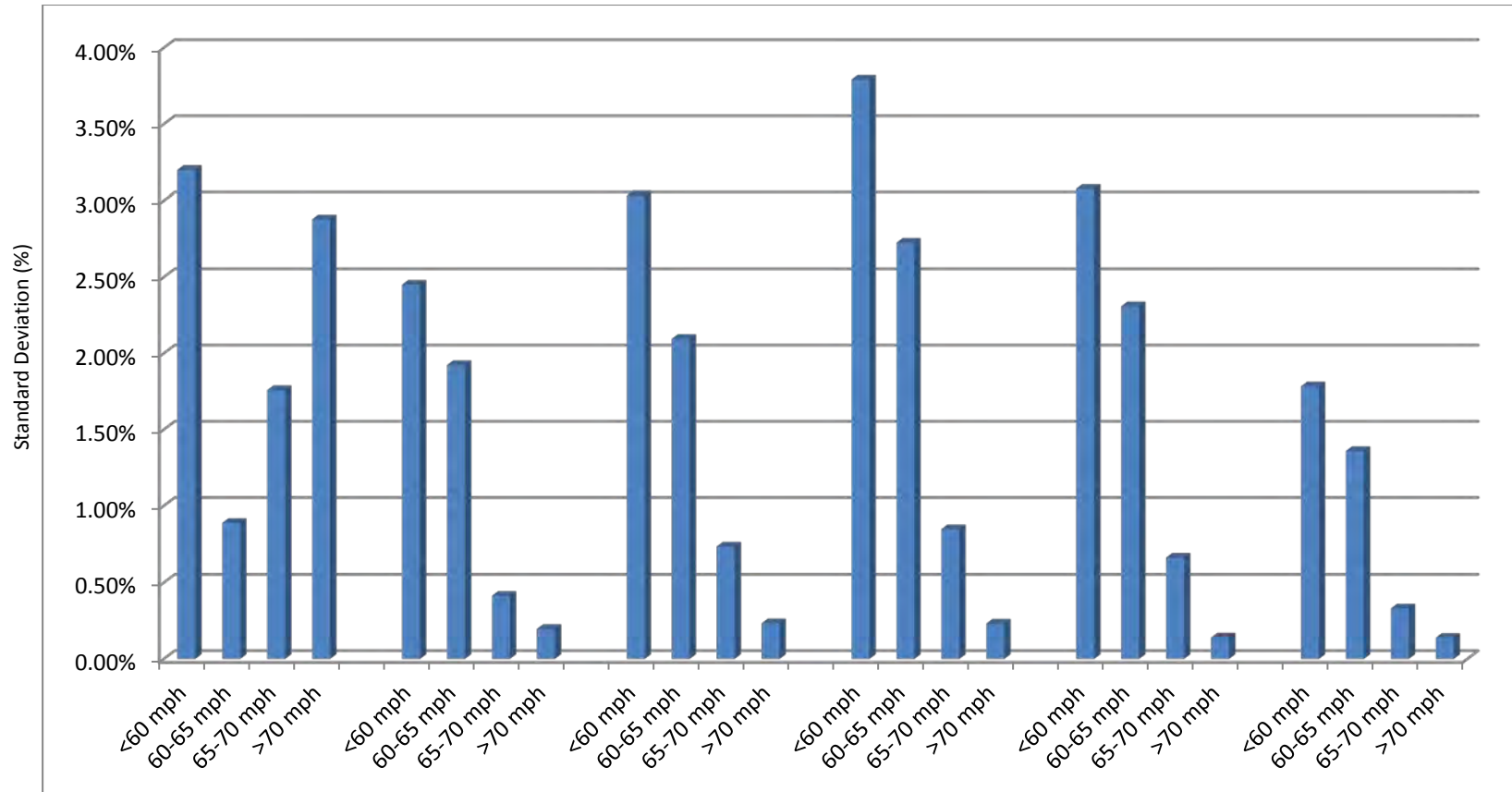
Cone 5

Cone 6

The work zone diagram with the relative location of iCones is shown by the figure on right for ready reference.







**Figure 26. Data Set # 1, Performance at each cone: Standard Deviation over all conditions and bins**

cone 1

cone 2

cone 3

cone 4

cone 5

cone 6

In this figure the standard deviation of all the deployment conditions over all the bins is plotted. The presence of a non-zero value for all the conditions and bins suggests that there is some effect as a result of the systems. We noticed a relatively higher variance in the under 60mph bin across all the cones, and a higher variance in the higher speed bins of 65-70mph and over 70mph at the first cone located at the start of work zone. This prompted us to further investigate the effect of the aSE system deployment once we have completed initial analysis of the second data set.

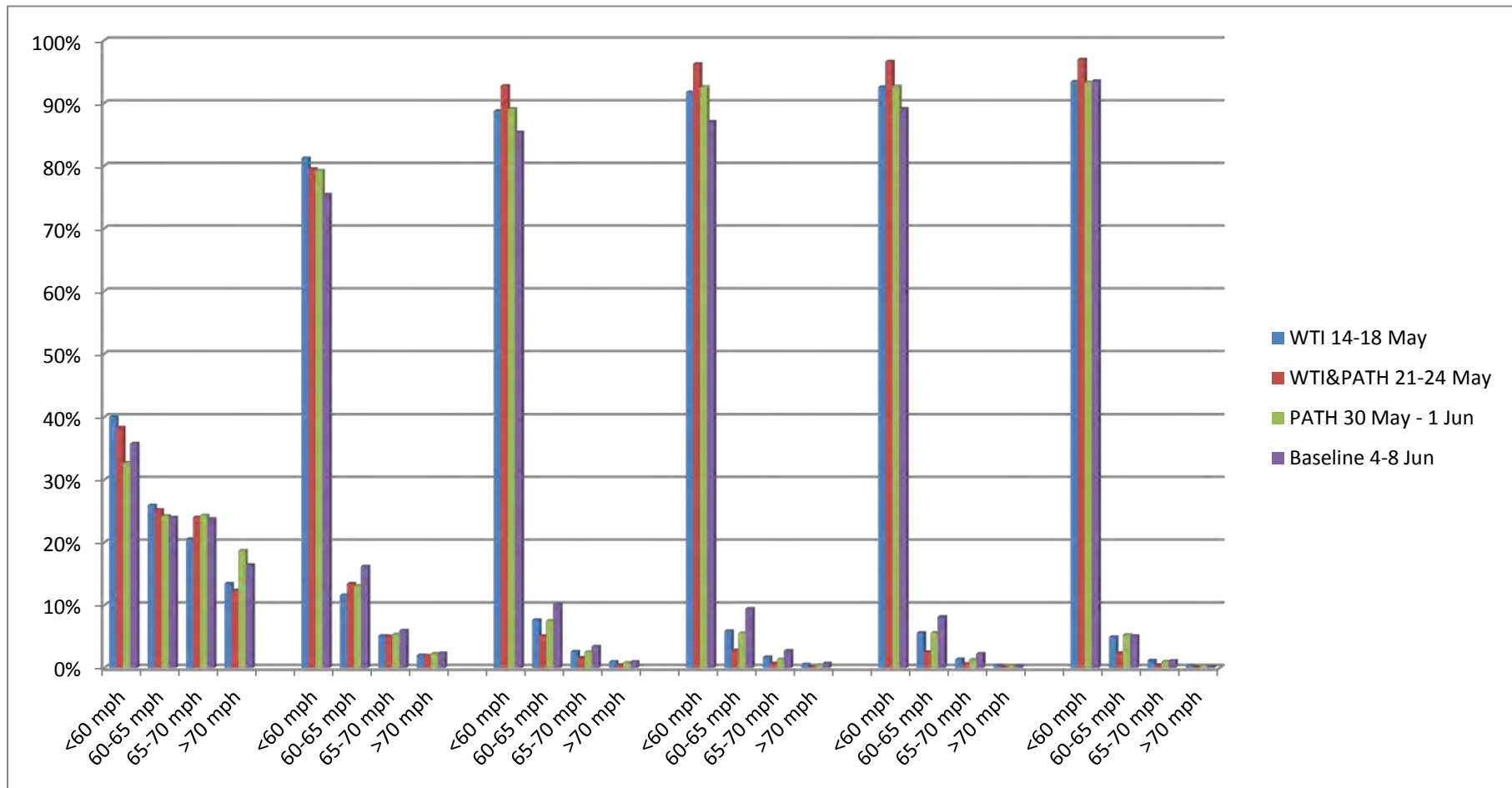
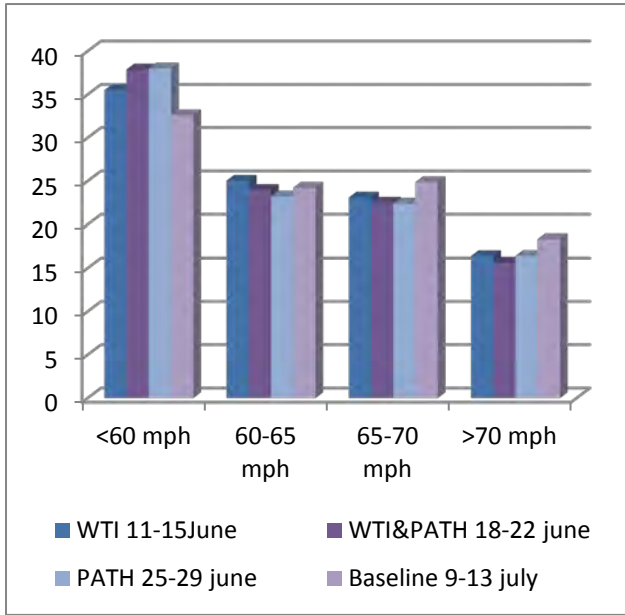


Figure 27. Data Set # 1, Overall Effects of Speed Distribution, Measured by iCones

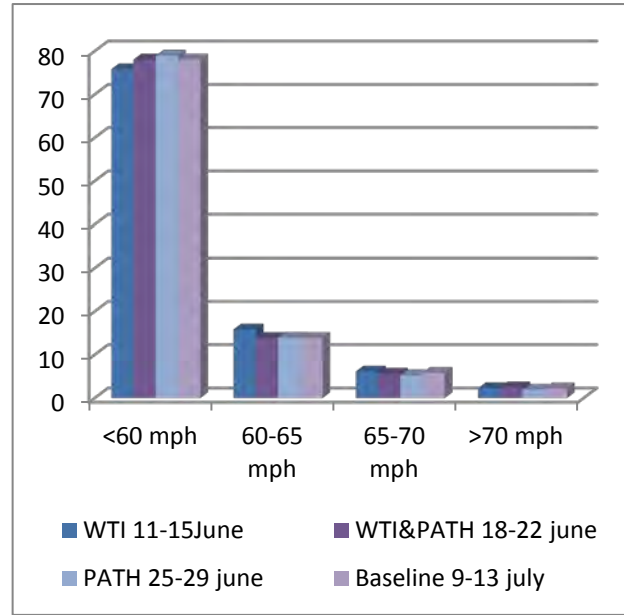
**Table 5 Data Set #2, Distribution of Vehicle Speeds, Measured by iCones**

<60 mph	60-65 mph	65-70 mph	>70 mph	<60 mph	60-65 mph	65-70 mph	>70 mph	<60 mph	60-65 mph	65-70 mph	>70 mph	<60 mph	60-65 mph	65-70 mph	>70 mph	<60 mph	60-65 mph	65-70 mph	>70 mph	<60 mph	60-65 mph	65-70 mph	>70 mph		
<b>WTI 11-15 June</b>																									
35.49	25.032	23.078	16.39	75.81	15.837	6.1025	2.242	86.99	9.2604	2.8663	0.876	91.86	6.1540	1.4569	0.519	92.75	5.5167	1.3312	0.392	94.40	4.5995	0.7836	0.214		
<b>WTI&amp;PATH 18-22 June</b>																									
37.87	23.976	22.499	15.64	78.04	13.880	5.6207	2.455	90.82	6.2464	2.2264	0.701	94.24	4.1483	1.1800	0.424	94.32	4.2938	1.0683	0.308	95.15	3.6289	0.9206	0.292		
<b>PATH 25-29 June</b>																									
37.99	23.215	22.380	16.40	78.93	13.917	5.2365	1.914	91.31	6.4718	1.7358	0.477	95.31	3.4212	1.0105	0.251	95.79	3.1285	0.8577	0.215	96.09	3.1282	0.5458	0.232		
<b>Baseline 9-13 July</b>																									
32.57	24.212	24.859	18.35	78.07	13.868	5.8255	2.226	87.21	8.6853	3.0805	1.017	87.54	9.3275	2.3404	0.790	91.72	6.1993	1.5996	0.472	95.93	3.1644	0.7629	0.142		
<b>Standard Deviation</b>																									
2.548	0.7482	1.1446	1.156	1.331	0.9747	0.3646	0.222	2.298	1.5299	0.6131	0.232	3.450	2.6425	0.5916	0.225	1.785	1.3565	0.3217	0.110	0.778	0.6852	0.1549	0.061		
079	23	35	338	825	08	05	995	625	85	79	704	016	99	7	191	002	66	68	215	06	19	79	867		
<b>cone 1</b>				<b>cone 2</b>				<b>cone 3</b>				<b>cone 4</b>				<b>cone 5</b>				<b>cone 6</b>					

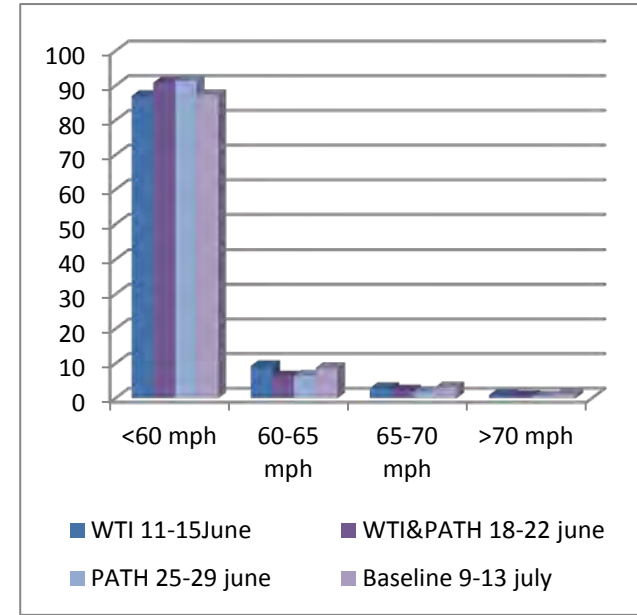
In this table we present the percentage of vehicles in each of the four speed bins at each of the six iCones in the Work Area for the different systems deployed as well as the baseline period during the second set of tests. This tabulation of the independent iCone data will help us further analyze trends and effects resulting from the deployments. These trends are in consonance with the effects indicated by radar at the CMS.



Cone 1



Cone 2



Cone 3

Figure 28 Data Set #2, Speed Distribution, Measured by iCones

Similar to the first data set, we plot the percentage of cars in each speed bin at each cone for all our deployment scenarios as a step towards identifying trends in the preceding and following three figures. The trend here, suggested by the data, is an increase in the number of cars going at below 60mph as they proceed through the work zone. It also suggests the potential for effectiveness once any of the systems are deployed over the baseline system. And it points out the increased effect of the PATH system, especially from the second cone onwards.

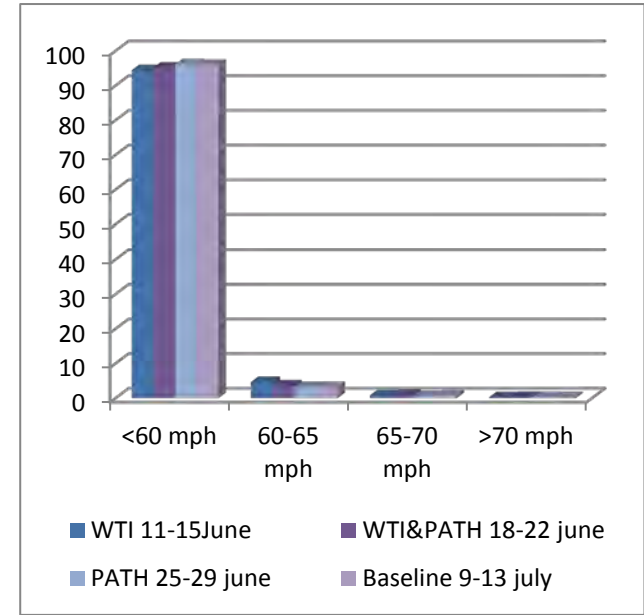
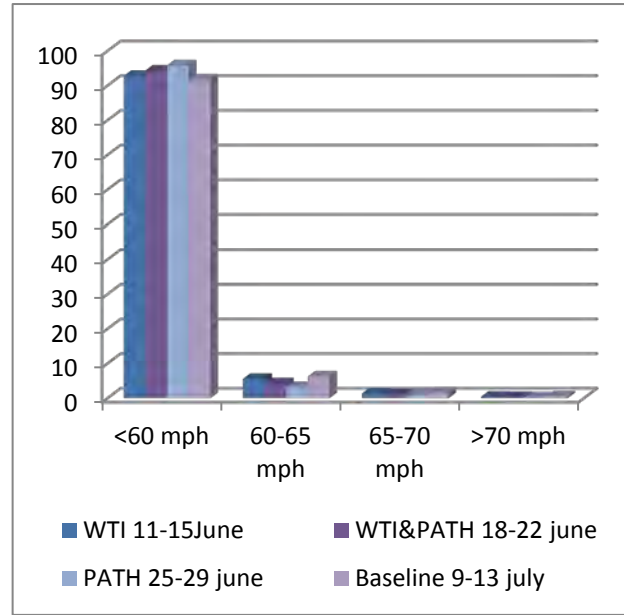
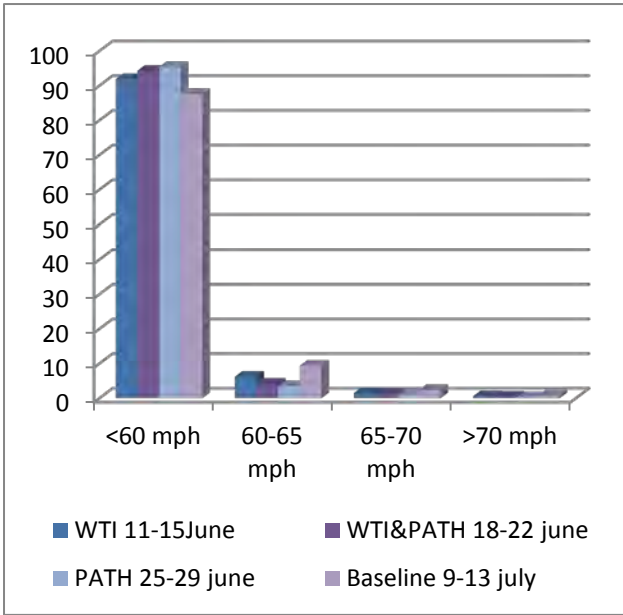


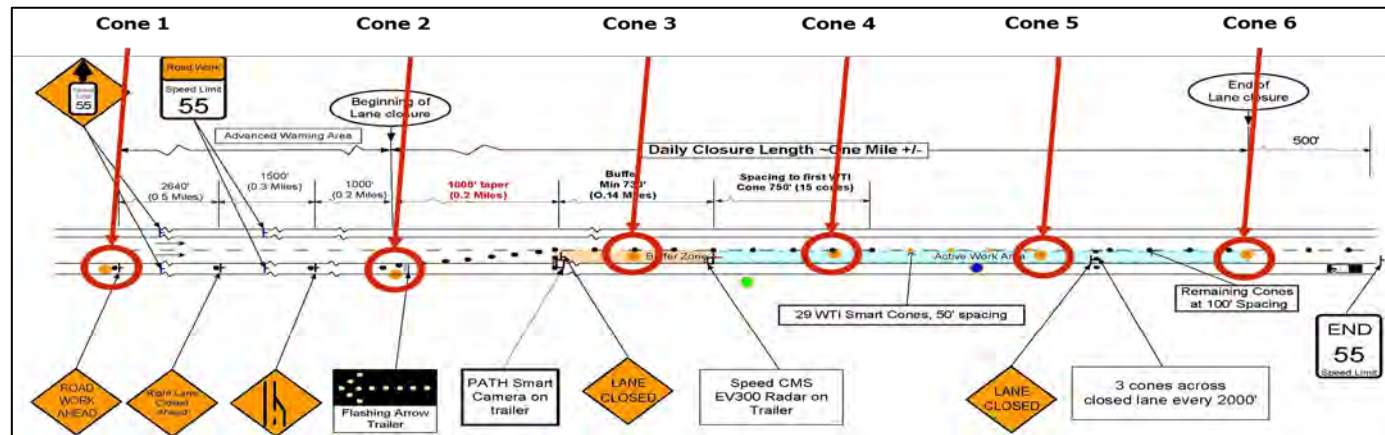
Figure 29 Data Set #2, Speed Distribution, Measured by iCones

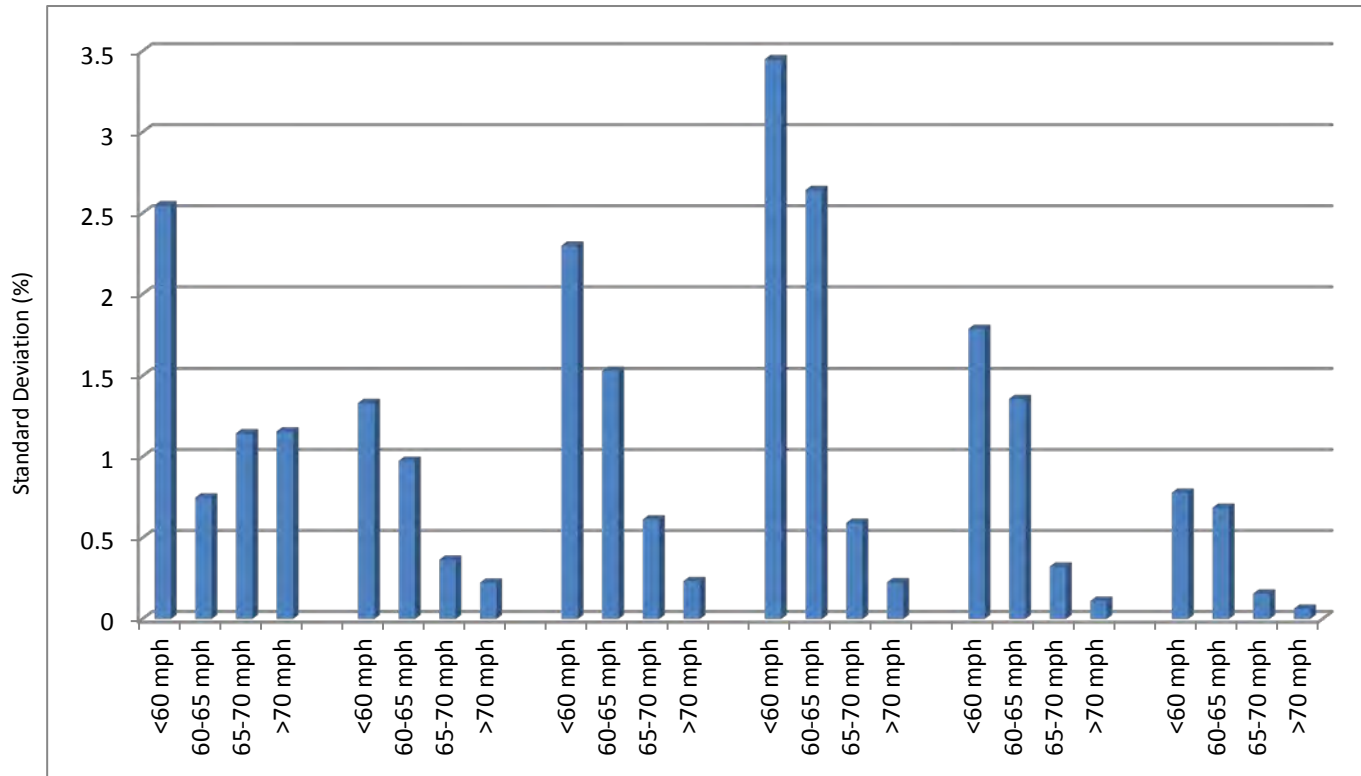
Cone 4

Cone 5

Cone 6

The work zone diagram with the relative location of iCones is shown by the figure on right for ready reference.





**Figure 30. Data Set # 2, Performance at each cone: Standard Deviation over all conditions and bins**

cone 1

cone 2

cone 3

cone 4

cone 5

cone 6

In this figure the standard deviation of all the deployment conditions over all the bins is plotted for the second set of data. Here, we also noticed the presence of a non-zero value for all the conditions and bins, which suggest that there is some effect from the systems. We also noticed a relatively higher variance in the under-60mph bin across all the cones and a higher variance in the higher speed bins of 65-70mph and over 70mph at the first cone at the start of the work zone. This is consistent with the initial analysis of the first set of data.

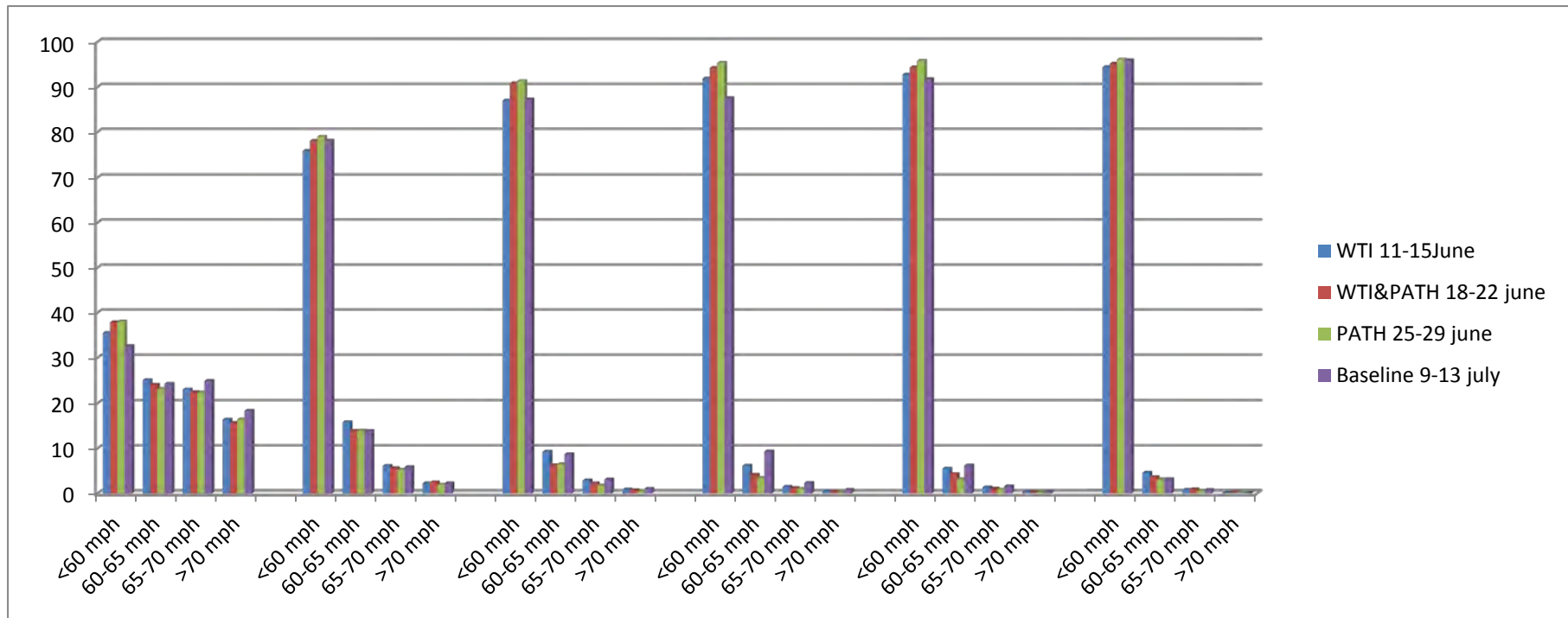


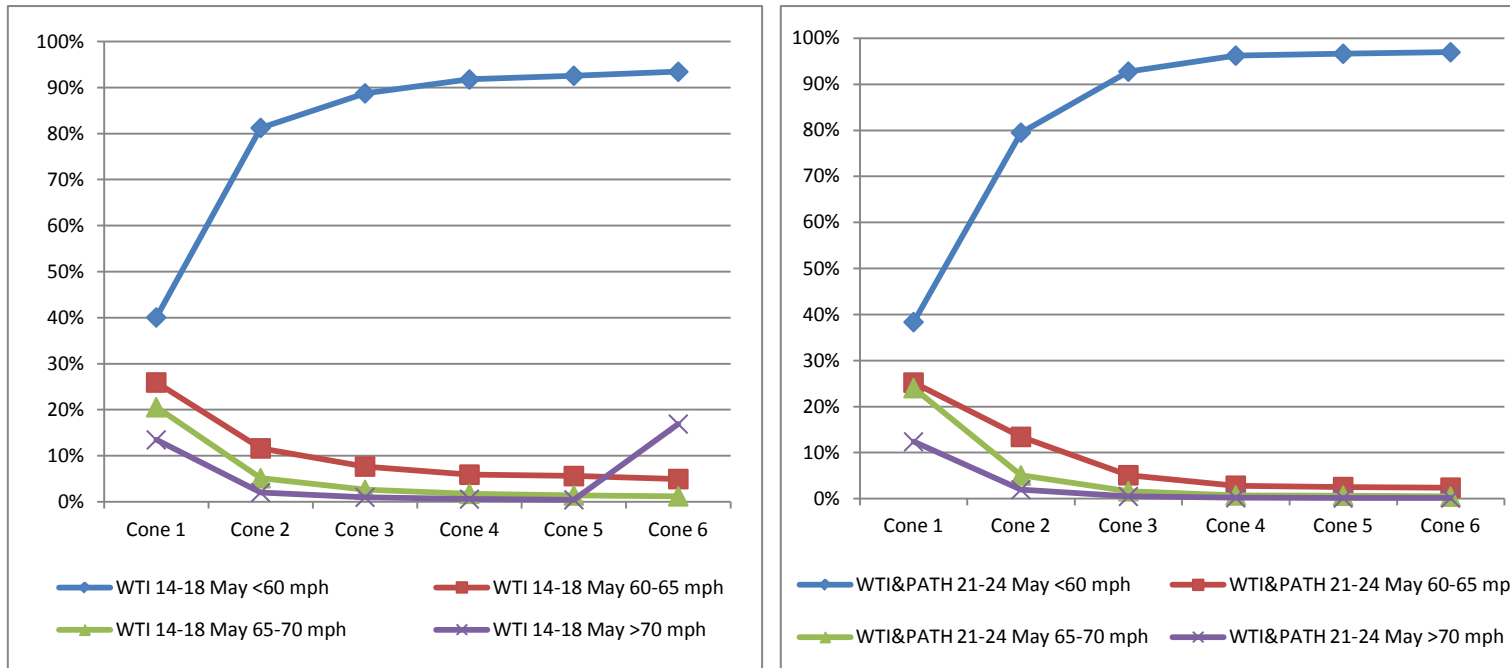
Figure 31. Data Set # 2, Overall Effects of Speed Distribution, Measured by iCones

**Table 6 Data Set #1, Distribution of Vehicle Speeds, Grouped by Weeks (Deployment Types), Cone Numbers, and Speed Bins**

WTI 14-18 May					WTI&PATH 21-24 May					PATH 30 May 1 June					Baseline 4-8 June				
	<60 mph	60-65 mph	65-70 mph	>70 mph		<60 mph	60-65 mph	65-70 mph	>70 mph		<60 mph	60-65 mph	65-70 mph	>70 mph		<60 mph	60-65 mph	65-70 mph	>70 mph
Cone 1	40%	26%	21%	13%	Cone 1	38%	25%	24%	12%	Cone 1	33%	24%	24%	19%	Cone 1	36%	24%	24%	16.43%
Cone 2	81%	12%	5%	2%	Cone 2	80%	13%	5%	2%	Cone 2	79%	13%	5%	2%	Cone 2	75%	16%	6%	2%
Cone 3	89%	8%	3%	1%	Cone 3	93%	5%	2%	0%	Cone 3	89%	8%	3%	1%	Cone 3	85%	10%	3%	1%
Cone 4	92%	6%	2%	1%	Cone 4	96%	3%	1%	0%	Cone 4	93%	6%	1%	0%	Cone 4	87%	9%	3%	1%
Cone 5	93%	6%	1%	0%	Cone 5	97%	3%	1%	0%	Cone 5	93%	6%	1%	0%	Cone 5	89%	8%	2%	0%
Cone 6	93%	5%	1%	17%	Cone 6	97%	2%	0%	0%	Cone 6	93%	5%	1%	0%	Cone 6	94%	5%	1%	0%

Prompted by the initial analysis, we take a closer look at the data from a different angle, as shown in the table above. This allows us to uncover the effects of multiple system deployments across all the cones -- individually as well as against each other -- providing insight into the variation in speed as vehicles move through the work zone.





**Figure 32. Data Set #1, Distribution of Vehicle Speeds, Grouped by Weeks (Deployment Types), Cone Numbers and Speed Bins**

The figures above show each of the systems -- WTI, WTI-PATH, PATH and the baseline across the work zone. We see a logical distribution of speed as the vehicles traverse the work zone. The percentage of vehicles in the lowest speed bin of less than 60mph increases as vehicles proceed from the start to the end of the work zone. This is complemented by a decrease in the three higher speed bins as vehicles progress through the work zone. There is also a finite benefit, when compared to baseline conditions, of using the aSE system in “calming” the traffic.

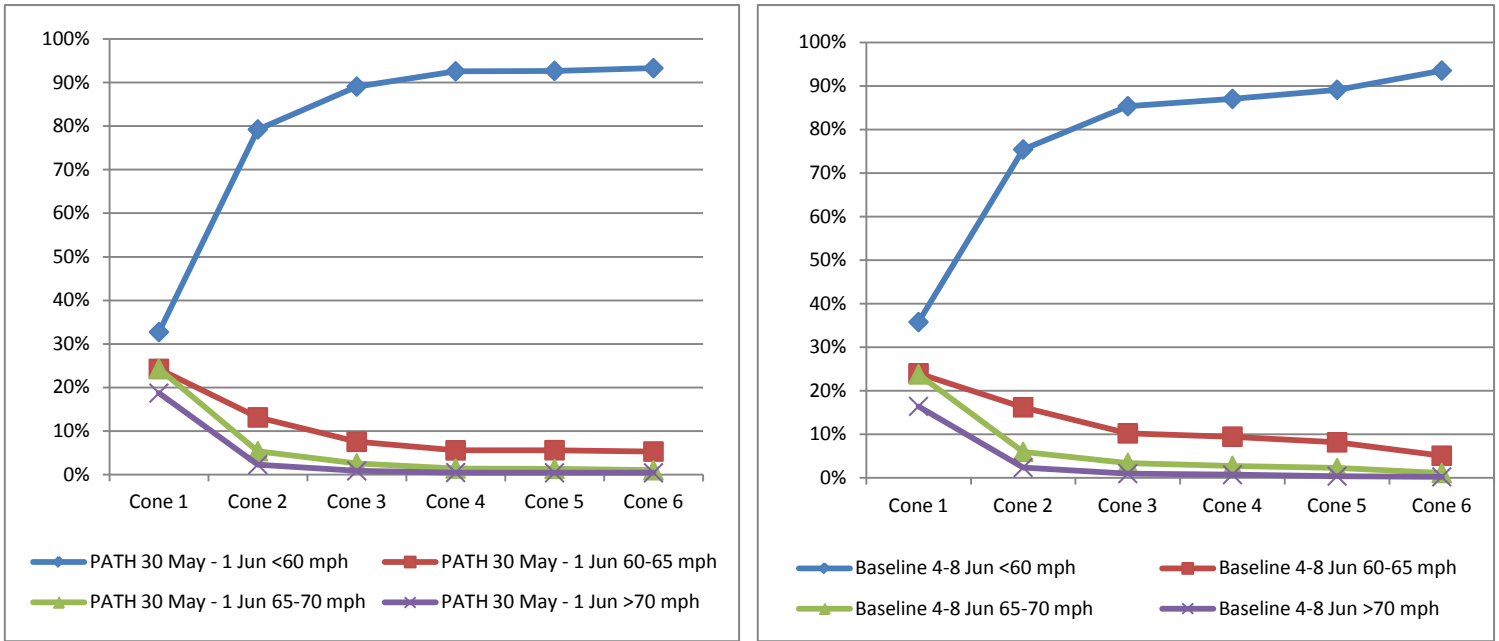


Figure 33. Data Set #1, Distribution of Vehicle Speeds, Grouped by Weeks (Deployment Types), Cone Numbers, and Speed Bins

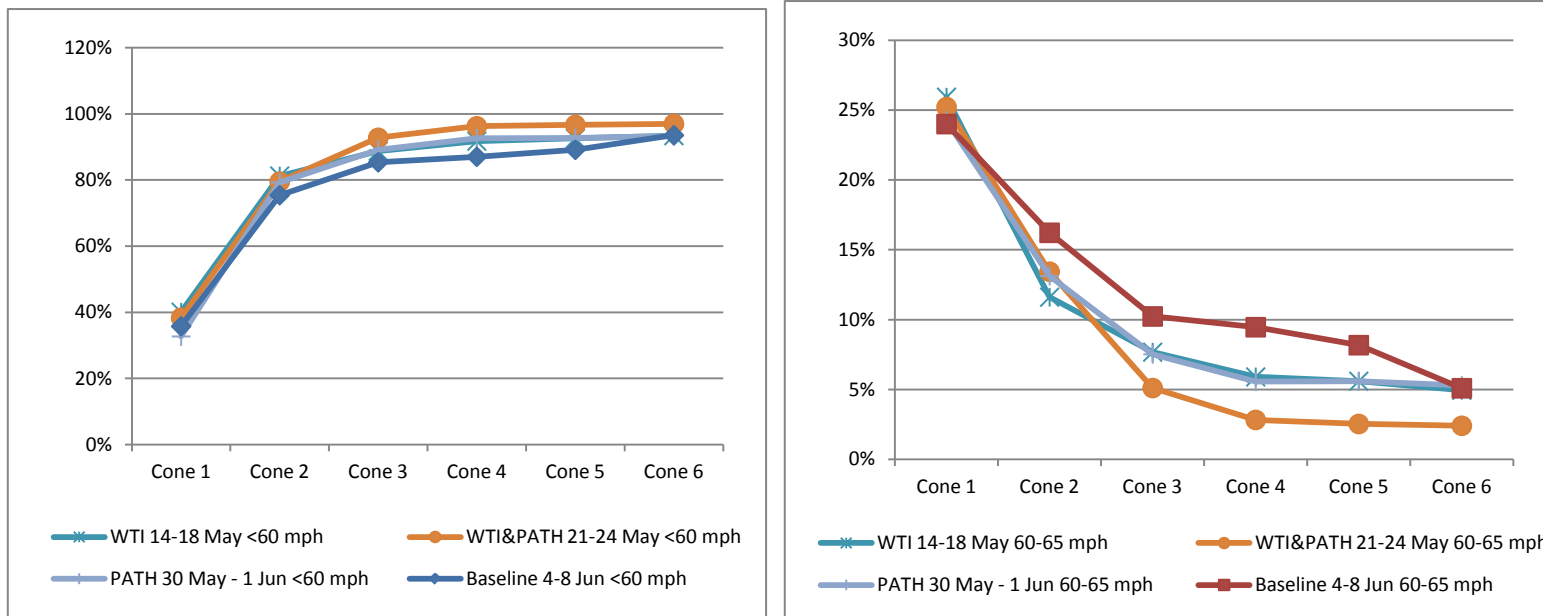
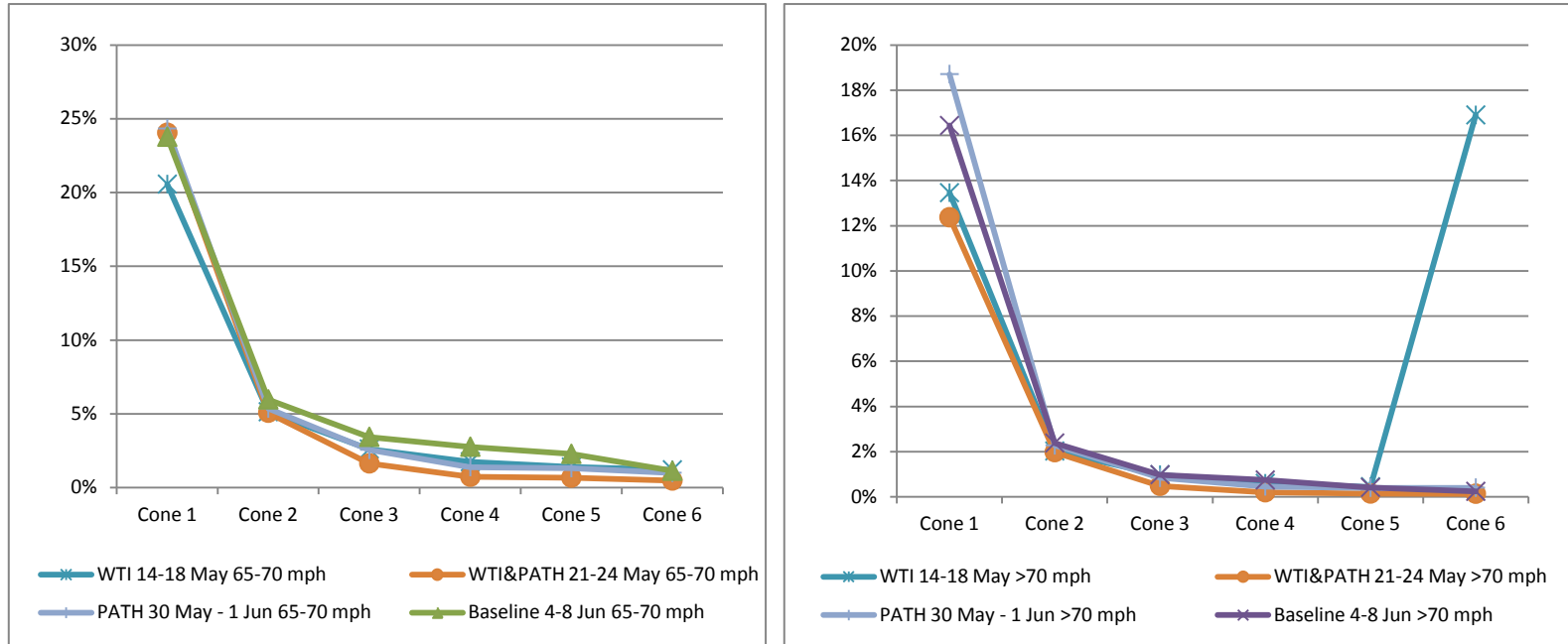


Figure 34. Data Set #1, Cumulative Distribution of Vehicle Speeds, Grouped by Weeks (Deployment Types), Cone Numbers, and Speed Bins



**Figure 35. Data Set #1, Cumulative Distribution of Vehicle Speeds, Grouped by Weeks (Deployment Types), Cone Numbers, and Speed Bins**

In the figures above we see that the joint WTI-PATH system is producing the most desirable effect by increasing the percentage of lower-speed vehicles through the work zone, as well as decreasing the percentage of higher-speed vehicles. According to this data, the combined system was the most effective, followed by the individual systems. The data showed finite improvement over the baseline condition.

**Table 7 Data Set #1, Distribution of Vehicle Speeds, Grouped by Weeks (Deployment Types), Cone Numbers, and Speed Bins**

	WTI 11-15 June					WTI&PATH 18-22 June					PATH 25-29 June					Baseline 9-13 July			
	<60	60-65	65-70	>70		<60	60-65	65-70	>70		<60	60-65	65-70	>70		<60	60-65	65-70	>70
	mph	mph	mph	mph		mph	mph	mph	mph		mph	mph	mph	mph		mph	mph	mph	mph
<b>Cone 1</b>	35.4952	25.03267	23.07895	16.3931	<b>Cone 1</b>	37.876	23.97605	22.4992	15.647	<b>Cone 1</b>	37.996	23.2157	22.38045	16.407	<b>Cone 1</b>	32.577	24.2129	24.8592	18.350
<b>Cone 2</b>	75.8176	15.83765	6.102559	2.24209	<b>Cone 2</b>	78.043	13.88024	5.62070	2.4554	<b>Cone 2</b>	78.931	13.9175	5.236577	1.9140	<b>Cone 2</b>	78.079	13.8683	5.82554	2.2268
<b>Cone 3</b>	86.9968	9.260487	2.866347	0.87633	<b>Cone 3</b>	90.825	6.24644	2.22640	0.7012	<b>Cone 3</b>	91.314	6.47185	1.735878	0.4777	<b>Cone 3</b>	87.217	8.68532	3.08058	1.0170
<b>Cone 4</b>	91.8697	6.154077	1.456903	0.51925	<b>Cone 4</b>	94.247	4.148322	1.18001	0.4243	<b>Cone 4</b>	95.316	3.42126	1.010507	0.2512	<b>Cone 4</b>	87.541	9.32756	2.34047	0.7902
<b>Cone 5</b>	92.7597	5.516786	1.331279	0.39216	<b>Cone 5</b>	94.329	4.293886	1.06836	0.3084	<b>Cone 5</b>	95.797	3.12858	0.857728	0.2158	<b>Cone 5</b>	91.728	6.19934	1.59963	0.4722
<b>Cone 6</b>	94.4022	4.599577	0.783639	0.21452	<b>Cone 6</b>	95.157	3.628998	0.92068	0.2924	<b>Cone 6</b>	96.093	3.12824	0.545872	0.2325	<b>Cone 6</b>	95.930	3.16445	0.76290	0.1421

Similar to the first data set, here we take a look at the second set of data from a different angle, as shown in the table above. This allows us to uncover the effects of multiple system deployments across all the cones, individually, as well as against each other, providing insight into variations in speeds as vehicles move through the work zone.

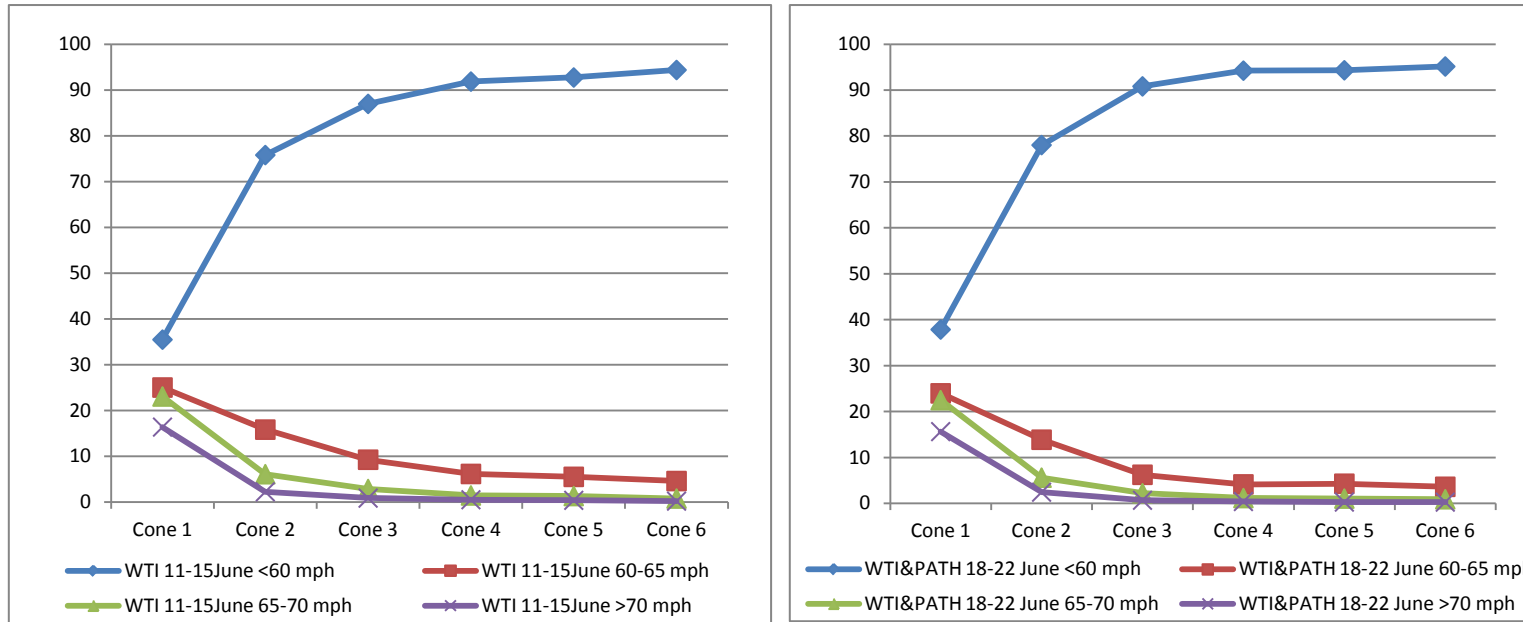
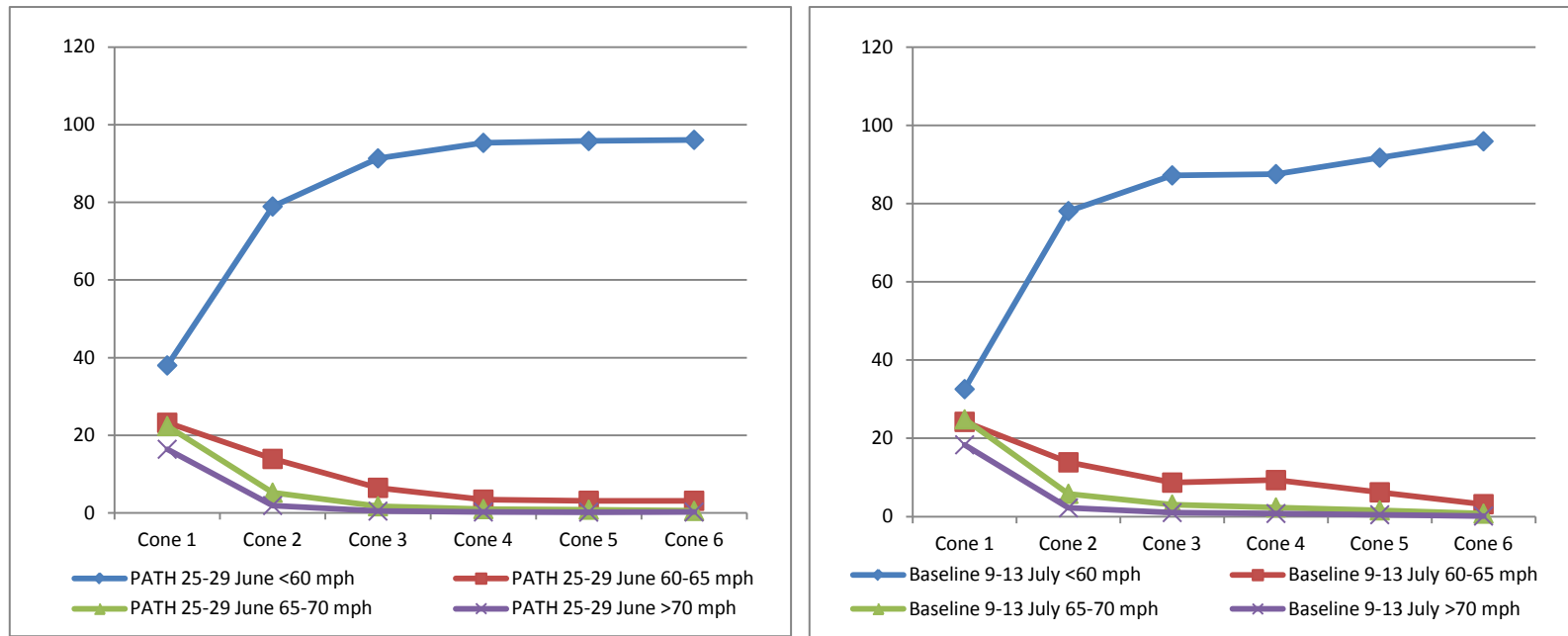


Figure 36. Data Set #2, Distribution of Vehicle Speeds, Grouped by Weeks (Deployment Types), Cone Numbers, and Speed Bins



**Figure 37. Data Set #2, Distribution of Vehicle Speeds, Grouped by Weeks (Deployment Types), Cone Numbers and Speed Bins**

The figures above show each of the systems -- WTI, WTI-PATH, PATH and the baseline across the work zone. Consistent with the first set, we see a logical distribution of speed as the vehicles traverse the work zone. The percentage of vehicles in the lowest speed bin of less than 60mph increases as the vehicles proceed from the start to the end of the work zone. This is complemented by a decrease in the three higher speed bins as the vehicles progress through the work zone. There is also a finite benefit over the baseline, of using the aSE system in “calming” the traffic.

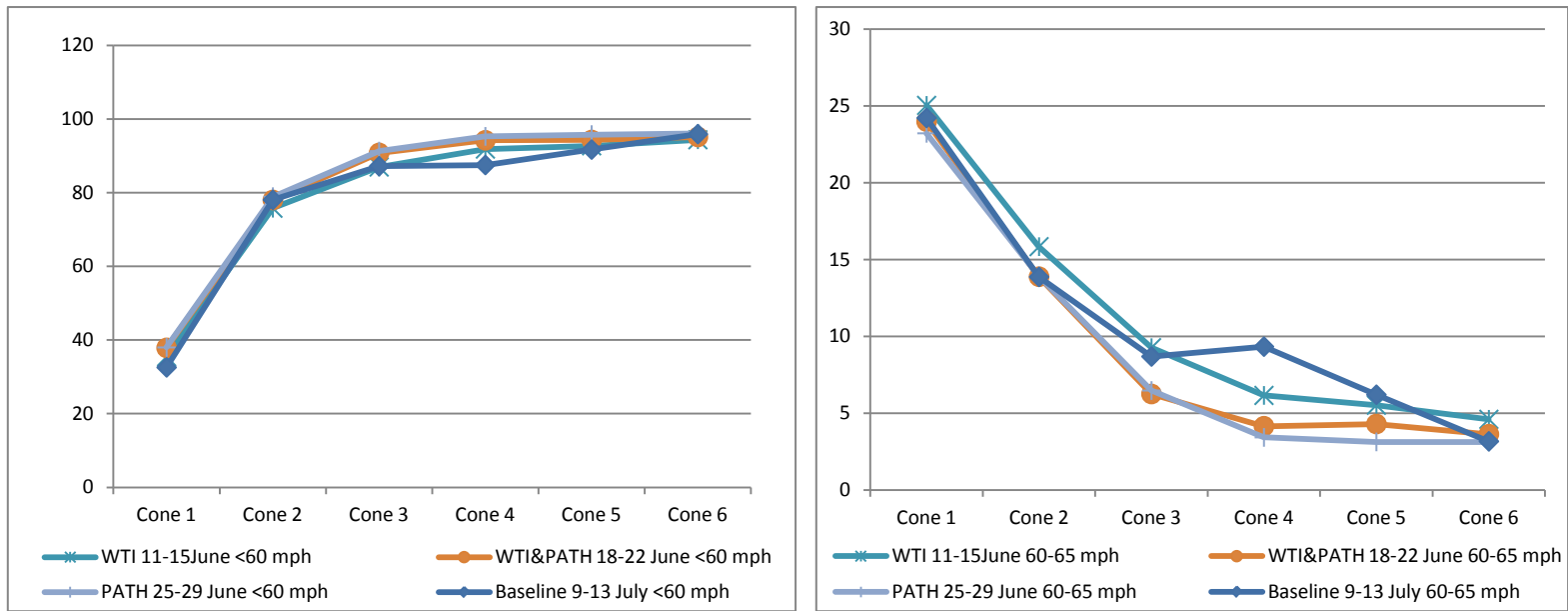
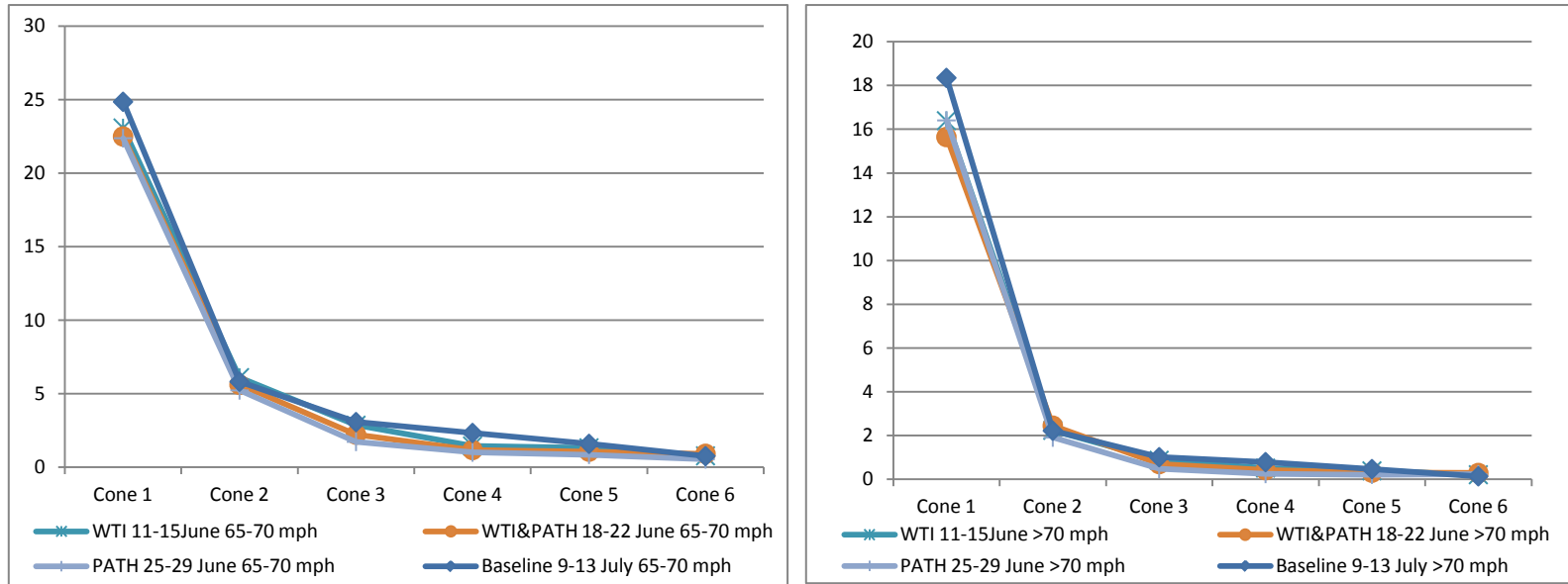


Figure 38. Data Set #2, Cumulative Distribution of Vehicle Speeds, Grouped by Weeks (Deployment Types), Cone Numbers, and Speed Bins





**Figure 39. Data Set #2, Cumulative Distribution of Vehicle Speeds, Grouped by Weeks (Deployment Types), Cone Numbers and Speed Bins**

In the figures above, the data in the second set suggests there is an increased benefit of the PATH system, which produced the most desirable effect by increasing the percentage of lower-speed vehicles through the work zone, as well as decreasing the percentage of higher-speed vehicles. According to this data, the PATH system was most effective, followed closely by the combined WTI-PATH system. Here also, the data showed finite improvement over the baseline condition when one of the aSE systems was deployed.

After the detailed analyses of the iCone data we examined the relative effectiveness of the PATH aSE system. We have already discussed that a key measure of effectiveness of this project is the reduction in the percentage of high speed vehicles going over 65mph in the work zone and an increase in the percentage of vehicles going below 60mph, which is much closer to the reduced work zone speed limit of 55mph. The analysis done so far already verifies the efficacy of the PATH aSE system over the baseline condition. But if we carefully examine the work zone layout, shown in Section 4.1, it becomes evident that data related to Cone 4 is most affected by the PATH system. Hence we investigate this data more closely. The result of this analysis show that at this location, the PATH aSE system shows a very significant 68% reduction in the percentage of vehicles travelling over 65mph. and 6% in the percentage of vehicles travelling below 60mph relative to the baseline condition. This information further reconfirms the usefulness and effectiveness of the PATH aSE system.

## **5. Potential Enhancements for Future Design and Implementation**

This section provides a brief review of the technology components, and sub-systems that have been used in this augmented speed enforcement project. It also describes how enhancements and improvements can be accomplished in future design and field implementation. A separate technical report for technology assessment offers more detailed descriptions.

The PATH system was demonstrated to operate according to design intents and specifications, even though it only represents a research prototype for initial field tests. The primary advantages that were observed for the current systems are as follows:

- All components and sub-systems are implemented with a concept of modular design to the fullest extent. This approach allows the replacement or substitution of elements whenever necessary. It also minimizes the potential drawback of components becoming obsolete or being limited to local operational constraints.
- All sub-components are acquired or procured to meet system requirements and state-of-the-art standards. They each, therefore, offer good performance.
- The system integration was significantly enhanced by the strong support of component and sub-system providers. Through this close collaboration with vendors, the PATH system could be fine-tuned and improved on site to meet various necessary adjustment requirements.
- The speed camera unit has a touch-screen interface that enables the adjustments of speed thresholds and other operating parameters. This is a big plus.

While the developed system performed satisfactorily during the field test, there is room for future improvements or enhancements. If there are opportunities for deployment in the future, based on field experience we have gathered some ideas to be considered. They are described below:

- Communication technologies are likely to evolve in the future and different options may become available. Our current implementation uses a DSRC/Cellular combination that requires the insertion of a cellular-provider SIM card. It will be more flexible in the future to separate the module into a single stand-alone DSRC unit, and a separate cellular unit, which can be adopted in different regions with a cellular modem that offers the best data transmission option.

- We used an iPad to illustrate the portability and ease of displaying information on a stand-alone device. Many tablets or smart phones can serve the same purpose. With the increasing popularity of such devices, choices can be based on the preference and suitability of particular operating systems that the operating agencies choose.
- The speed camera was actually designed with night-time capabilities, even though during our field tests, we only experimented with day-time operations. Camera flash lights, when needed in low ambient light, are preferred when the speed camera is pointed toward the back of vehicles. This reduces driver distraction and avoids affecting visibility. If the speed camera must face oncoming traffic (for example, to capture an image of the driver's face), camera with infrared flash should be considered.
- To overcome the difficulty in LNPR when bright sun or ambient light cause bright reflections off the vehicle, use a camera lens that can reduce light reflections.
- To improve the performance of LNPR, sample sets of photographs can be used to train users on the LNPR software in advance, as specific features of license plates in a region or a country can be better recognized when the software is calibrated.
- In this project, the speed camera is placed on a trailer, which is suitable for work zone deployment on a particular setting, but is still limited in its portability. For general mobile applications, the speed camera unit can be fitted into the back space of a van or utility vehicle.
- During field testing, researchers installed additional Wi-Fi access points connected to the speed camera unit and the changeable message sign. The wireless connection will ideally be part of the standard features that accompany these units in the future.

## 6. Concluding Remarks

This report describes an *augmented Speed Enforcement (aSE)* system that was developed, implemented and field tested by California Partners for Advanced Transportation Technology (**PATH**) of the University of California at Berkeley. The work was conducted under a project sponsored by USDOT with collaboration from California Department of Transportation (**Caltrans**), California Highway Patrol (**CHP**), and Western Transportation Institute (**WTI**) of Montana State University. The project was carried out with the goal of evaluating the effect of reducing traffic speed and minimizing hazards in a work zone in rural areas.

Specifically, the PATH aSE system aims to offer enhanced feedback to drivers so they travel safely under hazardous conditions, such as a work zone, as well as to provide assistance for enforcement officers to carry out their duties. The PATH aSE system includes the integrated use of sensing, computing, and wireless communication technologies. At the leading portion of a work zone, drivers of vehicles traveling above the speed limit are alerted in a timely manner by a changeable message sign that displays their license plate number and vehicle speed. Information about vehicles traveling at excessive speeds is also made accessible by CHP officers who are stationed at the trailing section of the work zone and out of the sight of drivers, allowing the officers to perform their enforcement duties, as deemed appropriate.

Demonstrated as a case study where the aSE system can be suitably deployed, the system was field tested on California State Route 152 near the city of Los Banos. The tests were carried out with the PATH and WTI sub-systems individually and jointly deployed to evaluate the effects of traffic movement in comparison to the baseline of a regular work zone. The four scenarios, baseline, PATH system only, WTI system only, and both systems, were tested for one week

each and the cycle was repeated with a total of eight weeks of data collected. During this period, Caltrans maintenance crew performed regular maintenance work on a stretch of SR-152 on a rotating basis.

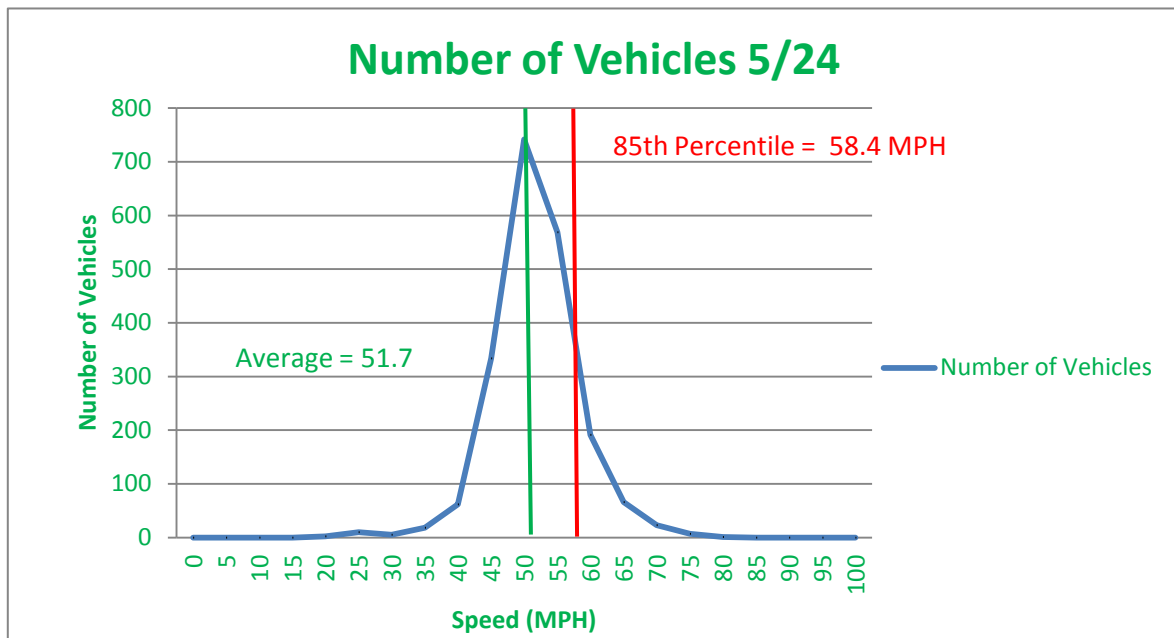
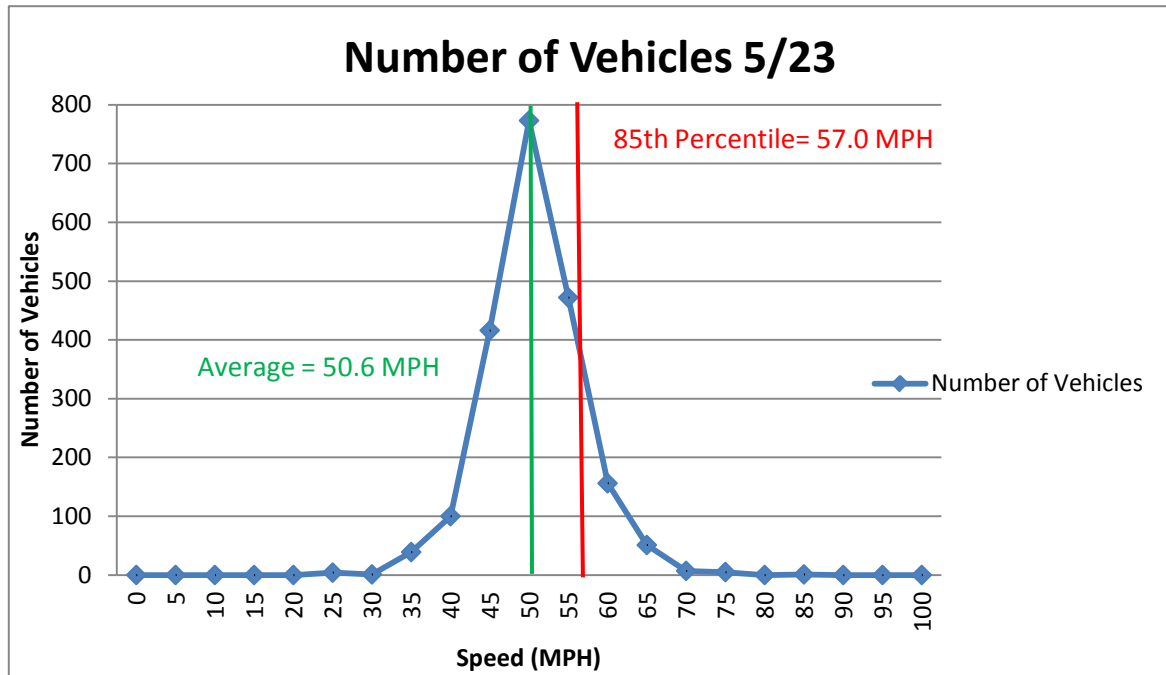
Results from the field tests, as summarized in the data analysis section of this report, show that the system was indeed effective in reducing the number of speeding vehicles. Based on the iCones data that were placed throughout the work zone for the duration of the field tests, the percentage of vehicles traveling in excess of 65 mph was significantly reduced. For example, the summation of percentage of vehicles moving faster than 65-mph from all six iCones decreased from 60.23% in the baseline scenario to 54.13% in the scenario when the PATH aSE system was in place. This denotes a 10% reduction in vehicles travelling over 65mph in the work zone, relative to baseline conditions. Specifically, data at the 4<sup>th</sup> iCone, which captures the most relevant effects of the PATH aSE system, shows a very significant 68% reduction in the percentage of vehicles travelling over 65mph. We also noticed an increase of approximately 6% in the percentage of vehicles travelling below 60mph at the 4<sup>th</sup> iCone. These reductions of higher speed vehicles and increase of lower speed vehicles are measured relative to the baseline condition. These results further highlight the effectiveness of the PATH aSE system.

PATH also carried out additional field testing activities to support the utilization of Dedicated Short-Range Communication (DSRC) for the augmented speed enforcement (aSE) project. The main objective of this DSRC experiment is to identify the effective range up to which DSRC can support the requirements of the aSE project. Secondary objectives would be to verify the benefit and necessity of specialized antenna and cables in extending the range along with the utility of using a repeater. The tests were executed in a suburban and rural setting in the city of Petaluma, CA. The details of DSRC testing are provided in Appendix E.

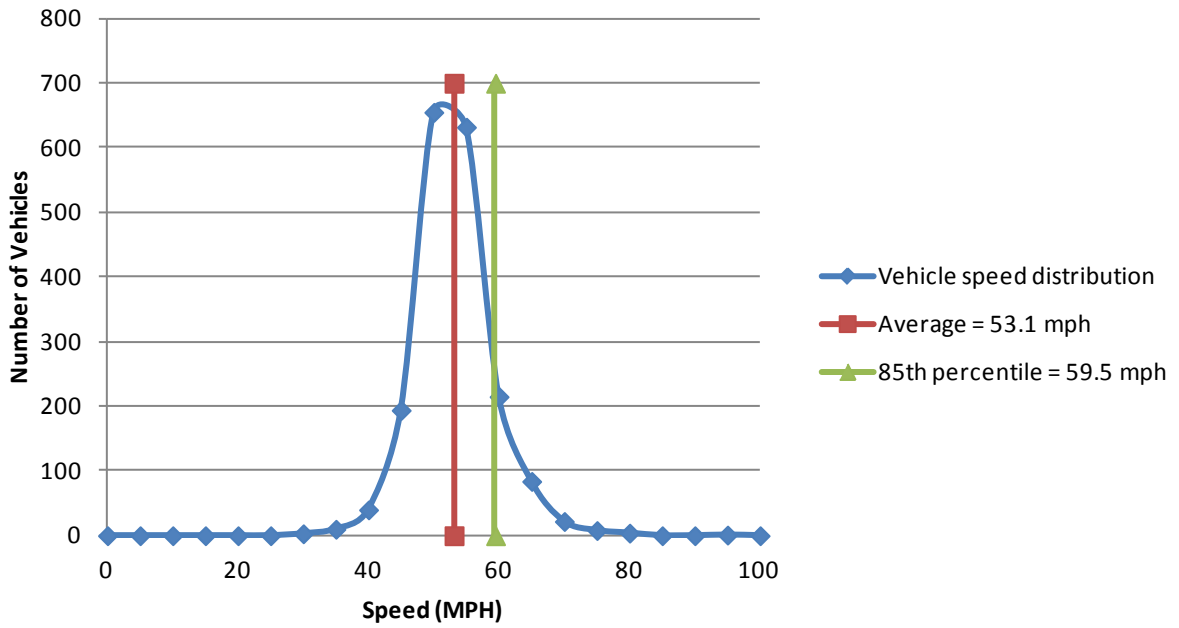
The PATH aSE system developed and validated in this project have the potential to be deployed for a wide range of highway segments, either in rural or urban areas. At locations where speeding is a concern, the augmented speed enforcement can be used to provide timely and enhanced driver feedback, achieving the primary objective of reducing traffic speeds to avoid hazards. Significantly, enforcement duties remain in the hands of officers, and the use of this system does not lead to legislative concerns in jurisdictions where automated functions are prohibited.

## Appendix A – Speed Distribution of Traffic Data, Measured by Speed Camera

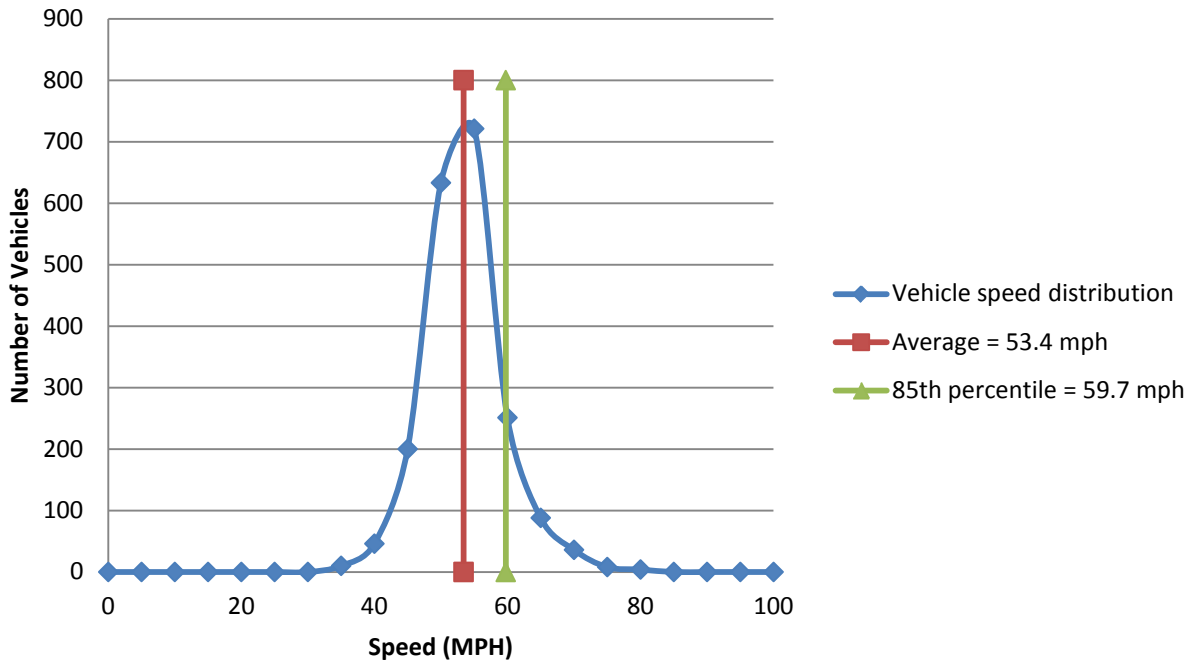
The data shown in this Appendix is a continuation of those presented in Section 4.2.1, but an extended set of data over multiple days are depicted here for comparison and reference.



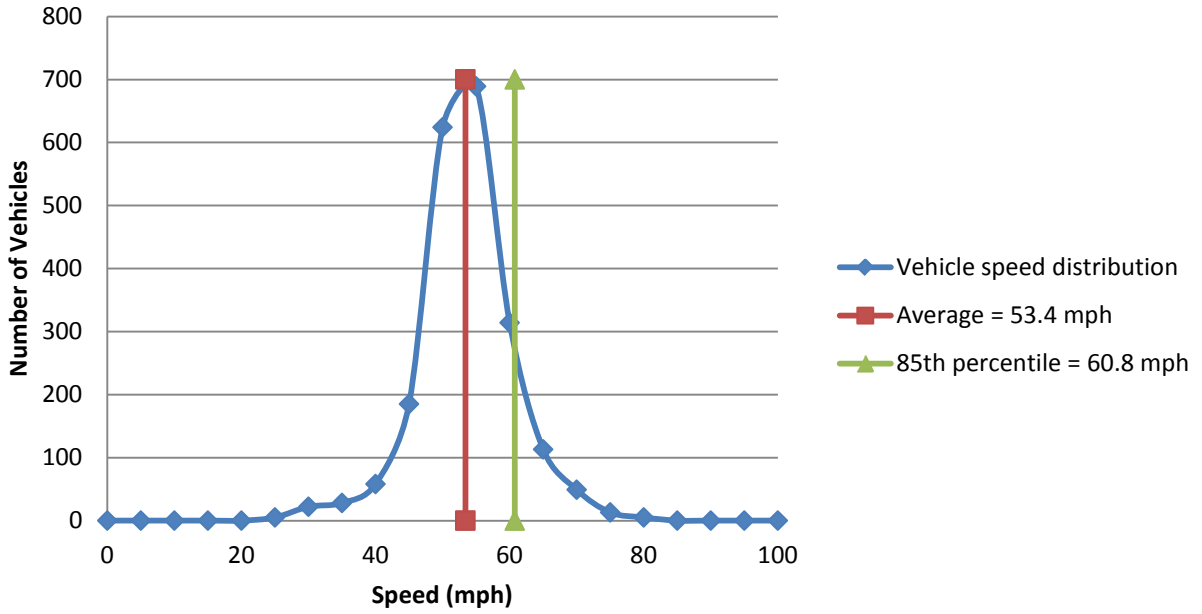
### 5/30 Speed Distribution



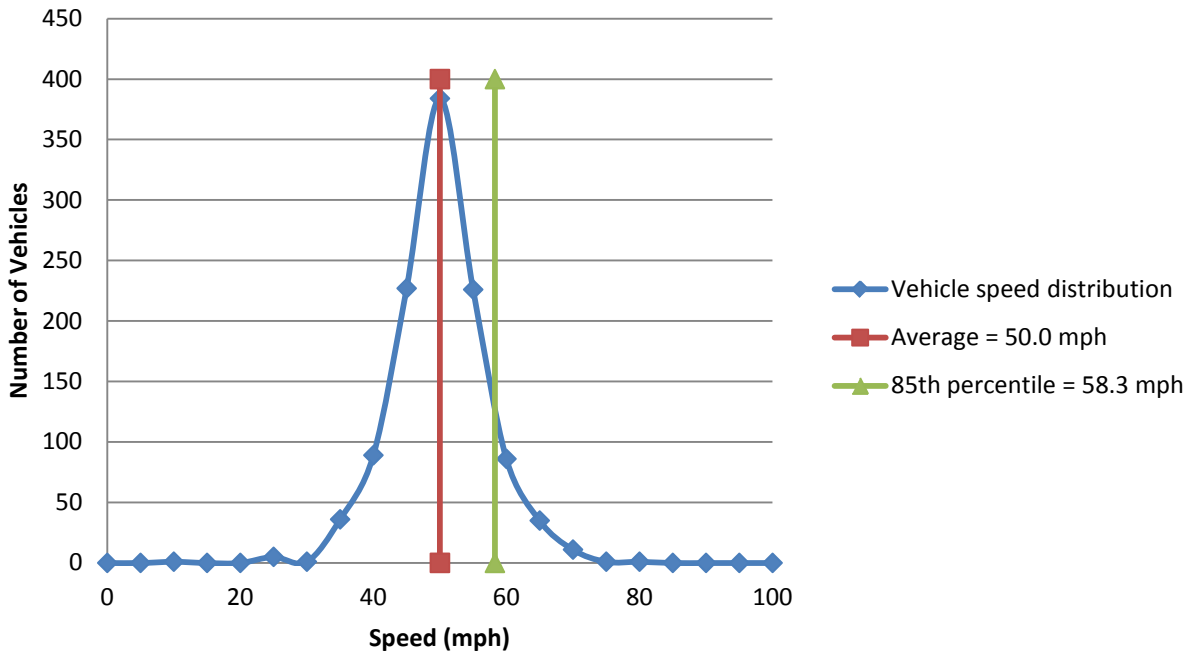
### 5/31 Speed Distribution



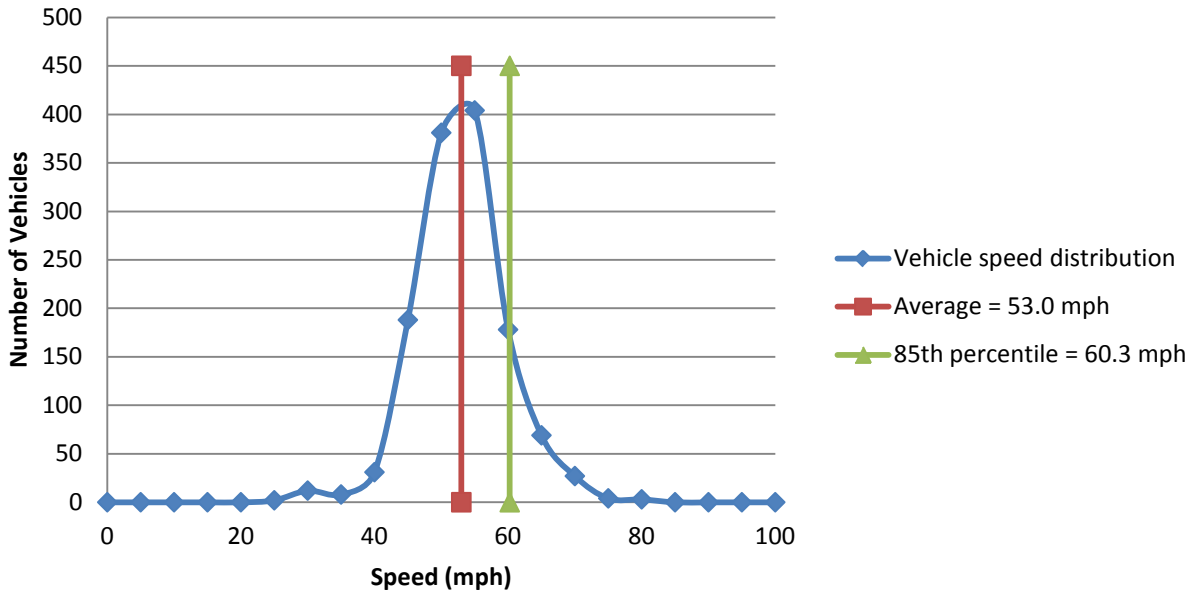
### 6/1 Speed Distribution



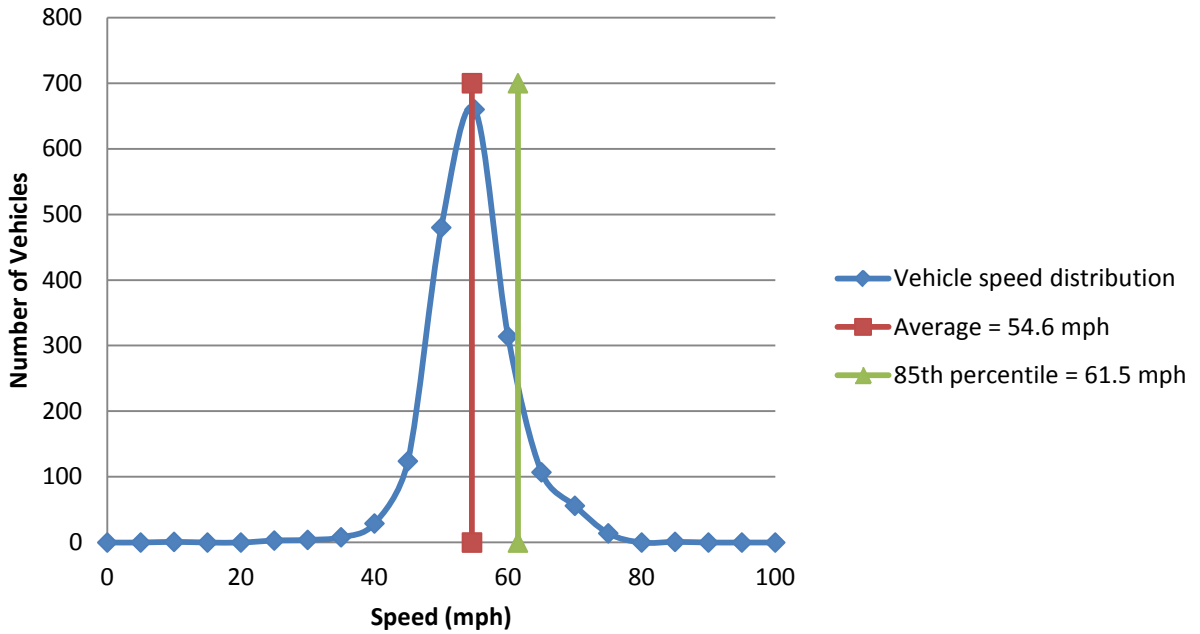
### 6/18 Speed Distribution



### 6/19 Speed Distribution

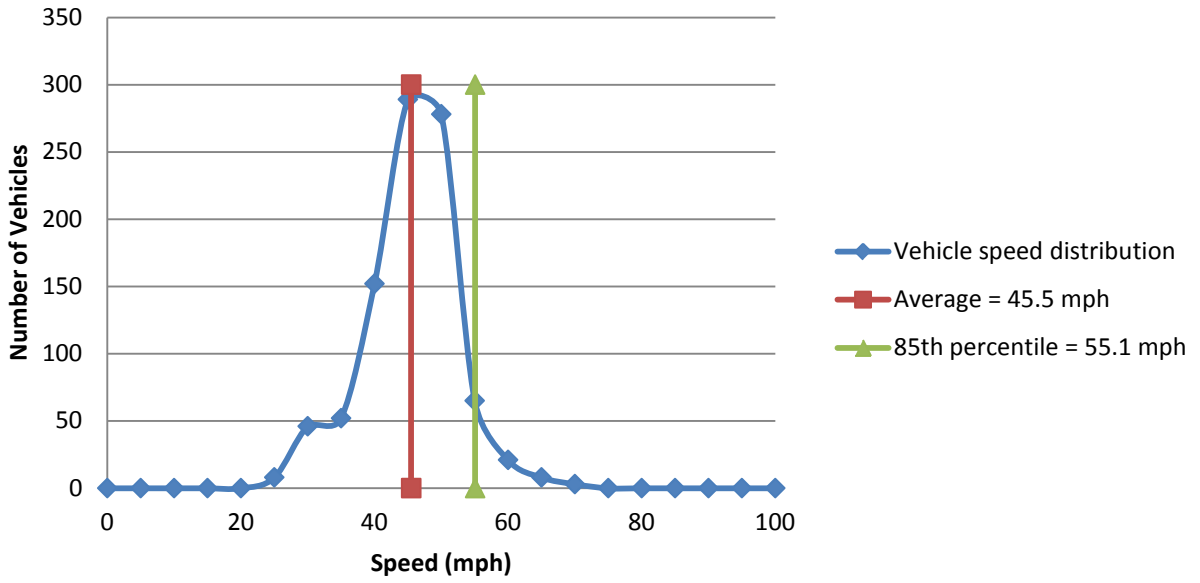


### 6/20 Speed Distribution

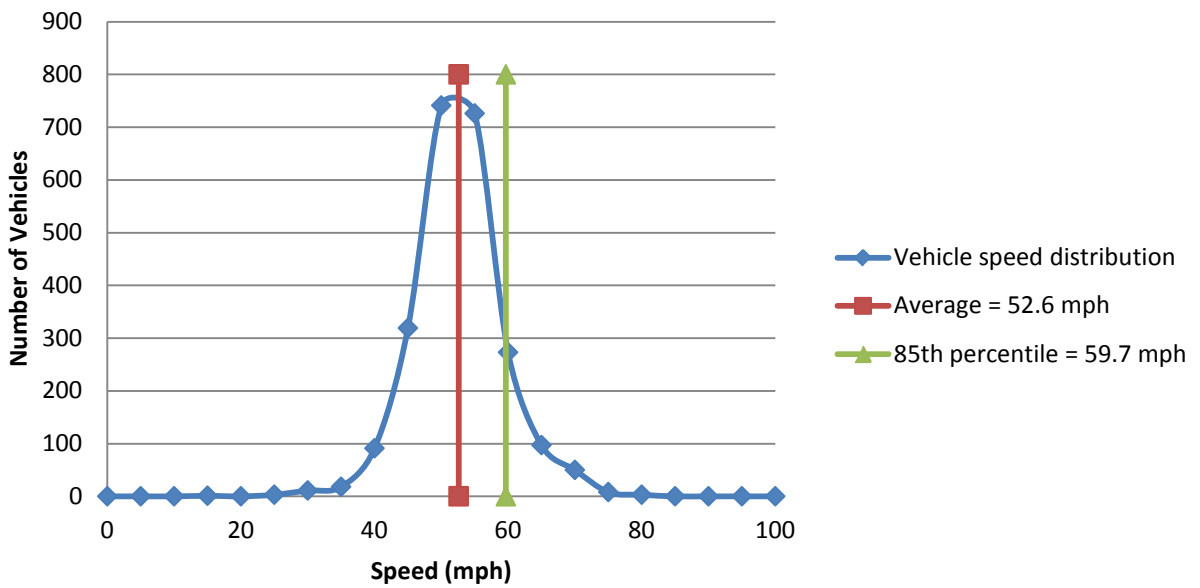




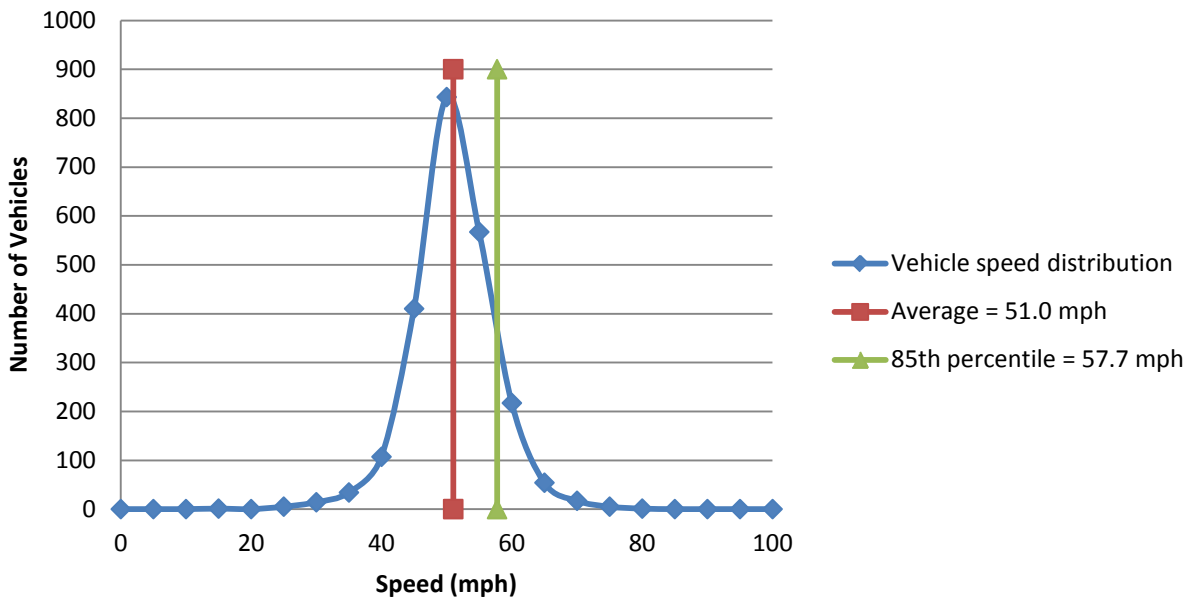
### 6/21 Speed Distribution



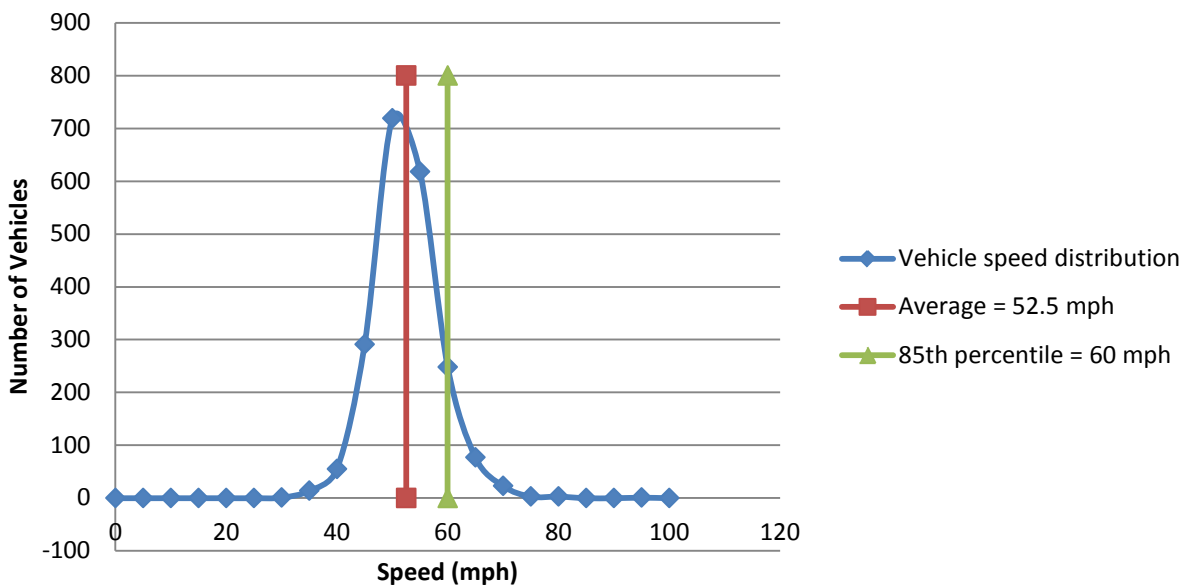
### 6/22 Speed Distribution



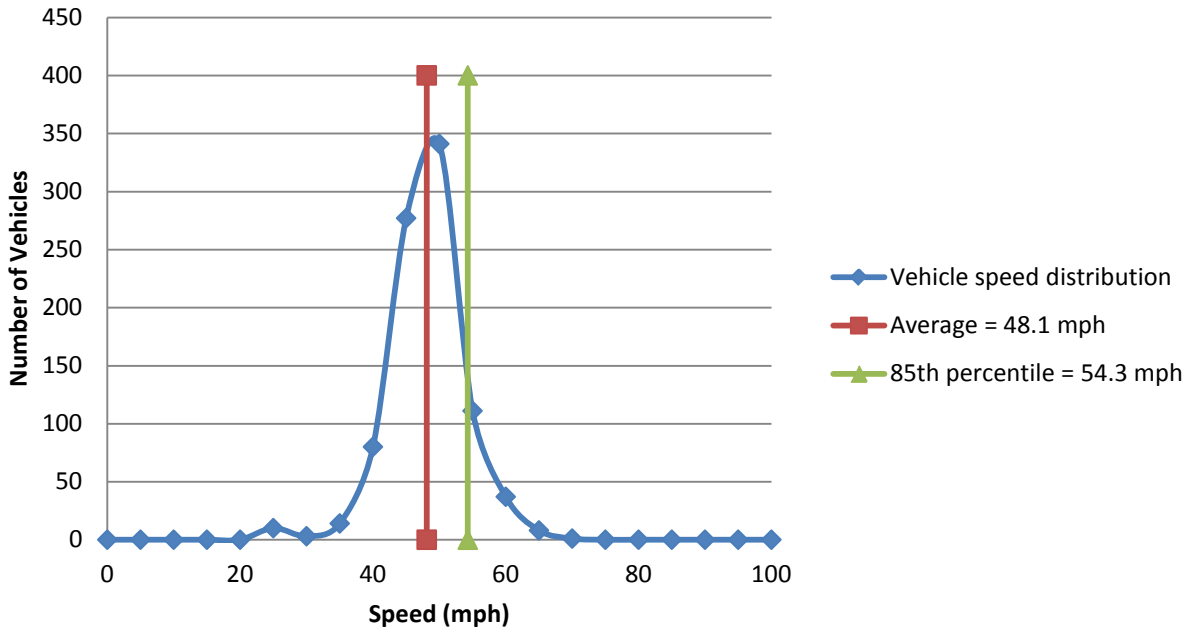
### 6/25 Speed Distribution



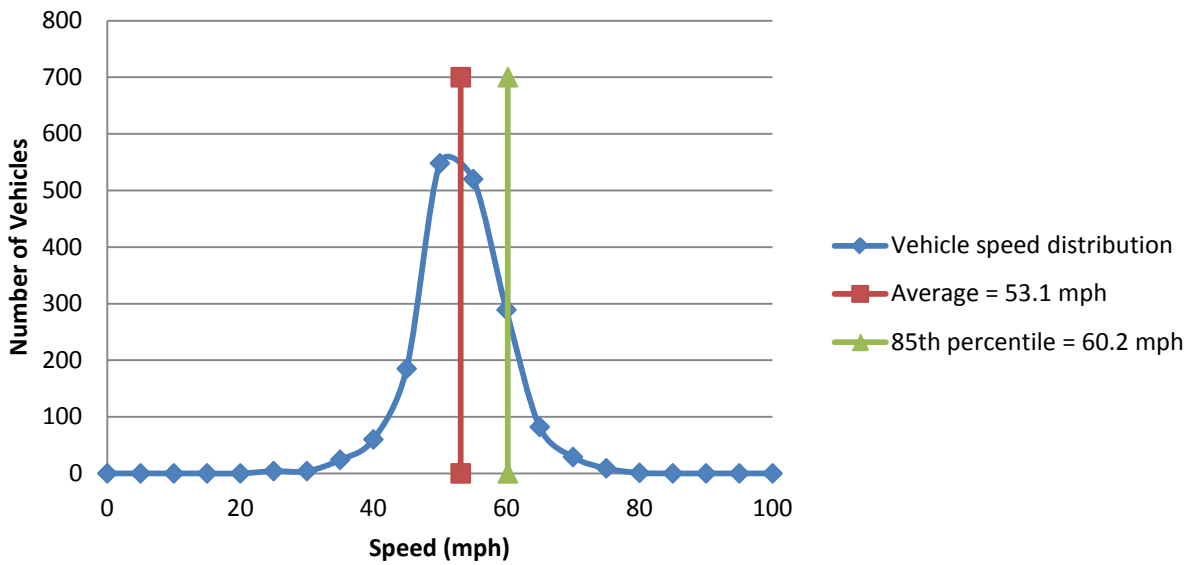
### 6/26 Speed Distribution



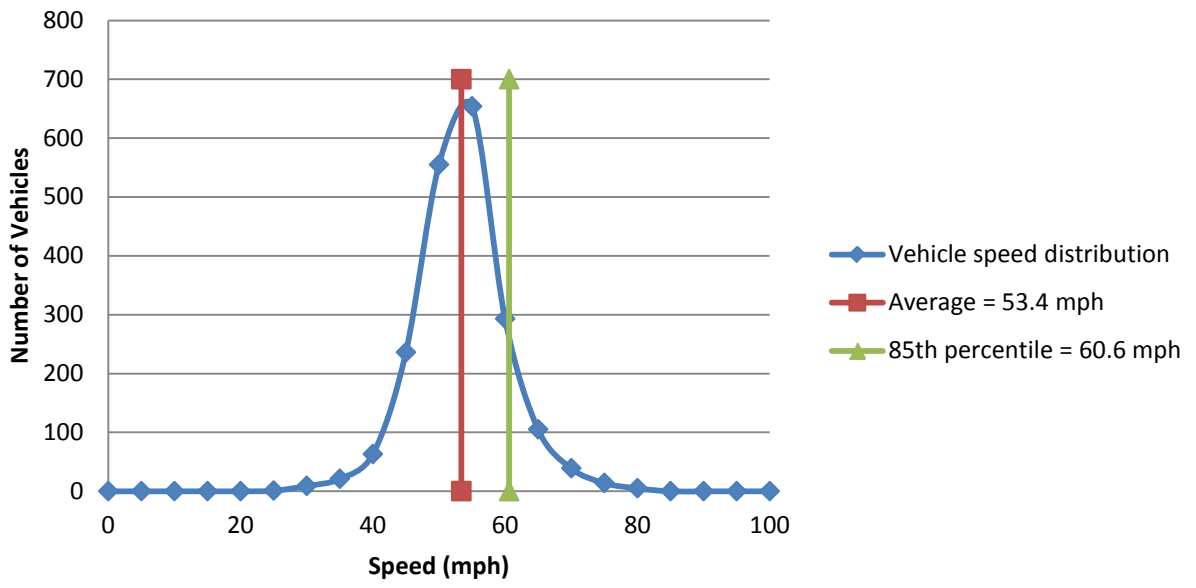
### 6/27 Speed Distribution



### 6/28 Speed Distribution



# 6/29 Speed Distribution

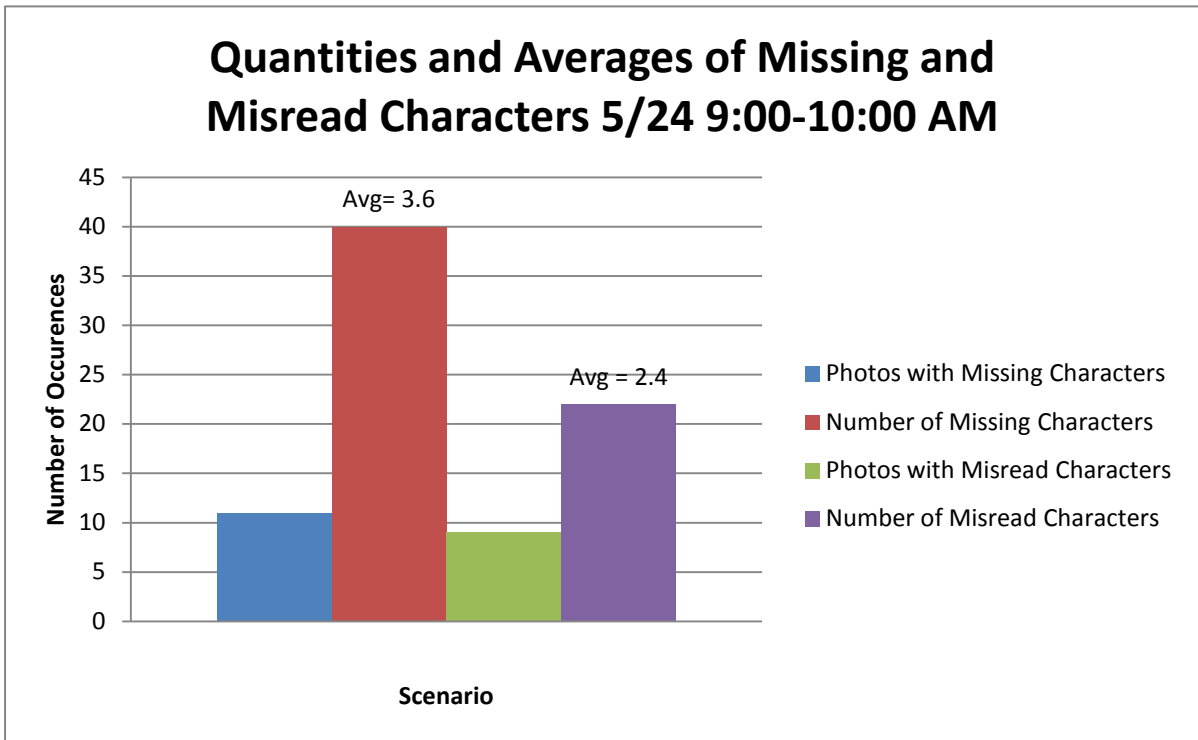
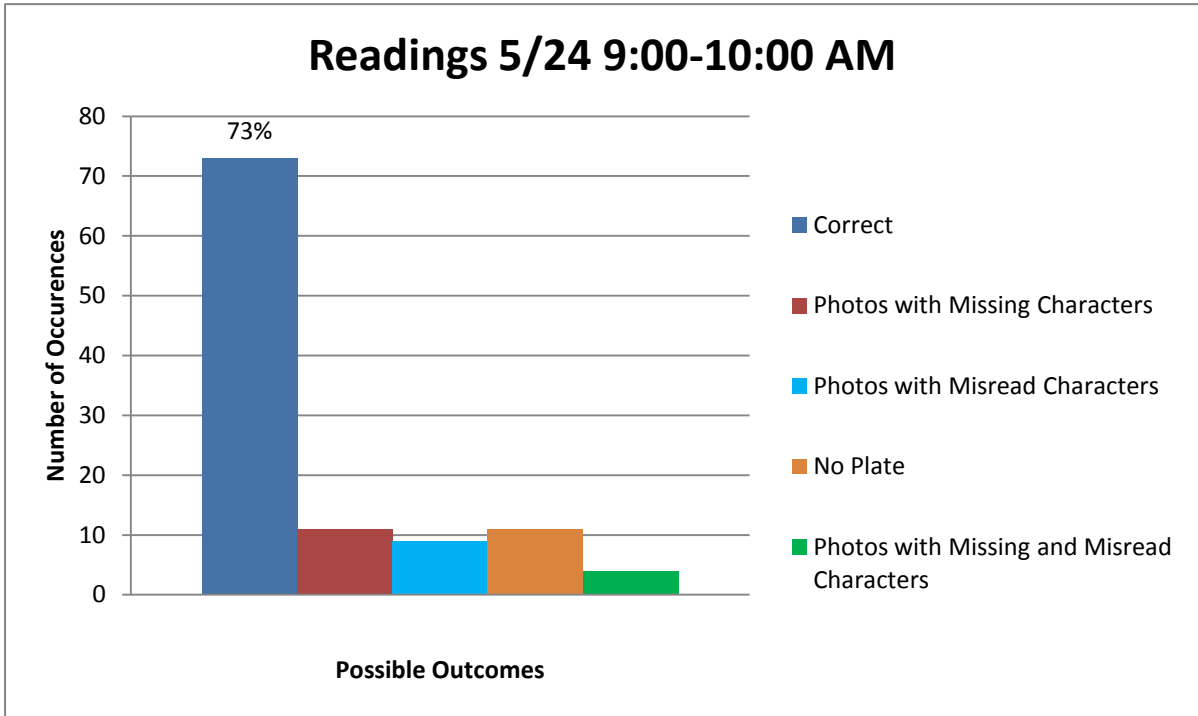


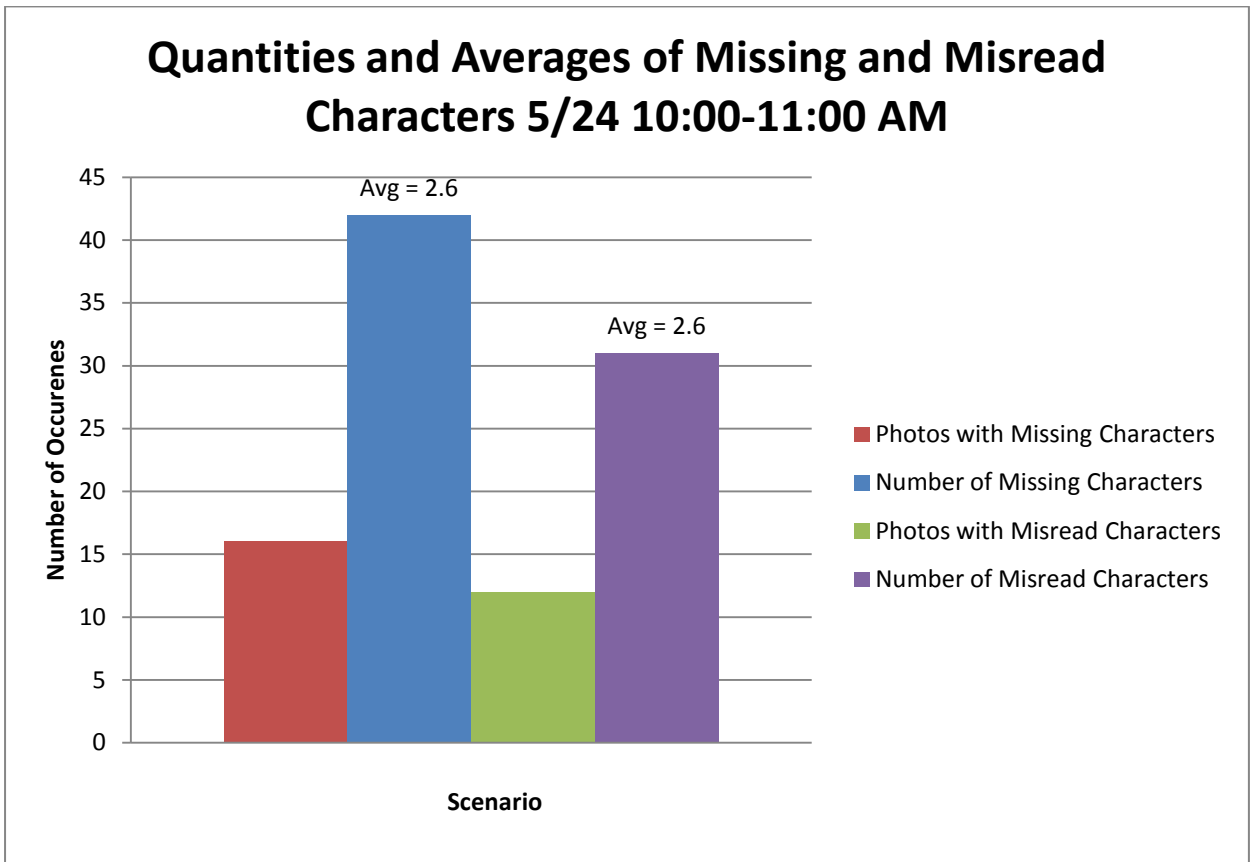
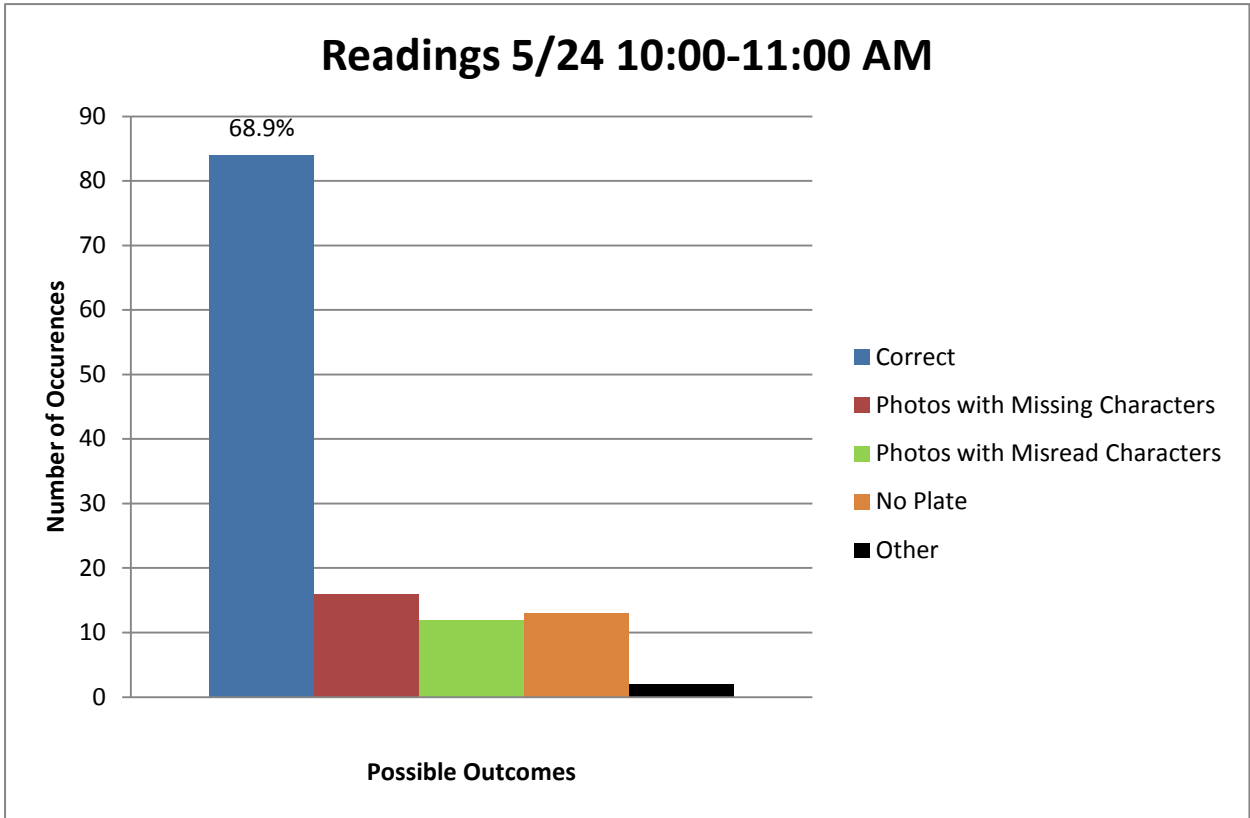
## Appendix B – Data Samples of License Plate Recognition

Results of data analysis from the license plate number recognition are given in this Appendix to illustrate the variation in its accuracy. More technical discussions can be found in Section 4.2.2.

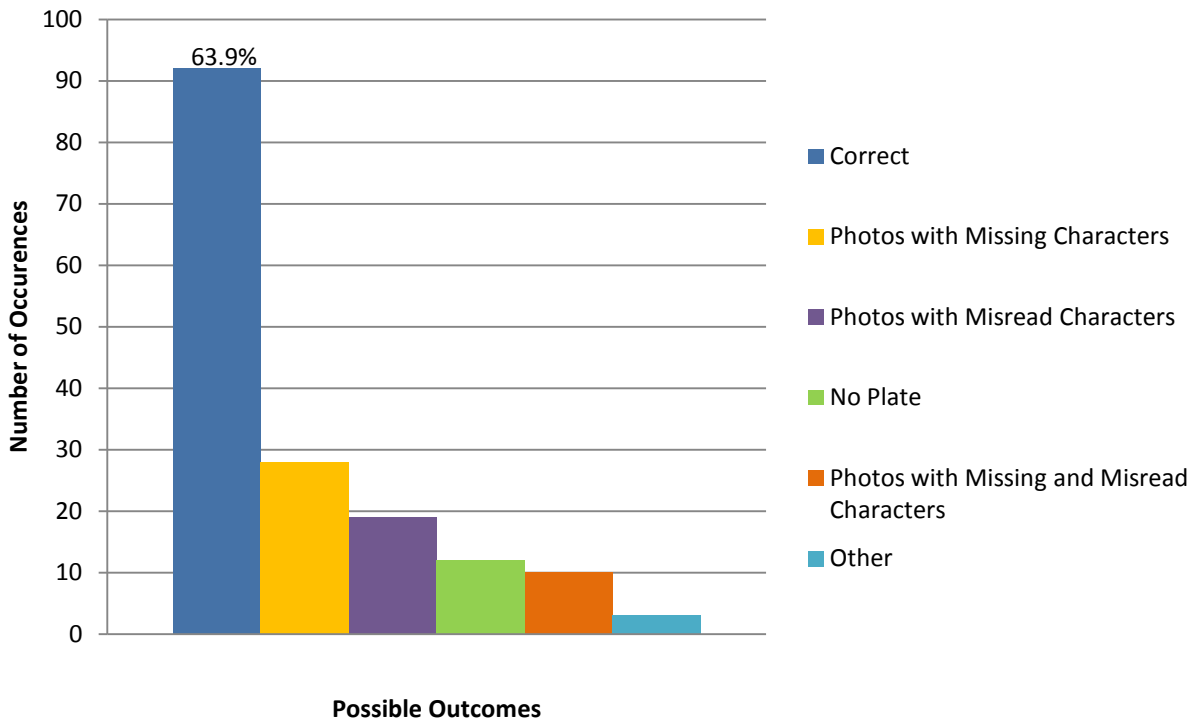
Each data set in the figures below represents one hour of data collected in the field. Note that only the vehicles moving beyond the speed threshold (work zone speed limit at 55 mph) were photographed. There are two figures for each data set. The first figure shows the counts of five scenarios: totally correct recognition, missing characters, misread characters, or both, and no plate. On the top of the leftmost column, a percentage number was given to indicate the “accuracy” performance that the LPNR system was able to achieve. The second figure shows the number of missed character recognition within the license plate numbers for each of the two cases: misread or totally missed. The vertical axis gives the reading of how frequently each case occurs, while a labeling within the bar chart gives a number of “AVG = x.x” at the top of the adjacent bars indicates how many character recognition errors were made.

May 24, 2012

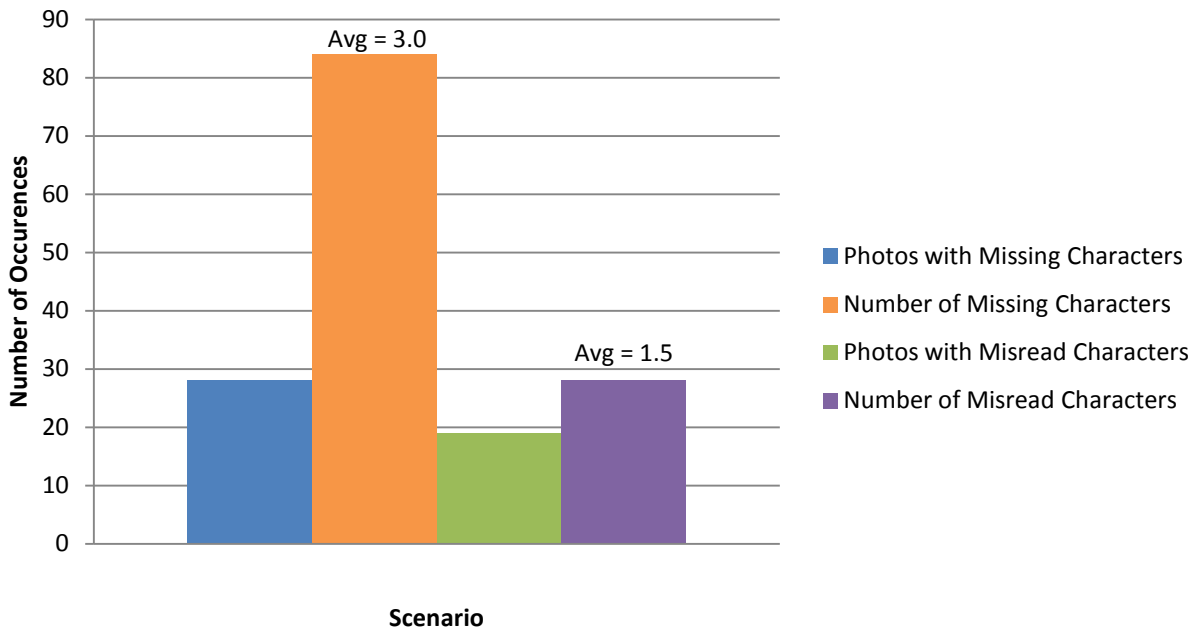




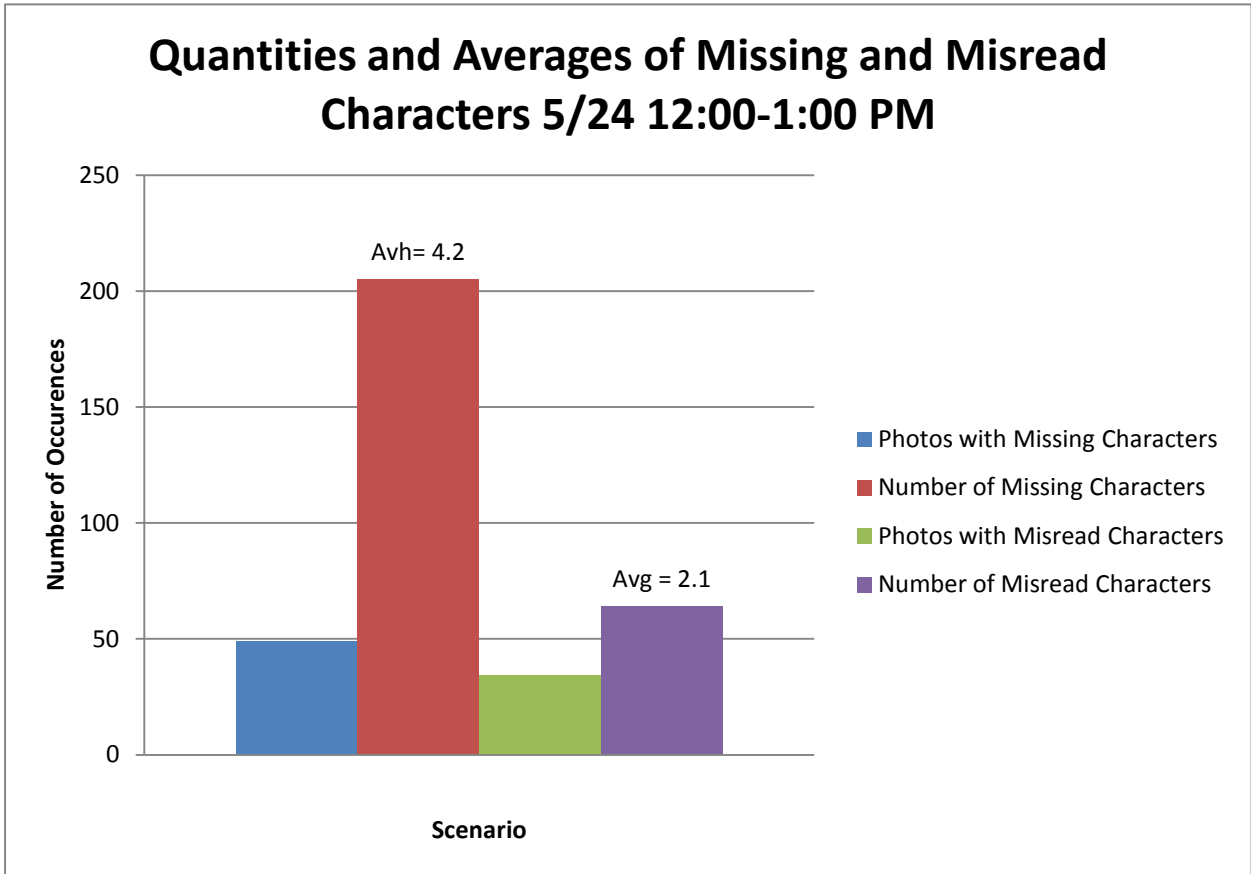
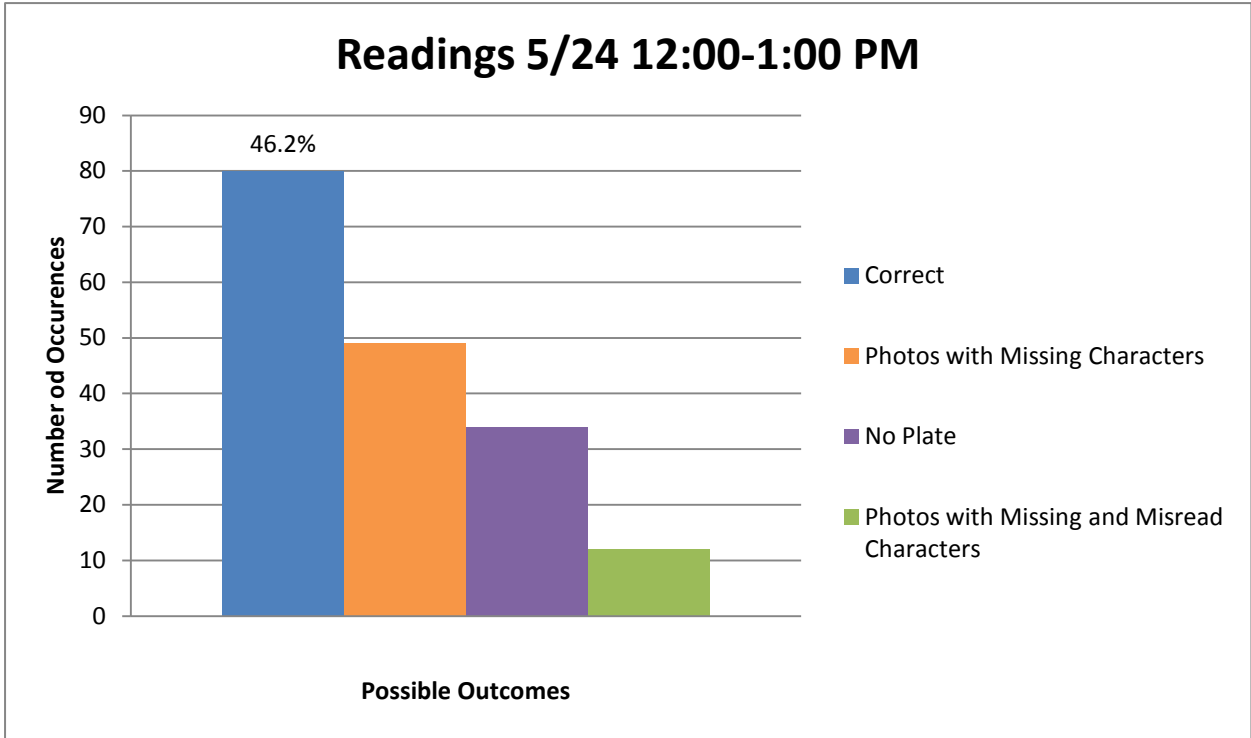
### Readings 5/24 11:00-12:00 AM-noon

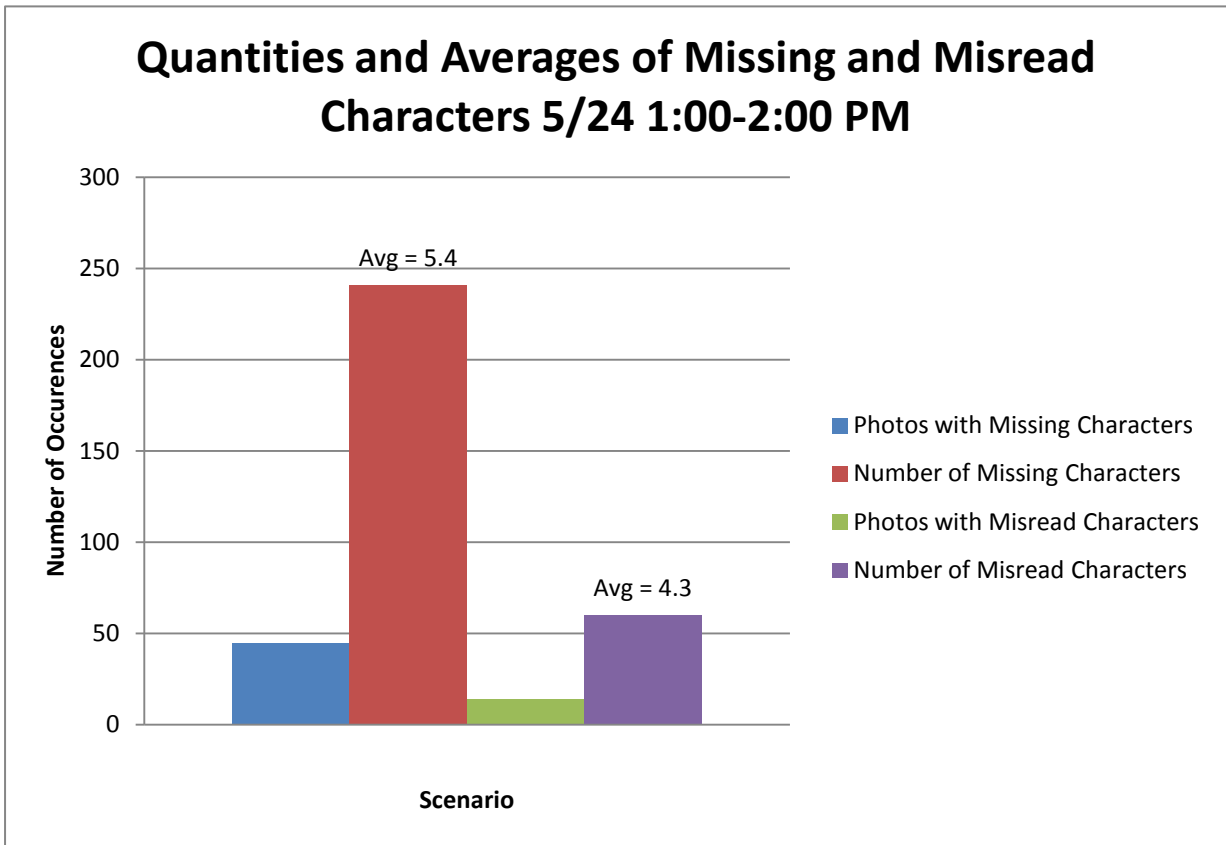
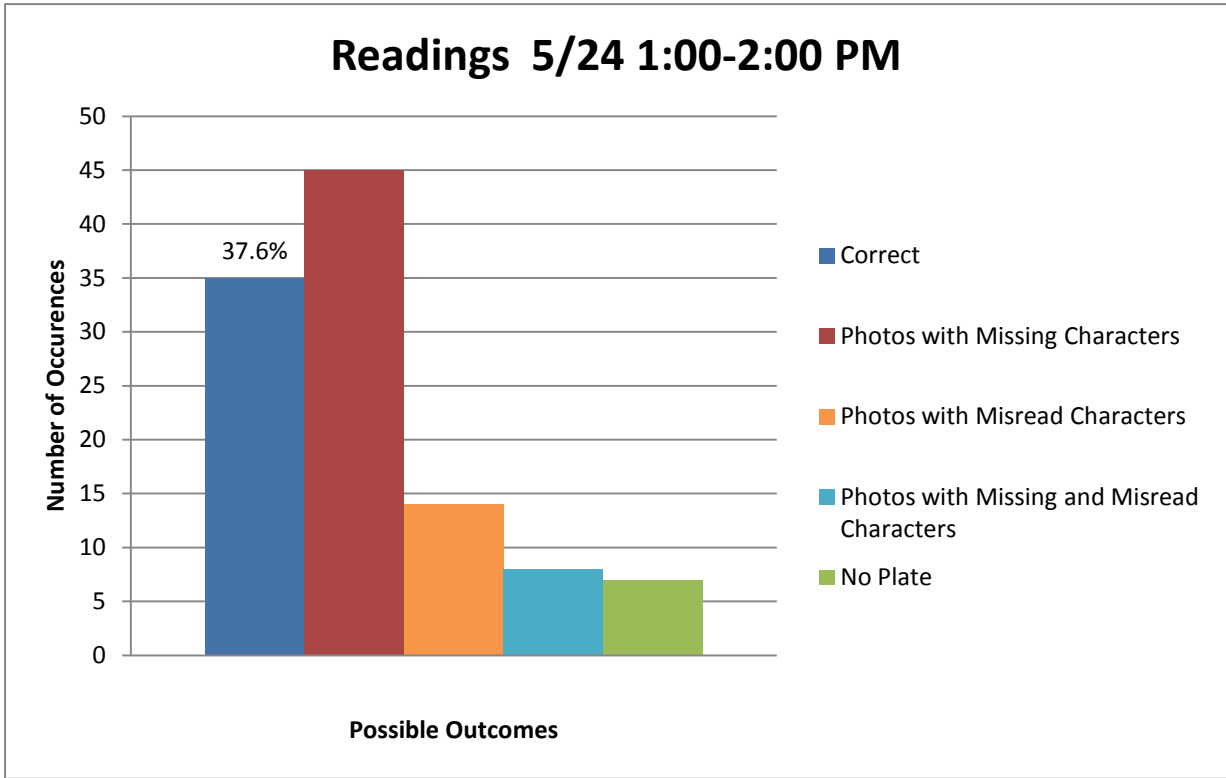


### Quantities and Averages of Missing and Misread Characters 5/24 11:00-12:00 AM - noon

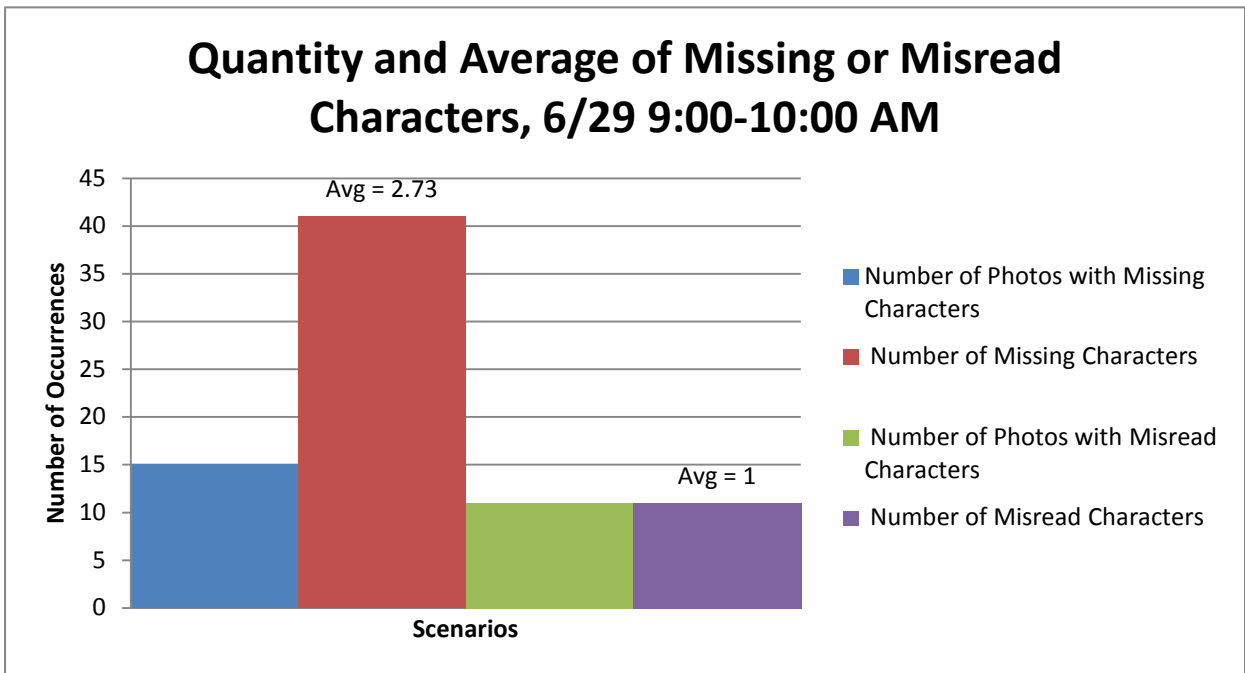
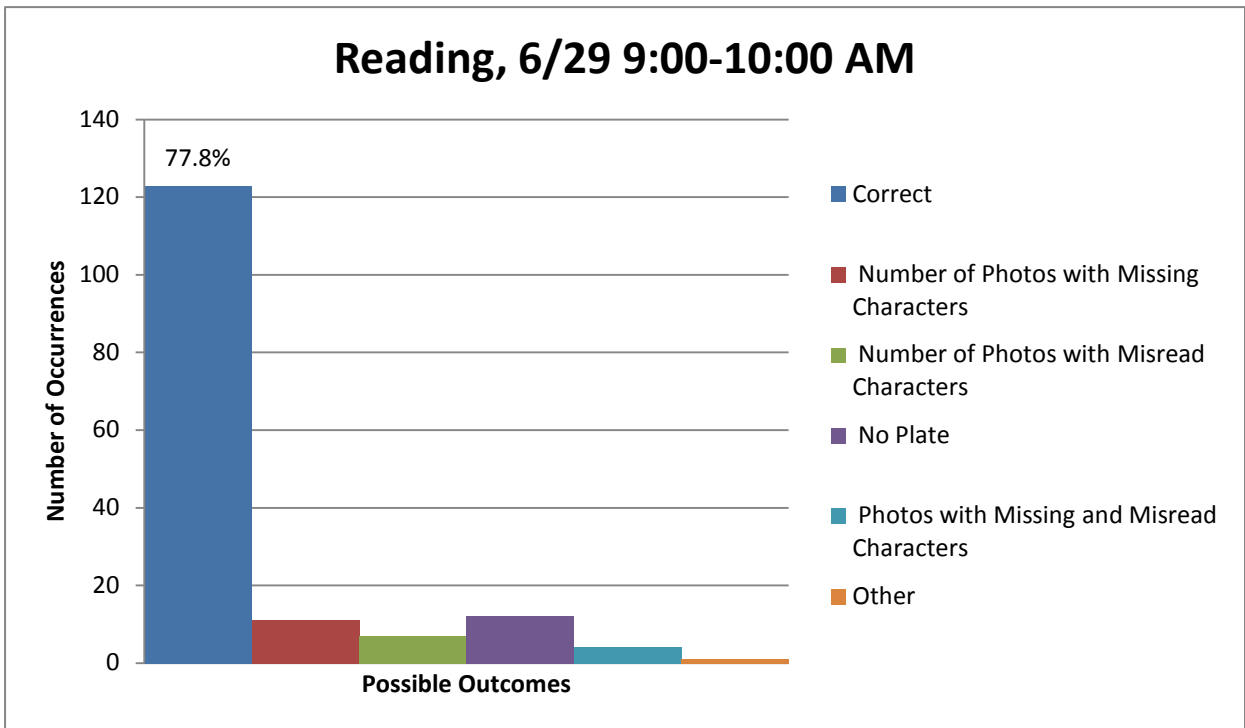




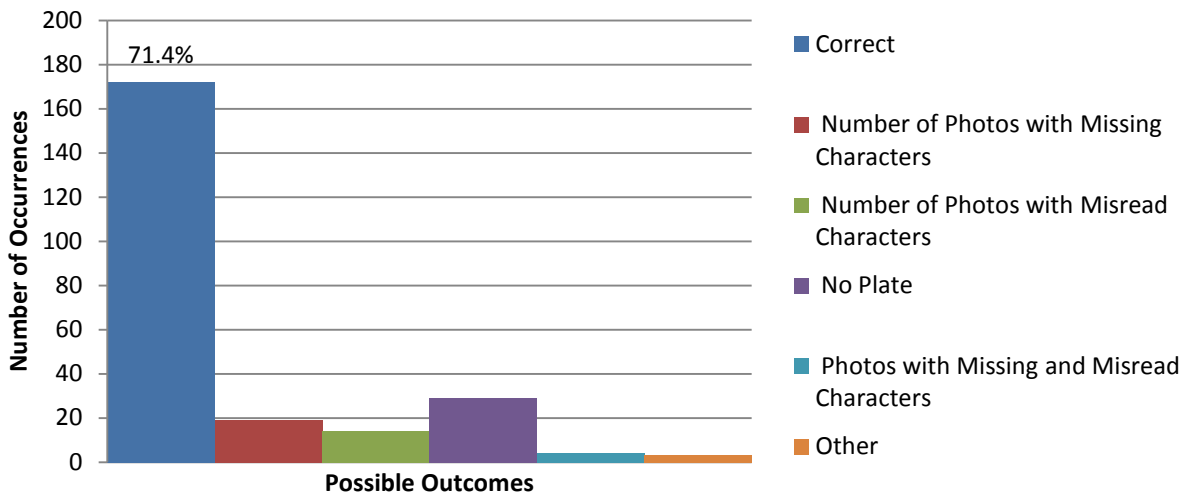




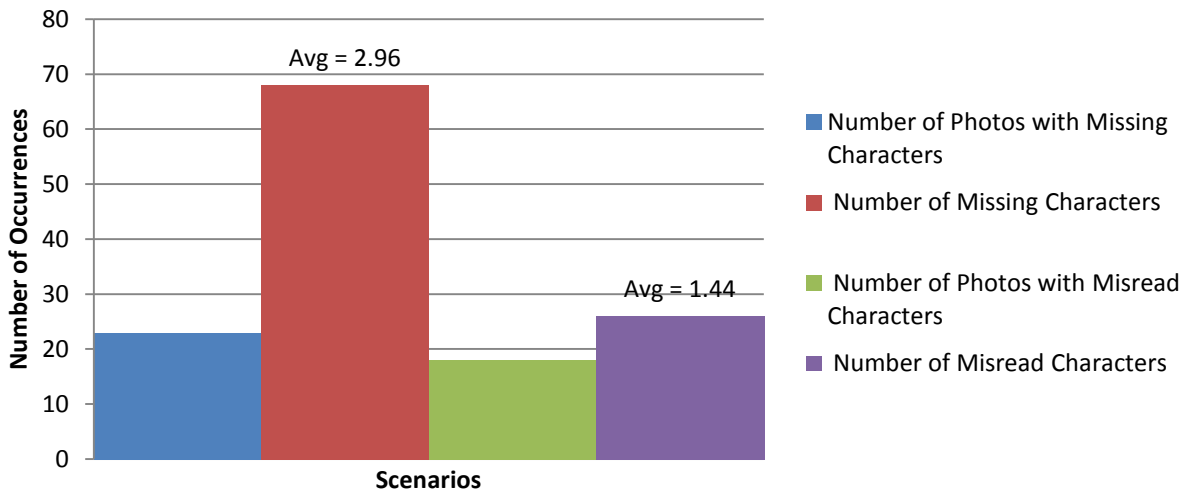
June 29, 2012



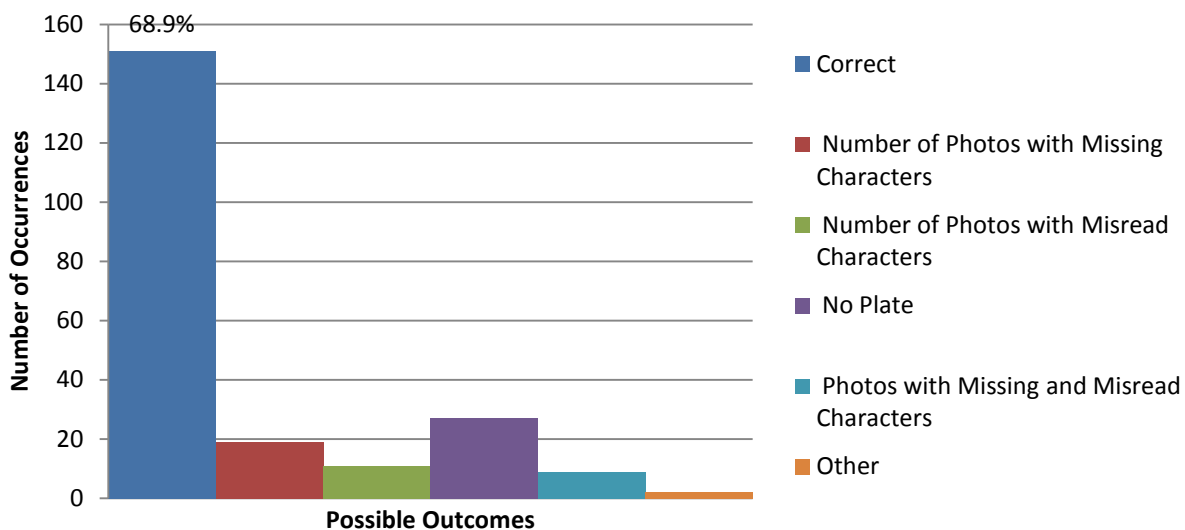
### Reading, 6/29 10:00-11:00 AM



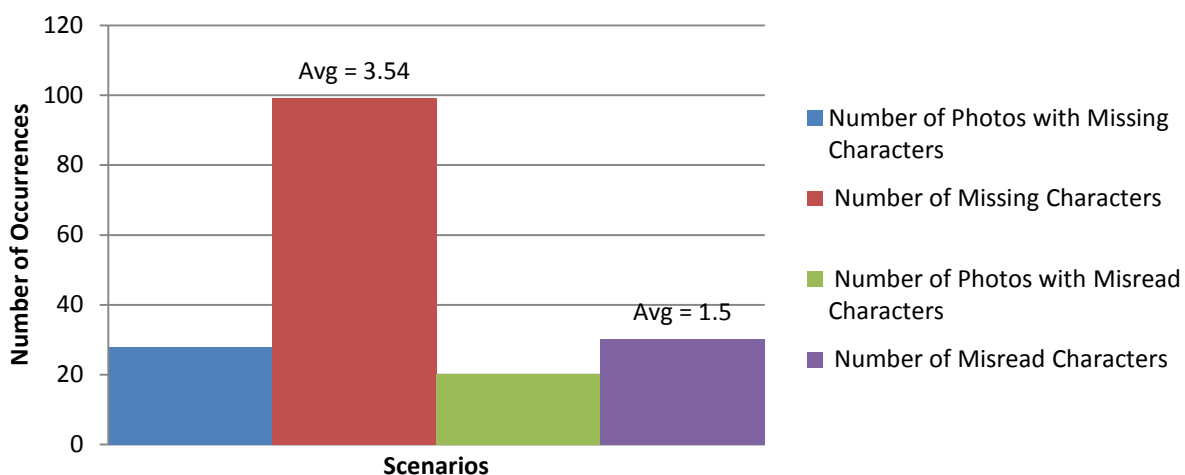
### Quantity and Average of Missing or Misread Characters, 6/29 10:00-11:00 AM



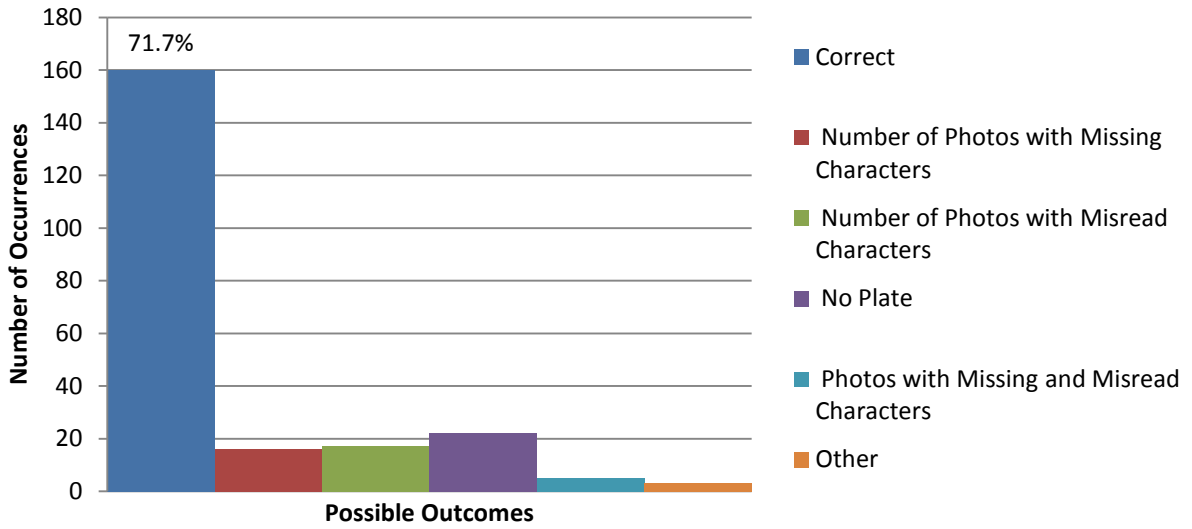
### Reading, 6/29 11:00-12:00 AM-Noon



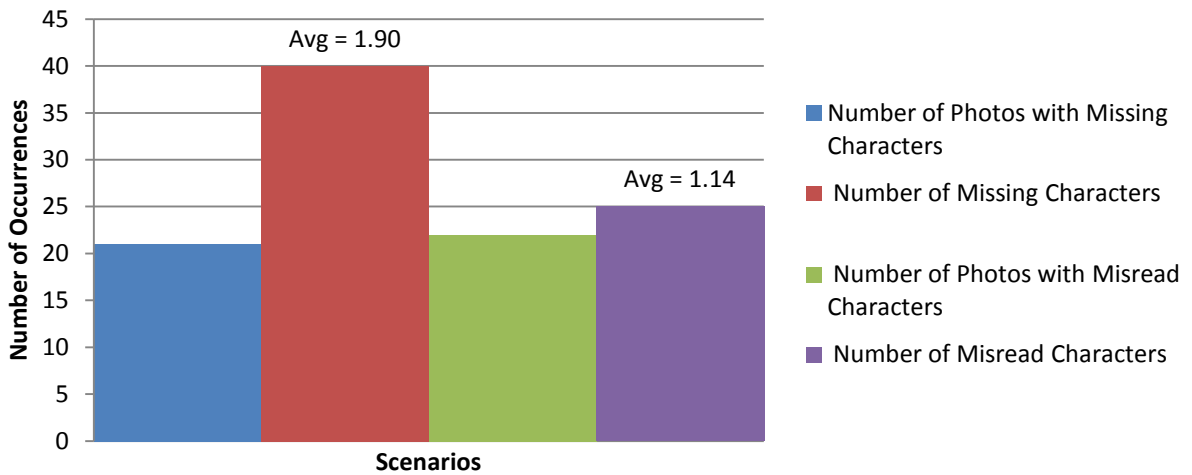
### Quantity and Average of Missing or Misread Characters, 6/29 11:00-12:00 AM -Noon



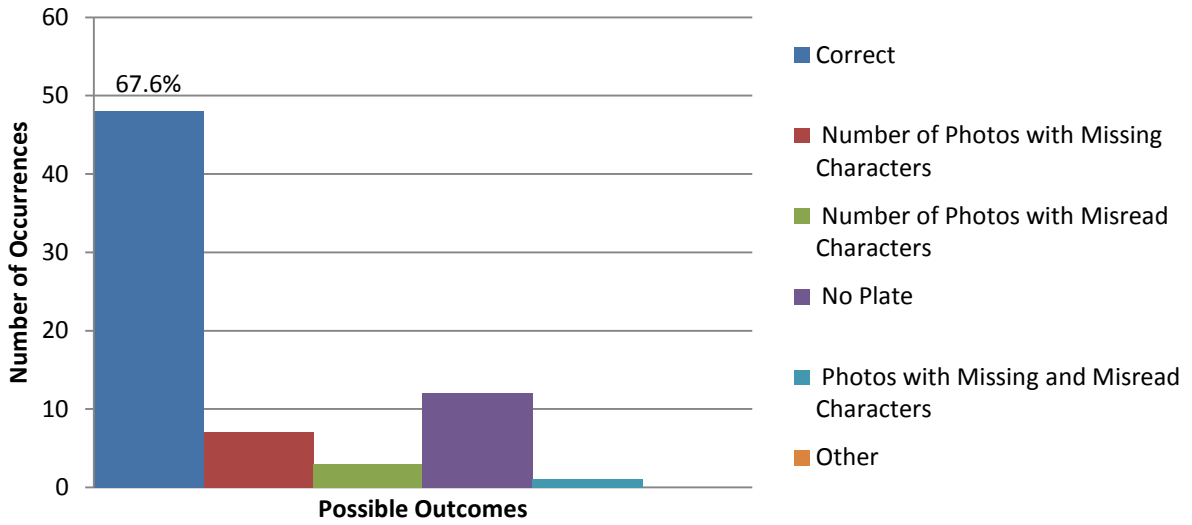
### Reading, 6/29 12:00-1:00 PM



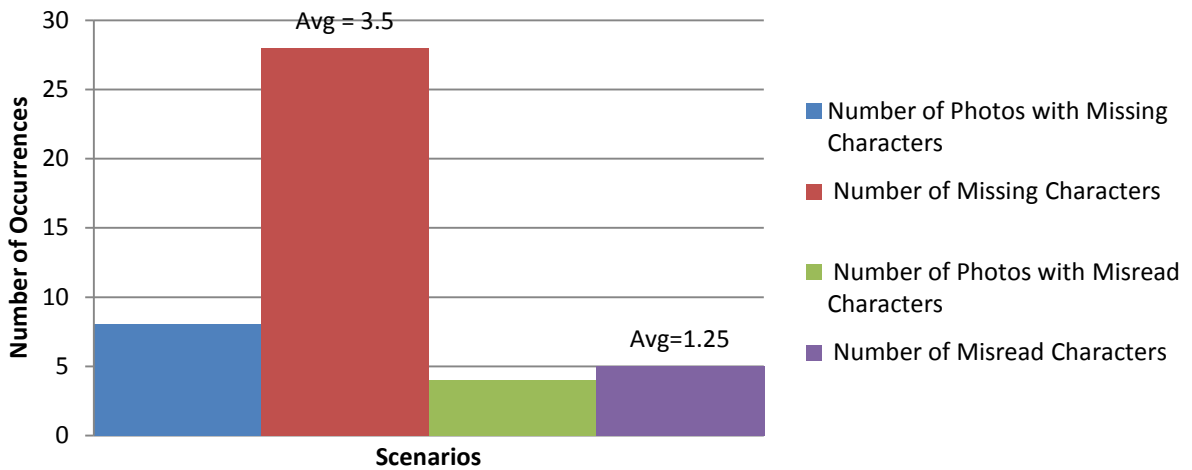
### Quantity and Average of Missing or Misread Characters, 6/29 12:00-1:00 PM



### 6/29 13:00-14:00 Reading Accuracy



### Quantity and Average of Missing or Misread Characters, 6/29 1:00-2:00 PM



## Appendix C – Speed Data Samples Measured by EVT-300 Radar

Each data set contains 30 minutes of data capture detected by the radar. The data are sampled for 16 times per second. At any instant, the radar can record up to 7 targets.

For each data set, four graphs are displayed

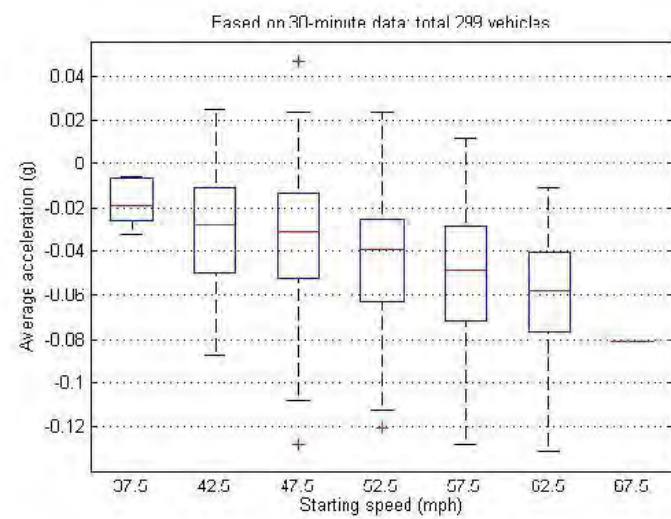
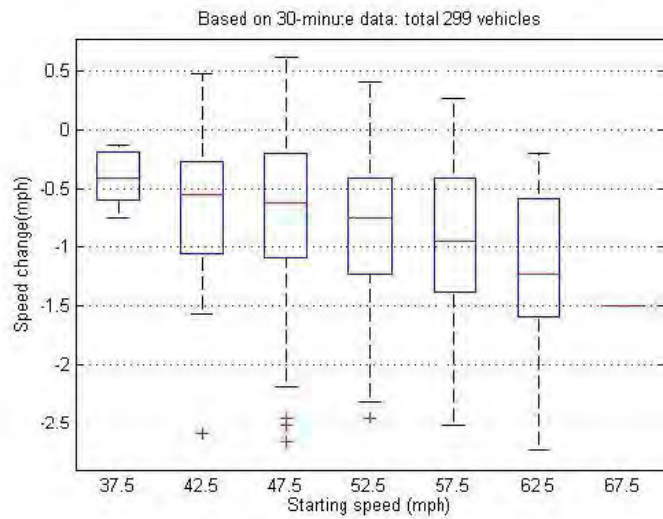
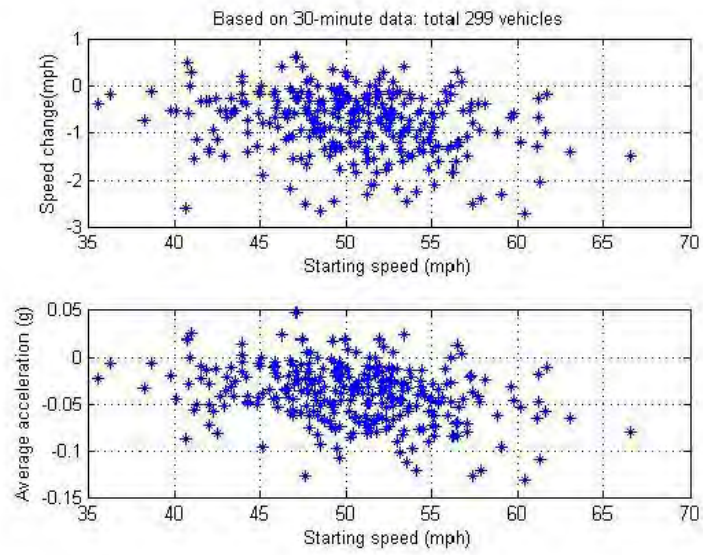
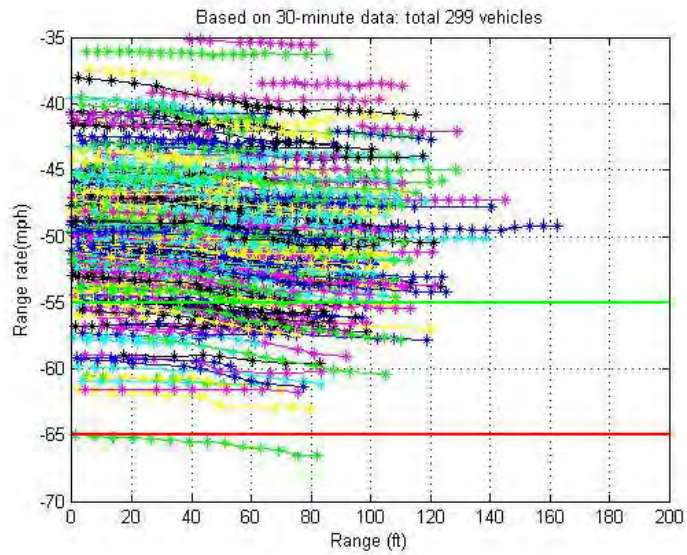
- (1) Range rate versus range (speed plotted against distance)
- (2) Distribution of speed change and acceleration plotted against the starting speed, which is the speed of the vehicle at the instant when the vehicle is first detected and tracked by the radar.
- (3) Distribution of speed change, grouped by starting speeds
- (4) Distribution of acceleration or deceleration, grouped by starting speeds

Note: The following pages show several sets of sample plots from 30-minute intervals. Additional plots from aggregated daily data will be added.

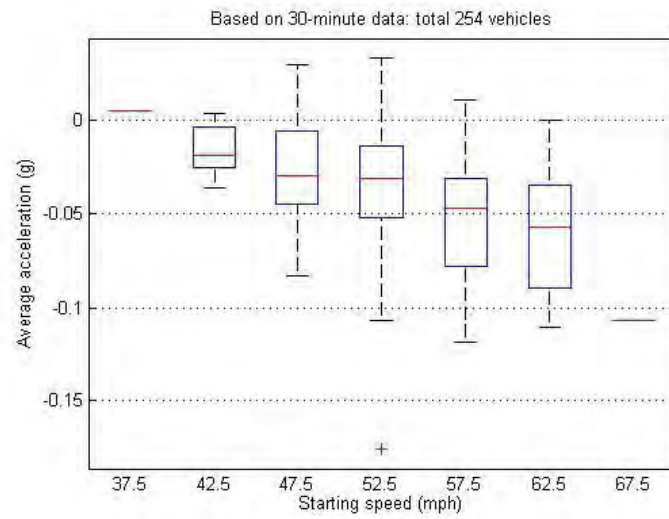
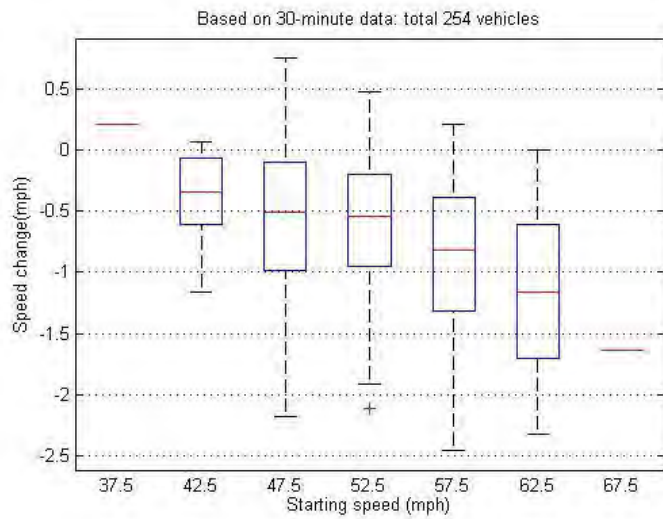
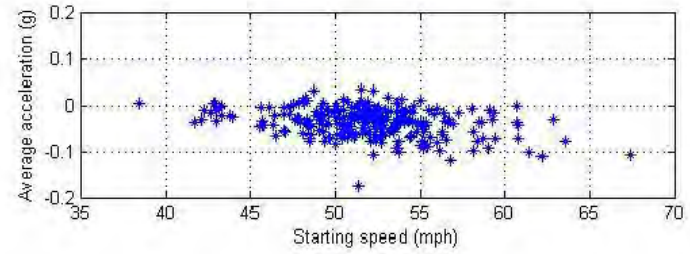
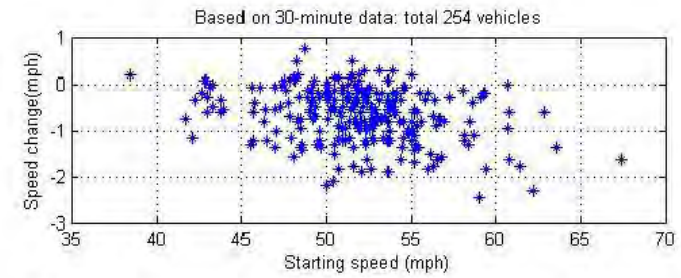
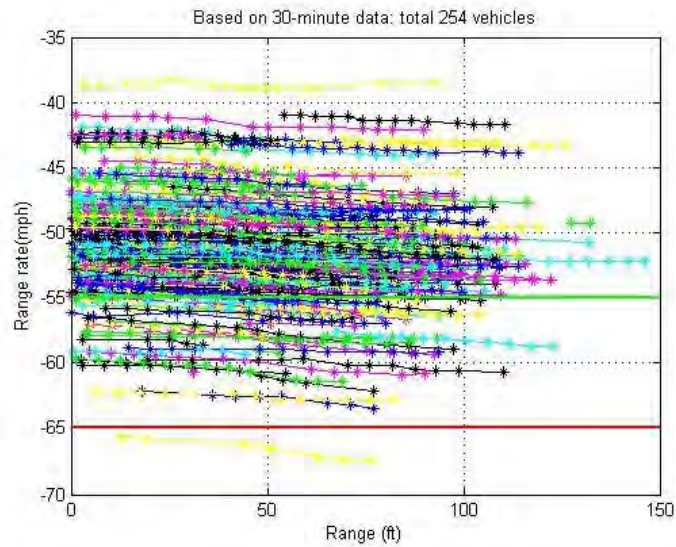
More technical discussions and explanations of these plots can be found in Section 4.2.3.



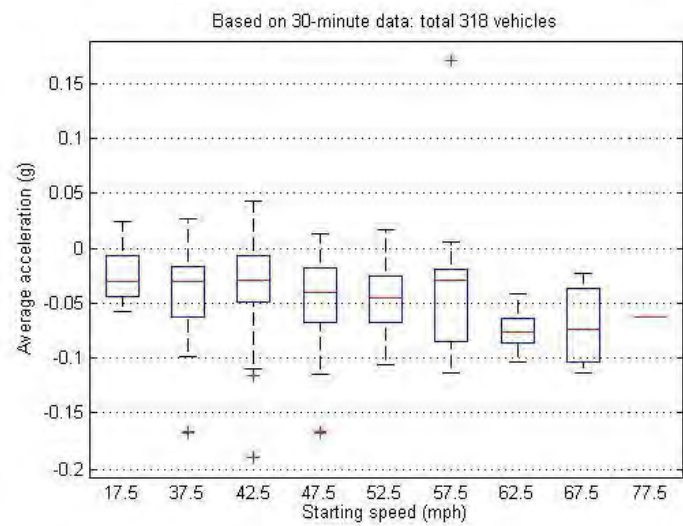
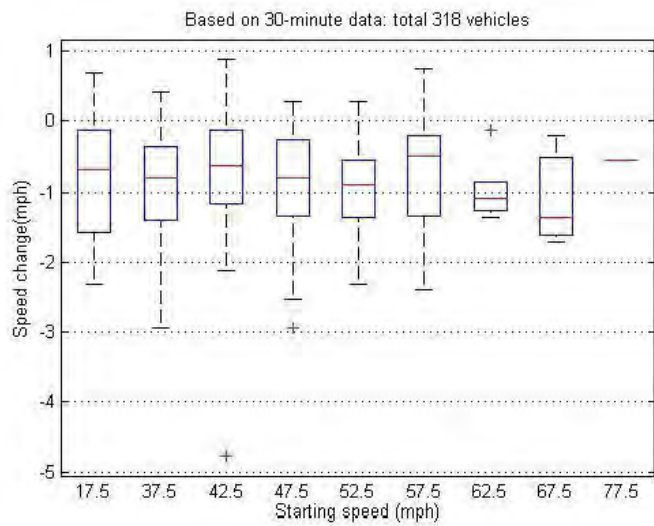
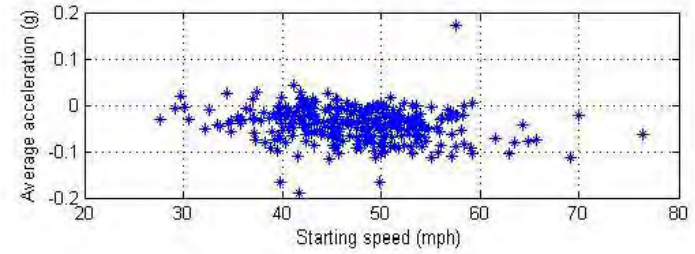
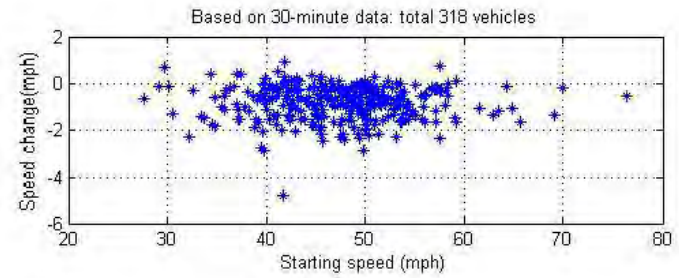
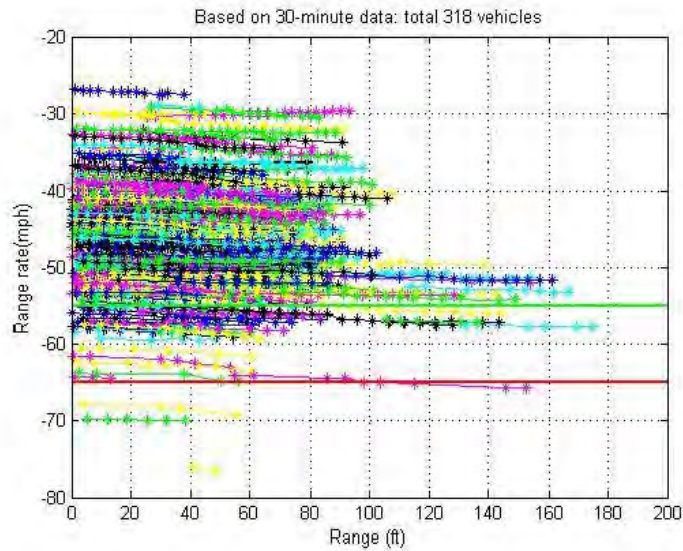
Data File: 0523007 (Week One)



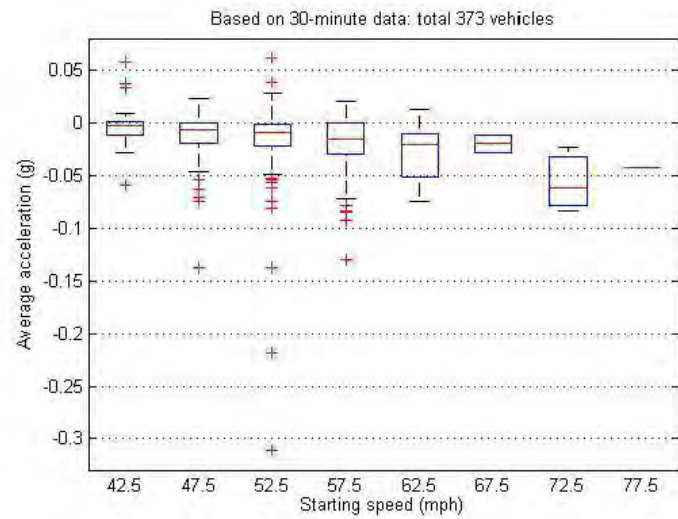
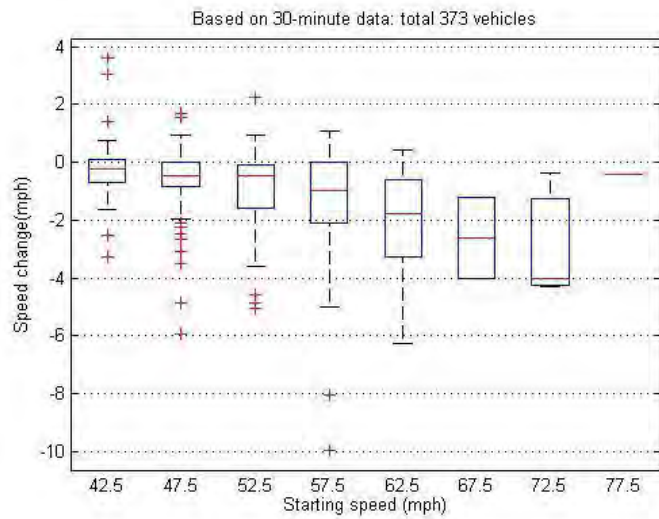
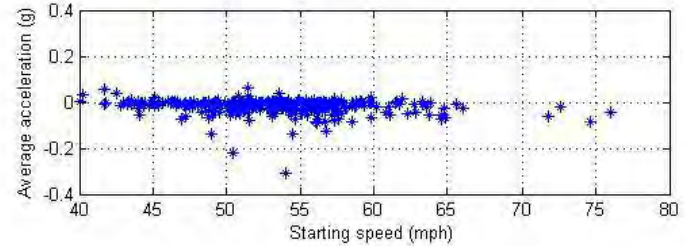
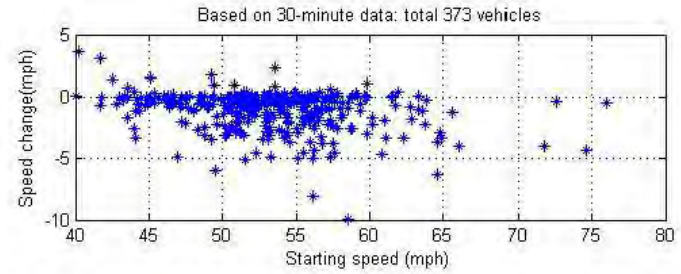
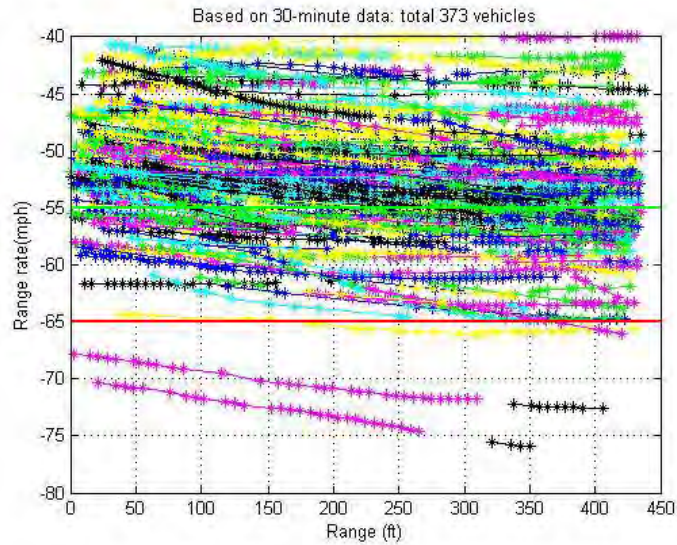
Data File: 0531002 (Week Two)



Data File: 0618008 (Week Three)



Data File: 0626008 (Week Four)



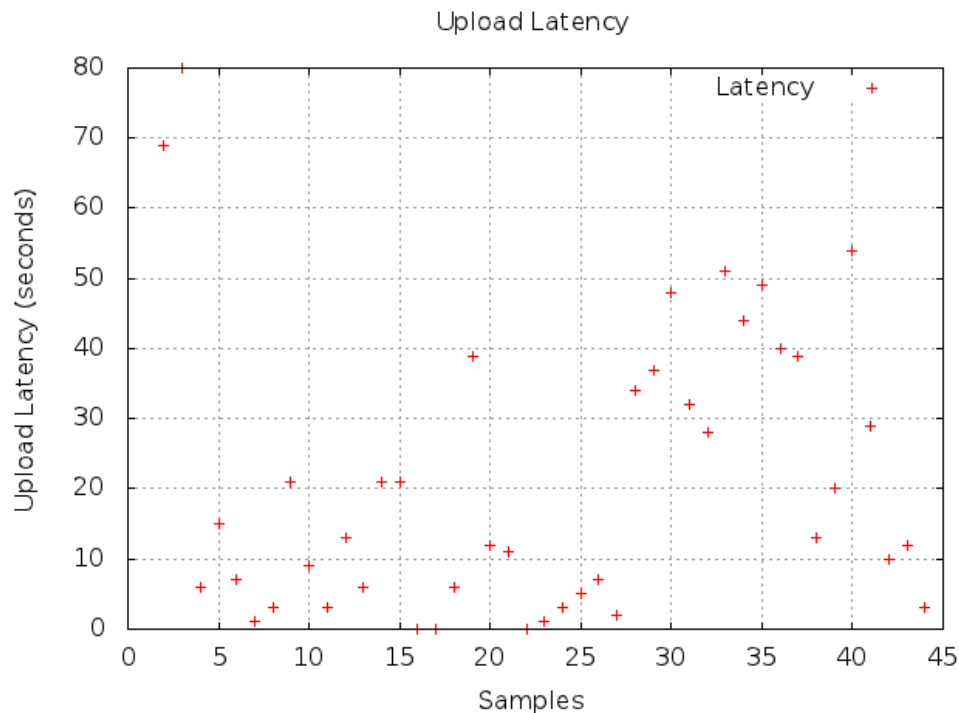
## Appendix D – Data Samples of Cellular Transmission

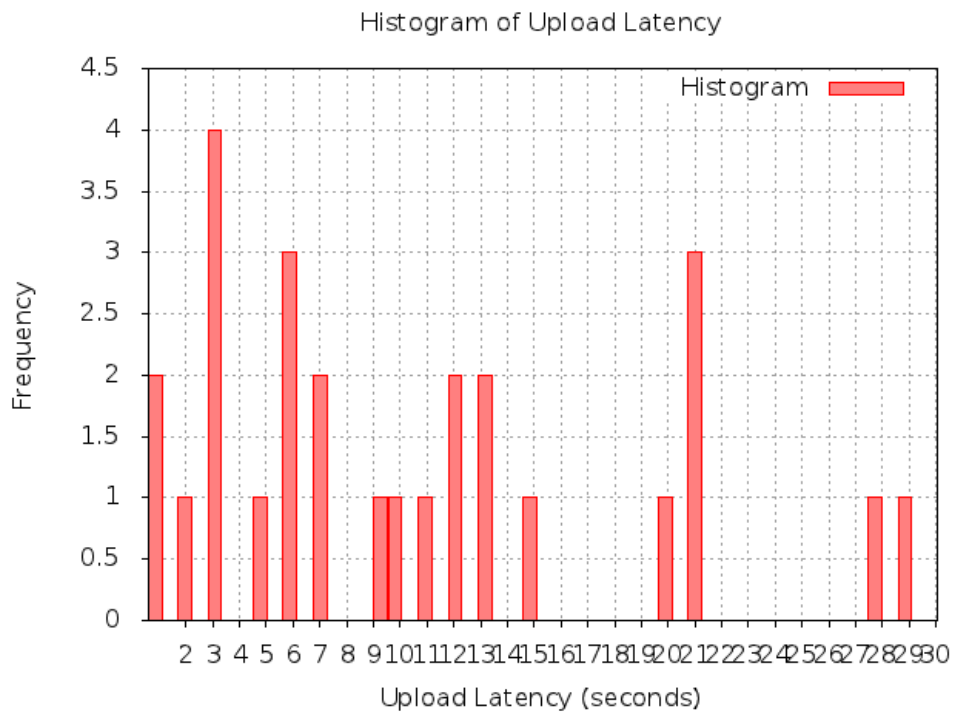
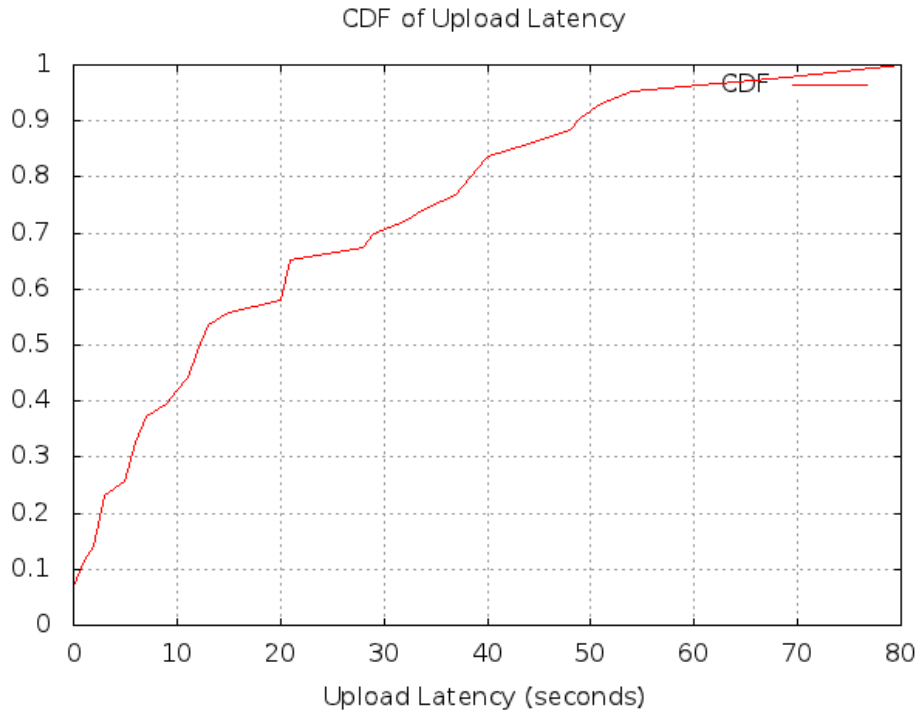
### Sample Set 1

The upload latency denotes the time taken by the license plate and speed data of speeding vehicles to go from the roadside to the server at PATH. For each set, the total number of uploads and the average upload latency is presented. A graphical representation of the upload latency, its Cumulative Distribution Function (CDF) and histogram are shown to offer clear insight into the distribution of the upload latency. The latency of the individual uploads on which this average is based is shown as a scatter plot in the figure titled Upload Latency. The CDF in the figure titled CDF of Upload Latency helps to easily determine the generalized behavior of this particular set of upload times. For example it can be easily determined from the figure titled CDF of Upload Latency that for this set of data 70% of the upload time was below 30seconds. Similarly, the histogram of this upload data set as shown in the figure titled Histogram of Upload Latency illustrates the frequency of the full range of upload times. From the figure titled Histogram of Upload Latency it is seen that for this particular set the frequency of upload times over 15 seconds are sparse and relatively low.

Total number of uploads: 100

Average Latency for uploads without mismatch: 21.0233 seconds

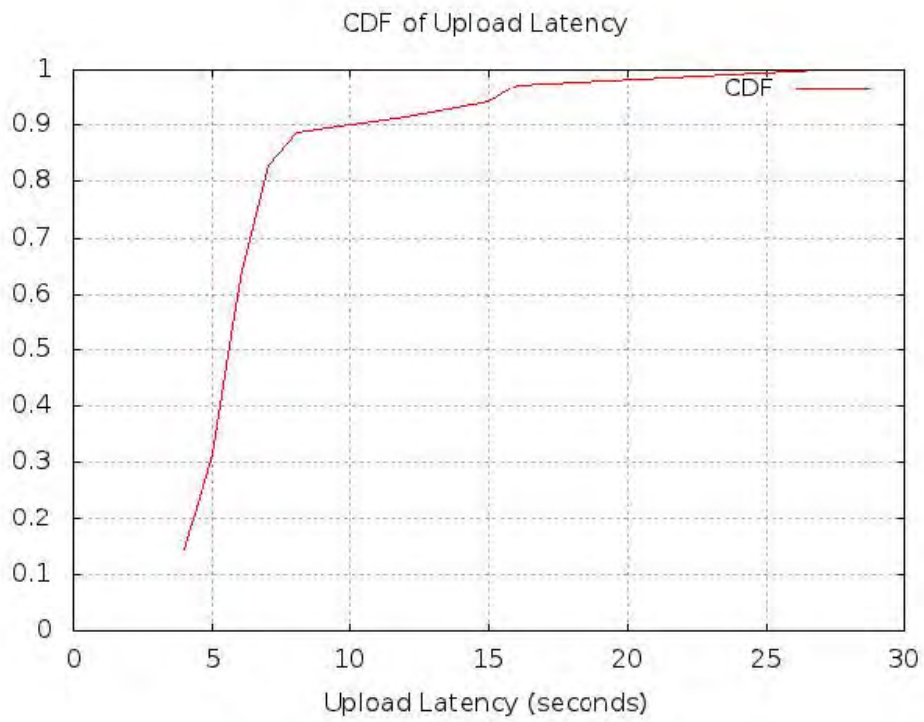
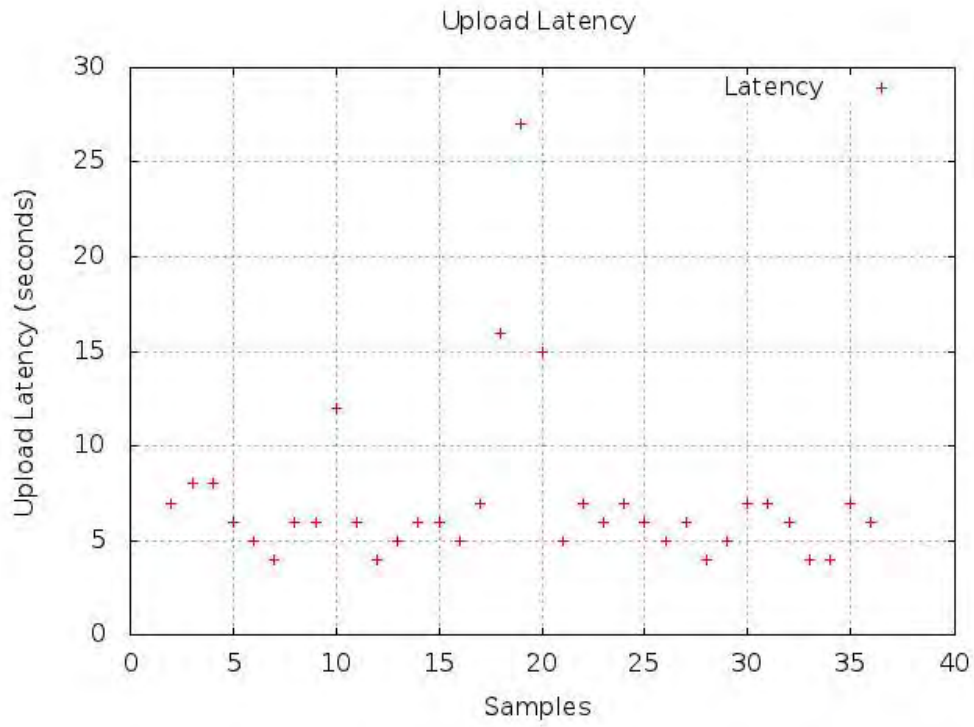


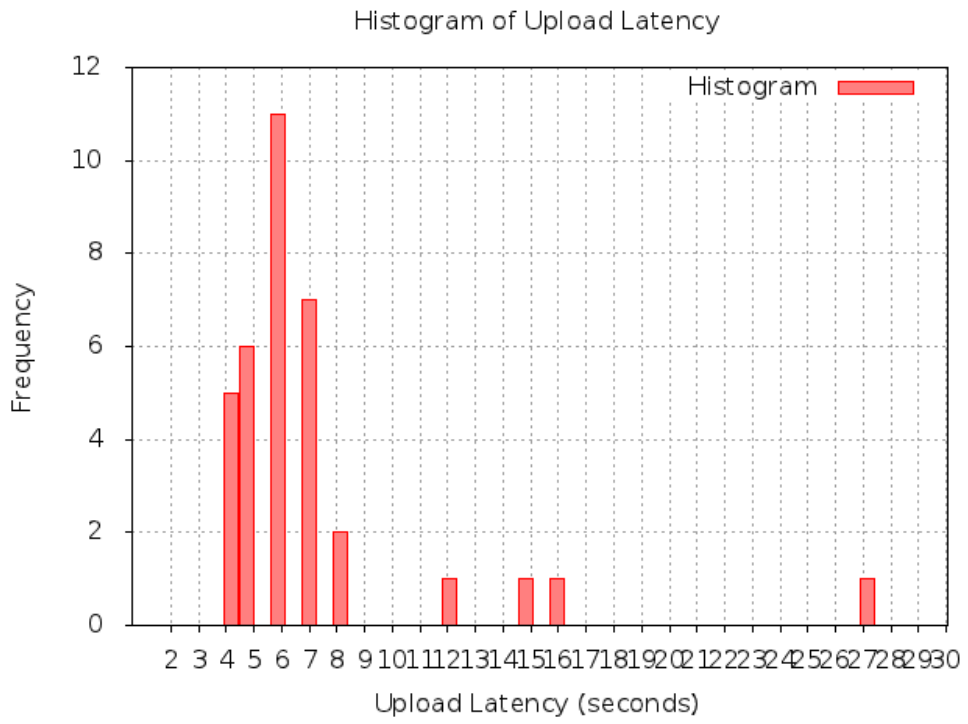


**Sample Set 2**

Total number of uploads: 35

Average Latency for uploads without mismatch: 7.17143 seconds



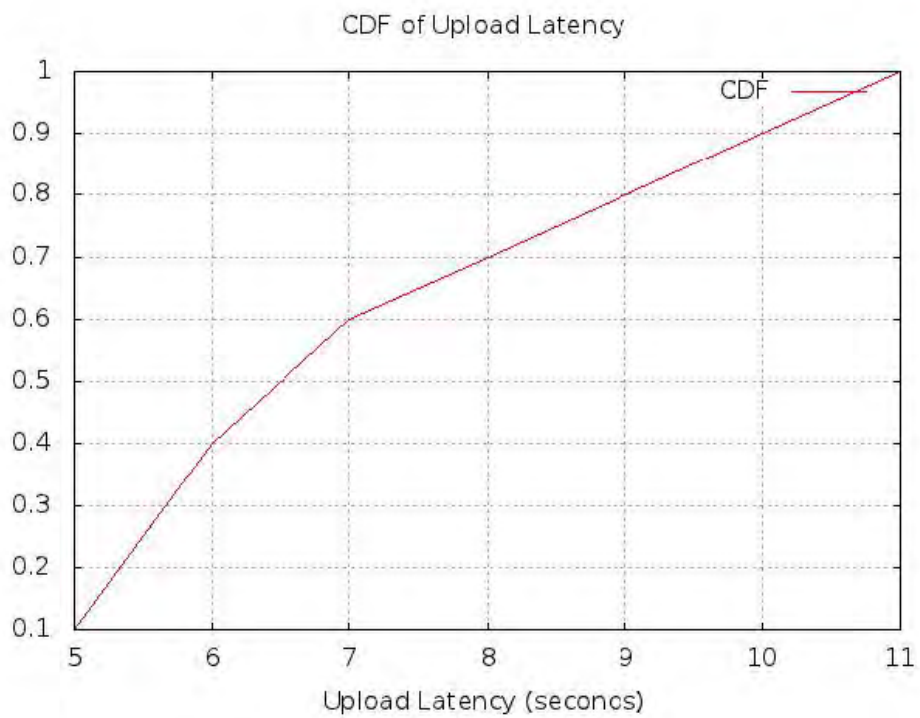
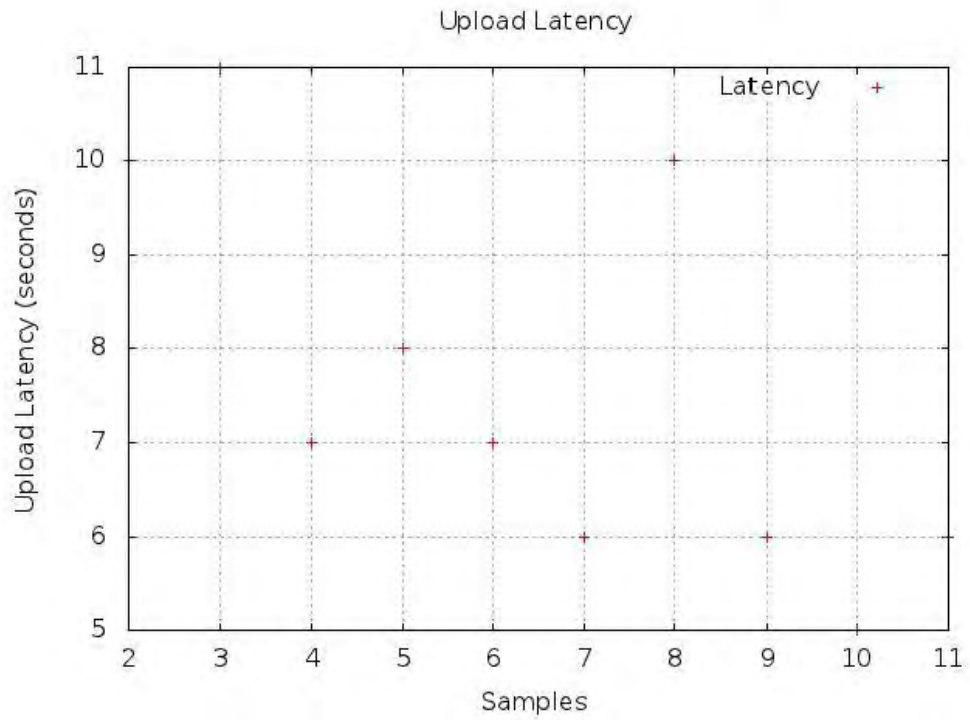


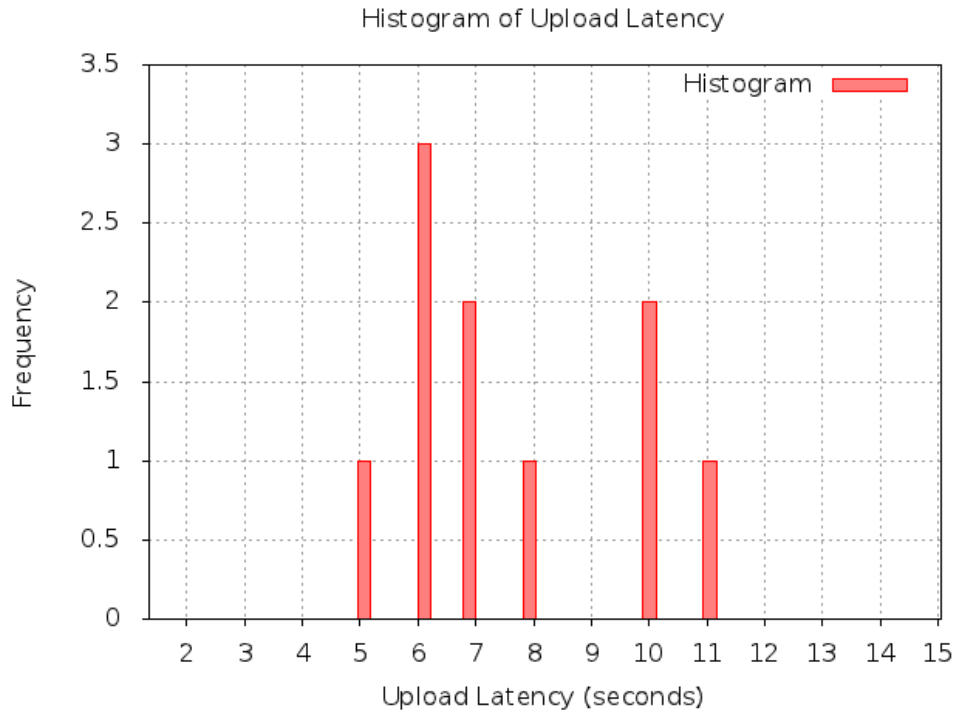


### Sample Set 3

Total number of uploads: 10

Average Latency for uploads without mismatch: 7.6 seconds

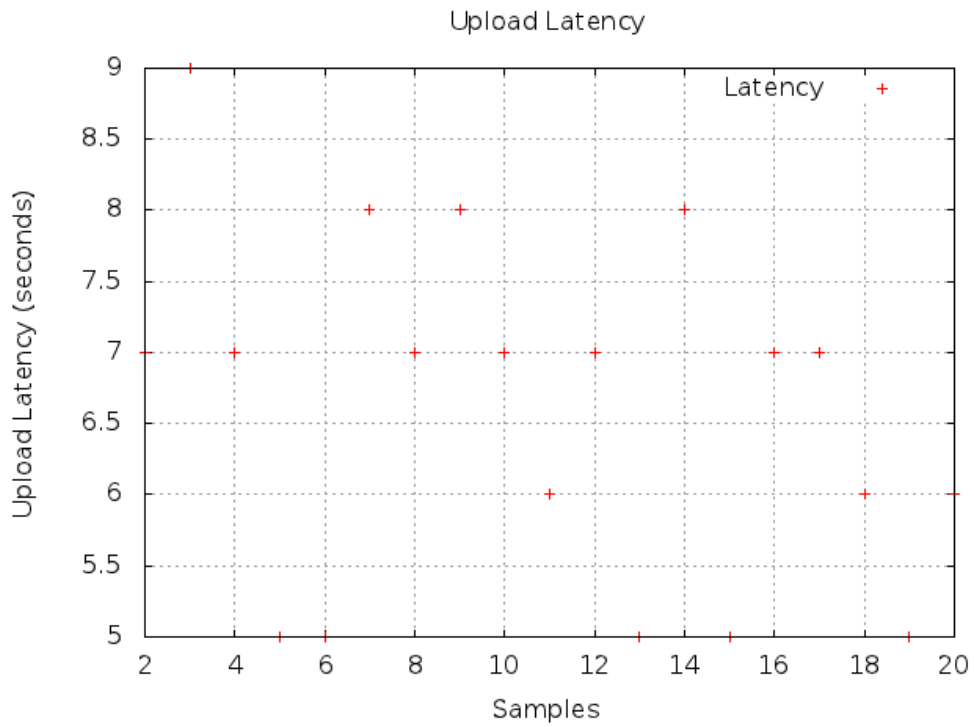




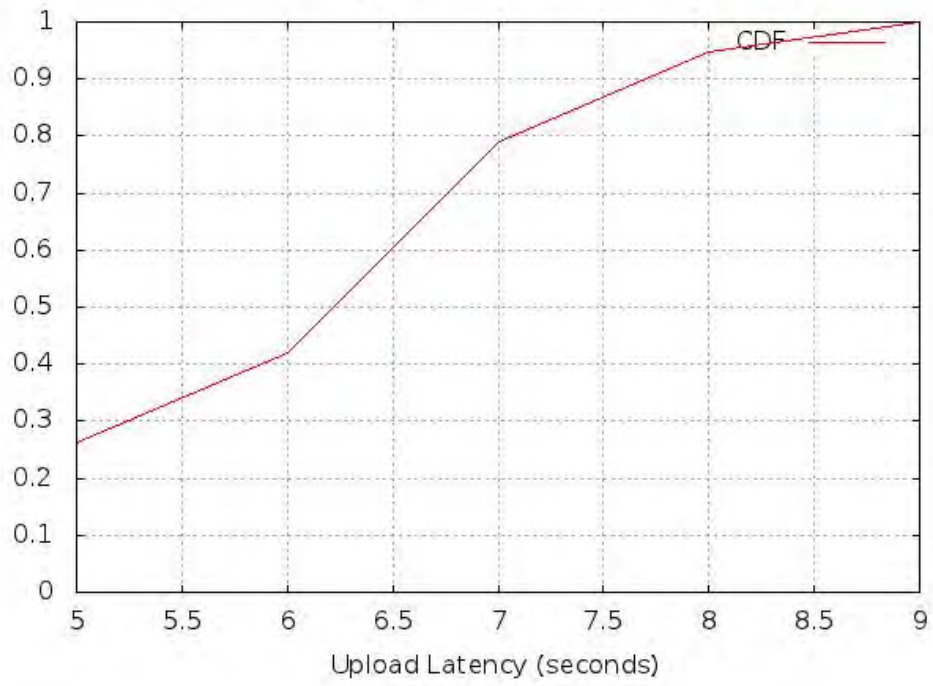
**Sample Set 4**

Total number of uploads: 19

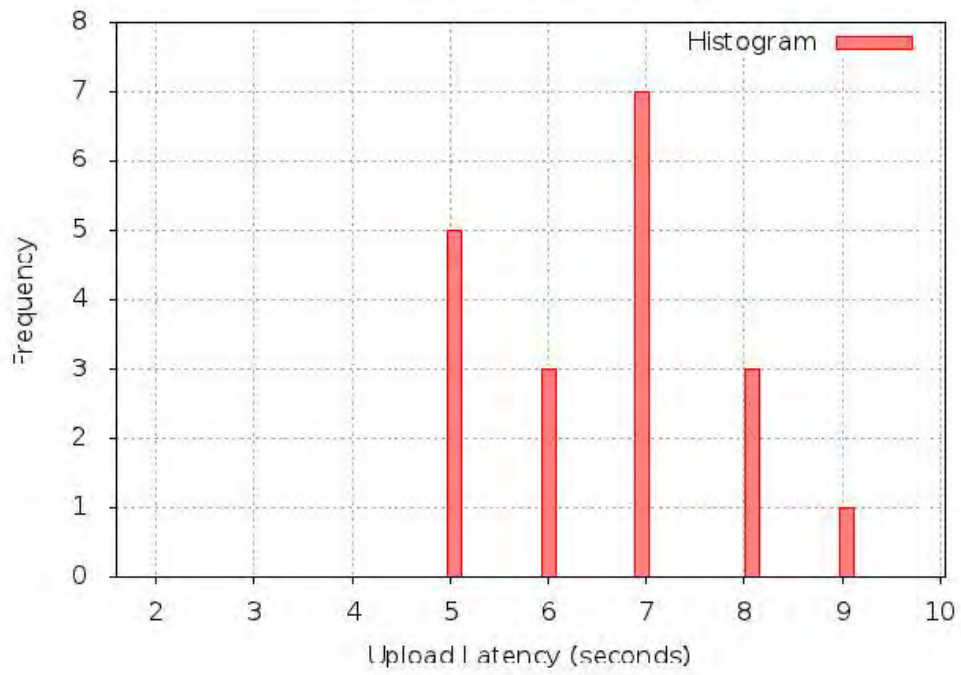
Average Latency for uploads without mismatch: 6.57895 seconds



CDF of Upload Latency



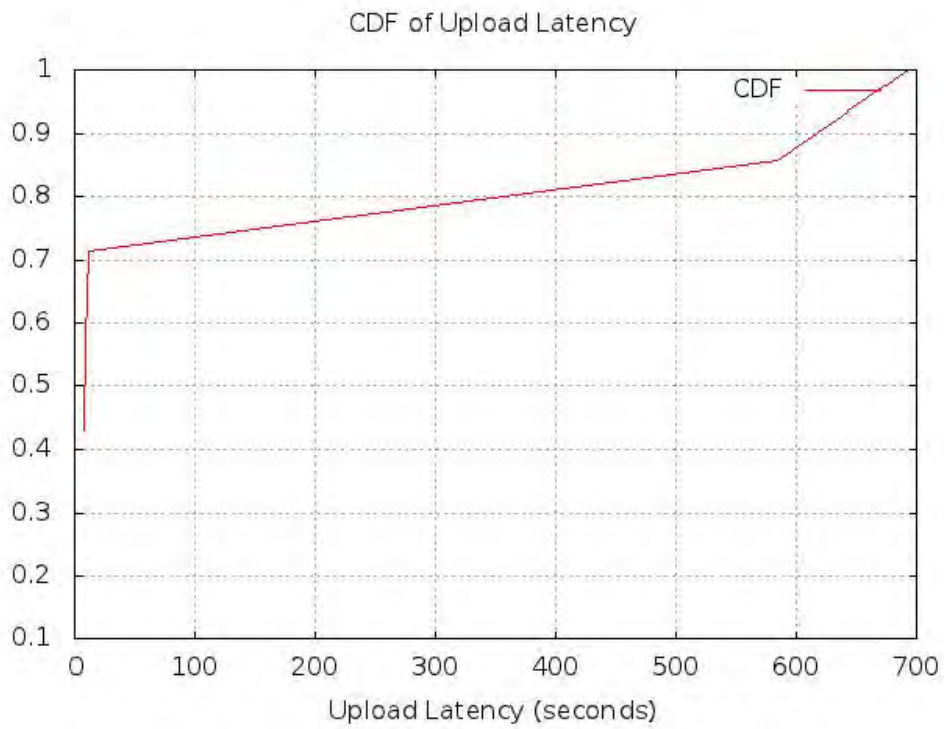
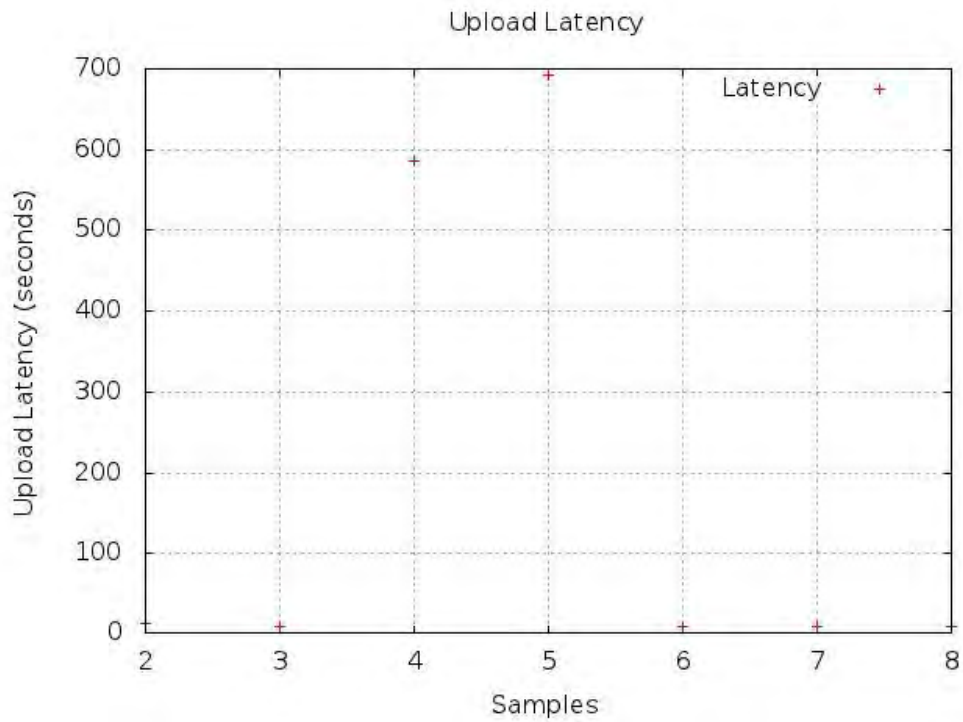
Histogram of Upload Latency

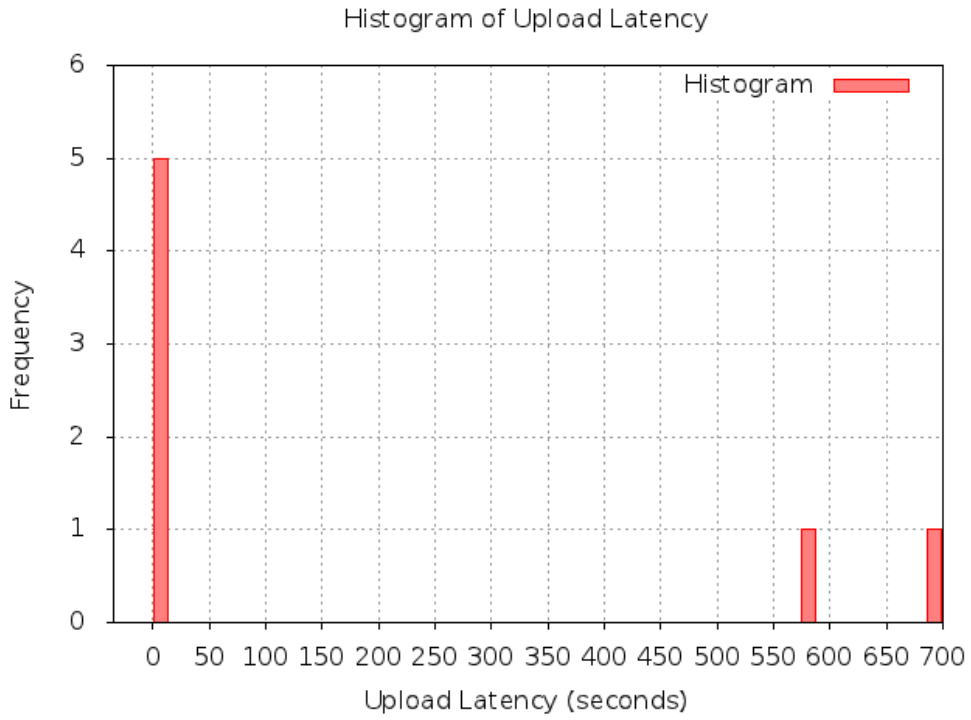


### Sample Set 5

Total number of uploads: 7

Average Latency for uploads without mismatch: 188.286 seconds

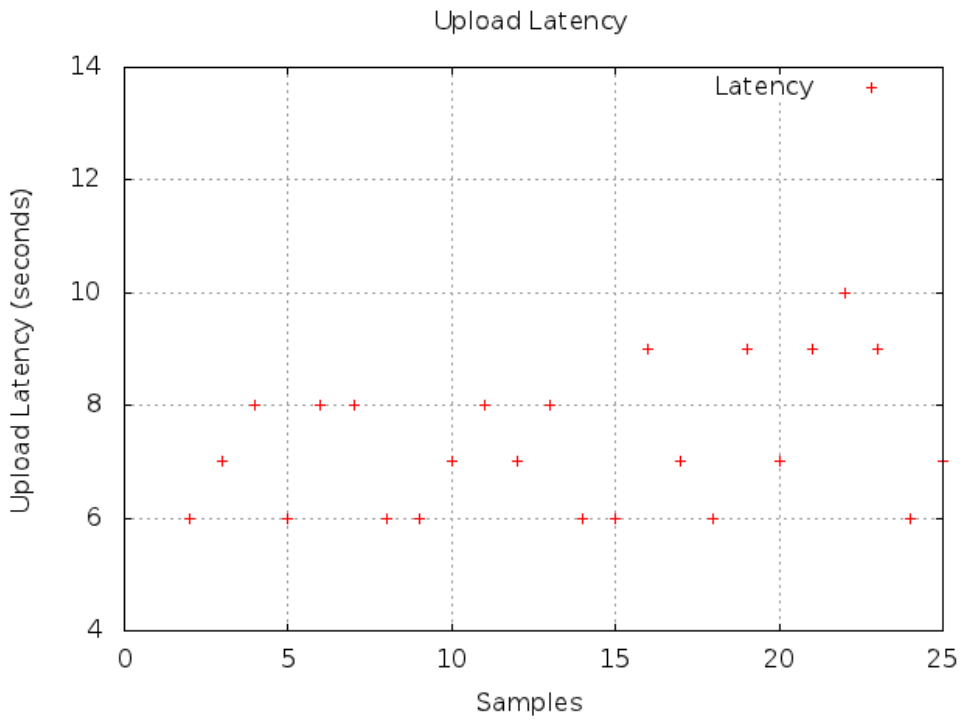




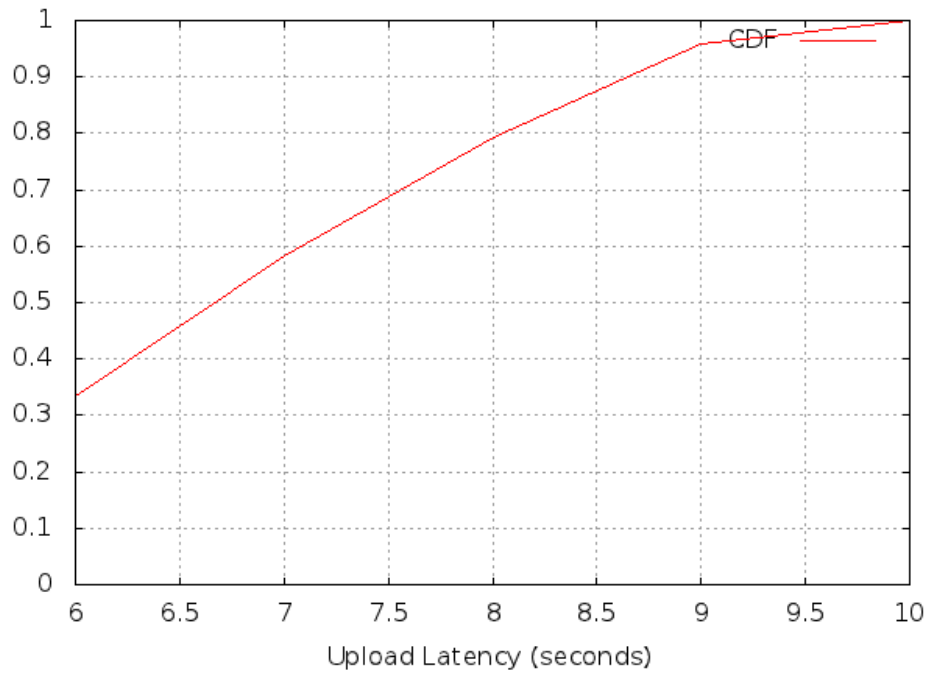
**Sample Set 6**

Total number of uploads: 24

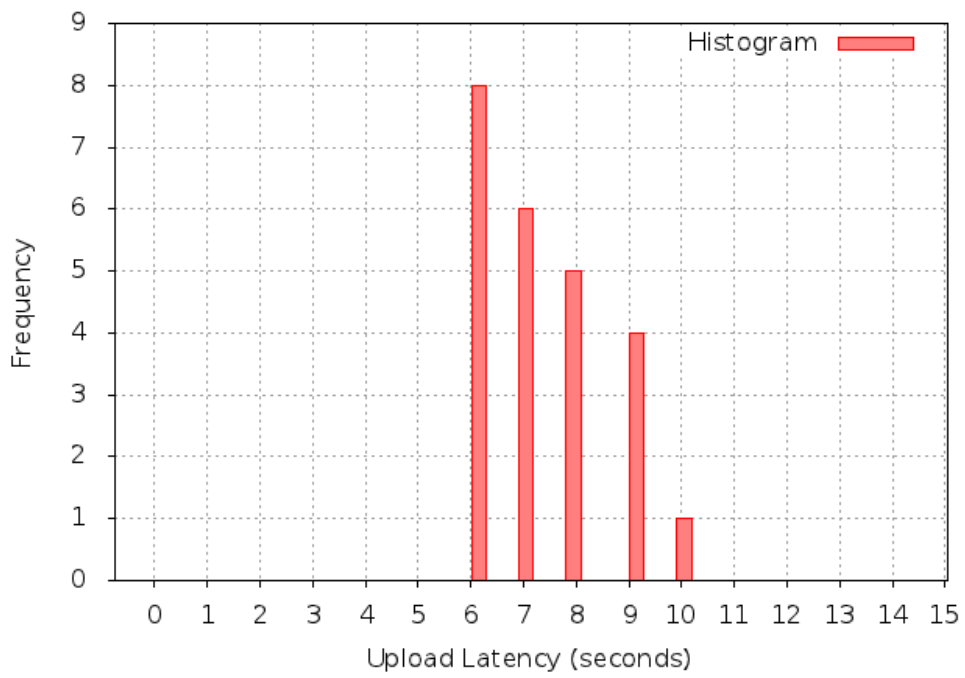
Average Latency for uploads without mismatch: 7.33333 seconds



CDF of Upload Latency



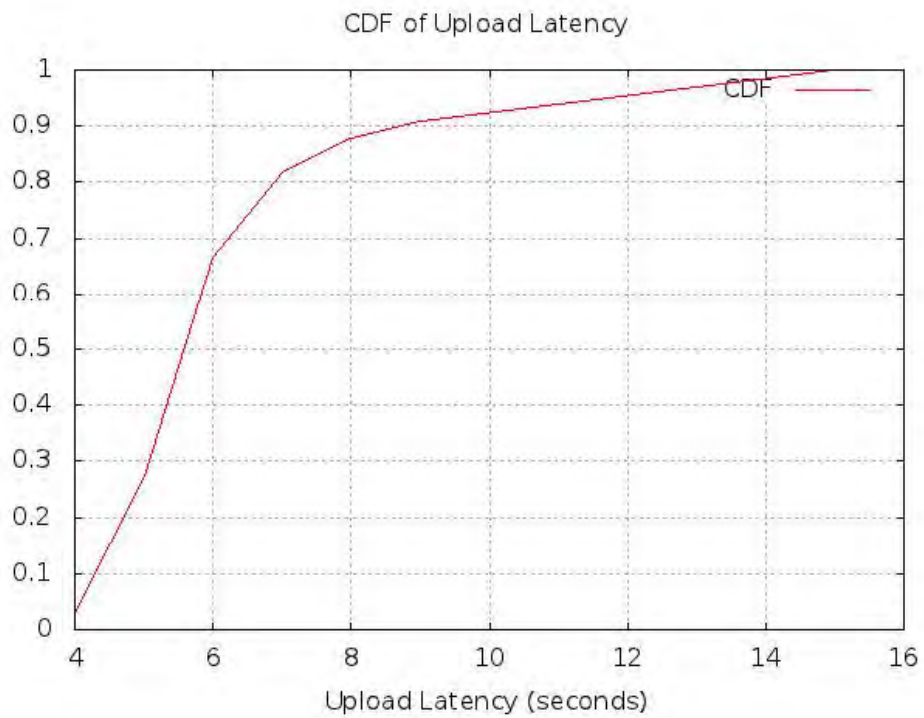
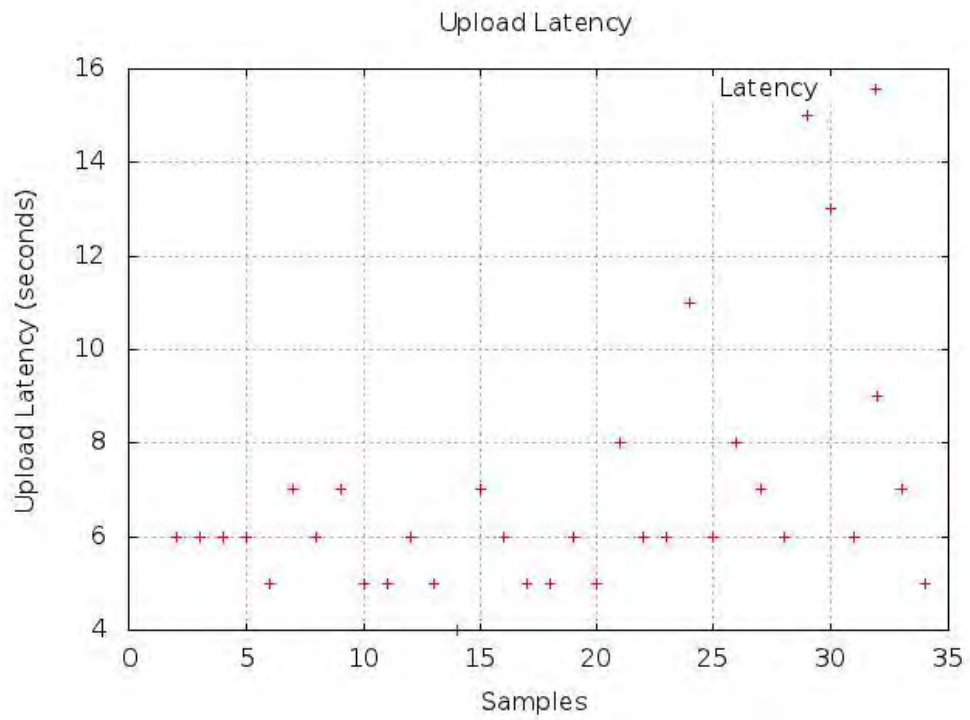
Histogram of Upload Latency

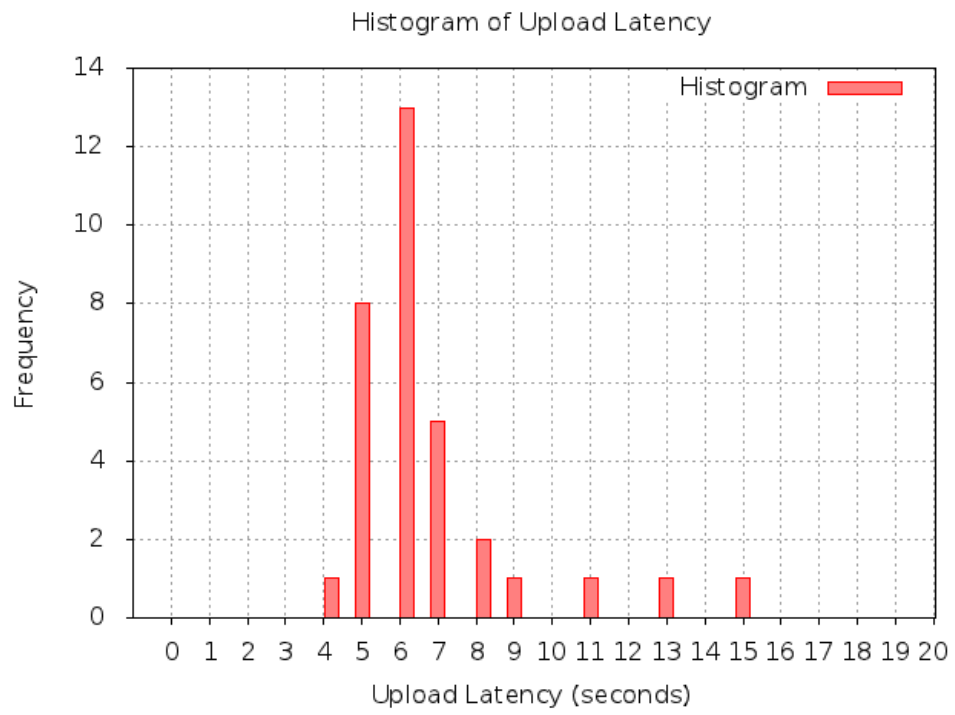


### Sample Set 7

Total number of uploads: 33

Average Latency for uploads without mismatch: 6.69697 seconds







## Appendix E – DSRC Range Verification Testing Report

### 1. Foreword

This document describes the planned and executed DSRC range testing activities to support the utilization of Dedicated Short-Range Communication (DSRC) for the augmented speed enforcement (aSE) project. The aSE project is sponsored by USDOT and has been carried out in California with joint efforts of California Department of Transportation (Caltrans), California PATH of UC Berkeley, Western Transportation Institute (WTI) of Montana State University, and California Highway Patrol (CHP). This particular range testing was designed, built and tested solely by PATH.

### 2. Scope and Scenario of DSRC Tests

#### 2.1 Test Objective

The main objective of this experiment is to identify the effective range up to which DSRC can support the requirements of the aSE project. It is assumed that this communication would be stationary and point to point. Secondary objectives would be to verify the benefit and necessity of specialized antenna and cables in extending the range along with the utility of using a repeater.

#### 2.2 Experimental Setup and Equipment

##### 2.2.1 Use of [Laptop and DSRC modules](#)

During the experiment messages were sent, and the transmission and reception of those messages are accomplished using DSRC communication. A pair of DSRC modules were used for this purpose. During the testing each DSRC module were connected to a laptop to conduct and monitor the tests.

##### 2.2.2 Roadside setup

The roadside setup consist of a pair of DSRC modules and corresponding laptops, pole mounted antenna along with low loss cables, local networking equipment and batteries for required power. Both of these are mobile preferably on a vehicle with the antenna mounted high. Such a setup helps in simulating field conditions and ease experimentation at the same time. The main components and their specifications are described below. They consist of the different antenna types the low loss cables and the DSRC unit. The specification of the DSRC unit is described in Appendix A. The focus in this section has been given in describing the newer components.

#### **Antenna:**

Two different kinds of antennas were used, Directional and Omnidirectional. They specifications are described below.

## **Directional Antenna**

Model # MA-WA57-3HG1

### **Specifications:**

#### **Electrical**

Frequency range 4.9 – 6.5 GHz

GAIN, typ. 4.9 - 5.15 @ 18 dBi

5.15 – 6.5 @ 19 dBi

VSWR, max. 1.5 : 1

Polarization Linear, Vertical or Horizontal

3 dB Beam-Width, H-Plane, typ. 19.5°

3 dB Beam-Width, E-Plane, typ. 19.5°

Cross Polarization, max ETSI EN 302 085 v1.2.3 TS2 Range 1

Front to Back Ratio, max. ETSI EN 302 085 v1.2.3 TS2 Range 1

Side Lobes, min. ETSI EN 302 085 v1.2.3 TS2 Range 1

Input power, max 50 Watt

Input Impedance 50 Ohm

Lightning Protection DC Grounded

#### **Mechanical**

Dimensions (HxWxD) 155 x 155 x 28 mm (6.1"x6.1"x1")

Weight 250 gr.

Connector N-Type, Female

Back Plane Aluminum protected through chemical passivation

Radome UV Protected Polycarbonate

Mount MNT-22 (Not Included)

#### **Environmental**

Operating Temperature Range - 40°C to + 65°C



**Omnidirectional Antenna**

Model # ECO12-5800 WiFi 5 GHz Omnidirectional Antenna

Band: DSRC, 5.9 GHz

Frequency: 5.7-6.0 GHz

Gain: 12 dBi gain

**Specifications**

VSWR: 2:1 max over range

Impedance: 50 Ohm nominal

Max Power: 25 Watts

Beamwidth: ECO12 7° EI, 360° Az

Operating Temp: -40° to +85° C

Lightning Protection: External recommended

Max Wind Velocity: 125+ mph (200 kph)

Material: White or black fiberglass

Weight: <0.75 lbs (< 0.340 kg)

Antenna Diameter: 0.63 in (1.6 cm) Radome, 0.9 in (2.3 cm) at the base



**Cables:**

**LMR400 Flexible Low Loss Coax Cables from Times Microwave Systems**

	Frequency(MHz)	30	50	150	220	450	900	1500	1800	2000	2500	5800
Attenuation	dB/100ft	0.7	0.9	1.5	1.9	2.7	3.9	5.1	5.7	6.0	6.8	10.8
Attenuation	dB/100m	2.2	2.9	5.0	6.1	8.9	12.8	16.8	18.6	19.6	22.2	35.5
Avg.	Power kW	3.33	2.57	1.47	1.20	0.83	0.58	0.44	0.40	0.37	0.33	0.21



**2.2.3 Generation of Message Sequence**

During the field tests the license number and speed data was transmitted via DSRC. We recreated similar messages while generating them during this experiment. The sequence of messages that were generated and recorded allowed the following:

- Monitoring and identification of missing or dropped message

- Counting of packet losses
- Frequency of packet losses

## **2.3 Experimental Sequence**

### **2.3.1 Range Verification**

The range verification addressed the main objective of the experiment. A sequence of gradually increasing distances and varying transmit powers between the transmitting and receiving stations were tested. At each step, monitoring and identification of missing or dropped messages were done and the performance in terms of distance was documented. We covered at least 1 mile and any distance safely verifiable after that. In the actual field tests, we were able to reach a distance of 1.1-1.2 miles. Reliability of the message reception at each step was verified so that it could sustain aSE functionalities.

### **2.3.2 Test Plan**

- 1) DSRC Radio with message transmitter setup.
- 2) Transmit EIRP set close to 44.8dBm
- 3) Antenna height is made practically as near 6m as possible.
- 4) The Receiving DSRC radio is setup with similar antenna settings at a distance of 1mile.
- 5) Message transmission is started at the transmitter and logged.
- 6) Message received at the receiver is also logged.
- 7) Message transmission is stopped and logs verified at both the transmitter and receiver.
- 8) At distances of 1 mile and any steps above it, the transmit power of the DSRC radio is varied progressively and the steps 5-7 are repeated until there are loss of messages and the reception becomes unreliable.
- 9) Post processing is done on the data collected for detailed analysis.

## **2.4 Repeater Setup**

A repeater was used to test the range in the case the point to point transmit receive fail to achieve a range of a mile. The reception and transmission at the repeater was done at different DSRC channels to minimize interference. Depending on the range achieved, a combination of further setups could be tried by changing the repeater and receiver position to verify the maximum reliable range. In this case the repeater also had a laptop attached to it to monitor and facilitate the testing. As before, missing and dropped packets were monitored and documented to evaluate performance.

### **2.4.1 Test Plan with Relay**

- 1) DSRC Radio with message transmitter setup.
- 2) Transmit EIRP set close to 44.8dBm
- 3) Antenna height is made practically as near 6m as possible.
- 4) The Relay DSRC radio is setup with omnidirectional antenna between the transmitter and receiver.
- 5) The Receiving DSRC radio is setup with similar antenna settings as TX at a distance of 1mile.

- 6) Message transmission is started at the transmitter and reception verified at the relay.
- 7) Message transmission is stopped and started afresh and logged.
- 8) Message received at the relay and receiver is also logged.
- 9) Message transmission is stopped and logs verified at the transmitter, relay and receiver.
- 10) Till a total range of 1 mile is achieved the Receiving DSRC radio is moved progressively and the relay transmit power varied and the steps 7-9 are repeated until there are loss of messages and the reception becomes unreliable.
- 11) Post processing is done on the data collected for detailed analysis.

## **2.5 Test Locations and Results**

The following are the chosen test locations characterized primarily by long straight stretches and also by low traffic and sparse population. Utmost consideration was given towards safety of the crew and public during testing in choosing the test locations. The chosen test locations provide a variety of operating environments viz. controlled test environment at Richmond Field Station, suburban environment along Ely Blvd. in Petaluma and rural environment along CA 37 in Petaluma. Performance in harsher radio environments in suburban areas was intended to provide perspective to the performance in friendlier radio environments in rural areas where the Augmented Speed Enforcement application is primarily targeted.

### **2.5.1 Ely Blvd., Petaluma, CA**

Ely Blvd. in Petaluma was one of the test locations. This presented a long enough stretch of road with low speed moderate traffic. It is a typical suburban road with two lanes in each direction. There are power lines on one side which switch to the other side after a distance. Figure 3 shows the location of the transmitter and locations of the receiver for both the 1mile and 1.2 mile separation.



**Figure 40 Ely Blvd., Petaluma, CA**

#### 2.5.1.1 Run 1 Parameter and Data

##### **Run 1:**

Distance between Transmitter and Receiver: 1 mile

Antenna at Transmitter: 19dBi directional

Antenna height at Transmitter: 15ft

Transmit Channel: 178

Antenna at Receiver: 19dBi directional

Antenna height at Receiver: 15ft

Receive Channel: 178

Transmit Power: 23 dB

The receiver was started first followed by the transmitter.

Average Received power: -60.8333dBm

No packets were lost.

#### 2.5.1.2 Run 2 Parameter and Data

##### **Run 2:**

Distance between Transmitter and Receiver: 1.2 mile

Antenna at Transmitter: 19dBi directional

Antenna height at Transmitter: 15ft

Transmit Channel: 178

Antenna at Receiver: 19dBi directional

Antenna height at Receiver: 15ft

Receive Channel: 178

Transmit Power: 23 dB

The receiver was started first followed by the transmitter.

Average Received power: -71.1667dBm  
No packets were lost.

### 2.5.2 CA 37 E Petaluma, CA

CA-37E in Petaluma was the location of another round of testing. It provided a rural setting to test the DSRC radio performance at a range similar to a typical maintenance work zone. The road runs straight for a few miles but presence of narrow shoulders and steep banks make testing along the road a serious safety hazard. So, a pair of locations was chosen in adjacent side roads where the testing can be staged safely as shown by Figure 4 below.



Figure 41 CA-37 E Petaluma

#### 2.5.2.1 Run 1 Parameter and Data

**Run 1:** Distance between Transmitter and Receiver: 1 mile

Antenna at Transmitter: 19dBi directional

Antenna height at Transmitter: 15ft

Transmit Channel: 178

Antenna at Receiver: 19dBi directional

Antenna height at Receiver: 15ft

Receive Channel: 178

The receiver was started first followed by the transmitter.

Transmit Power: 23 dB, 20dB, 17dB, 14dB, 12dB, 11dB

Corresponding Average Received power:

-61.2857dBm, -66.7722 dBm, -70.9174 dBm, -75.7059 dBm, -83.1068 dBm, -92.3571 dBm,

Packets started getting lost at 11dB.

Figure 5 and Table 3 show the variation of received power when the transmit power is reduced from 23dB to 11dB. The maximum, minimum and average received power were

calculated and plotted. For this setup and transmitter receiver separation of 1.1 miles in a rural setting a transmit power in the range of 20dB-17db should be adequate which is shown as the suggested operating area in Figure 5.

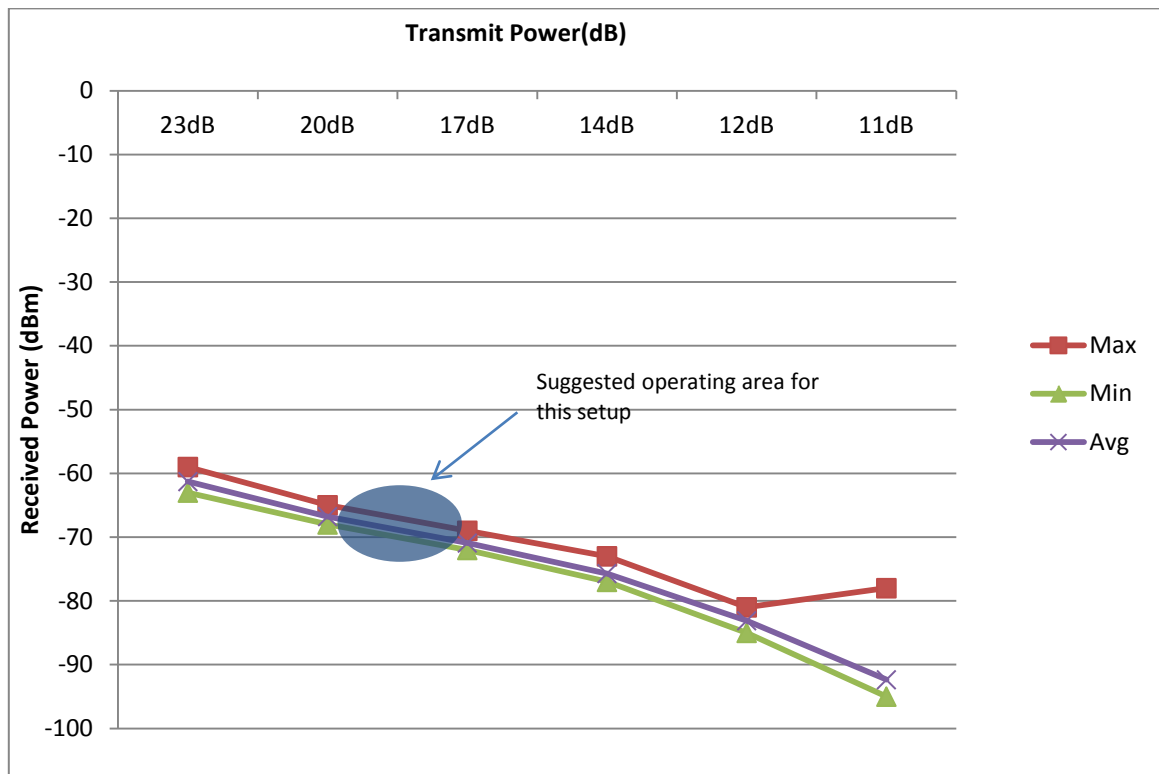


Figure 42 CA37 E - Performance at 1.1 miles

Table 8 CA37 E - Performance at 1.1 miles

	23dB	20dB	17dB	14dB	12dB	11dB
Max	-59	-65	-69	-73	-81	-78
Min	-63	-68	-72	-77	-85	-95
Avg.	-61.2857	-66.7722	-70.9174	-75.7059	-83.1068	-92.3571



### 2.5.3 Richmond Field Station

The RFS was the location where the relay functionality was tested. It provided a stretch of straight and level road segment 732 meters long measured from the parking lot in front of Bldg. 452 to the end gate near the southwest edge of RFS. It also has a road almost perpendicular to the previous road with an effective testing length of 389 meters. This geometry is especially helpful in showing the effectiveness of using relays in work zones with challenging road geometry.

Figure 4 below shows the relative locations of the transmitter, relay and the receiver laid out in an elbow configuration. The transmitter and relay are at a distance of 497 meters while the receiver was placed at a distance of 389 meters from the relay. This configuration allowed a total distance of 886 meters or 0.55 miles along the road between the transmitter and the receiver. Tall trees prevent direct link between the transmitter and the receiver in this layout. But to eliminate any packets being accidentally received directly by the receiver from the transmitter the relay receives on channel 178 from the transmitter and relays the message in channel 184 which is then received by the receiver which is already tuned to channel 184. This mechanism ensures that all packets received by the receiver are from the relay.

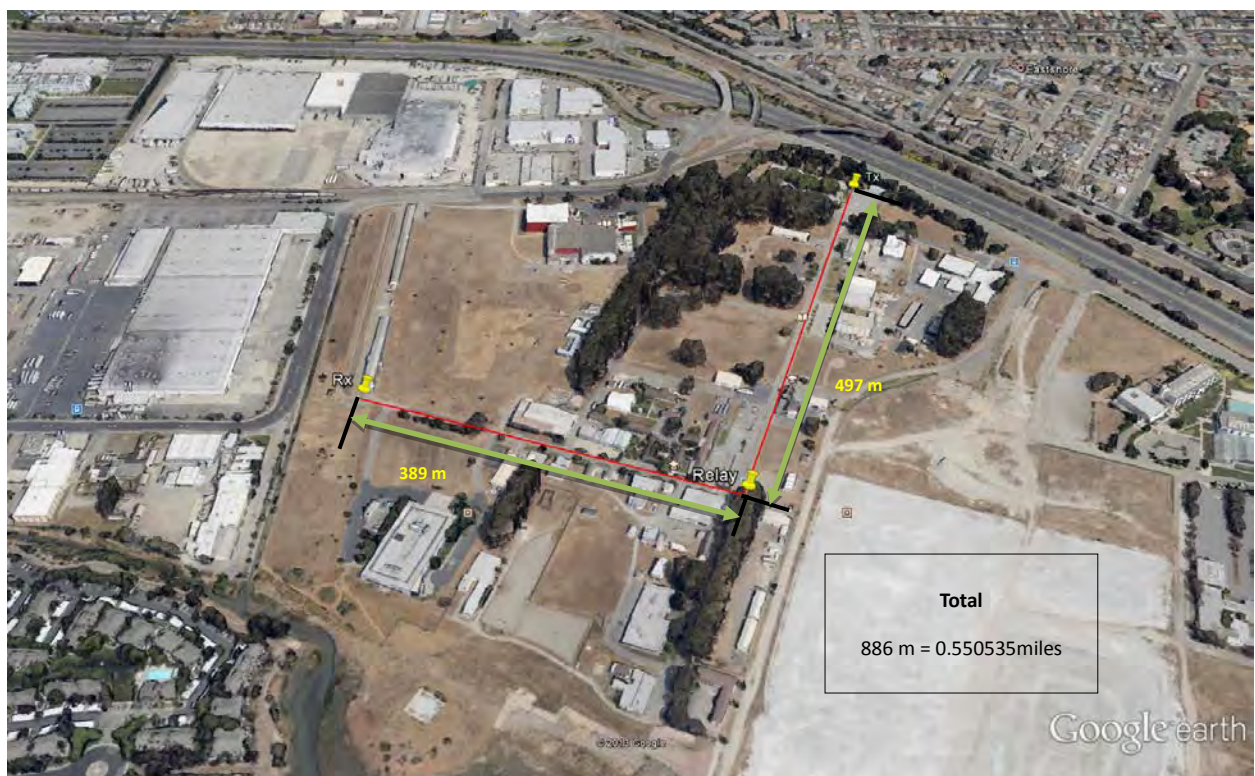


Figure 43 Richmond Field Station - Elbow Configuration

#### 2.5.3.1 Run 1 Parameter and Data

##### **Run 1:**

Distance between Transmitter and Relay: 497 m

Distance between Relay and Receiver: 389 m

Total Distance between Transmitter, Relay and Receiver: 886 meters or 0.550535 mile

Antenna at Transmitter: 19dBi directional

Antenna height at Transmitter: 15ft  
 Transmit Channel: 178  
 Transmit Power: 23 dB  
 Antenna at Relay: 12dBi omnidirectional  
 Antenna height at Relay: 15ft  
 Relay Receive Channel: 178  
 Relay Transmit Channel: 184  
 Antenna at Receiver: 19dBi directional  
 Antenna height at Receiver: 15ft  
 Receiver Receive Channel: 184

The receiver was started first followed by the relay and then the transmitter and stopped in the reverse order.

Relay Transmit Power: 23 dB, 20dB, 17dB, 14dB, 12dB, 11dB, 8dB, 5dB, 2dB  
 Corresponding Average Received power: - 61.8909dBm, -65.7477 dBm, -69.9725 dBm, -75.1262 dBm, -79.4206 dBm, -85.7913 dBm, -90.5833 dBm, -92.9808 dBm  
 Packets started getting lost at 8dB. No packets were lost at the relay

Figure 5 shows the maximum, minimum and average power at the Receiver for different transmit powers at the Relay. Figure 6 shows the Packet Error Rate at both the Relay and Receiver for the fixed transmit power of 23dB at the transmitter and different transmit powers at the relay. It also shows that there is no packet loss at the Relay while the Receiver starts losing packets at 8dB transmit power at the relay.

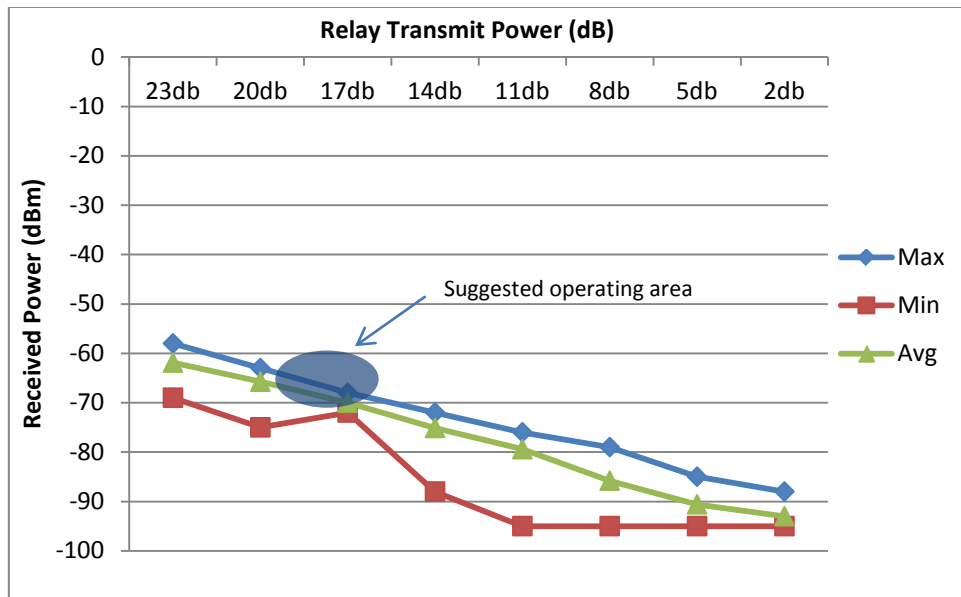


Figure 44 Richmond Field Station - Elbow configuration performance

Table 9 Richmond Field Station - Elbow configuration performance

	23db	20db	17db	14db	11db	8db	5db	2db
Max	-58	-63	-68	-72	-76	-79	-85	-88
Min	-69	-75	-72	-88	-95	-95	-95	-95
Avg.	-61.8909	-65.7477	-69.9725	-75.1262	-79.4206	-85.7913	-90.5833	-92.9808

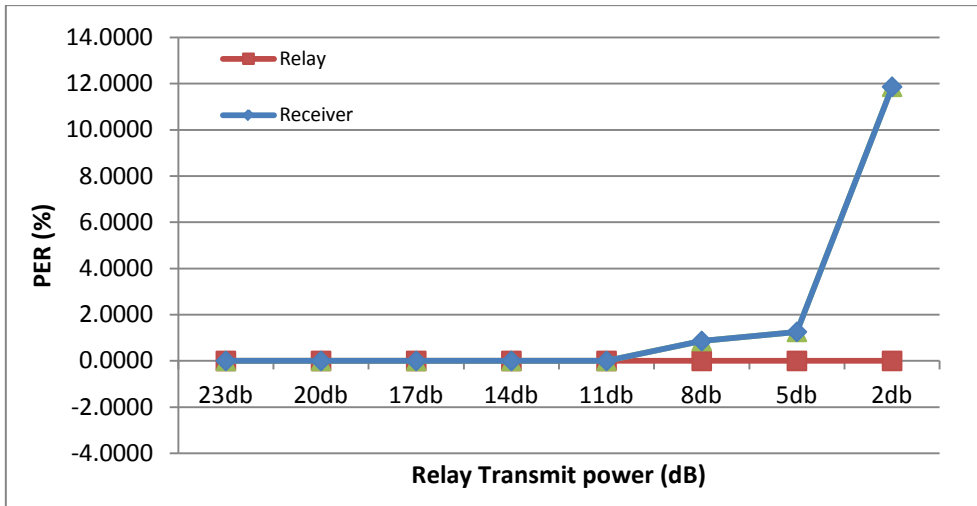


Figure 45 Richmond Field Station - Comparison of PER for Relay and Receiver in the Elbow configuration

### 2.5.3.2 Run 2 Parameter and Data

Another test, configured as shown in Figure 7, was conducted to examine the behavior at very low transmit powers with the relay at a distance of 732 meters from the transmitter and the receiver located next to the transmitter, hence 732 meters from the relay. This enhanced distance would let us form an idea about the receiver sensitivity of the receiving radios used in these experiments. We refer to this configuration as the Fold Back configuration.



Figure 46 Richmond Field Station - Fold Back Configuration

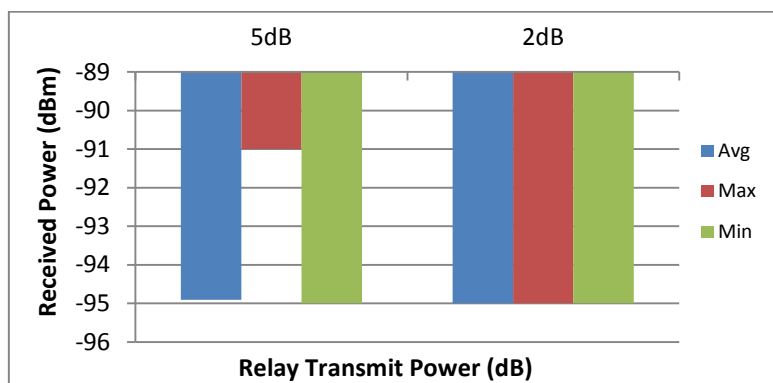
**Run 2:**

Distance between Transmitter and Relay: 732 m  
Distance between Relay and Receiver: 732 m  
Total Distance between Transmitter, Relay and Receiver: 1464 meters or 0.9096874 mile  
Antenna at Transmitter: 19dBi directional  
Antenna height at Transmitter: 15ft  
Transmit Channel: 178  
Transmit Power: 23 dB  
Antenna at Relay: 12dBi omnidirectional  
Antenna height at Relay: 15ft  
Relay Receive Channel: 178  
Relay Transmit Channel: 184  
Antenna at Receiver: 19dBi directional  
Antenna height at Receiver: 15ft  
Receiver Receive Channel: 184

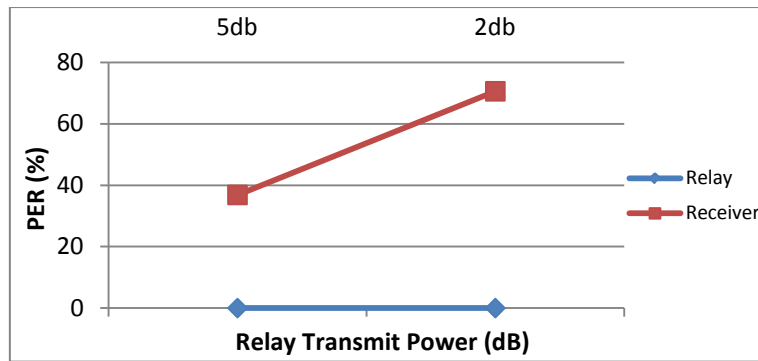
The receiver was started first followed by the relay and then the transmitter and stopped in the reverse order.

Relay Transmit Power: 5dB, 2dB  
Corresponding Average Received power: - -94.9074 dBm, -95 dBm  
No packets were lost at the relay

Figure 8 shows the maximum, minimum and average power at the Receiver for different transmit powers at the Relay. Figure 9 shows the Packet Error Rate at both the Relay and Receiver for the fixed transmit power of 23dB at the transmitter and different transmit powers at the relay. It also shows that there is no packet loss at the Relay while there is severe packet loss at the Receiver for these low transmit powers at the relay. From Figure 10 we also see that the Receiver fails to differentiate received powers lower than -95dBm, which can be designated as the observed receiver sensitivity value in our experiments.



**Figure 47 Richmond Field Station - Fold Back configuration performance**



**Figure 48 Richmond Field Station - Comparison of PER for Relay and Receiver in the Fold back configuration**

### 3. Estimate of upper bound of range under experimental conditions

Since it is not always practically possible to test larger distances in the field easily or safely we will estimate the upper bound of the range for the system we developed. It is compliant with the FCC guidelines and has the following characteristics.

- Antenna height never exceeded 15m above the roadway bed surface.
- If antenna height is more than 8m but less than equal to 15m, the EIRP should be reduced by  $20\log(\text{Antenna Height}/8)$  in dB, where Antenna Height is the height of the radiation center of the antenna in meters above the roadway bed surface.
- Channel 178 (5885-5895) - Max EIRP(dBm) = 33/44.8dB\*
- Channel 184 (5915-5925) - Max EIRP(dBm) = 33/40dB\*
- \* State and local agencies are allowed to use the higher power.
- Central Frequency 5890 MHz and 5920MHz
- Tx antenna gain 19 dBi
- Rx antenna gain 19 dBi
- Rx sensitivity -90 dBm
- Fade Margin 24 dB
- Cable losses: 10m of LMR400 - 3.39dB + one connector = 3.6dB
- Transmit Power: Varied in steps of 1dB from 12db to 23dB

Free Space Path Loss model was used to estimate the Path Loss and hence these estimates would be practical upper bounds of the range under the conditions mentioned above. In the field, based on location and environment these numbers will be different and the actual ranges achieved in the field will be somewhat lower.

Figure 10 and Table 3 show the estimated range achievable by a system, with the parameters and conditions mentioned above, considering Free Space Path Loss and a fade margin of 24dB when operating at Channel 184 (center frequency of 5920MHz). The estimated distances are shown both in miles and kilometers. Figure 11 and Table 4 shows the same information but for Channel 178 (center frequency of 5890MHz).

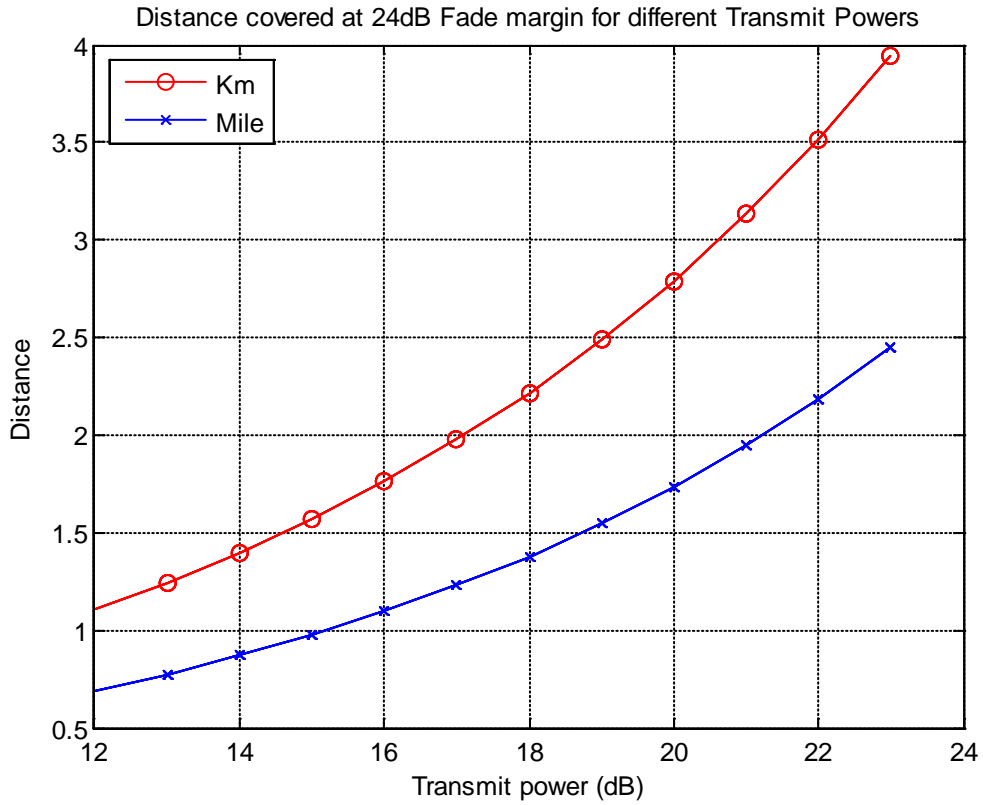


Figure 49 Channel 184

Table 10 system range at Chanel 184

Transmit Power (dB)	Km	Mile
12	1.1109	0.6903
13	1.2464	0.7745
14	1.3985	0.8690
15	1.5692	0.9750
16	1.7606	1.0940
17	1.9755	1.2275
18	2.2165	1.3773
19	2.4870	1.5453
20	2.7904	1.7339
21	3.1309	1.9455
22	3.5129	2.1828
23	3.9416	2.4492

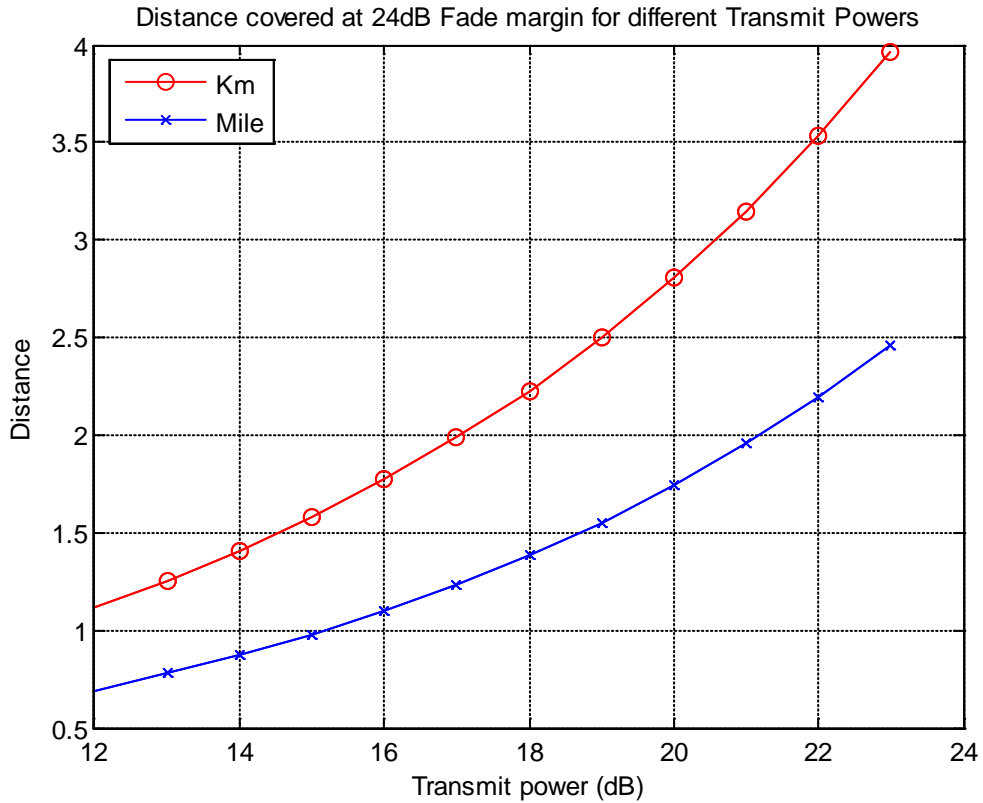


Figure 50 Channel 178

Table 11 system range at Chanel 178

Transmit Power (dB)	Km	Miles
12	1.1165	0.6938
13	1.2528	0.7784
14	1.4057	0.8734
15	1.5772	0.9800
16	1.7696	1.0996
17	1.9855	1.2338
18	2.2278	1.3843
19	2.4996	1.5532
20	2.8046	1.7427
21	3.1469	1.9554
22	3.5308	2.1940
23	3.9617	2.4617

Taking into account practical considerations, a conservative estimate of the range up to which our setup under the aforementioned conditions is reliable is 1.5 miles.

Also, expected we notice that CH 178 which has a lower central frequency of 5890MHz goes slightly further than CH 184 whose central frequency is higher at 5920MHz. Table 7 shows the difference between the theoretical system range at Chanel 178 and Channel 184. While they are small they are non-negligible and should be considered but in the scale of the

end-to-end distance of more than a mile they can be generalized. However, the system design should never be such that these differences due to different channel frequencies are detrimental.

**Table 12 Difference between the theoretical system range at Chanel 178 and Channel 184**

<b>Transmit Power (dB)</b>	<b>Meter</b>	<b>Feet</b>
12	5.6086	18.6082
13	6.3593	20.5809
14	7.1705	23.2022
15	8.0241	26.1868
16	8.9557	29.4978
17	10.0246	33.2476
18	11.2802	37.0596
19	12.6239	41.5280
20	14.1669	46.4945
21	15.9825	52.4762
22	17.8528	58.9063
23	20.1084	66.0491

#### **4. Summary of Results**

##### **4.1 Point to point**

During the testing at Ely Blvd., Petaluma, CA, no packets were lost at distances of 1.0 mile and 1.2 miles at transmit power of 23dB. This testing in a suburban area proves the capability of our setup to work in harsher radio environment and still achieve a mile long range.

During the testing at CA-37E, Petaluma, CA, a rural setting, the Transmitter and Receiver were placed 1.1 miles apart and different transmit powers were tested. At this distance packets started getting dropped at 11dB transmit powers. The distance in this test is representative of an average maintenance work zone. And based on the results it is suggested that for the same setup at this distance a transmit power range of 17db-20dB is adequate. This would help to operate the radios with transmit powers comfortably below their stated maximum of 23dB, though during our experiments we did not experience any adverse effect while operating at the maximum power for sustained durations.

##### **4.2 Relay**

With our setup we were able to reliably transmit and receive at distances of 1.2 miles thus fulfilling the primary goal of this experiment. But during the testing at Richmond Field Station we also proved a relay can be effectively used to transmit messages without any perceptible delay or loss of information. The downside of the relay is added complexity to any system trying to deploy it in the field. To reduce some complexity an omnidirectional



antenna was used at the relay while the alternative was two direction antennas with the added problem of pointing them properly. Thus the omnidirectional antenna provided an optimal solution between range and system and deployment complexity. It also demonstrated the use of relay in locations with unfavorable road geometry. With our 12dBi omnidirectional antenna at the relay the system can transfer a message reliably another 0.5km further. Of course use of higher power antennas can increase that distance.

### 4.3 Range Performance and Observations from Field Tests

Figure 12 presents the performance of the system with the transmit power set at 23db at distances of 1 mile, 1.1 mile and 1.2 mile. The first and the last ones are in a suburban setting and the middle one in a rural setting. It is seen that the difference between the maximum and minimum received powers in the rural setting is less than the suburban setting. Also, analyzing Table 8 we see that the standard deviation of the various readings in rural environment is less proving that the rural test location indeed had a friendlier radio environment. The fact that the system worked well in the suburban setting with harsher radio environment shows the robustness of the system and bolsters the fact that will work well in rural environments as demanded by the aSE system.

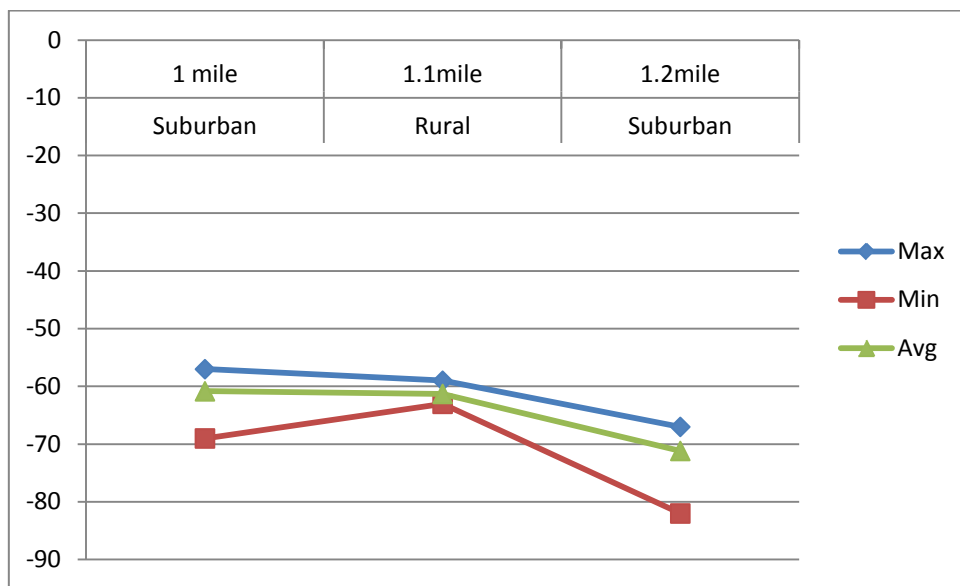


Figure 51 Performance at 23dB transmit power at various distances

Table 13 Performance at 23dB transmit power at various distances

	Suburban	Rural	Suburban
	1 mile	1.1mile	1.2mile
Max	-57	-59	-67
Min	-69	-63	-82
Avg.	-60.8333	-61.2857	-71.1667
Stdev	1.769283	0.85733	2.567847

### Acknowledgement

1. <http://www.talleycom.com/store/pdf/MRSMA-WA57-3HG1.pdf>
2. <http://www.mobilemark.com/images/spec%20sheets/pg%20117%20%20ECO%20OD%20Series-spec.pdf>
3. <http://www.timesmicrowave.com/products/lmr/downloads/22-25.pdf>
4. Theodore Rappaport. 2001. *Wireless Communications: Principles and Practice* (2nd ed.). Prentice Hall PTR, Upper Saddle River, NJ, USA.

### Acknowledgement

We would to thank John Spring, our colleague at PATH, and Yaoqiong Du, graduate student of University of California at Berkeley for their kind support during the field tests.

### Pictures from the field test

