

# **UC Office of the President**

## **Human Memory and the Learning Process**

### **Title**

Search processes in recognition memory

### **Permalink**

<https://escholarship.org/uc/item/04s9s089>

### **Authors**

Atkinson, Richard C.  
Herrmann, Douglas J.  
Wescourt, Keith T.

### **Publication Date**

1980

Peer reviewed

# 5 || SEARCH PROCESSES IN RECOGNITION MEMORY<sup>1</sup>

Richard C. Atkinson, Douglas J. Herrmann, and Keith T. Wescourt  
*Stanford University*

## INTRODUCTION

This paper is concerned with a theoretical account of some phenomena in the field of recognition memory. Many tasks have been used to study the recognition process (for a review see McCormack, 1972, and Kintsch, 1970), but we will focus on a particular procedure that has been extensively investigated in recent years. This task, introduced by Sternberg (1966) and often referred to as "memory scanning," involves a series of discrete trials. On each trial a test stimulus is presented, and the subject is required to decide whether or not the stimulus is a member of a previously defined target set. The subject is instructed to make a positive ("yes") response if the test stimulus is from the target set, and a negative ("no") response otherwise. The target sets in the experiments to be discussed range in size from just a few to as many as 60 items (usually words). When the set is large, subjects are asked to memorize it prior to the sequence of test trials; when the set is relatively small, it is presented at the start of each trial and followed shortly thereafter by the test stimulus. Under either condition errors are infrequent and the principal data are reaction times (RT).

In this paper we examine a series of experiments on memory scanning in terms of an extremely simple set of models that are all variants of one basic model. The models incorporate only those assumptions necessary for treatment of the phe-

<sup>1</sup>This research was supported by grants from the National Institute of Mental Health (MH21747) and the National Science Foundation (NSFGJ-443X3). The second author was on a Research Training Fellowship from the Social Science Research Council during the period this paper was written, and the third author was on a National Science Foundation Graduate Fellowship.

nomena under analysis. It should be noted, however, that the models can be regarded as special cases of a more general theory of memory (Atkinson & Shiffrin, 1968, 1971; Atkinson & Wickens, 1971; Atkinson & Juola, 1973, 1974). Thus, their evaluation has implications not only for the experiments examined here, but for the theory of which they are special cases. Before discussing specific studies, it will be useful to provide a brief overview of the theory.

### Elements of the Memory System

The elements of the memory system are diagrammed in Fig. 1. The system is divided into a memory storage network and control processes. The sensory register (SR), short-term store (STS), and long-term store (LTS) comprise the memory storage network. Information from the environment enters the system

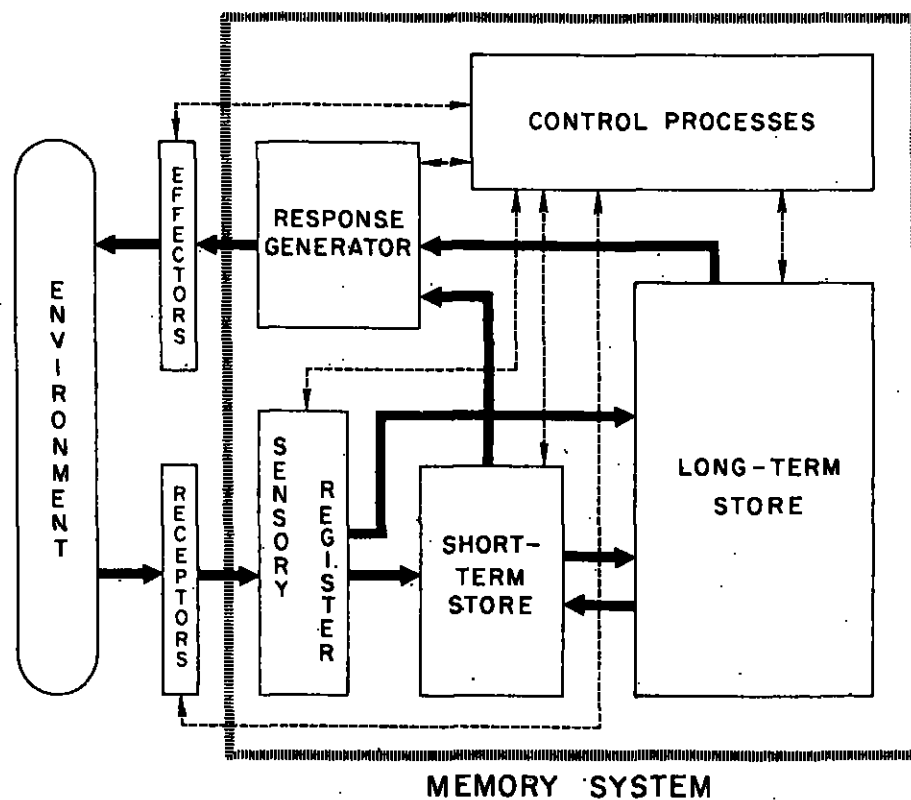

FIG. 1. A block diagram of the memory system. Solid lines indicate paths of information transfer. Dashed lines indicate connections that permit comparison of information arrays residing in different parts of the system; they also indicate paths along which control signals may be sent which modulate information transfer, activate rehearsal mechanisms, set decision criteria, alter biases of sensory channels, initiate the response generator, etc.

through the SR and is retained there briefly while pattern recognition is initiated. The STS is a working memory of limited capacity from which information decays fairly rapidly unless maintained by control processes such as rehearsal or imagery; the contents may be thought of as the "current state of consciousness" for the subject. The LTS is a large and essentially permanent memory bank. Information stored there is normally never lost, but the effectiveness of retrieval processes determines its availability for further use. Although the different components of the memory storage network are represented as separate boxes in the figure, these need not correspond to different neurological systems; rather, the different components of the system may simply represent different phases of activation of a single neurological system. The control processes regulate the flow of information between components of the network and the application of particular storage and retrieval processes within components. Control processes are adaptive with regard to the environment and demands of a task, and are in part under the conscious control of the subject. They include selective attention, rehearsal, choice of retrieval cues, and all types of decision strategies.

### Representation of Information Within the System

Information enters the system from the environment at the SR. This information, if attended to, is processed by pattern-recognition routines. The function of these routines is to transform various exemplars of the "same" stimulus into a unitary representation within the particular physical modality (e.g., auditory or visual) of the input. We will refer to these representations of a stimulus as its *perceptual code*. A perceptual code is specified in terms of a set of primitive features and does not convey information about the referents or meanings of the stimulus. The code may be thought of as an ordered list of features sufficient to locate the stimulus in an  $n$ -dimensional space; the dimensions of the space represent the ranges of values of an orthogonal set of perceptual features.

We are not concerned in this paper with variability in the pattern recognition process that generates a perceptual code, because the tasks considered here do not involve perceptually ambiguous stimuli. In other situations, however, where stimuli are perceptually ambiguous, variability of the perceptual codes output by the pattern-recognition process may be a significant determiner of subsequent processing. In such cases, prior context may affect pattern recognition: Information already in the system creates expectations about information about to enter. These expectations are realized by feedback processes that change parameter values within the pattern-recognition process. Thus, a particular sensory pattern may result in different perceptual codes entering the system as context is varied; for example, an "ill-formed" stimulus being seen as the number "13" or the letter "B" (Bruner & Minturn, 1955). The experiments reported in this paper involve presenting subjects with words in a consistent context and in a consistent typeface;

thus our analyses will tend to ignore the variability that is possible in initial stages of perceptual processing.<sup>2</sup>

Perceptual codes represent stimuli along perceptual dimensions. It is the case, however, that stimuli may convey information at a second level. This is particularly evident for words; they have assigned meanings with little or no dependence on their physical form. Stimuli are therefore represented within the memory system in a second form; we will call these representations *conceptual codes*. As in the case of perceptual codes, a conceptual code may be thought of as an ordered list of features specifying a point in an  $n'$ -dimensional space, where the dimensions of the space correspond to some set of primitive conceptual features (Fillenbaum & Rapoport, 1971). The conceptual code for a word does not represent its definition or full meaning. Rather, a distinction may be made between the defining and characteristic features of meaning (Lakoff, 1972; Rips, Shoben, & Smith, 1973). In this view, conceptual codes primarily represent a subset of the characteristic features of meaning. Such features indicate the classes of conceptual relations that may be entered by the concept representing a word. Reference to the conceptual dependency theory of language understanding developed by Schank (1972) can make this more substantive. Consider the conceptual code for some verb. It indicates the class of ACTs (primitive actions) that the verb maps into, the classes of "picture-producers" (concrete nouns) that form conceptual dependencies with the verb, and perhaps those aspects of the verb's meaning that differentiate it from other verbs mapping into the same ACT class.

Conceptual codes available to the memory system are permanently stored and organized within a functional partition of LTS that will be referred to as the conceptual store (CS). Each conceptual code and the array of perceptual codes linked to it form what will be called a CS-node. Thus, the sight of an actual dog, the auditory perception of the spoken word, the display of the printed word, etc., each has a perceptual code; the linking of these perceptual codes to a single conceptual code form a CS-node. It is the case that synonymous stimuli will have their various perceptual codes linked to a single conceptual code, and homographic or homophonic stimuli will result in identical perceptual codes being linked to different conceptual codes.

Perceptual and conceptual codes are the basic elements of *memory structures* stored within a second partition of LTS that we call the event-knowledge store (EKS). Events and episodes are recorded in EKS by linking together copies of codes or parts of codes that correspond to the patterns of stimuli entering the system from the environment. The EKS may be represented as an  $n''$ -dimensional space, where the dimensions are all those that characterize perceptual and con-

<sup>2</sup>Although we develop the memory system here on the basis of tasks involving words as stimuli, analogous processes are assumed to operate in the coding of visual scenes and nonverbal auditory stimuli. The sensory patterns produced by such stimuli are analyzed by the pattern recognition process and the resultant perceptual codes are then available for further processing. Just as for words, these codes characterize nonverbal stimuli as lists of primitive physical features.

ceptual codes and also include other dimensions (i.e.,  $n' > n + n'$ ). These other dimensions correspond to the temporal and spatial features between stimuli that underlie events and also to features (such as "superset," "subset," and "has-as-pari") that relate concepts to other concepts. Each memory structure is stored at a point in the EKS space. The position of this point in the  $n'$ -dimensional space may be a function of a subset of the features within the memory structure, but may also reflect features of codes processed at the time the structure was formed but not included in the structure. In this sense, the location of a memory structure in EKS is less determined by its contents than is the location of a node in the CS.

We wish to emphasize that the CS and EKS are not assumed to be independent structures. It seems intuitive that structures in CS evolve over a period of time as a result of repeated experience with some stimulus in a number of different episodes. These episodes provide a basis for inferring that a particular stimulus enters only particular classes of conceptual relations. For example, a bird tends to be an actor for only certain types of acts, and similarly, an act such as eating tends to have a restricted class of objects—namely, those that are "edible." Such generalizations develop with experience and are represented in the conceptual code that is linked to particular perceptual codes. Obviously, the perceptual code generated by the presentation of a novel stimulus, such as "durp," will not be located at any existing node in CS. However, if "durp" were to become the name of a new soft drink, a CS node for it would eventually be formed. The conceptual code at this node would be a list of features such as "liquid," "non-acting-picture-producer," "object-of-INGEST-ACT," etc. (These and any other "features" used in this paper are not intended as actual primitives but are used for illustrative purposes only.)

We next consider the processes by which information in LTS is retrieved. The organization of CS in terms of feature dimensions provides a basis for a content-addressable retrieval process (Shiffrin & Atkinson, 1969). Thus, the retrieval of information from CS can be quite rapid, requiring no "conscious" search. Once a CS node is located, all the codes stored there become available to the system. Difficulties may occur in this process only if perceptual input is "noisy," or if the perceptual code is stored at more than one CS node. In the former case, the perceptual code may be incomplete, requiring an examination of several nodes (possibly leading to errors based on physical similarity). In the latter case, only one of the nodes may be the "correct" one, in which case conceptual features of the context may serve to locate the appropriate node. The utilization of context in searching CS is obvious when we consider that homophonic and homographic words are seldom recognized as ambiguous in context. Puns and many jokes have their effect because they create a context that deliberately locates two senses for an ambiguous word.

The location of a memory structure in EKS is also a directed search process, but it is not strictly content-addressable like the CS search process. Since the original

placement of a memory structure may reflect only partially the features of its member codes, it will often be the case that several memory structures in EKS will need to be examined. The initial avenues of entry into EKS will be determined by the features of the retrieval context (Tulving & Thomson, 1973). Subsequent search may be directed by features of codes retrieved from other memory structures. Such a search will be relatively slow and will often become "conscious" as memory structures are examined and further dimensions of search are selected.

### Application to Memory Scanning

The distinctions made here between perceptual codes, conceptual codes, CS nodes, and memory structures in EKS are not arbitrary. Rather, they reflect the subject's ability to process information at different levels of complexity ( Craik & Lockhart, 1972). Two exemplars of a word, one in capitals and the other in lower case, may be judged "different" or "same" depending on whether the decision criteria involve physical or semantic similarity; in the former case, a comparison between two perceptual codes is the basis of the decision, whereas, in the latter case, two different perceptual codes associated with the same CS node lead to the judgment that the words mean the same. A somewhat analogous same-different decision is made in EKS if a subject must judge whether or not a given pair of test words are both members of a previously memorized list. In this case, a match must be sought between the codes for the two test words and the codes in the EKS structure associated with the memorized list.

In subsequent sections of this paper, we consider a series of memory-scanning experiments and analyze them in terms of models derived from the theory outlined above. To introduce these analyses, it will be helpful to provide a brief overview of how the theory is to be applied. We consider first the case where the target set is very large and stored in long-term memory, and then the case where the target set involves only a few items and is in short-term memory.

In the long-term case, the list of target words must be memorized prior to the sequence of test trials. As the subject attends to each word during learning, a perceptual code is produced by the pattern-recognition process. That code is then mapped onto the appropriate CS node. At that time, alternative perceptual codes and/or the conceptual code may be copied into STS. Because STS has limited capacity, the addition of new codes as more words are studied results in the loss of codes already in STS. We suppose that control processes act to organize the words on the target list, that is, the subject attempts to maintain in STS codes that are similar along some dimensions. This array of codes is then copied into a memory structure in EKS. The location of this structure can be thought of as a point in EKS defined by values on each of the dimensions of EKS; of course, for any particular structure many dimensions may not be specified. The values that define the point will be those that are common to codes in the memory structure;

they will also be determined by the context in which the list is learned (psychology experiment, etc.) and temporal factors. For simplicity, we usually assume that the entire target list is represented by a single memory structure located at a particular point in EKS. Obviously, this need not always be the case. There may be situations where a trade-off exists between one large structure and several smaller ones that are dispersed. In an experiment to be considered later (involving categorized memory lists) a single memory structure is formed for the entire list plus separate structures for each category sublist.

Once the memory structure for the list has been formed in EKS, the test phase of the experiment can begin. The subject's task is to compare a coded representation of the test stimulus against the codes in the memory structure, to determine if the probe is a target or a distractor. In our experiments the subject has no difficulty in locating the memory structure in EKS; this is evident by the fact that he can recall the list with no difficulty at any time during the experiment. Thus, we assume that contextual and temporal cues permit the search process to locate the memory-list structure rapidly and with little variability.

When a test word is presented, initial processing generates a perceptual code which is quickly mapped onto the appropriate CS node (see Fig. 2). Prior to extracting a code from the CS node to scan against the list's memory structure in EKS, the monitoring process may apply a special test. The test measures the activity level of the node associated with the test word; the node's activity level is a function of how frequently and how recently the node was accessed. We refer to the activity level of a CS node as its *familiarity value*. The node does not contain

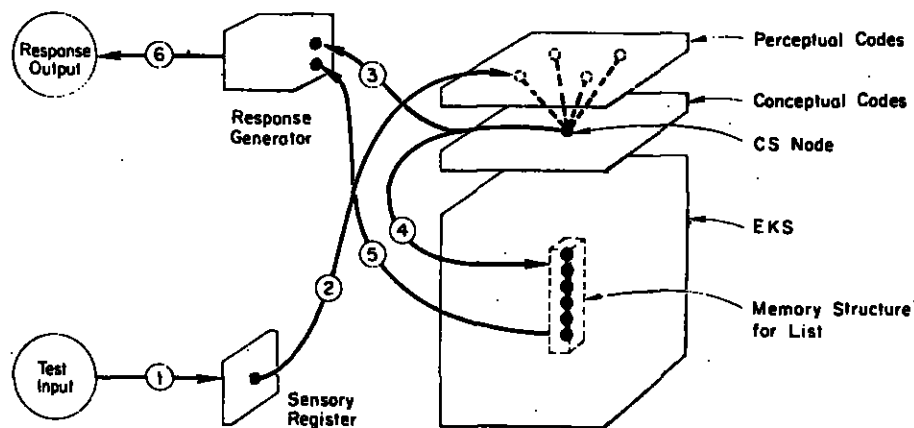

FIG. 2. A block diagram illustrating the processes involved in determining whether or not a test stimulus is a member of a "large" target set stored in LTS. Component processes are as follows: (1) input of test stimulus to sensory register; (2) pattern-recognition process leading to a mapping of test stimulus onto a perceptual code, and in turn access to the conceptual code; (3) immediate decision to respond based on familiarity; (4) selection of code to be scanned against memory structure in EKS; (5) decision to respond based on scan of the list's memory structure; (6) response output.



information about whether or not the test word was on the memory list, but its activity level does indicate the familiarity of the word.<sup>3</sup> Under some conditions, the location of a node with a relatively high or relatively low familiarity value may lead the subject to respond immediately without searching EKS. If the retrieved familiarity value is above a "high criterion" value, the subject may assume that the item was recently presented and thus is very likely to be a member of the target list; for a familiarity value below a "low criterion," he assumes that the item has not been recently presented and thus is unlikely to be on the target list. In the former case, the subject makes a quick positive response; in the latter case, a quick negative response. For intermediate familiarity values, an appropriate code is extracted from the CS node and compared with codes of the list's memory structure in EKS. The success of the comparison will lead to either a positive or negative response, thereby terminating the trial.<sup>4</sup>

Similar processes are assumed to operate when the target set is small (1 to 5 items) and varies from trial to trial. In this case, the target set is represented in STS as an array of perceptual and/or conceptual codes. When a test word is presented, precisely the same process described above is involved in estimating the item's familiarity value. If the retrieved familiarity value is above a high criterion or below a low criterion, the subject makes an immediate response; otherwise, a code for the test stimulus is extracted from its CS node and compared with the set of codes in STS. Thus, the process underlying recognition of information in EKS and STS is the same. However, differences between the memory stores may cause different codes to be preferred in each; evidence for this comes from a number of sources (Broadbent, 1970). The experiments to be described here also support the view that information may be encoded differently in EKS and STS.

Decisions about which memory stores to search and in turn which information structures to examine depend upon the context in which testing occurs, as well as feedback to the subject about the effectiveness of prior processing strategies. For example, the specific instructions used in an experiment will determine whether a subject relies on familiarity alone to make a decision or executes an extended search of memory. If the experimenter's instructions emphasize speed, then fa-

<sup>3</sup>Stated more precisely, the familiarity value must be considered as current activity level *relative* to baseline level such that the relative increase in activity due to accessing a node is less for more frequently accessed nodes. This interpretation is necessary if we are to account for the fact that subjects do not generally false alarm to their names or other very high-frequency words when these are inserted as distractors in a recognition test. Atkinson and Juola (1973; p. 602) report a study which included word frequency as an independent variable. Subjects responded to low-frequency words (both targets and distractors) faster than to high-frequency words. This means that low-frequency target words had higher familiarity values than high-frequency target words, but that low-frequency distractors had lower values than high-frequency distractors. The former relation depends on low-frequency words getting a greater boost in familiarity during study, and the latter relation depends on high-frequency words having more fluctuations from baseline activity due to extra-experimental events.

<sup>4</sup>See Mandler, Pearlstone, and Koopmans (1969) for a similar conception of recognition memory.

miliarity will play a key role; if accuracy is emphasized, then the slower memory search will occur. Thus, the high and low criteria for judging familiarity are determined by the speed-accuracy trade-off that the subject regards as acceptable.

The theory has been described in very general terms, and we turn now to specific applications. The first application deals with experiments employing small target sets (1 to 5 items) stored in STS. The second application involves large memory sets (60 or more items in some cases) stored in EKS. The third application considers scanning experiments where the target set involves some items stored in STS and others in EKS; experiments of this sort permit us to make direct comparisons between search rates in EKS and STS, and to examine the parallel versus serial search of these stores. The last two applications deal with target lists that are categorized; the questions of interest are how and under what conditions the category information may be used in making a response decision. Because the memory system is stratified so that information can be represented in several different stores (and in different memory structures within a store), performance in even simple tasks often depends upon a complex "mixture" of underlying processes. Our goal is not to build the simplest possible model for the set of experiments examined, but rather to analyze these experiments within the framework of a theory that is applicable to a wide range of phenomena.

### MEMORY SEARCH WITH SMALL TARGET SETS

The first experiments to be considered involve the search of short-term memory; the specific studies are variants on the type of scanning task investigated by Sternberg (1966, 1969a, 1969b, 1971). On each of a series of trials, the subject is presented with a memory set of from one to six words; the words in the memory set are "new" in the sense that they have not been presented on any prior trials of the experiment. When the subject has the memory set in mind, a test word is presented visually; the subject makes a positive response if the test word is in the memory set, and a negative response otherwise. The typical finding is that reaction time for both the positive and negative responses are linearly increasing functions of memory-set size, and that the slopes of the two functions are roughly equal.

The theoretical account of this type of experiment is schematically represented in Fig. 3. The memory set is temporarily stored in STS. When the test word is presented, it is encoded and mapped onto its CS node. Although the CS node does not contain a tag or marker indicating that the test word was in the memory set, it does have information about the familiarity of the word. If the subject finds a very high familiarity value, he gives an immediate positive response; if he finds an extremely low value, an immediate negative response is given. If the familiarity value is intermediate, the subject must then take the test word and scan it against the memory set in STS. If the scan yields a match, a positive response is made; otherwise, a negative response. When the familiarity value is intermediate,

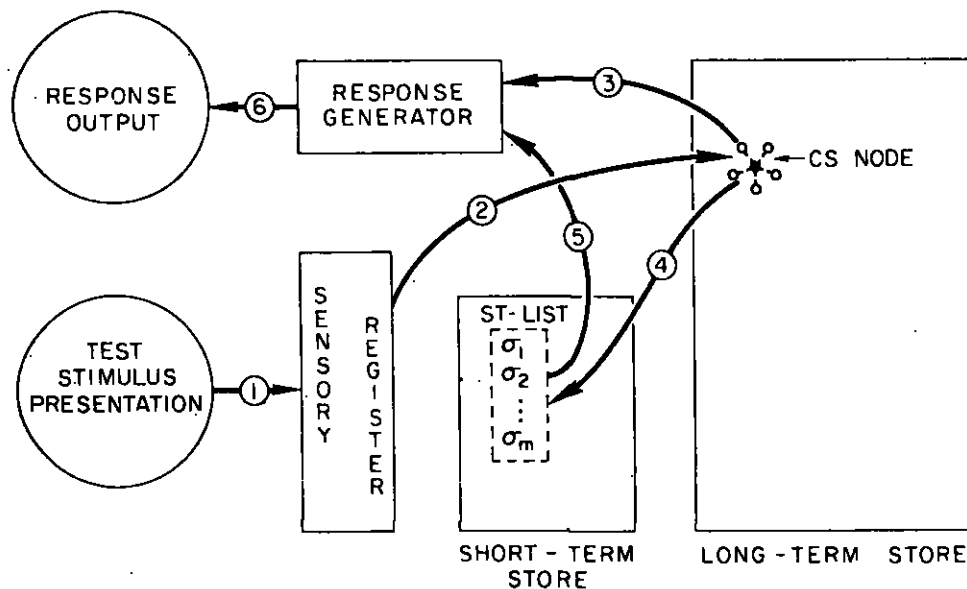

FIG. 3. A schematic representation of the search-and-decision processes in a short-term recognition memory study. A test stimulus is presented (1) and then matched to a CS node (2). The familiarity value associated with the node may lead to an immediate decision (3) and response output (6). Otherwise, a code is extracted and scanned against the target list in STS (4), which leads to a decision (5) and subsequent response (6). Path (1), (2), (3), (6) represents a much faster response process than Path (1), (2), (4), (5), (6), and it is independent of the size of the STS set.

the speed of the response is much slower and depends on the number of words in the memory set. Thus, for very high or very low familiarity values, the subject makes a fast response that does not depend on the memory-set size; for intermediate values a slower response occurs that is an increasing function of memory-set size.

The observed response latency averaged over trials is then a mixture of fast decisions based on familiarity alone (independent of memory-set size) and slower decisions based on a search of STS (dependent on memory-set size). The likelihood of bypassing the search of STS depends on the distribution of familiarity values associated with targets and distractors. Figure 4 presents familiarity distributions associated with a target word and a distractor. When a test word is presented, a familiarity value is sampled from the appropriate distribution. If the familiarity value is above a high criterion  $c_1$ , the subject makes an immediate positive response; and below a low criterion  $c_0$ , an immediate negative response. Otherwise, a search of STS is executed. It is assumed that the subject never makes an error if a search of STS occurs; however, if the search is bypassed, then an error will occur whenever the test word is a target with a familiarity value below  $c_0$  or a distractor with a familiarity value above  $c_1$ . Note that the proportion of test words that lead to a search of STS depends on the placement of the criteria. The probability distribution of familiarity values,  $x$ , for targets and dis-

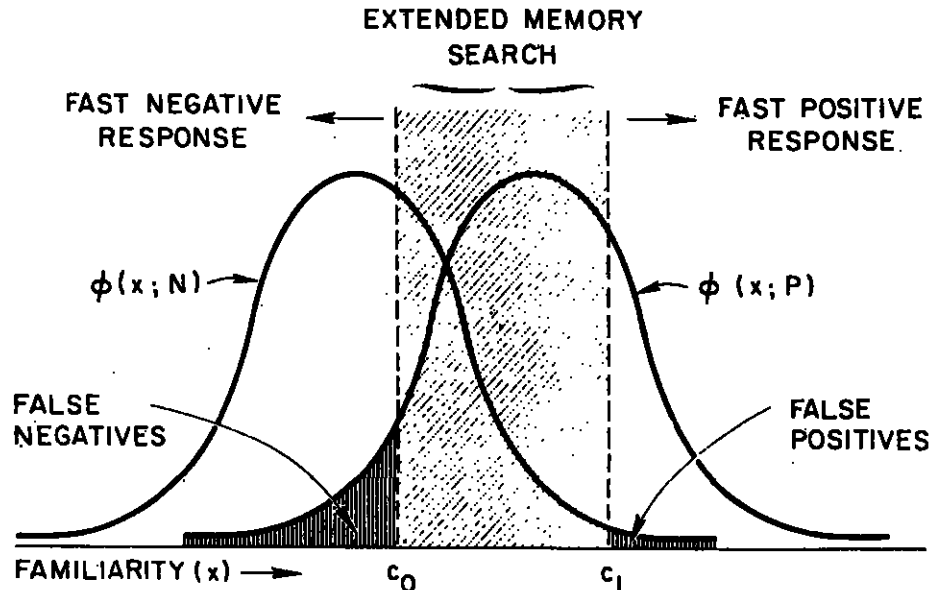

FIG 4. Distributions of familiarity values for distractor items,  $\phi(x;N)$ , and target items,  $\phi(x;P)$ .

tractors will be denoted as  $\phi(x;P)$  and  $\phi(x;N)$ , respectively; for present purposes these distributions will be assumed to be unit-normal with means  $\mu_P$  and  $\mu_N$ . (We use  $P$  for the target distribution because a positive response to a target is correct, and  $N$  for the distractor distribution because a negative response to a distractor is correct.) Later it will prove useful to know the probability of having made a search of STS given that the subject generated a correct response; this probability is denoted as  $s$  for targets and  $s'$  for distractors. As shown in Fig. 4, the probability that a correct response to a target involved a search of STS is the probability of a positive response based on a search of STS divided by the overall probability of a positive response; namely,

$$s = \frac{\int_{c_0}^{c_1} \phi(x, P) dx}{\int_{c_0}^{\infty} \phi(x, P) dx} \quad (1)$$

Similarly, the probability that a correct response to a distractor involved a search of STS is

$$s' = \frac{\int_{c_0}^{c_1} \phi(x, N) dx}{\int_{-\infty}^{c_1} \phi(x, N) dx} \quad (2)$$

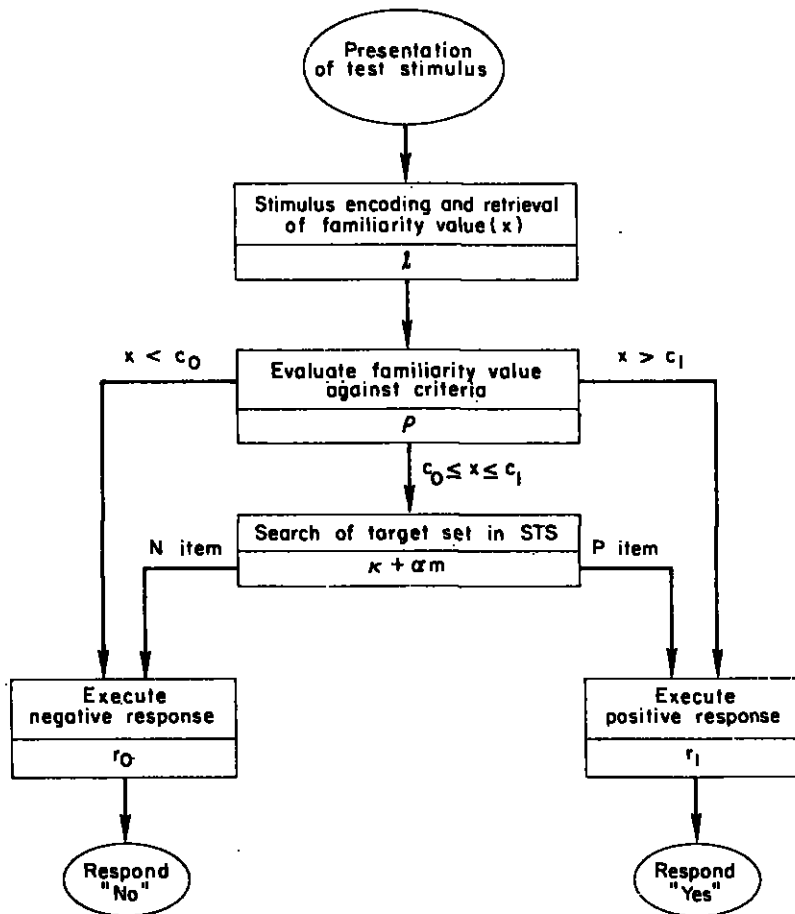

FIG. 5. Representation of the processing stages underlying recognition performance when the target set resides in STS. When stimulus familiarity is greater than  $c_1$  or less than  $c_0$ , a rapid positive or negative response is executed; otherwise, the encoded test stimulus is scanned against the contents of STS, leading to the appropriate response.

The preceding discussion can be summarized by referring to the flow chart in Fig. 5. Noted in the figure are the times associated with each stage. Certain stages must be executed for all probes; namely, encoding ( $l$ ), evaluation of the familiarity value ( $p$ ), and response execution ( $r_0$  for a negative response and  $r_1$  for a positive response). For probes of an intermediate familiarity value, the additional stage of searching STS is necessary. It is assumed that this search takes time  $\kappa + \alpha m$  where  $m$  denotes the size of the memory set;  $\kappa$  is the time to initiate the search of STS, and the search is proportional (with parameter  $\alpha$ ) to the size of the memory set. This linear search function corresponds to the exhaustive case of the serial-scanning model proposed by Sternberg (1969a). While Sternberg's model has proved to be extremely valuable in interpreting a variety of memory-

search experiments, good fits between the model and data do not require that the underlying process be either serial or exhaustive (for a discussion of this point see Townsend, 1971, and Murdock, 1971). Thus the use of a linear search function does not commit us to specific assumptions about whether the search is serial or parallel, self-terminating or exhaustive.

In terms of the time constants given in Fig. 5, expressions can be written for the latency of various types of responses. First note that an error to a target item takes time  $l + \rho + r_0$ , whereas an error to a distractor takes time  $l + \rho + r_1$ .<sup>5</sup> Expressions for correct responses are more complicated. We let  $t(P)$  denote the response time for a correct response to a target (i.e., the time for a positive response) and  $t(N)$  denote the response time for a correct response to a distractor (i.e., the time for a negative response). Recalling the definitions of  $s$  and  $s'$ , we can write the following expressions:

$$\begin{aligned} t(P) &= (1 - s)[l + \rho + r_1] + s[l + \rho + \kappa + \alpha m + r_1] \\ &= (l + \rho + r_1) + s(\kappa + \alpha m), \end{aligned} \quad (3)$$

$$\begin{aligned} t(N) &= (1 - s')[l + \rho + r_0] + s'[l + \rho + \kappa + \alpha m + r_0] \\ &= (l + \rho + r_0) + s'(\kappa + \alpha m). \end{aligned} \quad (4)$$

Examining these equations, we see that both  $t(P)$  and  $t(N)$  increase linearly with set size. In many experiments (see Sternberg, 1969a), the slope of the negative and positive functions are roughly equal, and this would be the case when  $s$  equals  $s'$ . The condition under which  $s$  equals  $s'$  requires that  $c_1$  and  $c_0$  be set symmetrically (i.e., the tail of the target distribution below  $c_0$  must equal the tail of the distractor distribution above  $c_1$ ). The linear predictions for  $t(P)$  and  $t(N)$  are based on the assumption that the criteria do not vary with  $m$ ; a correlated implication of this statement is that error rates also do not vary with  $m$ . Of course, in some experiments (especially where  $m$  is fixed over a block of trials), it is possible that the subject adjusts  $c_1$  and  $c_0$  as a function of the memory-set size. For example, when  $m$  is large the subject may anticipate a slow response and compensate by adjusting the criteria to generate more fast responses based on familiarity alone. Under these conditions errors would increase with  $m$ , and RT curves would be curvilinear.

The predictions outlined above are consistent with a number of experimental

<sup>5</sup>The model predicts that error latencies are "fast" since they are the result of decisions based upon familiarity alone: Whenever the memory set is searched, it is assumed that a correct response always occurs. While this assumption is reasonable for the tasks described here, it is the case that "slow" errors (resulting from a failure in the search process) will occur in other situations. Such errors would be expected when acquisition of the memory set is less than perfect. They might also occur when instructions emphasize speed of response; subjects in this case could establish an upper bound on the time they will search the stored memory set before "guessing."

results (Atkinson & Juola, 1973, 1974). In this sense, the model has proved to be quite satisfactory. However, these goodness-of-fit demonstrations have not directly tested the role of familiarity in a short-term-memory scanning task. With this in mind, Charles Darley and Phipps Arabie designed and ran a study at Stanford University which attempted to experimentally manipulate familiarity. The study was basically like the prototype experiment described at the beginning of this section. Memory-set size varied randomly from trial to trial, taking on values from 2 to 5 items. Each memory set involved new words (i.e., words that had not been used on any prior trial); the test word was a target on half the trials and a distractor on the other half. The only difference from the prototype experiment described at the outset of this section was that distractors were not always new words, thus permitting the experimenters to manipulate their familiarity values.

In accord with prior notation, the presentation of a target as the test word will be called a P-trial to indicate that a positive response is correct; the presentation of a distractor will be called an N-trial to indicate that a negative response is correct. In this experiment the distractors were of three types: new words never presented before in the experiment (denoted  $N_1$  since the word was presented for the first time); words that had been presented for the first time in the experiment as distractors on the immediately preceding trial (denoted  $N_2$  since the word was now being presented for the second time); and words that had been presented for the first time on the immediately preceding trial both as a member of the memory set and as a positive test word (denoted  $N_3$  since the word was now being presented for the third time). Thus, there were four types of test words (P,  $N_1$ ,  $N_2$ , and  $N_3$ ), and we assume that different familiarity values are associated with each. Figure 6 presents a schematic representation of the four familiarity distributions. The mean of the P-distribution should be the largest since the test word on a P-trial is a member of the current memory set and should be very familiar; likewise, the mean of the  $N_1$ -distribution should be smallest because  $N_1$  words are completely new; the other two means should be intermediate since  $N_2$  and  $N_3$  words appeared on the prior trial. Also displayed in the figure are the criteria  $c_0$

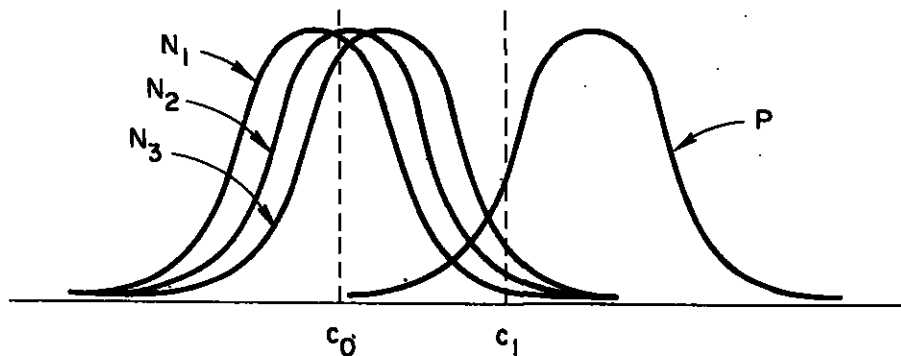

FIG. 6. Distributions of familiarity values for the three types of distractor items ( $N_1$ ,  $N_2$ ,  $N_3$ ) and for target items ( $P$ ).

and  $c_1$ , which are assumed to be the same for all trial types. This assumption is reasonable since the subject cannot predict the type of test that will occur, and thus he has no basis for varying the criteria. As can be seen from Fig. 6, an increasing amount of the distribution falls between  $c_0$  and  $c_1$  as we move from  $N_1$  to  $N_2$  to  $N_3$ . In terms of the mathematical formulation,  $s'$  defined in Eq. 2 increases from  $N_1$  to  $N_2$  to  $N_3$ . Accordingly, the likelihood of searching STS in-

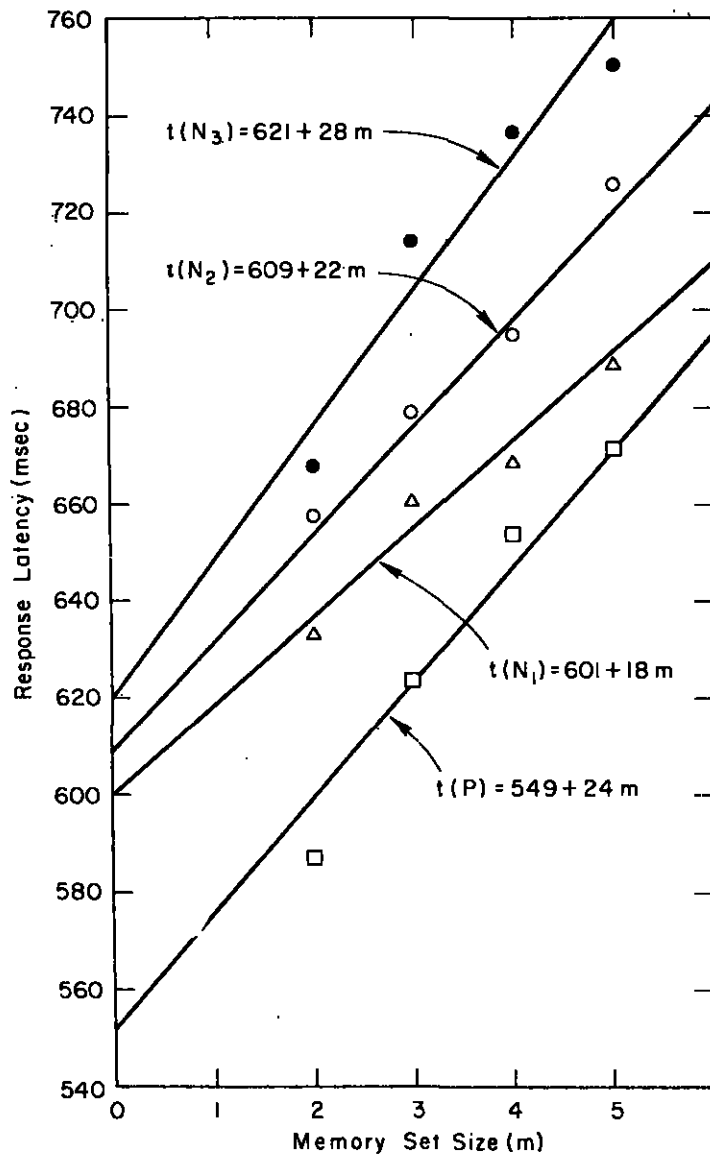

FIG. 7. Mean response latencies for the four probe types as a function of the size of the memory set. The straight lines fitted to the data represent theoretical predictions.



creases and thus the slope of the  $t(N_i)$  function increases from  $N_1$  to  $N_2$  to  $N_3$ ; for the same reason the intercept of the  $t(N_i)$  function also increases from  $N_1$  to  $N_2$  to  $N_3$ .

The latency data for the four types of probes are presented in Fig. 7. Note that latency increases with set size and is ordered such that P is fastest, and  $N_1$ ,  $N_2$ , and  $N_3$  are progressively slower. The straight lines in the figure represent theoretical predictions of the model. The derivation of theoretical equations and methods of parameter estimation are described in Atkinson and Juola (1974) and will not be reviewed here. It should be noted that the model not only predicts the response-time data, but also the probability of an error as response time varies over the four trial types. The complete set of parameter estimates is reported in Atkinson and Juola (1974), but several are given here since they play a role in later discussions, namely,

$$(l + \rho + r_1) = 499 \text{ msec} \quad \kappa = 70 \text{ msec}$$

$$(l + \rho + r_0) = 563 \text{ msec} \quad \alpha = 34 \text{ msec}$$

The results displayed in Fig. 7 indicate that the familiarity manipulation had a large and predictable effect. The predicted slope for P items was 24 msec, whereas the predicted slopes for  $N_1$ ,  $N_2$ , and  $N_3$  items ranged from 18 msec, to 22 msec, to 28 msec. If the subject ignored the familiarity value and searched STS on every trial, then all four functions would have a slope of 34 msec (the estimated value of  $\alpha$ ).<sup>6</sup>

Other experimental manipulations also should lead to variations in familiarity. The prototype experiment described at the start of this section can be viewed as involving an infinite pool of words from which the experimenter selects stimuli on each trial. Compare this procedure with one where the pool is restricted (say to 10 words), and on each trial stimuli are drawn without replacement from the pool. In the first procedure, words are never repeated during the course of an experiment; in the second procedure, repetitions occur frequently from trial to trial. The second case corresponds to the original memory-scanning study by Sternberg (1966) where the item pool was the digits from 0 to 9.

When no words are repeated, the familiarity index for targets should be substantially higher than for distractors, thereby making familiarity an effective dimension on which to make a decision. When a small pool of words is used, the

<sup>6</sup>Inspection of response time (in the final block of trials) for individual subjects indicates that they are bimodally distributed as would be expected from the theory; one mode, associated with a fast response based on familiarity alone, and the other mode for slower responses based on extended searches of memory. Analysis of RT distributions is complicated by the fact that there are too few observations on each subject, and further, that response times over-all tend to decrease during the course of the experiment. To fit the observed distributions one would have to elaborate the model to include assumptions about the distributions associated with each stage in the process, and about overall decreases in response time with practice.

familiarity value of all items will be raised, thus tending to wash out differences in familiarity between targets and distractors. Under these conditions the familiarity index will be less useful and a search of STS will be required more frequently. Support for this view comes from a study by Rothstein and Morin (1972) who ran just this type of comparison. They reported steeper slopes and higher intercepts for RT functions when the memory sets were selected repeatedly from a small pool. The repeated presentation of items increases the familiarity of all items to a high level, thereby reducing the usefulness of the familiarity measure as a basis for responding. Consequently, the probability of searching STS should be high, causing the slope of the RT function to be near its maximal value.

In addition to the relative familiarity of targets and distractors, another factor influencing the likelihood of searching STS is the placement of a subject's criteria. For example, if the subject is instructed to avoid errors, the appropriate strategy would be to set  $c_0$  and  $c_1$  relatively far apart, thereby insuring that a search will be conducted on most trials. Since the time necessary to complete a search depends on memory-set size, both over-all latency and set-size effects should be increased. Alternatively, if response speed is emphasized in the instructions, the criteria  $c_0$  and  $c_1$  should be placed close together so that most responses will be based on familiarity alone. In this case, over-all latency would be decreased and minimally influenced by set size.

William Banks of Pomona College ran such an experiment in our laboratory with the anticipated results. An entirely new set of words was presented on each trial as the memory set; set sizes were 2, 3, 4, 5, and 6 and varied randomly over trials. Targets and distractors occurred equally often, and the distractors always involved new words. Subjects served in two experimental conditions: accuracy instructions and speed instructions. The RT data for correct responses are presented in Fig. 8. If the criteria are being adjusted as suggested above, then the model predicts that the slope and intercept of the RT functions under accuracy instructions should be greater than under speed conditions. The results shown in Fig. 8 support this prediction; also, the pattern of error data is consistent with the model. Similar results have been reported by Weaver (1972) with memory sets of letters and a wider range of set sizes. It should be noted that Swanson and Briggs (1969) and Briggs and Swanson (1970) have found no differences in slope of the RT-set size function across speed and accuracy conditions. Comparison of their payoff matrices with those of Banks and of Weaver, however, suggests that Briggs's and Swanson's incentive system was not strong enough to cause subjects to adjust their criteria and rely more heavily on the familiarity measure.

## MEMORY SEARCH WITH LARGE TARGET SETS

A recognition task comparable to the one discussed in the last section can be formulated for very large target sets. Prior to the test session, the subject is required to learn a long list of words to a criterion of perfect recall; this list serves

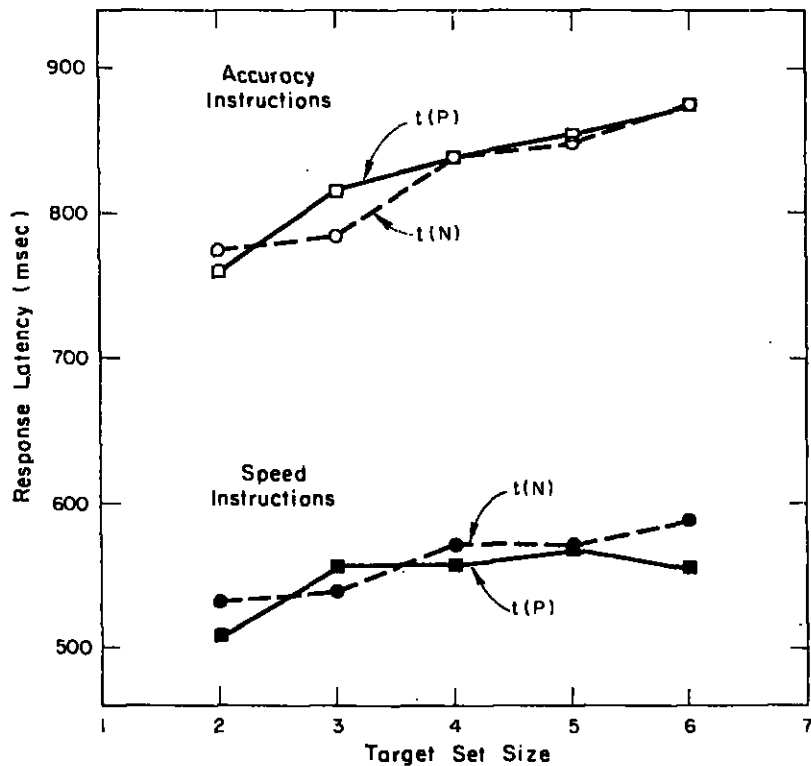

FIG. 8. Mean response latencies for P-items and N-items for five target-set-size conditions in an experiment manipulating instructions to subjects, emphasizing accuracy in one condition and speed in another.

as the memory set for the remainder of the experiment. The test session involves a series of trials where either a target word or a distractor is presented; the subject is instructed to make a positive response to an item from the list and a negative response otherwise. A number of studies have been done using this technique with target sets ranging from 10 to 60 words. These studies have been reviewed elsewhere (Atkinson & Juola, 1973) and interpreted in terms of the model presented here.

In this paper we will consider only one such study, which manipulated the size of the memory set (16, 24, and 32 words) and the number of times targets and distractors were presented during the test sequence; for a detailed account of the experiment see Atkinson and Juola (1974). Figure 9 presents RT data from the final block of test trials as a function of target set size; some words (whether targets or distractors) were presented for the first time during this final trial block, while others had been presented earlier in the test sequence and thus were receiving a repeated presentation. The left-hand panel presents RTs for correct responses to targets and distractors receiving their initial presentation in the final

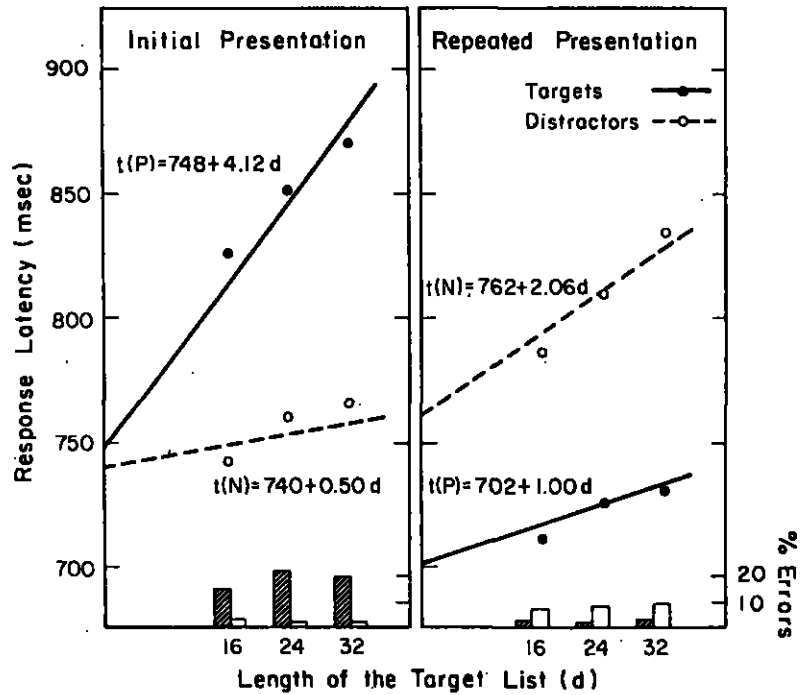

FIG. 9. Mean response latencies and error percentages as functions of target list length. The left panel presents data for initial presentations of target and distractor words, and the right panel presents data for repeated presentations. Incorrect responses to target words are indicated by the shaded bars, and errors to distractors by the open bars. The straight lines fitted to the data represent theoretical predictions.

block of test trials; the right-hand panel, for words receiving a repeated presentation. In both panels RTs increase with the size of the memory set; however, the slopes of the functions are much less than is observed when smaller memory sets are involved: It is interesting to note that repeating an item has a different effect if that item is a target word as compared with a distractor. Positive responses are slower and show a steeper slope to the initial presentation of a target word as compared to a repeated presentation of a target word; in contrast, negative responses are faster and have a more shallow slope to the initial presentation of a distractor than to a repeated presentation of one.

The model to be applied here is the same as the one developed in the last section. The only difference is that the memory set exceeds the capacity of STS, and it is assumed to be stored in EKS. Figure 10 presents a flow diagram of the process. The test item is encoded and the appropriate CS node is accessed, leading to the retrieval of a familiarity value. If the familiarity value is above  $c_1$  or below  $c_0$ , the subject gives a fast response. Otherwise, the subject retrieves a code for the test word to use in scanning the memorized list in EKS. Thus far the model is identical to that for the short-term case presented in the last section. How-

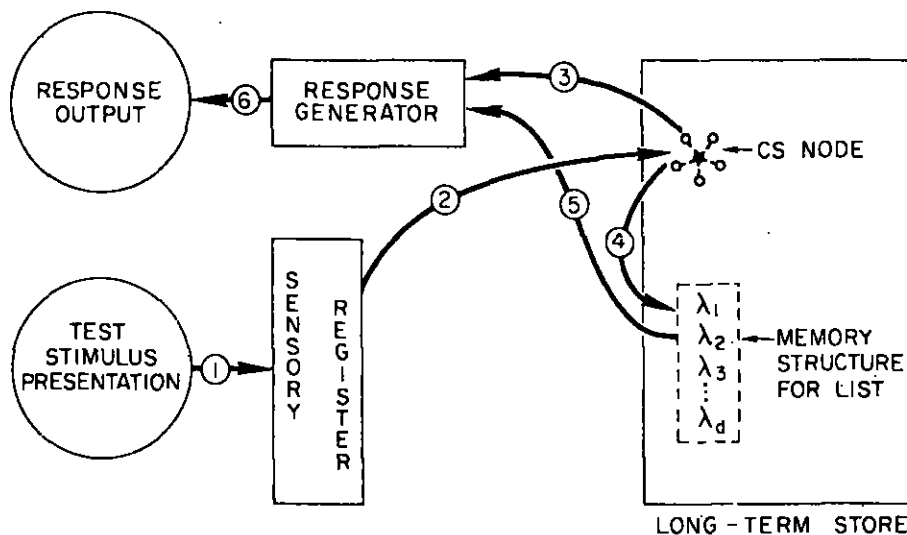

FIG. 10. A schematic representation of the search and decision processes in long-term recognition memory. A test stimulus is presented (1) and then encoded and matched to an appropriate CS node (2). The familiarity index associated with the node may lead to an immediate decision (3) and in turn to a response (6). Otherwise, an extended search of the stored target list is initiated (4), which eventually leads to a decision (5) and a subsequent response (6). Path (1), (2), (3), (6) represents a much faster response process than path (1), (2), (4), (5), (6), and one that is independent of target-set size.

ever, the code used to search the EKS may not be the same as that used in the short-term memory search. For example, Klatzky, Juola, and Atkinson (1971) present evidence that alternative codes for the same test stimulus can be generated and compared with either verbal, spatial, or conceptual representations of memory-set items. After retrieval of the appropriate code, a search of the memory set is executed, leading in turn to a correct response. Note that a response based on familiarity follows the same path as was proposed for familiarity decisions in the short-term case. However, when a search of EKS is required we assume that the time to initiate the search ( $\kappa$ ) and the search rate per memory set item ( $\alpha$ ) will not be the same as in the short-term case; this difference in the search rate may be due either to the storage of different types of codes in STS and EKS, to differing search and comparison processes within the stores, or to both. Restated, the parameters  $l$ ,  $\rho$ ,  $r_1$ , and  $r_0$  are the same in the long-term and short-term cases; these cases differ only with respect to the values of  $\kappa$  and  $\alpha$ . Thus, Eqs. (3) and (4) apply here, except that the estimates of  $\kappa$  and  $\alpha$  should differ for experiments involving large memory sets.

For the conditions of this particular experiment, the criteria  $c_1$  and  $c_0$  are assumed to be fixed and independent of the size of the memory set. The effect of repeating a word during the test sequence is to boost its familiarity value; this boost in familiarity is assumed to occur for both repeated targets and repeated

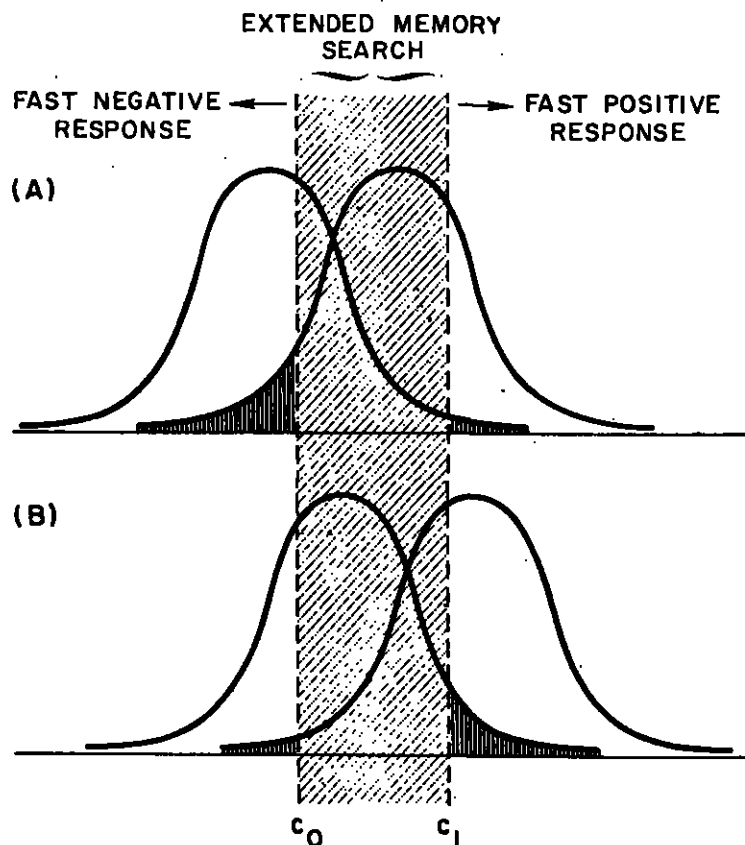

FIG. 11. Distributions of familiarity values for distractor and target items when presented for the first time (Panel A), and when receiving a repeated presentation (Panel B).

distractors. Figure 11 illustrates the familiarity distributions for targets and distractors when presented for the first time (top panel), and for targets and distractors when receiving a repeated presentation (bottom panel). Note that the likelihood of searching EKS is less on the repeated presentation of a target word than on the initial presentation of a target word; in contrast, the reverse holds for distractors. In terms of  $s$  and  $s'$  defined in Eqs. (1) and (2),  $s$  is less for a repeated presentation of a target and  $s'$  is greater for a repeated presentation of a distractor. Of course, the greater the likelihood of searching EKS, the steeper the slope of the RT function (i.e., the slopes of the target and distractor functions approach  $\alpha$  as  $s$  and  $s'$  approach one, respectively).

A quantitative application of the model sketched above leads to the predicted functions displayed in Fig. 9. The slopes and intercepts for targets and distractors show the appropriate relationships for initial and repeated items. In addition, the theory accurately predicts error rates and RTs for errors. The details of the model

and its fit to these data are presented in Atkinson and Juola (1974). It is important to note that the parameter estimates for this case differ from the short-term study discussed in the last section. The time,  $\kappa$ , to initiate the EKS search is 137 msec, as compared to 70 msec for the STS search; in contrast, the search rate per memory-list item,  $\alpha$ , is 10 msec for EKS compared to 34 msec for STS. Thus, the search is initiated more rapidly if it involves the STS, but comparison time per memory-set item is much faster for EKS.

To summarize, the same model is applicable to experiments using large memory sets as well as for those using small sets; the difference is in the extended search on those trials where familiarity is not used to make a decision. The complex pattern of data in Fig. 9 is interpretable in terms of the model if we assume that there is a boost in familiarity whenever a word is presented for test.<sup>7</sup> It should be noted, however, that the increase in familiarity is short-lived. Juola, Fischler, Wood, and Atkinson (1971) found that the effect on RT of repeating an item diminished as the lag between the initial and repeated presentations increased, indicating that the boost in familiarity decays over time.

An interesting feature of the data reported in this section is the absence of a serial-position effect in RTs. If the time to make a response to a target word is plotted as a function of the serial position of that word in the original study list, the result is a flat line. There is absolutely no trend relating RT to serial position; that is true for initial and repeated presentations of target words separately, as well as for the combined data. The same phenomenon has been observed in other studies using a similar design (Atkinson & Juola, 1973) and is rather surprising since the subjects were required to master the list in a strict serial order. Theoretically, this means that both familiarity effects and the EKS search are independent of a target item's position in the memory list. The absence of a serial-position effect in these experiments, however, does not mean that organizational factors influencing the acquisition of a target set will not affect RTs in the recognition phase of the experiment. In one study reported by Atkinson and Juola (1973), the set of target words was organized and learned as a semantic hierarchy; under these conditions RTs on the recognition tests varied as a function of the placement of the word in the original hierarchy.

Another example, more closely related to the experiment reported in this section, is a study conducted by Susan LeVine at Stanford University. Her test

<sup>7</sup>An increase in familiarity is not restricted to presenting the word in a test sequence. We have run a study similar to the one described in this section, except that the target set involved 25 words and distractor words were never repeated during the sequence of test trials. The test sequence involved two blocks of 50 trials each with a brief break between trial blocks. During the break subjects were given written instructions regarding a task they supposedly were going to participate in immediately after completing the second block of test trials; subjects were required to read the instructions twice, once silently and once aloud. In actual fact, 10 words in the instructions served as distractor words in the second block of test trials. Comparing RTs for distractor words that had been in the instruction set with those that had not yielded a statistically significant difference. Distractor words used in the instructions were responded to more slowly, as would be expected if their familiarity value was increased by including them in the instruction set.

sequence involved a target set of 48 words; half of the test trials involved target words and half distractors. The unique aspect of the study was the method for memorizing the target set. The subject memorized the 48 words as 24 paired associates and used an anticipation procedure. Eight of the paired associates were tested and studied on every trial of the training session, eight pairs on every other trial, and eight pairs on every third trial; thus, by the end of learning some pairs had been brought to a "high" acquisition level, others to a "medium" level, and others to a "low" level. In the recognition phase of the experiment, there were 96 trials; 48 trials tested individual words from the study list (positive trials) and 48 involved words not previously studied (negative trials). The RTs for correct responses to target words are presented in Fig. 12 along with error rates; the RT for correct responses to distractors was 758 msec with an error rate of 3 percent. Inspection of Fig. 12 indicates that RT is faster to a word that was a response member of a paired associate as compared with a stimulus member. Even for those words that have been perfectly mastered (i.e., high acquisition set), the stimulus versus response role of a word had an effect on recognition performance.

It is interesting to note that RT is related to the acquisition level; the more times a word was presented during study, the faster the RT. The fact that RT varied

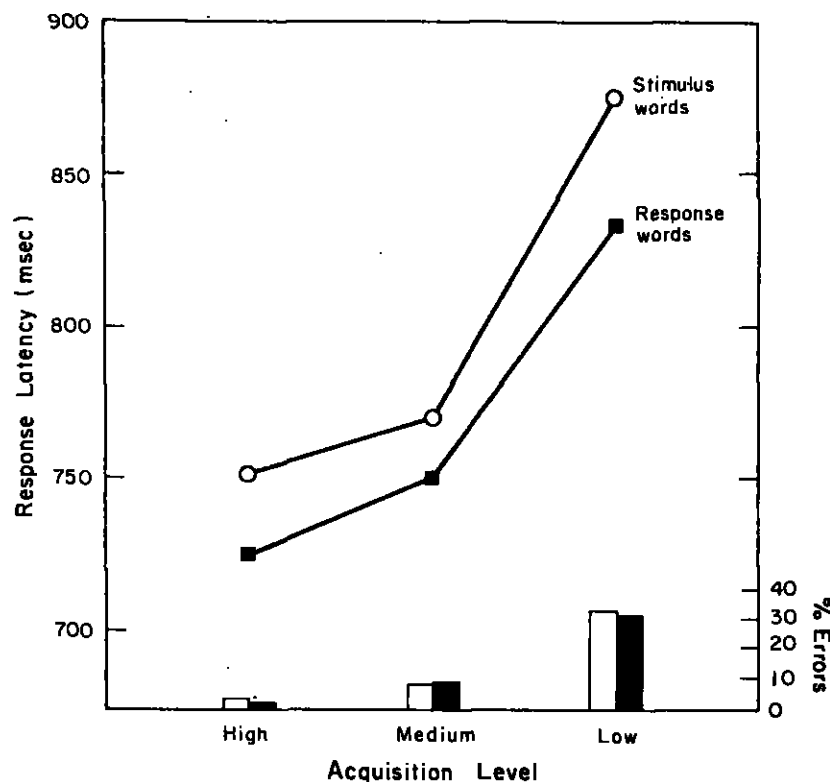

FIG. 12. Mean response latencies and error percentages across three conditions of acquisition for targets that were either stimulus or response members of paired associates.



with acquisition level suggests that the list-length effects in the prior study might be explained in the same way. One could assume that in mastering a memory list, the longer the list the lower the acquisition level at the start of the test series. Thus, the effect of list length on RT might be explained by a lower degree of mastery of the longer lists, rather than by a longer EKS search as we have done. This type of explanation could be accommodated by the theory, but we rejected it because of the error-rate data. In the paired-associate study, error rates increased as the acquisition level decreased (see Fig. 12). However, in the list-length study, both error rates and their reaction times were constant over list lengths; nevertheless, reaction times for correct responses increased with list length. For this reason we assumed in the theoretical analysis that all lists were equally well learned, that familiarity distributions were invariant over list lengths, and that the RT effects were to be explained by a longer (but equally accurate) search of the longer lists. This is an important point and emphasizes that we do not regard the linear search function postulated in this and the previous section as critical to the theory, rather, different search functions can be postulated depending on the organization

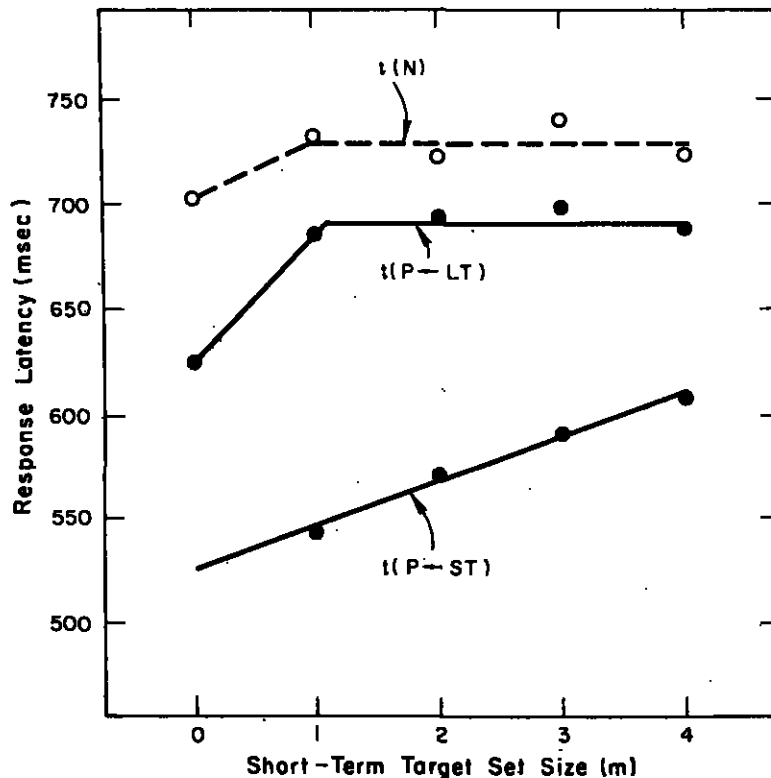

FIG. 13. Mean response latencies for targets ( $P \leftarrow ST$ ,  $P \leftarrow LT$ ) and distractors ( $N$ ) as a function of ST set size in an experiment involving short- and long-term target sets. The straight lines fitted to the data represent theoretical predictions.

of the target list and the feature sets by which target items are coded in EKS. For the experiments considered in this paper a linear function appears to provide a good approximation.

### MEMORY SEARCH WITH BOTH LARGE AND SMALL TARGET SETS

The experiments reported in this section involve a mix of the procedures discussed in the previous two sections. Prior to the test session, the subject memorizes a list of 30 words (designated the LT set) to a criterion of perfect mastery. In addition, each trial of the test session begins with the presentation of a short list of words (designated the ST set) that have never been shown before in the experiment. The test phase of the trial involves the presentation of a word, and the subject is required to make a positive response if the word is a member of either the LT set or the current ST set, and a negative response otherwise; thus a target is a word from either the LT or ST set, and a distractor is a word never previously used in the experiment. The size of the ST set varies from 1 to 4; half of the targets are from the ST set and half from the LT set. In addition, on some trials no ST set is presented, and then the target is necessarily from the LT set. Over trials, targets and distractors occur equally often.

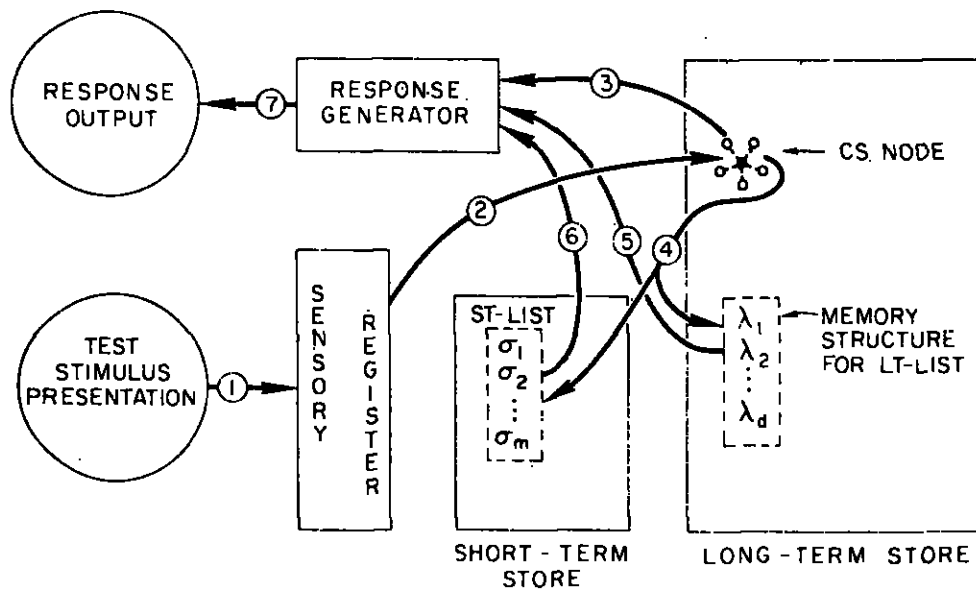

FIG. 14. A schematic representation when the target set is divided between STS and LTS. A test item is presented (1) and then matched to its CS node (2). The familiarity index of the node may lead to an immediate decision (3) and response output (7). Otherwise, appropriate codes are extracted from the CS node, and then used to simultaneously search STS and LTS (4). A decision about the test item is eventually made, based on the search of LTS (5) or of STS (6) and a response output (7).

Results from experiments by Wescourt and Atkinson (1973) and Mohs, Wescourt, and Atkinson (1973) are displayed in Fig. 13. RTs for targets and distractors are plotted as a function of  $m$ , the ST-set size;  $t(P \leftarrow ST)$  and  $t(P \leftarrow LT)$  denote the latency of a correct positive response to an ST and LT item, respectively, and  $t(N)$  denotes a correct negative response to a distractor. Inspection of the figure indicates that  $t(P \leftarrow ST)$  increases with the size of the ST set. In contrast,  $t(P \leftarrow LT)$  and  $t(N)$  seem to be independent of ST-set size as it varies from 1 to 4; however, the presence or absence of a ST set ( $m = 0$  versus  $m > 0$ ) has a marked effect on these two response times.

The model for this experiment is essentially the same as the one developed in the previous sections. A flow chart of the process is presented in Fig. 14. The LT set is assumed to reside in EKS, and each ST set is temporarily stored in STS. The recognition process first involves a check of the test word's familiarity value, which may lead to an immediate response. If not, a search of the EKS and STS will be required before a response can be emitted.

As described earlier, the decision to respond on the basis of familiarity alone is a function of the criteria  $c_0$  and  $c_1$ . Figure 15 presents a diagram of the familiarity distributions for ST-set words, LT-set words, and distractors. The relative positions of these distributions are not determined *a priori*, but are inferred from error rates associated with the three types of test items (i.e., the tail of the distractor distribution above  $c_1$  determines the error rate associated with distractors; and the tails below  $c_0$  for the ST and LT distributions, the error rates associated with ST and LT targets, respectively).<sup>8</sup>

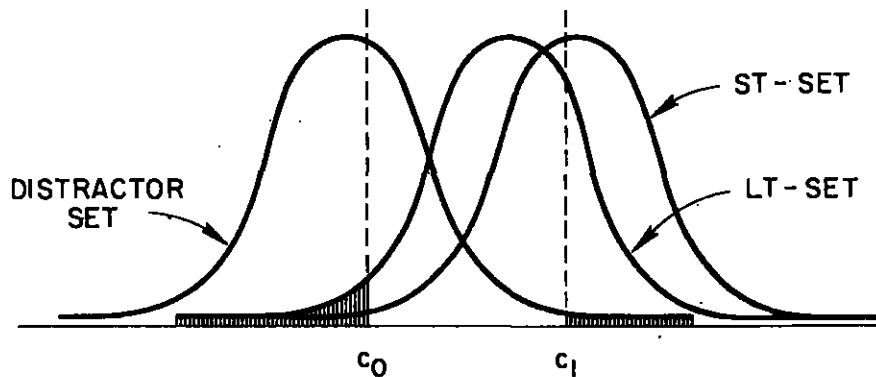

FIG. 15. Distributions of familiarity values for the three trial types.

<sup>8</sup>An experiment has been conducted by Richard Mohs in which elements of the LT set are included in the ST set on some trials; the time for a positive response to these items can be denoted as  $t(P \leftarrow ST \& LT)$ . The average response times in the experiment were ordered as follows:  $t(P \leftarrow ST \& LT) < t(P \leftarrow ST) < t(P \leftarrow LT) < t(N)$ . These results would be expected if the presentation of LT-set words within ST sets cause an additional boost of familiarity value for them.

When the retrieved familiarity value of a test word does not suffice for a decision to be made, then a search of STS and EKS is required. In this case, the principal issue is the order in which the two stores are searched. For example, the search could be first conducted in STS and if a match is not obtained, then continued in EKS. This scheme seems plausible since information in STS tends to be lost rapidly. However, if the two stores were searched in this order (and the time to search STS depended on the size of the ST set), then both  $t(P \leftarrow LT)$  and  $t(N)$  should increase as  $m$  goes from 1 to 4. Clearly, the data in Fig. 13 do not support this sequential search scheme. An alternative approach is to assume that STS and EKS are searched in parallel, and that if a match is found in either store, a positive response will be made; if both searches are completed and no match is established, then a negative response will be made.

The flow chart for the parallel-search process is shown in the right-hand panel of Fig. 16; the left-hand panel is for those trials on which the ST set is omitted and illustrates precisely the model developed in the previous section of this paper.

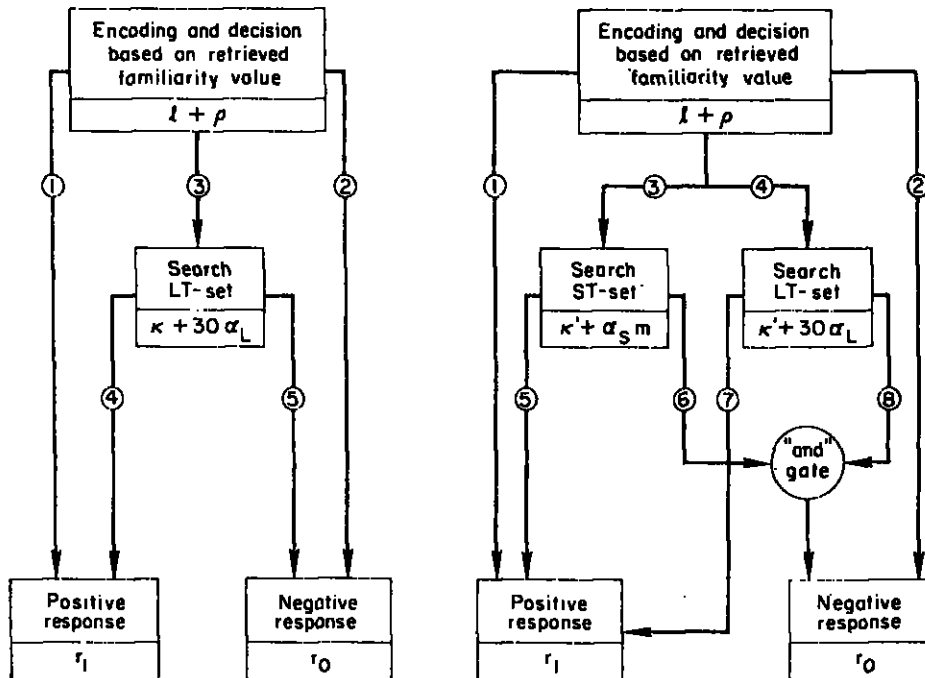

FIG. 16. Schematic representations of the processing strategies in searching the memory stores. The model when an ST set is omitted is shown in the left-hand panel; arrows (1) and (2) represent fast responses based on familiarity alone, whereas (4) and (5) represent responses after a search of EKS has occurred. In the right-hand panel a parallel-search model is presented for those trials on which an ST set is present. The arrows (1) and (2) represent fast responses based on familiarity. When a search is required, the ST and LT sets are searched simultaneously (3,4). If a match is found in the ST set (5) or in the LT set (7), a positive response will be made. If a match is not established in either set (6,8), a negative response will be made.

As indicated in the figure, the time  $\kappa'$  to initiate the search of both the EKS and STS (i.e., when  $m > 0$ ) is assumed to be different from the time  $\kappa$  to initiate search of EKS alone (i.e., when  $m = 0$ ). Once the search of a store is initiated, its rate is independent of whether or not any other store is being searched. We let  $\alpha_S$  and  $\alpha_L$  denote the search rates for the two stores. Thus, when an ST set is present, it takes time  $\kappa' + \alpha_S m$  to search the STS store and time  $\kappa' + 30\alpha_L$  to search EKS. When the ST set is omitted, it takes time  $\kappa + 30\alpha_L$  to search EKS. Recall that the LT set is of size 30.

Since both stores are searched simultaneously when  $m > 0$ , the total search time will depend on which search required the most time. For the sizes of the ST and LT sets considered here, we assume that the STS search is always completed prior to the completion of the EKS search. Consequently, the search of STS will yield a match in time  $\kappa' + \alpha_S m$  and the search of EKS will yield a match in time  $\kappa' + 30\alpha_L$ . If the test item is a distractor, then both searches will have to be completed (which takes time  $\kappa' + 30\alpha_L$ ) before a negative response can be initiated. Thus,  $t(P \leftarrow ST)$  will increase as  $m$  goes from 1 to 4, but both  $t(P \leftarrow LT)$  and  $t(N)$  will be independent of the size of the ST set. However,  $t(P \leftarrow LT)$  and  $t(N)$  will be faster when no ST set is present than when one is present, if  $\kappa$  is less than  $\kappa'$ .

A quantitative application of the model sketched out above leads to the predicted functions in Fig. 13. Not presented in the figure are error rates for the three types of test stimuli, but they also are accurately predicted by the model. (For a detailed account of this work, see Atkinson and Juola, 1974.) In fitting the model to these data, certain parameter estimates prove to be interesting:

$$\kappa' = 207 \text{ msec}$$

$$\kappa = 140 \text{ msec}$$

$$\alpha_S = 35 \text{ msec}$$

$$\alpha_L = 10 \text{ msec}$$

The  $\kappa$  and  $\alpha_L$  recovered here are very close to the corresponding estimates made in the last section dealing with long-term target sets; similarly, the estimate of  $\alpha_S$  is very close to the estimate of  $\alpha$  recovered in the analysis of the short-term memory study. Finally,  $\kappa'$ , the time to initiate the joint search of EKS and STS, is significantly above  $\kappa$ , the time to initiate the search of EKS alone.

In the model, we assumed that  $\alpha_L$  is independent of the size of the ST set; any difference in the search of EKS on trials with and without an ST set is simply due to  $\kappa'$  and  $\kappa$ , respectively. Independent support for this assumption comes from an experiment conducted by Keith Wescourt. The experiment exactly replicated the procedure described in this section, except for positive test words: All positive

test words were drawn from the LT set and the ST set was never tested. Subjects had to maintain 0 to 4 items in STS for recall at the end of the trial; however, they were told (and it was always the case) that the test word would be either an LT item or a distractor. Under these conditions, the latency of a positive response to an LT item and of a negative response to a distractor did not display a jump from the  $m = 0$  condition to the  $m > 0$  conditions; rather, both latency functions were constant as the ST-set size varied from 0 to 4. The parameters  $\kappa$  and  $\alpha_t$ , estimated in the prior experiment can be used to predict these data; the parameter  $\kappa'$  was not required since only EKS needed to be searched even on those trials where an ST set was present. The existence of a load in STS *per se* had no effect on RT; what did affect performance in the original experiment was the relevance of the STS load for the scanning decision.

### MEMORY SEARCH MODERATED BY SEMANTIC FACTORS

A number of studies, using both small and large memory sets, have shown that semantic factors can influence RT. In this section, recognition experiments involving semantic variables are considered, and the theory is employed to explain how they can affect search and decision processes.

A frequently used paradigm requires a subject to memorize a target set composed of sublists, where words on each sublist are from a given category. The number of sublists will be denoted by  $c$ , and the length of each sublist by  $d$ ; thus, the target set is composed of  $c \cdot d$  words. For example, with  $c = 2$  and  $d = 3$ , the target set might be

[(BEAR, LION, HORSE) (CARROTS, PEAS, BEANS)]

a total of six words from the categories *animal* and *vegetable*. Once the target set has been memorized, tests are initiated. On a test trial, one of three types of words is presented: (1) a word on the memory list (P-item) to which the subject is required to make a positive response; (2) a word not on the memory list but from a category represented on the list (N-items) to which the subject is required to make a negative response; and (3) a word not on the memory list and not a member of any of the categories represented on the list (N\*-items) to which the subject also is required to make a negative response. In the above example, a P-item might be LION, an N-item might be DEER, and an N\*-item might be NAIL. A target word (P-item) is presented with probability  $\frac{1}{2}$ , a related distractor (N-item) with probability  $\frac{1}{2}\eta$ , and an unrelated distractor (N\*-item) with probability  $\frac{1}{2}(1 - \eta)$ . When  $\eta = 1$ , only P and N items are presented; when  $\eta = 0$ , only P and N\* items; and when  $0 < \eta < 1$ , a mix of P, N, and N\* items. The dependent variables of principal interest are again latencies of correct responses to P, N, and N\* items and will be denoted as  $t(P)$ ,  $t(N)$ , and  $t(N^*)$ , respectively.

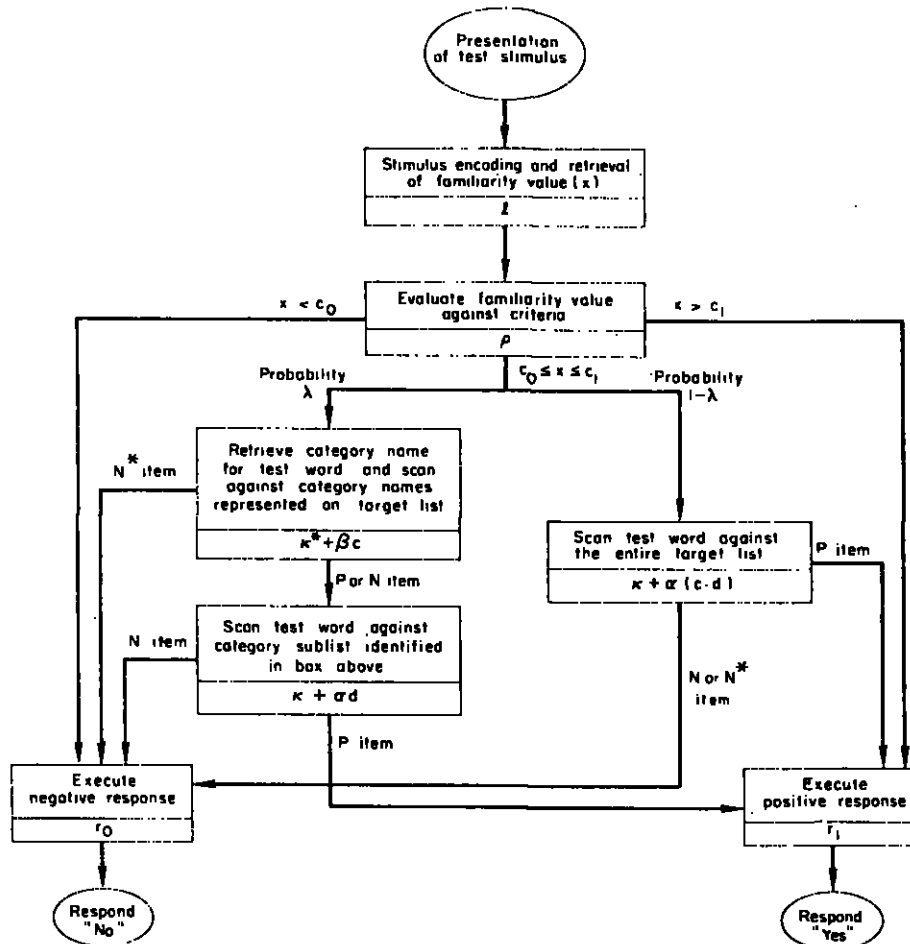

FIG 17. Representation of the processing stages underlying recognition performance when semantic factors may influence search in EKS. The subject may execute a rapid response based on familiarity or alternatively may search EKS. In the latter case, semantic information may be utilized to direct search on some proportion of trials; on other trials this information is ignored and the entire target set is scanned.

The theory as it applies in this situation is summarized in Fig. 17. A word is encoded (time  $t$ ) and its familiarity value is retrieved and evaluated (time  $\rho$ ). If the familiarity value is above  $c_1$ , an immediate positive response is made; below  $c_0$ , an immediate negative response. If the familiarity value is intermediate, the subject has two options. With probability  $\lambda$  he categorizes the test item and then scans its category name against the category names represented on the memory list. If no match occurs ( $N^*$ -item), a negative response is made; if a category-name match occurs, the subject then searches the appropriate category sublist of the memory set, making either a positive response ( $P$ -item) or a negative

response (N-item). Alternatively, with probability  $1 - \lambda$  the subject ignores the semantic information in the test item and searches the entire memory list.

Given that the subject does categorize the test item, the time to retrieve its category name is  $\kappa^*$ , and the search rate among the  $c$  category names is  $\beta$ ; thus, the time for this stage is  $\kappa^* + \beta c$ . If the categorizing stage determines that the word is an N\*-item, a negative response occurs. Otherwise, the subject next searches the sublist of the memory set identified by the categorization process; it takes time  $\kappa'$  to initiate the search, and its rate is  $\alpha$  yielding time  $\kappa' + \alpha d$  for this stage. Given that the subject does not categorize the item, the search of the entire memory list is presumed to take  $\kappa + \alpha(c \cdot d)$ ; that is, time  $\kappa$  to initiate the search which proceeds at rate  $\alpha$  for the total set of  $c \cdot d$  items.

Figure 18 illustrates the familiarity distributions associated with P, N, and N\* items. While not critical to the model, the N distribution is shown in the figure to have a higher mean than the N\* distribution. The reason is that there is evidence to suggest that distractor items that are related to items on the memory list have a higher familiarity value than unrelated distractors (Juola et al., 1971; Underwood, 1972). This relation between the distributions would be expected if there were a spread of "activation" in the CS space in the areas of target-word nodes (Meyer & Schvaneveldt, 1971). Using Eq. (1), the quantity  $s$  can be defined for the P distribution. Similarly, using Eq. (2), the quantities  $s_N'$  and  $s_{N^*}'$  can be defined for the N and N\* distributions. Once this has been done, the following expressions can be written for the time to make a correct response to each of the item types:

$$t(P) = (l + \rho + r_1) + s \{ \lambda [(\kappa^* + \beta c) + (\kappa' + \alpha d)] + (1 - \lambda) [\kappa + \alpha(c \cdot d)] \} \quad (5)$$

$$t(N) = (l + \rho + r_0) + s_N' \{ \lambda [(\kappa^* + \beta c) + (\kappa' + \alpha d)] + (1 - \lambda) [\kappa + \alpha(c \cdot d)] \} \quad (6)$$

$$t(N^*) = (l + \rho + r_0) + s_{N^*}' \{ \lambda [\kappa^* + \beta c] + (1 - \lambda) [\kappa + \alpha(c \cdot d)] \}. \quad (7)$$

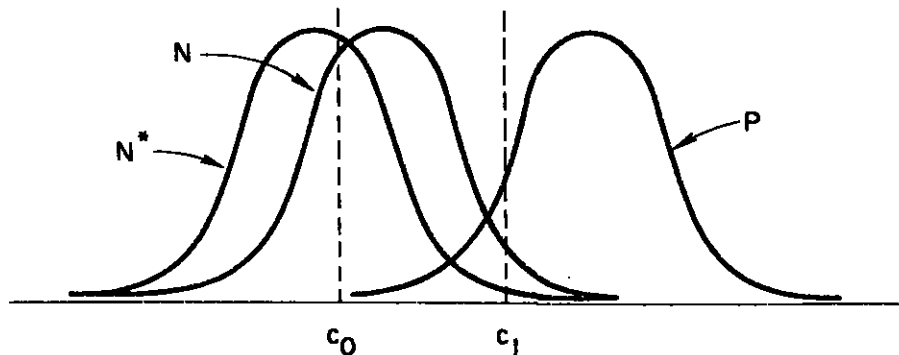

FIG. 18. Distributions of familiarity values for the two types of distractor items (N\*, N) and for target items (P).



How does the subject select between his two options: Should he first categorize a test item or search the entire memory list? We offer no theory to explain this selection and propose to estimate  $\lambda$  from the data. However, if all parameters of the process are fixed and the subject is trying to minimize his average response time over all trial types, then  $\lambda$  should be selected as follows: If the quantity  $[(\kappa^* + \beta c) + \frac{1}{2}(1 + \eta)(\kappa' + \alpha d)]$  is greater than  $[\kappa + \alpha(c \cdot d)]$ , set  $\lambda$  equal to 0; otherwise set  $\lambda$  equal to 1.<sup>9</sup> Stated somewhat differently, an optimal setting for  $\lambda$  depends on an interplay of search parameters with the structure of the list (the values of  $c$  and  $d$ ) and the nature of the test schedule (the value of  $\eta$ ). Although estimates of the various search parameters vary from study to study (see Juola & Atkinson, 1971), the data indicate that (a)  $\beta$  is about three times as large as  $\alpha$ , and that (b)  $\kappa^*$  and  $\kappa$  are fairly close to each other with  $\kappa'$  somewhat smaller.

Figure 19 presents unpublished data from two separate experiments, one conducted by Homa (1972) as part of a Ph.D. thesis at the University of Wisconsin, and the other as a pilot study at Stanford University. For the data displayed in the figure,  $\eta = \frac{1}{2}$  and  $c = 2$ ; the Homa data are for  $d$  equal to 2, 3, and 5, whereas

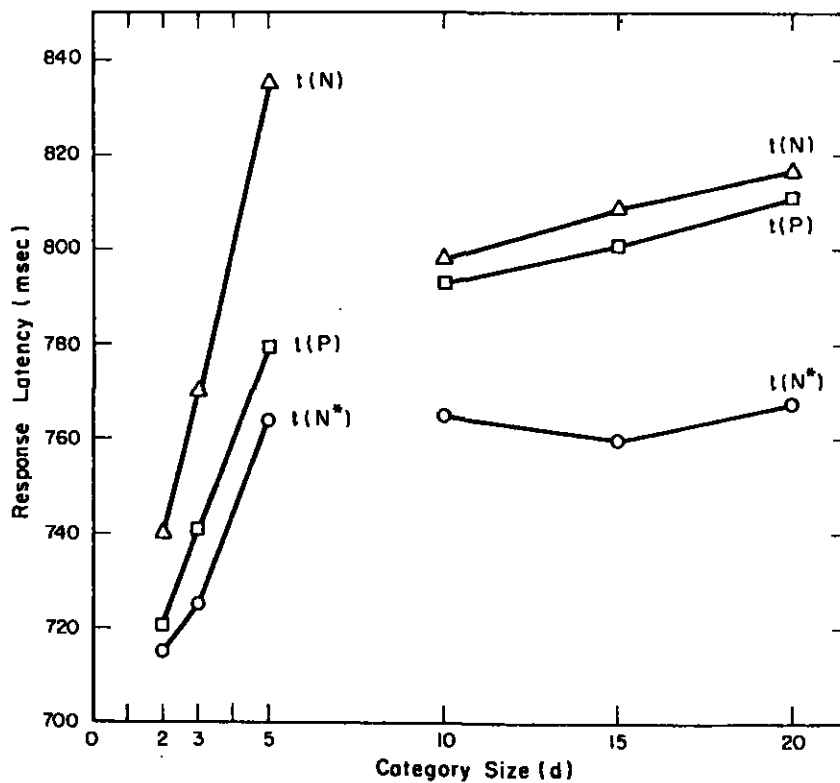

FIG. 19. Mean response latencies for positive items (P) and for semantically related (N) and unrelated (N\*) negative items as a function of category size ( $d$ ).

<sup>9</sup>A similar proposal has been made by Naus (1972).

the Stanford data are for  $d$  equal to 10, 15, and 20. No attempt will be made to generate quantitative predictions for these data; it is evident that appropriate parameter values can fit the results. The main point to consider is the effect of  $d$  on  $t(N^*)$ . In the Homa data,  $t(N^*)$  is increasing and at about the same rate as  $t(N)$ , which indicates that  $\lambda$  is close to zero; thus, when  $d$  is relatively small, the subject is scanning the entire memory list and not attempting to categorize test items. For the Stanford data,  $t(N^*)$  is relatively constant over the three values of  $d$  while  $t(N)$  shows a sizable increase; this finding, of course, implies that  $\lambda$  must be equal to one (i.e., that the subject is categorizing each test item and processing the item accordingly).

These results are what one might expect if the subject is attempting to set  $\lambda$  optimally. When  $d$  is small, the slow scan of the category names is not warranted, but when  $d$  becomes large, there is an advantage to categorizing and, only if necessary, making a search of the appropriate sublist. Thus, the subjects appear to be selecting a value of  $\lambda$  in accordance with the specific parameters of the search task.<sup>10</sup>

There are other results that can be cited to support the  $\lambda$ -process proposed here. For example, Homa has data where  $c = 12$  and  $d = 1$  for which the estimate of  $\lambda$  is zero. On the other hand, Tarrow Indow (personal communication) has data for  $c = 1$  and  $d$  varying from 5 to 27; these data are consistent with the view that  $\lambda$  is zero for small values of  $d$ , but increases to one for  $d$  greater than 10 or 12.

We have not provided a quantitative fit of the model to the data presented here. The reason is that the task is quite complex from a theoretical viewpoint; the subject has alternative strategies to apply, which means that different subjects may be electing different mixes of strategies in a given experimental condition. Hence, a quantitative evaluation of the model requires carefully designed experiments and a large sample of data for each subject. It is clear, however, that the basic outline of the theory is correct. An individual subject may or may not retrieve a category name for a test item, depending on the structure of the memory list (the values of  $c$  and  $d$ ) and the nature of the test sequence (the value of  $\eta$ ).<sup>11</sup>

The experiments considered in this section have all used words for the stimulus materials. Comparable experiments have been run using letters and digits to distinguish between P, N, and N\* items. For example, the memory set might be

<sup>10</sup>The model proposed here assumes that the subject selects between one of two search strategies with probability  $\lambda$ . Another approach is to assume that both searches (the search by categories and the search of the entire list) are initiated simultaneously and that the one finishing first determines the subject's response latency; this type of assumption is in accord with a model proposed by Naus, Glucksberg, and Ornstein (1972). Under certain conditions, the simultaneous search model generates the same predictions as the model developed in this paper. Thus, the particular interpretation that we offer is open to question, and an argument can be made for a simultaneous search.

<sup>11</sup>Studies can be run that vary the length of sublists within a memory list. For example, the memory list can involve three categorized sublists with one having 4 words, the second 8 words, and the third 12 words for a total set of 24 (i.e.,  $c = 3$ ,  $d_1 = 4$ ,  $d_2 = 8$ ,  $d_3 = 12$ ). Applications of the theory to these experiments is straightforward, but the equations are cumbersome.

composed of three letters, with the test involving a letter from the memory set (P-item), a letter not in the memory set (N-item), or a digit (N\*-item). Results from these experiments have been somewhat variable. There are studies (Williams, 1971; Lively & Sanford, 1972) where the estimate of  $\lambda$  is significantly greater than zero for small memory sets of three or four items. For other studies, as we shall see in the next section, the estimate of  $\lambda$  is very close to, if not exactly, zero. It appears that when words are used as the stimulus materials, the estimate of  $\lambda$  is invariably zero for small memory sets; but when letters versus numbers are used,  $\lambda$  is sometimes greater than zero. Of course, when letters versus digits are used, it is conceivable that the subject may be classifying the probe on the basis of perceptual features; clearly, when words are used, there is no possibility for category classification based on perceptual cues, but with letters versus digits such a possibility may exist depending on the type font and displays used. A greater readiness to classify on the basis of perceptual factors than on semantic factors is consistent with the viewpoint developed in this paper, which distinguishes between perceptual codes and conceptual codes. Since a test stimulus will be represented in the memory system as a perceptual code before it can be represented as a conceptual code, strategies that allow accurate responding by processing perceptual codes will be preferred in those tasks where response speed is an important task demand.

#### MEMORY SEARCH INVOLVING A DUPLEX TARGET SET

In this section we examine an experiment that has similarities to the ones considered in the previous two sections; nevertheless, its theoretical analysis requires separate treatment. The experiment is one in a series of studies conducted by Charles Darley at Stanford University dealing with duplex target sets. His research on this problem is in an early stage, and the theoretical treatment given here may prove to be premature. The task is of such intrinsic interest, however, that some discussion of it seems warranted at this time.

On each trial the subject is presented with a target set composed of two subsets—one of letters and the other of digits. The target set is presented visually, with one subset on the left and the other on the right; whether letters or digits are on the left is determined randomly on each trial. The sizes of the two subsets are also randomly determined from trial to trial, each independently taking on the values 1, 2, or 3; the digits are drawn from the numbers 1 through 9 and the letters from a restricted alphabet with the vowels deleted. When the subject has the target set in mind, a test stimulus, which is either a letter or digit, is presented. The subject is required to make a positive response if the probe is from the target set, and a negative response otherwise. For example, the target set might be (D,B,K)(8,6); if any of these five items is presented at test, the subject should make a positive response; otherwise, a negative response. The subset that corresponds to the test stimulus will be called the *memory set* and the other the *load*

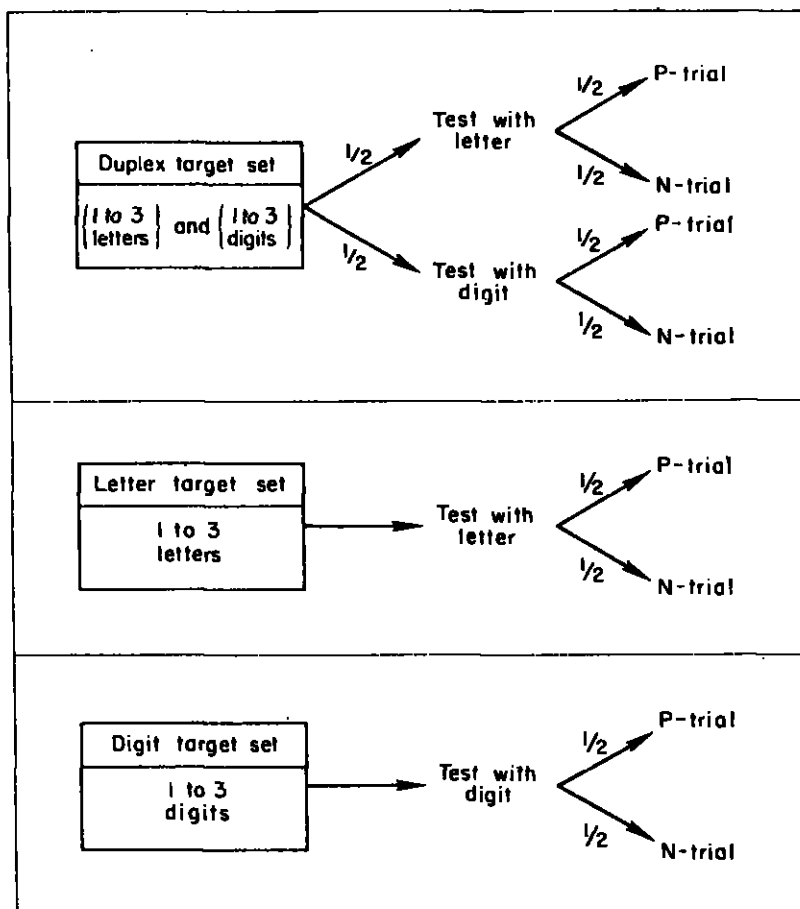

FIG. 20. Design of an experiment with duplex target sets. The upper panel describes trials presenting both a set of letters and a set of digits. The two lower panels describe trials presenting a homogeneous set of either letters or digits.

set. We let  $d_M$  denote the size of the memory set and  $d_L$  the size of the load set. In terms of the above example, if the test stimulus is a letter, then  $d_M = 3$  and  $d_L = 2$ ; if the test stimulus is a digit, then  $d_M = 2$  and  $d_L = 3$ . Of course, until the test stimulus appears the subject does not know which array is the memory set and which is the load. The top panel of Fig. 20 presents a schematic account of a trial; letters and digits are tested equally often, and positive and negative trials are equally probable. The question of interest is how the scan of a memory set in STS is influenced by the size of a load set also in STS.<sup>12</sup>

<sup>12</sup>In this experiment, the subject was required to recall aloud the load set after he made his RT response; errors in this recall were extremely rare. The requirement to recall the load set does not seem to be an important factor, for Darley has run another study where the recall was omitted with results comparable to those to be reported here.

Mixed in with the duplex-type trials are others involving only a single target set (either 1 to 3 letters or 1 to 3 digits). These trial types are illustrated in the bottom two panels of Fig. 20; note that when the target set involves only letters, the test stimulus is a letter (and the same holds for digits). These trials correspond to the procedure used by Sternberg (1966) and will be called zero-load trials. In terms of the above notation,  $d_M$  takes on the values 1 to 3 and  $d_T = 0$ .

Average RT data for correct responses are shown in Fig. 21; error probabilities have not been presented since they were less than 3% overall. What is plotted is the average time for positive and negative responses as a function of memory-set size; each curve is for a different load size. The composition of the memory set did not have a statistically significant effect on RT, and consequently the data

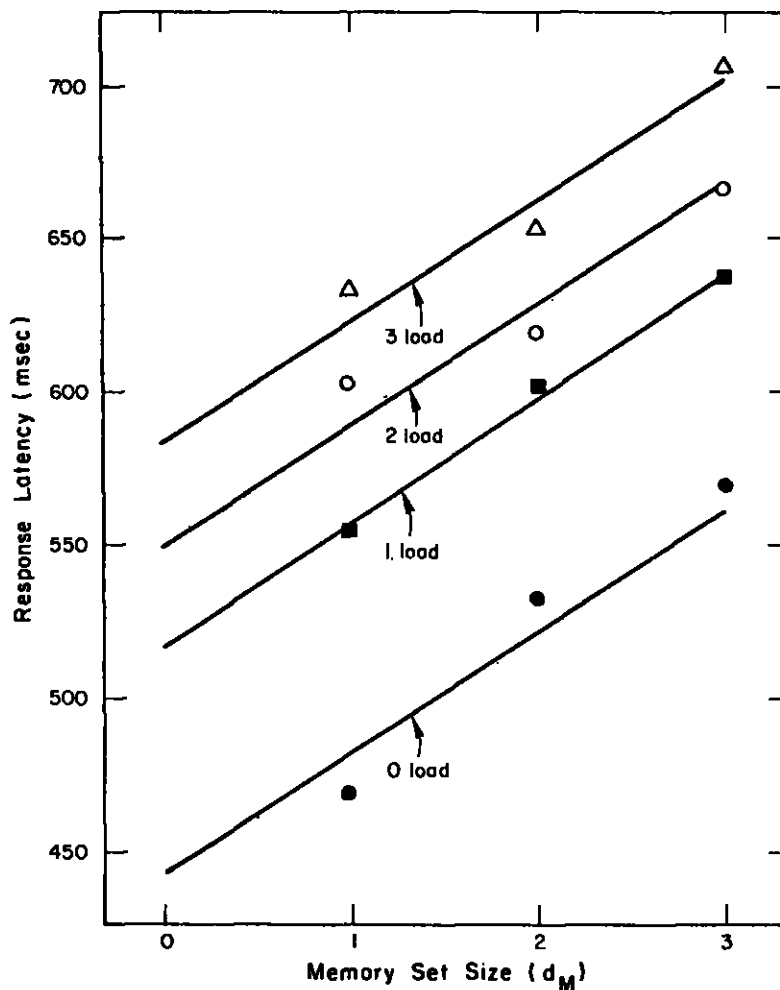

FIG 21. Mean response latencies (combining positive and negative trials) for four conditions of memory-load size as a function of three target set sizes.

have been averaged over both memory sets composed of letters and memory sets composed of digits. For example, in Fig. 21 the observed value of 601 msec for a memory set of two and a load of one is an average which includes positive and negative responses and memory sets of letters and of digits.

The results displayed in Fig. 21 indicate that the load has a clear effect on RTs, but only on the intercept of the functions. It appears that all four RT functions have approximately the same slope. The subject cannot simply be classifying the test stimulus as a letter or digit and then restricting the search to appropriate subset. If this were the case, the obtained equality of the slopes for the four functions would be predicted, but predictions for their intercepts would be incorrect. The three load functions would all have the same intercept, which would be above that

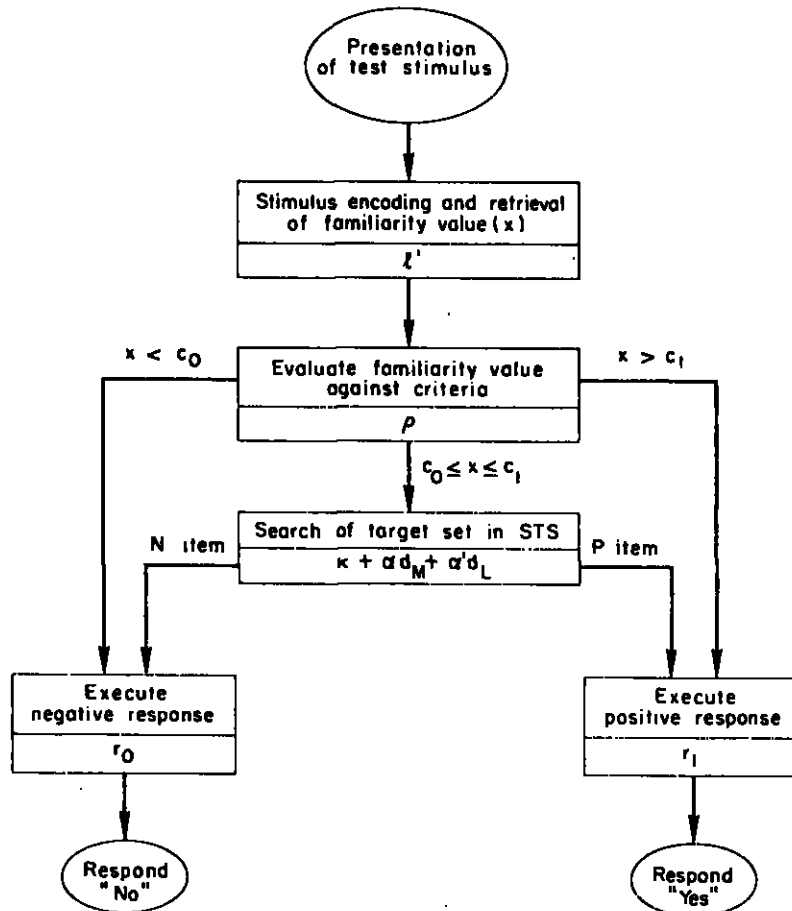

FIG. 22. Representation of the processing stages underlying recognition performance when there are two target sets in STS. A rapid response may be executed based on stimulus familiarity; otherwise, the encoded test stimulus is scanned against the contents of STS. The time of the search is a function of both target and load-set sizes.

for the zero-load functions; the intercept difference would reflect the time needed to determine which subset to search. A better fit to the data is not obtained by adding the assumption that maintaining a load set decreases the search rate for the memory set in proportion to load size. If this were the case, the three load functions would still all have the same intercept, and only their slopes would increase with load size.

It appears that the subject makes no attempt to limit the search by categorizing the test item but rather searches the entire target set; categorization would take time and is not warranted if that time is greater than the time required to search the load set. If target-set sizes were greater than those employed here, a categorization strategy might be used; in that case, a model like the one presented in the previous section would be appropriate.

Figure 22 presents the model for this experiment. As in previous sections, the familiarity distribution for a target item is assumed to have a mean above that for a distractor item, and to be independent of the size of the target set. First, the test stimulus is encoded and its familiarity value checked against the criteria  $c_0$  and  $c_1$ . Given a high or low familiarity value, the appropriate response is immediately executed. Otherwise, a search of STS occurs. The time to initiate the search of STS is  $\kappa$ . The search rate for items in the target set from the same class as the test item is  $\alpha$ , and the search rate is  $\alpha'$  for items from the other class. Thus, the search of STS on a duplex trial takes time  $\kappa + \alpha d_M + \alpha' d_L$ . When no load is present, the same process applies and is precisely the one presented in the second section of this paper (see Fig. 5). The only difference is with regard to the time parameter for encoding the test stimulus. In the zero-load conditions, the subject knows that the test stimulus will be from the same class as the target set; being able to anticipate which class the test stimulus will be from may facilitate the encoding process. To provide for this possibility, we let  $l$  represent the encoding time for the zero-load case in accord with previous notation and use  $l'$  for the load case. Otherwise, all parameter values are identical for the load and zero-load conditions; the target and distractor distributions for familiarity values, criteria values, and  $\alpha$  are assumed to be the same on all trials.

For the zero-load case the equations for RT are identical to Eqs. (3) and (4). The proportion of positive and negative trials was equal in this experiment, and hence, averaging Eqs. (3) and (4), yields

$$t_M = (l + \rho + \bar{r}) + \bar{s}(\kappa + \alpha d_M) \quad (8)$$

Here  $t_M$  denotes average RT to a memory set of size  $d_M$  in the zero-load condition. The quantity  $\bar{r} = (r_1 + r_0)/2$  and  $\bar{s} = (s + s')/2$ , where  $s$  and  $s'$  are as defined in Eqs. (1) and (2). Similarly, for the load conditions

$$t_{M,L} = (l' + \rho + \bar{r}) + \bar{s}(\kappa + \alpha d_M + \alpha' d_L) \quad (9)$$

where  $t_{M,l}$  denotes average RT to a memory set of size  $d_M$  with a load set of size  $d_l$ . Note that  $t_M$  is a linear function of  $d_M$  with intercept  $(l + \rho + \bar{r} + \bar{s}\kappa)$  and slope  $\bar{s}\alpha$ . Similarly,  $t_{M,l}$  is a linear function of  $d_M$  with intercept  $[(l' + \rho + \bar{r} + \bar{s}\kappa) + (\bar{s}\alpha'd_l)]$  and the same slope  $\bar{s}\alpha$ .

Fitting Eqs. (8) and (9) to the data using a least-squares method yields the predicted functions given by the straight lines in Fig. 21.<sup>13</sup> There are only four identifiable parameters and their least-squares estimates are as follows:

$$(l + \rho + \bar{r} + \bar{s}\kappa) = 443 \text{ msec}$$

$$(l' - l) = 41 \text{ msec}$$

$$(\bar{s}\alpha) = 40 \text{ msec}$$

$$(\bar{s}\alpha') = 33 \text{ msec}$$

Note that  $\alpha$  is greater than  $\alpha'$ ; that is, the search rate for target items in the same class as the test stimulus is slower than the search rate for items in the other class. This relation is what would be expected if the time to establish a mismatch between two letters is slower than between a letter and a digit (and vice versa). Such a difference is consistent with representations of items as codes comprised of features. In general, fewer feature comparisons are necessary to find a mismatch between items in different classes than between items in the same class.

There are other interpretations that can be given to these data. For example, one might assume that the subject first decides which subset to search and then dumps the load set from memory before starting the search. If the time to dump the load set is a linear function of its size, this interpretation (properly formulated) generates the same predictions as the one presented above. For reasons that are too lengthy to discuss here we do not favor the latter interpretation. Nevertheless, until there is more research using this type of task, it will be difficult to choose between these and other explanations. In our view, however, familiarity plays the same role in the load and zero-load conditions, and an adequate model will have to take this factor into account.

## DISCUSSION

The model described in this paper asserts that recognition memory involves the operation of a set of processes. The information processing stages that occur in a particular recognition task are determined by the physical parameters of the

<sup>13</sup>The model also has been fit to the data with the positive and negative RT's kept separate. The fits are comparable to those displayed here, but were not presented to simplify the discussion. It should be noted that the slope of the four positive functions was about 47 msec, whereas the slope of the four negative functions was about 33 msec. In the theory, this means that  $s$  is greater than  $s'$ . Similarly, the intercept of a negative function tended to be higher than the intercept of the corresponding positive function, indicating that  $r_0$  is greater than  $r_1$ .



experimental situation and by subjects' strategies. These strategies develop in accord with subjects' perceptions of task demands and abilities to apply alternative strategies. The experiments reviewed here support the model's major contention: Recognition decisions may be made quickly on the basis of partial information (familiarity), or they may be made more slowly, and more accurately, on the basis of an extended memory search. The data indicate that performance in a memory-scanning task represents a mixture of these two processes. Several factors have been shown to influence which of these processes subjects will tend to rely upon.

Besides these data, introspective reports seem to support the type of model developed here. Subjects report that sometimes they find themselves making immediate responses to a probe without "knowing for sure" whether or not it is a target item; on other trials, they report recalling portions of the target set before knowing how to respond. Subjects are almost always aware of their errors, indicating that although they may respond on the basis of familiarity, they continue processing by searching memory and thereby check their decision.

#### Limitations of the Mathematical Model

While we feel that the theory has wide applicability, certain qualifying comments need to be made about the specific models outlined in the previous sections. These models are reasonable approximations for the situations that have been investigated, but they do not reflect the full complexity of the theory. In particular, the assumption of independence of processing stages may not be justified. This assumption is reasonable in some cases, but generally processing in memory involves interactions between operations in different components of the system; processing operations selected at one stage can influence subsequent stages by restricting the number of alternative processes available, by altering the operating characteristics of these processes, or by both. The selection of internal codes could have such effects on subsequent stages of search and comparison when these depend on the nature of features comprising codes.

A second assumption made in the mathematical models is that the time to execute a memory search is a linear function of the target-set size. Corollary to this is the assumption that the search functions for both positive and negative probes are identical. There is no *a priori* reason for these assumptions; it is simply the case that much of our data are in accord with them. It is not necessary, however, that the search-and-comparison functions increase linearly with target-set size to account for the observed linear increase of RT. Both linear and nonlinear RT functions can be obtained from models that have mixtures of fast familiarity-based responses (which have times independent of target-set size) and slower responses based on extended searches (which have times either independent of or related nonlinearly to target-set size). This is the case, for example, if set size affects the mixture of the two processes; in terms of the model, the criteria that determine when familiarity-based decisions are made might vary as a function of

target-set size. Under these conditions, a linear RT function can be obtained, but, in general, nonlinear functions would be expected.<sup>14</sup> Similar reasoning can be applied to the assumption that the scan time for both positive and negative probes is the same. Certain types of interactions between the encoding and search stages or between the search and decision stages may occur for positive and negative probes. In general, interactions would lead to differences between positive and negative probes, but in particular cases such differences may not be observed. For example, if negative probes are encoded more slowly than positive probes, but are scanned against the target set more rapidly, then the trade-off on times between stages might result in identical observed RTs for positives and negatives. The models presented here assume a linear search time that is the same for positive and negative probes, because it simplifies matters and still gives good fits to the data.

### The Division of LTS

In describing the theory we proposed that LTS has two components, the conceptual store and event-knowledge store. Subdividing LTS is not a new idea (see, for example, Tulving, 1972). However, the distinctions between CS and EKS are different from the type of distinctions made in other theories. The main difference is that the CS is not a true lexicon or "semantic memory." It functions primarily as a high-speed interface between the perceptual processes and EKS. The conceptual code at each node in CS provides a very limited subset of information about a concept's full "meaning." One way to view this subset is that it provides information about the concept's relations to broad conceptual categories rather than to its relations with other specific concepts. Conceptual codes may be utilized initially to form the conceptual relations that characterize complex stimulus ensembles; subsequently, their dimensions suggest entry points into EKS where more detailed information about a concept may be located. The CS may be regarded as more analogous to an index for an encyclopedia rather than a dictionary. This index has the property of being organized on the basis of both the physical and conceptual elements of its entries, thereby allowing fast access to the stored information. While the particular description of the CS presented here does not depend directly upon any of our experimental results, it is consistent with research demonstrating that there are different levels of information representation (Posner, 1969, 1972). In addition, an experiment by Juola (1973) indicates that the familiarity of a stimulus does not depend on the specific mode of presentation; this supports our view of a CS node where the various perceptual representations of a concept are linked to one another. At an intuitive level, the CS also seems to be the type of memory required for the parsing of input by theories of language understanding (Schank, 1972); it allows high-speed access to the level of meaning.

<sup>14</sup>For example, linear RT functions could result if search time increased more than linearly with target-set size, while the proportion of familiarity decisions also increased in a positively accelerated manner.

necessary for determining the class of conceptual relations that a word can enter into, and mediates the search of EKS for additional information needed to specify the "meaning" of natural language input. Even though the division between CS and EKS may be taken as conjecture, our experiments call for some such separation in order to account for the range of effects observed.

### Memory Structures in EKS

The term "memory structure" has been used here to refer to collections of perceptual and conceptual codes stored in EKS. These structures represent past events and episodes as well as the full meaning of concepts in terms of their relations to other concepts. For instance, when subjects in experiments learn word lists, copies of codes representing the words are linked together to form a memory structure in EKS. *Since it is likely that the ability to locate particular codes within a memory structure depends on how the structure is organized internally, the nature of these structures is a relevant issue (Herrmann & McLaughlin, 1973).* It seems reasonable that the organization of EKS structures should vary with the nature of the stored information. The elements of a visual scene could be stored by linking perceptual codes and/or conceptual codes in an organization maintaining some isomorphism to the original physical display. A second form of internal organization for memory structures could be similar to Schank's (1972) conceptual dependencies. In this case, the codes underlying an event are organized on the basis of their conceptual relations. For either type of structure, the codes themselves are linked together with other codes to define the particular type of relations between other codes. The internal organization of a memory structure therefore can be thought of as a simple linking of individual codes where some of the codes define a higher-order organization of other codes. That is, objects A and B of some visual scene have codes linked by another code that defines an "above" relation between A and B if A was above B in the scene (Clark & Chase, 1972). Similarly, there is a code for the relation "actor-of" that would be linked between the actor and ACT of an event, organized on the basis of conceptual relations. When necessary, the same information may be stored in more than one memory structure (contingent on the time available). Alternately, information can be translated from one type of memory organization to another at some subsequent time; an event originally stored on the basis of physical relations (e.g., visual coding) can be analyzed for conceptual relations in the same way the original scene might have been. To the extent, however, that the information about an event stored in EKS is not a perfect copy of all the information originally available, subsequent translations of memory structures into new ones with alternative organizations may be incomplete or otherwise distorted. Therefore, the control processes for building memory structures attempt to create structures organized in a way that reflect expectations of how the information will be used at some later time. A related assumption is that the specific codes and organization used to form a memory structure affect the search and retrieval processes that operate on it; that

is, there are alternative strategies that are more or less efficient, depending on the form and organization of the codes they manipulate.

### Levels of Information Representation

As presented here, information codes in memory exist at two distinct levels, perceptual and conceptual. A code represents the set of primitive features or attributes that a stimulus or concept conveys; "primitive" should not be taken to mean innate in this context. Considerable research has been done on the internal coding of information (Melton & Martin, 1972), and undoubtedly the dichotomy presented in this paper is too simple to provide a detailed account of the various findings. While we do suppose that there are different perceptual codes for different sensory modalities, no distinctions have been made regarding the complexity of features within a modality. However, it is clear that there are several possible levels of analysis for any modality; for example, the evidence is that printed words produce perceptual codes that may reflect line segments, entire letters, or higher-order features like spelling patterns or vocalic center groups. A related issue is whether or not higher-order features map onto simple combinations of more basic features; if so, then different levels may be reduced to more basic ones, as we have suggested. The notion of different levels of perceptual codes adds considerable complexity to the scheme presented here, but it may prove necessary.

### Fully and Partially Connected Memory Networks

The system described here differs conceptually from many other theories with regard to the overall organization of information within memory. A prevalent view is that memory is a *fully connected network* (Anderson & Bower, 1972; Rumelhart, Lindsey, & Norman, 1972). In such a network, events are stored by forming links between already existing internal nodes representing concepts. Usually, a distinction is made between type nodes and token nodes, and every token is linked to its type. In principle, it is possible to reach any node in the network from any other node by following the links from one node to the next. Our conception of LTS, in contrast, may be described as a *partially connected network*. While codes at a CS node may be viewed as types for which there are tokens present in memory structures in EKS, there are no direct links between codes in CS and in EKS. There also are no direct links between the various nodes in CS. Instead, related nodes in CS are stored "near" each other because their features tend to have similar dimension values in the CS space. Similarly, structures in EKS are not linked to one another, but similar or related events may be stored within a small neighborhood of the EKS space. The only connections in our system are those within a given CS node and within a given memory structure in EKS; thus, codes in memory form only partially connected networks. In our system, the ability to locate information in LTS depends on the ability to isolate those features of the retrieval context that index the area of memory containing the to-be-

remembered structure. The success of this process depends on whether the features used for placement of a memory structure during learning are those available (or utilized) during retrieval.

A corollary to our notion of separate memory structures is the notion that the same information may be multiply represented in LTS. Whenever a particular code underlies some to-be-remembered event, a copy of that code is stored in the newly formed EKS structure. Similarly, whenever old knowledge is updated, all or part of the existing memory structure is recopied along with the new information. This view is not economical in terms of "storage space," but it may provide a more efficient basis for retrieval and modification of information already in the system because these processes do not have to deal with all the irrelevant relations associated with a given code. In a fully connected network, it is necessary to decide which and how many of the multitude of links leading away from a node are to be examined during a memory search.

It is important to emphasize that on a strictly formal basis fully connected networks and partially connected networks with directed retrieval processes may lead to equivalent predictions for a wide class of phenomena. This does not mean, however, that they are identical in a wider sense. Given a particular theoretical representation for the coding and retrieval of information, it is difficult not to opt for one or the other type of network, as we have done.

### Concluding Remarks

The theoretical divisions of the memory system described in this paper offer a framework for understanding how particular variables affect recognition performance. In addition, the theory provides a basis for considering recognition in terms of processes that underlie other types of behavior; aspects of the theory thereby may be generalized to other paradigms for investigating memory and, in principle, could be extended to higher-order functions such as the understanding of language. We recognize that a direct test of the theory is not possible; however, it has proved to be a useful tool for several reasons: (a) It has permitted us to formulate and test a series of quantitative models for specific experimental tasks; (b) at an intuitive level, it seems consistent with the memory demands of more complex cognitive behaviors; and (c) it has served to identify several factors that have been shown to significantly affect memory. The theory, thus, has value as a tool for analyzing particular experiments and as a framework within which to view the broad domain of memory and cognition.

### REFERENCES

- Anderson, J. R., & Bower, G. H. Recognition and retrieval processes in free recall. *Psychological Review*, 1972, 79, 97-123.
- Atkinson, R. C., & Juola, J. F. Factors influencing speed and accuracy of word recognition. In S. Kornblum (Ed.), *Attention and performance IV*. New York: Academic Press, 1973.

- Atkinson, R. C., & Juola, J. F. Search and decision processes in recognition memory. In R. C. Atkinson, D. H. Krantz, & P. Suppes (Eds.), *Contemporary developments in mathematical psychology*. San Francisco: W. H. Freeman & Company, 1974, in press.
- Atkinson, R. C., & Shiffrin, R. M. Human memory: A proposed system and its control processes. In K. W. Spence & J. T. Spence (Eds.), *The psychology of learning and motivation: Advances in research and theory*. Vol. 2. New York: Academic Press, 1968.
- Atkinson, R. C., & Shiffrin, R. M. The control of short-term memory. *Scientific American*, 1971, **225**, 82-90.
- Atkinson, R. C., & Wickens, T. D. Human memory and the concept of reinforcement. In R. Glazer (Ed.), *The nature of reinforcement*. New York: Academic Press, 1971.
- Briggs, G. E., & Swanson, J. M. Encoding, decoding, and central functions in human information processing. *Journal of Experimental Psychology*, 1970, **86**, 296-308.
- Broadbent, D. E. Review lecture: Psychological aspects of short-term and long-term memory. *Proceedings of the Royal Society of London*, 1970, **175 B**, 333-350.
- Bruner, J. S., & Minturn, A. L. Perceptual identification and perceptual organization. *Journal of General Psychology*, 1955, **53**, 21-28.
- Clark, H. H., & Chase, W. G. On the process of comparing sentences against pictures. *Cognitive Psychology*, 1972, **3**, 472-517.
- Craik, F. I. M., & Lockhart, R. S. Levels of processing: A framework for memory research. *Journal of Verbal Learning and Verbal Behavior*, 1972, **11**, 671-684.
- Fillenbaum, S., & Rapoport, A. *Structures in the subjective lexicon*. New York: Academic Press, 1971.
- Herrmann, D. J., & McLaughlin, J. P. Effects of experimental and pre-experimental organization on recognition: Evidence for two storage systems in long-term memory. *Journal of Experimental Psychology*, 1973, **99**, 174-179.
- Homa, D. Organization and long-term memory search. Unpublished doctoral dissertation, University of Wisconsin, 1972.
- Juola, J. F. Repetition and laterality effects on recognition memory for words and pictures. *Memory & Cognition*, 1973, **1**, 183-192.
- Juola, J. F., & Atkinson, R. C. Memory scanning for words vs. categories. *Journal of Verbal Learning and Verbal Behavior*, 1971, **10**, 522-527.
- Juola, J. F., Fischler, I., Wood, C. T., & Atkinson, R. C. Recognition time for information stored in long-term memory. *Perception & Psychophysics*, 1971, **10**, 8-14.
- Kintsch, W. Models for free recall and recognition. In D. A. Norman (Ed.), *Models of human memory*. New York: Academic Press, 1970.
- Klatzky, R. L., Juola, J. F., & Atkinson, R. C. Test stimulus representation and experimental context effects in memory scanning. *Journal of Experimental Psychology*, 1971, **87**, 281-288.
- Lakoff, G. HEDGES: A study in meaning criteria and the logic of fuzzy concepts. Paper presented at the Eighth Regional Meeting, Chicago Linguistics Society. Chicago: University of Chicago Linguistics Department, 1972.
- Lively, B. L., & Sanford, B. J. The use of category information in a memory-search task. *Journal of Experimental Psychology*, 1972, **93**, 379-385.
- Mandler, G., Pearlstone, F., & Koopmans, H. S. Effects of organization and semantic similarity on recall and recognition. *Journal of Verbal Learning and Verbal Behavior*, 1969, **8**, 410-423.
- McCormack, P. D. Recognition memory: How complex a retrieval system? *Canadian Journal of Psychology*, 1972, **26**, 19-41.
- Melton, A. W., & Martin, E. (Eds.), *Coding processes in human memory*. Washington: Winston, 1972.
- Meyer, D. E., & Schvaneveldt, R. W. Facilitation in recognizing pairs of words: Evidence of a dependence between retrieval operations. *Journal of Experimental Psychology*, 1971, **90**, 227-234.

- Mohs, R. C., Wescourt, K. T., & Atkinson, R. C. Effects of short-term memory contents on short- and long-term searches. *Memory & Cognition*, 1973, 1, 443-448.
- Murlock, B. B., Jr. A parallel processing model for scanning. *Perception & Psychophysics*, 1971, 10, 289-291.
- Naus, M. J. Memory search of categorized lists: A consideration of alternative self-terminating search strategies. Unpublished doctoral dissertation, Princeton University, 1972.
- Naus, M. J., Glucksberg, S., & Ornstein, P. A. Taxonomic word categories and memory search. *Cognitive Psychology*, 1972, 3, 643-654.
- Posner, M. I. Abstraction and the process of recognition. In G. H. Bower & J. T. Spence (Eds.), *The psychology of learning and motivation: Advances in research and theory*. Vol. III. New York: Academic Press, 1969.
- Posner, M. I. Coordination of internal codes. Paper presented at the 8th Carnegie Symposium on Cognitive Processes, Pittsburgh, May, 1972.
- Rips, L. J., Shoben, E. J., & Smith, E. E. Semantic distance and the verification of semantic relations. *Journal of Verbal Learning and Verbal Behavior*, 1973, 12, 1-20.
- Rothstein, L. D., & Morin, R. E. The effects of size of the stimulus ensemble and the method of set size manipulation on recognition reaction time. Paper presented at the meeting of the Midwestern Psychological Association, Cleveland, May, 1972.
- Rumelhart, D. E., Lindsay, P. H., & Norman, D. A. A process model for long-term memory. In E. Tulving & W. Donaldson (Eds.), *Organization of memory*. New York: Academic Press, 1972.
- Schank, R. C. Conceptual dependency: A theory of natural language understanding. *Cognitive Psychology*, 1972, 3, 552-631.
- Shiffrin, R. M., & Atkinson, R. C. Storage and retrieval processes in long-term memory. *Psychological Review*, 1969, 76, 179-193.
- Sternberg, S. High-speed scanning in human memory. *Science*, 1966, 153, 652-654.
- Sternberg, S. The discovery of processing stages: Extensions of Donder's method. In W. G. Koster (Ed.), *Attention and performance II*. *Acta Psychologica*, 1969, 36, 276-315. (a)
- Sternberg, S. Memory scanning: Mental processes revealed by reaction-time experiments. *American Scientist*, 1969, 57, 421-457. (b)
- Sternberg, S. Decomposing mental processes with reaction-time data. Invited address presented at the meeting of the Midwestern Psychological Association, Detroit, May, 1971.
- Swanson, J. M., & Briggs, G. F. Information processing as a function of speed versus accuracy. *Journal of Experimental Psychology*, 1969, 81, 223-229.
- Townsend, J. T. A note on the identifiability of parallel and serial processes. *Perception & Psychophysics*, 1971, 10, 161-163.
- Tulving, E. Episodic and semantic memory. In E. Tulving & W. Donaldson (Eds.), *Organization of memory*. New York: Academic Press, 1972.
- Tulving, E., & Thomson, D. M. Encoding specificity and retrieval processes in episodic memory. *Psychological Review*, 1973, 80, 352-373.
- Underwood, B. J. Are we overloading memory? In A. W. Melton & E. Martin (Eds.), *Coding processes in human memory*. Washington: Winston, 1972.
- Weaver, F. S. Retrieval processes in short-term memory. Unpublished doctoral dissertation, University of Delaware, 1972.
- Wescourt, K. T., & Atkinson, R. C. Scanning for information in long- and short-term memory. *Journal of Experimental Psychology*, 1973, 98, 95-101.
- Williams, J. D. Memory ensemble selection in human information processing. *Journal of Experimental Psychology*, 1971, 88, 231-238.